

FROM A PIECE

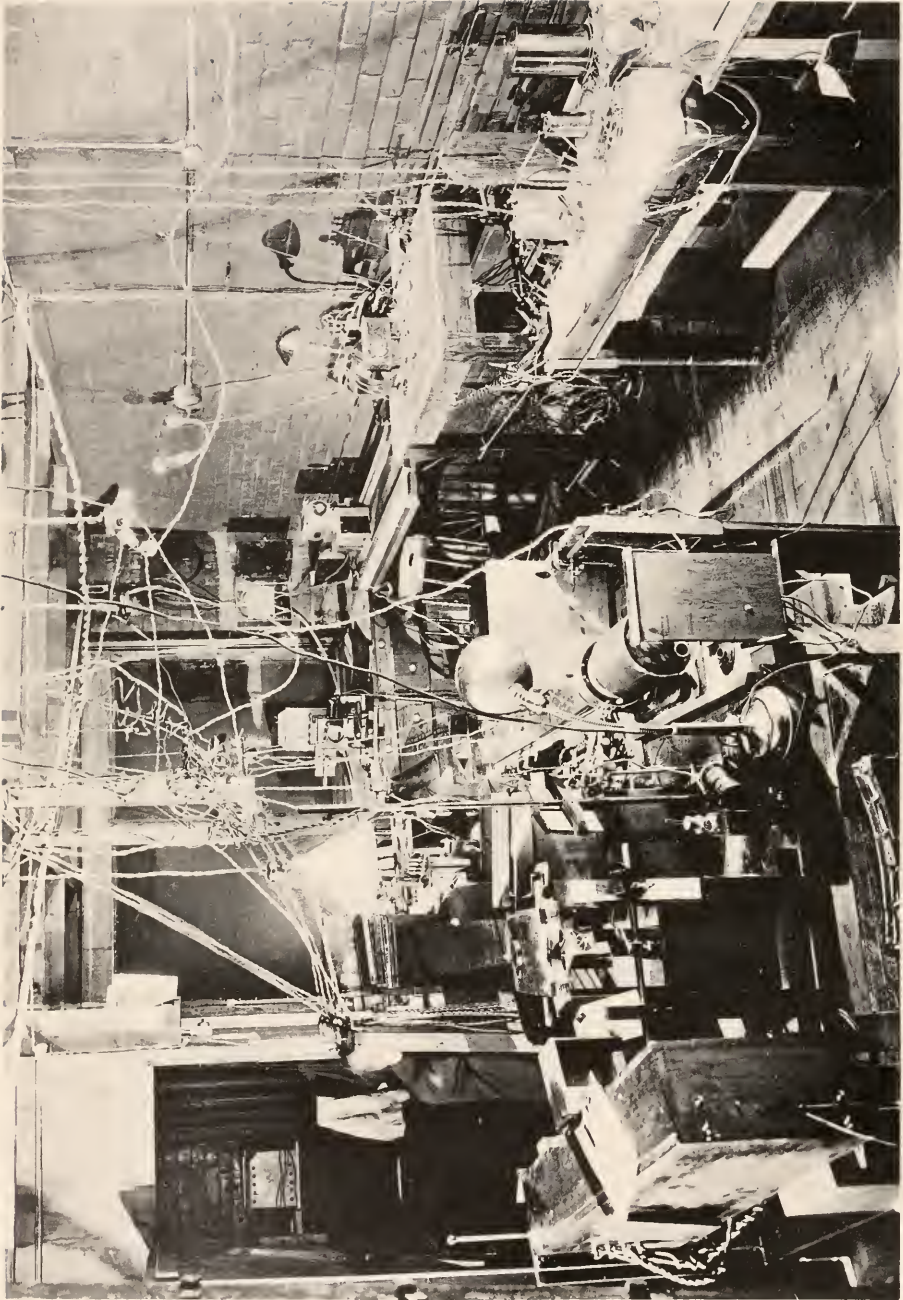

General View of the Psychological Laboratory of the Nutrition Laboratory at Boston.

PSYCHOLOGICAL EFFECTS OF ALCOHOL

AN EXPERIMENTAL INVESTIGATION OF THE EFFECTS OF MODERATE DOSES OF ETHYL ALCOHOL ON A RELATED GROUP OF NEURO-MUSCULAR PROCESSES IN MAN

By

RAYMOND DODGE AND FRANCIS G. BENEDICT

WITH A CHAPTER ON FREE ASSOCIATION IN COLLABORATION WITH
F. LYMAN WELLS

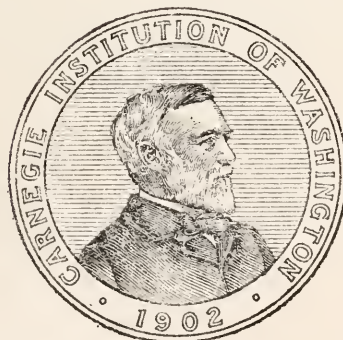

WASHINGTON, D. C.

PUBLISHED BY THE CARNEGIE INSTITUTION OF WASHINGTON

1915

CARNEGIE INSTITUTION OF WASHINGTON
PUBLICATION No. 232

9236

PRESS OF GIBSON BROTHERS, INC.
WASHINGTON, D. C.

CONTENTS

	PAGE.
CHAPTER I.—PLAN OF THE INVESTIGATION	9-32
Principles of selection of the experimental processes	13
General methodological considerations	18
Normal or basal experiments	20
Control mixtures	22
Subjects	24
Statistical expression of the measurements	27
Dosage	29
General arrangement of the apparatus	30
CHAPTER II.—EFFECT OF ALCOHOL ON THE SIMPLEST NEURAL ARCS	33-74
Available human reflexes	34
Effect of alcohol on the patellar reflex	35
Technique	36
Stimulus	37
Recording device	40
Experimental procedure	41
Results	44
Variability of the patellar reflex	44
Normal variations in the case of Subject II	46
Summary of the effect of alcohol on the patellar reflex	54
Effect of alcohol on the protective lid-reflex	56
Technique	56
Stimulus	57
Eyelash	58
Photographic recording camera	58
Experimental procedure	60
Records	61
Results	62
Summary of the effect of alcohol on the protective lid-reflex	71
CHAPTER III.—EFFECT OF ALCOHOL ON COMPLEX NEURAL ARCS	75-108
Effect of alcohol on the reaction of the eye to peripheral visual stimuli	76
Methods for recording the eye-reactions	77
Theory of recording the movements of the eye by photographing the movement of reflection from the cornea	78
Reaction-time of the eye	78
Apparatus	79
Recording camera	79
Head-rest	81
Recording light	81
Exposure apparatus and stimulus	81
Time records	82
Experimental procedure	82
Results	83
Summary of eye-reaction data	89
Variability of the measurements	89
Effect of alcohol on the eye-reaction	90
Effect of alcohol on the reaction-time in reading isolated words	90
Exposure apparatus	91
Voice-reaction key	97
Experimental procedure	99
Records	101
Results	101
Summary of the word-reactions	106
Effect of alcohol on word-reaction	108

	PAGE.
CHAPTER IV.—EFFECT OF ALCOHOL ON FREE ASSOCIATIONS.....	109-125
Methods and apparatus.....	109
Apparatus for the psycho-galvanic reflex.....	109
Apparatus for recording the association time.....	110
Stimulus words.....	113
Association-reaction time.....	114
Associative categories.....	117
“Frequency” of the response words.....	120
Correlations between the various measurements.....	123
Special episodes.....	125
CHAPTER V.—EFFECT OF ALCOHOL ON THE PROCESS OF MEMORIZING.....	126-133
Apparatus and technique.....	129
Experimental procedure.....	132
Summary of the effect of alcohol on memory.....	133
CHAPTER VI.—EFFECT OF ALCOHOL ON THE SENSORY THRESHOLD FOR FARADIC STIMULATION (MARTIN MEASUREMENTS).....	134-145
Apparatus and technique.....	137
Results.....	139
CHAPTER VII.—EFFECT OF ALCOHOL ON MOTOR COÖRDINATIONS.....	146-185
General motor processes.....	146
Motor coördinations.....	148
Effect of alcohol on the velocity of eye-movements of the first type.....	150
Technique for measuring the velocity of eye-movements.....	151
Results.....	154
Summary of eye-movement data.....	164
Effect of alcohol on the reciprocal innervation of the finger.....	167
Technique.....	168
Apparatus.....	169
Position of the subject.....	170
Experimental procedure.....	170
Results.....	171
Summary of finger-movement data.....	182
CHAPTER VIII.—EFFECT OF ALCOHOL ON THE PULSE-RATE DURING MENTAL AND PHYSICAL WORK EXPERIMENTS.....	186-241
Techniques for recording the pulse during psychological experiments.....	189
Telephone pulse-recorder.....	189
Construction and operation of an electrical sphygmograph for recording pulse-rate at a distance.....	189
Electro-cardiograms from body leads through condensers.....	193
Effect of alcohol on the pulse-rate during association experiments.....	194
Effect of alcohol on the pulse-rate during word-reaction and finger-movement experiments and also during moderate muscular activity and rest.....	211
Cause of the relative acceleration of the pulse after alcohol.....	233
CHAPTER IX.—SUMMARIES AND CORRELATIONS.....	242-265
Differential incidence of the effects of alcohol.....	242
Evidence for alcoholic stimulation.....	250
Is alcoholic depression a conservative process?.....	253
Temporal incidence of the effect after the ingestion of alcohol.....	256
Effect of repetition on the various measurements.....	259
Correlation of the various measurements with the average.....	262
APPENDIX I.—Tentative plan of investigation on physiological and psychological effects of alcohol on man.....	266-275
APPENDIX II.—Family and personal histories of the subjects.....	276-281

ILLUSTRATIONS.

	PAGE.
Frontispiece. General view of the psychological laboratory of the Nutrition Laboratory.	
FIG. 1. General plan of psychological laboratory and apparatus.....	31
2. Main apparatus table in psychological laboratory (first view).....	32
3. Main apparatus table in psychological laboratory (second view).....	32
4. Apparatus for stimulating the patellar reflex.....	38
5. A typical record of the patellar reflex.....	43
6. The noise-stimulus apparatus for the lid-reflex in position before the photographic recording camera.....	59
7. Time-recording interruptor at rest.....	60
8. Interruptor in action.....	60
9. Protective lid-reflex record.....	60
10. Falling-plate recording-camera.....	80
11. Falling-plate recording-camera (inner construction).....	80
12. Eye-reaction records.....	83
13. Diagram of pendulum-stop exposure apparatus.....	94
14. Diagram of apparatus for Faradic threshold, word-reaction, lid-reflex, and eye-movement.....	95
15. Record showing latency of the pendulum-stop exposure apparatus.....	96
16. Voice-reaction key.....	99
17 to 20. Records of the latency of the voice key.....	100
21. Photograph of a subject in position for the association experiments.....	101
22. Typical record of a word-reaction experiment.....	101
23. Curves of the association-reaction time.....	115
24. Curves of the frequency of the association categories.....	118
25. Curves of the usualness of the association.....	122
26. Diagram of the connections for memory experiment.....	129
27. Typical eye-movement record.....	154
28. Typical records of the finger-oscillations and pulse of two subjects.....	171
29. Reproduction of a temporal-pulse record as made by the Dodge telephone-recorder in series with the string galvanometer.....	171
30. Part of an association experiment record.....	195
31. Association pulse of Subject VII.....	201
32. Variations of the normal subjects from the average of the group for various measurements.....	264

PSYCHOLOGICAL EFFECTS OF ALCOHOL

AN EXPERIMENTAL INVESTIGATION
OF THE
EFFECTS OF MODERATE DOSES OF ETHYL ALCOHOL ON A
RELATED GROUP OF NEURO-MUSCULAR
PROCESSES IN MAN

BY
RAYMOND DODGE AND FRANCIS G. BENEDICT

With a chapter on Free Association, in collaboration with F. Lyman Wells

CHAPTER I.

PLAN OF THE INVESTIGATION

Probably no subject in physiological chemistry has received so much desultory experimental attention as has that of the effects of ethyl alcohol on organic processes. We have numerous systematic and exhaustive contributory studies on the physiology of the proteins, of the carbohydrates, and of the fats; but in spite of the fact that several million people regularly obtain a somewhat larger proportion of their total energy requirement from alcohol than they do from protein, there has been no adequate, systematic investigation of the metabolism of alcohol and its physiological action. This is a misfortune to science. On these grounds the Nutrition Laboratory believed it important to classify the lines of research, and to prepare a tentative plan for an extended systematic investigation into the physiological action of ethyl alcohol in man.

While the central problems of the plan are questions of general physiology and total metabolism, it seemed desirable that there should be a correlated investigation of the psychological effects of alcohol. Accordingly, as the plan indicates, a definite program was arranged for the study of the specific effects of alcohol on the various neural processes. This plan,¹ which was privately printed and issued under date of January 1, 1913, is reprinted in full, with minor typographical changes, as Appendix I of this monograph.

As a consequence of the distribution of this plan among scientists in Europe and in America, we received a large number of comments and suggestions which showed clearly that the program was given serious consideration. Many scientists granted personal interviews and freely discussed the problems. These are Drs. Paul Héger, Slosse, and Van Laer, of Brussels; Alquier and Bertrand, of Paris; Kossel, of Heidelberg; Cohnheim, of Hamburg; Jaquet and Staehelin, of Basel; Fano, of Florence; Luciani, of Rome; Tangl and Vérzar, of Budapest; Durig, Kassowitz, and Hans Horst Meyer, of Vienna; Franck, Grüber, F. Müller, and Neubauer, of Munich; His, Rubner, and Zuntz, of Berlin; Schaternikoff, of Moscow; Albitsky, Kartaschewsky, Likhatscheff, and Pawlow, of Petrograd; Tigerstedt and Von Wendt, of Helsingfors; Arrhenius, Johansson, and Santesson, of Stockholm; Hasselbalch,

¹Tentative Plan for a Proposed Investigation into the Physiological Action of Ethyl Alcohol in Man. Boston, 1913. (Reprinted as Appendix I.)

Henriques, and Krogh, of Copenhagen; Hamburger, of Groningen; Pekelharing and Zwaardemacher, of Utrecht; Pembrey, of London; Schaefer, of Edinburgh; and Martin, of Boston.

Many of these gentlemen supplemented their personal interviews by carefully written statements with regard to the program, and friendly, helpful letters were also received from the following: Drs. Hemmeter, Baltimore; Metzner, Basel; Bickel, Friedenthal, and Grotjahn, Berlin; Külpe, Bonn; Cannon, Cabot, Councilman, W. F. Dearborn, Edsall, Hunt, Joslin, and Rosenau, Boston; Cleghorn, Brantford, Canada; Aron and Rosenfeld, Breslau; Hari, Budapest; Langfeld, Cambridge, Massachusetts; Rivers, Cambridge, England; MacNider, Chapel Hill, North Carolina; Hough, Charlottesville, Virginia; Carlson, Freeman, and Judd, Chicago; MacLeod and Sollmann, Cleveland, Ohio; Sewall, Denver; Kirkpatrick, Fitchburg; Morawitz, Freiburg; Cattell, Garrison-on-Hudson, New York; Müller, Göttingen; Abderhalden and Schmidt, Halle; Bingham, Hanover, New Hampshire; Cushny and Horsley, London; Davenport, Long Island, New York; Cady, Middletown, Connecticut; Rosemann and Krummacher, Münster; Galeotti, Naples; Berthelot, Neuchâtel; Henderson and Mendel, New Haven, Connecticut; Coleman, Dana, and Thorndike, New York; Douglas, Oxford; Hare and Keen, Philadelphia; Holitscher, Pirkenhammer bei Karlsbad; Brooks, Pittsburgh, Pennsylvania; Pick, Prague; Shaffer, St. Louis, Missouri; Crawford, Palo Alto, California; Geill, Viborg; Goddard, Vineland, New Jersey; Franz, Langworthy, and Salant, Washington, D. C.

Helpful criticism of the psychological program was given on the occasion of the partial presentation of our data at the 1914 meeting of Experimental Psychologists at Columbia University and at the Philadelphia meeting of the American Psychological Association, 1915.

It was generally felt that the tentative plan filled a real need. The principle of commencing a new alcohol research upon definitely organized lines was fully approved by practically all of the scientists with whom we conferred. While the Nutrition Laboratory is committed to a continuation of the investigation, and while definite arrangements have been formulated to make the alcohol investigation, either on the physiological side or on the psychological side, a substantial part of each year's work, it is inconceivable that any one or a dozen laboratories can adequately complete this program in a decade. Consequently, as the published program clearly stated, it was presented with the hope that it would suggest profitable lines of articulated research in a considerable number of laboratories and institutions whose facilities and interests particularly fit them for undertaking the various problems.

In the tentative plan no suggestions were made for digesting the literature of alcohol. The accumulation of scientific research upon the physiology and psychology of alcohol has been in more or less active

progress for the last half century. An enormous number of titles is included in the available bibliographies, notably those of Abderhalden¹ and Viazemsky.² Many of these researches are at present absolutely inaccessible to us. To cover all adequately would be the labor of years. To delay experimentation until a complete digest had been made would have meant to postpone experimental work indefinitely. We have attempted to digest the main experimental investigations pertaining to the special phases of the alcohol problem of which we treat in this book; but we have written with a painful sense of many omissions that should appear in any attempt to record faithfully each experimenter's share in the progress of knowledge concerning the psychology of alcohol. Our lists of works cited disclaim any pretense of being a complete collection of the relevant literature. For such, reference must be made to the excellent bibliographies just cited.

The investigation of certain purely physiological phases of the alcohol problem was begun concurrently with the investigation in the psychological laboratory. But the larger proportion of the efforts of the Nutrition Laboratory in the alcohol investigation during the academic year of 1913-14 were concentrated upon the psychological program. This arrangement seemed desirable, since we were forced to take advantage of the relatively short time that Dodge could be free from his academic work. This first publication under the general plan for the systematic investigation of alcohol consequently has to deal with the effects of alcohol on the neuro-muscular tissue, with special reference to mental operations and conduct.

Neither the technical nor the practical difficulties of this phase of the problem were underestimated. As we pointed out in the psychological program, unfortunately only the simpler and more elementary neuro-muscular processes can be studied directly by present laboratory techniques. Of the important higher mental and moral processes there is at present scant probability for securing experimental data of scientific reliability, owing to the difficulty of measuring them experimentally in any direct way. This technical defect is a serious limitation to all experimental investigations of the psychological effects of the ingestion of alcohol, since it is in precisely these directions that our general and scientific experience indicates that the effects of alcohol are probably the most serious.³ It is in these directions also that animal experimentation most needs to be supplemented by data from human subjects. The present investigation makes no pretense to have

¹Abderhalden, *Bibliographie der gesamten wissenschaftlichen Literatur über den Alkohol und den Alkoholismus*, Berlin and Vienna, 1904.

²Viazemsky, *A bibliography on the question of alcoholism*, Moscow, 1909, Part I. (Russian.) The Russian original, together with an English translation made by H. A. Norman and H. B. Dine, are both on file at the Nutrition Laboratory.

³Hodge, *Pop. Sci. Monthly*, 1896-97, **50**, pp. 594 and 796; Hunt, Hyg. Lab., *Public Health and Marine-Hospital Service Bull.* No. 33, 1907; Laitinen, *Zeitschr. f. Hyg. u. Infektionskrankheiten*, 1907, **58**, p. 139.

solved this fundamental technical difficulty. We believe, however, that in our selection of definitely related groups of measurable phenomena we have not only secured accurate data concerning the action of alcohol on definite neuro-muscular processes, but that we have positively contributed to the knowledge of the conditions of the more complex psycho-physiological effects.

In addition to the theoretical and technical considerations which we outlined in the psychological program, a number of accidental conditions combined to determine the particular series of measurements that could be undertaken in the single academic year which Dodge could devote to the alcohol program. These were chiefly matters of expediency. They concerned the economical use of the time, energy, and laboratory equipment which were available. Two different reactions to these practical limitations suggested themselves. The first was to cover as much of the program as practicable with one or two subjects. One could thus eliminate by trial such technique as seemed likely to yield least consistent data and elaborate those that seemed more promising. The second possibility was to limit the year's work to relatively few lines of research, investigating the neuro-muscular system at various levels by techniques for which we were peculiarly well equipped, and endeavoring to make the data from those particular lines of investigation as exhaustive and definitive as possible. After consideration, the second reaction was adopted as on the whole the more expedient. Under these circumstances it was inevitable that the year's work should raise many questions to which there was no opportunity for obtaining experimental answers. This explains also why a considerable part of our original psychological program is apparently neglected, and why we were unable to put into practice the many valuable suggestions which were kindly sent in reply to our request for suggestions and criticisms on the original program. The Nutrition Laboratory is continuing this part of its plan under the direction of Professor W. R. Miles. It is a pleasure to acknowledge our grateful obligation to Professor Miles for his kindness in supplying several of the photographs used in this report and for his counsel in many ways. The preparation of the report has had the editorial supervision of Miss A. N. Darling, whose careful scrutiny of the tabular presentation of the material has been a valued service.

Before beginning experimentation on the effects of alcohol upon the neuro-muscular processes, the special laboratory devoted to this purpose had been partially equipped for nearly a year and the main apparatus had been tested in a systematic research with several subjects on the neuro-muscular effects accompanying the metabolic disturbances which were provoked by an acidosis resulting from the use of a carbohydrate-free diet. Thus we were able to secure valuable experience prior to the undertaking of this more elaborate research.

The following neuro-muscular processes were investigated in relation to the effects of alcohol:

- (1) Simple reflexes:
 - (a) Lumbar arc. The patellar reflex, its latency and extent of contraction as measured by quadriceps thickening, with indication of its refractory period.
 - (b) Cephalic arc. The protective lid-reflex to noise stimulus; its latency, extent of movement, and refractory period.
- (2) Complicated reactions—cortical arcs:
 - (a) Eye-reactions to suddenly appearing peripheral visual stimuli.
 - (b) Adequate speech-reactions to a series of 24 visual words.
- (3) Free-association reactions. Latency, character of the response, and concurrent pulse-changes.
- (4) Memory. Learning a normal series of 12 significant but unconnected words.
- (5) Sensory threshold to Faradic stimulation. Method of Martin.¹
- (6) Motor coördination:
 - (a) Speed of the reciprocal innervation of the middle finger.
 - (b) Speed and accuracy of eye-movements in looking from one point of fixation to another in the same horizontal plane through an arc of 40°.
- (7) In addition to the neuro-muscular processes of the cerebro-spinal system, the autonomic system was investigated in the peculiarly significant pulse-rate. Throughout the experiments pulse was recorded either continuously or at such intervals as the changing conditions seemed to warrant.

PRINCIPLES OF SELECTION OF THE EXPERIMENTAL PROCESSES.

In several respects this group of experimental measurements represents a conscious departure from traditional methods for the investigation of the effects of foods or drugs on man. The fundamental principle of their selection was the attempt to secure a group of systematically coördinated measurements. Instead of studying the effect of alcohol on special, isolated, more or less arbitrarily chosen processes, we have tried to bring together systematically coördinated data covering the most fundamental aspects of neuro-muscular action.

It may be objected that in the end several investigations of different processes, even though the latter are somewhat arbitrarily chosen, would be as useful as a single investigation of coördinated processes. It would seem that if unrelated investigations are sufficiently numerous and sufficiently varied, they must finally furnish data for the most extensive correlations. This would undoubtedly be true provided the experimental material were obtained by comparable techniques on the same subjects. Such conditions, however, could scarcely be realized, except in carefully organized series like the present. Even under the

¹Martin, Measurement of Induction Shocks, New York, N. Y., 1912.

most favorable experimental conditions the individual subject is often measurably different in his reactions at one session from what he was at another. The statistical problem of correlating the various measurements would be enormously more difficult if, in addition to the differences of the individual at different times, one must take into account the still larger differences between the several individuals.

Whatever the faults of the present application of our fundamental principle, and they are admittedly many, we feel confident that the attempt to secure accurate measurements of the most complete possible group of systematically related phenomena is sound procedure. Indeed, on any of the current theories of science it appears to be the only sound basis for this sort of experimentation on man. Only in the simplest of inorganic processes can the measurement of a single function be satisfactory. The more complex the system under investigation the greater will be the number of possible organic variants, and the larger should be the group of coördinated measurements. In a group of tissues as complex as the neuro-muscular tissues in man our best arrangements for simultaneous measurements of coördinated processes must fall far short of the ideal.

The arrangement of the experimental processes in convenient series was entirely a matter of laboratory economy and expediency. The main principles of arrangement were to distribute the use of our instruments so as to prevent waste of time and material, to avoid disturbing readjustments of the subject, and to condense the most possible into the half-hour periods into which the sessions were divided. Recombinations of the series were consequently not specially avoided where they would increase laboratory efficiency. There were originally five series of experiments which were subsequently reduced to three, partly by the omission of some of the members and partly by consolidation. Experiments which were not carried into latter series are marked "not continued." The various original series are as follows:

SERIES I.

(1) Electro-cardiogram, lead I, of Einthoven, taken at the first session only (not continued). (2) Reciprocal innervation of the middle finger of the right hand for 8 seconds repeated after 60 seconds. (3) Pulse-records (temporal artery, telephone recorder) at rest and during finger-movements. (4) Patellar reflex; stimulated by pendulum hammers of various weights and recorded from the quadriceps thickening. (5) Sensory threshold to Faradic stimulation, Martin¹ measurement.

SERIES II.

(1) Eye-reactions. (2) Eye-movements through an angle of 40°. (3) Protective lid-reaction to noise stimulus. (4) Memory. (5) Tapping test, full arm and wrist (not continued). (6) Time estimates, seconds (not continued).

¹Martin; Measurement of Induction Shocks, New York, N. Y., 1912.

SERIES III.

(1) Adequate speech-reaction to visual words. (2) Memory, repetitions and new material. (3) Protective lid-reflex to noise stimulus with controlled attention. (4) Involuntary eye-movements in reading a moving text with supposed constant fixation (not continued). (5) Pulse-records, quiet, immediately after standing and after 60 seconds of standing, after two double genuflections, and after 60 seconds quiet. (6) Threshold for muscle contraction in response to Faradic stimulation (not continued).

SERIES IV.

(1) Adequate speech-reactions to complete series of 24 words with concurrent pulse-records. (2) Finger, hand, and arm tremors, photographic registration (not continued). (3) Rapid reading, with photographic registration of eye-movements: (a) natural, as rapid as possible; (b) letter by letter (not continued). (4) Convergence and divergence eye-movements (not continued). (5) Pulse-records as in Series III.

SERIES V.

(1) Association experiments under the direction of Dr. F. L. Wells, of McLean Hospital staff, with continuous graphic records of reaction time, pulse, and respiration, and occasional observation of the "psycho-galvanic reflex" by the aid of the string galvanometer. (2) Sensory threshold to Faradic stimulation.

In the 12-hour experiments, Series I to IV were condensed to a single series, which was repeated each hour: (1) patellar reflex; (2) sensory threshold to Faradic stimulation; (3) protective lid-reflex; (4) eye-reaction; (5) eye-movement; (6) speech-reaction with pulse; (7) finger-movement with pulse.

Series V was never changed nor united with any other. It was not given to the psychopathic subjects. (See p. 25.)

For most of the main group of subjects, and for all the psychopathic and occasional subjects, Series I to IV were condensed to two series, as follows:

SERIES I A.

(1) Patellar reflex; (2) speech-reactions with pulse; (3) finger-movements with pulse; (4) threshold to Faradic stimulation.

SERIES II A.

(1) Eye-reaction; (2) eye-movement; (3) protective lid-reflex; (4) memory; (5) pulse at rest, after rising, and after two double genuflections.

In the succeeding detailed discussion of the various techniques and their results the matter will be arranged according to the nature of the experiment rather than according to the series.

If we call the first principle which determined our selection of measurable phenomena the principle of systematic coördination, a second conscious departure from traditional procedure may be called the principle of relative simplicity. We have made the attempt to inves-

tigate elementary neuro-muscular processes in their simplest available form, and of the more complex processes to choose those involving as few unknown factors as possible. In particular we have tried to measure processes that were as insusceptible as possible to direct and arbitrary conscious modification, and as free as possible from uncontrollable influences of bias, effort, and attention. We thus tried to avoid the occasion for most of the adverse criticism that has been directed against earlier researches on the psychological effects of alcohol. This second principle led us to lay particular emphasis on the simplest reflex arcs as a precondition for interpreting the complicated reactions. In addition to the accuracy and simplicity of the photographic technique, the freedom of the processes from arbitrary modification led us to measure the velocity of the eye-movements in preference to the movement of members which are more subject to voluntary control. The same principle of simplicity led us to measure the sensory threshold for Faradic stimulation in preference to those sense thresholds which are complicated by more or less elaborate adaptive mechanisms, as in vision; or by the irregular interplay of related sense data, as in the pressure threshold. On the negative side, this principle led us to exclude a considerable number of familiar techniques, the most conspicuous example of which is the ergographic experiment. In addition to the fact that any ergographic data which we might collect would add relatively little to the mass of more or less conflicting data already at hand, and quite apart from the purely mechanical difficulties in the operation of the ergograph and in the interpretation of the resulting data, we were disinclined to use that instrument because of the fundamental difficulty of disentangling the numerous physiological and psychological factors that unite to produce any specific ergographic accomplishment.¹ On similar grounds, any measurements involving long-sustained attention or effort, or indifference to increasing discomfort, without opportunity for adequate, objective control, seemed undesirable. But obviously, even at best, in view of recent analyses of neuro-muscular processes, such as those of Sherrington,² Verworn,³ and Isserlin,⁴ simplicity can be no more than a relative term. We must concede that the action of even the simplest spinal arcs is normally dependent on the interplay of an indefinite number of inhibiting and reinforcing conditions that can never be entirely eliminated. The action of the higher nervous

¹The attempt of Mlle. Joteyko (Joteyko, *Travaux du Laboratoire de Physiologie, Instituts Solvay, Brussels, 1904, 6, p. 361*) to give a mathematical expression to the interrelationship of central factors, the effects of exhaustion, and the intoxication by fatigue products must be regarded as suggesting a direction of investigation rather than as establishing a technique. At the present time, at least, her original analysis can not be said to supply a reliable instrument for general application to ergographic curves. The classical analysis of the fatigue curve by Kraepelin shows how complex may be the interplay of the various factors.

²Sherrington, *Integrative Action of the Nervous System*, New York, N. Y., 1907.

³Verworn, *Irritability*, New Haven, 1913; *Verworn, Erregung und Lähmung*, Jena, 1914.

⁴Isserlin, *Psychol. Arbeiten*, 1914, 6, pp. 1 to 196.

centers commonly follows enormously complex patterns. Granting all the difficulties, we still believe that the principle of simplicity is an important practical guide in the selection of measurable phenomena, even though it must remain for the present a principle of relative simplicity.

A third principle that guided us in the selection of our techniques is the principle of customary reaction. Wherever the practice curve is not intentionally an object of investigation, we believed that our experiments should be so arranged that the motor response of the subject will be a thoroughly natural and familiar act. The theoretical advantage of customary reaction is that, in view of the large number of pre-experimental responses of a similar character, the relatively few experimental instances would not operate to introduce a practice curve in the results.¹ It was on this principle that we chose adequate eye-reactions instead of any arbitrary opening or closing of special reaction keys. The adaptive movement of the eyes, by which a suddenly appearing peripheral object is fixated, has been practiced since birth. It does not have to be taught the subject for experimental purposes. It consequently seemed unlikely to us that any practice effects of our relatively short experimental series would materially affect the results. The sequel will show that our technique did not entirely eliminate unusual limitation in the variety of possible positions and consequent practice. But that does not affect the value of the principle. It was on similar grounds that we chose the familiar speech-reactions to visual word-stimuli in place of the more unfamiliar controlled association tests.

It should be emphasized that neither the principles of selection nor the techniques for measuring the selected processes were elaborated solely for the study of the effects of the ingestion of alcohol. With the exception of the Martin's Faradic threshold measurements and the association experiments, for which Dr. F. L. Wells was responsible, both the theory and the techniques of all our measurements have been elaborated by Dodge² through a number of years with special reference to their bearing on mental work and mental fatigue. Not only were the technique and apparatus in general thoroughly tried out, but the particular equipment of the psychological laboratory had been installed and tested in the previous acidosis experiments. Furthermore, assistants had been thoroughly trained to this investigation before the alcohol problem was begun.

¹Bryan and Harter, *Psychol. Review*, 1897, 4, p. 27; also 1899, 6, p. 346; Book, *The Psychology of Skill*, 1908; Swift, *Mind in the Making*, New York, 1908.

²Detailed references to the original papers are given in the bibliography of the various processes.

GENERAL METHODOLOGICAL CONSIDERATIONS.

The problem of studying the consequences of any experimental interference with a living organism is fundamentally a problem of scientific method, both general and specific. Both the experimenter and his critical reader should have clearly in mind the available canons of investigation, and the degree of accuracy that may be legitimately expected in the results, as well as the specific lines of investigation and the specific techniques that can be relied on to yield adequate quantitative data. Since in our case the question at issue is the nature of the neuro-muscular consequences of the ingestion of alcohol, the logical problem is strictly causal. It is our task to isolate from the complex phenomena that may follow the experimental ingestion of alcohol the uniform and necessary consequences.

It may not be amiss to emphasize at the beginning that the basic experimental method of difference in its true form is inapplicable in such experiments as these. It is obviously impossible to isolate a single experimental circumstance in man. The living human organism includes too many complex variables. It is subject to too many rhythmic and arrhythmic changes, which make it, at any moment of time, different from what it has ever been before. After the introduction of our experimental circumstance into this complex of ever-changing conditions, we could not be sure that even notable variations in the measurements of selected processes were not conditioned in whole or in part by organic changes which were quite unrelated to our experiment. Our excuse for appearing to insist on the obvious is that in past experiments on the physiological effects of drugs the obvious has not always been noticed. The importance of distinguishing between the accidental and the necessary by carefully planned series of control experiments is a relatively recent product. It is not always realized even in current studies. Still more frequently do experiments on the effects of drugs on animals as well as on man fail to provide for an adequate statistical elaboration of their results. This is a particularly difficult matter in operative techniques. But, in man at least, it is never a satisfactory procedure to regard succeeding changes in a measured phenomenon as the effect of an experimental change, merely because one is consequent to the other.

If all the organic rhythms and accidental changes were adequately known we might arrive at the quantitative results of our experiment by a process of subduction. Unfortunately, with our present knowledge this can not be done directly. With a few notable exceptions, such as the work of Lombard,¹ and of Grabfield and Martin,² we know altogether too little about the daily rhythms of even the simplest neuro-muscular processes. We have still scantier quantitative data of the

¹Lombard, *Journ. Physiol.*, 1892, **13**, p. 25.

²Grabfield and Martin, *Am. Journ. Physiol.*, 1912-13, **31**, p. 300.

accidental environmental effects, such as those produced by changes of temperature, light, humidity, etc. Except in a few isolated cases we have no knowledge at all of the mental consequences of such complex vital processes as are involved in the secretions of the various ductless glands, changes in blood-pressure and pulse-rate, the ingestion of different foods, and various kinds of muscular activity.

As far as these various factors were known to influence the question at issue, they were more or less completely avoided by the arrangement of our experimental program. For example, we endeavored to avoid the interplay of possible weekly, as well as daily, rhythms by experimenting on each subject, in so far as possible, only once a week on the same day of the week, at the same time of day, and at the same time after eating. (The group of psychopathic subjects made the only exception to this rule. They served as subjects five consecutive days.) But the climatic changes were not controllable. Moreover, from the data that we regularly collected at the beginning of each experimental session, it is clear that in the comparatively even life of students there were more or less conspicuous differences in the conditions which immediately preceded our experiments. The weekly routine of work and relaxation was far from constant. Neither the amount nor the kind of food could be accurately predetermined. Slight indispositions, differences of subjective tiredness and sleepiness, and probable differences of real fatigue developed as the experimental sessions progressed. To have interrupted or deferred the experiments whenever any of these differences appeared would have lost much time and have enormously increased the number of experimental periods. To have demanded rigid controls and strict regulation of life would have meant the loss of all our subjects of the student class, and possible serious mental disturbances in the others. The complete elimination of physiological variation would be utterly impossible in human beings.

For the purpose of our experimental investigation we were consequently forced to regard all the rhythmic and arrhythmic variables which we could not eliminate as accidents which a sufficiently large number of instances should tend to distribute, without bias to the question at issue. While we must carefully protect the experiments from every known bias, we must realize the possibility that in any given instance the real effects of alcohol may be completely masked by the accidental variables, and on the other hand, that on occasion the real effects may be more or less grossly exaggerated. Within the physiological limits which are prescribed by our immediate problem, viz., the effects of moderate doses, we can not expect any fundamentally important neuro-muscular process to entirely disappear. Neither may we properly expect the appearance of a new specific reaction to alcohol within the limits of our selected measurements. All that we can legitimately expect to say at the end of our investigation is that

some modifications of the measurable qualities of selected neuro-muscular processes occur more regularly or in greater or less degree after the ingestion of alcohol than without it. Giving due weight to our measurements of the normal variations, we can say that the average change in the measurable qualities of the selected processes after the ingestion of alcohol, minus the average change under otherwise similar conditions, but without the ingestion of alcohol, will represent the effects of the dose of alcohol that was administered. Experimental results of this sort have a degree of probability which depends not only on the accuracy of the individual measurements and the similarity of controllable circumstances, but also on the number of experimental instances and on the probability of a really chance distribution of the accidental variations. The sequel will show that for no single subject are the data sufficiently numerous, except in the case of the pulse-records, to give a satisfactory quantitative statement of the individual differences of the effect of alcohol. Our experimental answer to the main question at issue, viz, as to the general direction and amount of change in the various processes consequent to the experimental ingestion of alcohol, is, we believe, conclusive and adequate.

In addition to the main experimental precautions, we systematically varied the alcohol dose. This was done for the following reasons: In the first place, it is a fact that different doses of some drugs produce quite different physiological effects, amounting even to a change of sign. That this is probably true of alcohol seemed to be indicated in more than one experimental investigation. The existence and conditions of such a change in the effect of alcohol, if it really occurs, is a peculiarly important phase of the alcohol problem. In the second place, we felt that no safeguard against mistaking accidental variation for causal relationship is so effective and no evidence is quite so convincing as that of concomitant variation in the amount of the alcohol dose and its effects. We believe that the results justify the increased labor, and that in no other way could we have secured the same insight into the vagaries of the commonly observed effects of alcohol.

NORMAL OR BASAL EXPERIMENTS.

The fundamental requirements of method which we have already considered demand the largest possible number of measurements of the phenomena under investigation, both with and without alcohol, but under otherwise similar or comparable circumstances. On general logical principles, the number of instances should be approximately equal in both cases. This was arranged for in our routine, by the regular introduction of normal days identical with the alcohol days as far as practicable, with the exception that on normal days no alcohol was administered. Furthermore, even on alcohol days one normal period was given before the dose. Each experimental session may

thus be regarded as beginning with a "normal of the day,"¹ which was followed either by normal or by alcohol experiments according to a predetermined plan.

The non-alcohol periods and days are frequently called control periods and control days in the literature. The term is misleading. It would seem to imply that such experimental periods were occasional and incidental to the main course of the experiments. In fact, the non-alcohol experiment is as essential to the logical theory as the alcohol experiment. Strictly speaking, the non-alcohol experiments are not supposed to furnish controls of the validity of the other experiments; they are supposed to furnish norms or base-lines from which the alcohol experiments may or may not show characteristic differences. In careful terminology, then, our non-alcohol experiments are not controls, but basal or normal experiments, as Warren¹ and Rivers² properly call them.

The normal or basal experiments were necessarily placed somewhat differently in the various series, as they were arranged for the different groups of subjects. The general arrangement for the main group was as follows: For each series of tests, one normal session of three consecutive hours preceded experiments with alcohol. Then followed one session each with the smaller and larger dose of alcohol respectively, given after the normal of the day. A final normal session concluded the work of each subject in each series of experiments. The psychopathic subjects began each of their two series of experiments with a normal session. This was followed by an alcohol session for the same series. On the fifth day a normal session was given for the combined series. In the 12-hour experiments only two subjects were used, and they were already familiar with the tests. The first day for each of them was normal. On the second day hourly doses of 12 c.c. absolute alcohol were administered after the normal of the day. In all cases the alcohol was administered after dilution with 5 volumes of water, cereal coffee, or other flavoring liquid. The arrangement as outlined above provided for normal sessions before and after the alcohol sessions. This gave an adequate normal base-line for the experiments, and provided that any effects of practice in the various tests which might appear in the alcohol sessions must also appear in the normal.

¹A term first used in alcohol experiments by Prof. J. W. Warren. (*Journ. Physiol.*, 1887, 8, p. 311.)

²Rivers, *The Influence of Alcohol and Other Drugs on Fatigue*, London, 1908.

CONTROL MIXTURES.

As our program indicated (Appendix I, p. 272) we were unmindful neither of the advisability nor of the difficulty of preparing a suitable control mixture to be used on normal days in place of the dose of alcohol. Since the discussion of Rivers,¹ the regular use of control doses has become a touchstone of accuracy in psycho-physiological experiments with drugs. The function of the control mixture is to prevent the subject's knowing which are normal and which are alcohol sessions. As Rivers himself notes, such control doses are relatively easy to prepare in the case of caffeine and relatively difficult in the case of alcohol. The difficulty in the case of alcohol became more and more apparent as our preparations progressed.

With the help of the various chemists of the Nutrition Laboratory, and the advice of a number of physiologists, a variety of possible control mixtures were considered. A number of these, including the preparation advised by Rivers,² were tried on ourselves and other members of the Laboratory staff. None of them proved to be entirely satisfactory. In every case the alcohol mixture of a concentration anywhere approximating 20 per cent could always be detected by competent observers, even when the flavoring was sufficiently strong to raise serious questions as to its pharmaceutical indifference. Wiping the rim of the glass which contained the control mixture with alcohol introduced a somewhat confusing discrepancy between smell and taste, but the alcohol "taste," its peculiar stinging warmth, was never even approximately masked. If enough capsicum were put into the control dose to produce a sting at all comparable to that of the alcohol, it was conspicuously different in its subjective after-effects. But even then the control dose seemed flat.

In those cases where the administration of control mixtures seemed imperative, *i. e.*, for the psychopathic subjects, we used Rivers's mixture, substituting 1 c.c. strong infusion of quassia for the capsicum. We substituted the quassia for the capsicum because of its pharmaceutical indifference and because of the general capacity of a strong bitter to cover other tastes. The mixture has good precedents; quassia was used by Zimmerberg,³ and by Von der Mühl and Jaquet.⁴ It produces a medicine-like taste which apparently distracts the attention from the other ingredients. While in these experiments none of the

¹Rivers, *The Influence of Alcohol and Other Drugs on Fatigue*, London, 1908.

²Concerning his recent experience with the control mixture Professor Rivers kindly gave us information by letter. The control finally adopted by him is as follows:

Concentrated compound infusion of orange	0.5 drachm.
Elixir saccharine	1 minim.
Alcohol or water	1 ounce.
Liquor capsici	to taste.

³Zimmerberg, *Untersuchungen über den Einfluss des Alkohols auf die Thätigkeit des Herzens*. Dissertation. Dorpat, 1869.

⁴Von der Mühl and Jaquet, *Corresp.-Blatt f. schweizer Aerzte*, 1891, 21, p. 457.

psychopathic subjects knew whether or not alcohol was being given, they all spontaneously remarked that the dose with alcohol was "stronger" than the other. Even the hard drinker (Subject XIII) specified that it felt warm in the stomach.

There appear to be only three adequate means for masking the alcohol: capsules, stomach or duodenal tube, and intravenous injections. It seemed to us that the use of any of the three would violate the principle of simplicity; that is, all of them would introduce into the experimental process more or less distracting if not annoying conditions which would be subject to enormous adaptive variations as the experiment progressed. Capsules seemed inexpedient because of the size and number that would be necessary to ingest 30 c.c. of alcohol in suitable dilution. Many subjects would apparently be unavailable if large capsules were used, through inability to swallow them. The stomach-tube would doubtless be less objectionable after sufficient practice, but the judgment of various physicians was that it would take some subjects so long to become even relatively indifferent to it that it was inexpedient for us to try it. The use of intravenous injections apparently presented too many possibilities for serious trouble. We believe, however, that if it becomes essential to completely mask the alcohol dose, some one of these devices must be used.

It seems clear to us that if the alcohol must be masked it must be masked completely, with no unregulated instances of half-knowledge or doubt, controlled only by the subject's impression that the degree of knowledge did not influence the results. The difficulties of really masking the alcohol, the questionable pharmaceutical action of strong flavors, and the final probability that some of the subjects would know what they were getting, or at least be more or less conscious of differences in the doses, led us to scrutinize more closely the grounds for attempting to mask the alcohol and to keep the subject ignorant of the fact that he was taking it. The fundamental theoretical grounds for masking the ingestion of alcohol by the use of control mixtures is the increased similarity of the experimental conditions in normal and in alcohol experiments. Aside from the matter of taste, which should properly be regarded as a part of the total action of the drug, this is a valid ground; but it is significant only if the knowledge that the subject had taken alcohol might probably modify the course of the experiment. In his own case, Rivers¹ was led to suspect just such a modification of the results. He found (p. 20) "that the days on which I took the drug interested me more than the normal days on which nothing was taken." While in his own case the control mixtures were "usually wholly indistinguishable" from those which contained the active substances, Rivers remarks (p. 66), concerning the attempts to disguise the alcohol, that "the disguise is much more difficult than in

¹Rivers, *The Influence of Alcohol and Other Drugs on Fatigue*, London, 1908.

the case of caffein." While it was "very difficult to distinguish the two from one another when the dose was small," with doses of 24 to 40 c.c., such as were used in his work with the ergograph, Rivers regarded it as probable that the alcohol would be recognized; consequently he adopted the additional precaution of comparing two different doses. In other words, in experiments on alcohol, Rivers felt obliged to supplement the doubtful efficacy of control mixtures by the systematic arrangement of his experiments. We carried this process to its only logical conclusion in experiments on alcohol, *i. e.*, to develop as far as practicable the controls that are dependent on the nature of the experiments as well as those that are dependent on their systematic arrangement. These internal preventatives of the effect of bias we believe to be particularly effective in our experiments, since one of the main principles of selection of measurable phenomena was the greatest possible freedom of the process from the interplay of arbitrary and capricious voluntary modification. The danger of such bias must have been much greater in ergographic experiments, in which the complex interrelation between capacity and effort is subject to large and uncontrollable variations. It must have been peculiarly great while the experimenter served as subject. After mature consideration, in view of the impracticability of completely masking the "taste" of the alcohol, in view of our systematic precautions against voluntary modification of our experimental results, and in view of the character and variety of our subjects, we decided that the regular use of highly flavored control mixtures be abandoned, except in the case of the psychopathic subjects, in whom the knowledge that alcohol was being taken might conceivably have produced some agitation. We believe that the nature and systematic arrangement of our experiments, on the latter of which Rivers himself came finally to rely in alcohol experiments, contain more efficient controls than could be produced by the use of doubtful control mixtures.

SUBJECTS.

The selection of subjects presented a number of practical difficulties. In accordance with our program (p. 267), it seemed desirable to investigate the effects of alcohol on total abstainers, occasional users, moderate users, habitual drinkers exceeding 30 c.c. of absolute alcohol a day, and on excessive drinkers. Of these groups, the first and last proved most difficult to secure.

With respect to the first group the practical difficulties were social and moral, on the one hand, and theoretical on the other. In the first place, we were loth to assume responsibility for administering alcohol to total abstainers for a series of experimental days. There was a small but serious risk of initiating a practice that might become habitual and excessive. In the second place, we were confronted by

the theoretical absurdity that after the first experimental ingestion of alcohol the total abstainer had ceased to exist as such. For the purpose of experimentation he could scarcely be differentiated from the very moderate or occasional user. A third difficulty was the reluctance of total abstainers to serve as subjects, even for purely scientific ends. It may be remarked in passing that if there had been any chance of modifying the results by personal bias, that chance would have been greatest in the case of the total abstainer. Consequently no serious efforts were made to secure a group of totally abstinent subjects. One subject only of this class offered himself, Subject VIII. Unfortunately, business engagements interrupted his sessions before the series were completed.

For totally different reasons the class of excessive drinkers had but one representative, Subject XIII, though we had three other subjects who at one time had been excessive drinkers, the psychopathic Subjects XI, XII, and XIV. The most serious limitation to this class seems to be that the excessive drinker especially resents any considerable interference with his alcoholic habits. Our one subject of this class was a man who regularly consumed from one-half to one pint of whisky a day. Except for some general observations, his experimental results are quite worthless to us for the following reasons: The time and amount of his pre-experimental drinking could not be determined nor controlled. Even his own statements in the matter were not altogether convincing. Still more disastrous was the fact that he flatly refused to abstain long enough for a significant normal base-line. He believed that he "needed the whisky" and he did not propose to jeopardize his health by abstinence. None of his results are included in the tables of results, as without a normal base-line it seemed impossible to give them intelligible statement.

The most numerous class of subjects in our investigation was that of the moderate users. This resulted partly from the relative ease with which they could be obtained and controlled, and partly because of the comparatively small moral responsibility of the experimenters. Even in this class, however, care was exercised to secure subjects of maturity and stability of character. Legal age and graduation from a college were made prerequisites in the selection of these subjects. Three of this class of subjects who served for complete series of experiments were medical students. Three others were of the rank of instructors or interns. One was one of the writers.

A particularly interesting group of three subjects volunteered from the out-patient department of the Psychopathic Hospital of Boston. All three had been under treatment for excessive alcoholism, and were still under observation. They made excellent subjects. We would take this opportunity to thank publicly Dr. E. E. Southard and Dr. F. W. Stearns, of the Psychopathic Hospital, for their coöperation in securing this group.

At the beginning of the first experimental period, each subject was requested to supply data for the following questions:

Identification number, Date,
 Nationality of father, Mother,
 When married?
 Number and ages of brothers and sisters,
 Does father take any alcohol? ; kind, . . . ; amt., . . . ; time, . . . ; effects, . . .
 mother " " "
 brothers " " "
 sisters " " "
 Is there any habitual use of other drugs by any member of the family?
 Any nervous or mental disease in the family history?
 Any excessive use of alcohol in family history?
 Subject's age, . . . ; height, . . . ; weight, . . . ; occupation, . . . ; sport, . . .
 Education, . . . ; college or high school, . . . ; place, . . . ; scholarship, . . . ; best
 studies, . . . ; worst,
 Verbal memory, . . . ; quick, . . . ; accurate, . . . ; long, . . . ; responsive, . . .
 If abstainer, what are the reasons? moral, . . . ; scientific, . . . ; practical, . . . ;
 family, . . . ; social, . . . ; accidental,
 If non-abstainer, kind, . . . ; amt., . . . ; time, . . . ; effects,
 Largest amt. ever taken? kind, . . . ; time, . . . ; effects,
 Last use? amt., . . . ; " . . . ; " . . . ; "
 Ever intoxicated? ; when, . . . ; kind, . . . ; how often?
 How much without noticeable effect? . . . ; kind, . . . ; time,
 First noticeable effects,
 excitement or the contrary, . . . ; normal,
 talkative or the contrary, . . . ; "
 happy or the contrary, . . . ; "
 peculiar sensations,
 effect on flow of ideas,
 effect on affection, . . . ; temper,
 effect on pain, mental, . . . ; physical,
 effect on routine work, . . . ; strength, . . . ; accuracy, . . . ; ease,
 effect on sense of propriety, . . . ; on morals,
 effect on digestion, . . . ; urine,
 Use of tea and coffee,
 When last examined for life insurance, . . . ; what company,

In each case the subject was assured that his replies and the experimental data would be published anonymously. Every precaution was taken by the experimenter to secure accurate replies. A complete set of these histories of our subjects is published in Appendix II.

At the conclusion of the last experimental session each subject was given the following form, which he was required to read, fill out, and sign. No serious "exceptions" were noted under this form by any of the subjects.

The undersigned hereby makes affidavit on his honor as a gentleman:

(1) That all data given by me concerning last ingestion of food, and the use of alcohol, were correct according to the best of my knowledge and belief, except as herein specified.

(2) That there has been no conscious modification of effort or attention to modify the results; and that there has been no intention to modify them, except as herein specified.

(3) That there has been no discussion of the experiments and their probable results with any person outside the psychological laboratory, except as herein specified. (Please be full as to time and nature of the conversation, if there are exceptions.)

(4) That there has been no habitual use of drugs during the experimental weeks, and no occasional use of any drug that might modify the effects of the alcohol as far as I know, except as herein specified.

STATISTICAL EXPRESSION OF THE MEASUREMENTS.

In our previous discussion of the general methodological considerations we have pointed out certain limitations in the outside control of our subjects. It is in several respects unfortunate that the 3 hours of confinement in the laboratory determined the practical limits of strict experimental procedure. To have predetermined for all our subjects the antecedent ingestion of foods and fluids, antecedent voiding of feces and urine, antecedent amounts and kinds of mental and physical activity, and antecedent periods of rest, with fixed waking and sleeping hours, would have been difficult, if not impracticable. But even these precautions, valuable as they might be, must have failed to provide strict similarity of conditions on successive days. Experimental interference with the spontaneous reactions of intelligent and busy men in their routine demands for food and drink, work and rest, might easily produce mental and even purely physical disturbances which it would be difficult or impossible to measure. At best we could not control the immediate and remote effects of "colds," intestinal disturbances, and other slight infections of the mucous membrane. It would be obviously impossible to take account of all these and numberless similar variations, and at the same time provide for similar phases of the weekly and yearly rhythms, possible climatic changes, etc. A preliminary exploration of the possible disturbances to discover their respective significance for each of our subjects would have been entirely impracticable. Admitting the desirability of enforcing stricter experimental conditions outside of laboratory hours, it seems that the best practical procedure in the use of subjects whose outside activities are not strictly regulated is to treat all except obvious or gross disturbances as chance variations, which can not obscure any really significant tendency in the group, provided the measurements are numerous enough and their statistical treatment is adequate.

In thus emphasizing the group system of comparison we are merely following established precedents in this laboratory since its beginning. The resources and facilities of the laboratory are such as to make it practically obligatory that conclusions should not be drawn from experimental data until there are sufficiently large groups of individuals on whom the special observations have been made, and a sufficiently large number of normal experiments for adequate comparison. In the previously published studies from this Laboratory on diabetes and on the metabolism of athletes, vegetarians, and normal and atrophic infants, the group system has been invariably applied.

Our main statistical requirement, after provision is made for a sufficient number of accurate measurements of significant and systematically related processes, is to provide for the best basis of comparison of the normal and alcohol experiments.

We have raised serious objection to expressing the effect of alcohol by any difference in the measurements of the experimental processes before and after the dose is administered.¹ Such an expression would fail to show any accidental inhibition of normal changes, while it would improperly include all changes due to other intercurrent tendencies, such as the results of enforced quiet, of repetition, of regular daily rhythms, etc. There are even greater objections to expressing the effect of alcohol by the difference in the averages of measurements which are made on normal and on alcohol days respectively. Such expressions would improperly include all the accidental peculiarities of the condition of the subject on the respective days, such as changes of general well-being, fatigue, and mild infections, all the seasonal rhythms, climatic changes, etc. It is obvious, however, that if the number of experiments were sufficiently large, and if they were spread over a number of years, the accidental errors in this method of expression would tend to balance.

The real statistical problem is to find an impartial expression for the effects of alcohol from a relatively small number of experiments on a subject on any experimental day. It should tend to exclude the short rhythmic and arrhythmic changes on the one hand, and the longer changes in general condition on the other, leaving as exclusively as possible just those precise changes that are occasioned by the experiment itself. We believe that on the whole these requirements are best met by the average differences between the "normal of the day" and subsequent measurements on normal and alcohol days respectively.

The normal of a day, it will be remembered, is the result of measurements which are obtained during the first period of each session. The first period in our experiments was always normal, even on days when an alcohol dose was subsequently administered. The normal of any day should consequently represent the general condition of the subject on that particular day. The average differences between the normal of the day and subsequent measurements on a normal day should represent the normal rhythmic and arrhythmic tendencies of an experimental session. Deviations of the average difference after alcohol from a normal average difference should come as near as possible to expressing the actual change produced by the alcohol alone.

In all our statistical expressions, then, these average differences between the first and subsequent periods are of primary importance. In our tables they are commonly accompanied by a statement of average measurements, but the latter are regarded as of relatively little importance. They are only given as details that may be of interest to some future investigator who may be measuring similar processes.

The effect of alcohol on the average differences may be expressed either in absolute units or in percentiles. The percentile expression is

¹Page 18.

probably more useful for comparing one individual, dosage, or process with the others. The main objection to the percentile is that it eliminates every vestige of the units in which the measurements were actually made. It is useful for comparative purposes to know the percentage of change. It is also important to know these same changes in terms of the unit of measurement. Our summaries will contain both values.

The methods for computing these various values are not especially significant. It is important only that they be uniform and clearly understood. The *average difference* of a day's measurements is obtained as follows:

$$\text{Av. D.} = \frac{(1-2) + (1-3) + (1-4) + (1-n)}{n}$$

That is, the sum of the algebraic results of subtracting the various subsequent measurements from the normal of the day is divided by the number of periods. If the Av. D. has a minus sign it shows that the measured values are larger as the session progresses. Conversely, if the Av. D. has a positive sign it shows that on the average the subsequent measurements are less than the normal of the day.

The *effect of alcohol* as expressed in Av. D. is computed as follows:

$$\text{Effect of alcohol} = \text{the Av. D. on alcohol days} - \text{the Av. D. on normal days.}$$

If the effect of alcohol has a plus sign, then the +Av. D. on alcohol days is greater than the +Av. D. on normal days, or the latter has a negative sign. Similarly, *mutatis mutandis*, if the effect of alcohol has a negative sign. It should be noticed that the sign of the effect in all cases is a result of the statistical procedure. It does not indicate whether the effect of alcohol increases or decreases the sensitivity of a process unless it is interpreted in the light of its origin.

The *effect of alcohol* as expressed in percentiles retains the same sign as when the effect is given in the units of measurement. It is computed by dividing the latter by the average of the relevant normals of the day.

For the convenience of the reader, these various mathematical expressions are commonly reinterpreted as they occur in the tables and the text.

DOSAGE.

Neither in the experimental literature nor in the theoretical discussions is there any uniform standard of alcohol dosage. Probably the most satisfactory arrangement of the dosage, in man as in animals, would be according to some definite percentage of the mass of the blood. This would appear to be necessary in all attempts to measure individual differences. In view of our relatively simpler problem, we chose to follow the easier traditional usage in these experiments, and administer the alcohol in fixed doses for all subjects. The quantity of alcohol in

a "moderate dose" is determined neither by general experimental agreement nor by convention. Single experimental doses vary in the literature from 10 c.c. to 100 c.c. and over. Almost any size of dose would have precedents enough. Meyer and Gottlieb¹ place the "stimulating" dose for abstemious adults at 30 to 40 grams, adding that for those accustomed to its use the dose must be larger. As a standard dose we adopted what seemed to be a fair average of 30 c.c. (actually 29.8 c.c.). In the text we refer to this standard dose as *dose A*.²

Two variations of the standard dose were made for methodological reasons. In the 12-hour experiments, 12 c.c. was given hourly for 8 consecutive hours, excepting the hour of lunch. This is called in the text *dose C*. A dose of 45 c.c. (actually 44.7 c.c.) was given to the regular group of moderate drinkers on a sufficient number of experimental days to obtain adequate measurements in Series I A, II A, and V. We refer to this dose in the text as *dose B*.

In order to relieve somewhat the disagreeable raw taste of the diluted alcohol, one-third of the total volume consisted of a solution of cereal "coffee."³ Fruit juices, which we tried, proved to be disagreeable to one of the first subjects and were consequently abandoned. The liquids were invariably drunk at room temperature, about 20° C. The total volume of dose A was 150 c.c.; that of dose B was 225 c.c. In all cases the alcohol and control mixtures were administered by mouth, the subjects being instructed to drink the mixtures as rapidly as convenient.

GENERAL ARRANGEMENT OF THE APPARATUS.

The research occupied a specially constructed laboratory of the Nutrition Laboratory, measuring about 5.5 by 3.5 meters, with a balcony about 4.5 by 3.5 meters. All the experimental records were made in this room. The incidental photographic work, such as loading the plate and paper holders, and developing the photographic records, was done in a small dark-room which was partitioned off in one corner of this laboratory.

Uniform lighting of the room during experimental sessions was insured by shutting out the variable daylight altogether, and by the use of incandescent electric lights. Ventilation was provided for by forced draught. An electric fan to provide free circulation of air in

¹Meyer and Gottlieb, *Experimentelle Pharmakologie*, Berlin, 1914.

²In the original preparation of the standard solution of pure grain alcohol to be used in this research, emphasis was laid upon the constancy of the amount in each dose rather than the absolute values. Owing to a misstatement on my part, Professor Dodge used the values 25 c.c. and 37.5 c.c. as representing the amount of absolute alcohol in the two doses employed in this research in giving preliminary reports of the work at the 1914 meeting of Experimental Psychologists at Columbia University, and at the Philadelphia meeting of the American Psychological Association in 1915. The true values should have been 30 c.c. and 45 c.c., respectively. The error is wholly mine. F. G. B.

³Prepared from roasted cereal and obviously free from caffeine.

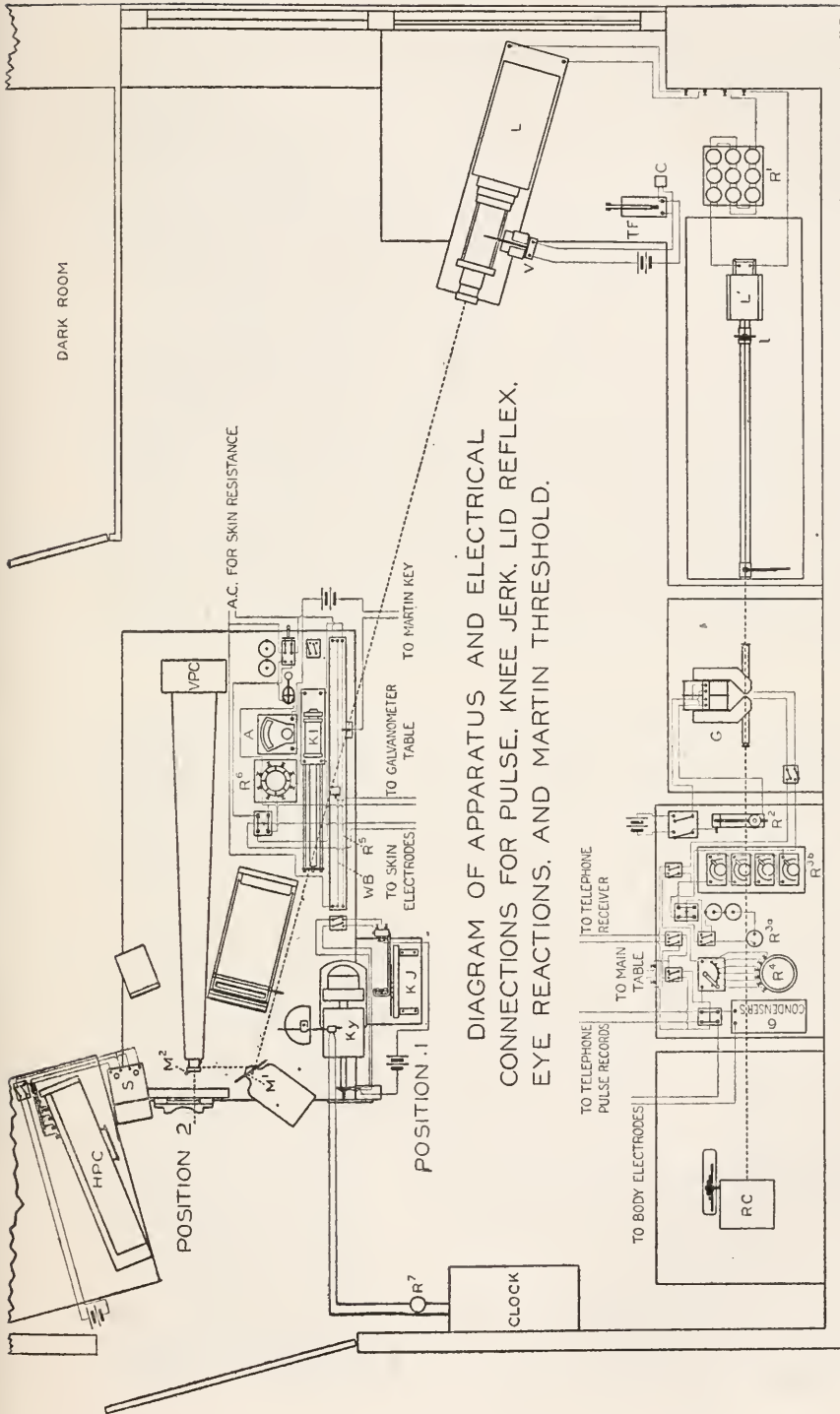

DIAGRAM OF APPARATUS AND ELECTRICAL CONNECTIONS FOR PULSE. KNEE JERK. LID REFLEX. EYE REACTIONS. AND MARTIN THRESHOLD.

FIG. 1.—General plan of psychological laboratory and apparatus.

A, ammeter in the inductorium circuit; AC, alternating current leads from small inductorium, not shown; C, condenser in the electric tuning-fork circuit; G, string galvanometer; HPC, horizontal photographic camera for recording the lid-reflex; KLI, inductorium; KJ, apparatus for eliciting the patellar reflex; Ky, Blix-Sandström kymograph; l, lens with iris diaphragm; L and L', arc lights for the photographic records; M¹ and M², mirrors for deflecting the recording light either to the eye for the eye-movement records or across the eyelashes for the lid-reflex records; R¹-7, resistances in the various circuits; RC, recording camera for the string galvanometer; S, sound stimulus apparatus for eliciting the lid-reflex; TF, tuning-fork of 50 d. v.; V, vibrator in series with the tuning-fork; VPC, vertical photographic camera for recording eye-movements; WR, Wheatstone bridge.

the room was commonly kept in motion during experiments, but naturally it was not allowed to blow directly on the subject.

A general plan of the room and apparatus is given in figure 1. A general photographic view is given in the frontispiece. The string galvanometer equipment for pulse-records occupied one side of the room (bottom of the plan). The galvanometer itself occupied the central table *G*. A hand-fed horizontal carbon arc light *L'*, burning at 5 amperes, supplied its illumination. A separate controlling table at the left of the galvanometer table provided the space for resistances, switches, etc. The recording camera *RC* occupied still another table, shown at the extreme left hand.

The main apparatus table, approximately in the middle of the floor, held the following apparatus: inductorium and resistance boxes for the Faradic threshold (Martin measurements); enlarging camera for photographing the eye-movements and eye-reactions; the word-exposure apparatus; and the Blix-Sandström kymograph, for patellar reflex and memory test. A separate table, shown at the upper left of the plan, held the camera for the lid-reflex records. The source of light for these various photographic records was the self-regulating arc light *L* at the right.

Figure 2 is from a photograph of the main apparatus table from the corner of the room which was normally occupied by the recording camera for the string galvanometer. It shows the Blix-Sandström kymograph in the foreground, with the patellar-reflex apparatus and word-exposure device at the right, and the voice-reaction key at the left. In the background is the camera for eye-movements, with its head-rest at the left. At the extreme upper left is shown the noise-stimulus key for the protective lid-reflex, and a part of the lid-reflex camera.

In figure 3 we have a view of the same table from the position of the self-regulating arc light, *i. e.*, from the extreme right end of figure 1. In the center foreground are the inductorium, mil-ammeter, and resistance boxes for the Faradic threshold. Beyond these the Blix-Sandström kymograph is seen in end-view. The patellar-reflex apparatus appears at the left. On the right appears the long enlarging camera for the eye-movements.

All measurements, except those of Series V, *i. e.*, except the association and Faradic threshold measurements, were made with the subject either at position I or position II, figure 1. In Series V the subject and Dr. Wells, the operator, occupied the balcony.

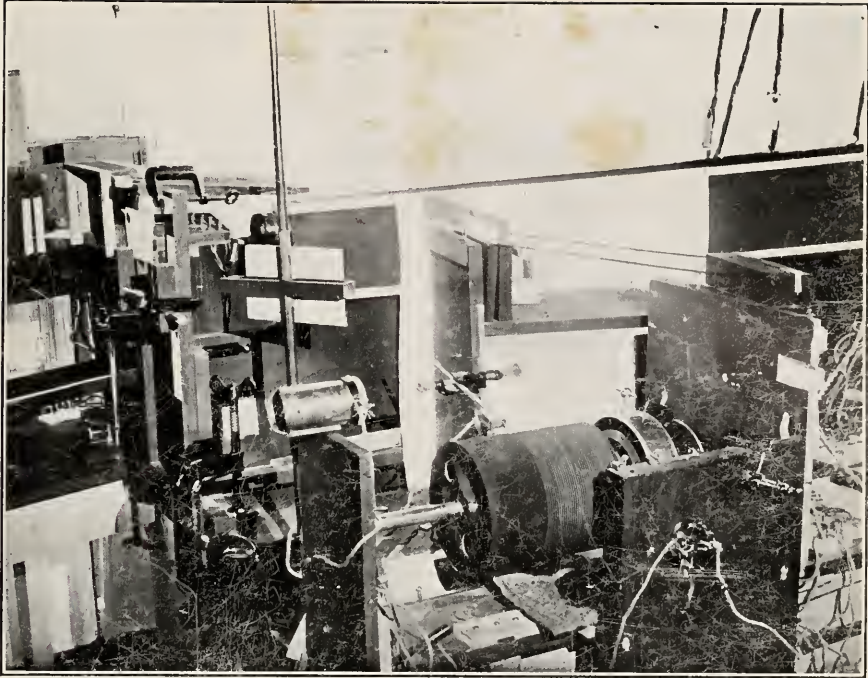

FIG. 2.—Main apparatus table in psychological laboratory (first view).

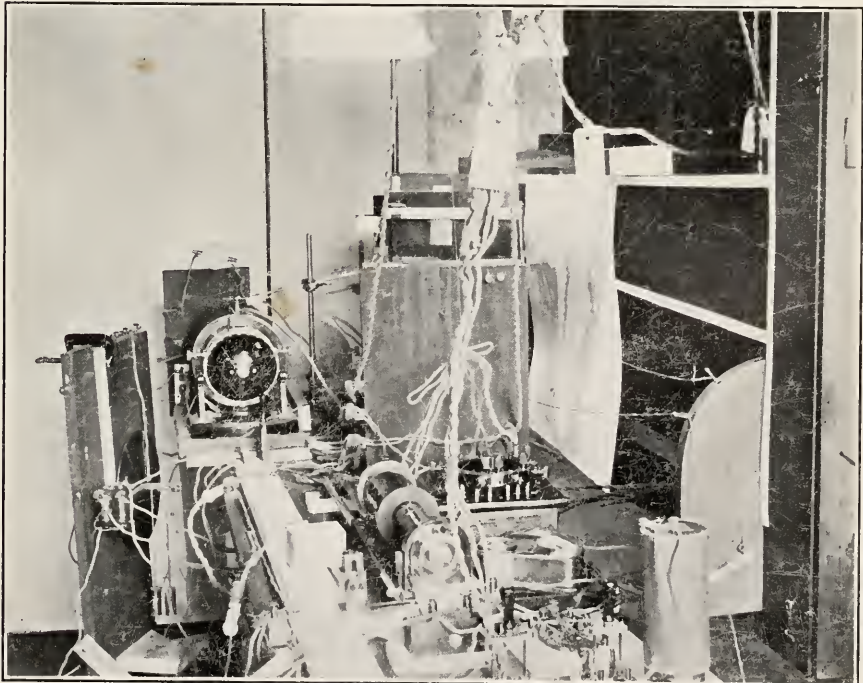

FIG. 3.—Main apparatus table in psychological laboratory (second view).



CHAPTER II.

EFFECT OF ALCOHOL ON THE SIMPLEST NEURAL ARCS.

Pursuant to the principles on which this investigation was organized, a study of the simplest reflex arcs under the influence of alcohol is held to be of basal importance. Since the simple reflexes are conspicuously free from direct voluntary control, as well as from the effects of practice, they should furnish unambiguous and conclusive evidence of the effect of alcohol on the particular group of tissues on which they depend. As the simplest complete neuro-muscular process, they should furnish a basis for the interpretation of the effects of alcohol on the more complex ones, and, in conjunction with the rest of the systematically related processes, they should furnish evidence of the relative incidence of the effects of alcohol on the various neural levels of the same individual.

In view of its theoretical importance, quantitative knowledge of the action of the simple human reflexes under alcohol is surprisingly scanty. Bunge¹ asserts that reflex excitability is decreased by alcohol, basing his assertion on a single apparently incomplete reference to J. C. Th. Scheffer.² Sternberg³ holds that alcohol operates at first to increase the reflexes. He gives no references.

The effect of alcohol on animal reflex is better known. In 1873, Meihuizen⁴ studied the effect of various drugs on the reflex excitability of the frog to induction shocks. In his three specimens, 1 c.c. of 10 per cent alcohol decreased reflex excitability. The effect began within 15 minutes and reached its maximum in from 45 to 90 minutes. Of the many more or less casual observations which are scattered in the physiological and pharmacological literature of animal experimentation, we have found it impracticable to take account. That doses of alcohol as large as 5 per cent of the circulation of the frog produce complete inexcitability of the cord appears in the work of Winterstein.⁵ The most complete systematic study of the effect of alcohol on the frog reflexes is that of Hyde, Spray, and Howat.⁶ They found that alcohol in doses stronger than 1 c.c. of 15 per cent solution per 10 gm. of weight depressed all the reflexes of the frog. The depression differed for the different reflexes and for different doses. The depression came in 10 minutes after the dose, and lasted 1 to 1½ hours. The relatively larger number of studies of the reaction of the invertebrate organisms to alcohol have no direct bearing on our present problem, since the anatomical and physiological conditions are so different.

¹Bunge, *Lehrbuch der Physiologie des Menschen*, Leipsic, 1903, p. 209.

²Scheffer, *Nederl. Weekbl.*, 1900, p. 217 (not accessible, reference apparently incomplete).

³Sternberg, *Die Sehnenreflexe*, Leipsic, 1893, p. 177.

⁴Meihuizen, *Archiv f. d. ges. Physiol.*, 1873, **7**, p. 201.

⁵Winterstein, *Zeitschr. f. allg. Physiol.*, 1902, **1**, p. 19.

⁶Hyde, Spray and Howat, *Am. Journ. Physiol.*, 1912-13, **31**, p. 309.

AVAILABLE HUMAN REFLEXES.

A considerable number of relatively simple neural arcs are available, even in human subjects, for more or less accurate quantitative study. Some of them have assumed considerable diagnostic importance without a corresponding development of satisfactory quantitative techniques. The swallowing reflex, the skin reflexes, the semicircular-canal reflexes, the pupil reflex, the corneal reflex, and many of the tendon reflexes are in regular clinical use. But their clinical investigation is generally satisfied by cataloguing the case under one of three or four general categories, such as absent, depressed, moderate, and exaggerated. Change of a case from one category to another represents a relatively profound disturbance. Accurate techniques for measuring small differences would perhaps be too time-consuming for clinical purposes. Their development for special experimental investigations has followed the development of definite experimental problems.

While none of the available reflexes may be ignored in a study like the present, certain of them have a better experimental status than others. Such, for example, are a few of the tendon reflexes, particularly the patellar reflex and the Achilles reflex, the pupil reflex, and the protective lid-reflex. Experimental techniques for the measurement of these reflexes have been developed so that they are dependable. This was our main reason in selecting the patellar reflex and the protective lid-reflex for immediate investigation. In choosing these two arcs we were also influenced by several other considerations. It seemed advisable: (1) to study the effect of alcohol on the nervous system at as widely different reflex levels as practicable; (2) to use reflex arcs of similar latency, and presumably similar complexity; and (3) to avoid fatigue and adaptation phenomena.

The patellar reflex appeared most suitable as a representative of the lowest spinal level. On a variety of grounds one would have preferred the Achilles reflex. For instance, it is less subject to accidental anatomical conditions than the patellar reflex. That is, length of tendon and the underlying cushions of connective tissue effect less extreme individual differences in the Achilles than in the patellar reflex. Opposed to this advantage are certain technical difficulties in recording the Achilles reflex from the thickening of isometric muscle, and the practical necessity for the subject to assume an unusual position with more or less variable antecedent muscular activity. The patellar reflex, on the other hand, can be recorded from a sitting or reclining subject without moving him from the position he would naturally adopt for other neuro-muscular measurements. Moreover, if the leg is prevented from moving, quadriceps thickening may be registered from practically isometric muscle by direct recording levers, resting on the anterior thigh.

Reflexes of the higher levels are perhaps best represented by those of the eye. In particular, the pupil reflex deserves and has received

relatively careful observation. It is, however, in no way analogous to the knee-jerk. It is relatively slow, and is controlled through the autonomic system. Furthermore, a series of measurements may give rise to long-continued and painful ocular disturbances, as is known to one of us from unpleasant personal experience. Finally, the best available registering technique for the pupil reflex is by cinematograph, an arrangement that gives too few records per second for accurate measurements of latency. For these reasons, and on account of the necessity of limiting the selection, the pupil reflex was omitted from the present study.

The protective lid-reflex, on the contrary, seemed to offer a perfect analogy to the knee-jerk. It has a latency of the same order as the knee-jerk, and normally changes very slowly from adaptation. Furthermore, entirely adequate and relatively simple technique is available, by which uniform stimuli (sound) can be recorded by the same optical system that records a movement of the shadow of the eyelashes. The resulting photographic records are unusually free from instrumental latency and distortion.

EFFECT OF ALCOHOL ON THE PATELLAR REFLEX.

The present investigation of the effect of alcohol on the knee-jerk is based on the assumption that the reflex character of the human knee-jerk has been established. The classical controversy as to the nature of the phenomenon was started by Westphal's¹ contention that there was no evidence for receptors in the muscle. After Westphal's evidence was weakened by the discovery of proprio-muscular receptors, Waller² and Gotch³ were led to believe that the knee-jerk was not a reflex because of the exceedingly low latent time that was required under favorable conditions by the knee-jerk of the rabbit.

The psychiatrists, on the other hand, have long assumed the reflex character of the human knee-jerk. The clinical value of the knee-jerk test is so firmly fixed by the mass of clinical experience that psychiatry may be comparatively indifferent to the question as to its nature. Its diagnostic significance rests secure on empirical correlations. Its physiological exploitation, however, was practically impossible as long as the uncertainty remained. But if the knee-jerk is a true reflex, it must be of value not only in diagnosis of nervous disease, but also for a large number of studies of the normal physiology of the human reflex arc, such as the rate of propagation of nervous excitation in human nerves and in the cord, for studies of fatigue, inhibition, and "Bahnung," as well as for the effects of drugs on man.

A number of recent studies have shown conclusively that whatever may be true of the rabbit, the normal human knee-jerk as ordinarily

¹Westphal, *Archiv f. Psychiatrie*, 1875, **5**, p. 803.

²Waller, *Journ. Physiol.*, 1890, **11**, p. 384.

³Gotch, *Journ. Physiol.*, 1896, **20**, p. 322.

elicited is a true reflex. The evidence may be summarized as follows: (1) Records of currents of action with the string galvanometer by Dodge and Bull,¹ Hoffman,² Jolly,³ Snyder,⁴ and others, show that their latency is too long for purely peripheral phenomena. On the basis of recent measurements of the speed of nervous currents (Piper⁵), and the latency of the cord (Miss Buchanan⁶), these studies show that the latent time of the knee-jerk is that of a true cord reflex, with the simplest possible central organization. (2) In addition, it appears from the character of the current of action that the impulse is not a simple muscle-twitch, but a more or less complex contraction wave which travels through the muscle from the point of entrance of the motor nerve. Similar evidence was obtained by Dodge¹ from direct muscle tracings. Photographic records of the quadriceps contraction, which were taken simultaneously from five different points of the muscle, showed a gradual peripheral progression of the muscle contraction. (3) Further evidence is that with accurate recording devices the latent time of the human knee-jerk is related to that of the Achilles-jerk directly as the distance of the respective receptor-reactors from the cord. These differences in latent time are best explained by the increased length of nerve-conduction. (4) It was also found that the latent time of the knee-jerk was practically identical with that of an undoubted reflex, the protective lid-reflex. (5) Finally, in the normal human knee-jerk, the quadriceps contraction was found to be coördinated with the contraction of the flexors of the leg. Such muscle coördination can be explained only by the action of nervous centers. We have consequently regarded it as proved that the knee-jerk is a reflex.

TECHNIQUE.

Extended preliminary study of the normal knee-jerk technique, undertaken by Dodge¹ in connection with a different, though related, problem, showed that the only satisfactory records of reflex latency are those made from muscle thickening. For the details of that study we must refer to the original paper, where it was shown that the form of the curve and the apparent latency of the reflex are enormously influenced by the nature of the recording device. The latency as recorded by the movements of the leg averaged 65σ , with a mean variation of 11σ . Slight prestimulation activity of the flexors, to produce a backward pressure of the leg against a fixed support, reduced the latent time to an average of 52σ , with a mean variation of from 2.7σ to 4.7σ . Records from thickening of the quadriceps muscle by a system of light

¹Dodge, *Zeitschr. f. allg. Physiol.*, 1910, **12**, p. 1.

²Hoffman, *Med. Klinik*, 1910, **6**, p. 1002.

³Jolly, *Quart. Journ. exp. Physiol.*, 1911, **4**, p. 67; *British Med. Journ.*, 1910, **2**, p. 1259.

⁴Snyder, *Am. Journ. Physiol.*, 1910, **26**, p. 474.

⁵Piper, *Archiv f. d. ges. Physiol.*, 1908, **124**, p. 591.

⁶Buchanan, *Proc. Roy. Soc.*, 1907, **B 79**, p. 503.

levers reduced the latent time to 37σ , with a mean variation within the series of 1σ , or less. Similar differences between the latent time as measured respectively by the movements of the leg and by thickening of the quadriceps muscle are reported by Weyler.¹ Partial explanation of these differences is found in the weight of the leg. A certain degree of contraction of the muscle-fibers seems to be necessary before the heavy leg-lever can be set in motion. An entirely new factor in the case was shown by Dodge to be the initial forward motion of the leg immediately after the stimulus blow. This is a purely mechanical effect, and is due to the virtual shortening of the tendon of the extensor, which is produced through its deformation by the stimulus blow. The consequent pendular movement of the leg prevents its showing the exact moment of reaction. This disturbance is more serious than might at first appear. Since the deformation of the tendon increases with the weight of the pendulum hammer, the initial movement of the leg, which has no direct connection with the reflex action, must increase with the weight of the hammer. This may have led to the anomalous data reported by Lombard,² who found that, as measured by the leg-movement, the latent time was increased by increasing the weight of the hammer. A further advantage of the muscle-thickening records is that they show the true course of the muscle contraction and disclose any preliminary stiffening of the leg to receive the blow, as well as any arbitrary or voluntary interference with the course of contraction. Finally, quadriceps thickening is uninfluenced by the chance interplay of flexor antagonism.

STIMULUS.

In all quantitative studies of the knee-jerk, the usual stimulus has been a sudden blow on the patellar tendon. While this is not the only means of eliciting the knee-jerk, and is not always the best for clinical purposes, for experimental work it is doubtless the most convenient and exact. It should not be forgotten, however, that the receptors in the knee-jerk are intra-muscular, and that their stimulation is a sudden muscle deformation. Consequently, only a perfectly regulated blow on the tendon, with a muscle at uniform tension, is satisfactory for comparative purposes. This demands a uniform percussion hammer, striking at a uniform place, with the limb in a uniform position.

The preliminary study favored the electrically released double, pendulum-percussion hammer which is shown in figure 4. A pendulum is ideally uniform in action under similar circumstances, and the energy of the blow can be easily and simply expressed in c. g. s. units. Its velocity and mass are independently variable. Both factors are directly measurable on the apparatus and may be experimentally changed, easily and with precision. To provide for changes of mass,

¹Weyler, *Zeitschr. f. d. ges. Neur. u. Psychiat.*, 1910, **1**, p. 116.

²Lombard, *Journ. Physiol.*, 1889, **10**, p. 139.

our pendulum bobs were hollow cylinders (C' , C'' , fig. 4), into which closely fitting lead weights, which were accurately adjusted to the desired totals, could be inserted and clamped. In our experiments, the total masses of the bobs were respectively 30, 50, 75, and 100 grams.

Magnetic release for the pendulum-percussion hammers provided for accurate timing of the stimuli by means of a circuit-breaker attached to the shaft of the kymograph. The magnets which held the hammers (M' , M'' , fig. 4) were attached to a heavy brass arm A . This arm moved on an axis which was coincident with the axis of the pendulums and could be clamped at any desired position on a divided arc C . This provided for considerable latitude of experimental variation in the height of fall and the correlated velocity of the hammer at the moment of stimulation. Except in a few specified cases, our hammers fell from a horizontal to a vertical position, making h in the energy equation equal to the length of the pendulum from its axis to the center of gravity of the bob (20 cm. in our pendulums). Thus, the energy of the pendulum at the moment of stimulation varied directly with the mass and was respectively

$$\begin{array}{ll} 20 \times 30 \text{ c.g.} & 20 \times 75 \text{ c.g.} \\ 20 \times 50 \text{ c.g.} & 20 \times 100 \text{ c.g.} \end{array}$$

Dodge¹ suggested as an indicator of the fatigability of a reflex, as far as that can be shown in its relative refractory phase, that it would be desirable to give two similar stimuli separated by a definite interval of time within the relative refractory period. For that purpose our pendulum was made double, with similar bobs, and two separate release magnets. The weight of the two bobs was determined directly. The actual lengths of the two pendulums were controlled by comparing their periods of oscillation.

To secure uniformity of application of the two successive stimuli was more difficult. A light wooden rod (B' , fig. 4), about 60 cm. long,

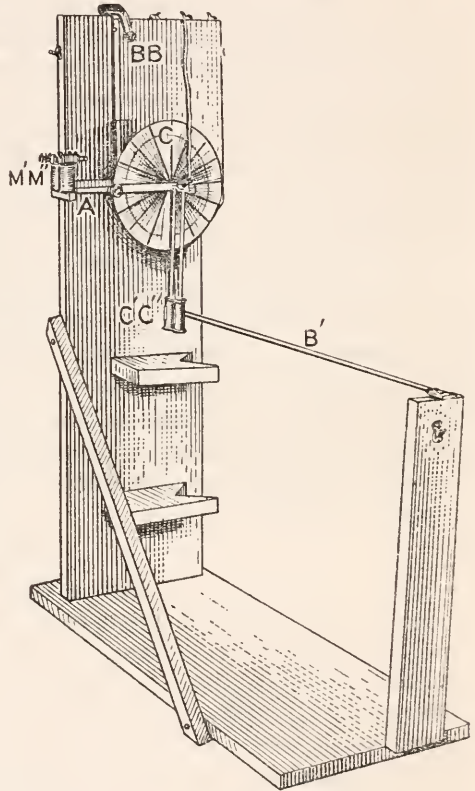

FIG. 4.—Apparatus for stimulating the patellar reflex.

¹Dodge, *Am. Journ. Psych.*, 1913, 24, p. 1.

was mounted at one end on a vertical axis, so that it could move freely in a horizontal plane at about the height of the subject's patellar tendon. The free end of this rod was attached by a flexible cord to a point concentric with the axis of the pendulums, and was adjusted to such a height that both pendulums struck it at their center of gravity when they reached a vertical position. The height of the whole system could be changed for each subject, without changing any of the instrumental constants, by raising or lowering the sliding base *BB*, so that the rod *B'* rested against the middle of that particular subject's patellar tendon. Once adjusted, the base was securely clamped against the vertical frame, and the rod *B'* was given an even tension against the tendon by the pressure of an elastic band which was stretched between the rod and a fixed point on the upright support. When once fixed for any subject, this system remained unchanged throughout an afternoon's experiments. It could be afterwards reset for the same subject by the use of a scale which was attached to the side of the frame. But for obvious reasons the scale alone was never depended upon. On each day the position of the system was carefully verified for each subject.

The blows of the pendulums were thus transmitted to the subject through a light horizontal lever which was adjusted as above indicated. This secured identity of the point of application of the two blows. Since a lever neither increases nor decreases energy, the effect on the tendon must be practically identical for both pendulum hammers, even though one pendulum strikes the horizontal transmitting-rod somewhat nearer its axis than the other. This simple theoretical relationship is somewhat complicated by the fact that in practice the lever will have a certain amount of weight and elasticity. To reduce the error of transmission to a minimum, our transmitting rod is as long as it can conveniently be (60 cm.), while the two percussion hammer pendulums strike it as near together as practicable (25 mm. apart). The consequent discrepancy in the energy of the successive blows is a small fraction of 1 per cent, and is negligible in practice. In comparative measurements this discrepancy can play no rôle at all, since it is an instrumental constant.

Two checks on the constancy of the stimulus blows are included in our records. (1) If the blows of the pendulums are exactly equal, the extent of the mechanical disturbance to the muscle incident to stimulation should be equal after each blow. To be sure, this can not be a very fine measure of the relative energy of the pendulums, but it served to disclose any accidental differences in the weights. (2) We took what is probably excessive precaution in arbitrarily omitting the first blow at least once in every series of experiments, to see if the blow from the second pendulum produced an appropriate reaction. There were no measurable discrepancies.

RECORDING DEVICE.

On grounds which are already indicated, we believe that adequate records of the human knee-jerk must be either direct records of quadriceps thickening or galvanometric records of the muscle-current of action. While the latter are probably preferable to the former, and should be used for the final analysis of the phenomenon, they are much more expensive of time and material, and are practically more difficult to manage. In the present investigation the records were produced by direct recording levers which wrote on a Blix-Sandström kymograph the reflex thickening of isometric quadriceps muscle.

The adaptation of our recording levers to the different subjects proved an unexpected source of difficulty. It was proved in the case of Dodge that neither the size of the lever terminal which rested on the muscle nor the pressure which it exerted on the muscle at the point of contact, had any considerable influence on the latency of the reflex. In various subjects, however, a new and somewhat serious source of error was discovered. The blow of the hammer upon the tendon always sets up within the muscle a mechanical wave-like disturbance. We depend on this wave to record the moment of stimulation. Under certain combinations of stimulus intensity and tonic contraction of the muscle, which are otherwise undefinable, this mechanical disturbance consisted of a succession of damped oscillations, which occasionally seriously complicated the curve and rendered the true beginning of reaction uncertain. Two devices seemed to lessen these vibrations: (1) The area of contact between the lever system and the muscle should be relatively large. In all except the earliest experiments we used a rectangular base, 13 mm. by 70 mm., placed lengthwise of the muscle. (2) The elastic pressure of the lever system against the muscle should be relatively intense as well as quick acting. An elastic band was used for this purpose which exerted a pressure of about 500 gm. Though this varied somewhat from individual to individual because of the variations in diameter of the respective thighs, it remained practically constant for each individual throughout the series. Our lever system magnified the muscle thickening by the proportion of 6 to 1. This proportion was found by preliminary experiment to be the most favorable with our particular lever arrangements.

For recording the knee-jerk we used the Blix-Sandström¹ kymograph, which was run at a peripheral rate of 100 mm. per second. While this form of kymograph is one of the most accurate and convenient available, it may not be used without constant watchfulness and occasional readjustments of the regulator. Even the most careful regulation at the beginning of an experimental session proved to be inadequate. Except in the earliest experiments, we consequently used a control time-record throughout. Unfortunately for psychological

¹Blix, *Archiv f. d. ges. Physiol.*, 1902, 90, p. 405.

investigations, the Blix-Sandström kymograph has one rather serious defect. It is never noiseless. In our measurements of the knee-jerk the noise itself was probably negligible, but the correlated vibration tended to transmit itself through the table to the axis of the recording levers. When this occurred an irregular base-line was produced, which more or less obscured the moment of muscle contraction. These vibrations of the lever axis may be largely eliminated by suitable independent supports. Before the cure was found, however, these vibrations ruined a number of early knee-jerk records.

A final difficulty which appeared as the experiments progressed was the fact that the knee-jerk of a few subjects was highly refractory. In all our subjects a knee-jerk was elicitable, but in some only by reinforcements, by extra heavy hammers, or by considerably increased velocity of the hammers. Under these exceptional circumstances, the knee-jerk measurements were omitted, since intense stimulation tended to produce not merely mechanical disturbances of the muscle, but also unpleasant mental correlates, and an involuntary tendency to stiffen the leg-muscles for the blows. Any one of these factors would operate to make interpretation of the records questionable.

EXPERIMENTAL PROCEDURE.

The subject was seated comfortably in a slightly reclining chair at the edge of the main apparatus table (position I, fig. 1). The experimenter moved the chair so that the subject's left leg fitted comfortably into the double V supports (fig. 4); and the whole was oriented with respect to the apparatus table so that the middle point of the quadriceps of the left leg was directly beneath the recording lever. Before the first records of a day were taken, the height of the pendulum-hammer system was controlled and accurately adjusted, so that the blow was delivered on the middle of the patellar tendon.

The recording-lever was then adjusted to its proper position. The muscle end of the lever was placed in position and secured by an elastic band which was passed around the thigh and fastened at proper tension. The recording end of the lever was adjusted so that it was perpendicular to the axis of the drum and tangential to its surface.

The kymograph was set in motion and allowed four revolutions to gain regular speed. (Measurements showed that our instrument gains regular speed in three revolutions, when run at the rate of 100 mm. per second.) The time-marker was set in operation. The subject was instructed to relax completely, but to say "Ha" each time the knee was struck. This was done in an effort to control both the attention and the respiration. At each revolution of the kymograph, offsets from the shaft broke the circuit of the electromagnets which controlled the hammers, at a definite point of each revolution. This regulated the interval between the stimuli and determined the position of the records on the smoked paper. To insure regularity of the first stimulation,

the contact-breaker was tested by one free revolution of the drum, but without letting the hammers fall. When all these details were in order, the operator touched the key to the mechanism which gave the rotating smoked drum a gradual lateral displacement, so that the succession of knee-jerk records appeared as one continuous line whose base was a spiral. After each stimulus the operator caught the hammer on its rebound from the knee and raised it to the magnet. If more than one stimulus weight was used, the record regularly began with the lighter. The pendulum bobs were then progressively increased in weight until a vigorous reflex was produced. For all except the earliest records, two or more stimulus weights were regularly used in each period. Unless this had been done, it would frequently have occurred that the reflexes at some period of the experimental session would have had no comparable "normal of the day." For example, it frequently, almost regularly, happened during an experimental session that, after an hour or two of relative quiet, the knee-jerk was notably decreased in extent. Occasionally a stimulus that at first produced a good reflex later produced no reflex at all. If that stimulus alone had been used, either the later experiments would be meaningless, or the stimulus must be changed at some time during the session, with consequent incomparability of earlier and later results.

In the record shown in figure 5, reading the upper line from left to right, the mechanical shock to the muscle, which is produced when the pendulum hammer strikes the tendon, is recorded by the first slight drop in the base-line. In reading the records for the latent time of the reflex, this point is taken as the moment of stimulation. Owing to the delay which is occasioned by the progression of this mechanical wave along the partially elastic muscle-tissue, this curve does not represent the exact moment when the pendulum strikes the tendon. As measured by Dodge¹ in his own case, there is a delay between the two events of about 3σ . While it does not represent the moment when the tendon was struck, this first dip of the line does represent with greatest precision the much more significant moment when the particular part of the muscle suffered deformation as a result of the blow. And since the real stimulus of the muscle receptors is due to the sudden muscle deformation, as we have mentioned before, this indicator of muscle deformation shows the moment of actual stimulation of the corresponding receptors more accurately than as though we recorded the moment of contact between hammer and tendon.

The moment of reaction is indicated by the main drop in the line. Here again we are not recording the beginning of change in the muscle as a whole, but rather the reflex thickening of the muscle at exactly the point where we have previously recorded its stimulation. Records from several places along the axis of the muscle show a measurable

¹Dodge, *Zeitschr. f. allg. Physiol.*, 1910, **12**, p. 1.

progression of the thickening wave. With our recording device, however, that progression is entirely irrelevant, since we measure from the moment of stimulation of any part of the muscle to the moment of the reflex thickening of that particular part. Since both events are recorded by the same writing lever, the record as it stands is an exceedingly accurate measurement of the latency of the particular arc which is involved in the reflex action of that part of the muscle. The vertical displacement of the recording line indicates the amount of the reflex

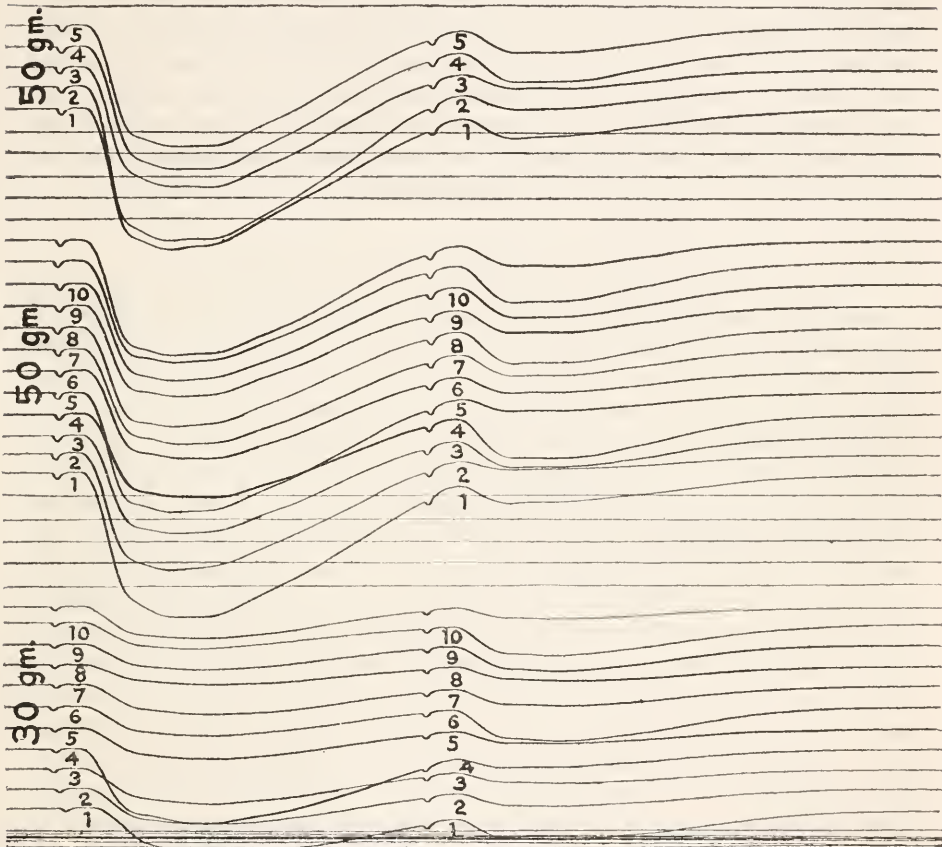

FIG. 5.—A typical record of the patellar reflex.

muscle thickening, multiplied by the leverage of the recording-arm. We believe that these reflex measurements are particularly well adapted to indicate the relative changes induced in latency and amount of this reflex arc by the use of drugs.

Each line represents the reflex response to a double stimulation of the same intensity. The interval between the lines is one complete revolution of the drum. Since this was regulated to occur in 5 seconds, the series of records follow in pairs at intervals of 5 seconds. Differ-

ences between the first and second reflex in each pair of records indicate the relative amount of refractoriness of the patellar reflex of the subject at that particular time after that particular interval.

The task of reading the records is rather exacting, though relatively simple. At the rate for which the kymograph was regulated, each running millimeter of the record is equivalent to 10σ ($0.01''$). The records were read with a lens through a glass plate which was divided into millimeter cross-sections. The glass coördinate system was so placed on the record that its horizontal ordinates were parallel with the base-lines of the records. It was then carefully moved so that a main ordinate cut the record line at the first indication of reflex muscle thickening. The length of the abscissa from the ordinate which was placed on the beginning of the reflex thickening to the beginning of the stimulation curve can be read on the millimeter scale directly to 10σ ($0.01''$) and estimated with reasonable accuracy to 1σ ($0.001''$).

RESULTS.

VARIABILITY OF THE PATELLAR REFLEX.

In all the studies of the patellar reflex its variability has been one of the most conspicuous features of the records. Normal individuals differ widely in their susceptibility to the ordinary stimuli. Since the patellar reflex is not essential to any known vital process, these individual differences are not surprising. In addition to the variation between individuals, the patellar reflex is subject to more or less gross variation in the same individual at different times. Even with string-galvanometer technique, Jolly¹ found the latent time to vary in one individual so that the highest value was more than double the lowest (11.7σ and 24.4σ respectively). When, as in Jolly's measurements, the currents of action are used as indicators, this variation must be almost entirely central. It is proportionately more prominent as one decreases the relative importance of the peripheral factors. For the purposes of a science that seeks an invariant, these central variations seem unfortunate. On the contrary, no fact may properly be regarded as unfortunate in science. The variability of the knee-jerk emphasizes, in the case of the simplest possible neural arc, the contention which appeared in our introduction, that biological invariants do not exist except as statistical artifacts.

Simple reflex in an intact vertebrate is after all a relative term. There is no reflex arc so simple as to consist of an isolated chain of neurons from receptors to muscle-fiber. There is no reflex so simple that we can conceive of it as a transmission of energy from receptor to reactor through a more or less resistant conductor. At no step, except, perhaps, in conduction through the axones, does the process follow a physical model. In no living organism can we ever assume that an

¹Jolly, *Quart. Journ. exp. Physiol.*, 1911, 4, p 67; *British Med. Journ.*, 1910, 2, p. 1259.

absolutely inactive tissue is aroused to action by our stimulus. Rather, we must think of the living central nervous system as in a continuous state of excitation. In the waking state, at least, it probably originates a continuous succession of centrifugal excitations, so that each "final common path" has converging upon it every moment a complex of stimulating and inhibiting impulses whose algebraic sum at any moment of time conditions the state of the "final common path" at that particular moment. A stimulus to reflex action is not a form of energy to be transmitted to muscle. It does not develop activity in an otherwise inert system. It merely modifies the balance of existing tendencies. On these grounds the reflexes may not be expected to be uniform.

The extreme susceptibility of the patellar reflex to peripheral reinforcement was shown by Jendr ssik¹ in the familiar *Kunstgriff*; by Weir Mitchell and Lewis² in simultaneous stimulation of the skin; by Schreiber³ in friction of the skin; by Beevor⁴ in cold-water douches; by Bowditch and Warren⁵ through various methods; and by Sternberg⁶ in the simple handclap. Similarly, central conditions of reinforcement and inhibition are in constant interplay. It is surprising how often in the literature of the patellar reflex one finds without a sequel the "preliminary announcement" of some remarkable correlation between the knee-jerk changes and various mental processes, like attention. The verification of these supposed correlations seldom appears. Only in spinal preparation are successive reflexes relatively uniform. Of the various conditions that produce this lack of uniformity only a few are definitely localizable like the specific action of curare, strychnine, and carbolic acid. In general we know that reflex excitability is modified by the degree of activity of the higher centers. Antagonistic and facilitating influences may also arise at or about the same spinal level as the reflex itself. Variations in pulse-rate and blood-pressure, and various phases of respiratory rhythm, also seem to modify the reflexes.

With a full realization of all these sources of variation, our first direct and immediate problem is to discover whether the irritability of this human reflex arc is increased or decreased by moderate doses of alcohol. Assuming that all these sources of variation and many others may be present in our records in greater or less degree, it was a technical problem to equalize the conditions as far as practicable. The problem of interpreting the results is first of all statistical. It is obvious that the need of statistical treatment to eliminate as far as possible accidental variations not otherwise shut out by our technique is just as great in the simple as in the more complex processes.

¹Jendr ssik, *Neurolog. Centralbl.*, 1885, **4**, p. 412.

²Mitchell and Lewis, *Med. News*, 1886, Feb. 13, p. 48.

³Schreiber, *Deutsch. Archiv f. klin. Med.*, 1884, **35**, p. 254.

⁴Beevor, *Brain*, 1883, **5**, p. 56.

⁵Bowditch and Warren, *Journ. Physiol.*, 1890, **11**, p. 25.

⁶Sternberg, *Die Sehnenreflexe*, Leipzig, 1893, p. 177.

NORMAL VARIATIONS IN THE CASE OF SUBJECT II.

An instance where the difficulties of an adequate interpretation of the data appear in extreme form is the case of Subject II. Table 1 gives the data for 2 days' knee-jerk experiments on Subject II.

TABLE 1.—*Patellar reflex. Subject II.*

[R' and R'' are given in thousandths of a second.]

Normal. ¹					Alcohol (dose A).				
Date and time.	R'	H'	R''	H''	Date and time.	R'	H'	R''	H''
<i>Oct. 8, 1913.</i>					<i>Sept. 23, 1913.</i>				
50 gm. hammer:					30 gm. hammer:				
7 ^h 45 ^m p. m.	51	2.4	50	2.2	8 ^h 18 ^m p. m. ²	35	21.4	42	7
8 05 p. m.	51	2.0	50	1.6	Alcohol given.				
8 45 p. m.	51	2.4	48	3.0	8 ^h 40 ^m p. m.	36	9.0	42	5.6
9 10 p. m.	46	5.0	43	6.0	8 50 p. m.	37	8.0	44	2.0
9 50 p. m.	50	5.2	51	2.8	9 03 p. m.	3.0	...	0.0	...
					50 gm. hammer:				
					9 ^h 05 ^m p. m.	40	13.7	41	4.0
					9 20 p. m.	43	10.3	48	5.3
					9 34 p. m.	42	5.0	...	0.0
					9 50 p. m.	3.0	...	0.0	...
					10 02 p. m.	44	7.0	48	3.4
					10 12 p. m.	47	7.0	48	6.1
					10 20 p. m.	46	7.2	47	5.8
					10 30 p. m.	44	8.3	46	4.4

¹Subject had been "all day at the microscope."

²Normal period preceding the taking of alcohol. In this and all subsequent tables, the data for the first period of the alcohol experiments will be printed in *italics* to indicate that they were obtained before the alcohol was given.

On September 23, 30 c.c. of absolute alcohol were given in a total volume of 150 c.c. directly after 8^h 20^m p.m. October 8 was a normal day without alcohol. The time of day at which the series were given is shown in the first column. Columns R' and R'' give the latency of the first and second responses, respectively, in thousandths of a second. Columns H' and H'' show the amount of muscle thickening in millimeters as recorded by a marker with a magnifying leverage of 6:1.

The most conspicuous fact is that the two days, September 23 and October 8, started at widely different levels of reflex excitability. In the first period on September 23, a 30 gm. hammer falling 20 cm. produced an average muscle-thickening of $\frac{21.4}{6}$ mm. This was about four-tenths of the maximum voluntary isometric contraction of Subject II. In the first period, on October 8, a 50 gm. hammer falling through the same distance produced a contraction thickening of only one-ninth of the previous amount. The latency in the two cases was 35 σ and 51 σ respectively. The regularity of the succeeding periods shows that these values are not accidents. The notes on the two days show only

one apparently relevant difference. On October 8, Subject II remarked that he had "spent all day at the microscope and was tired."

A second obvious difference in the two days is shown in the course of succeeding periods. On the normal day, succeeding periods after the "normal of the day" show a tendency toward increase in the height of contraction and a reduction of its latency. On the alcohol day, on the contrary, succeeding periods after the "normal of the day" show a gradual increase of latency and a rapid fall in the height of contraction. This change begins within 20 minutes after the ingestion of alcohol and lasts about 90 minutes. At 9^h 3^m, the effect of the 30 gm. hammer had almost disappeared. The substitution of a 50 gm. hammer showed a continual fall of height up to about 90 minutes after the ingestion of alcohol and a slight subsequent recovery. If the data of September 23 stood alone, one could interpret them only as an evidence of the depressing effect of alcohol on the knee-jerk. Taken in connection with the normal record of October 8, the question arises whether the changes on September 23 are not really due to an accidental initial extreme excitability and whether the opposite tendency on the normal day is not due to an initial abnormal subexcitability. Subsequent records imply that both of these hypotheses are partially true.

It is obvious that the least valid measure of the effect of alcohol on the patellar reflex of Subject II would be the difference in the average values of the two days. That would be significant only if they started at the same level. The most significant data are given by the course of the process in succeeding periods after the respective normals of the day, with alcohol and without. If the average of all our cases shows a predominant change in the relation of subsequent measurements to the normals of the day on alcohol days, the direction of that change must be taken as the direction of the probable effect of alcohol. But only if related processes show similar tendencies can we regard this evidence as conclusive.

All our knee-jerk data are exhibited on this plan in table 2. Each value entered under the appropriate column shows the algebraic difference between the measurements of the first period, or "normal of the day" and each of the succeeding periods of the day. For example, +5 entered opposite 1-4, under Subject II, October 8, R', shows that on that date the latency of the knee-jerk was 0.005" less in the fourth series than in the first of the same day.

In the measurements of the patellar reflex, it proved impracticable to follow the usual plan of securing complete sets of comparable data after both doses of alcohol. The extent of the muscle contraction was reduced enormously even by the 30 c.c. dose. In many cases the curves were so low that the latency could not be satisfactorily measured when the action of the alcohol was at its maximum. In most cases

the same stimulus that produced a good reflex on a normal day produced no reflex at all after the larger dose of alcohol (45 c.c.). To have increased the weight of the stimulus hammer in such cases until a reflex was produced would have resulted in serious complication of the data, and would not have added to our comparable facts. To have foreseen the results was of course impossible. But even if the results had been foreseen, there are grave objections to using excessive stimuli on normal days. These objections may be summarized as follows: (1) excessive blows and excessive contraction of the big quadriceps muscle tend to produce prestimulation and preparatory stiffening of the whole body, with consequent inhibition of the reflex; (2) excessive isometric contraction stretches the muscle mechanically at each contraction and notably changes the muscle tonus; (3) if the leg is held so that it can not move, it is hurt at the point of contact with the supports by excessive contraction of the muscle; (4) excessive contraction of the quadriceps moves the body of the subject more or less out of alignment with the apparatus. In the few cases where reliable data were obtained after the larger dose of alcohol, the results are entered in the table with appropriate designation.

Table 2 shows the results of the patellar reflex measurements for each subject, in D values (D equals the deviation of the measurements of the subsequent periods from the first period, or "normal of the day"). The table is so arranged that all the data for each subject are grouped together. Normal days are given on the left and alcohol days on the right. Under R' and R'' are entered data from the latent time of the reflex after the first and second stimulation respectively. Similarly, under H' and H'' are entered the data referring to the extent of contraction in millimeters of muscle thickening multiplied by the leverage of the recording-lever, in the first and second reflexes respectively.

TABLE 4.—Protective *hid-reflex* measurements—Continued.

	Date and number of period.		Subject and kind of experiment.	
H''	Average	Difference	Normal.	Subject III.
	age of (1-2, age of 1-3, etc.).	age of (1-2, age of 1-3, etc.).	Jan. 19, 1914:	Jan. 19, 1914:
	1.7	1.7	33	33
	+ 0.5	+ 1.2	+ 1	+ 1
	+ 1.0	+ 0.0	- 2	- 2
	+ 1.3	+ 1.7	- 5	- 5
	0.4	0.7	34.4	34.4
	Mean variation.	Mean variation.	1.9	1.9
	Jan 26, 1914:	Jan 26, 1914:	150.7	150.7
	1	1	37.7	37.7
	2	2	9.2	9.2
	3	3	- 7	- 7
	4	4	1.6	1.6
	5	5	+ 13.4	+ 13.4
	6	6	+ 14.0	+ 14.0
	7	7	4.0	4.0
	8	8	+ 12.0	+ 12.0
	9	9	3.0	3.0
	10	10	39.5	39.5
	Mean variation.	Mean variation.	5.2	5.2
	Alcohol (dose B)	Alcohol (dose B)	Feb. 9, 1914:	Feb. 9, 1914:
	1	1	129	129
	2	2	- 10	- 10
	3	3	+ 10.5	+ 10.5
	4	4	2.4	2.4
	5	5	+ 9.6	+ 9.6
	6	6	39	39
	7	7	- 7	- 7
	8	8	39	39
	9	9	1	1
	10	10	132	132
	Mean variation.	Mean variation.	13.5	13.5
	Normal.	Normal.	Mar. 9, 1914:	Mar. 9, 1914:
	1	1	35	35
	2	2	41	41
	3	3	+ 1	+ 1
	4	4	34	34
	5	5	- 6	- 6
	6	6	37	37
	7	7	- 2.5	- 2.5
	8	8	13.6	13.6
	9	9	40	40
	10	10	2	2
	Mean variation.	Mean variation.	3	3
	Normal.	Normal.	Jan. 30, 1914:	Jan. 30, 1914:
	1	1	44.7	44.7
	2	2	+ 5.2	+ 5.2
	3	3	3.4	3.4
	4	4	49	49
	5	5	+ 0.6	+ 0.6
	6	6	48	48
	7	7	+ 1	+ 1
	8	8	49	49
	9	9	46.6	46.6
	10	10	3.3	3.3
	Mean variation.	Mean variation.	3.3	3.3
	Alcohol (dose B)	Alcohol (dose B)	Feb. 13, 1914:	Feb. 13, 1914:
	1	1	170	170
	2	2	+ 4	+ 4
	3	3	36	36
	4	4	2.4	2.4
	5	5	46	46
	6	6	0.9	0.9
	7	7	+ 5	+ 5
	8	8	39	39
	9	9	1.3	1.3
	10	10	43	43
	Mean variation.	Mean variation.	5	5
	Normal.	Normal.	Mar. 19, 1914:	Mar. 19, 1914:
	1	1	51	51
	2	2	- 2.2	- 2.2
	3	3	50	50
	4	4	+ 1	+ 1
	5	5	44	44
	6	6	+ 7	+ 7
	7	7	46	46
	8	8	1.7	1.7
	9	9	49	49
	10	10	1.9	1.9
	Mean variation.	Mean variation.	3	3
	Alcohol (dose B)	Alcohol (dose B)	Feb. 19, 1914:	Feb. 19, 1914:
	1	1	51	51
	2	2	- 4	- 4
	3	3	50	50
	4	4	+ 1	+ 1
	5	5	44	44
	6	6	+ 7	+ 7
	7	7	46	46
	8	8	2.0	2.0
	9	9	48	48
	10	10	1.7	1.7
	Mean variation.	Mean variation.	49	49
	Normal.	Normal.	Mar. 19, 1914:	Mar. 19, 1914:
	1	1	51	51
	2	2	- 0.9	- 0.9
	3	3	52	52
	4	4	+ 0.9	+ 0.9
	5	5	48	48
	6	6	2.2	2.2
	7	7	50	50
	8	8	1.4	1.4
	9	9	52	52
	10	10	1.7	1.7
	Mean variation.	Mean variation.	50	50
	Alcohol (dose B)	Alcohol (dose B)	Feb. 19, 1914:	Feb. 19, 1914:
	1	1	51	51
	2	2	- 0.9	- 0.9
	3	3	50	50
	4	4	+ 1	+ 1
	5	5	44	44
	6	6	+ 7	+ 7
	7	7	46	46
	8	8	2.0	2.0
	9	9	48	48
	10	10	1.7	1.7
	Mean variation.	Mean variation.	49	49
	Normal.	Normal.	Mar. 19, 1914:	Mar. 19, 1914:
	1	1	51	51
	2	2	- 2.2	- 2.2
	3	3	50	50
	4	4	+ 1	+ 1
	5	5	44	44
	6	6	+ 7	+ 7
	7	7	46	46
	8	8	2.0	2.0
	9	9	48	48
	10	10	1.7	1.7
	Mean variation.	Mean variation.	49	49
	Normal.	Normal.	Mar. 19, 1914:	Mar. 19, 1914:
	1	1	51	51
	2	2	- 2.2	- 2.2
	3	3	50	50
	4	4	+ 1	+ 1
	5	5	44	44
	6	6	+ 7	+ 7
	7	7	46	46
	8	8	2.0	2.0
	9	9	48	48
	10	10	1.7	1.7
	Mean variation.	Mean variation.	49	49

The values for the first period of the alcohol experiments were obtained before the alcohol was given and are therefore not included in the averages. ¹Illegible because reaction was too slight. ²No reaction.

to determine the instant at which the movement began. To insure the greatest uniformity in the reading of the lid-reflex records we adopted the following rules: (1) all records are read with a lens; (2) since the moment of stimulation is more sharply defined than the beginning of muscle contraction, we regularly read from the latter to the former; (3) to this end a fine line scratched on a transparent glass plate was first placed on the record where the shadow of the lid seemed to leave its base-line. This was controlled by slight oscillations of the scratch until it rested on a point where in motion to the right the base-line seemed to move, while in motion to the left it seemed to remain still. Estimating this point in terms of one-tenth of a division, the reader then read back to the break in the stimulus-line, counting the full spaces and estimating the rest in tenths of a division. Aside from placing the scratch, we believe from numerous control readings that the errors of reading are very small, certainly not over 1σ. The errors involved in finding the beginning of the curves of small amplitude are undoubtedly greater. But while different readings of the same curve will vary in this way occasionally as much as 3σ, this represents an extreme variation. We believe that the averages are accurate to 1σ.

The extent of contraction of the lid-muscle is a complex trigonometrical function of the displacement of the shadow. For comparative purposes, however, the displacement of the shadow is a satisfactory measure when, as in our records, the artificial eyelash has a uniform length. In extreme reflex movements the shadow will leave the slit entirely. This deprives the curve of its apex. The height of such curves can usually be estimated from the direction of the visible lines without significant loss of accuracy.

A more serious disturbance occurs when the record is complicated by hid-movements from other arcs, such as corneal reflexes, changes in the line of regard, and voluntary blinking. In most cases the reflex is clearly distinguishable from these disturbances. When there was any real ground for question the readers were instructed to omit the measurement.

RESULTS.

Tables 4 and 5 contain all the available data arranged by subjects. Since there was no such extreme effect of alcohol on the protective lid-reflex as prevented accurate measurements of the patellar reflex after dose B, the full program was followed; that is, except for accidental omission, each subject has two normal sessions at least, and one session each for 30 c.c. and 45 c.c. of absolute alcohol respectively. Under each subject is given first the averages of each experimental period of each session. These data will be significant in the discussion of individual peculiarities. Beside and to the right of these data, in units of measurement, appear the more significant differences between the "normal of the day" and subsequent periods, according to the formula $D = 1 - 2, 1 - 3, 1 - 4, \dots, 1 - N$. The subjects are given

was necessary. Since none of the recording rays entered the eyes, this was obtained without difficulty by reducing the thickness of the blue-glass screen.

To secure a constant pre-experimental position of the lid, the subject was instructed to look at a regular fixation mark. In order to control the attention and respiration of the subject, as in the knee-jerk, he was instructed to count in a slow drawl forwards or backwards, according to the instructions, from a number which was given a second or two before the experiment began.

The following events just preceded each record: (1) the opaque slide of the plate-holder was withdrawn; (2) the shadows were observed on the ground-glass focusing-screen, to be sure that the light and position were satisfactory; (3) the subject began to count; (4) the plate-holder mechanism was noiselessly set in motion; (5) at fixed points in its course the moving plate-holder broke the contacts which controlled the movement of the percussor hammers, and consequently produced the stimulus noises.

RECORDS.

An illustrative record is shown in figure 9. Reading the record from left to right, the two breaks in the lower line show the moments of the first and second stimulus respectively. A careful inspection of this stimulus record will show two phases. A preliminary phase of about 5σ represents the recoil of the whole system to the thrust of the hammer as it responds to the pressure of its spring. A slow-moving hammer increases this phase. Since it is desirable to reduce it to a minimum, the hammer should be of relatively small mass, and should offer the least possible resistance to the air, while the spring should be quick-acting. The moment of contact between hammer and sounding-board and the consequent moment of the noise stimulus is shown by a sudden interruption of this preliminary phase. The stimulus record then passes into a series of secondary vibrations corresponding to the combination of fundamental periods of the system and its supports. The upper line is a shadow of the artificial eyelash. While it runs horizontally the lid is at rest. Lid closure is shown by a drop in the line. The moment of incidence, course of the lid-movement, its extent, and the duration of the return to its base-line can all be read directly from the records. The abscissæ or parallels to the base-line are 2 mm. apart. The vertical ordinates represent time intervals of 0.01 second. We believe that our lid-reflex technique guarantees the most exact graphic records that it is possible to obtain of the reflex contraction of human muscle. The apparatus has no instrumental latency. The muscle load is minimal and the stimulus is not modified by the response movement.

Reading the records for the latency of the reflex is a less exact process. The gradual onset of a muscle contraction always makes it difficult



Fig. 9.—Protective lid-reflex record.

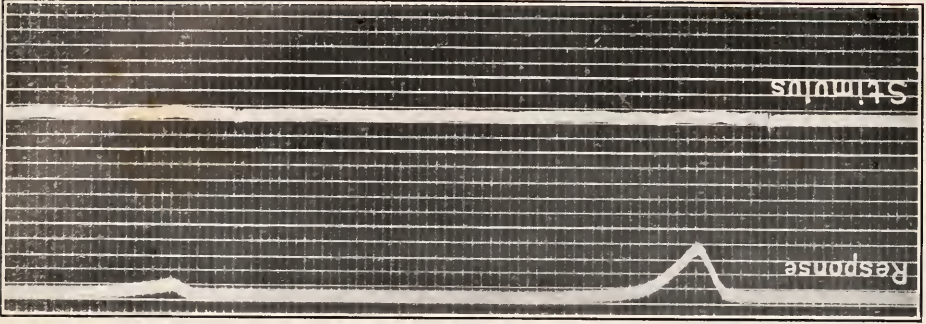

Fig. 8.—Interruptor in action.

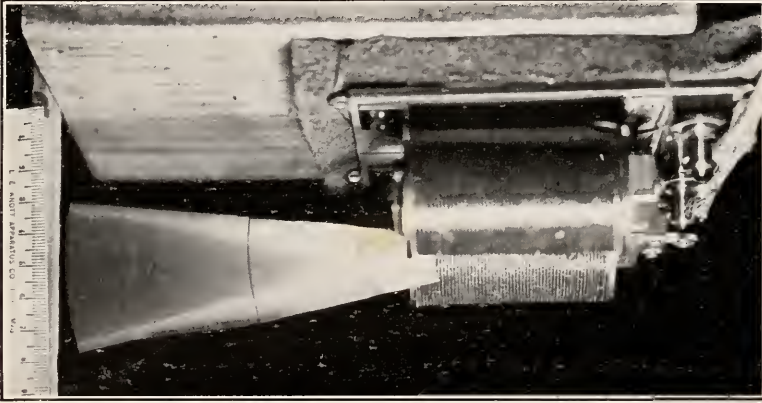
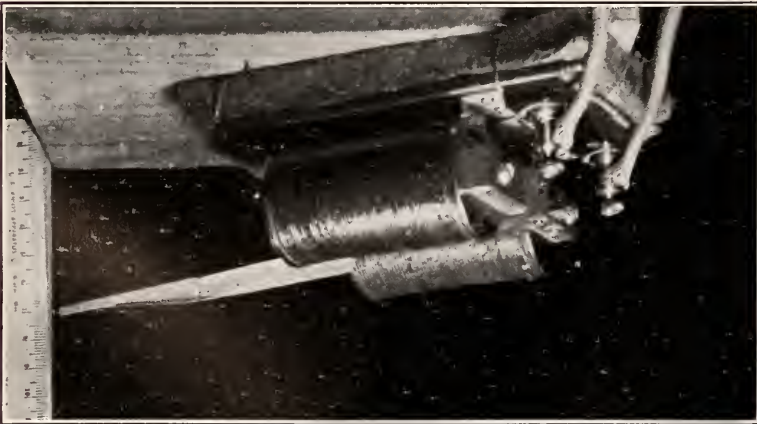

Fig. 7.—Time-recording interruptor at rest.



Since these silk threads are perpendicular to the axis of the cylindrical lens, their shadows appear on the photographic records as parallels to the base-line of the record. Interruptions of the beam of light at its source by a vibrator (figs. 7 and 8), in series with an electrically driven tuning-fork of 50 double vibrations, appear on the records as time-ordinates 0.01" apart.

Figures 7 and 8 give photographic reproductions of the light interruptor at rest and in vibration. The simultaneously photographed millimeter scale on the right of the cuts is in the plane of the marker and gives its dimensions directly.

The interruptor is so constructed that the vibrating reed can be shortened or lengthened until its natural period is identical with the period of the instigating fork. This insures a maximum amplitude of oscillation with a minimum of electric current. The amplitude of oscillation should be as large as is practicable, so that the width of the corresponding time-ordinate shadow may be minimal.

The operation of a light-interruptor as a time-marker for photographic records is doubtless too familiar to need extended description. Briefly it is as follows: If the recording beam of light is momentarily interrupted at its source, a shadow line is made across the record, giving the alignment of all phases of the record at that moment. With a tuning-fork driven vibrator as interruptor, the consequent succession of alignment shadows becomes a true time-record. Each time ordinate in our records represents 0.01 second.

EXPERIMENTAL PROCEDURE.

Lid-reflex measurements were usually taken immediately after the eye-movement records. The subject remained in the same position against the head-rest as for the eye-movement records (position 2, fig. 1). The following changes were made by the experimenter on the apparatus table and in the lighting system: (1) a screen, which covered the left eye during the eye-movement measurements to prevent binocular complications of the eye-movements, was withdrawn so that the shadow of the left eyelash could fall across the slit of the recording camera; (2) the mirror (M' , fig. 1) was rotated so that the beam of recording light was deflected to the recording camera; (3) the objective of the projection lantern was moved in so that the recording rays were highly dispersed; (4) the blue-glass screen that cut down the physiological rays of the arc light for photographing the eye-movements was reduced to one-third its normal thickness; (5) the time-marking vibrator was partially withdrawn, so that only its narrow tip cut the light beam. The last change reduced the duration of the interruptions to the least possible proportion of the record. The faintest practicable time ordinates were desirable in order to interfere with reading the curves as little as possible. Dispersed rays gave sharper shadows than parallel rays. But with the dispersion greater intensity of the light

It is a horizontal form of the Dodge-Cline recording camera. Within a horizontal wooden box (fig. 6, camera C) is a frame which is fitted to carry commercial 5 by 7 inch photographic-plate holders. This frame slides horizontally in grooves of heavy brass supports. The lateral movement of the frame and plate-holder is produced by the lead weight W working against an oil resistance OC outside the box. In this case, however, it operates in the reverse direction to that in which it was originally used. Piston P works in an oil-filled cylinder OC. While the pull of the weight W exerts a constant pressure to raise the piston in the cylinder, actual movement is impossible unless oil is admitted behind the piston through a valve V, which is just visible in the figure. The oil which is fed in at the bottom is taken from the top of the cylinder through a by-pass which is not visible in figure 6. The valve

Fig. 6.—The noise-stimulus apparatus for the lid-reflex in position before the photographic recording camera.

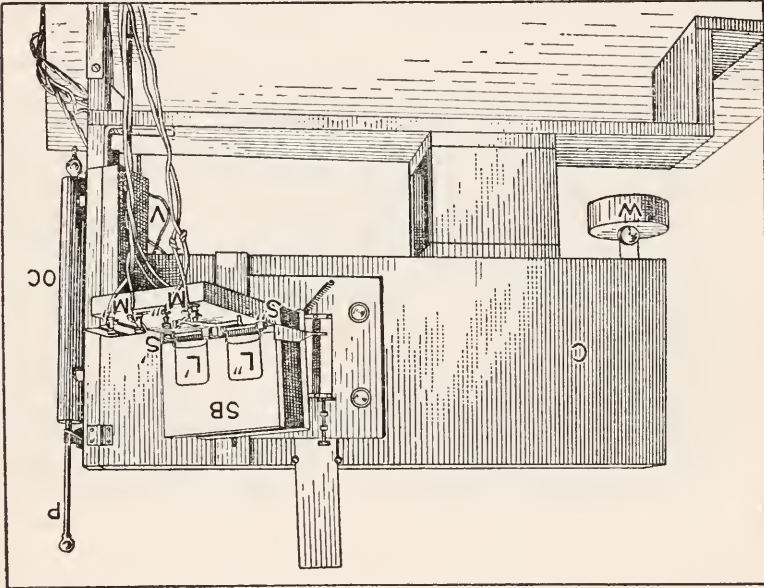

within a horizontal wooden box (fig. 6, camera C) is a frame which is fitted to carry commercial 5 by 7 inch photographic-plate holders. This frame slides horizontally in grooves of heavy brass supports. The lateral movement of the frame and plate-holder is produced by the lead weight W working against an oil resistance OC outside the box. In this case, however, it operates in the reverse direction to that in which it was originally used. Piston P works in an oil-filled cylinder OC. While the pull of the weight W exerts a constant pressure to raise the piston in the cylinder, actual movement is impossible unless oil is admitted behind the piston through a valve V, which is just visible in the figure. The oil which is fed in at the bottom is taken from the top of the cylinder through a by-pass which is not visible in figure 6. The valve

While their personal peculiarities disturb the general average of the group, the contribution of their data to the general theory is of particular value. In any event, the disadvantages of using a sound stimulus are not greater than those of other stimuli. The advantages of a sound stimulus are three: (1) it permits direct recording in the same shadow complex that includes the eyelashes; (2) successive stimuli are apprehended as discrete, well within the limits of the complete refractory phase, and (3) the mechanism of reaction in no wise modifies the receptor.

In the noise-stimulus apparatus (fig. 6) the two steel-wire loops *L'L'* serve as percussive hammers to produce the noise. Before the stimulation they are held horizontal by the electromagnets *M'M'*. A break in the circuit of either one of these magnets frees the wire-loop hammer, which is hurled against the sounding-board *S B* by the adjustable spring *S'S'*. The sharp clap of contact was an adequate wink stimulus for all but one of our subjects.

Some minor points in this stimulus device, the product of our experience, may be worth mentioning. (1) Wire hammers are better than solid hammers. Though the latter would have greater weight, the former can be given greater velocity. This increased velocity is desirable, since it lessens the time interval between the release of the hammer and the moment of stimulation, and so offers less chance for disturbing secondary cues before the real stimulus. For a similar reason the hammers move through 90° instead of 180°, as in our first instrument. (2) To reduce the consumption of electric current and consequent wear on contacts, the hammers are not held directly by the magnets, but by wire triggers. (3) The leverage of the trigger for the second hammer must be considerably greater than for the first, otherwise the second hammer would be released by the vibrations of the first impact.

EYELASH.

Since the eyelashes of different subjects are very often different in length and thickness, it became necessary to standardize them by using artificial lashes. These were cut from black paper, and measured 1 mm. by 15 mm. A short arm 1.5 mm. long, bent at right angles to the main piece, gave a satisfactory base for attachment to the eyelid. Very heavy gum arabic solution proved a satisfactory adhesive medium.

PHOTOGRAPHIC RECORDING CAMERA.

For photographically recording the shadows of the eyelash and noise stimulus almost any horizontal photographic device would serve. For compactness and convenience of operation, the instrument that we used leaves little to be desired. Unfortunately it is not entirely noiseless.

graphic plate. We believe that this is not only the simplest but the most accurate available technique for time measurements of the protective lid-reflex. Our technique is essentially the same as that which was described by Dodge.¹ Its instrumental requirements are a photographic recording camera, and a device for producing a sudden loud noise. Across the slit of the photographic recording camera are thrown two shadows. One is the shadow of a projection from the sounding-board of the noise-producer, the other is the shadow of a real or of an artificial eyelash. Movement of the first shadow shows the moment of stimulation. Movement of the second shadow shows the moment of reflex response. A suitable timing device permits direct reading of the latency and extent of lid-movement.

STIMULUS.

Various forms of stimuli are usable to elicit the protective wink-reflex. Zwaardemaker and Lans,² experimenting with both rabbit and human subjects, used two forms of stimuli—flashes of light and puffs of air blown against the cornea. With a frog as a subject, Dodge used a weak Faradic stimulation of the cornea. A blow on the face or a sudden noise will also produce a wink-reflex. Both flashes of light and puffs of air are unsatisfactory stimuli for studying the refractory phase of the reflex, since in both cases the wink modifies the receptors and mechanically decreases their accessibility to a subsequent stimulus for an appreciable interval of time. Moreover, the wink itself produces a sudden change in the illumination of the retina and a slight stimulation of the cornea. Both the flash of light and the puff of air become decidedly annoying in any considerable number of repetitions, the former by its effect upon the muscles of the iris, the latter as it dries the cornea. Electrical stimulation of the cornea ought to be especially useful. We have not attempted to use it in humans, because of the lack of suitable electrodes on the one hand and the possibility that electric stimulation of neighboring tissue might also directly stimulate the lid-muscles. Dermal stimuli, like a blow on the cheek, were found in preliminary trial to have a relatively long after-effect.

On a variety of grounds we chose the noise stimulus. But even this is not without its possible difficulties. For example: (1) it would be useless in cases of deaf subjects; (2) subjects trained by participation in athletic sports or by other means to keep their eyes open would be in a class by themselves. With the deaf we have had no experience. The class would probably not be larger than that of visual defectives. Of those especially trained not to respond, Dodge investigated and

¹Dodge, *Zeitschr. f. allg. Physiol.*, 1910, 12, p. 1; *Dodge, Am. Journ. Psych.*, 1913, 24, p. 1.
²Zwaardemaker and Lans, *Zentralbl. f. Physiol.*, 1899, 13, p. 325.

(6) The data as a whole unequivocally indicate that moderate doses of alcohol tend to produce a marked depression of the patellar reflex, as shown in a decreased response or a lengthened latency, or both. The refractory phase of the patellar reflex is not measurably affected by the 30 c.c. dose in any regular way.

EFFECT OF ALCOHOL ON THE PROTECTIVE LID-REFLEX.

The second of the simple reflexes which the psychological program suggested for immediate study in connection with the ingestion of alcohol was the protective lid-reflex. It seemed to satisfy all our requirements both in respect to the accuracy of technique and in respect to the completeness with which it fitted into the scheme of related neuro-muscular processes. Its latent time is of the same order as that of the patellar reflex, *i. e.*, 30 σ to 40 σ . Since it is a cephalic reflex, experimental data should be significant for the effect of alcohol on a very different part of the neuro-muscular organism from that which governs the patellar reflex. Furthermore, it satisfied our requirements with respect to freedom from voluntary control and arbitrary interference with the results. The characteristic reflex lid-movement can neither be simulated nor voluntarily inhibited. Like the patellar reflex, the protective lid-reflex is subject to considerable individual variation, but its normal variation in the same individual is much less.

TECHNIQUE.

The latent time and duration of the several phases of the wink have been investigated by a number of physiologists with a variety of techniques. The first measurements of the latent time of the wink reflex were made by Exner.¹ Subsequent measurements were made by Franck,² Mayhew,³ and Garten.⁴ Garten's beautiful photographic technique gave the first accurate curves of the course of the lid contraction. The more recent kinematographic records of O. Weiss⁵ refer only to the voluntary wink and not to the protective reflex. Both Garten and Weiss used the general principle of serial, intermittent photographic records. To give comparable values for the short latent time of the reflex wink (30 to 40 σ), such records should have a frequency of from 500 to 1,000 per second. The obvious difficulties in intermittent records of this frequency, while they are not prohibitive, emphasize the relative simplicity of a photographic method which gives continuous records of the shadows of the eyelashes on a moving photo-

¹Exner, Archiv f. d. ges. Physiol., 1874, 8, p. 526.

²Franck, Ueber die zeitlichen Verhältnisse des ref. u. willk. Lidschlusses. Dissertation, Königsberg, 1889.

³Mayhew, Journ. exp. Med., 1897, 2, p. 35.

⁴Garten, Archiv f. d. ges. Physiol., 1898, 71, p. 477.

⁵Weiss, Zeitschr. f. Sinnesphysiol., 1911, 45, p. 307.

(2) Since the second reflex (R'' and H'') is affected by alcohol like the first, though in less degree, one may say that these experiments show less effect of alcohol on the second reflex within the refractory phase of the knee-jerk than on the initial response. But, since the second stimulus was regularly given during the relatively refractory phase of the first, the response is often too slight to permit an accurate measurement of R''. Consequently, the instances in which a latent time was measurable in response to the second stimulus are substantially fewer than in the case of the first. On this account the relationship between the percentile effect of alcohol on the latent time in the two cases must be regarded as partly accidental. That it represents a real tendency, however, appears from the similar relationship of the percentile changes in extent.

(3) Individual variations from the average are conspicuous. Their discussion will be more in place in the final chapter in connection with other measurements. The chief exception in the main group is Subject VI, who not uncommonly differs from the rest of the group in the other measurements, as well as in these.¹

(4) The psychopathic subjects, table 3, at the bottom, show considerable variation among themselves, and between themselves and the main group. While the number of subjects in this class is too few to treat statistically as a class, it is conspicuous that they all agree in the effect of alcohol on the amount of reflex contraction (H'), and that this agrees in direction with that of the main group. The effect on the reflex latency and on the refractory phase H'' is highly irregular. We have no basis for their interpretation.

(5) In the 12-hour experiment, H' is affected as after a single dose. It is apparent that in this case Subject VI follows the rule of the main group rather than his own precedents after a single dose. It is worthy of note, moreover, that the much larger total amount of alcohol given in smaller doses over a long period affects the latency of the reflex less than a single dose of 30 to 45 c.c.

¹This tendency of Subject VI to differ from the group was a troublesome matter to handle. It was possible that he actually presented a physiological exception to the average effects of alcohol as represented by the rest of the group. As far as our controls went, however, it was not impossible that he was taking food or drugs that masked the effect of the alcohol. It was further possible that his was one of the cases of chance variation. In any event, it appeared advisable to repeat the experiments on him after his work in the medical school had closed in June. To this end he served as a subject a full week of 6 days, 5 hours per day. On 3 of these days alcohol was given with River's solution and quassa. On the 3 normal or non-alcohol days, the same quantity of the control mixture was given (River's solution and quassa without alcohol). Though he never failed to know when alcohol was present, he had no way of knowing beforehand whether alcohol would be given or not. This series was given and elaborated by Professor W. R. Miles, of this Laboratory, without consulting the previous records. The results will be published separately. These sessions were given under the best practical controls. Being given after the close of the regular term's work, the subject was relatively free from the pressure of outside engagements. He agreed to maintain the utmost regularity with respect to food and daily routine. The resulting data are the most complete secured from any of the subjects. They clearly show that VI is not a true physiological exception to the group of normal subjects.

SUMMARY OF THE EFFECT OF ALCOHOL ON THE PATELLAR REFLEX.

The results of the patellar reflex measurements, as far as the effects of alcohol are concerned, are grouped together in the summary, table 3. In this table the effect of alcohol is shown in two ways: (1) at the left, in terms of time and space units, and (2) at the right, in percentiles. These various values are calculated according to the formulae that are given in the discussion of the statistical method. (See p. 29.)

TABLE 3.—Summary of the effects of alcohol on the patellar reflex.

[R' and R'' are given in thousandths of a second.]

Subject.	Dose.	Effect as shown by average differences, ¹		Effect as shown by percentile differences, ²			
		R'	R''	H'	H''		
Normal subjects:	A	-8.5	+19.7	+152	+12.0		
	A	(3)	+6.0	(3)	+91		
	A	(3)	+1.7	(3)	+45		
	B	-3.8	+6.2	-2.7	+9.0		
	A	(3)	+4.2	(3)	-19		
	A	(3)	+3.1	(3)	+105		
	A	(3)	+2.7	(3)	+68		
	A	-0.1	-3.7	-0.3	-13		
	B	+2.3	-7.5	+6.4	-37		
	A	-3.0	+8.8	+7.3	+110		
	A	-5.7	+2.2	-17.0	+14		
	B	-7.0	+6.8	-20.0	+47		
Average.....		-3.7	+4.1	+48.9	+21.8		
12 hr. experiments:	A	+2.8	+4.1	+26	+29		
	C	+0.9	+3.9	+2.8	+6.8		
	Average.....	+1.8	+4.0	+4.8	+27		
	Psychopathic subjects:	A	-1.8	+3.0	-4.6	+31	
		XI	+2.3	+4.3	+6.6	+36	
		XII	+0.5	+0.2	+1.2	+2	
		Average.....	-0.0	+1.9	+0.3	+23	
		Effect on the average difference equals (Av. 1-2, 1-3, 1-4, etc., alcohol) minus (Av. 1-2, 1-3, 1-4, etc., normal). ¹ Effect on the percentile difference equals average difference divided by average of the corresponding first periods. ² Illegible.	A	-1.8	+3.0	-0.2	-4.6
			A	+2.3	+4.3	+6.6	+36
			A	+0.5	+0.2	+1.2	+2
			Average.....	-0.0	+1.9	+0.3	+23
			A	-1.8	+3.0	-0.2	-4.6
A			+2.3	+4.3	+6.6	+36	
A			+0.5	+0.2	+1.2	+2	
Average.....			-0.0	+1.9	+0.3	+23	
A	-1.8		+3.0	-0.2	-4.6		
A	+2.3		+4.3	+6.6	+36		
A	+0.5		+0.2	+1.2	+2		
Average.....	-0.0		+1.9	+0.3	+23		

At the extreme left of table 3 appear the numbers of the subjects. In the next column the alcohol dosage is indicated. Under R' and H' appear the effect of alcohol on the latency and extent of the first reflex. Similarly, under R'' and H'' appear the effect on the latency and the extent of the second reflex. (1) From the upper part of table 3 (normal subjects), it appears that alcohol regularly tends to depress the patellar reflex, that is, it lengthens the latent time of the reflex in five out of six of the main group of subjects by an average of 9.6 per cent, and it decreases the height of the contraction by an average of 48.9 per cent.

Subject VIII is not included in this summary, since he was unable to complete the series and his inclusion would make it impossible to compare this with later tables. His results are in the same direction as the average of the group, but greater in degree.

Subject VIII is not included in this summary, since he was unable to complete the series and his inclusion would make it impossible to compare this with later tables. His results are in the same direction as the average of the group, but greater in degree.

PSYCHOPATHIC SUBJECTS.

<i>Subject XI.</i> Mar. 24, 1914	30 gm. hammer:	σ	<i>mm.</i>	σ	<i>mm.</i>	<i>Subject XI.</i> Mar. 25, 1914 (15 e.c.) ⁴	50 gm. hammer:	σ	<i>mm.</i>	σ	<i>mm.</i>
	1-2.....	-2.1	+0.7	-4.4	+2.5		1-2.....	-1.8	+0.6	+0.7	-0.3
	1-3.....	-5.3	+3.6	-8.5	+5.7		1-3.....	-1.4	+7.1	(⁶)	+1.9
Mar. 26, 1914	50 gm. hammer:					Mar. 27, 1914 (Dose A.)	1-4.....	-2.5	+0.1	-4.0	-0.4
	1-2.....	-0.8	+2.8	+0.1	-2.1		1-5.....	+1.6	-9.3	+1.2	-3.4
	50 gm. hammer:						Average <i>D.</i> ...	1	0.4	-1.2	-0.5
Mar. 28, 1914	1-2.....	+1.4	-7.2	-0.6	-2.2	50 gm. hammer:	1-2.....	-4.6	+2.7	-2.1	-2.8%
	1-3.....	+0.7	-10.0	-1.3	-1.3		1-3.....	-4.2	+1.9	-0.2	-20%
	Average <i>D.</i> ...	-1.2	-2.3	-2.9	-0.05		1-4.....	0.2	-2.4	+0.6	+0.2
<i>Subject XII.</i> Mar. 31, 1914	75 gm. hammer:					Average <i>D.</i> ...	Average <i>D.</i> ...	3.0	+0.7	-0.6	-0.2
	1-2.....	-7.1	+2.1	-6.4	+1.9		Percentile <i>D.</i> ...	-6.4%	+7.6%	-0.1%	-5%
	1-3.....	-2.3	+0.3	-6.6	+1.0						
Apr. 4, 1914	75 gm. hammer:					<i>Subject XII.</i> Apr. 1, 1914 (Dose A.)	75 gm. hammer:				
	1-2.....	+3.7	-0.4	-0.5	+0.2		1-2.....	+2.5	+4.7	(⁶)	+1.4
	1-3.....	+0.7	+3.3	(⁶)	+1.3		1-3.....	+1.3	+3.7	+2.5	+1.0
<i>Subject XIV.</i> Apr. 21, 1914	Average <i>D.</i> ...	1.2	+1.3	-4.5	+1.1	50 gm. hammer:	1-4.....	+0.7	+3.9	-0.5	+0.7
	Percentile <i>D.</i> ...	-3%	+19%	-12.5%	+30%		1-5.....	-0.1	+3.6	-2.5	-0.2
							Average <i>D.</i> ...	1.1	+3.97	-0.2	+0.72
Apr. 25, 1914	75 gm. hammer:					<i>Subject XIV.</i> Apr. 22, 1914 (Dose A.)	Percentile <i>D.</i> ...	+3.2%	+51%	-5.4%	+23%
	1-2.....	+0.9	+0.09	+1.9	+0.2		75 gm. hammer:				
	1-3.....	+0.3	+3.90	+0.4	+1.79		1-2.....	+3.5	+3.62	+2.1	+1.61
<i>Subject XVI.</i> Apr. 25, 1914	75 gm. hammer:					1-3.....	1-3.....	-0.4	+0.15	-0.2	-0.33
	1-2.....	+0.8	+3.79	+4.3	+0.34		1-4.....	-2.2	+5.31	(⁶)	+2.64
	1-3.....	+4.4	+5.01	(⁶)	+1.39		1-5.....	-5.4	+4.38	-6.2	+1.63
<i>Subject XVII.</i> Apr. 25, 1914	Average <i>D.</i> ...	0.6	+3.2	+2.2	+0.9	Average <i>D.</i> ...	Average <i>D.</i> ...	1.1	+3.4	-1.4	+1.4
	Percentile <i>D.</i> ...	-1.4%	+17%	+4.3%	+27%		Percentile <i>D.</i> ...	-2.4%	+43%	-3.3%	+38%

¹No record.

²Illegible on account of continuous mechanical vibration.

³Illegible because reactions were too slight.

⁴In this first alcohol experiment with psychopathic subjects, one-half the usual dose was given as a precautionary measure. The reduction in regular dosage proved unnecessary and was not continued.

⁵Illegible.

TABLE 2.—*Patellar reflex*—Continued.
 In *D* values. *D* equals the difference of the measurements of subsequent periods from those of the first or normal period of the day. *R'* and *R''* are given in thousandths of a second.]

Normal.						Alcohol.					
Subject and date.	Periods compared.	<i>R'</i>	<i>H'</i>	<i>R''</i>	<i>H''</i>	Subject and date.	Periods compared.	<i>R'</i>	<i>H'</i>	<i>R''</i>	<i>H''</i>
<i>Subject IX.</i> Oct. 11, 1913	50 gm. hammer:					<i>Subject IX.</i> Oct. 20, 1913 (Dose A.)	50 gm. hammer:				
	1-2.....	+ 1	<i>mm.</i> - 8.1	σ 2	<i>mm.</i> - 9.0		1-2.....	- 3	<i>mm.</i> - 6.9	σ 0	<i>mm.</i> - 9.5
	1-3.....	+ 2	- 3.2	+ 2	- 5.9		1-3.....	- 4	- 5.2	+ 1	- 6.0
	1-4.....	+ 1	- 9.2	+ 1	- 16.8		1-4.....	- 5	- 1.4	+ 1	- 7.4
	Average <i>D</i>	+ 1.3	- 6.8	+ 0.3	- 10.6		1-5.....	- 5	- 3.7	+ 1	- 7.4
	Percentile <i>D</i> ...	+ 3.5%	- 39%	+ 0.9%	- 61%		1-6.....	- 5	- 5.8	+ 1	- 7.8
							Average <i>D</i>	- 4.4	- 4.6	+ 0.4	- 7.6
					Percentile <i>D</i> ...	- 14.5%	- 32%	- 0.1%	- 54%		
Dec. 22, 1913 (12 hr. expt.)	50 gm. hammer:					Jan. 29, 1914 (Dose B.)	50 gm. hammer:				
	1-2.....	+ 1	+ 3.25	0	+ 2.75		1-2.....	0	- 6.6	+ 1	- 3.1
	1-3.....	- 2	- 6.00	- 3	+ 4.25		1-3.....	- 2	+ 5.2	+ 3	+ 3.0
	1-4.....	(⁷)	(⁷)	(⁷)	(⁷)		1-4.....	(⁴)	+ 9.3	+ 1	- 2.9
	1-5.....	- 4	- 3.0	- 2	- 7.75		1-5.....	- 5	+ 5.1	+ 1	+ 4.9
	1-6.....	(²)	(²)	(²)	(²)		1-6.....	- 6	+ 4.4	0	+ 3.3
	1-7.....	7	+ 4.0	- 6	+ 0.25		1-7.....	- 5	- 2.9	- 2	+ 4.1
	1-8.....	- 3	+ 1.0	- 1	+ 2.25		1-8.....	3	+ 5.6	+ 1	+ 4.8
	1-9.....	- 3	- 6.0	- 3	- 10.75		Average <i>D</i>	- 3.5	+ 2.9	+ 1.4	+ 2.3
	1-10.....	- 2	- 9.0	- 5	- 2.25		Percentile <i>D</i> ...	- 10.6%	+ 16%	- 1.3%	+ 25%
	Average <i>D</i>	- 2.9	- 2.2	- 2.9	- 1						
	Percentile <i>D</i> ...	- 10%	- 14%	- 10%	- 10%						
	Dec. 23, 1913 (Dose C.) (12 hr. expt.)	50 gm. hammer:						Dec. 23, 1913 (Dose C.) (12 hr. expt.)	50 gm. hammer:		
1-2.....		- 5	+ 1.2	+ 6	- 4	1-2.....	- 5		+ 1.2	- 6	- 4
1-3.....		- 2	+ 7.0	- 1	+ 1.1	1-3.....	- 2		+ 7.0	- 1	+ 1.1
1-4.....		- 3	+ 8.2	(⁹)	+ 2.4	1-4.....	- 3		+ 8.2	(⁹)	+ 2.4
1-5.....		+ 2	- 2.1	- 3	+ 0.5	1-5.....	+ 2		- 2.1	- 3	+ 0.5
1-6.....		4	- 3.1	- 3	- 11.2	1-6.....	4		- 3.1	- 3	- 11.2
1-7.....		2	+ 2.6	1	+ 0.8	1-7.....	2		+ 2.6	1	+ 0.8
1-8.....		0	(⁶)	(³)	(³)	1-8.....	0		(⁶)	(³)	(³)
1-9.....		3	+ 4.8	- 3	- 3.2	1-9.....	3		+ 4.8	- 3	- 3.2
1-10.....		- 4	+ 4.9	- 4	- 1.9	1-10.....	- 4		+ 4.9	- 4	- 1.9
Average <i>D</i>		- 2	+ 1.7	- 2.8	- 1.9	Average <i>D</i>	- 2		+ 1.7	- 2.8	- 1.9
Percentile <i>D</i> ...		- 7.9%	+ 10%	- 8.7%	- 22%	Percentile <i>D</i> ...	- 7.9%		+ 10%	- 8.7%	- 22%

SIMPLEST NEURAL ARCS.

Jan. 1, 1914 (12 hr. experiment)	30 gm. hammer:	1-2.....	1	+5.8	(?)	+1.7	1-6.....	-2	+7.5	(?)	+0.2
		1-3.....	5	+3.8	(?)	+2.5	1-7.....	-1	+0.6	(?)	+0.4
		1-4.....	8	+6.5	(?)	+3.4	1-8.....	3	+7.5	(?)	-0.6
		1-5.....	2	+10.0	(?)	+4.0	Average D....	-1	+3.5	0.0
		1-6.....	6	+12.1	(?)	+2.6	Percentile D...	-2.5%	+31.5%	0.0%
		1-7.....	2	+11.6	(?)	+1.6					
		1-8.....	7	+6.6	(?)	+2.4					
		1-9.....	0	+3.0	(?)	+1.4					
		1-10.....	2	+2.8	(?)	+3.5					
		Average D....	3.6	+6.2	+2.6					
Percentile D...	8.9%	+34.7%	+53.1%							
Subject VIII. Oct. 8, 1913	75 gm. hammer:	1-2.....	0	+1.0	+2	-0.8	1-2.....	0.4	+5.3	0.7	+4.4
		1-3.....	3	+2.7	4.6	+1.5	1-3.....	(?)	+12.5	(?)	+7.5
		1-4.....	5	+1.5	6.0	+1.2	1-4.....	7.6	+10.7	(?)	+6.4
		Average D....	2.7	+1.7	2.9	+0.6	1-5.....	(?)	+12.3	(?)	+7.1
		Percentile D...	6.4%	+19%	6.6%	+14.2%	1-6.....	5.2	+10.3	1.8	+5.5
						1-7.....	9.6	+10.6	3.6	+6.7	
						Average D....	5.7	+11.4	5.6	+5.6	
						Percentile D...	13.5%	+10.5	7.0%	+6.2	
										+7.7%	
Subject VIII. Oct. 9, 1913	75 gm. hammer:	1-2.....	+0.2	+4.6	+8	-10.4	1-2.....	9.6	+17.9	7	+14.1
		1-3.....	+7.6	+1.6	+6.6	-8.9	1-3.....	-12.0	+23.6	-11	+15.9
		1-4.....	+7.6	+8.1	+6.5	-8.2	1-4.....	10.2	+22.5	0	+12.2
		Average D....	+5.1	+4.8	+7	-9.2	1-5.....	-11.6	+24.2	4	+5.1
		Percentile D...	+10%	+30%	+15.5%	-71%	1-6.....	(?)	+25.3	4	+12.1
						Average D....	-11.9	+23.5	7	+11.7	
						Percentile D...	-30%	+85%	-15.7%	+44%	
Jan. 2, 1914 (Dose C) (12 hr. experiment)	30 gm. hammer:	1-2.....	+1	+3.9	(?)	+10.2	1-2.....	3	+10.2	(?)	-1.5
		1-3.....	3	+10.2	(?)	+10.4	1-3.....	10	+10.4	(?)	-0.4
		1-4.....	10	+7.9	(?)	+12.4	1-4.....	6	+7.9	(?)	-2.8
		1-5.....	6	+12.4	(?)	+11.0	1-5.....	1	+11.0	(?)	+0.1
		1-6.....	(?)	+11.4	(?)	+10.7	1-6.....	2	+11.4	(?)	-0.6
		1-7.....	1	+11.4	(?)	+11.8	1-7.....	3	+11.8	(?)	-1.8
		1-8.....	2	+10.7	(?)	+13.2	1-8.....	1	+13.2	(?)	-1.2
		1-9.....	3	+11.8	(?)	+10.3	Average D....	0.8	+10.3	(?)	0.0
		1-10.....	1	+13.2	(?)	+71.4%	Percentile D...	2%	+71.4%	-0.9
		Average D....	0.8	+10.3	+71.4%					-81%
Percentile D...	2%	+71.4%								
Subject VII. Oct. 15, 1913 (Dose A.)	75 gm. hammer:	1-2.....	0.4	+5.3	0.7	+4.4	1-6.....	5.2	+10.3	1.8	+5.5
		1-3.....	(?)	+12.5	(?)	+7.5	1-7.....	9.6	+10.6	3.6	+6.7
		1-4.....	7.6	+10.7	(?)	+6.4	Average D....	5.7	+11.4	5.6	+5.6
		1-5.....	(?)	+12.3	(?)	+7.1	Percentile D...	13.5%	+10.5	7.0%	+6.2
		1-6.....	5.2	+10.3	1.8	+5.5					+7.7%
		1-7.....	9.6	+10.6	3.6	+6.7					
		1-8.....	5.6	+11.4	5.6	+5.6					
		Average D....	5.7	+10.5	7.0%	+6.2					
		Percentile D...	13.5%	+10.5	7.0%	+6.2					
Subject VIII. Oct. 16, 1913 (Dose A.)	50 gm. hammer:	1-2.....	9.6	+17.9	7	+14.1	1-2.....	9.6	+17.9	7	+14.1
		1-3.....	-12.0	+23.6	-11	+15.9	1-3.....	-12.0	+23.6	-11	+15.9
		1-4.....	10.2	+22.5	0	+12.2	1-4.....	10.2	+22.5	0	+12.2
		1-5.....	-11.6	+24.2	4	+5.1	1-5.....	-11.6	+24.2	4	+5.1
		1-6.....	(?)	+25.3	4	+12.1	1-6.....	(?)	+25.3	4	+12.1
		1-7.....	-11.9	+23.5	7	+11.7	1-7.....	-11.9	+23.5	7	+11.7
		Average D....	-11.1	+23	-5.5	+11.8	Average D....	-11.1	+23	-5.5	+11.8
		Percentile D...	-30%	+85%	-15.7%	+44%	Percentile D...	-30%	+85%	-15.7%	+44%

Illegible on account of continuous mechanical vibration.

Illegible because reaction was too slight.

TABLE 2.—*Patellar reflex*—Continued.
 [In *D* values, *D* equals the difference of the measurements of subsequent periods from those of the first or normal period of the day. *R'* and *R''* are given in thousandths of a second.]

Normal.					Alcohol.						
Subject and date.	Periods compared.	<i>R'</i>	<i>H'</i>	<i>R''</i>	<i>H''</i>	Subject and date.	Periods compared.	<i>R'</i>	<i>H'</i>	<i>R''</i>	<i>H''</i>
<i>Subject IV.</i> Oct. 2, 1913	50 gm. hammer:	σ	<i>mm.</i>	σ	<i>mm.</i>	<i>Subject IV.</i> Sept. 28, 1913 (Dose A.)	50 gm. hammer:	σ	<i>mm.</i>	σ	<i>mm.</i>
	1-2.....	- 1	- 1.1	0	+ 2.6		1-2.....	(1)	+ 1.2	(1)	+ 2.3
	1-3.....	+ 1	0.0	0	+ 3.4		1-3.....	(1)	- 2.4	(1)	+ 3.1
	1-4.....	- 2	- 5.4	- 1	- 6.2		1-4.....	(1)	- 8.0	(1)	+ 5.5
	Average <i>D</i>	- 0.7	- 2.2	- 0.3	- 0.1		1-5.....	(1)	- 6.6	(1)	+ 5.7
Percentile <i>D</i> ...	- 1.7%	- 20%	- 0.7%	- 0.9%	Average <i>D</i>		- 3.9		+ 4.1		
<i>Subject VI.</i> Oct. 7, 1913	30 gm. hammer:					Percentile <i>D</i> ...		- 53.5%		+ 43.5%	
	1-2.....	0	+ 6	(2)	+ 6.9	50 gm. hammer:					
	1-3.....	- 4	+ 10	(2)	+ 7.2	1-2.....	(2)	+ 6.3	(2)	+ 6.8	
	1-4.....	6	+ 17	(2)	+ 7.3	1-3.....	5	+ 3.3	5	+ 1.9	
	Average <i>D</i>	- 3.3	+ 11		+ 7.1	1-4.....	- 4	+ 2.5	- 1.0	+ 2.6	
Percentile <i>D</i> ...	- 10%	+ 37%		+ 86%	Average <i>D</i>	- 4.5	+ 4.0	- 2.5	+ 2.6		
<i>Subject VI.</i> Oct. 14, 1913 (Dose A.)	30 gm. hammer:					Percentile <i>D</i> ...	- 10%	+ 54%	- 5.2%	+ 33%	
		1-2.....	- 5	+ 5	(2)	+ 5	50 gm. hammer:				
		1-3.....	+ 1	+ 2	(2)	+ 2	1-2.....	(2)	+ 6.3	(2)	+ 6.8
		1-4.....	- 3	+ 15	(2)	+ 0.4	1-3.....	5	+ 3.3	5	+ 1.9
		1-5.....	- 4	+ 10		+ 1.6	1-4.....	- 4	+ 2.5	- 1.0	+ 2.6
Average <i>D</i>	- 3.4	+ 7		+ 3.7	Average <i>D</i>	- 3.4	+ 7.3	- 6	+ 1.4		
Percentile <i>D</i> ...	- 11%	+ 27%		- 16%	Percentile <i>D</i> ...	- 11%	+ 27%		- 87%		
<i>Subject VI.</i> Jan. 27, 1914 (Dose B.)	30 gm. hammer:					1-7.....	4	+ 9	4	- 4.4	
		1-2.....	+ 1	- 2.8	(2)	+ 1	1-8.....	- 4	+ 7	- 4	
		1-3.....	0	+ 0.1	(2)	0	Average <i>D</i>	- 3.4	+ 7.3	- 6	
		1-4.....	- 2	+ 2.5	(2)	+ 0.2	Percentile <i>D</i> ...	- 11%	+ 27%		
		1-5.....	(2)	+ 9.5	(2)	0					

TABLE 2.—*Patellar reflex.*

[In *D* values. *D* equals the difference of the measurements of subsequent periods from those of the first or normal period of the day. *R'* and *R''* are given in thousandths of a second.]

Normal.					Alcohol.												
Subject and date.	Periods compared.	<i>R'</i>	<i>H'</i>	<i>R''</i>	<i>H''</i>	Subject and date.	Periods compared.	<i>R'</i>	<i>H'</i>	<i>R''</i>	<i>H''</i>						
<i>Subject II.</i> Oct. 8, 1913	50 gm. hammer:					<i>Subject II.</i> Sept. 23, 1913 (Dose A.)	30 gm. hammer:										
	1-2.....	0	+0.4	0	+0.5		1-2.....	-1	+12.4	0	+1.4						
	1-3.....	0	0.0	+2	-0.8		1-3.....	-2	+13.4	-2	+5						
	1-4.....	+5	-2.6	+7	-3.8		1-4.....	+18.4	+7						
	1-5.....	+1	-2.8	-1	-0.6		50 gm. hammer:										
	Average <i>D</i>	+1.5	-1.2	+2	-1.2		1-5.....	-5	+18.4	+1	+7						
Percentile <i>D</i>	+2.9%	-50%	+4%	-55%	1-6.....	-8	+19.4	-6	+7								
<i>Subject III.</i> Oct. 1, 1913	100 gm. hammer:					1-7.....	-7	+20.4	+7							
	1-2.....	(?)	+1.4	(?)	-0.7	1-8.....	+20.8	+7							
	1-3.....	(?)	+0.2	(?)	+1.0	1-9.....	-9	+20.0	-6	+5							
	1-4.....	(?)	+1.8	(?)	+1.0	1-10.....	-12	+20.0	-6	+5							
	Average <i>D</i>	+1.1	+1.1	+0.4	1-11.....	-11	+20.0	-5	+5							
	Percentile <i>D</i>	+93%	+40%	1-12.....	-9	+20.0	-4	+5							
<i>Subject III.</i> Sept. 29, 1913 (Dose A.)	100 gm. hammer:	Average <i>D</i>	-20%	+18	-3.5%	+5.8	+81%					
													1-2.....	(?)	+7.0	(?)	+2.0
													1-3.....	(?)	+7.8	(?)	+3.0
													1-4.....	(?)	+4.9	(?)	+2.4
													1-5.....	(?)	+6.6	(?)	+3.8
													1-6.....	(?)	+7.2	(?)	+4.0
													1-7.....	(?)	+7.8	(?)	+4.5
													1-8.....	(?)	+6.4	(?)	+4.0
													1-9.....	(?)	+8.0	(?)	+5.0
													1-10.....	(?)	+7.4	(?)	+3.4
													1-11.....	(?)	+7.2	(?)	+3.5
													1-12.....	(?)	+8.8	(?)	+4.4
													1-13.....	(?)	+7.6	(?)	+3.8
													1-14.....	(?)	+5.7	(?)	+2.3
Average <i>D</i>	+7.1	+3.5													
Percentile <i>D</i>	+74%	+60%													

¹These values are reduced to correspond with those obtained by a 30 gm. hammer, by assuming that the *H'* and *H''* actually obtained by using a 50 gm. hammer at 9^h 5^m p. m. should be equivalent to the *H'* and *H''* produced by a 30 gm. hammer at 9^h 3^m p. m.

²Illegible on account of instrumental vibration.

TABLE 4.—Protective lid-reflex measurements—Continued.

Subject and kind of experiment.	Date and number of period.	R'		H'		R''		H''	
		Average of period.	Difference (1-2, 1-3, etc.).	Average of period.	Difference (1-2, 1-3, etc.).	Average of period.	Difference (1-2, 1-3, etc.).	Average of period.	Difference (1-2, 1-3, etc.).
<i>Subject VI.</i>									
Normal.....	Oct. 22, 1913:	σ	σ	mm.	mm.	σ	σ	mm.	mm.
	1.....	29		¹ 25		(²)		(³)	
	2.....	(³)	(³)	(³)	(³)	(³)	(³)	(³)	(³)
	3.....	33	- 4	21	+ 4	30	(²)	19	(³)
	4.....	30	- 1	21	+ 4	(²)	(²)	(³)	(³)
	5.....	36	- 7	20	+ 5	(²)	(²)	(³)	(³)
	6.....	(²)	(²)	(³)	(³)	(²)	(²)	(³)	(³)
	Average.....	32	- 4	21	+ 4.3				
	Mean variation...	2		1.2					
Alcohol (dose A)..	Oct. 29, 1913:								
	1.....	⁴ 46		⁴ 13.0		⁴ 40		⁴ 20.0	
	2.....	46	0	1.7	+11.3	51	-11	4.1	+15.9
	3.....	60	-14	2.4	+10.6	49	- 9	1.4	+18.6
	4.....	52	- 6	1.6	+11.4	50	-10	2.0	+18.0
	5.....	45	+ 1	6.8	+ 6.2	38	+ 2	3.0	+17.0
	6.....	54	- 8	6.5	+ 6.5	39	+ 1	11.0	+ 9.0
	Average.....	51	- 5.4	3.8	+ 9.2	45	- 5.4	4.3	+15.7
	Mean variation...	5		2.3		6		2.7	
Normal.....	Nov. 5, 1913:								
	1.....	37		16		33		10	
	2.....	40	- 3	9	+ 7	40	- 7	4	+ 6
	3.....	30	+ 7	10	+ 6	37	- 4	6	+ 4
	4.....	47	-10	6	+10	35	- 2	3.7	+ 6.3
	Average.....	38	- 2	10	+ 7.7	36	- 4.3	5.9	+ 5.43
	Mean variation...	5		2.7		2		2.1	
Alcohol (dose A)..	Nov. 12, 1913:								
	1.....	⁴ 41		⁴ 14		⁴ 47		⁴ 4.6	
	2.....	35	+ 6	7.3	+ 6.7	44	+ 3	4.1	+ 0.5
	3.....	44	- 3	11.0	+ 3.0	43	+ 4	1.3	+ 3.3
	4.....	37	+ 4	0.0	+14.0	38	+ 9	5.0	- 0.4
	5.....	37	+ 4	2.3	+11.7	39	+ 8	2.7	+ 1.9
	Average.....	38	+ 2.7	5.1	+ 8.85	41	+ 6	3.3	+ 1.32
	Mean variation...	3		4.0		2		1.3	
Normal (12 hr. experiment).	Dec. 22, 1913:								
	1.....	33		¹ 15		(²)		(³)	
	2.....	31	+ 2	15	0	30	(²)	15	(³)
	3.....	32	+ 1	15	0	29	(²)	15	(³)
	4.....	29	+ 4	15	0	(²)	(²)	(³)	(³)
	5.....	(³)	(³)	(³)	(³)	(³)	(³)	(³)	(³)
	6.....	35	- 2	15	0	(²)	(²)	(³)	(³)
	7.....	36	- 3	10	+ 5	(²)	(²)	(³)	(³)
	8.....	29	+ 4	15	0	(²)	(²)	(³)	(³)
	9.....	(²)	(²)	(³)	(³)	(²)	(²)	(³)	(³)
	10.....	32	+ 1	(³)	(³)	(²)	(²)	(³)	(³)
	Average.....	32	+ 1	14	+ 0.8	29.5		15	
	Mean variation...	2		1.4		0.5		0	
Alcohol (dose C; 12 hr. experiment).	Dec. 23, 1913:								
	1.....	⁴ 38		⁴ 15		(²)		(³)	
	2.....	(³)	(³)	(³)	(³)	(³)	(²)	(³)	(³)
	3.....	38	0	¹ 15	0	(²)	(²)	(³)	(³)
	4.....	(²)	(²)	(³)	(³)	(²)	(²)	(³)	(³)
	5.....	35	+ 3	15	0	(²)	(²)	(³)	(³)

¹Approximate.

²Voluntary anticipatory lid-movement.

³No record.

⁴The values for the first period of the alcohol experiments were obtained before the alcohol was given and are therefore not included in the averages.

TABLE 4.—Protective lid-reflex measurements—Continued.

Subject and kind of experiment.	Date and number of period.	R'		H'		R''		H''	
		Average of period.	Difference (1-2, 1-3, etc.).	Average of period.	Difference (1-2, 1-3, etc.).	Average of period.	Difference (1-2, 1-3, etc.).	Average of period.	Difference (1-2, 1-3, etc.).
<i>Subject VI</i> —con. Alcohol (dose C; 12 hr. experiment)—con.	Dec. 23, 1913—con.	σ	σ	mm.	mm.	σ	σ	mm.	mm.
6.....	39	- 1	15	0	(1)	(1)	(2)	(2)	
7.....	33	+ 5	15	0	(1)	(1)	(2)	(2)	
8.....	33	+ 5	15	0	(2)	(1)	(2)	(2)	
9.....	(1)	(1)	(2)	(2)	(1)	(1)	(2)	(2)	
10.....	(1)	(1)	(2)	(2)	(1)	(1)	(2)	(2)	
11.....	30	+ 8	15	0	(1)	(1)	(2)	(2)	
Average.....	35	+ 3	15	0					
Mean variation...	3		0						
Alcohol (dose B)..	Jan. 22, 1914:								
1.....	³ 39.7		³ 11.3		³ 39		³ 3.7		
2.....	45.5	- 5.8	1.5	+ 9.8	38	+ 1	1.3	+ 2.4	
3.....	45.0	- 5.3	0.85	+10.45	49	-10	0.3	+ 3.4	
4.....	46.0	- 6.3	0.8	+10.5	39	0	0.2	+ 3.5	
5.....	43.0	- 3.3	1.2	+10.1	33	+ 6	5.0	- 1.3	
6.....	36.0	+ 3.7	5.0	+ 6.3	39	0	2.3	+ 1.4	
Average.....	43.1	- 3.4	1.87	+ 9.43	39	- 0.6	1.8	+ 1.88	
Mean variation...	2.9		1.25		3		1.4		
<i>Subject VII.</i> Normal.....	Oct. 21, 1913:								
1.....	44		20		45		5		
2.....	41	+ 3	20	0	42	+ 3	20	-15	
3.....	37	+ 7	20	0	40	+ 5	20	-15	
4.....	40	+ 4	20	0	40	+ 5	20	-15	
5.....	40	+ 4	20	0	39	+ 6	17	-12	
Average.....	40	+ 4.5	20	0	41	+ 4.7	16.4	-14	
Mean variation...	2		0		2		4.6		
Alcohol (dose A)..	Oct. 28, 1913:								
1.....	³ 33.5		³ 20		³ 36		³ 9.1		
2.....	37	- 3.5	20	0	35	+ 1	10.0	- 0.9	
3.....	36	- 2.5	20	0	42	- 6	2.7	+ 6.4	
4.....	38	- 4.5	15	+ 5	37	- 1	1.9	+ 7.2	
5.....	43	- 9.5	15	+ 5	42	- 6	0.8	+ 8.3	
6.....	44	-10.5	13	+ 7	40	- 4	1.3	+ 7.8	
Average.....	39	- 6.1	16	+ 3.4	39	- 3.2	3.3	+ 5.8	
Mean variation...	3		2.6		3		2.6		
Normal.....	Nov. 4, 1913:								
1.....	38		20		36		1.5		
2.....	35	+ 3	20	0	40	- 4	0	+ 1.5	
3.....	33	+ 5	20	0	39	- 3	1.0	+ 0.5	
Average.....	35	4	20	0	38	- 3.5	.8	+ 1.0	
Mean variation...	1.7		0		1.7		.6		
Alcohol (dose A)..	Nov. 11, 1913:								
1.....	³ 39		³ 20		(2)		(2)		
2.....	47	- 8	14	+ 6	39	(2)	1.1	(2)	
3.....	38	+ 1	15	+ 5	33	(2)	14.0	(2)	
4.....	42	- 3	12	+ 8	43	(2)	.7	(2)	
5.....	40	- 1	14	+ 6	39	(2)	.9	(2)	
6.....	40	- 1	18	+ 2	44	(2)	5.0	(2)	
Average.....	41	- 2.4	14	+ 5.4	39		5.1		
Mean variation...	2		1.4		4		4.4		

¹Voluntary anticipatory lip-movement.²No record.³The values for the first period of the alcohol experiments were obtained before the alcohol was given and are therefore not included in the averages.

TABLE 4.—Protective lid-reflex measurements—Continued.

Subject and kind of experiment.	Date and number of period.	R'		H'		R''		H''	
		Average of period.	Difference (1-2, 1-3, etc.).	Average of period.	Difference (1-2, 1-3, etc.).	Average of period.	Difference (1-2, 1-3, etc.).	Average of period.	Difference (1-2, 1-3, etc.).
<i>Subject VII—con.</i>									
Alcohol (dose B) ..	Mar. 13, 1914:	σ	σ	<i>mm.</i>	<i>mm.</i>	σ	σ	<i>mm.</i>	<i>mm.</i>
	1.....	¹³¹	¹²⁴	¹³²	¹⁹
	2.....	30	+ 1	21	+ 3	34	- 2	1.2	+ 7.8
	3.....	38	- 7	12	+12	31	+ 1	1.5	+ 7.5
	4.....	32	- 1	20	+ 4	32	0	2	+ 7
	5.....	(²)	(²)	(²)	(²)	(²)	(²)	(²)	(²)
	Average.....	33.3	- 2	17.7	6.3	32	- 0.3	1.5	+ 7.4
	Mean variation...	3	3.8	127
Normal.....	Mar. 20, 1914:								
	1.....	34	20.5	35	8.9
	2.....	31	+ 3	26.7	- 6.2	34	+ 1	5.0	+3.9
	3.....	36	- 2	16.9	+ 3.6	36	- 1	2.7	+6.3
	4.....	33	+ 1	24.0	- 3.5	32	+ 3	7.9	+1.0
	Average.....	33.5	+ 0.7	22.0	- 2.0	34	1	6.0	3.7
	Mean variation...	1.5	3.3	1	2.3
<i>Subject IX.</i>									
Normal.....	Oct. 27, 1913:								
	1.....	43	14	33	5.1
	2.....	38	+ 5	17.5	- 3.5	34	- 1	10.0	- 4.9
	3.....	35	+ 8	³ 20.0	- 6.0	38	- 5	4.5	+ 0.6
	4.....	38	+ 5	11.5	+ 2.5	38	- 5	13.0	- 7.9
	5.....	32	+11	18.0	- 4.0	38	- 5	13.0	- 7.9
	Average.....	37	+ 7.2	16.2	- 2.75	36	- 4	9.1	- 5.02
	Mean variation...	3	2.8	2	3.5
Alcohol (dose A) ..	Nov. 3, 1913:								
	1.....	¹⁴²	¹¹⁷	(⁴)	(⁴)
	2.....	39	+ 3	9.3	+ 7.7	39	(⁴)	2.1	(⁴)
	3.....	45	- 3	5.5	+11.5	42	(⁴)	0.6	(⁴)
	Average.....	42	0	7.4	+ 9.6	40	(⁴)	1.3	(⁴)
	Mean variation...	3	1.9	1.5	0.75
Normal.....	Nov. 10, 1913:								
	1.....	35	³ 15	41	6
	2.....	36	- 1	15	0	39	+ 2	7	- 1
	3.....	34	+ 1	15	0	31	+10	6.5	- 0.5
	4.....	33	+ 2	15	0	36	+ 5	9.1	- 3.1
	Average.....	34	+ 0.7	15	0	37	+ 6	7.1	- 1.53
	Mean variation...	1	0	3	0.95
Alcohol (dose A) ..	Nov. 17, 1913:								
	1.....	¹³⁶	¹¹⁸	¹³⁵	(⁵)
	2.....	39	- 3	12.6	+ 5.4	(⁴)	(⁴)	(⁵)
	3.....	46	-10	18.7	- 0.7	39	- 4	(⁵)
	4.....	39	- 3	19.3	- 1.3	43	- 8	(⁵)
	5.....	36	0	20.0	- 2.0	35	0	(⁵)
	6.....	37	- 1	18.7	- 0.7	37	- 2	(⁵)
	Average.....	39	- 3.4	17.8	+ 0.14	38	- 3.5
	Mean variation...	2	2.1	2
Normal (12 hr. experiment).	Jan. 1, 1914:								
	1.....	31	9.4	44	2.50
	2.....	30.2	+ 0.8	11.6	- 2.2	30	+14	4.50	- 2
	3.....	31.7	- 0.7	6.7	+ 2.7	32	+12	2.87	- 0.37
	4.....	33.5	- 2.5	14.5	- 5.1	30	+14	3.25	- 0.75
	5.....	40.3	- 9.3	9.3	+ 0.1	28	+16	6.83	- 4.33
	6.....	32.0	- 1.0	18.0	- 8.6	36	+ 8	4.83	- 2.33
	7.....	34.0	- 3.0	14.0	- 4.6	37	+ 7	5.25	- 2.75

¹The values for the first period of the alcohol experiments were obtained before the alcohol was given and are therefore not included in the averages.

²Illegible.

³Approximate.

⁴No record.

⁵Voluntary anticipatory lid-movement.

TABLE 4.—Protective lid-reflex measurements—Continued.

Subject and kind of experiment.	Date and number of period.	R'		H'		R''		H''	
		Average of period.	Difference (1-2, 1-3, etc.).	Average of period.	Difference (1-2, 1-3, etc.).	Average of period.	Difference (1-2, 1-3, etc.).	Average of period.	Difference (1-2, 1-3, etc.).
<i>Subject IX—con.</i> Normal (12 hr. experiment)— <i>con.</i>	Jan. 1, 1914— <i>con.</i>	σ	σ	<i>mm.</i>	<i>mm.</i>	σ	σ	<i>mm.</i>	<i>mm.</i>
	8.....	34.7	- 3.7	9.8	- 0.4	39	+ 5	2.83	- 0.33
	9.....	27.0	+ 4.0	22.0	-12.6	45	- 1	5.0	- 2.50
	10.....	32.0	+ 1.0	19.3	- 9.9	36	+ 8	3.0	- 0.50
	Average.....	32.6	- 1.6	13.46	- 4.51	35.6	+ 9.2	4.08	- 1.76
	Mean variation.....	2.3		4.10		4.5		1.19	
Alcohol (dose C; 12 hr. experiment).	Jan. 2, 1914:	¹ 29.7		¹ 13		¹ 40.7		¹ 6	
	1.....	31.2	- 1.5	9.12	+ 3.88	32.5	+ 8.2	5.25	+ 0.75
	2.....	28.0	+ 1.7	14.0	- 1.0	35.0	+ 5.7	4.87	+ 1.13
	3.....	30.5	- 0.8	8.12	+ 4.88	38.5	+ 2.2	1.87	+ 4.13
	4.....	31.5	- 1.8	9.75	+ 3.25	43.5	- 2.8	2.37	+ 3.63
	5.....	36.0	- 6.3	8.0	+ 5.0	35.3	+ 5.4	5.50	+ 0.50
	6.....	(²)	(²)	(²)	(²)	(²)	(²)	(²)	(²)
	7.....	41.5	-11.8	5.87	+ 7.13	51.3	-10.6	2.0	+ 4.00
	8.....	40.3	-10.6	6.33	+ 6.67	39.0	- 1.7	2.0	+ 4.00
	9.....	31.7	- 2.0	6.83	+ 6.17	37.0	- 3.7	10.5	+ 4.50
	10.....	34.7	- 5.0	14.25	- 1.25	31.0	- 9.7	9.0	- 3.00
	11.....	33.0	- 4.2	9.14	+ 3.86	38.0	- 0.8	4.82	+ 1.18
	Average.....	33.0	- 4.2	9.14	+ 3.86	38.0	- 0.8	4.82	+ 1.18
	Mean variation.....	4.0		2.35		4.3		2.47	
Alcohol (dose B)	Jan. 21, 1914:	¹ 31		¹ 26		¹ 41		¹ 6.3	
	1.....	38.7	- 8	5.7	+20.3	38	+ 3	26.0	-19.7
	2.....	38.0	- 7	10.3	+15.7	(³)	(³)	(²)	(²)
	3.....	32.0	- 1	14.7	+11.3	(³)	(³)	(²)	(²)
	4.....	36.0	- 5	2.7	+23.3	37	+ 4	23.0	-16.7
	5.....	25.0	+ 6	14.5	+11.5	33	+ 8	5.2	+ 1.1
	6.....	33.9	- 3	9.6	+16.42	36	+ 5	18.0	-11.77
	Average.....	33.9	- 3	9.6	+16.42	36	+ 5	18.0	-11.77
	Mean variation.....	4.4		4.3		2		8.6	
<i>Subject X.</i> Normal.....	Mar. 11, 1914:	32		2.2		(⁴)		0.0	
	1.....	38	- 6	0.7	+ 1.5	(⁴)	(⁴)	.0	0
	2.....	41	- 9	.9	+ 1.3	(⁴)	(⁴)	.0	0
	3.....	40	- 8	.5	+ 1.7	(⁴)	(⁴)	.0	0
	4.....	34	- 2	1.5	+ 0.7	(⁵)	(⁵)	.5	- 0.5
	5.....	31	+ 1	1.2	+ 1.0	(⁵)	(⁵)	.5	- .5
	6.....	36	- 4.8	1.17	+ 1.24	(⁵)	(⁵)	.2	- .2
	Average.....	36	- 4.8	1.17	+ 1.24			.2	- .2
	Mean variation.....	4		.45				.2	
Alcohol (dose A)...	Mar. 18, 1914:	¹ 41		¹ 6		(⁴)		¹ 0.0	
	1.....	36	+ 5	.7	+ 0.9	(⁴)	(⁵)	.15	- 0.15
	2.....	45	- 4	1.8	- .2	(⁴)	(⁴)		
	3.....	41	0	1.0	+ .6	(⁵)	(⁵)	.2	- .2
	4.....	39	+ 2	1.7	- .1	(⁵)	(⁵)	.2	- .2
	5.....	44	- 3	0.7	+ .9	(⁵)	(⁵)	.1	- .1
	6.....	41	0	1.2	+ .42			.13	- .16
	Average.....	41	0	1.2	+ .42			.13	- .16
	Mean variation.....	3		.5				.05	

¹The values for the first period of the alcohol experiments were obtained before the alcohol was given and are therefore not included in the averages.

²No record.

³Voluntary anticipatory lid-movement.

⁴No reaction.

⁵Illegible because reaction was too slight.

TABLE 4.—Protective lid-reflex measurements—Continued.

PSYCHOPATHIC SUBJECTS.

Subject and kind of experiment.	Date and number of period.	R'		H'		R''		H''	
		Average of period.	Difference (1-2, 1-3, etc.).	Average of period.	Difference (1-2, 1-3, etc.).	Average of period.	Difference (1-2, 1-3, etc.).	Average of period.	Difference (1-2, 1-3, etc.).
<i>Subject XI.</i>									
Normal.....	Mar. 26, 1914:	σ	σ	<i>mm.</i>	<i>mm.</i>	σ	σ	<i>mm.</i>	<i>mm.</i>
	1.....	38	0	1.5		(¹)	(¹)	0	0
	2.....	38	0	1.3	+ 0.2	(¹)	(¹)	0	0.0
	3.....	37	+ 1	0.7	+ 0.8	(²)	(²)	0.1	- 0.1
	Average.....	38	+ 0.5	1.2	+ 0.5				.05
	Mean variation...	0.3		.3				.04	
Alcohol (dose A)..	Mar. 27, 1914:	³ 37		³ 1.4		³ 38		³ 1.2	
	1.....	(¹)	(¹)	0	+ 1.4	(¹)	(¹)	0	+ 1.2
	2.....	71	-34	.1	+ 1.3	(¹)	(¹)	0	+ 1.2
	3.....	32	+ 5	.2	+ 1.2	(¹)	(¹)	0	+ 1.2
	Average.....	51	-14.5	.1	+ 1.3			0	+ 1.2
	Mean variation...	19		.07				0	
Normal.....	Mar. 28, 1914:								
	1.....	37		0.9		40		0.1	
	2.....	34	+ 3	.9	0	27	+13	.3	- 0.2
	3.....	30	+ 7	.9	0	(¹)	(²)	.05	+ .05
	Average.....	34	+ 5	.9	0	33	(²)	.15	- .07
	Mean variation...	2		.0		6		.1	
<i>Subject XII.</i>									
Normal.....	Apr. 2, 1914:								
	1.....	37		6.1		(¹)		0	
	2.....	36	+ 1	3.2	+ 2.9	(¹)	(¹)	0	0
	3.....	(²)	(²)	.1	+ 6.0	(¹)	(¹)	0	0
	4.....	51	-14	.2	+ 5.9	(¹)	(¹)	0	0
	5.....	47	-10	.4	+ 5.7	(¹)	(¹)	0	0
	Average.....	43	- 8	2.0	+ 5.12			0	0
	Mean variation...	6		2.1				0	
Alcohol (dose A)..	Apr. 3, 1914:	³ 39		³ 3.6		³ 39		³ 0.1	
	1.....	48	- 9	1.0	+ 2.6	(¹)	(¹)	0	+ 0.1
	2.....	35	+ 4	1.2	+ 2.4	(¹)	(¹)	0	+ .1
	3.....	52	-13	0.1	+ 3.5	(¹)	(¹)	0	+ .1
	4.....	(¹)	(¹)	0	+ 3.6	(¹)	(¹)	0	+ .1
	Average.....	45	- 6	.6	+ 3.02			0	+ .1
	Mean variation...	7		.5					
Normal.....	Apr. 4, 1914:								
	1.....	40		0.5		(¹)		0	
	2.....	42	- 2	.03	+0.47	34	(¹)	0.5	- 0.5
	3.....	42	- 2	.2	+ .30	(¹)	(¹)	0	.0
	Average.....	41	- 2	.24	+ .38	34		0.2	- .25
	Mean variation...	1		.17				0.2	
<i>Subject XIV.</i>									
Normal.....	Apr. 23, 1914:								
	1.....	44		11.1		(²)		0.1	
	2.....	41	+ 3	7.0	+ 4.1	(¹)	(¹)	0	0.1
	3.....	36	+ 8	4.2	+ 6.9	(¹)	(¹)	0	.1
	4.....	41	+ 3	10.0	+ 1.1	(¹)	(¹)	0	.1
	Average.....	40	+ 4.7	8.1	+ 4.0			0.02	.1
	Mean variation...	2		2.5				.03	

¹No reaction.

²Illegible because reaction was too slight.

³The values for the first period of the alcohol experiments were obtained before the alcohol was given and are therefore not included in the averages.

PSYCHOLOGICAL EFFECTS OF ALCOHOL.

TABLE 4.—Protective lid-reflex measurements—Continued.

PSYCHOPATHIC SUBJECTS—Continued.

Subject and kind of experiment.	Date and number of period.	R'		H'		R''		H''	
		Average of period.	Difference (1-2, 1-3, etc.).	Average of period.	Difference (1-2, 1-3, etc.).	Average of period.	Difference (1-2, 1-3, etc.).	Average of period.	Difference (1-2, 1-3, etc.).
<i>Subject XIV—con.</i> Alcohol (dose A)...	Apr. 24, 1914:	σ	σ	<i>mm.</i>	<i>mm.</i>	σ	σ	<i>mm.</i>	<i>mm.</i>
	1.....	135	1.9	(?)	10.1
	2.....	33	2	1.2	+ 0.7	(?)	(?)	0	+ 0.1
	3.....	39	- 4	0.4	+ 1.5	(?)	(?)	0.1	+ 0
	4.....	36	- 1	.7	+ 1.2	(?)	(?)	.02	+ 0.08
	5.....	34	1	.3	+ 1.6	(?)	(?)	.02	+ .08
	6.....	35	0	.2	+ 1.7	(?)	(?)	.05	+ .05
	Average.....	35	0.4	.5	+ 1.3404	+ .062
	Mean variation.....	1303
Normal.....	Apr. 25, 1914:								
	1.....	34	0.3	32	0.05
	2.....	34	0	.6	- 0.3	38	- 6	.10	- 0.05
	3.....	36	- 2	.7	- .4	36	- 4	.02	+ .03
	Average.....	35	- 1	.5	- .35	35	- 5	.06	- .01
	Mean variation.....	12	203

¹The values for the first period of the alcohol experiments were obtained before the alcohol was given and are therefore not included in the averages. ²Illegible because reaction was too slight. ³No reaction.

TABLE 5.—Summary of average differences in the protective lid-reflex measurements.¹

Subjects.	Normal.				Alcohol (dose A).				Alcohol (dose B).			
	R'	H'	R''	H''	R'	H'	R''	H''	R'	H'	R''	H''
Normal:	σ	<i>mm.</i>	σ	<i>mm.</i>	σ	<i>mm.</i>	σ	<i>mm.</i>	σ	<i>mm.</i>	σ	<i>mm.</i>
II.....	-8.0	- 1.5	-4.7	- 6.3	- 1.0	+ 1.5	+ 0.2	+ 1.1	-4.6	+11.2	+2.0	+ 0.7
	-3.0	0.0	0	- 0.3	- 7.6	0.0	- 4.5	+ 7.5
	-1.6	+ 1.36	-2.4	- 4.4
Average.....	-4.2	0.0	-2.4	- 3.7	- 4.3	+ 0.7	- 2.1	+ 4.3
X.....	-4.8	+ 1.2	- 0.2	0.0	+ 0.42	- 0.20
IV.....	-1.4	+ 1.8	+3.0	+ 0.3	+1.0	- 0.4	- 0.2
	+2.2	- 0.7	- 0.7
Average.....	+0.4	+ 0.5	- 0.2
VI.....	-4.0	+ 4.3	- 5.4	+ 9.2	- 5.4	+15.7	-3.4	+ 9.4	-0.6	+ 1.9
	-2.0	+ 7.7	-4.0	+ 5.4	+ 2.7	+ 8.8	+ 6.0	+ 1.3
Average.....	-3.0	+ 6.0	-4.0	+ 5.4	- 1.3	+ 9.0	+ 0.3	+ 8.5
III.....	-2.0	+15.5	-0.3	+ 0.5	- 8.6	+11.2	-10.0	+ 3.3	-9.7	+10.0	-7.0	+ 3.3
	-2.5	- 0.8	-3.5	- 0.7
Average.....	-2.2	+ 7.3	-1.9	- 0.1
IX.....	+7.2	- 2.7	-4.0	- 5.0	0.0	+ 9.6	-3.0	+16.4	+5.0	-11.8
	+0.7	0.0	+6.0	- 1.5	- 3.4	+ 0.1	- 3.5	(?)
Average.....	+3.9	- 1.3	+1.0	- 3.2	- 1.7	+ 4.8	- 3.5
VII.....	+4.5	0.0	+4.7	-14.0	- 6.1	+ 3.4	- 3.2	+ 5.8	-2.0	+ 6.3	-0.3	+ 7.4
	+4.0	0.0	-3.5	+ 1.0	- 2.2	+ 5.4
Average.....	+0.7	- 2.0	+1.0	+ 3.7
	+3.1	- 0.8	+0.7	- 3.1	- 4.1	+ 4.4
Psychopathic:												
XI.....	+0.5	+ 0.5	- 0.05	-14.5	+ 1.3	+ 1.2
	+5.0	0.0	- 0.07
Average.....	+2.7	+ 0.2	- 0.06
XII.....	-8.0	+ 5.12	0.00	- 6.0	+ 3.0	+ 0.1
	-2.0	+ 0.38	- 0.25
Average.....	-5.0	+ 2.7	- 0.12
XIV.....	+4.7	+ 4.0	+ 1.00	- 0.4	+ 1.34	+ 0.06
	-1.0	- 0.35	- 0.01
Average.....	+1.8	+ 1.8	+ 0.49

¹Differences equal periods 1-2, 1-3, 1-4, etc.

²Illegible.

SUMMARY OF THE EFFECT OF ALCOHOL ON THE PROTECTIVE LID-REFLEX.

(1) Summaries of the effects of alcohol computed according to the usual formulæ are contained in table 6. From this table, summary of the normal subjects, it appears that 30 c.c. alcohol increased the latent time of the response of the first stimulus in 4 out of 6 subjects by an

TABLE 6.—*Summary of the effect of alcohol on the protective lid-reflex.*

[R' and R'' are given in thousandths of a second.]

Subject and kind of experiment.	Effect as shown in average differences. ¹				Effect as shown in percentile differences. ²			
	R'	H'	R''	H''	R'	H'	R''	H''
<i>Normal subjects.</i>								
Dose A:	σ	<i>mm.</i>	σ	<i>mm.</i>	<i>p. ct.</i>	<i>p. ct.</i>	<i>p. ct.</i>	<i>p. ct.</i>
II.....	- 0.1	+ 0.7	+ 0.3	+ 8.0	- 0.3	+ 4.0	+ 1.0	+ 63.5
X.....	+ 4.8	- 0.8	0.0	+13.3	-42.0
IV.....
VI.....	+ 1.7	+ 3.0	+ 4.3	+ 3.1	+ 4.5	+18.0	+10.7	+ 27.0
III.....	- 6.4	+ 3.9	- 8.1	+ 3.4	-19.4	+20.0	-22.5	+179.0
IX.....	- 5.6	+ 6.1	- 4.5	-14.3	+38.0	-12.5
VII.....	- 7.2	+ 5.2	- 3.9	+ 8.9	-19.2	+26.0	-10.3	+146.0
Average.....	- 2.0	+ 3.0	- 2.4	+ 4.7	- 5.9	+10.7	- 6.8	+103.9
Dose B:
II.....	- 0.4	+11.2	+ 4.4	+ 4.4	- 1.4	+49.7	+13.7	+ 54.0
X.....
IV.....	+ 0.6	- 0.9	0.0	+ 1.3	-42.8
VI.....	- 0.4	+ 3.4	+ 3.4	- 3.5	- 1.1	+19.5	+ 9.4	- 51.0
III.....	- 7.5	+ 2.7	- 5.1	+ 3.4	-23.2	+14.4	-13.8	+179.0
IX.....	- 6.9	+17.7	+ 4.0	- 8.6	-19.2	+96.7	+10.5	-148.0
VII.....	- 5.1	+ 7.1	- 1.0	+10.5	-13.8	+33.8	- 2.7	+172.0
Average.....	- 3.3	+ 6.9	+ 1.1	+ 1.0	- 9.5	+28.5	+ 3.4	+ 41.0
<i>12 hr. experiments.</i>								
Dose C:
VI.....	+ 2.0	- 0.8	(³)	+ 5.7	- 5.0
IX.....	- 2.6	+ 8.3	-10.0	+ 2.9	- 8.6	+74.0	-23.6	+ 69.0
Average.....	- 0.3	+ 3.7	- 1.4	+34.0
<i>Psychopathic subjects.</i>								
Dose A:
XI.....	-17.2	+ 1.1	(³)	+ 1.26	-46.0	+85.0	(³)
XII.....	- 1.0	- 0.3	(³)	+ 0.22	- 2.6	- 9.0	(³)
XIV.....	- 2.2	- 0.5	(³)	- 0.42	- 5.8	-11.0	(³)
Average.....	- 6.8	+ 0.1	+ 0.35	-18.1	+22.0

¹Effect on the average difference equals (av. 1-2, 1-3, 1-4, etc., alcohol) minus (av. 1-2, 1-3, 1-4, etc., normal).

²Effect on the percentile difference equals average difference divided by average of the corresponding first periods.

³Illegible.

average of 5.9 per cent. At the same time the extent of movement was decreased in 5 out of 6 subjects by an average of 10.7 per cent. Similarly 45 c.c. alcohol increased the latent time of the first reflex 9.5 per cent, and decreased the extent of the movement 28.5 per cent. In this case there is but one exception out of 6 subjects.

(II) In the case of the psychopathic subjects the average results are in the same direction as those of the normal group. The 12-hour experiments with the normal subjects are evenly divided; Subject IX follows the average, and Subject VI opposes it—consistent with his other records.

(III) Since an increased latency and a decreased amplitude of reflex movement are the usual physiological indicators of decreased reflex excitability, we must conclude that in the case of the protective lid-reflex, as in that of the patellar reflex, moderate doses of alcohol tend to depress the excitability of the reflex arc. In the case of the lid-reflex, where the data include the effects of both the 30 c.c. and the 45 c.c. doses, the average depression varies directly with the dose.

(IV) The effect of alcohol on the refractory phase, as that is indicated by the reflex response to the second stimulus, is less uniform. After the 30 c.c. dose, both the first and the second reflexes are affected in the same direction. The percentile decrease in amplitude of the second reflex response is conspicuously high. After the 45 c.c. dose, on the contrary, the latency of the second reflex is actually decreased, while the amplitude is decreased, but less than half what it was after the 30 c.c. dose. The refractory-phase data are neither regular nor, since they represent only a single interval, can they be regarded as final. But they are certainly suggestive and seem to indicate an important lead for the investigation of individual differences in the action of drugs. If, as we assume, the refractory phase is an index of fatigability, the enormous individual variation in the effect of alcohol on the refractory phase of the reflex arc is evidence that the discrepancy between various studies of the effect of alcohol on fatigue is not an accident of experimental technique, but a result of actual individual differences. In the second place, our data seem to indicate that while both the first and second reflex responses are depressed in extent by both doses of alcohol, the larger dose with practically every subject has a less depressing effect on the latency of the second response than the first. The hypothesis suggests itself that one is approaching the border-line between refractory phase and summation. In the former, response to the first stimulation lessens response to the second; while in the latter, the effect of the first stimulus operates to augment the response to the second. Such border-lines or critical points are often found in the systematic variation of the interval between the first and second stimulation. Moreover, under normal conditions it regularly occurs that, when from some unknown cause the first response is unusually slight, the second may be higher than the first. It appears that with the larger dose, when the first response is conspicuously decreased, the second begins to be less depressed. These facts suggest the further hypothesis that the alcohol depression of the reflexes is more like a decrease in the readiness of the arc than a real paralysis. They suggest

the possibility that the alcoholic depression of the reflexes which follow its ingestion within our experimental sessions may operate to conserve reflex excitability. They emphasize the importance of experimenting over much longer periods than was provided for in this research. If the alcoholic depression of excitability may operate to facilitate recuperative processes, or even to conserve against normal fatigue, it would throw new light on the gross differences in clinical accounts of the reflexes of alcoholics.

(V) Two conspicuous exceptions to the generalization that alcohol tends to depress the lid reflex occur in Subjects X and IV. In both these subjects there is an unambiguous change of sign in the effect of alcohol. In both cases the reflex latency is decreased and the amplitude of the response is increased. That is, in both these subjects alcohol facilitates the reflex.

An inspection of the data of these subjects will show that in both cases the amplitude of the normal lid-reflex is conspicuously small. The extreme amplitude of lid-movement for subjects X and IV is 2.2 mm. and 4 mm. respectively. And these values are found only in the very first periods of the first session. In other periods the amplitude of the lid-movement of Subject X fails to reach even 2 mm. In no series of this subject, moreover, is the response to the second stimulus of sufficient amplitude to permit measurement of its latent time. In other words, in response to both the first and the second stimulus the normal lid-reflex of Subject X is extremely refractory. This was naturally noticed by the experimenters during the preliminary tests and led to the following disclosures: All the reflexes of Subject X are either entirely lacking or extraordinarily refractory. The knee-jerk could not be produced regularly without reinforcement by hammers up to 100 gm. in weight falling 40 cm. The Achilles reflex was present, but was apparently as refractory as the knee-jerk. The toe-reflexes were reported to be entirely lacking. They were not reinvestigated. With special reference to his lid-reflex to noise, Subject X reported being thoroughly accustomed to the use of firearms and trained to keep his eyes open as he shoots. The relative importance of nature and training in this case can not be determined from the data at hand. It is clear, however, that both factors are present. It should be noted in passing that both Subjects X and IV differ from the refractory subject previously described by Dodge¹ in having a normal reflex latency. Only the amplitude is abnormal. Much the same is true of the lid-reflex of Subject IV that was true of Subject X. In this subject, however, the refractoriness of the lid-reflex seems to be entirely artificial, connected with his football training. Evidence for a rapid adaptation process in both subjects is found by comparing the first with the second period on the first normal day of each.

¹Dodge, *Zeitschr. f. allg. Physiol.*, 1910, **12**, p. 1.

Taking all these facts into account, the change of sign in the effect of alcohol on the lid-reflex of these two subjects demands further scrutiny. It is conceivable, in the first place, that the change in sign may be accidental. But the data seem too consistent for such an interpretation. One must assume as probable that the facts indicate a real exception to the rule. Any evidence to the contrary must bear the burden of proof. In the second place, it should not be overlooked that the normal difference values for Subject X are based on a single normal day. While this violated both the requirements of our statistical theory, and our practice in other cases, it seemed unavoidable in the case of Subject X, who could ill afford time for further experiments. In the case of Subject IV the records of two normal days are available, but the relatively small amplitude of reflex movement on the second day, combined with the relatively large amplitude in the first period of the first normal day tends to disturb the distribution of the results in the same direction as it is disturbed in the case of Subject X. The effect was to exaggerate the importance of the initial sensitivity to the stimulus. The average normal difference (av. 1-2, 1-3, 1-4, 1-5) is consequently exaggerated, and the expression of the effect of alcohol (alcohol difference minus normal difference) is doubtless too high. Inspection of the unelaborated averages in the case of both Subjects X and IV indicates that the effect of alcohol on the lid-reflex was in fact not quite as great as the elaborated differences indicate. It may be questioned, then, why we allow the misleading difference values to stand. Following our statistical rule, we are bound to include all computed values in the total, where accidental variations such as these should theoretically tend to balance. Our special interest in these individual cases is not because of any effect that they have on the general tendency. It is chiefly the question whether they could be interpreted as genuine exceptional cases of facilitation of a reflex by alcohol. From the data at hand, this might be doubtful in the case of Subject X. It seems especially clear, however, in the case of Subject IV, where there is a conspicuous increase in the amplitude of the reflex lid-movement immediately following the ingestion of alcohol. In both cases one might suggest a third hypothesis. In view of the trained inhibition of the reflex in both subjects, in Subject X by training in shooting, and in Subject IV by training in football, it seems probable that the trained inhibitions are the first to feel the effects of alcohol. There are analogies enough in the succeeding chapters to give this hypothesis plausibility. This is another of the special problems that would seem to deserve direct experimental investigation.

(VI) The total result of all these data indicate that as in the patellar reflex so also in the lid-reflex, moderate doses of alcohol tend to depress the excitability of the reflex arc.

CHAPTER III.

EFFECT OF ALCOHOL ON COMPLEX NEURAL ARCS.

If we increase the complication of the nervous arc, we thereby also increase the sources of normal variability, as well as the difficulties of maintaining the similarity of experimental conditions, while we correspondingly decrease the probability of finding a normal invariant by any available statistical method. These difficulties incident to a study of the effect of alcohol on the more complex arcs are doubly unfortunate since the complex arcs represent both the theoretical and the practical climax of the study of the effects of alcohol on the neuro-muscular processes of man. The simpler nervous arcs can be studied in animals. Though the results of animal experiments in this, as in other problems, may not be uncritically transferred to man, yet the bulk of experimental evidence of the effects of alcohol on the lower arcs may be more economically obtained from animals. The effect of alcohol on the more complex arcs, however, constitutes a preeminently human problem.

Increased difficulties do not lessen scientific obligations; they increase them. They make greater demands on technique, which at any particular stage of technical development operate as limitations of the direction of profitable laboratory experiment. Unfortunately, there is at present scant probability of securing experimental data of scientific reliability with respect to the action of moderate doses of alcohol on the higher mental and moral processes. In our attempt to study systematically related processes, we have chosen such elementary processes as were likely to throw the most light on the more complex. We must choose such relatively complex processes as are related, on the one hand, to the elementary processes that we have already studied, and on the other hand, to the higher processes that are beyond our experimental reach.

The effect of alcohol on reaction processes has been studied chiefly with respect to the so-called simple, discrimination, and choice reactions. These studies began with the experiments of Exner,¹ who found that alcohol increased the duration of reaction time. Dietl and von Vintschgau² made a comparative study of the effects of morphine, coffee, and wine, and found that alcohol decreased the reaction time. Kraepelin³ experimented with amyl nitrite, ether, chloroform, and alcohol and found that moderate doses of alcohol differed from ether and chloroform by first decreasing and then increasing the reaction, while Warren,⁴ in a paper of fine critical acumen and unexcelled statistical

¹Exner, *Archiv f. d. ges. Physiol.*, 1873, **7**, p. 601.

²Dietl and von Vintschgau, *Archiv f. d. ges. Physiol.*, 1878, **16**, p. 316.

³Kraepelin, *Phil. Stud.*, 1883, **1**, p. 573.

⁴Warren, *Journ. Physiol.*, 1887, **8**, p. 311.

treatment of his data, studied the effect of alcohol on the simple reaction only, and found "no general effect of any definiteness."

Pursuant to the principles of selection which determined our choice of measurable processes for these experiments, we felt obliged to omit the traditional simple, discrimination, and choice reactions. They seemed unsatisfactory to us partly because of the entire artificiality of the usual reactions and the necessity for extensive preliminary practice before the reaction times have any real significance, partly because of the uncontrollable interplay of interest and attention and the easy contamination of results by arbitrary and capricious, conscious control, and partly because the best analyses of the various processes show such variability of the possible subjective attitudes to the experiment, that one can be sure of similar experimental conditions only in subjects of the most careful training. Even in trained reactors alcohol might conceivably modify the effect of training rather than the reaction arc itself. Finally, variations in the reaction type, such as motor and sensory reaction, for example, may modify the reaction time more than moderate doses of alcohol have been found to do, and the suspicion of such a subjective variation can not be objectively verified.

Practical reactions involving complex arcs, which are thoroughly practiced and comparable in different individuals without special training, are comparatively few. Of those which might be found, we chose the following for our present series, partly because of the adequacy of the respective techniques and our knowledge of the underlying processes, and partly because of the extensive mental systems which they sample:

(1) Eye-reaction to a suddenly appearing peripheral stimulus is a thoroughly practiced part of the individual's response to his spatial environment. It samples his spatial adjustments.

(2) Speech-reaction to visual word stimuli is a thoroughly practiced part of the individual's response to his social environment. It samples the elaborate mental complex of the speech associations, in one of its primitive and most firmly established phases.

EFFECT OF ALCOHOL ON THE REACTION OF THE EYE TO PERIPHERAL VISUAL STIMULI.

The tendency of the eyes to turn to a suddenly appearing object of interest, whose image falls outside the field of clear vision, is probably the most universal and best practiced reaction of the voluntary muscles. In normal life the line of regard probably never passes through the same point of the field of view for a full second at a time. The records of Judd¹ and his collaborators show that the maintenance of strict fixation is of still shorter duration. Even if the object of interest remains the

¹Judd, McAllister, and Steele, *Yale Psychological Studies*, 1905, new series, **1**, No. 1.

same for a longer interval, Dodge¹ has shown that physiological causes are constantly operating to produce lapsed fixations which must be corrected by frequent eye-reactions. If these primary and corrective reactions have occurred on the average of once a second since birth, the number of eye-reactions of our normal subjects before they reached the psychological laboratory was enormous. In many uses of the eyes, as in reading for example, eye-reactions occur on the average at more than twice that rate. Obviously, the eye-reaction is one which the subject does not have to learn arbitrarily for experimental purposes, like lifting his finger in reaction to a noise or to the appearance of a predetermined color. It is a natural part of his vital equipment—a necessary pre-condition of the effective visual apprehension of his environment. But, as a rule, one is unconscious both of the exact stimulus to movement and of the consequent reaction of the eye. Under such circumstances there can be no distinguishable motor and sensory types. In view of the importance of eye-reaction in normal life, in view of its pre-experimental practice, and its independence of arbitrary voluntary interference and freedom from change of type, the eye-reaction entirely satisfied our criteria of available processes for measurements. The fact that Diefendorf and Dodge² secured comparable measurements of their eye-reactions from a group of over 40 insane patients may be cited as relevant evidence that the experiment does not make exorbitant demands on the coöperation of the subject. Moreover, the elaboration of the motor impulse that carries the eye to an approximately correct position for its new fixation in a single sweep is as well understood as any highly coördinated voluntary act. It has been subjected to an extraordinary amount of psychological and physiological investigation. It involves at least no arbitrarily changing factors. Finally, the photographic technique for recording the eye-reactions is simple, dependable, and accurate.

METHODS FOR RECORDING THE EYE-REACTIONS.

We may pass over without discussion the earlier non-graphic method of measuring the eye-reactions. The first reliable data on the reaction of the eye was given by the blind-spot method.³ It depended on measuring the necessary duration of a light which fell within the blind spot while the eye was at rest, but emerged from the blind spot on to a sensitive part of the retina when the eye moved to see a suddenly appearing peripheral object. If this light was seen its duration must have been greater than the latent time of the eye. If it was not seen its duration was less. Such an experimental method, however accurate, would have been impractical in a study like the present. It is too sub-

¹Dodge, *An Experimental Study of Visual Fixation*. Monograph Supp. of the *Psychol. Review*, No. 35, 1907.

²Diefendorf and Dodge, *Brain*, 1908, 31, p. 451.

³Dodge, *Psychol. Review*, 1899, 6, p. 477.

jective, and makes too large demands on the skill and coöperation of the observer. Objective records are best furnished by photographing the movements of the eye.

Of the available photographic techniques, the kinematographic Chinese-white method of Judd¹ is less adapted to showing time changes in the eye-movements than Dodge's continuous records by reflection from the cornea. The latter is the method which we used in these experiments. For a complete description of its technique as well as for a full discussion of its theory, we must refer to the original papers.²

THEORY OF RECORDING THE MOVEMENTS OF THE EYE BY PHOTOGRAPHING THE MOVEMENT OF A REFLECTION FROM THE CORNEA.

The theory of the corneal reflection method, briefly stated, is that a virtual image from an eccentrically mounted convex spherical mirror will appear to move in the direction of the latter's rotation when the axis of rotation lies behind the center of curvature. Within a small error the surface of the normal healthy cornea is a convex spherical surface. Its optical surface is as exact as the visual process which it conditions. If the radius of the curvature of the cornea were infinitesimal, the apparent movement of the corneal reflection would equal the sine of the arc of eye-movement, measured on a great circle of the eyeball. If, on the other hand, the radius of the cornea were equal to the radius of the eyeball, and the latter rotated on its center of curvature, the corneal reflection would appear to remain stationary. As a matter of fact, neither of the above suppositions is true, and the apparent movement of a corneal reflection actually lies somewhere between zero and the sine of the angular movement of the eyeball. Since the average radius of curvature of the center of the cornea is 7.7 mm. and the distance from its apex to the center of rotation of the eye averages 13.5 mm., the apparent movement of a distant object reflected from near the center of the cornea will be slightly less than one-half the actual displacement of the apex of the cornea, but always in the same direction. More accurately, under the above conditions, the apparent movement of the corneal reflection will be $\frac{13.5-7.7}{13.5} = \frac{5.8}{13.5}$ of the actual movement of the eye for small arcs (Dodge²).

REACTION TIME OF THE EYE.

All adequate data concerning the latent time of the eye-reaction show that it is relatively long. According to the most extensive photographic data hitherto collected, that of Diefendorf and Dodge,³ the normal average latency of the eye-reactions is about 200 σ .

¹Judd, McAllister and Steele, Yale Psychological Studies, 1905, new series, 1, No. 1.

²Dodge, An Experimental Study of Visual Fixation. Monograph Supp. of the Psychol. Review, No. 35, 1907.

³Diefendorf and Dodge, Brain, 1908, 31, p. 451.

On general principles, one might have expected that a reaction which is at once so common and apparently so necessary to the individual in the conduct of life would be short. But it should also be noted that each ocular reaction to peripheral stimuli involves a considerable sensory-motor elaboration of the stimulus. The adequate reacting eye-movement is not only in a definite direction, but it is also of definite extent. The accuracy of the eye-movement does not now concern us, since we measure in reaction time only the beginning of the reactive movement. But the beginning of every eye-movement is really only the initial phase of a movement of definite direction and extent. Before the eye starts to move, the elaboration of definite motor impulses for that particular eye-movement must be complete. In a sense, then, every ocular reaction to a peripheral stimulus is not a simple reaction at all, but an individual's adaptation to a change in his environment. In the past history of reaction, such a reaction would have borne the misleading name of a "choice reaction." The length of the simple ocular reaction consequently is not an anomaly. It corresponds directly with a relatively complex but automatic elaboration of the sensory-motor impulse.

APPARATUS.

RECORDING CAMERA.

The general construction of the apparatus has not changed since it was first described by Dodge and Cline,¹ though many of the details have been improved. The eye-movements are photographed by means of an enlarging camera of fixed length. In its present form it is substantially a wooden box, 4 feet long and 6.5 inches square, but tapering at the lens end. The lens is a Bausch and Lomb convertible protar, series VII, No. 8. Doubtless other lenses would answer the purpose, but the above was specifically recommended by the manufacturer to meet our demands, and proved satisfactory after some disappointing experiences with other types. At the back end of the camera-box, in place of the ordinary plate-holder, is a falling-plate recording-camera.

The mechanism of the recording-camera² is exceedingly simple and particularly adapted for psychological work, since it is noiseless, is quickly changed in speed from 200 mm. per second to less than 1 mm. per second, and reaches its maximum velocity in the first centimeter of fall. It is daylight-loading with commercial plate-holders, and may be used with either film, plate, or paper, according to the available illumination. Finally, an image of the recording light, as it is reflected from the cornea, may be seen on the focusing-glass up to the moment of actual recording. This last is an absolutely essential feature in a camera for recording the eye-movements of untrained subjects.

¹Dodge and Cline, *Psychol. Review*, 1901, 8, p. 145.

²Now made by Spindler and Hoyer.

Two views of the falling-plate recording-camera are shown in figures 10 and 11. Figure 10 represents the back of the instrument, showing the aperture for focusing, a plate-holder partly inserted, the handle of the valve, and a stop for regulating the speed of the plate. Figure 11 is a drawing of the inner construction of the camera. The aperture for inserting the plate-holder when the box is closed is shown at *A*. A shutter closing the recorder completely from the outside light is shown at *S*. The oil cylinder to control the fall of the plate is indicated at *C*. A plunger which is not represented plays in the cylinder.

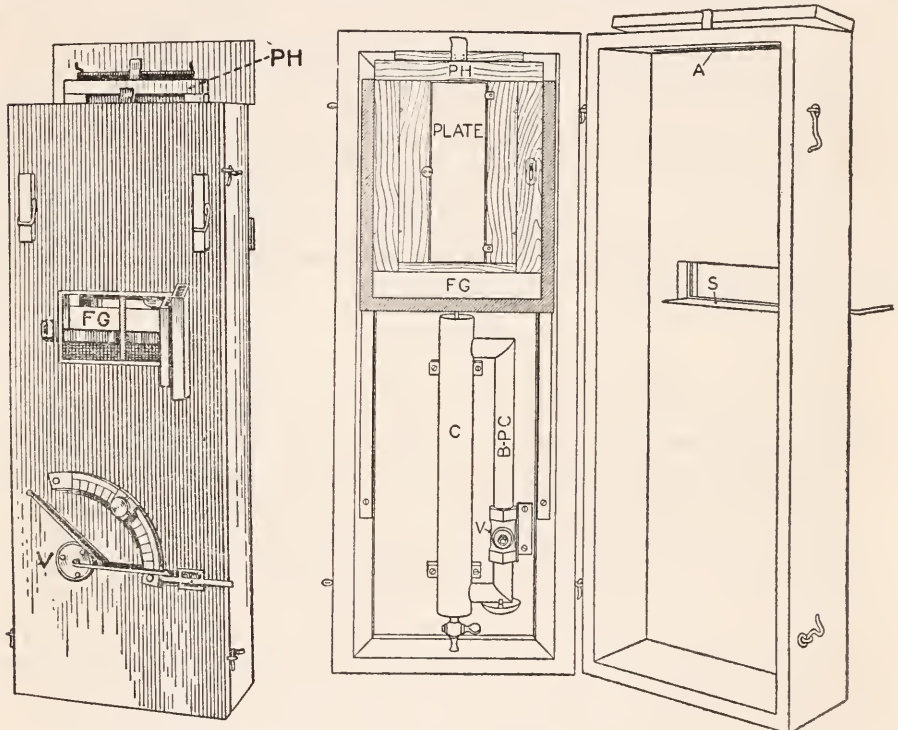

FIG. 10.

FIG. 11.

FIG. 10.—Falling-plate recording-camera.

FIG. 11.—Falling-plate recording-camera (inner construction).

It offers only slight resistance to raising the plate, but prevents its falling, except when valve *V* is open. When the oil is forced out at the bottom of the cylinder *C* it flows back through a by-pass *B-PC* into the top of *C*. The speed of the fall is determined by the size of the opening in the valve *V*. A commercial plate-holder open to expose the plate is shown at *PH*. The focusing screen is shown at *FG*. It is in the same plane as the photographic plate, and stands in front of *S* until the plate begins to fall. The frame which holds the plate-holder runs between two rails with V-shaped furrows. Oscillation of the

plate and plate-holder is taken up, and friction rendered relatively constant by a spring guide on one side of the frame.

HEAD-REST.

For measurements of the time of the eye-movements, a relatively simple head-rest is sufficient. A forehead-rest above, and a mouth-rest, or rest for the upper teeth, make an adequate support in the simplest possible manner.

RECORDING LIGHT.

The best sort of light for recording the eye-movements is an arc light, stopped down by blue glass. In the following experiments we used three thicknesses of blue glass. The consequent light is a soft blue for vision, but is highly actinic. Even direct fixation of this light for several seconds produces an after-image only slightly disturbing to vision. Figure 1 (page 31) shows the general orientation of the source of light and the mirrors which reflected it to the eye of the subject.

EXPOSURE APPARATUS AND STIMULUS.

The exposure of the peripheral stimulus and the beginning of the record were synchronized mechanically. Both were produced by the movement of a single shutter, shown in figure 1 to the subject's right of the enlarging-camera.

The nature of the peripheral stimulus, its position, and the instructions to the subject are not unimportant in the eye-reaction experiments. In experiments with the insane, Diefendorf and Dodge¹ used digits for the peripheral objects. The subjects were requested to read these as quickly as possible after exposure. The reaction of the eyes was thus made an incident in the process of reading. The task was a familiar one and the results were fairly consistent for the same individual. A similar arrangement was adopted in the present series of experiments. Letters were used instead of digits, however. They were typewritten on small, uniform strips of paper, which could be inserted in the object-holder of the exposure apparatus. This object-holder was movable in a horizontal plane, and was placed at a different one of six possible positions before each experiment. The order of these positions varied from record to record and from series to series. But it was the same on all days, alcohol and normal alike.

Some variation of this sort about the prestimulating fixation mark is necessary to prevent anticipatory reactions, which no subject can prevent if he knows exactly where the object is to appear. It is doubtful, however, if our arrangement was the best possible. The six positions are probably too few. There is some apparent tendency for the subject to guess where the next exposure will be. Such guesses are usually clear enough on the records, since there is only one chance in six that the subject will guess correctly, and an incorrect guess will result

¹Diefendorf and Dodge, *Brain*, 1908, **31**, p. 451.

in characteristic corrective movements of the eye. Nevertheless, the possibility of anticipatory reactions is unfortunate. They tend to increase the variability of the results, even though the records clearly show their existence. Moreover, it is not always easy to distinguish a corrective movement which follows a guess from the normal corrective movement which follows inadequate coördination of the eye-muscles. A further objection, which will appear in the discussion of the results, is the surprisingly large effect of repetition. It would probably be better, in the future, to instruct the subject to keep his eye on a fixation mark, and then move the fixation mark in one direction or another as a stimulus to reaction.

TIME RECORDS.

As in our measurements of the lid reflex, time records are incorporated directly into the record of the position of the eye by interrupting the recording beam of light with the vibrator in series with an electrically driven tuning-fork of 50 d. v. per second, as described on page 60. The records taken in this manner are a series of dashes. Each dash represents 0.01''.

EXPERIMENTAL PROCEDURE.

With the subject seated in position 2, with the vibrator and its controlling tuning-fork in operation and the arc light burning steadily, the subject was instructed to assume the position for eye-reaction. The subject then pressed his head gently against the head-rest, which had been adjusted to the proper elevation. The operator inserted the sensitive plate and focused the camera. Before each series began, the operator repeated the standard instruction, "Look at the fixation mark, and read the letters as soon as they appear. Don't try to guess where they will come." About one second after the signal, "Ready," was given, the photographic plate was released and the shutter was dropped. The dropping shutter carried with it the pre-fixation mark, exposed the letter, and simultaneously permitted the recording beam of blue light to reach the eye. After reaction the shutter was raised and the exposure apparatus was reset by an assistant. The operator raised the photographic plate, moved the camera a few millimeters to the left, and repeated the experiment. Five records were made in succession in each period. All five can easily be recorded on the same plate without danger of interference or fogging the plate. At the end of the day's work the plates were unloaded, dated, and numbered. The assistant who read the plates numbered the curves in the order of the experiments, counted the dashes, and noted the corrective movements.

Figure 12 reproduces an illustrative photographic plate containing five records of eye-reactions. Each line of dashes represents an eye-reaction. The beginning of each line is coincident with the exposure of the stimulus to move the eyes. The reaction movement of the eyes is

shown by the first irregularity in the line. The number of dashes from the beginning to the break gives the latent time of the reaction in hundredths of a second. The figure is arranged to read from left to right. The left of the figure really corresponds to the bottom of the photographic record.

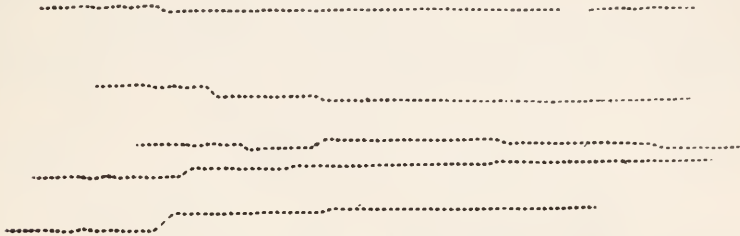

FIG. 12.—Eye-reaction records.

RESULTS.

The data for the eye-reactions are presented in table 7. The left- and right-hand divisions of the page contain the data for normal and alcohol experiments, respectively. In each half the first column gives the subject, date, and number of the experimental period. The second column contains the average latent times for each period of the experimental session and the general average of the session. The mean variation of each period and the average mean variation of the session are given in the next column. In the column headed Differences are entered at the left the differences between the first and each succeeding period, according to the formula, $D = 1-2, 1-3, 1-4$, etc. Similarly, the Differences between the mean variations of the succeeding periods are entered at the right.

TABLE 7.—*Latency of the eye-reactions.*
 [Values given in thousandths of a second.]

Normal.					Alcohol.				
Subject, date, and number of period.	Average.	Mean variation.	Difference (1-2, 1-3, etc.).		Subject, date, dose, and number of period.	Average.	Mean variation.	Difference (1-2, 1-3, etc.).	
			Average.	Mean variation.				Average.	Mean variation.
<i>Subject II.</i>					<i>Subject II.</i>				
Nov. 14, 1913:					Nov. 20, 1913:				
1.....	248	43	Dose A:				
2.....	272	44	-24	- 1	1.....	(¹)	(¹)
3.....	245	6	+ 3	+37	2.....	217	9
4.....	236	29	+12	+14	3.....	215	10
Average.....	250	30	- 3	+17	4.....	262	29
Mar. 17, 1914:					Average.....				
1.....	208	33	5.....	242	29
2.....	202	8	+ 6	+25	Average.....				
3.....	218	25	-10	+ 8	234 19				
4.....	203	27	+ 5	+ 6	<i>Subject III.</i>				
5.....	194	41	+14	- 8	Jan. 26, 1914:				
6.....	199	14	+ 9	+19	Dose A:				
7.....	208	35	0	- 2	1.....	² 201	² 25
Average.....	205	26	+ 4	+ 8	2.....	230	42	- 29	-17
<i>Subject III.</i>					3.....				
Jan. 19, 1914:					249 21 - 48 + 4				
1.....	(³)	(³)	4.....				
2.....	191	28	215 0 - 14 +25				
3.....	201	23	-10	+ 5	Average.....				
4.....	187	18	+ 4	+10	231 21 - 30 + 4				
Average.....	193	23	- 3	+ 7	<i>Subject III.</i>				
Mar. 9, 1914:					Jan. 26, 1914:				
1.....	187	7	Dose A:				
2.....	179	7	+ 8	0	1.....	² 203	² 26
3.....	173	27	+14	-20	2.....	186	23	+ 17	+ 3
Average.....	179	14	+11	-10	3.....	193	5	+ 10	+21
<i>Subject IV.</i>					4.....				
Jan. 30, 1914:					103 18 + 20 + 8				
1.....	217	22	6.....				
2.....	185	17	+32	+ 5	18 18 + 22 + 8				
3.....	192	25	+25	- 3	Average.....				
4.....	193	14	+24	+ 8	187 16 + 16 +10				
5.....	210	30	+ 7	- 8	<i>Subject IV.</i>				
Average.....	199	22	+22	+ 0.5	Feb. 9, 1914:				
Mar. 17, 1914:					Dose B:				
1.....	193	21	1.....	² 177	² 15
2.....	160	22	+33	- 1	2.....	163	20	+ 14	- 5
3.....	174	7	+19	+14	3.....	190	12	- 13	+ 3
4.....	190	20	+ 3	+ 1	4.....	185	12	- 8	+ 3
5.....	200	18	- 7	+ 3	Average.....				
Average.....	183	18	+12	+ 4	179 15 - 2 +0.3				
<i>Subject IV.</i>					<i>Subject IV.</i>				
Jan. 30, 1914:					Feb. 13, 1914:				
1.....	217	22	Dose B: ⁴				
2.....	185	17	+32	+ 5	1.....	² 177	² 17
3.....	192	25	+25	- 3	2.....	190	11	- 13	+ 6
4.....	193	14	+24	+ 8	3.....	181	16	- 4	+ 1
5.....	210	30	+ 7	- 8	4.....	180	0	- 3	+17
Average.....	199	22	+22	+ 0.5	Average.....				
Mar. 17, 1914:					184 9 - 7 + 8				
1.....	193	21	<i>Subject IV.</i>				
2.....	160	22	+33	- 1	Feb. 13, 1914:				
3.....	174	7	+19	+14	Dose B: ⁴				
4.....	190	20	+ 3	+ 1	1.....	² 177	² 17
5.....	200	18	- 7	+ 3	2.....	190	11	- 13	+ 6
Average.....	183	18	+12	+ 4	3.....	181	16	- 4	+ 1

¹Records illegible.

²The values for the first period of the alcohol experiments were obtained before the alcohol was given and are therefore not included in the averages.

³Missing.

⁴Experiment with dose A was accidentally omitted.

TABLE 7.—*Latency of the eye-reactions*—Continued.
[Values given in thousandths of a second.]

Normal.					Alcohol.				
Subject, date, and number of period.	Average.	Mean variation.	Difference (1-2, 1-3, etc.).		Subject, date, dose, and number of period.	Average.	Mean variation.	Difference (1-2, 1-3, etc.).	
			Average.	Mean variation.				Average.	Mean variation.
<i>Subject VI.</i> Oct. 22, 1913:					<i>Subject VI.</i> Oct. 29, 1913:				
1.....	(¹)	(¹)	Dose A:				
2.....	200	20	1.....	² 166	² 23
3.....	197	12	+ 3	+ 8	2.....	145	22	+ 21	+ 1
4.....	192	30	+ 8	-10	3.....	147	10	+ 19	+13
5.....	227	26	-27	- 6	4.....	(³)	(³)
6.....	230	20	-30	0	5.....	158	28	+ 8	- 5
Average.....	209	22	-11	- 2	6.....	190	35	- 24	-12
					Average.....				
					159				
					24				
					+ 6				
					- 0.7				
					Jan. 22, 1914:				
					Dose B:				
					1.....				
					² 185				
					² 20				
								
					2.....				
					180				
					25				
					+ 5				
					- 5				
					3.....				
					199				
					27				
					- 14				
					- 7				
					4.....				
					195				
					25				
					- 10				
					- 5				
					5.....				
					200				
					16				
					- 15				
					+ 4				
					6.....				
					255				
					45				
					- 75				
					- 25				
					Average.....				
					206				
					28				
					- 22				
					- 8				
					12 hr. experiment.				
					Jan. 2, 1914:				
					Dose C:				
					1.....				
					² 176				
					² 17				
								
					2.....				
					169				
					33				
					+ 7				
					-16				
					3.....				
					199				
					43				
					- 23				
					-26				
					4.....				
					223				
					34				
					- 47				
					-17				
					5.....				
					171				
					31				
					+ 5				
					-14				
					6.....				
					185				
					20				
					- 9				
					- 3				
					7.....				
					171				
					34				
					+ 5				
					-17				
					8.....				
					189				
					9				
					- 13				
					+ 8				
					9.....				
					190				
					42				
					- 14				
					-25				
					10.....				
					198				
					38				
					- 22				
					-21				
					11.....				
					194				
					25				
					- 18				
					- 8				
					Average.....				
					189				
					31				
					- 13				
					-14				
					<i>Subject VII.</i>				
					Oct. 28, 1913:				
					Dose A:				
					1.....				
					² 223				
					² 16				
								
					2.....				
					195				
					8				
					+ 28				
					+ 8				
					3.....				
					197				
					9				
					+ 26				
					+ 7				
					4.....				
					214				
					11				
					+ 9				
					+ 5				
					5.....				
					192				
					22				
					+ 31				
					- 6				
					6.....				
					232				
					22				
					- 9				
					- 6				
					Average.....				
					206				
					14				
					+ 17				
					+ 1.6				
					Mar. 20, 1914:				
					Dose B:				
					1.....				
					² 199				
					² 24				
								
					2.....				
					191				
					39				
					+ 8				
					-15				
					3.....				
					242				
					21				
					- 43				
					+ 3				
					4.....				
					241				
					45				
					- 42				
					-21				
					Average.....				
					225				
					35				
					- 26				
					-11				

¹Records illegible.

²The values for the first period of the alcohol experiments were obtained before the alcohol was given and are therefore not included in the averages.

³No record.

TABLE 7.—*Latency of the eye-reactions*—Continued.

[Values given in thousandths of a second.]

Normal.					Alcohol.				
Subject, date, and number of period.	Average.	Mean variation.	Difference (1-2, 1-3, etc.).		Subject, date, dose, and number of period.	Average.	Mean variation.	Difference (1-2, 1-3, etc.).	
			Average.	Mean variation.				Average.	Mean variation.
<i>Subject IX.</i> Oct. 27, 1913:					<i>Subject IX.</i> Nov. 3, 1913:				
1.....	286	74			Dose A:				
2.....	190	34	+96	+40	1.....	¹ 345	¹ 78		
3.....	198	18	+88	+56	2.....	256	87	+ 89	- 9
4.....	201	21	+85	+53	3.....	197	16	+148	+62
5.....	204	40	+82	+34	4.....	181	29	+164	+49
Average.....	216	37	+88	+46	5.....	202	16	+143	+62
					Average.....	209	37	+136	+41
					Jan. 21, 1914:				
					Dose B:				
					1.....	¹ 161	¹ 33		
					2.....	156	15	+ 5	+18
					3.....	201	9	- 40	+24
					4.....	202	20	- 41	+13
					5.....	170	17	- 9	+16
					6.....	182	16	- 21	+17
					Average.....	182	15	- 21	+18
					<i>12 hr. experiment.</i> Dec. 23, 1913:				
					Dose C:				
					1.....	¹ 167	¹ 18		
					2.....	180	35	- 13	-17
					3.....	184	17	- 17	+ 1
					4.....	173	24	- 6	- 6
					5.....	162	17	+ 5	+ 1
					6.....	160	10	+ 7	+ 8
					7.....	198	41	- 31	-23
					8.....	213	12	- 46	+ 6
					9.....	220	20	- 53	- 2
					10.....	193	22	- 26	- 4
					11.....	(?)	(?)		
					Average.....	187	22	- 20	- 4
					<i>Subject X.</i> Mar. 11, 1914:				
					Dose A:				
					1.....	¹ 240	¹ 32		
					2.....	230	23	+ 10	+10
					3.....	327	31	- 87	+ 1
					4.....	216	4	+ 24	+28
					5.....	235	25	+ 5	+ 7
					6.....	206	11	+ 34	+21
					Average.....	243	19	- 3	+13
					<i>Subject X.</i> Mar. 18, 1914:				
					Dose A:				
					1.....	¹ 240	¹ 32		
					2.....	230	23	+ 10	+10
					3.....	327	31	- 87	+ 1
					4.....	216	4	+ 24	+28
					5.....	235	25	+ 5	+ 7
					6.....	206	11	+ 34	+21
					Average.....	243	19	- 3	+13

¹The values for the first period of the alcohol experiments were obtained before the alcohol was given and are therefore not included in the averages.

²Records illegible.

TABLE 7.—*Latency of the eye-reactions—Continued.*
 [Values given in thousandths of a second.]
 PSYCHOPATHIC SUBJECTS.

Normal.					Alcohol.				
Subject, date, and number of period.	Average.	Mean variation.	Difference (1-2, 1-3, etc.).		Subject, date, dose, and number of period.	Average.	Mean variation.	Difference (1-2, 1-3, etc.).	
			Average.	Mean variation.				Average.	Mean variation.
<i>Subject XI.</i>					<i>Subject XI.</i>				
Mar. 26, 1914:					Mar. 27, 1914:				
1.....	220	23	Dose A:				
2.....	279	69	-59	-46	1.....	¹ 221	¹ 29
3.....	251	27	-31	-4	2.....	222	51	-1	-22
Average.....	250	39	-45	-25	3.....	259	19	-38	+10
Mar. 28, 1914:					4.....	212	35	+9	-6
1.....	242	21	Average.....	231	35	-10	-6
2.....	211	13	+31	+8	<i>Subject XII.</i>				
3.....	205	17	+37	+4	Apr. 2, 1914:				
Average.....	219	17	+34	+6	1.....	178	28
<i>Subject XII.</i>					2.....	162	19	+16	+9
Apr. 2, 1914:					3.....	150	24	+28	+4
1.....	178	28	4.....	187	30	-9	-2
2.....	162	19	+16	+9	5.....	141	22	+37	+6
3.....	150	24	+28	+4	Average.....	164	25	+18	+4
4.....	187	30	-9	-2	Apr. 4, 1914:				
5.....	141	22	+37	+6	1.....	178	49
Average.....	164	25	+18	+4	2.....	164	19	+14	+30
Apr. 4, 1914:					3.....	209	43	-31	+6
1.....	178	49	Average.....	184	37	-8	+18
2.....	164	19	+14	+30	<i>Subject XIV.</i>				
3.....	209	43	-31	+6	Apr. 24, 1914:				
Average.....	184	37	-8	+18	Dose A:				
<i>Subject XIV.</i>					1.....	¹ 212	¹ 37
Apr. 23, 1914:					2.....	190	24	+22	+13
1.....	240	30	3.....	215	20	-3	+17
2.....	222	2	+18	+28	4.....	196	23	+16	+14
3.....	202	36	+38	-6	5.....	198	8	+14	+29
4.....	238	29	+2	+1	6.....	203	12	+9	+25
Average.....	225	24	+19	+8	Average.....	200	17	+12	+20
Apr. 25, 1914:									
1.....	195	40					
2.....	200	12	-5	-28					
Average.....	197	26					

¹The values for the first period of the alcohol experiments were obtained before the alcohol was given and are therefore not included in the averages.

TABLE 8.—Summary of the latent time of the eye-reactions.
[Values are given in thousandths of a second.]

Subject.	Normal.					Alcohol.					
	I		II		Average difference.	Dose A. ¹			Dose B.		
	Average.	Mean variation.	Average.	Mean variation.		Average.	Mean variation.	Average difference.	Average.	Mean variation.	Average difference.
Normal subjects:											
II.....	250	30	205	26	0	234	19	231	21	-30
III.....	193	23	179	14	+ 4	187	16	+ 16	179	15	- 2
IV.....	199	22	183	18	+17	184	9	- 7
VI.....	209	22	-11	159	24	+ 6	206	28	-22
VII.....	218	17	204	23	- 7	206	14	+ 17	225	35	-26
IX.....	216	37	+88	209	37	+136	182	15	-21
X.....	225	23	+34	243	19	- 3
Average...	216	25	193	20	206	21	201	20
12 hr. experiments:											
VI.....	196	23	+38	¹ 189	¹ 31	¹ - 13
IX.....	179	15	-17	¹ 187	¹ 22	¹ - 20
Average...	187	19	188	26
Psychopathic subjects:											
XI.....	250	39	219	17	- 5	231	35	- 10
XII.....	164	25	184	37	+ 5	168	24	+ 33
XIV.....	225	24	197	26	+ 7	200	17	+ 12
Average...	213	29	200	27	199	25

¹Dose C was used in the 12-hour experiments.

TABLE 9.—Summary of the effect of alcohol on the latent time of the eye-reactions.
[Average values given in thousandths of a second.]

Subject.	Effect as shown in average differences. ¹			Effect as shown in percentile differences. ²		
	Dose A.	Dose B.	Dose C.	Dose A.	Dose B.	Dose C.
Normal subjects:	σ	σ	σ	<i>p. ct.</i>	<i>p. ct.</i>	<i>p. ct.</i>
II.....	- 30	-13.7
III.....	+12	- 6	+ 6.2	- 3.2
IV.....	- 24	-12.2
VI.....	+17	- 11	+ 9.3	- 6.0
VII.....	+24	- 19	+11.1	- 9.3
IX.....	+48	-109	+15.2	-49.0
X.....	-37	-15.0
Average...	+13	- 33	+ 5.4	-15.6
12 hr. experiments:						
VI.....	-51	-25.1
IX.....	- 3	- 1.8
Average...	-27	-13.4
Psychopathic subjects:						
XI.....	- 5	- 2.2
XII.....	+28	+15.0
XIV.....	+ 5	+ 2.3
Average...	+ 9	+ 5.0

¹Effect on the average difference equals (av. 1-2, 1-3, 1-4, etc., alcohol) minus (av. 1-2, 1-3, 1-4, etc., normal).

²Effect on the percentile difference equals average difference divided by average of the corresponding first periods.

SUMMARY OF EYE-REACTION DATA.

A summary of the latent time of the eye-reactions, as well as the average differences, is given in table 8. The first and second normal days are shown on the left, the two alcohol days on the right. The other headings are self-explanatory.

A summary of the effect of alcohol on the eye-reactions is given in table 9, calculated from the differences. On the left the effect is shown in the units of measurement. On the right it is shown in percentiles.

VARIABILITY OF THE MEASUREMENTS.

Inspection of the averages and mean variations of table 8 will throw considerable light on the reliability of this group of measurements: (1) In the first place, it will be noticed that the average mean variation of eye-reaction is about 12 per cent of the average of the measurements. In interpreting this variability it should be borne in mind that, with the exception of Subject VI, none of the subjects had ever served in similar experiments. We regard it as a conspicuous service of the eye-reactions that they furnished us comparable "choice reaction" data with an average mean variation of approximately 12 per cent from a heterogeneous group of subjects without previous training. No other "choice reaction" with which we are acquainted is so uniformly available. (2) As appears from the table of average reactions, there is a slight but regular improvement in the average reaction time of all subjects as the experiments progress. The averages show a total reduction of 23σ for the main group and 13σ for the psychopathic group between the first and last normal days. The only exception is the second normal day of Subject XII, which prevents the average of the psychopathic subjects from showing any advantage of repetition on the second normal day as compared with the alcohol day. Notwithstanding this exception, the facts are unequivocal. The average latent time of the eye-reactions decreases by an average of about 11 per cent from the first to the last experimental day as a result of repetition. A regular practice effect of 11 per cent between the first and last quarters of 120 measurements clearly shows that the process was not initially as thoroughly practiced as we had expected, *i. e.*, to the degree that the practice effect of the experimental sessions would be insignificant. The question of the origin of the effect of repetition in the case of the supposed thoroughly practiced eye-reaction, and the possibility of adopting suitable experimental measures to reduce it, will be taken up again in the summary, Chapter IX.

We would point out here that, notwithstanding the obvious effect of repetition, our normal base-line is adequate for any interpretation of the effect of alcohol. The experimental as well as the statistical procedure of these experiments was especially planned for just such exigencies.

EFFECT OF ALCOHOL ON THE EYE-REACTION.

Following our regular procedure of calculating the effects of alcohol from the differences between the normal of the day and subsequent periods, it appears from table 9 that the average effect of the smaller dose of alcohol (dose A) is to decrease the reaction time in four cases out of five, amounting to an average change of 13σ or 5.4 per cent. The effect of the larger dose of alcohol (dose B), on the other hand, is a lengthening of the reaction time, in all six subjects, by 33σ , or 15.6 per cent. The psychopathic subjects show a slight (5 per cent) decrease of latency like the main group after similar dosage. The effect of the 12-hour experiments (dose C) is an increase of the reaction time in both subjects, but the increase in the case of Subject IX is too slight to be significant.

In general one must conclude that a dose of 45 c.c. of alcohol clearly increases the latency of the eye-reactions. The effect of 30 c.c., on the contrary, seems to be in the opposite direction. This corresponds rather closely with the results of the simple reaction experiments by Kraepelin. In conjunction with the data from other sources, we shall discuss in the general summary (Chapter IX) whether or not our data warrant the conclusion that the two doses of alcohol really affect the complex nervous arc which is involved in eye-reaction in opposite ways.

EFFECT OF ALCOHOL ON THE REACTION-TIME IN READING
ISOLATED WORDS.

There are very few mental operations which are comparable with the reflexes in uniformity; very few that may be assumed to be even approximately equally practiced in the experience of different individuals. Probably the most nearly common element in the intellectual experience of normal individuals in literate communities is the association between visual, auditory, and motor symbols in language and the associations of elementary mathematics.

The computation experiments of Kraepelin and his pupils make use of this community of elementary mathematical experience to measure the effect of alcohol on controlled associations. But common experience, as well as laboratory experiment, makes it obvious that even in the associations of elementary mathematics there are gross differences in the facility with which different individuals react to different combinations. Even in the same subject, provided he is not specially practiced, the difficulty of relatively simple mathematical tasks may vary enormously. For example, the multiplication of 8×5 is commonly a readier association than that of 8×7 . Similarly $9 + 9$ is commonly readier than $7 + 6$. The practice effects are, moreover, often enormous.

Compared to even the simpler association tasks of mental arithmetic, the association process which is involved in reading short, familiar words seems easy to most subjects. For the average literate it is also probably better practiced. Reading should consequently be a reaction

in which the different individuals are comparable with each other and relatively stable with respect to the effect of repetition. It may be objected that actual articulation in reading is less common in adults than silent reading. While that is undoubtedly true, it must be remembered that the restraint of articulation is a refinement of development. Reading was learned by actual articulation. And the passing of silent reading into articulation occurs on the least provocation and in the aggregate relatively often. In any event, the arousal of the motor-acoustic residua is practically a universal if not a necessary accompaniment to the process of understanding the printed word. The nervous arcs which are involved in the articulation of familiar words are relatively complex, but they are relatively constant and thoroughly practiced. Of all the controlled associations, reading is probably the most nearly immediate and universally practiced. Even in a mathematical reaction the first associate which is aroused by digits, 7 times 8, for example, is probably not their multiple, but the auditory-motor associate which is involved in reading them.

Other things being equal, reading simple words appeared to satisfy our criteria of a satisfactory experimental process better than adding or any other mathematical task. Furthermore, the basal psychology of the reading process has been subject to much more satisfactory analysis than the mathematical processes. The adequate reaction to visual verbal stimuli is about the best understood of all associations. It has been experimentally studied in connection with a considerable variety of mental processes, both normal and abnormal. It has furnished material for a large number of investigations in the psychology of perception and attention. The conditions which determine satisfactory experimentation are consequently thoroughly known and the criteria of a satisfactory technique are entirely familiar to the experimental psychologist. In all these respects, the inclusion of word-reaction measurements in our series has been justified. In none of the measurements, not even in the reflexes, have we found a lower percentage of variation within a series of observations. Notwithstanding the differences between the words, the mean variation in a series of 24 is about 7 per cent of the reaction time. The same series of 24 four-letter English words was reacted to in all our experiments by all our subjects, regular and control subjects alike.

EXPOSURE APPARATUS.

The variety of possible instruments for giving visual stimuli under experimental conditions is practically limitless. Equally limitless are the experimental conditions which they may be required to satisfy. There is probably no one best universal exposure apparatus. No such instrument is equally good for all purposes. Any instrument is good if it satisfies the specific experimental demands of the occasion. Between

approximately equally good instruments there may be a further criterion of expediency. Experimental psychologists have spent, in the aggregate, an unduly large amount of time in developing various types of exposure apparatus to satisfy various experimental demands. The excuse for using a new form in these experiments was a new combination of experimental demands and expediency.

The most generally recognized criteria of a satisfactory exposure apparatus¹ relate to the type called the tachistoscope. But the demand for tachistoscopic exposure, that is, for the most rapid possible exposure, is certainly not universal. It has probably been overvalued where it is most useful, that is, in the effort to isolate a single act of vision. It is entirely possible to produce experimental circumstances in which extreme shortness of exposure and consequent uncontrolled adequacy of exposure may be quite undesirable. This is doubtless the case in memory experiments. We believe that it is also the case in all association experiments, where the first condition of a satisfactory association process would seem to be the least practicable interference with the normal and adequate perception of the stimulus word.

If it is true in reading, as the evidence seems to point, that the normal visual perception of a word is a complex of stimulation and inhibition processes which may be more or less separated in time (Dodge,² pp. 55-60), it would seem that the most satisfactory condition for the reading reaction would be to combine all the processes in the same instant, as far as practicable, and to increase to a maximum the visual controls that ordinarily complete the process which is begun in the prefixational perception of a word. In other words, the stimulus word of adequate size should appear suddenly, after a signal, all at once, in the field of clear vision, with provision for satisfactory adaptations to distance and illumination. After adequate exposure the persistence of the stimulus word has relatively little or no significance. It may serve a useful function as a control for misperception.

Our experimental requirements distinctly excluded the tachistoscope type of apparatus. Our positive instrumental demands may be summarized as follows: (1) In order to exclude disturbing pre-judgments from partial visual exposure, and to give a definite amount of total exposure, the exposure should be rigidly simultaneous and as nearly instantaneous as possible (*cf.* Erdmann and Dodge³). (2) To facilitate the calculation of latency, the moment of total exposure should be related in some constant way to a registrable process. (3) The obvious visual requirements of adaptation to illumination and to the place of exposure in all dimensions must not be transgressed. (4) Since the

¹Whipple, *Mental and Physical Tests*, Baltimore, 1910, p. 223.

²Dodge, *An Experimental Study of Visual Fixation*. Monograph Supp. of the Psychol. Review, No. 35, 1907.

³Erdmann and Dodge, *Psychologische Untersuchungen über das Lesen*, Halle, 1898, p. 94.

same experimental conditions must be used for a large variety of subjects with very different natural adaptability, the demands on the subject must be definite and simple. Disturbing influences must be reduced where they can not be eliminated. Conditions must be as natural as possible. (5) Finally, since we aimed to concentrate apparatus and technique so that the different experiments should follow with minimum loss of time and a minimum change in the position of the subject, elaborate or bulky apparatus was inexpedient.

The instrument which was devised to meet these conditions was not an accident. Back of it are some years of effort to produce the perfect exposure of a word without eye-movements, which accurately duplicates a normal fixation in reading. The instrument is in no sense a tachistoscope. It makes no pretense to satisfy all the desiderata of a perfect exposure apparatus. It does satisfy our particular experimental needs without serious defects. One new principle involved in its construction will doubtless be of general use, namely, the pendulum stop. It is a device to stop rapid movements of an object suddenly, but with as little noise and as little vibration as is possible.

In type, our exposure apparatus is characterized by a rapid movement of the visual field like the Erdmann-Dodge¹ gravity tachistoscope or the commercial models of Ranschburg, Wirth, and Rupp memory apparatus, or the disk instrument of Dodge.² The principle of this type of apparatus is to place the fixation marks and the stimulus word on the same surface, which suddenly and rapidly moves, at the moment of stimulation, to replace the insignificant fixation mark by the significant stimulus object in the field of clear vision. Since a word is entirely illegible to the motionless eye while it is in rapid motion across the field of vision, the exposure is simultaneous in all parts when the movement ceases. Complete adaptation to distance and light is preserved from prestimulation to stimulation period, by identity of background and identity of the plane of the fixation mark and the exposed word. The moment of exposure is the moment of stopping.

The great difficulty in constructing apparatus of this type has always been to effect the sudden stop without undue noise or disturbing vibration of the exposed word. To meet this difficulty is the function of our new device, the pendulum stop. Most of the stops in common use involve considerable noise. If the stop is padded to prevent noise, it is practically sure to produce a rebound or vibration, with consequent blurring of the exposed word during the first moment of exposure. If the end-movement is damped by oil or air cushion, the moment of exposure is apt to become uncertain. The pendulum stop obviates or minimizes all these sources of disturbance.

¹Erdmann and Dodge, *Psychologische Untersuchungen über das Lesen*, Halle, 1898.

²Dodge, *An Experimental Study of Visual Fixation*. Monograph Supp. of the *Psychol. Review*, No. 35, 1907.

Our exposure apparatus is pictured in figure 13. It operates as follows: Behind a suitable screen, which is pierced by an aperture, *A*, about twice the size of the words to be exposed, is hung a light horizontal arm *OB*. One end of the arm *OB* is pivoted, so that the other end—the free end—may move past the aperture in the screen. The free or moving end carries the cards on which are printed a fixation mark and a stimulus word. The fixation mark is held in front of the aperture during the pre-exposure interval by a magnet acting on the armature *AR*. An automatic circuit-breaker attached to the shaft of the kymograph (fig. 14) breaks the circuit of the electro-magnet and releases the free end of the arm at a given point in each revolution. The arm stops at a point to expose the word in the middle of the aperture. The required acceleration of the arm is produced by a quick-acting spring.

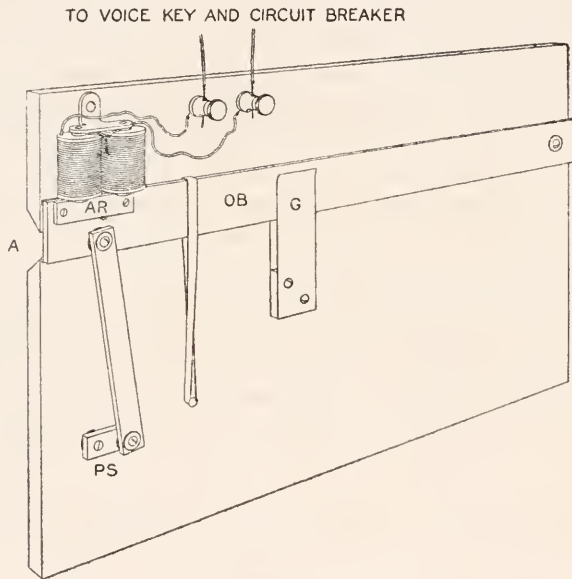

FIG. 13.—Diagram of pendulum-stop exposure apparatus.

The arm is stopped quickly and quietly at the right spot for optimum exposure of the word by the previously mentioned pendulum stop, as follows: A rigid lever connects the free end of the arm with a short pendulum, *PS*, whose length is exactly the distance that the arm must move to produce a proper exposure. When the arm is at rest in the pre-exposure position, this short pendulum is horizontal. As the arm moves into the exposure position, the short pendulum becomes vertical. The pendulum is exceedingly light, so that there may be no tendency for it to go beyond the position of equilibrium. In our instrument the length of the pendulum was 13 mm. With this device the movement of the arm is exceedingly uniform and the otherwise inevitable, regularly increasing acceleration is prevented by the increasing resistance of the pendulum component of the compound system. The stop is

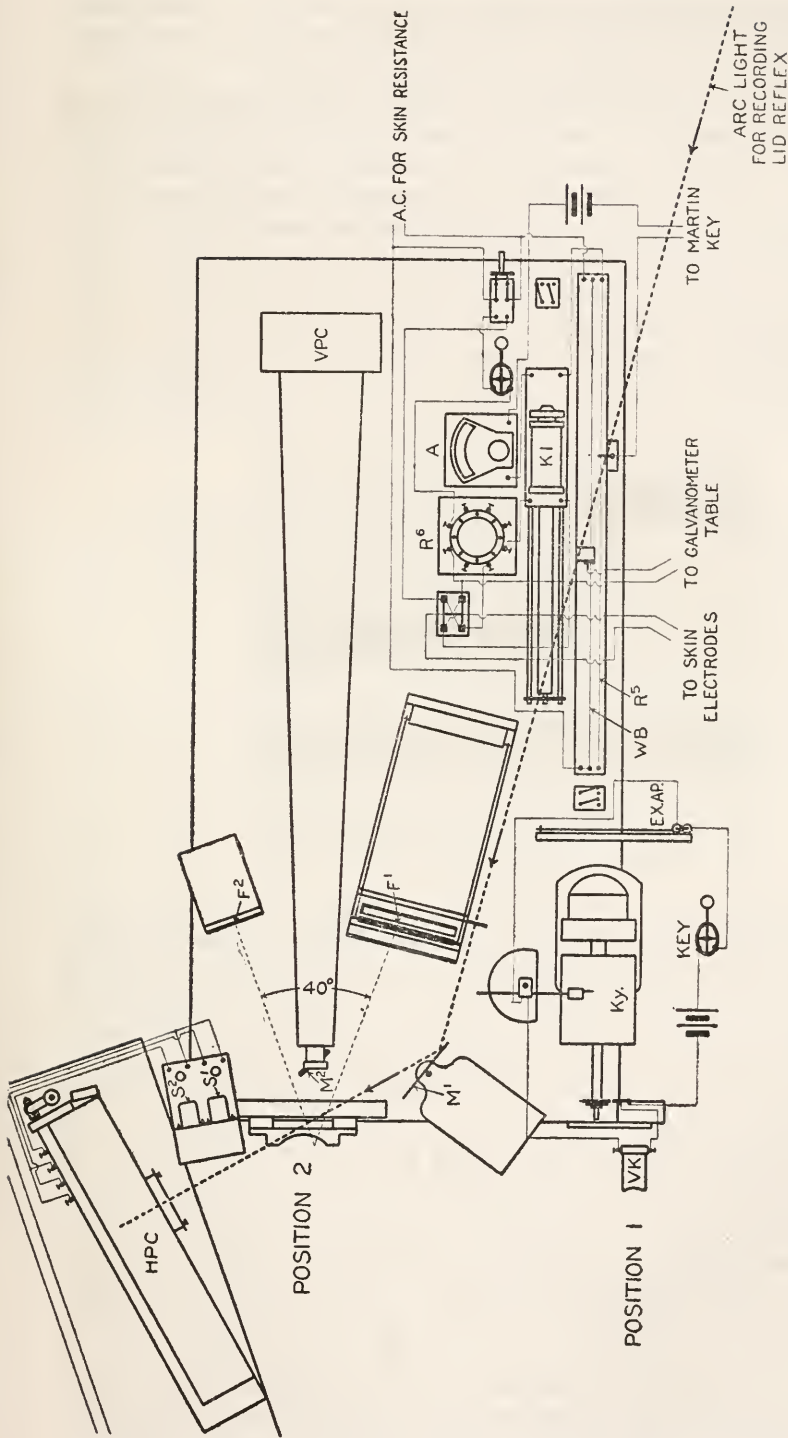

FIG. 14.—Diagram of apparatus for Faradic threshold, word-reaction, lid-reflex, and eye-movement.

A, ammeter in the inductorium circuit; A.C., leads to small inductorium supplying the alternating current for measuring the skin-resistance; EX. A.P., exposure apparatus for word-reactions; F^1 and F^2 , first and second fixation-marks, respectively, for eye-movements of 40° ; HPC, horizontal photographic recording camera for the lid-reflex; KI, inductorium; Ky, Blix-Sandström kymograph for recording the word reactions; M^1 and M^2 , mirrors for deflecting the recording light either to the eye for the eye-movement records or across the eye-lashes for the lid-reflex records; R^6 , fine resistance for modifying the amount of current in the primary coil of the inductorium; R^8 , resistance-box for measuring the skin resistance and for increasing the resistance of the secondary circuit by definite steps; S^1 and S^2 , sound-stimulus hammers for eliciting the lid-reflex; VK, voice-key for the word-reactions; VPC, vertical photographic camera for recording the eye-movements; WB, Wheatstone bridge for measuring the skin resistance.

produced when the pendulum reaches a vertical position. Rebound is impossible, because the pendulum in the vertical position is at a dead-point with respect to the direction of the applied forces.

The accompanying record (fig. 15) is one of a series which was made to measure the latency of the drop and the character of the stop. These records were taken in the following manner: The apparatus was set up before the vertical slit of a photographic recording-camera. A word was exposed exactly as during the experiments, except that a light marker was attached to the free end of the movable arm. This marker made the shadow record *A* (fig. 15). The horizontal ordinates are approximately 2 mm. apart. The vertical ordinates are produced by the vibrator interrupting the recording beam of light 100 times a second. Line *S* was made by the shadow of a Deprez signal in circuit

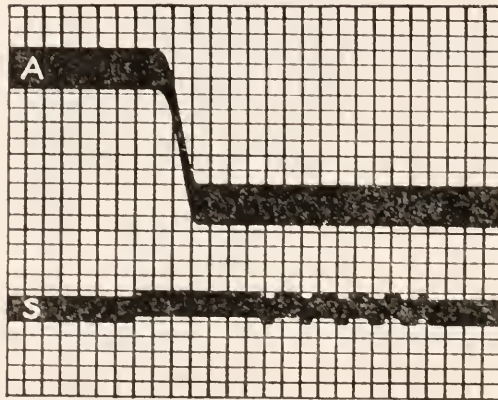

Fig. 15.—Record showing latency of the pendulum-stop exposure apparatus.

parallel with the circuit of the recorder. The break in the circuit which releases the magnet of the exposure apparatus also moves the signal. The latency of the exposure apparatus from the moment when the current is broken to the moment of exposure is seen to be slightly over 0.035 second. A series of 11 records gave an average instrumental latency of 0.0362 second; mean variation 0.0006 second. It may be objected that an instrumental latency of 36σ is a grave technical defect in reaction experiments. Against such an objection we must urge: (1) that an instrumental latency which is known, and known to be constant within the limits of accuracy that are prescribed by the experimental requirements, can not affect the value of any measurement, since it may be simply subtracted from the results, leaving the measurements free from instrumental factors; (2) particularly in comparative records, an instrumental constant can not hide or distort the experimental tendency. Inspection of the shadow record (line *A*, fig. 15), which is produced by the movement of the arm, shows that there is a very short period of positive acceleration, succeeded by a rapid movement at practically uniform speed for the greater part of the angle of

displacement. The movement terminates abruptly, absolutely without rebound or secondary vibration. Inspection of the curve at the moment of stopping shows that the transition from the most rapid movement to complete rest occurs in about 0.002". The exposure is not absolutely noiseless. It seems to begin with a light swish and ends with a light thud. Neither noise bears any resemblance to the usual noisy stop of the spring or the gravity tachistoscope. Granting its reasonable fulfillment of the main criteria of a satisfactory exposure apparatus, the chief advantage of this form over the camera tachistoscope of Erdmann-Dodge,¹ the transparent-mirror tachistoscope of Dodge,² and other satisfactory instruments, is its simplicity and compactness. None of these forms could have been used in our complex of instruments without serious inconvenience to the operator or subject or both. All of them are relatively bulky, and in our experimental arrangements space was a valuable asset.

VOICE-REACTION KEY.

Considerably more difficult of construction than an adequate exposure apparatus is an adequate reaction key for vocalization. We know of no even relatively good reaction key for recording the movements of the vocal organs. Movements of the chin, lips, tongue, and larynx may each be recorded separately, as is commonly done in experimental phonetics. But there is no one key for them all. The familiar voice keys of Kraepelin,³ Cattell,⁴ Erdmann-Dodge,¹ Römer,⁵ and others frankly surrender the effort to register the muscle-action of articulate speech in favor of the consequent air-movements. But this is a questionable expedient, unless due precautions are taken to render it innocuous. Voice keys depend on the expiration of air involved in utterance, to break an electric contact. Unfortunately, the chronological place of the expiration of air in the total physiological process of utterance is very different for different words. Consequently, no air-current key can ever register in any reliable way the real beginning of the vocalization reaction. In most experimental investigations, however, this is not a material source of error. If one seeks the relative efficiency of the vocalization process under varying conditions, and if one uses a definite, unchanging series of stimulus words, such as our group of words was, the precise beginning of muscular reaction is relatively unimportant. For studying the effect of a drug, any one of the systematically correlated movements of the reaction would be equally significant in comparing the normal with the drug-reaction periods. It is on these grounds and with the corresponding limitations that air-movement keys are defensible in speech-reaction movements. As Wirth⁶ states in a discussion of this type of key, "They permit

¹Erdmann and Dodge, *Psychologische Untersuchungen über das Lesen*, Halle, 1898.

²Dodge, *Psychol. Bull.*, 1907, 4, p. 10. ³Kraepelin, *Phil. Stud.*, 1883, 1, p. 417.

⁴Cattell, *Phil. Stud.*, 1885, 3, p. 313. ⁵Römer, *Kraepelin's Psychol. Arbeit.*, 1, p. 577.

⁶Wirth, *Psychophysik. Tigerstedt's Handbuch der physiologischen Methodik*, 1912, 3, p. 490.

comparative records of the same sounds only." The admissibility of any particular type of such sound keys is first a matter of sensitivity and constancy, and secondly a matter of convenience. Sensitivity of the voice key affects reaction experiments chiefly through its relation to instrumental constancy. The use of extremely sensitive recording devices, like the phonoscope of Weiss, or the microphone, would be possible, but is probably inexpedient, since, in view of the fundamental defects of all records of speech-reactions by air-movement, an instrument of such sensitivity could only give the illusion of extreme accuracy in speech-reaction measurements. It would not obviate the main defects of the measurement. Simultaneous records of the throat-muscle movements and tested sound keys make it clear that the similarity of sequence of the physiological processes as close as 0.001" can not be relied upon even for similar sounds. The demand for an extremely sensitive instrument under such circumstances would be experimental pedantry. The voice key which was used in this experiment is one which was first described by Dodge.¹ Like the Erdmann-Dodge key, it is a modification of the Kraepelin-Cattell sound key. The present form was evolved after a considerable number of changes, to make the instrument more compact, more manageable, and more regular in its action.

One end of a short brass tube, 4 cm. in diameter, is fitted with a hard-rubber ring (shown removed from the brass tube in fig. 16). Across the ring a rubber membrane is stretched. This membrane presses a light spring, with platinum tip, against an adjustable contact-point within the tube. When the spring and membrane are in elastic equilibrium, the contact-point is adjusted by a micrometer-screw to make the lightest possible contact. The contact should be tested to break by a slight free-hand jerk of the key. It should break positively in movements of 2 cm. Under such circumstances a slight increase of air-pressure within the tube, such as is produced by speaking into its open end, disturbs the elastic equilibrium of spring and membrane and breaks the electric circuit.

The relative latency of this instrument has been tested in a number of ways. Records illustrating some of these tests are reproduced in figures 17 to 20. All these records are read from left to right. The vertical ordinates are 0.01" apart. The horizontal ordinates are approximately 1 mm. apart.

These and similar records also give us definite controls of the total latency of our voice key in series with the Harvard marker, as actually used in these experiments, and also the relative latency of the Harvard signal as compared with the Deprèz signal. The total latency of our voice key and Harvard marker is not over 2σ (0.002") for open tones. The latency of the Deprèz signal is not over 0.5σ . Most available

¹Dodge, *An Experimental Study of Visual Fixation*. Monograph Supp. of the Psychol. Review, No. 35, 1907.

measurements make it smaller. When the spring and the current are carefully adjusted the latency of the break may be even less than 0.2σ . The total latency of the Harvard signal without friction is not over 1.5σ . This seems to be constant within the errors of measurement for currents such as were used in our experiments. We were particularly gratified at this showing of the Harvard marker. We started to use it because of its availability. We continued to use it because of its excellence. From these various records of the latency of our apparatus, it appears that the actual latency of the word-reactions will really be about 37σ less than the recorded value. This total error, however, will vary from word to word, but will be relatively constant for similar initial sounds. The instrumental variation is much smaller than the unit

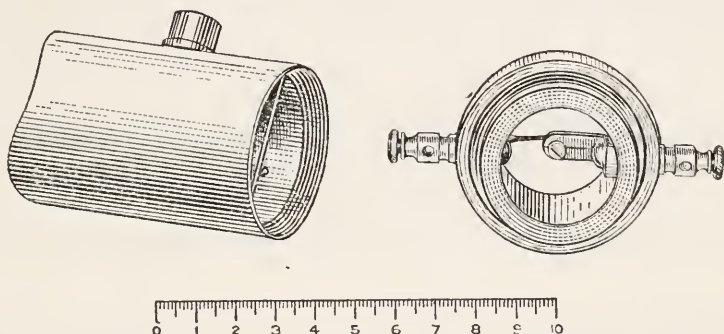

FIG. 16.—Voice-reaction key.

of our measurements. In no event can it be understood as constituting a bias for or against alcohol days. We have entered into this careful analysis of the instrumental errors to guarantee as far as instrumental accuracy is concerned that the drug effect, though relatively small, indicates a real physiological difference occasioned by the administration of alcohol.

EXPERIMENTAL PROCEDURE.

Position of the subject.—For the word-reactions the subject was seated at position I (fig. 1), as in the knee-jerk and memory experiments. The back of the seat was raised so that the subject sat upright with adequate support at his back. The leg was freed from the knee-jerk apparatus. The left hand held the voice-reaction key lightly but firmly against the upper lip, as per standard instructions. The left arm was supported either on the table or on a rest which was held in the subject's lap.

Stimuli.—A standard set of 24 words was used throughout the year. In every word-reaction experiment the entire set of 24 words was reacted to. Since the reaction time for reading varies directly with the length of the word, as shown by Cattell,¹ and by Erdmann and Dodge,² an arbitrary word-length of 4 letters was adopted. All the

¹Cattell, *Phil. Stud.*, 1885, 3, p. 313.

²Erdmann and Dodge, *Psychologische Untersuchungen über das Lesen*, Halle, 1898.

subjects were shown each word separately before the first day's experiments. The psychopathic subjects were shown each word separately at the beginning of each day's experiments.

Exposure.—The words were exposed by the exposure apparatus in chance order at intervals of 10 seconds. They were changed by the operator by hand.

Operation.—With the subject in position, the time and reaction markers properly adjusted to the drum, and, the Blix-Sandström kymograph running at the rate of 100 mm. per second, one of the stimulus cards was selected at random and inserted by the operator in the exposure apparatus. From 2 to 2.5 seconds before the exposure the operator touched the kymograph lever to change the circular movement of the drum to a spiral, and withdrew his hand from the apparatus as a signal for attention. As the drum continued to revolve, an offset on the kymograph shaft engaged a circuit breaker, with which the voice key, the electrical marker, and the electric magnets of the exposure apparatus were in series. The consequent movement of the marker indicates the beginning of the movement of the exposure apparatus which eventuates in the exposure of the word stimulus. As was previously explained, this movement of the marker is not coincident with the exposure; the latter followed after 37σ . While this discrepancy between the registered and the actual beginning of exposure is theoretically inexpedient, it can not affect comparative values as we have shown. Absolute values for the reaction time can be obtained by deducting the latencies of the exposure apparatus (37σ).

The variation of this latency as is indicated above is considerably less than half the unit of measurement. As the drum moves on, the circuit-

FIGS. 17 to 20.—Records of the latency of the voice key.

Figure 17 is a record of the sound of "ah," recorded by three methods. Two records were produced respectively by a Harvard Apparatus Company marker and a Deprèz signal. Both were in series with each other and with the sound key. The middle record was made by a Cambridge string galvanometer (sensitivity, 3 cm. per 0.001 volt) in series with a telephone receiver which is pressed against the throat over the thyroid cartilage by an elastic band. This record shows an exceedingly small difference between the various forms of recording devices. None of the records shows a relative delay of more than 0.002". Of the three the string-galvanometer curve naturally shows the most details.

Figure 18 is a record of the word "cake," recorded similarly as the above sound "ah." The various sounds of the word appear plainly in the record of the string galvanometer movement. The vowel is especially conspicuous. Almost identical time relations exist between the various lines in this record as in figure 17, *i. e.*, the initial *C* is recorded by our voice key with as little error as the open vowels.

Figure 19 is a similar record of the word "yolk." The character of the vowel is notably changed. The initial "y" and the final "k" are obvious in the galvanometer record. The relative latencies do not change.

Another record of the word "cake," using the string galvanometer as before, is reproduced in figure 20. But instead of actuating the galvanometer from the throat, in this record the telephone receiver was placed at the side of our voice key. The latency appears not to be materially modified by this process, *i. e.*, the difference between the throat-movement and actual vocalization in the sound *C* is negligible, but the record contains some details which are not found in figure 18, namely, at the beginning of the record, the initial *C* of "cake" appears in the string galvanometer record of figure 20 as a high-pitched tone. This corresponds with the fact that the pitch of *C* is not determined at the vocal cords, but at the front of the mouth.

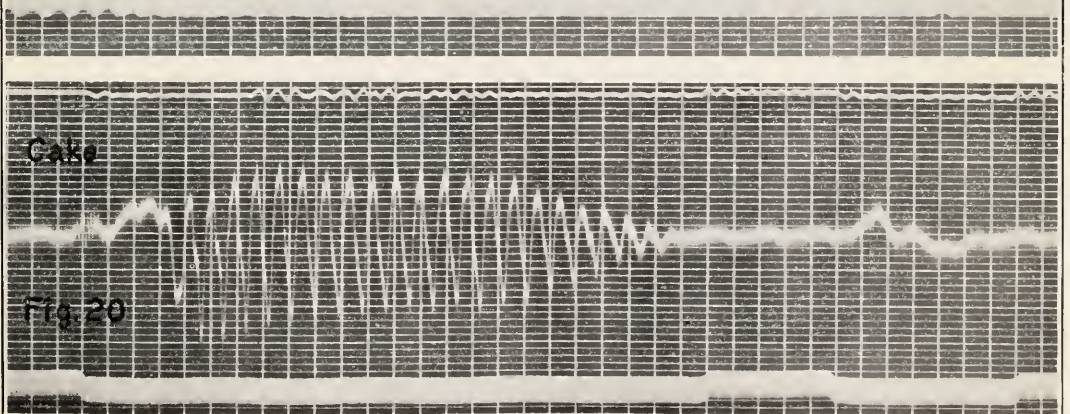
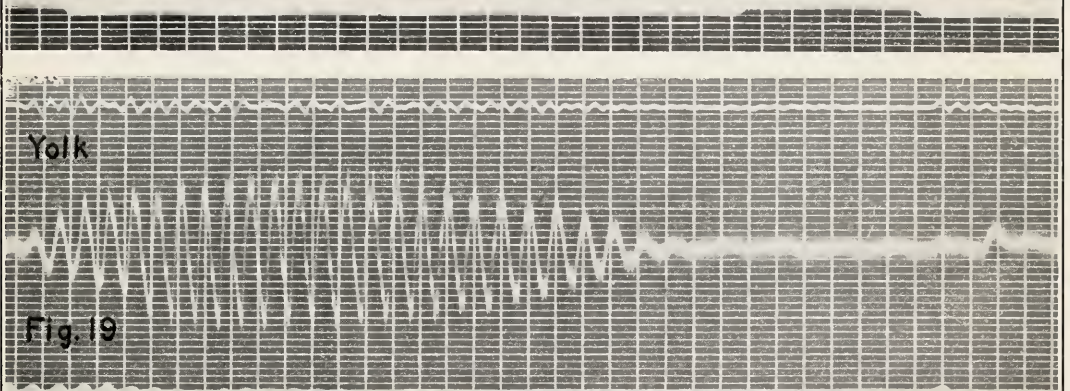
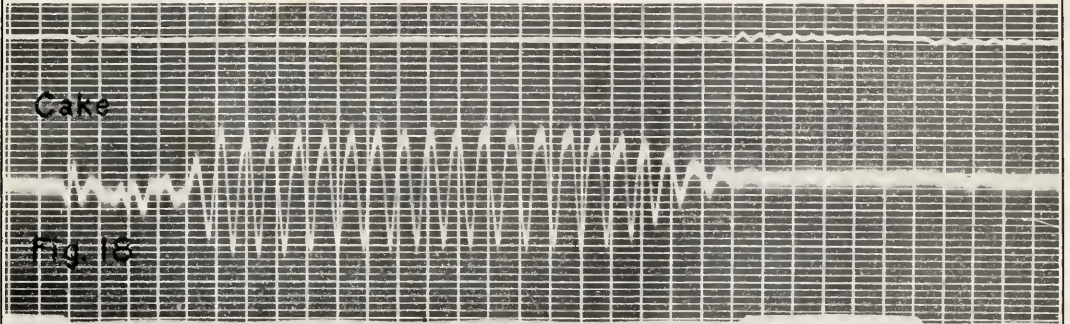
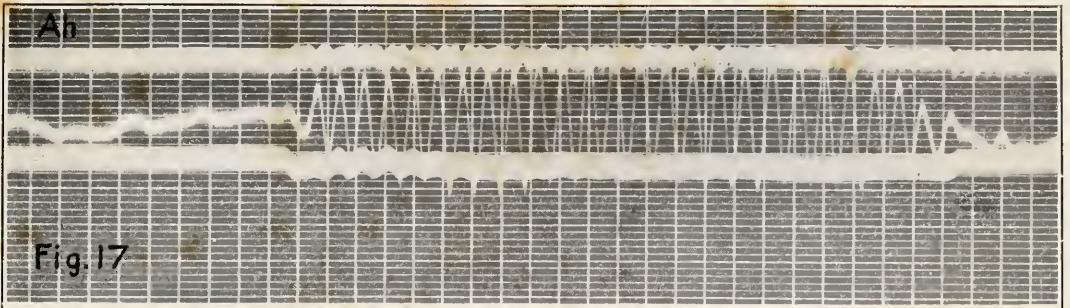

Figs. 17 to 20.



FIG. 21.—Photograph of a subject in position for the association experiments.

The arrangement of the sphygmograph and the psycho-galvanic electrodes can be seen in the photograph, as well as the operator's table with its switches. (See p. 109.)

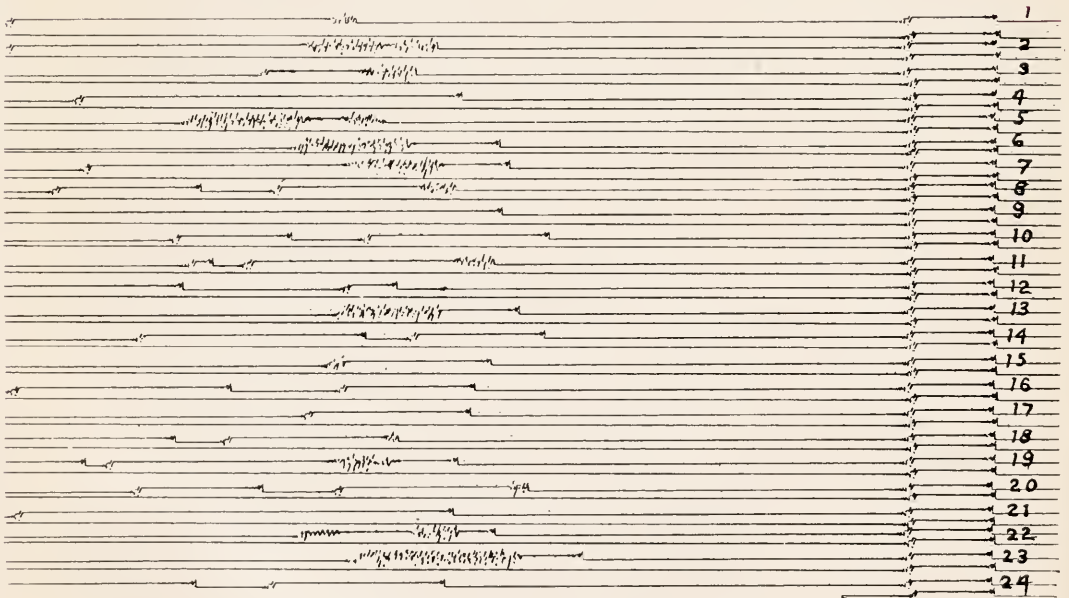

FIG. 22.—Typical record of a word-reaction experiment.

breaker closes again, and the marker returns to its normal position. The armature of the exposure apparatus, however, is so far from its magnet that it remains unaffected by the closure of the circuit and the exposure is continuous. When the subject reacts by speaking the word, the circuit of the electric marker is broken a second time by the voice key. This second movement of the marker indicates the moment of reaction. Since both the exposure and the reaction are recorded by breaking the same electric circuit, and since both events are recorded by movements of the same writing-point, the alignment of the marker and its latency do not affect the records.

Standard instructions to the subject.—(1) Hold the voice key to the mouth, pressing it firmly against the upper lip; (2) speak the words as soon as possible after you see them; (3) if you misread or mispronounce a word, speak it correctly as soon as possible.

RECORDS.

A typical word-reaction record is reproduced in figure 22. The record reads from right to left. The extreme right-hand breaks in the horizontal lines indicate the moment of contact between the offset of the kymograph shaft and the circuit-breaker which was in series with the marker and the exposure apparatus. These breaks are in approximate vertical alignment. Since the kymograph drum revolves completely in 5'', and the stimulus follows at intervals of 10'', each alternate break is insignificant and is not followed by a reaction, because the exposure apparatus was arbitrarily prevented from falling by the operator. The second elevation in the horizontal lines of the significant records is the reaction break. The character of the reaction record varies with the word. The continuous record furnishes its own distribution curve. Measuring the distance between the stimulus and the reaction breaks gives the reaction-time. One millimeter along the base-line equals 10 σ (0.01''). All records which are not marked at the time of taking, as defective in technique or in response, are included in the following results. In this, as in other measurements, we deemed it inexpedient to eliminate any records on the basis of probable error, unless the evidence of inadequacy was given, independent of results.

RESULTS.

Table 10 gives the data for word-reaction experiments. Results of the normal days are entered on the left, alcohol days on the right. In the first column of each section are entered the designation of the subject, the date of the experiment, and the number of the periods. In the next column are entered the averages of the 24 reactions of each period. Their mean variations are given in the column headed Mean variation. Under the heading Difference are given the deviations of subsequent periods from the first, according to the formula $D=1-2, 1-3, 1-4, \text{ etc.}$, and also the mean variations of these differences.

TABLE 10.—Word-reaction measurements.
[Values given in thousandths of a second.]

Normal.				Alcohol.					
Subject, date, and number of period.	Average.	Mean variation.	Difference (1-2, 1-3, etc.).		Subject, date, dose, and number of period.	Average.	Mean variation.	Difference (1-2, 1-3, etc.).	
			Average.	Mean variation.				Average.	Mean variation.
<i>Subject II.</i>				<i>Subject II.</i>					
Dec. 5, 1913:				Dec. 19, 1913:					
1.....	433	26			Dose A:				
2.....	450	42	- 17	-16	1.....	¹ / ₄₂₆	¹ / ₃₂		
3.....	493	75	- 60	-49	2.....	441	23	- 15	+ 9
4.....	478	38	- 45	-12	3.....	452	24	- 26	+ 8
Average.....	463	45	- 41	-26	4.....	468	29	- 42	+ 3
					5.....	443	51	- 17	-19
					Average.....	446	32	- 25	0
Mar. 16, 1914:				Mar. 10, 1914:					
1.....	495	47			Dose B:				
2.....	497	33	- 2	+14	1.....	¹ / ₄₃₇	¹ / ₂₈		
3.....	510	51	- 15	- 4	2.....	503	25	- 66	+ 3
4.....	517	45	- 22	+ 2	3.....	521	27	- 84	+ 1
5.....	452	24	+ 43	+23	4.....	583	64	-146	-36
Average.....	494	40	+ 1	+ 7	Average.....	511	36	- 99	-11
<i>Subject III.</i>				<i>Subject III.</i>					
Jan. 19, 1914:				Jan. 26, 1914:					
1.....	411	19			Dose A:				
2.....	422	24	- 11	- 5	1.....	¹ / ₃₉₄	¹ / ₂₆		
3.....	399	34	+ 12	-15	2.....	402	21	- 8	+ 5
4.....	414	21	- 3	- 2	3.....	409	20	- 15	+ 6
Average.....	411	24	- 1	- 7	4.....	385	21	+ 9	+ 5
					5.....	414	21	- 20	+ 5
					6.....	401	21	- 7	+ 5
					Average.....	401	22	- 8	+ 5
Mar. 9, 914:				Feb. 9, 1914:					
1.....	395	21			Dose B:				
2.....	389	28	+ 6	- 7	1.....	¹ / ₄₁₂	¹ / ₂₂		
3.....	399	26	- 4	- 5	2.....	417	32	- 5	-10
Average.....	394	25	+ 1	- 6	3.....	420	27	- 8	- 5
					4.....	397	26	+ 15	- 4
					Average.....	411	27	+ 1	- 6
<i>Subject IV.</i>				<i>Subject IV.</i>					
Jan. 30, 1914:				Feb. 13, 1914:					
1.....	502	33			Dose B:				
2.....	472	32	+ 30	+ 1	1.....	¹ / ₄₆₈	¹ / ₃₁		
3.....	479	25	+ 23	+ 8	2.....	490	40	- 22	- 9
4.....	462	43	+ 40	-10	3.....	469	38	- 1	- 7
5.....	472	42	+ 30	- 9	4.....	464	33	+ 4	- 2
Average.....	477	35	+ 31	- 2	Average.....	473	35	- 6	- 6
Mar. 19, 1914:									
1.....	448	23							
2.....	454	25	- 6	- 2					
3.....	442	28	+ 6	- 5					
4.....	458	65	- 10	-42					
5.....	437	36	+ 11	-13					
Average.....	448	35	0	-15					

¹The values for the first periods of the alcohol experiments were obtained before the alcohol was given and are therefore not included in the averages.

TABLE 10.—*Word-reaction measurements*—Continued.

[Values given in thousandths of a second.]

Normal.					Alcohol.				
Subject, date, and number of period.	Average.	Mean variation.	Difference (1-2, 1-3, etc.).		Subject, date, dose, and number of period.	Average.	Mean variation.	Difference (1-2, 1-3, etc.).	
			Average.	Mean variation.				Average.	Mean variation.
<i>Subject VI.</i>					<i>Subject VI.</i>				
Nov. 19, 1913:					Dec. 2, 1913:				
1.....	457	44	Dose A:				
2.....	485	44	- 28	0	1.....	¹ 449	130
3.....	491	61	- 34	-17	2.....	459	31	- 10	- 1
4.....	492	55	- 35	-11	3.....	440	32	+ 9	- 2
Average.....	481	53	- 32	- 14	4.....	452	39	- 3	- 9
Feb. 12, 1914:					Jan. 22, 1914:				
1.....	454	27	Dose B:				
2.....	472	26	- 18	+ 1	1.....	¹ 500	¹ 49
Average.....	463	26	- 18	+ 1	2.....	557	70	- 57	-21
<i>12 hr. experiment.</i>					<i>12 hr. experiment.</i>				
Jan. 1, 1914:					Jan. 2, 1914:				
1.....	420	31	Dose C:				
2.....	487	38	- 67	- 7	1.....	¹ 467	130
3.....	492	45	- 72	-14	2.....	497	33	- 30	- 3
4.....	455	31	- 35	0	3.....	463	38	+ 4	- 8
5.....	509	46	- 89	-15	4.....	466	29	+ 1	+ 1
6.....	530	54	-110	-23	5.....	475	48	- 8	-18
7.....	503	28	- 83	+ 3	6.....	473	27	- 6	+ 3
8.....	488	35	- 68	- 4	7.....	497	50	- 30	-20
9.....	542	47	-122	-16	8.....	478	33	- 11	- 3
10.....	513	31	- 93	0	9.....	488	33	- 21	- 3
Average.....	494	39	- 82	- 8	10.....	510	61	- 43	-31
<i>Subject VII.</i>					<i>Subject VII.</i>				
Nov. 18, 1913:					Dec. 3, 1913:				
1.....	464	43	Dose A:				
2.....	431	30	+ 33	+13	1.....	¹ 415	¹ 24
3.....	431	25	+ 33	+18	2.....	404	17	+ 11	+ 7
Average.....	441	33	+ 33	+ 15	3.....	410	25	+ 5	- 1
Mar. 20, 1914:					Mar. 13, 1914:				
1.....	417	28	Dose B:				
2.....	419	26	- 2	+ 2	1.....	¹ 454	¹ 29
3.....	428	28	- 11	0	2.....	471	37	- 17	-12
4.....	424	28	- 7	0	3.....	468	62	- 14	-33
Average.....	422	27	- 7	+ 1	4.....	451	35	+ 3	- 6
					Average.....				
					461 41 - 9 -17				

¹The values for the first periods of the alcohol experiments were obtained before the alcohol was given and are therefore not included in the averages.

TABLE 10.—*Word-reaction measurements*—Continued.

[Values given in thousandths of a second.]

Normal.					Alcohol.				
Subject, date, and number of period.	Average.	Mean variation.	Difference (1-2, 1-3, etc.).		Subject, date, dose, and number of period.	Average.	Mean variation.	Difference (1-2, 1-3, etc.).	
			Average.	Mean variation.				Average.	Mean variation.
<i>Subject IX.</i>					<i>Subject IX.</i>				
Nov. 10, 1913:					Nov. 17, 1913:				
1.....	(¹)	(¹)			Dose A:				
2.....	473	23			1.....	² 486	² 41		
3.....	531	50	- 58	-27	2.....	490	39	- 4	+ 2
4.....	525	40	- 52	-17	3.....	518	37	- 32	+ 4
5.....	512	93	- 39	-70	4.....	549	78	- 83	-37
Average.....	508	51	- 50	-38	5.....	466	34	+ 20	+ 7
					6.....	478	41	+ 8	0
					Average.....	498	45	- 18	- 5
Nov. 24, 1913:					Jan. 21, 1914:				
1.....	438	36			Dose B:				
2.....	473	34	- 35	+ 2	1.....	² 462	² 30		
3.....	479	51	- 41	-15	2.....	603	109	-141	-79
4.....	471	48	- 33	-12	3.....	531	34	- 69	- 4
5.....	463	44	- 25	- 8	4.....	522	48	- 60	-18
Average.....	465	35	- 33	- 8	5.....	503	33	- 41	- 3
					6.....	502	46	- 40	-16
					Average.....	524	50	- 70	-24
<i>12 hr. experiment</i>					<i>12 hr. experiment.</i>				
Dec. 22, 1913:					Dec. 23, 1913:				
1.....	465	29			Dose C:				
2.....	462	34	+ 3	- 5	1.....	² 460	² 29		
3.....	477	47	- 12	-18	2.....	439	28	+ 21	+ 1
4.....	476	51	- 11	-22	3.....	471	32	- 11	- 3
5.....	476	34	- 11	- 5	4.....	452	29	+ 8	0
6.....	485	47	- 20	-18	5.....	488	30	- 28	- 1
7.....	465	38	0	-11	6.....	487	29	- 27	0
8.....	457	24	+ 8	+ 5	7.....	484	49	- 24	-20
9.....	472	31	- 7	- 2	8.....	464	26	- 4	+ 3
10.....	461	27	+ 4	+ 2	9.....	453	28	+ 7	+ 1
Average.....	470	36	- 5	- 9	10.....	489	32	- 29	- 3
					11.....	514	47	- 54	-18
					Average.....	473	33	- 14	- 4
<i>Subject X.</i>					<i>Subject X.</i>				
Feb. 11, 1914:					Feb. 18, 1914:				
1.....	(²)	(²)			Dose A:				
2.....	460	28			1.....	² 436	² 41		
3.....	456	32	+ 4	- 4	2.....	453	53	- 17	-12
4.....	452	30	+ 8	- 2	3.....	439	49	- 3	- 8
Average.....	456	30	+ 6	- 3	4.....	453	30	- 17	+11
					5.....	471	50	- 35	- 9
					Average.....	450	45	- 18	- 4
					Mar. 18, 1914:				
					Dose A:				
					1.....	² 451	² 31		
					2.....	463	26	- 12	+ 5
					3.....	486	32	- 35	- 1
					4.....	478	42	- 27	-11
					5.....	495	41	- 44	-10
					Average.....	475	34	- 29	- 4

¹The measurements for the first period were obtained in the preliminary exposure of the words and the records are therefore not included in the table of results.

²The values for the first periods of the alcohol experiments were obtained before the alcohol was given and are therefore not included in the averages.

³Key was held too low, so that only a few records were made.

TABLE 10.—*Word-reaction measurements*—Continued.
[Values given in thousandths of a second.]

PSYCHOPATHIC SUBJECTS.

Normal.				Alcohol.							
Subject, date, and number of period.	Average.	Mean variation.	Difference (1-2, 1-3, etc.).		Subject, date, dose, and number of period.	Average.	Mean variation.	Difference (1-2, 1-3, etc.).			
			Average.	Mean variation.				Average.	Mean variation.		
<i>Subject XI.</i>				<i>Subject XI.</i>							
Mar. 24, 1914:				Mar. 25, 1914:							
1.....	706	56	Dose 15 c.c.:						
2.....	682	69	+ 24	- 13	1.....	¹ 681	¹ 88		
3.....	704	78	+ 2	- 22	2.....	658	45	+ 23	+ 43		
Average.....	697	68	+ 13	- 17	3.....	728	61	- 47	+ 27		
Mar 28, 1914:				4.....				690	74	- 9	+ 14
1.....	686	42	Average.....	689	67	- 16	+ 28		
2.....	729	53	- 43	- 11	<i>Subject XII.</i>						
3.....	696	59	- 10	- 17	Apr. 1, 1914:						
Average.....	704	51	- 26	- 14	Dose A:						
<i>Subject XII.</i>				<i>Subject XII.</i>							
Mar. 31, 1914:				Apr. 1, 1914:							
1.....	573	54	1.....	¹ 538	¹ 28		
2.....	485	59	+ 88	- 5	2.....	518	37	+ 20	- 9		
3.....	459	50	+ 114	+ 4	3.....	518	48	+ 20	- 20		
Average.....	506	54	+ 101	0	4.....	495	57	+ 43	- 29		
Apr. 4, 1914:				5.....				474	51	+ 64	- 23
1.....	489	37	Average.....	508	44	+ 37	- 20		
2.....	508	41	- 19	- 4	<i>Subject XIV.</i>						
3.....	513	28	- 24	+ 9	Apr. 22, 1914:						
Average.....	503	35	- 21	+ 2	Dose A:						
<i>Subject XIV.</i>				<i>Subject XIV.</i>							
Apr. 21, 1914:				Apr. 22, 1914:							
1.....	573	54	1.....	¹ 613	¹ 48		
2.....	473	59	+ 100	- 5	2.....	607	52	+ 6	- 4		
3.....	641	76	- 68	- 22	3.....	589	52	+ 24	- 4		
Average.....	562	63	+ 16	- 13	4.....	587	44	+ 26	+ 4		
Apr. 25, 1914:				5.....				570	60	+ 43	- 12
1.....	563	33	Average.....	593	51	+ 25	- 4		
2.....	581	44	- 18	- 11							
3.....	571	46	- 8	- 13							
Average.....	572	41	- 13	- 12							

The values for the first periods of the alcohol experiments were obtained before the alcohol was given and are therefore not included in the averages.

SUMMARY OF THE WORD-REACTIONS.

A summary of the word-reaction data is given in table 11, in the same general arrangement of columns as obtained in table 10. Since the effects of alcohol are relatively slight at most, it seemed desirable to present the results in true averages as well as by differences. All the results are given without correction for the instrumental latency. In accordance with our investigation of that factor (p. 99), absolute values will be found by subtracting 37σ from recorded values.

TABLE 11.—*Summary of word-reactions.*

[Values given in thousandths of a second.]

Subject.	Normal (I and II).				Alcohol.							
					Dose A. ¹				Dose B.			
	Average.	Mean variation.	Average difference. ²		Average.	Mean variation.	Average difference. ²		Average.	Mean variation.	Average difference. ²	
			Average.	Mean variation.			Average.	Mean variation.			Average.	Mean variation.
Normal subjects:												
II.....	478	42	-20	- 9	446	32	-25	0	511	36	-99	-11
III.....	402	24	0	- 6	401	22	- 8	+ 5	411	27	+ 1	- 6
IV.....	462	35	+15	- 8	(³)	(³)	(³)	(³)	473	35	- 6	- 6
VI.....	472	39	-25	- 6	451	38	- 2	-10	542	62	-48	-19
VII.....	431	30	+13	+ 8	406	23	+10	+ 1	461	41	- 9	-17
IX.....	486	43	-41	-23	498	45	-18	- 5	524	50	-70	-24
X.....	456	30	+ 6	- 3	462	39	-23	- 4				
Average...	455	35	- 7	- 7	444	33	-11	- 2	487	42	-38	-14
12 hr. experiments:												
VI.....	494	39	-82	- 8	¹ 481	¹ 38	¹ -17	¹ - 9				
IX.....	470	36	- 5	- 9	¹ 473	¹ 33	¹ -14	¹ - 4				
Average...	482	37	-43	- 8	¹477	¹35	¹-15	¹- 6				
Psychopathic subjects:												
XI.....	700	59	- 6	-15	689	67	-16	+28				
XII.....	504	44	+40	+ 1	508	44	+37	-20				
XIV.....	567	52	+ 1	-12	593	51	+25	- 4				
Average...	590	52	+12	- 9	597	54	+15	+ 1				

¹Dose C (12 c.c.) was used in the 12-hour experiments.²Differences equal period 1-2, 1-3, 1-4, etc.³Experiment with dose A was accidentally omitted from this series.

As appears from table 11, the average recorded normal latency of the word-reaction for the normal group, is 455σ . It is notably higher, viz, 590σ , for the psychopathic group. Subject XI was especially handicapped by a slight impediment in his speech. His latency is consequently conspicuously long.

The range of normal averages for the main group is from 402σ to 486σ , a maximum difference of 21 per cent. Within the main group, at least, the community of linguistic association corresponds with our expectation.

The average of mean normal variation for the main group is 7.7 per cent of the average latency. It is notable that nowhere, not even in the psychopathic cases, does the mean variation reach 10 per cent of the average. This is the more conspicuous when one realizes that only one of the subjects (Subject VI) had ever served as a subject in similar experiments, and, moreover, that the mean variation includes the variations which must be expected from the differences in familiarity among the 24 stimulus words, as well as the psychophysical variability of the subjects.

TABLE 12.—Summary of the effect of alcohol on the word-reactions as expressed in averages and differences.

[Average values given in thousandths of a second.]

Subject.	Effect as shown by averages. ¹					Effect as shown by average differences. ²				Effect as shown by percentile differences. ³	
	Dose A.		Dose B.		Total average effect with doses A and B.	Dose A.		Dose B.		Dose A.	Dose B.
	Average.	Mean variation.	Average.	Mean variation.		Average.	Mean variation.	Average.	Mean variation.		
Normal subjects:	σ	σ	σ	σ	σ	σ	σ	σ	σ	<i>p. cl.</i>	<i>p. cl.</i>
II.....	-32	-10	+33	-6	0	-5	+9	-79	-2	-1	-17
III.....	-1	-2	+9	+3	+4	-8	+11	+1	0	-2	0
IV.....			+11	0	+11			-21	+2		-4
VI.....	-21	-1	+70	+23	+24	+23	-4	-23	-13	+5	-5
VII.....	-25	-7	+30	+11	+2	-3	-7	-22	-25	-1	-5
IX.....	+12	+2	+38	+7	+25	+23	+18	-29	-1	+5	-6
X.....	+6	+9			+6	-29	-1			-6	
Average.	-10	-1	+32	+6	+10	0	+4	-29	-6	0	-6.2
12 hr. experiments:											
VI.....	⁴ -13	⁴ -1				⁴ +65	⁴ -1			⁴ +15	
IX.....	⁴ +3	⁴ -3				⁴ -9	⁴ +5			⁴ -2	
Average.	⁴ -5	⁴ -2				⁴ +28	⁴ +2			⁴ +6	
Psychopathic subjects:											
XI.....	-11	+8				-10	+43			-1	
XII.....	+4	0				-3	-21			-1	
XIV.....	+26	-1				+24	+8			+4	
Average.	+6	+2				+4	+10			+1	

¹Effect on averages equals alcohol average minus normal average.
²Effect on the average difference equals (av. 1-2, 1-3, 1-4, etc., alcohol) minus (av. 1-2, 1-3, 1-4, etc., normal).
³Effect on the percentile difference equals the effect of alcohol on the average difference divided by the average of the corresponding normals of the day.
⁴Dose C given in 12-hour experiments.

The effect of repetition decreases the reaction latency between the first and last normal day 3.7 per cent for the normal group. The effect of repetition for the psychopathic group is less than 1 per cent. With respect to instrumental accuracy, community of pre-experimental experiences, low variability, and small effect of repetition the word-reaction measurements qualify as among the most satisfactory of the group.

EFFECT OF ALCOHOL ON WORD-REACTION.

A summary of the effect of alcohol on the word-reactions is given in table 12. In the three sections of the table the effect of alcohol is shown respectively, by averages, by average differences, and by percentile differences.

No matter how the effect of alcohol is reckoned as a result of these measurements, it is minute to the point of disappearance after dose A, and small but consistent after dose B. By every method of computation, dose B increases the latent time of the reaction. By percentile differences the increase averages 6.2 per cent, *i. e.*, 80 per cent of the normal mean variation. The apparent effect of dose A, however, depends on the table from which it was computed. If on the basis of the small mean variation and the small effect of repetition, one ventured to compute the effect from the averages, it would appear that dose A decreased the latency in 4 out of 6 normal subjects, by about 3 per cent. If we reckon the effect, as in previous cases, by the differences, we find that dose A appears to lengthen the latency in 4 out of 6 cases, averaging 1 per cent. Taking the average of percentile changes, dose A appears to effect practically no change at all, either in the main group or in the psychopathic subjects. For reasons previously discussed, we believe the differences represent the facts more closely than the simple averages. While these show an increase in reaction latency in 4 out of 6 cases as a result of dose A, the percentile average change is zero.

The average change of latency due to the ingestion of alcohol (both doses) is consequently about 3 per cent. In view of all our precautions and the reliability of our technique, this must be regarded as evidence for a real though slight tendency of moderate doses of alcohol to increase the latency of the word-reaction.

CHAPTER IV.

EFFECT OF ALCOHOL ON FREE ASSOCIATIONS.¹

The highest complication of the reflex arc with which we felt justified in dealing in this research is that which is commonly known as the free-association experiment, and this would not have been attempted had it not been for the generous collaboration of an expert in the field.

METHODS AND APPARATUS.

As it is commonly practiced, the association experiment is a kind of reaction. The stimulus to reaction is a word spoken by the operator. The reaction is a response word spoken by the subject. The kind of response which is demanded of the subject may be systematically varied, giving rise to several different types of association experiments. In the free-association experiment the subject is required merely to speak as quickly as possible the first word that occurs to him after the stimulus word is given.

The relationship between the stimulus word and the response, together with the latency of the reaction word, are the usual significant facts in the experiment. In addition, the so-called psycho-galvanic reflex and the accompanying pulse-changes have been regarded as significant. We undertook to measure all these factors.

The free-association experiment occupied the balcony of the psychological laboratory (see p. 30). The subject reclined in a steamer-chair and faced a bare corner of the room. Behind the subject and to his right the operator (Wells) sat at a small, properly illuminated writing-table, on which were the switches for the various electric currents, a 2-volt signal light, and the operator's reaction key.²

The device for securing pulse-records³ was attached to the left wrist of the subject. A light but sensitive pneumograph capsule was buttoned under his vest. Electrodes for securing the psycho-galvanic reflex rested on a suitable stand at the subject's right hand, so that the index and second digit of his right hand could reach them with the arm in a natural and comfortable position.

APPARATUS FOR THE PSYCHO-GALVANIC REFLEX.

The apparatus which was used for measuring the psycho-galvanic reflex was : (1) non-polarizable electrodes for the fingers: (2) a Wheatstone bridge which was connected as though to measure the skin-resistance against a variable, known resistance; and (3) a string galvanometer connected across the bridge. The electrodes were the same

¹In collaboration with Dr. F. L. Wells, of McLean Hospital, Waverly, Mass.

²See figure 21, facing page 101.

³A complete description of this device is given in Chapter VIII, p. 189.

as were regularly used by us for measuring the sensory threshold to Faradic current. Two evaporating dishes about 6 cm. in diameter were one-quarter filled with a saturated solution of zinc sulphate. Each dish held an amalgamated zinc rod, through which the electrode was connected with the wiring from the bridge, and a porous porcelain cup, which was half filled with physiological salt solution, in which the respective fingers were immersed. The Wheatstone bridge was the same as that used in determining the skin-resistance for the Martin measurements of Faradic threshold; but in the present case it was operated by a constant current of 3 volts, instead of the alternating current which must be used for skin-resistance measurements. In place of the usual telephone receiver we connected the string galvanometer. (See fig. 1.)

The recording beam of light from the string galvanometer was reflected at the eyepiece of the projection microscope at an angle of 90° to a millimeter scale which was attached to the side of the eye-reaction camera. The string was loosened to a sensitivity of about 20 cm. per 0.001 volt. Its position on the scale was kept approximately constant by balancing the Wheatstone bridge between the experiments. The experimental movement of the string shadow resulted from a lack of balance in the arms of the bridge, and showed at once the direction of change and its amount. 100 mm. of scale was measured in terms of millimeters of balanced bridge at the beginning and at the end of each experimental period, so that the experimental changes could be reduced to terms of resistance changes.

Two circumstances greatly reduced the value of the resulting readings: (1) Long immersion of the fingers in the fluid electrodes was found almost to annihilate the phenomenon. It was consequently measured only in the *D-D'* series (Kent-Rosanoff series). (2) In the predetermined sequences of reactions, 6 per minute, it appears that there is not sufficient time between experiments for a return of the psycho-galvanic equilibrium. At any rate, in our experiments the resistance changes seemed cumulative. For some cause the apparent resistance at the end of a series was regularly different from that at the beginning. These circumstances make it doubtful if our measurements of the psycho-galvanic reflex are of any real significance.

APPARATUS FOR RECORDING THE ASSOCIATION TIME.

The arrangements for recording the latent time of the responses and the synchronous pulse-waves were somewhat complex. It will be remembered that both subject and operator occupied the balcony of the research room. There was no apparatus on the balcony except the tambour and the mercury-cup devices to transform the mechanical pulse and respiration waves into electric impulses. All graphic records were taken on the Blix-Sandström kymograph on the floor below. It

was consequently necessary to correlate the processes by some scheme that would identify each phase of the records, as well as to unite the various records into one whole.

The signal for giving each stimulus word was transmitted to the operator (Wells) at each revolution of the kymograph drum by an automatic break in the 2-volt incandescent signal-lamp circuit. Since the kymograph was regulated to make 1 revolution in 10 seconds, these signals placed the stimuli 10 seconds apart. At the moment of actually giving the stimulus word, the operator simultaneously pressed a telegraph key that registered the event on the kymograph record by a characteristic break in the curve. On the continuous spiral record corresponding to 50 experiments, these breaks come at approximately the same moment of each revolution, and make a more or less approximately straight line. When the subject responded to the stimulus, the operator signaled the moment of response by releasing his pressure on the telegraph key, and the recording curve correspondingly returned to its pre-stimulation base-line. The latent time of each response thus appeared on the records as a plateau, whose rise corresponded with the moment of stimulation and whose fall corresponded with the operator's reaction to the response of the subject.

A constant error in the association time as thus recorded is involved in the fact that the stimulation signal is given synchronously with the stimulus word, while the recorded moment of reaction must include the personal equation of the operator, who can give the signal only after he hears the subject speak. While it makes all our values somewhat too large, in the comparison of one series of performances with another, this constant error is negligible.

Aside from this constant and negligible error, the probability that any measured association time corresponds with the real association time is dependent on the variability of the personal equation of the operator. Our records are protected in this respect by the fact that Wells is an unusually practiced reactor, with a small mean variation. Moreover, we did not aim at an accuracy greater than is implied in the rather large unit of measurement of 0.01''.

We shall probably be criticized for not using some more mechanical form of stimulus and reaction key. The answer to all such criticism must be to emphasize the main purpose of the free-association experiments. Their main value lies in the character of the response. Anything that tends to disturb that phase of the experiment is unpardonable. Other phases are only of relative importance. For example, it would have been easy to give the stimulus word optically, with all the accuracy that characterizes the word-reaction experiment. But the optical word is a stimulus for a very different mental operation from the auditory. The inevitable associate for the optical word is its auditory-motor associate. We depended on that regular connection in the word-

reaction experiments. But that association would have been disastrous to the present experiments. It would have been equally possible to give words by a dictaphone, as was suggested by some friendly critics before the experiments began. But there is no natural impulse to talk back to a dictaphone, none at least to respond to its pronouncements by an associated word. Still more serious than the psychological "set," is the confusion of the intercurrent noises and the instrumental elisions of sound which may be variously important in stimulus words of different lengths. Moreover, it takes practice to become a good dictaphone operator, and even the best must constantly depend on reconstructing the sound from the sense. This is naturally impossible with isolated words. Actual experiments with a typical series of words recorded on the dictaphone showed enormous individual variations in the number of errors. One subject failed in about 80 per cent of the trials. Not even a practiced operator understood them all.

It would have been entirely possible to record the moment of reaction by our speech-reaction key. We tried it. But, owing to the muffling of the sounds by the diaphragm, it proved to be utterly impossible for the operator to be sure what was the response of the subject. At present, at least, there appears to be no means for mechanizing the timing device without jeopardizing the main technical requirement of the experiment—the clear mutual understanding of operator and subject.

For convenience of identification on the record, the stimulus words were given in groups of 5. Between each group of 5 words a blank line was run on the record without reaction. After the first 25 words of each series an interval of a few seconds was allowed for resetting the markers. This divided the graphic record further into halves. Each half consisted of 5 groups of 5 records each. Thus the subsequent correlation of each record with its appropriate association was a simple and accurate process.

The pulse-records and pneumographic records were superposed on the reaction-records by the following arrangements: After the mechanical pulse-wave had been transformed into an electric impulse by the mercury-cup device, which is described on page 191, the electric circuit was carried directly to the same duplex marker that recorded the latency of the response. Coincident with the association latency records, then, and on the same record line, appears a continuous record of the length of the concurrent pulse-waves. Thus the pulse-lengths at any part of the reaction process may be read directly from the records.

The pneumograph records were made by using a second mercury-cup device to transform the mechanical action of respiration to electrical waves which caused a marker to touch the record during each inspiration only. This recorded only the respiration rhythm, not its depth, but it sufficed to show that the pulse-rhythm of the experiments is

not a mere respiration rhythm, but is superposed on the latter in a definite manner.

A time-line was also introduced into the records to control the accuracy of the kymograph. The pendulum of an accurately running clock was made to break the electric circuit of a time-marker, which was thus permitted to vibrate against the drum for a moment every 2 seconds. This intermittent time-record is so delicate that it can not interfere in the least with the other lines, while it serves as an absolute guarantee of the speed of the kymograph.

STIMULUS WORDS.

The series of stimulus words was that given in the Appendix of the monograph by Woodworth and Wells.¹ The Kent-Rosanoff² words were eliminated from it, and made into two series, D and D', as hereafter described. The entire series was divided into 20 lists of 50 words each. One list formed the material for a single experimental period. Six lists were given on each experimental day, regularly alternating with the Faradic threshold experiments. On a few occasions difficulties of technique caused a delay which necessitated the omission of the threshold experiment, but the interval between the association experiments approximated 12 minutes in each case. The instructions to the subject were verbal, in a form that frequent repetition has reduced to practical uniformity. On the first day, conventional examples of stimulus and response were given to the subject, who also reacted correctly to preliminary stimulus words before the experiments were begun. In this manner all difficulties in understanding the nature of the test were avoided during the experiment. If a stimulus word was misunderstood, it was taken in the sense in which it was understood; if the response were doubtfully understood, the subject was requested to spell it, or was asked about ambiguities.

There are three more or less standard ways of dealing with the data of the association experiment. These are: (1) according to the reaction time of the response; (2) according to certain quasilogical relations of the response and the stimulus word; (3) by the statistical frequency of the responses within the range of the material where this has been determined. In addition, the present experiments record the pulse-reactions of the subjects and, in certain cases, also "psycho-galvanic" reactions. These phases of the experiment are first described in order, after which some questions of correlation are dealt with.

¹Woodworth and Wells. *Psychological Monographs*, 1911, **13**, No. 57.

²Kent and Rosanoff, *Am. Journ. Insanity*, 1910, **67**, pp. 37 and 317.

ASSOCIATION-REACTION TIME.

This is the most highly educated group of subjects that Wells has used in the association experiment. As a group, the reaction times are a little longer than those of less-educated subjects Wells has seen, the slower formulation of the response being very probably due to the more complex mental processes the stimulus word is likely to arouse in educated subjects. In spite of the fact that the differences between the averages are small, the order of quickness in which these averages place the subjects is fairly constantly maintained, Subjects X and III being the fastest. Then follow in order Subjects VI, VII, II, and IX. The place of Subject IX is doubtless accounted for by the fact that not English but German is his native language.

TABLE 13.—*Association-reaction times.*

[Values given in hundredths of a second.]

Subject and kind of experiment.	Series A.	Series B.	Series C.	Series D.	Series E.	Series F.	Average.
Normal I:							
II.....	240	241	234	205	254	248	237
III.....	196	205	194	163	194	202	192
IV.....	233	216	215	201	235	230	222
VI.....	234	207	217	191	194	224	211
VII.....	228	225	218	209	187	223	215
IX.....	316	313	280	248	267	281	281
X.....	157	163	162	158	163	179	164
Alcohol (dose A):							
II.....	¹ 218	261	268	203	233	274	248
III.....	¹ 203	189	187	164	182	193	183
IV.....	¹ 262	239	241	191	240	240	230
VI.....	¹ 219	244	212	194	208	205	213
VII.....	¹ 202	223	235	204	226	243	226
IX.....	¹ 268	270	275	256	278	285	273
X.....	¹ 177	173	172	161	168	169	168
Alcohol (dose B):							
II.....	¹ 287	258	257	196	239	267	243
III.....	¹ 185	189	179	169	193	188	184
IV.....	¹ 203	223	212	188	207	228	212
VI.....	¹ 190	193	186	170	184	186	184
VII.....	¹ 196	207	196	189	196	198	197
IX.....	¹ 245	231	279	256	292	309	271
Normal II:							
II.....	236	222	248	212	273	268	243
III.....	189	177	201	180	191	185	187
IV.....	207	155	191	182	206	209	192
VI.....	187	172	185	177	198	198	186
VII.....	180	177	196	185	193	218	191
IX.....	266	242	251	237	272	267	256

¹Values for Series A obtained before alcohol was given, and therefore not included in averages.

The complete table of association-reaction times is given in table 13. In the column at the extreme left is given the kind of experiment and the designation of the several subjects. The columns headed Series A, Series B, etc., contain the average results for the 6 experimental periods

into which each session was divided. The last column shows the average of the whole experimental session for each subject.

That the present doses of alcohol have produced no marked effect on the association reaction times is at once apparent; it is rather a question of whether a consistent effect is discernible.

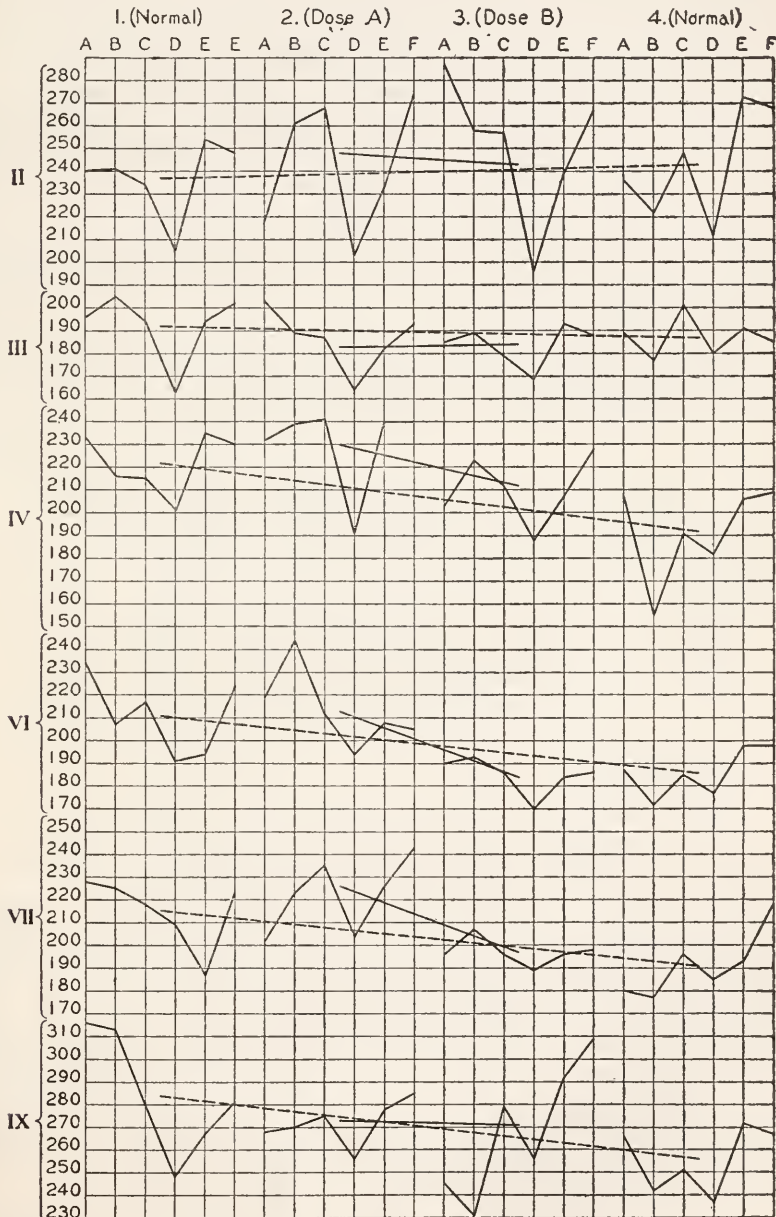

FIG. 23.—Curves of the association-reaction time.

As we already know, there is considerable practice effect in association-reaction time, and the influence of alcohol might be obscured by it. The most we can do is to observe the relation of the first and fourth normal days to the days on which alcohol was given. The accompanying curves (fig. 23) show this graphically for the different subjects.

In figure 23, the average reaction times for the normal days are connected, also those for the alcohol days. If the alcohol produces no effect, the line connecting the experiments should approximately coincide with that of the non-alcohol days. It very nearly does so in the case of Subject IX, though in the third experiment it is a little higher. Subject VI is slower with the smaller dose and nearly equal to normal with the larger one. Subject III is perhaps a little faster with alcohol; Subject II somewhat slower; and Subject IV distinctly so. In contemplating the size of the variations in the individual series, it is plain that these differences are not too large to be due to chance, neither are they systematically distributed.

TABLE 14.—Average differences in measurements of word-reaction time.¹
[Values given in hundredths of a second.]

Subject.	Normal.			Alcohol.		
	I	II	Average.	Dose A.	Dose B.	Average.
II.....	+ 4	- 9	- 2	-30	+44	+ 7
III.....	+ 5	+ 2	+ 3	+20	+ 1	+10
IV.....	+14	-18	- 2	+ 2	- 9	- 3
VI.....	+27	+ 1	+14	+ 6	+ 6	+ 6
VII.....	+16	-14	+ 1	-22	+ 1	-10
IX.....	+38	+12	+25	- 5	-28	-16
X.....	- 8	(- 8)	+ 8	(+ 8)
Average..	+ 5	+ 0.3
Percentage effect of alcohol.....	1.6

¹Differences obtained by subtracting the values for each of the series B to F from the values for the series A. (See table 13.)

Each experiment consists of 6 series of 50 associations. We may compare the differences between the normal of the day and subsequent series in the rate of reaction shown on the alcohol and normal days. On the normal days Subjects II, IV, and X average an increase in the reaction-time, as is shown in table 13. On the alcohol days marked progressive increases are shown in the averages of Subjects VII and IX; the progressive decrease is less in Subject VI. Subject IV shows no significant change. Subjects II and III show a greater lengthening of reaction-time in the alcohol series. Subject X changes from a progressive increase in rate without alcohol to a progressive decrease with it. Not only is this quite irregular, but the alcohol and non-alcohol

days do not agree among themselves; thus Subject II increases his rate an average of 0.30" in the second experiment and decreases it an average of 0.44" in the third experiment, both alcohol days.

The experiments do not justify attributing to alcohol such widely varying changes as the above, which are shown in full by table 14.

The association time is not a simple process, and its results might conceivably be produced by consistent, though opposite effects upon its components—a facilitation of the motor and retardation of the psychic elements, for example. If this were the case, variations could still be expected in the form and content of the responses.

ASSOCIATIVE CATEGORIES.

In 1911 Wells¹ formulated a system of quasilogical classification of associations, which aimed to preserve the valuable distinctions of such categories in their simplest possible form. It was derived most immediately from the system of Jung and Riklin.² The categories were reduced to 5 in number, the egocentric, the supraordinate, the contrast, the miscellaneous, and the speech-habit. A brief definition and illustration of them is as follows:³

- (1) The egocentric reactions may be typified by—
 - (a) Predicate reactions: cloud-ominous, flower-pretty, crooked-line, red-rose, scratch-cat, lion-roar, money-wish, invent-machine, weasel-stealth, beauty-rose, safe-quite, almost-grown, sing-well, never-decide, nicely-very (including the responses yes and no).
 - (b) Responses in the form of proper names: citizen-New York, boy-Johnny, mountain-Kearsarge.
 - (c) Reactions interpreting the stimulus word as a proper name: eagle-newspaper, park-square.
 - (d) Reaction involving the response of a pronoun: hand-you, health-me.
 - (e) Interjections, failures of response, or repetitions of the stimulus word.
- (2) The supraordinate category is confined strictly to the individual genus order, defined in such examples as: priest-man, potato-vegetable, lily-flower, cow-animal.
- (3) The contrast group is composed, of course, of reactions in which the response meets the opposite of the stimulus and is made up of such associations as: good-bad, trouble-pleasure, scatter-gather, fertile-sterile, and the like.
- (4) The miscellaneous category is composed essentially of the remaining reactions of the "inner" type. It includes about 45 per cent of all associations.
- (5) The speech-habit group is composed of associations by familiar phrase (stand-pat), word compounding (play-ground), simple sound associations (tease-sneeze), and syntactic changes (high-height).

¹Wells, *Psychol. Review*, 1911, **18**, p. 229.

²Jung and Riklin, *Journ. f. Psychol. u. Neurol.*, 1904, **3**, p. 55, and 1904-05, **4**, p. 24; Jung, *Journ. f. Psychol. u. Neurol.*, 1905-06, **6**, p. 1.

³Wells, *Psychol. Review*, 1911, **18**, pp. 229-288.

Individual differences are shown in the amount of incidence of these categories of associations, especially in the number of egocentric reactions. In respect to their types of association some people show practice effects and others do not; they are, in general, less marked than those of the association-reaction time. Such practice effects as do appear lie rather in the direction of greater egocentricity of response.

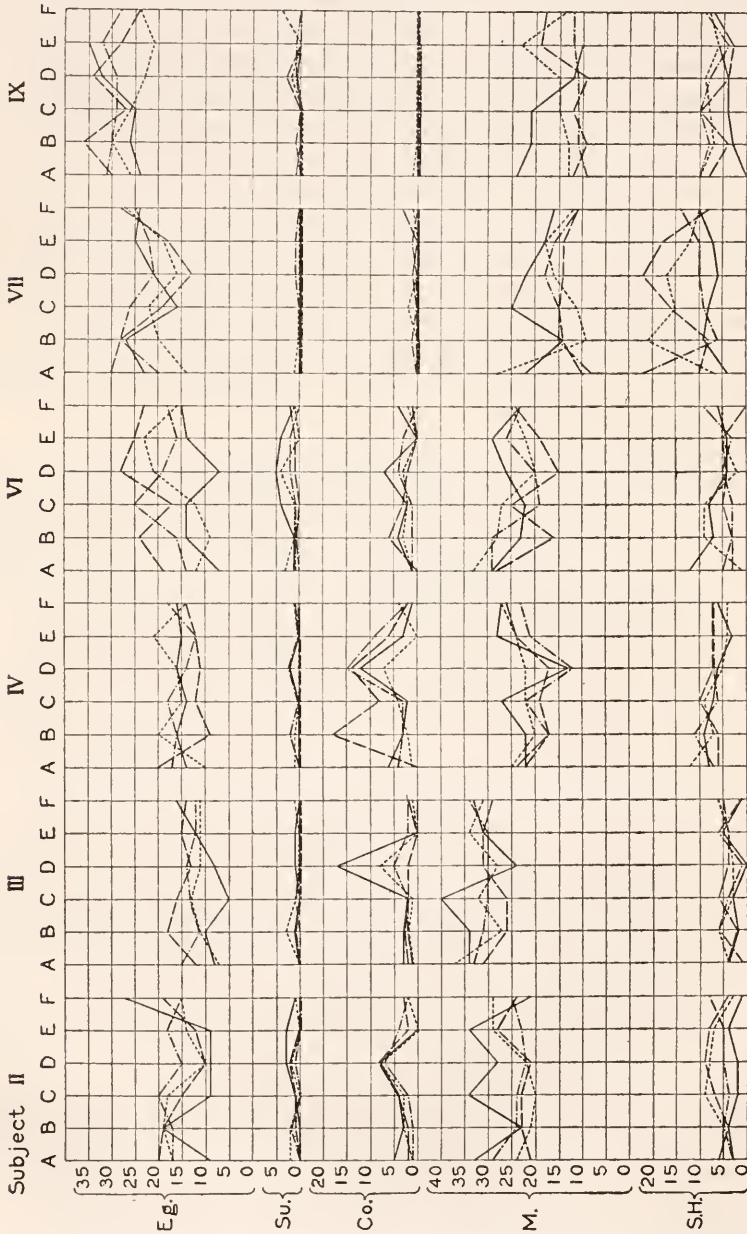

FIG. 24.—Curves of the frequency of the association categories.

The present subjects show more egocentric reactions than others in Wells's experience, which probably, like their longer reaction-times, is a function of their greater education. There are no extremes save in the case of Subject IX, who is not strictly comparable, but the average is higher. A conspicuous way in which these results differ from any other that Wells has studied is in respect to the supraordinate and contrast reactions. There has been elsewhere a strong negative correlation between these, but here they are both practically absent.

The results were examined to see if the normal performance was in any way affected by alcohol. The main situation is depicted in the curves of figure 24, in which the supraordinate and contrast associations are obviously too few for significant comparison between normal and alcohol days. The letters on the left of the figure represent the various association categories as explained above; *Eg.* means egocentric; *Su.*, supraordinate; *Co.*, contrast; *M.*, miscellaneous; and *S. H.*, speech-habit. The plotted lines indicate the number of associations under each category that occurred in each of the six experimental periods (A-F) of each experimental day for the subjects II, III, IV, VI, VII, IX. The first and last normal days are represented by the solid line and the line of dashes, respectively. The day on which dose A was given is shown by a dotted line; dose B by the line of dots and dashes.

TABLE 15.—*Effect of alcohol on the miscellaneous and speech-habit associations.*

	Normal.	Alcohol.
Average number of miscellaneous associations.....	22.5	21.2
Average number of speech-habit associations.....	5.7	7.1
Average decrease of miscellaneous associations.....		1.32
Average excess of speech-habit associations.....		1.32
Per cent of miscellaneous decrease.....		6.5
Per cent of speech-habit excess.....		23.0

Do the curves for the alcohol days differ in any characteristic way from those for the non-alcohol days? Subject IX shows a fairly consistent increase in the number of reactions classified under the category of speech-habit. Rüdín,¹ working with much larger doses and with the "continuous" form of the association experiment, reports an increase in the "outer" associations, but his conception of this category is much broader than what is here formulated as speech-habit. He quotes observations to the same effect by Fürer,² who employed the discrete association method as here. It is the general result one would expect on the supposition, frequently stated, that alcohol makes easier

¹Rüdín, Kraepelin's Psychol. Arbeit., 1904, 4, p. 1.

²Fürer, Bericht über den V. Internationalen Congress zur Bekämpfung des Missbrauchs geistigen Getränke, 1896, p. 367.

the lower level, motor reactions. However, Subject IX is the only one who shows it in the curves. The speech-habit category does not appear to be consistently affected by alcohol in any other subject. But the average of the alcohol days shows for all subjects some increase in the speech-habit category; the miscellaneous category decreases in 5 cases out of 6, the total change being the same, as shown in table 15.

The effects reported by Rüdín and Fürer seem established, but require much heavier doses than are here given to produce them. The present effects, though small, are in the same direction. As regards the egocentric category, ordinarily the one of the greatest psychological meaning, Subjects II and III show the nearest approach to a consistent tendency in the direction of an increase of egocentric responses under alcohol. Nothing can possibly be read into the figures for the remaining categories as an alcohol effect. There is no doubt that, as Partridge¹ remarks, sufficient alcohol will produce great changes in the character of associative responses; but beyond the results of such experiments as those of Rüdín and Fürer, or the unanalyzed data of Partridge, we are unable to say in what direction they are, or whether they would be in a uniform direction for different subjects.

"FREQUENCY" OF THE RESPONSE WORDS.

The Kent-Rosanoff Frequency Tables² make possible this sort of measurement. For comparing the usualness of response on alcohol and normal days, it was thought necessary to divide the Kent-Rosanoff series of 100 into 2 series of 50 words each, so that comparison should not be had with material that had been used before. The two series should, of course, be so selected as to show in central tendency the same frequency of response in each. It did not seem that this should be left to chance, for a series of words like *dark*, *mutton*, or *short*, would be much more likely to have "usual" or "frequent" responses than one composed of words like *anger*, *religion*, or *memory*. Various systematic means of selecting two equal series were tried, that finally employed being as follows:

So far as was known, the normal median frequency value of the Kent-Rosanoff series of associations is represented by the figures 9.0. It was then determined for each stimulus word how many subjects out of a thousand had given a reaction word which was less frequent than this. Thus, in the case of *table*, 733 persons did so, in the case of *dark*, 352 persons, etc. All the words were arranged in the order of the

¹Partridge, *Studies in the Psychology of Intemperance*, New York, 1912.

²These frequency tables were prepared on the following basis: "From the records obtained from these subjects, including in all 100,000 reactions, we have compiled a series of tables, one for each stimulus word, showing all the different reactions given by 1,000 subjects in response to that stimulus word, and the frequency with which each reaction has occurred." (Kent and Rosanoff, *Am. Journ. Insanity*, 1910, 67, pp. 37 and 317.)

number of persons who had given responses to them of less than the above standard of 9.0. These words were then paired, and one of each pair assigned to either series, which are called series D and D' respectively. The order of the words was kept the same as in the original Kent-Rosanoff series, so the two lists were finally constituted as follows:

KENT-ROSANOFF WORDS, SERIES D.			KENT-ROSANOFF WORDS, SERIES D'.		
Table.	Spider.	Head.	Dark.	Red.	Blue.
Sickness.	Carpet.	Religion.	Music.	Sleep.	Stove.
Man.	Working.	Bitter.	Soft.	Anger.	Long.
Deep.	Sour.	Hammer.	Eating.	Girl.	Whisky.
Black.	Trouble.	Thirsty.	Mountain.	High.	Child.
Mutton.	Soldier.	Square.	House.	Earth.	City.
Haud.	Hard.	Loud.	Comfort.	Cabbage.	Butter.
Smooth.	Stem.	Thief.	Short.	Eagle.	Doctor.
Chair.	Dream.	Bed.	Fruit.	Stomach.	Lion.
Sweet.	Yellow.	Heavy.	Butterfly.	Lamp.	Joy.
Whistle.	Bread.	Baby.	Common.	Boy.	Tobacco.
Cold.	Justice.	Scissors.	Woman.	Health.	Moon.
Slow.	Light.	Quiet.	Wish.	Bible.	Green.
River.	Memory.	Street.	Beautiful.	Sheep.	Salt.
White.	Hungry.	King.	Window.	Bath.	Cheese.
Citizen.	Priest.	Blossom.	Rough.	Cottage.	Afraid.
Foot.	Ocean.		Needle.	Swift.	

One or the other of these constituted the fourth series of each experimental day. The figures given in table 16, as *c*, represent the median of the different figures for the usualness of each response, as calculated from the Kent-Rosanoff tables. The higher this figure, the more usual are the subject's responses. The results of these calculations for the 4 days are shown in table 16.

TABLE 16.—Index of community "c" of 50 Kent-Rosanoff words normally and under alcohol.

Kind of experiment.	Subject II.	Subject III.	Subject IV.	Subject VI.	Subject VII.	Subject IX.	Average.
Normal I, List D.....	13.0	9.7	6.8	11.0	1.0	0.8	7.1
Alcohol (dose A) D'.....	5.7	3.5	2.7	5.9	0.7	0.5	3.2
Alcohol (dose B) D.....	5.0	2.5	13.0	6.0	1.2	0.9	4.8
Normal II, List D'.....	2.0	2.3	7.0	2.0	0.5	0.8	2.4

Other experiments had made it apparent that practice increases the individuality of the response, and it is borne out in these figures. It seems certain, also, that the object of splitting the series, namely, to get two series of equal tendency in respect to the frequency of response, was not achieved, at least for this group of subjects. There is an obvious tendency for Series D' to show more unusual responses than Series D that is beyond any reasonable expectation from practice. In further experiments it would be advisable to repeat the whole Kent-Rosanoff series. This unfortunate difference in the series materially interferes with interpreting the results in reference to alcohol. Marked alcohol effects are clearly not present. The figures for the alcohol days are generally between or on either side of those for the normal days. Diagrammatically the relationship is shown in figure 25, the general

tendency falling somewhat (4.0 to 4.75) on the side of the less-frequent responses on the alcohol days.

In figure 25 the average usualness of response in the two series D and D' is plotted for the four experimental days. The dotted lines give a theoretical construction of the probable effect of equalizing the two series. The dotted line, 6.6 to 3.4, shows the probable effect of practice. The difference between the middle points of the two solid lines shows the probable effect of alcohol.

In reference to the apparent inequality of the two series for these subjects, there were indications that the whole psychological "set" of the responses was different from that of the Kent-Rosanoff tables, as is shown in table 17.

An illustration from table 17 may serve to make it clearer for those who are not familiar with the association experiment. The first line of the table relates to the use of the stimulus word "table." When our subjects heard that word, in 50 per cent of the cases they gave the associate "cloth." The frequency of that association is consequently 50 per cent. The same associate also occurred in the Kent-Rosanoff experiments, but its frequency was only about one-tenth as great as in our subjects, namely, 5.7 per cent.

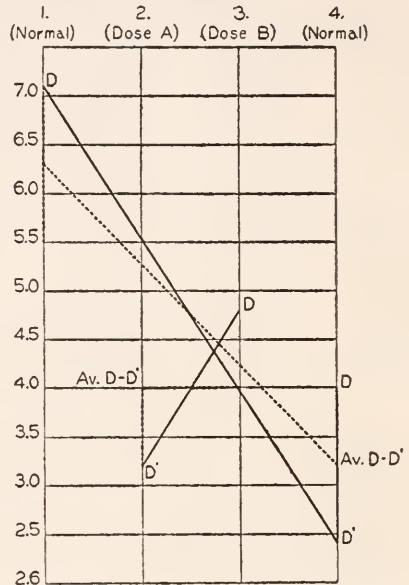

FIG. 25.—Curves of the usualness of the association.

TABLE 17.—Characteristic differences between our subjects and those of Kent-Rosanoff.

Stimulus and associate.	Value in the Kent-Rosanoff tables.	Proportional value with present subjects.
	<i>p. ct.</i>	<i>p. ct.</i>
table-cloth	5.7	50.0
deep-sea	9.0	71.4
slow-train	1.8	42.9
spider-web	18.8	71.4
stem-pipe	7.0	42.9
stem-plant	7.4	42.9
dream-sweet	1.4	50.0
ocean-wave	1.2	57.1
soft-pedal	0	28.6
comfort-home	6.3	42.9
fruit-tree	3.5	42.9
wish-bone	1.9	57.1
window-pane	8.2	71.4
rough-sea	1.5	42.9
red-hair	0.6	42.9
eagle-eye	1.2	57.1

CORRELATIONS BETWEEN THE VARIOUS MEASUREMENTS.

Owing to the exceptional opportunity, certain measurements of correlation were made, though they do not bear directly on the alcohol question. First, with reference to whether those who have more usual responses also have shorter or longer reaction times. This was the only definite relationship observed, the Pearson r 's¹ being in the four experiments respectively -0.75 , -0.50 , -0.53 , and -0.33 . That is, the person who gives usual responses seems also likely to have shorter reaction-times, as is not difficult to understand. It does not follow so pronouncedly that the usual reactions of a certain individual are quicker than his unusual ones, though there is a tendency in this direction. There appeared no significant correlation between frequency and pulse-change, or between pulse-change and reaction-time. Even when extreme cases only are considered, there was no special tendency for the longer reaction-times to be accompanied by larger pulse-changes, as table 18 shows.

In table 18 we attempt to indicate the correlation of the pulse-change and reaction-times, by comparing the average latency of the 5 reactions that had the largest pulse-change with the average latency of the 5 reactions that had the least pulse-change. These values, together with their mean variations, are entered under the appropriate legend for each subject. A comparison of the average reactions is entered for each subject in the extreme right-hand column as the average excess of reaction-times with high pulse-change over those with low pulse-change. The extreme irregularity of these results shows an absence of correlation between pulse-change and reaction-time. This is interesting, in view of the fact that both increased pulse-rate and long time-reactions have been suggested as indicators of the same thing, *i. e.*, an emotional complex. (Coriat.²) No correlation between the pulse-change and the galvanometer readings taken in connection with the so-called psycho-galvanic reflex was observed.

Table 19 gives the relationships that were calculated between the reaction-time and the frequency of response, between pulse-changes and frequency, and between reaction-time and pulse-changes, series D'.

¹Pearson's coefficient of correlation, r , was computed according to the familiar formula: $r = \frac{\sum xy}{n \sigma_1 \sigma_2}$ in which the x 's are the series of deviations from the median in the first group of data and the y 's are the deviations from the median in the second group; σ_1 is the standard deviation of the first, σ_2 is the standard deviation of the second group; and n is the number of cases. Zero resulting from such a computation would show that the values in the two groups have no correlation. Plus values in the coefficient of correlation show that the values are positively correlated; *i. e.*, increase in one group is more or less regularly accompanied by increase in the other group. Minus values in the coefficient show that the values are negatively correlated, *i. e.*, that an increase in the one is accompanied by a decrease in the other. Absolute positive or negative correlation is indicated by $+1$ and -1 respectively. Our results indicate that in our experiments there was considerable negative correlation between the duration of the reaction and the "frequency" of the response; that is, the longer reaction-times tended to correspond with the less common associates.

²Coriat, Journ. Abnormal Psychol., 1909, 4, pp. 1 and 261.

TABLE 18.—*Correlation between pulse-change and reaction-time.*

Subject and series.	No. of reactions in series.	High pulse-changes (5 highest).		Corresponding reaction-times.		Low pulse-changes (5 lowest).		Corresponding reaction-times.		Average excess reaction-times with high pulse-changes over those with low pulse-changes.
		Average.	Mean variation.	Average.	Mean variation.	Average.	Mean variation.	Average.	Mean variation.	
Subject II:										
A.....	50	12.4	3.4	308	32	0	0	228	48	80
B.....	48	12.0	2.8	486	382	0	0	195	17	291
C.....	24	13.2	3.0	243	75	0	0	225	59	18
D.....	31	13.6	2.4	155	17	0	0	159	34	- 4
E.....	16	11.4	3.6	253	83	0	0	282	112	- 29
F.....										
Subject III:										
A.....										
B.....										
C.....	21	6.6	1.2	205	33	0.8	0.2	195	34	10
D.....	50	10.8	2.6	178	18	0	0	188	57	- 10
E.....	25	8.4	1.2	222	70	0.4	0.5	197	26	25
F.....	42	14.4	4.4	198	17	0	0	202	16	- 4
Subject IV:										
A.....	22	5.0	0.8	249	71	1.0	0.4	203	33	46
B.....	27	7.0	2.0	214	28	1.4	0.8	239	33	- 25
C.....										
D.....	29	9.6	1.2	215	31	0	0	222	48	- 7
E.....										
F.....	15	12.0	2.8	180	39	2.0	0.8	271	26	- 91
Subject VI:										
A.....	43	16.0	3.2	292	68	4.8	2.6	172	15	120
B.....	47	14.0	1.2	229	30	3.0	0.8	173	25	56
C.....	43	15.2	0.6	253	11	3.4	1.2	179	27	74
D.....	42	13.6	2.0	182	14	1.6	0.8	173	14	9
E.....	50	18.4	2.8	224	39	1.4	1.2	165	12	59
F.....	38	15.2	1.0	210	19	3.2	0.6	209	44	1
Subject VII:										
A.....	49	15.6	1.2	219	33	2.0	0.4	184	25	35
B.....	50	14.2	0.6	250	57	1.4	1.2	193	28	57
C.....	45	11.8	1.4	253	27	1.6	0.8	232	66	11
D.....	26	10.4	1.6	243	49	1.0	0	181	8	62
E.....	48	12.4	1.2	189	16	1.2	0.6	185	29	4
F.....	45	11.0	1.2	253	71	1.2	0.6	220	27	33
Subject IX:										
A.....	33	20.0	2.6	334	67	3.0	1.2	353	190	- 19
B.....	46	19.0	0.8	405	121	2.6	1.4	198	13	207
C.....	26	18.2	1.4	275	32	2.0	1.6	270	41	5
D.....	35	21.0	1.0	231	20	4.8	2.2	255	36	- 24
E.....	29	18.2	2.2	265	23	2.0	1.6	217	35	38
F.....										

TABLE 19.—*Measurements of relationships calculated from Kent-Rosanoff list D' for normal experiment II.*

Subject.	No. of cases.	Reaction-time and frequency.		Pulse-change and frequency.		Reaction-time and pulse-change.	
		Preponderance of + signs over median.	Pearson's <i>r</i>	Preponderance of + signs over median.	Pearson's <i>r</i>	Preponderance of + signs over median.	Pearson's <i>r</i>
II....	48	<i>p. ct.</i> 46	-0.09	<i>p. ct.</i> 56	-0.11	<i>p. ct.</i> 55	+0.11
III....	50	40	-.24	56	-.03	50	-.09
IV....	44	23	-.57	61	+.27	45	-.08
VI....	48	33	-.34	50	+.06	44	+.03
VII....	50	48	+.03	50	-.14	58	+.06
IX....	23	52	+.28	39	+.28	70	+.16

The present doses of alcohol have therefore produced in the associative responses only very few and small consistent effects that are measurable by available techniques.

SPECIAL EPISODES.

Special episodes occurring in the course of the experiments as spontaneous remarks by the subject and the like, were noted in shorthand. Two of these occurrences are worth mentioning here. On two occasions Subject II dropped asleep between association words and had to be aroused. The experimental data in this connection were:

Feb. 3, 1914, 5 ^h 30 ^m p. m. series: pattern-scissors. cliff-(asleep; roused after 20 to 30 seconds). level-rule.	Feb. 17, 1914, 5 ^h 25 ^m p. m. series: scissors-cut. quiet-(asleep). street-number.
---	---

The point of these occurrences is that a subject within 10 seconds after responding properly in an experiment involving some complexity of mental process could so completely lose consciousness as to be able to make no response at all, and after arousal could immediately take up the process at apparently the same level as before.

The experiment on March 6, 1914, with Subject VII showed a very marked fluctuation in the number of speech-habit associations corresponding with a change that the subject described in his mental condition. The numbers of the speech-habit associations in the successive series were as follows:

Series	4 ^h 10 ^m p. m.	4 ^h 35 ^m p. m.	5 ^h 05 ^m p. m.	5 ^h 30 ^m p. m.	6 ^h 00 ^m p. m.	6 ^h 20 ^m p. m.
Speech-habit associations.	10	8	16	22	18	8

There is an increase in the speech-habit associations which later falls off. At the end of the 5^h 05^m p.m. series the subject complained of sleepiness. At the end of the 5^h 30^m p.m. series he says: "I notice that I am using compound words to-day; that is, the word comes right after it. I am quite tired. My decision follows the path of least resistance." At the end of the 6^h 20^m p.m. series, when the speech-habit reactions have fallen back to the starting-point, he says: "I am not sleepy now as I was then; feel more comfortable. The associations seem different; for *smoke* I might now say *tobacco*, while before I would be more apt to say *stack*."

This condition of normal sleepiness seems, therefore, related in the subject to a change in the character of the associations in the same direction as the alcohol effects, but to a far greater amount. An abnormally great number of speech-habit reactions was also noted in this subject in the first series on February 27. Here the subject states that he "does not understand the words clearly, having a cold which interferes with his hearing." Probably every worker with the experiment has had the experience, with Wells, that indistinct hearing of the stimulus word conduces to speech-habit reaction.

CHAPTER V.

EFFECT OF ALCOHOL ON THE PROCESS OF MEMORIZING.

There have been no complete systematic investigations of the effect of alcohol on the memory. Only a few of its many phases have been studied, and these have been selected apparently at random. The relatively inaccessible work of Vogt¹ seems to be the only extensive study of the effect of alcohol on the ability to learn logical material in metrical form. The pioneer work of Kraepelin² and the later work of the Kraepelin school is based on the continuous memorizing of series of numbers. But since number memory and poetry memory are special forms with their own peculiar laws, our knowledge of the effect of alcohol on the memorizing process is still very incomplete. Possibly this is because all the classical techniques make such demands on the intelligent coöperation of the subject that they are poorly adapted for alcohol experiments. Whatever the cause, lack of investigation of the changes in memory that are affected by alcohol is one of the most conspicuous deficiencies in our knowledge of the effect of alcohol on the neural tissue. This deficiency is the more striking because, in any psychological view of normal life, memory is a fundamental psychophysical process. It is the more embarrassing because quantitative objective techniques for measuring changes in memory are so rare.

The classical method that seemed to us likely to make the least demands on the active coöperation of the subject was the memory-span method that in many hands has proved so valuable an indication of individual differences. But we found in preliminary trials that when given in sufficient number to yield data for satisfactory statistical treatment, even the memory-span experiments seem exacting, tedious, and often repulsive to the average subject. Besides this, they seem to be subject to enormous practice effect, as well as an indefinite number of unknown subjective and objective conditions that, in view of the principles of this research, completely disqualified them for our use.

The memory-span method, like most of the many recent methods for testing the memory process, has been developed as a short cut to the Ebbinghaus³ method of complete memorization. The latter is yet the standard method, but it is enormously time-consuming, tedious, and fatiguing. It is impractical for untrained subjects. In such studies as ours some short cut is essential if memory measurements are to be included at all. The underlying principles of the short cut that we

¹Vogt, *Norsk Magazin f. Laegevidenskaben*, 1910, 8, p. 605.

²Kraepelin, *Ueber die Beeinflussung einfacher psychischer Vorgänge durch einige Arzneimittel*, Jena, 1892.

³Ebbinghaus, *Ueber das Gedächtnis*, Leipsic, 1885.

finally adopted followed as far as possible the original complete memorization method of Ebbinghaus, except that in our arrangement memorization need not be completed. Ebbinghaus measured the total number of repetitions that it took to enable a subject to learn a series of nonsense syllables, that is, to speak the words of the series without prompting. We sought to measure the value of each repetition by its saving in the reaction-time of successive members of the series as they were exposed seriatim. We measured the reaction-time of each word, instead of that of the group process. An analogous short cut in the psychology of reading is to measure the reaction to individual words instead of the total time it takes to read a page. In certain respects our method resembles the Müller and Pilzecker's¹ *Treffmethode*, but instead of "paired" associates, our associates were continuous, and the decrease of the reaction-time in successive repetitions of the series showed the increase of perseveration. The technique is the direct outgrowth of Professor G. E. Müller's lectures on memory measurements, which one of us was fortunate enough to attend at the University of Göttingen in the winter of 1910-11. We would hereby express our obligation to Professor Müller, while expressly disclaiming for him any faults in our technique. According to the theory of our method, any saving of time between the reaction-time in responding to the first exposure of a series of words and the reaction-time in responding to the second exposure must be due to the influence of memory. The memory process itself would be complete when the reaction-time for each member of the series is zero or less; that is, when each member of the word series could be pronounced before it appeared, as in the complete memorization of Ebbinghaus.

This method seemed to satisfy our demand for a practiced process. To be sure, words are not commonly read during a gradual exposure; certainly not during the kind of exposure that was used in our experiments. But, after all, something not so very different appears to be involved in all rapid reading. Only a part of the words of a page are actually fixated by the reader. Most of them are read chiefly or partly in indirect vision where the visual cues to the identity of the words are few. The more familiar the text the fewer the words that are actually fixated, and the more significant become the imperfectly seen cues of extra-foveal vision, and the more important are the central or memory factors in the process. Fundamentally, then, the method is as practiced and natural as the process of reading itself.

A special device to procure a slow, gradual increase in the visual exposure of the words, so that reaction differences might be exaggerated, was to expose the words backwards one letter at a time. This insured a gradually increasing number of cues to the identity of the word, until,

¹Müller and Pilzecker, *Experimentelle Beiträge zur Lehre vom Gedächtnis*, *Zeitschr. f. Psychol., Ergänzungsband*, 1, 1900.

as the first letter appeared, the visual word was complete. We exposed the words backward instead of forward because the final letter of a word is the least definite cue that could be given. Final letters are much less suggestive than initial letters. Moreover, when the end letter is shown first, the correct pronunciation can not begin unless the whole word is revived in consciousness. If the initial letters were shown first, articulation might start correctly before the word was fully known.

In spite of its theoretical plausibility, its relatively small demands on the active coöperation of the subject, and the probability that it corresponds more or less closely to a common practice of extra-laboratory life, our method for obtaining quantitative expression of changes in retentiveness is the one of our techniques which developed most serious defects in use. We incline to believe, however, that the principle of the technique is valid and useful, and that only the form in which we used it is faulty. Its defects are not peculiar to our technique. They are due to the difficulty of securing really homogeneous material for memorizing. This constitutes a universal source of difficulty in all quantitative investigation of the memory process. Vogt¹ remarks it in his poetic material. Differences in the associability of material exists even in the Müller-Schumann² development of Ebbinghaus nonsense syllables. Only the elaborate scheme of Müller and Pilzecker³ for presenting the material in every possible order completely obviates this source of error. In the effort to equalize the associability of the memory material, Ebbinghaus,⁴ and, following him, most of the German investigators emphasize the value of nonsense syllables. In his excellent review of the various memory techniques, Pohlmann⁵ regards nonsense syllables as the best experimental material. In English, however, nonsense syllables are not so satisfactory as they are in German. As Miss Gamble⁶ has pointed out, special rules are necessary for the construction of English nonsense syllables, while "no devices seem to make the reading and spelling of English nonsense syllables a simple matter for all American college students." Our vowel signs are relatively few and superlatively ambiguous without arbitrary rules. There are very few nonsense syllables of three letters that may not be pronounced so as to resemble or to recall a significant word in some language that the subject may know. Differences in pronunciation in successive repetitions may completely change the series. There is no way by which the spelling can be guaranteed to give the same series of words to two different subjects except by the adoption of artificial rules.

¹Vogt, *Norsk Magazin f. Laegevidenskaben*, 1910, 8, p. 605.

²Müller and Schumann, *Zeitschr. f. Psychol.*, 1894, 6.

³Müller and Pilzecker, *Experimentelle Beiträge zur Lehre vom Gedächtnis*, *Zeitschr. f. Psychol.*, *Ergänzungsband*, 1, 1900.

⁴Ebbinghaus, *Ueber das Gedächtnis*, Leipzig, 1885.

⁵Pohlmann, *Experimentelle Beiträge zur Lehre vom Gedächtnis*, Berlin, 1906.

⁶Gamble, *Wellesley College Studies in Psychology*, No. 1. *Psychological Monograph* No. 43, 1909; esp. pp. 18-23.

Believing that, in English at least, real words represent the least individual differences in apprehension, we abandoned the nonsense syllables for real English words. In some respects at least it is a distinct advantage not to complicate the word series in memory tests by a superposed letter series. In the case of words, we may assume that the association between their spelling and the pronunciation is familiar and fixed. Drawing from an equally well associated and equally revivable mass of possible material, the process of memorizing words is not complicated by the necessity for memorizing the constitution of the members of the series. It is concerned solely with their serial connection.

APPARATUS AND TECHNIQUE.

Normal series of 12 four-letter words were printed on strips of white paper, 52 cm. in length, so that each word occupied the same proportion of a 4 cm. space. Such a slip encircled the 50 cm. Blix-Sandström kymograph drum, leaving 2 cm. spare space to indicate the beginning of the series, as well as to accommodate the paper clip that held the strip of words to the drum. A circular screen, with a slit large enough to expose two letters at a time, covered the drum and consequently the series of words, except as each word was exposed letter by letter when the drum revolved. The screen and electrical connections are shown diagrammatically in figure 26.

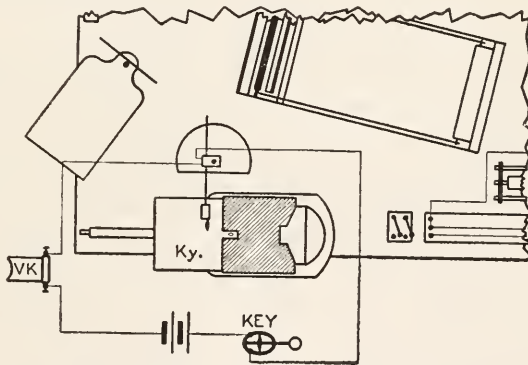

FIG. 26.—Diagram of the connections for memory experiment.

As each word was perceived the subject spoke it into the voice key (for description of this key, see Chapter III, p. 97), and so broke the circuit of an electric marker that wrote the record of the reaction on the same cylinder which carried the words. Since both stimulus and reaction records were on the same evenly rotating drum, the correlation of the two was permanent and mechanically accurate. Any advance of the reaction record along its base-line on the second revolution of the drum showed the effect of memory and was taken as its measure. Since the cylinder moved at a rate of 10 mm. per second, the change

with the letter concerned, the visual word was complete. We exposed the whole word at once and at the same time the final letter of a word in the same manner as the whole word. Final letters are much less important than initial letters. Moreover, when the final letter is shown first, the word is recognized more easily than when the whole word is shown first. If the initial letter were shown first, the word would be recognized more easily than when the whole word is shown first.

In order to understand the relatively small demands on the visual perception of the subject, and the probability that it is not a matter of less clarity to a common practice of extra-laboratory things, we should be describing quantitative expression of changes in the intensity of the use of our techniques which developed most rapidly during the war. We would like to believe, however, that the principle of the technique is valid and useful, and that only the form in which it is applied is faulty. The defects are not peculiar to our technique. They are due to the difficulty of securing really homogeneous material for reading. The constant and personal source of difficulty in all quantitative measurements of the memory process. Vogt remarks it in an early manual. Differences in the availability of material may be seen in the *Wahrnehmungsentwickelung* of Ebbinghaus non-words series. Only the elaborate scheme of Miller and Pilzecker's for presenting the material in every possible order completely obviates this source of error. In the effort to equalize the availability of the memory material, *Strophensatz* and, following him, most of the German investigators emphasize the value of nonsense syllables. In his excellent paper on the various memory techniques, Pohlmann regards nonsense syllables as the best experimental material. In English, however, nonsense syllables are not so satisfactory as they are in German. A. H. Fowler has pointed out, special rules are necessary for the collection of English nonsense syllables, while "no devices need be used for the reading and spelling of English nonsense syllables a single method for all languages will be suitable." Our vowel signs are relatively free and unambiguously ambiguous without arbitrary rules. There are no two nonsense syllables of those letters that may not be pronounced in the same way. Differences in pronunciation in nonsense syllables may occur. Differences in pronunciation in nonsense syllables may completely change the series. There is no way by which the reading can be guaranteed to give the same series of words as the original material except by the adoption of special rules.

1. The word 'series' is used in a technical sense. It does not mean a list of words, but a list of words which are read in a certain order. The order of the words in the series is determined by the order in which they are read. The order of the words in the series is determined by the order in which they are read.

English at least, no words represent the least in apprehension or abandoned the non-sensuous words. In some respects at least it is a dis- complicate the two series in memory tests by ies. In the case of words, we may assume that their spelling and to pronunciation is familiar from an equally well associated and equally able material, the process of memorizing words the necessity for memorizing the constitution series. It is composed solely with their serial

PARATUS AND TECHNIQUE.

four-letter words was printed on strips of white so that each word occupied the same proportion of a slip encircled to 50 cm. Blix-Sandström giving 2 cm. spare space to indicate the beginning as to accommodate to paper clip that held the drum. A circular screen, with a slit large enough at a time, covered the drum and consequently the as each word was crossed letter by letter when The screen and electrical connections are shown figure 26.

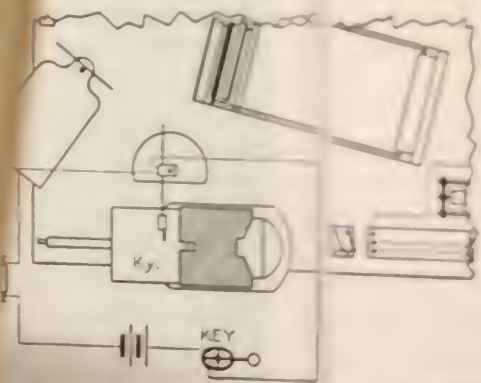

26.—Diagram of the connections for memory experiment.

was perceived the subject took it into the voice key of this key, see Chapter II, p. 97), and so breaks the electric mark... record of the reaction under which... both stimulus and... the correlation... advance... of

EXPERIMENTAL PROCEDURE.

The subject sat before a horizontally placed Blix-Sandström kymograph, in line with its axis of rotation in position I (fig. 1); through a slit 14 mm. wide in the cylindrical screen, which was concentric with the kymograph drum, a series of 4-letter words was exposed backwards, *i. e.*, in such a way that the last letter of each word appeared in the slit of the screen first and the first letter appeared last. A series consisted of 12 words. Each series was repeated 3 times. During the first reading of the series each word must have been completely exposed before the first letter was known and before the word was spoken. In the two succeeding readings, residua of the first series effected a certain saving in reaction-time. The word might then be spoken while one or

TABLE 21.—*Effect of alcohol on memory.*
[Average values given in thousandths of a second.]

Subject.	Average saving.		Effect of alcohol ¹ (alcohol — normal).	Percentile effect. ²
	Normal.	Alcohol.		
Normal subjects:	σ	σ	σ	<i>p. ct.</i>
II.....	932	939	+ 7	+ 0.6
VI.....	761	856	+ 95	+ 8.7
VII.....	1,382	1,189	-193	-13.1
VIII.....	1,005	974	- 31	- 4.1
IX.....	921	881	- 40	- 3.9
X.....	980	1,071	+ 91	+ 7.0
Average.....			- 12	- 0.8
Psychopathic subjects:				
XI.....	524	517	- 7	- 1.3
XII.....	714	855	+141	+16.0
Average.....			+ 67	+ 7.3

¹Effect on the average saving equals alcohol average minus normal average.

²Percentile effect equals the effect of alcohol on the average saving divided by the average saving of the corresponding normals of the day.

more of the letters were still hidden. In a perfect score each word was spoken before any letter appeared on the second or third exposure. Perfect scores often occurred for the first word of a series. Only one subject regularly achieved perfect scores for practically all the series in three exposures. The saving in reaction-time between the first and the two succeeding exposures is regarded as a measure of the advancement of the memorizing process.

With the drum revolving at the rate of 10 mm. per second and the words 4 cm. apart, the time-interval from the beginning of one word to the beginning of the next was 4". The duration of the whole series was 48" for the words, plus 2" for the spare space at the end of the series. The whole memory experiment of three repetitions thus lasted about 3 minutes. The relative shortness of the experiment is of double advantage; it not only conserves time during the experimental period,

but it saves the subject from the tedium and ennui of the classical methods.

Relatively slight disturbances of attention during the series show immediately and directly in the record by a lengthening of the corresponding reaction-time beyond that of the previous exposure. Such disturbances are universal after a false reaction has been made. They are difficult to score simply, but should doubtless be considered in some way in the results. False reactions must be marked on the record by the experimenter. Their time was excluded in computing the total saving, but a record of them was kept for comparison with future experiments.

SUMMARY OF THE EFFECT OF ALCOHOL ON MEMORY.

The results of our experiments on the effect of alcohol on memory are summarized in table 20. While different subjects vary widely in the effect of alcohol on the memory process as measured by our technique, the total results show no predominant tendency of alcohol on the main group of subjects. As far as our measurements go, rote memory (primary retention) is neither better nor worse after small doses of alcohol.

It is interesting to note that the most pronounced improvement of memory after alcohol was found with Subject VI, who frequently differed notably from the group in other experiments. Under ordinary circumstances, he was the most easily confused of the group. He was particularly liable to become disturbed and to get "rattled," as he put it. The most pronounced decrease of capacity after alcohol was shown by Subject VII, who depended least on simple perseveration and most on quickness in forming artificial associations to memorize the series. It is not impossible that the same depression of the capacity for making new associations that decreased the effectiveness of Subject VII may have relieved Subject VI from intercurrent mental disturbances.

CHAPTER VI.

EFFECT OF ALCOHOL ON THE SENSORY THRESHOLD FOR FARADIC STIMULATION (MARTIN MEASUREMENTS).

In a series of papers published in the *American Journal of Physiology* between the years 1908 and 1911, Professor E. G. Martin,¹ of the Harvard Medical School, developed a method for measuring induction shocks. Starting with a properly calibrated inductorium of standard construction, it is now possible to include in a single equation all the various physical factors which are involved in the production of an induction shock of threshold intensity. The absolute threshold of a tissue may be expressed in units which are directly comparable wherever properly calibrated instruments are used. To these units Professor Martin has given the name β units. Their use involves more experimental data and considerably more mathematical elaboration of the data than has previously been customary in measurements of threshold for Faradic stimulation. The experimental procedure, however, is simple and the mathematical work with Wilbur's² simplification of the Martin equation is now neither difficult nor extravagantly time-consuming. For the theoretical derivation of the various formulæ, we must refer to Professor Martin's papers, especially to his book, "The Measurement of Induction Shocks."

We can scarcely overestimate the advantages to experimental psychology of a sensory threshold technique in which the stimuli can be expressed in absolute units of electrical energy. The high standards of instrumental accuracy, the ease of manipulation, and general availability of electrical stimuli, the simplicity of the skin receptors, and their freedom from complicated adjustments seem to make the threshold for Faradic stimulation the simplest and most satisfactory sensory-threshold measurements at our disposal. The recent criticisms of inductorium calibration by Erlanger and Garrey³ do not affect the fundamental value of the method (Martin⁴). Like all threshold measurements, however, in which one must depend on the verbal reports of the subject, the Martin threshold probably depends for highest accuracy on the subject's training in observation. There is at present no means for analyzing the sensory process, to determine in how far apparent variations in the threshold of any particular subject depend on changes in central conditions of perception, on interest, attention, alertness, etc. Our experience suggests that some indicator for the

¹Martin. a. *Am. Journ. Physiol.*, 1908, **22**, p. 116.

b. *Am. Journ. Physiol.*, 1909, **24**, p. 269.

c. *The Measurement of Induction Shocks*, New York, N. Y., 1912.

²Martin, Bigelow, and Wilbur, *Am. Journ. Physiol.*, 1914, **33**, p. 415.

³Erlanger and Garrey, *Am. Journ. Physiol.*, 1914, **35**, p. 377.

⁴Martin, *Am. Journ. Physiol.*, 1914-15, **36**, p. 223.

grade of attention is of vital importance to satisfactory measurements of the human threshold by the Martin method in untrained subjects.

Of scarcely secondary importance seems to be the precise technique by which the operator satisfies his scientific conscience that any given position of the secondary coil of the inductorium corresponds to the probable true threshold of the subject. As Grabfield and Martin¹ state, "The threshold position found by moving the coil in, is often several millimeters away from the threshold position moving it out." To make their experimental conditions uniform, Grabfield and Martin discarded the threshold readings which were found when the coil was moving out¹ (p. 304). It is not impossible, however, that this very discrepancy may serve as an indicator of the grade of attention, since variations of attention seem to produce it, and there seems to be no other ground for its existence. In our experience we have always found successive threshold positions, even in the same direction, to vary more or less. Our earliest measurements were based on the standard psychophysical method of averaging the threshold values found by increasing and decreasing the stimulus respectively. It is commonly assumed in psycho-physics that the true threshold lies between the apparent threshold, which is found when a subthreshold stimulus is increased, and that found by decreasing a suprathreshold stimulus. The difficulty with this procedure in the present instance is probably due to a fatigue of attention. A somewhat later procedure was to take the highest value that was found three times out of five. This obviously produced fatigue effects, since the first values were regularly higher than the later ones. All values reported in this paper under dates subsequent to January 1, 1914, were found by averaging the first three ingoing threshold positions of the coil. Professor Martin kindly informed us that his present procedure is to repeat the ingoing movements of the coil until two thresholds agree. While this seems statistically somewhat arbitrary, his results are much more regular than ours.

Our variation of procedure should affect materially only the level of measurements on different days. Differences between the successive series on one day should still be comparable with the differences between successive series on another day, even though the actual values are somewhat higher or lower on the different days. Since our whole statistical treatment is based on these serial differences rather than on average levels, our variations in procedure, as regrettable as it was unavoidable in the present stage of experience with the Martin threshold, are not vital to our main problem.

A further difficulty connected with the use of the sensory threshold for electrical stimulation is the nature of the sensation whose threshold is measured. Probably it may safely be said that threshold induction shocks are never felt as simple touch or pressure sensations. Martin, Porter, and Nice² report an apparent difference in the sensations, and

¹Grabfield and Martin, *Am. Journ. Physiol.*, 1912-13, **31**, p. 300.

²Martin, Porter and Nice, *Psychol. Review*, 1913, **20**, p. 194.

a probable difference in the receptors, when wire or needle electrodes are used instead of fluid electrodes. In the former case, the sensory effect was sharply localized and the receptors were probably superficial. In the latter case the effect was more diffuse and the receptors were probably those for deep sensibility. For one of their subjects, who had a slight abrasion of one finger, each shock produced a distinct throb of pain when that finger was used.

Our own experience corresponds with this report. A cut or scratch always occasioned a sharply localized, superficial pricking sensation. The ordinary deep sensibility quality seemed to resemble that of a slight, involuntary muscle-twitch. The apparent location of this sensation, as reported by our subjects, was not necessarily at the point of application of the electrodes, but usually at some more or less remote point, often just above or between the fingers. Changes in the apparent position of the sensation occasioned some disturbance. It seems clear that the sensation quality of threshold electrical stimulation differs from that of more intense electrical stimulation. It was noticed that even threshold stimulation seemed to produce a different sense quality at different times. It seemed sharper and quicker at some times, duller and slower at others.

A further difficulty that we encountered is the variability in the degree of assurance that the sensation is present, which was demanded by different subjects, and by the same subjects at different times. It was not infrequent for a subject to say, "I really felt it before I pressed the signal key, but I was not sure." There are objective evidences of this difference. Dr. Wells kindly served as subject for two days' Martin-threshold experiments, one with alcohol and one without. His introspective notes show that he was aware of his being more easily satisfied of the presence of the sensations on the alcohol day. This is proved to be correct by his records. They show that whereas without alcohol, that is, on the normal day, he never once reported a sensation when there was no stimulus; on the alcohol days such errors were very numerous. Especially in experiments on the effect of drugs, we believe that such differences of critical reliability should be taken into account. They may be really more important for an understanding of the drug action than the apparent changes in the threshold level. Unfortunately, our realization of the possible importance of this secondary phenomenon came too late to enable us to collect systematic data. We have occasional notes, however, to indicate that other subjects showed a similar tendency, especially under the influence of the larger dose of alcohol. This experience leads us to a good working hypothesis as to the probable nature of the new factor that the results indicate must have influenced the threshold under the larger dose of alcohol. It must be remembered that the receptors of a finger immersed in a liquid are never entirely unexcited. Temperature and pressure sensations are present at first. Even after adaptation or fatigue makes them indis-

tinct, they may on occasion flash out intermittently. Furthermore, the throb of the pulse and slight muscle-twitches often appear to concentrated attention. Geissler¹ found pulse sensations to interfere with minimal-weight sensations. There may thus be some purely physiological grounds for the errors which occur under higher doses of alcohol, especially when, as our observations in Chapter VIII show, this is accompanied by an accelerated pulse.

In general, we may say that a thoroughgoing psychological exploitation of the Martin-threshold measurements will probably take into account fatigability, differences between the threshold to increasing stimuli and the threshold to decreasing stimuli, the number and distribution of errors, as well as actual changes in the apparent threshold level. Unless changes in the skin-resistance are considerable, we believe it will be more profitable psychologically to neglect the absolute β value, after it is once determined for a given subject and day, and to concentrate attention on a statistical treatment of the simplest threshold measurements at skin resistance (Martin Z units). β values and Z values are commonly parallel in any event. Concentration on Z measurements will consequently not impair the relative significance of the results, while it may give important indications of varying subjective conditions.

APPARATUS AND TECHNIQUE.

The general arrangement of apparatus for the sensory threshold to Faradic stimulation (Martin measurements) is seen in figure 14, page 95. Inductorium, mil-ammeter, and resistance boxes are seen to occupy the lower right-hand corner of the main apparatus table. KI indicates the Kronecker inductorium, which was calibrated for the Nutrition Laboratory by Professor Martin. The Martin key for breaking the primary circuit under a column of mercury is not shown in the diagram. In our early experiments, it was operated by an assistant in an adjoining room. In all the data which are reported in this paper subsequent to February 1, an electrically operated key of similar construction was used. A simple contact device held in the operator's hand caused the key to make and break the primary circuit of the coil. A indicates the mil-ammeter. It was continuously in the primary circuit, and served to indicate not only any accidental change in the amount of primary current, but also the exact moment of each stimulation. R^6 is a non-inductively wound resistance-box, ranging from 10,000 to 100,000 ohms resistance. This resistance served to introduce a known resistance of 20,000, 30,000, and 40,000 ohms respectively into the secondary circuit. By use of the double switch at the left, this same box also served as a standard resistance for measuring the skin-resistance by the Kohlrausch method. The alternating current for measuring the skin-resistance was furnished by a Porter inductorium which is not shown in the diagram. Connections for

¹Geissler, Am. Journ. Psychol., 1907, 18, p. 309.

measuring the skin-resistance were carried to the galvanometer table, whence they might be switched to the string galvanometer for optical measurements, or to a suitable high-resistance watch-case telephone receiver for the acoustic method. The electrical connections for the system are diagrammatically represented by the fine lines with appropriate legends.

Position of the subject.—Two positions were occupied by the subject for sensory-threshold measurements by the Martin method. In the earlier measurements and in the 12-hour experiments, the subject reclined in a comfortable chair in position I, figure 1. In the measurements which form the bulk of the experiments here reported, that is, in all measurements which were made on Subjects II to X subsequent to January 3, 1914, the subject reclined in a steamer-chair on the balcony of the laboratory. In the former case, threshold measurements were a part of Group I of the experimental series. In the latter case, threshold measurements alternated with association experiments. In every respect the balcony position corresponded more closely with the conditions that are recommended by Martin. In this position the subject faced a blank wall and responded to the stimulation by signaling with a telegraph key. When position I was used and the subject sat in the same room with the apparatus, the inductorium and its connections were hidden from view by other apparatus. In this case the subject indicated a perceptible stimulation by saying "now" or "yes." It is doubtless always more or less unsatisfactory to have the subject in the same room with the apparatus, even when the utmost precautions are taken to prevent his hearing the key or seeing the movements of the secondary coil. If the threshold work alone was under consideration the ideal condition of isolating the subject could be rigidly enforced. When a series of measurements was undertaken, such as ours was, such isolation becomes more difficult. Periodic movement of the subject from one room to another would have been indefensible in our case. Nevertheless, it seems probable that with increasing definiteness of the various controls in this type of experimentation isolation of the subject from the apparatus, both for the threshold measurements and for other psychological experiments, must not be neglected.

Electrodes.—In all our threshold experiments zinc sulphate non-polarizable electrodes were used. Amalgamated zinc electrodes were immersed in concentrated sulphate of zinc. The fingers were placed in a porous porcelain inner vessel in which there was a physiological salt solution. Martin reported that the value of β was not changed by changes in the amount of the finger immersion. Assuming on this ground that it made no difference, we found it more convenient to have only the first joint of the finger immersed.

Primary current.—For sensory threshold experiments we universally used a primary current of 0.5 ampere taken from two accumulators of

large capacity. The amount of the current was regulated by two slide resistances, of which the fine adjustment only is represented in figure 14 as a slide-wire resistance at the front of the table.

Application of the electrodes.—The fingers to which the electrodes were applied were usually the index and middle fingers of the right hand. In case of abrasion of either of these fingers, or for any accidental reason that rendered their use inexpedient, the third and fourth fingers of the same hand were used.

RESULTS.

A full summary of our available data on the sensory threshold to electrical stimulation by the Martin method is given in tables 22 and 23.

TABLE 22.—*Threshold measurements for Faradic stimulation.*
[Values given in Martin units.]

Subject, date, and number of period.	Normal.				Subject, date, dose, and number of period.	Alcohol.			
	Average.		Difference. ¹			Average.		Difference. ¹	
	Z	β	Z	β		Z	β	Z	β
<i>Subject II.</i>					<i>Subject II.</i>				
Jan. 6, 1914:					Jan. 13, 1914:				
Dose A:					Dose A:				
1.....	274	136	1.....	² 326	² 204
2.....	274	139	0	- 3	2.....	385	223	- 59	- 19
3.....	274	136	0	0	3.....	361	⁽³⁾	- 35
4.....	281	135	- 7	+ 1	4.....	409	203	- 83	+ 01
Average....	276	136	- 2	- 1	5.....	409	235	- 83	- 31
Feb. 17, 1914:					6.....				
1.....	277	148	6.....	349	152	- 23	+ 52
2.....	274	149	+ 03	- 1	Average....	383	203	- 57	+ 1
3.....	262	147	+ 15	+ 1	Feb. 3, 1914:				
4.....	289	172	- 12	- 24	Dose B:				
5.....	294	151	- 17	- 3	1.....	² 298	² 152
Average....	279	153	- 3	- 7	2.....	349	167	- 51	- 15
<i>Subject III.</i>					3.....				
Oct. 1, 1913:					4.....				
1.....	281	⁽³⁾	4.....	433	222	-135	- 70
2.....	289	⁽³⁾	- 8	5.....	433	195	-135	- 43
3.....	298	⁽³⁾	- 17	6.....	500	272	-202	-120
4.....	289	⁽³⁾	- 8	Average....	429	214	-131	- 62
5.....	316	⁽³⁾	- 35				
6.....	289	⁽³⁾	- 8	<i>Subject III.</i>				
7.....	307	⁽³⁾	- 26	Jan. 12, 1914:				
Average....	296	- 17	Dose A:				
Feb. 16, 1914:					1.....				
1.....	289	166	1.....	² 307	² 127
2.....	307	197	- 18	- 31	2.....	298	120	+ 9	+ 7
3.....	281	157	+ 8	+ 9	3.....	349	190	- 42	- 63
4.....	307	159	- 18	+ 7	4.....	409	247	-102	-120
5.....	290	137	- 1	+ 29	5.....	349	179	- 42	- 52
6.....	307	141	- 18	+ 25	6.....	361	196	- 54	- 69
Average....	297	159	- 9	+ 8	7.....	373	208	- 66	- 81
					Average....				
					356				
					190				
					- 49				
					- 63				
								
					Feb. 2, 1914:				
					Dose B:				
					1.....				
					2.....				
					3.....				
					4.....				
					5.....				
					Average....				
					324				
					177				
					- 17				
					- 5				

¹Differences equal 1 period, 1-2, 1-3, 1-4, etc.

²The values in the first period were obtained before the alcohol was given, and are therefore not included in the averages.

³Insufficient data.

TABLE 22.—Threshold measurements for Faradic stimulation—Continued.
[Values given in Martin units.]

Subject, date, and number of period.	Normal.				Subject, date, dose, and number of period.	Alcohol.			
	Average.		Difference. ¹			Average.		Difference. ¹	
	Z	β	Z	β		Z	β	Z	β
<i>Subject IV.</i>					<i>Subject IV.</i>				
Jan. 8, 1914:					Jan. 15, 1914:				
1.....	592	416	Dose A:				
2.....	545	302	+ 47	+114	1.....	² 421	² 228
3.....	569	314	+ 23	+102	2.....	521	303	-100	- 75
4.....	569	318	+ 23	+ 98	3.....	569	338	-148	-110
Average....	569	337	+ 31	+105	4.....	647	429	-226	-201
Feb. 19, 1914:					5.....	592	381	-171	-153
1.....	446	245	6.....	647	400	-226	-172
2.....	592	384	-146	-139	Average....	595	370	-174	-142
3.....	569	364	-123	-119	Feb. 6, 1914:				
4.....	545	343	- 99	- 98	Dose B:				
5.....	464	269	- 18	- 24	1.....	² 289	² 146
6.....	482	279	- 36	- 34	2.....	349	190	- 60	- 44
Average....	516	314	- 84	- 83	3.....	397	228	-108	- 82
<i>Subject VI.</i>					4.....	473	274	-184	-128
Oct. 7, 1913:					5.....	421	238	-132	- 92
1.....	285	(³)	6.....	421	209	-132	- 63
2.....	268	(³)	+ 17	7.....	397	184	-108	- 38
3.....	278	(³)	+ 7	Average....	410	220	-121	- 74
4.....	298	(³)	- 13	<i>Subject VI.</i>				
5.....	298	(³)	- 13	Oct. 14, 1913				
Average....	285	- 0.5	Dose A:				
Mar. 2, 1914:					1.....	² 298	(³)
1.....	217	134	2.....	326	(³)	- 28
2.....	235	140	- 18	- 6	3.....	349	(³)	- 51
3.....	238	136	- 21	- 2	4.....	463	(³)	-165
4.....	226	91	- 9	+ 43	5.....	445	(³)	-147
5.....	256	113	- 39	+ 21	6.....	520	(³)	-222
6.....	238	118	- 21	+ 16	7.....	439	(³)	-141
Average....	235	122	- 22	+ 14	8.....	521	(³)	-223
<i>12 hr. experiment.</i>					Average....	438	-140
Jan. 1, 1914:					Feb. 4, 1914:				
8 ^b 30 ^m a. m.	298	165	Dose B:				
9 30 a. m.	361	212	- 63	- 47	1.....	² 224	² 127
11 20 a. m.	316	188	- 18	- 23	2.....	226	130	- 2	- 3
12 10 p. m.	281	155	+ 17	+ 10	3.....	238	140	- 14	- 13
2 00 p. m.	289	166	+ 9	- 1	4.....	274	158	- 50	- 31
3 15 p. m.	361	205	- 63	- 40	5.....	274	153	- 50	- 26
4 25 p. m.	385	223	- 87	- 58	Average....	253	145	- 29	- 18
5 10 p. m.	337	175	- 39	- 10	<i>12 hr. experiment.</i>				
6 10 p. m.	373	226	- 75	- 61	Jan. 2, 1914:				
7 10 p. m.	409	235	-111	- 70	Dose C:				
Average....	341	195	- 48	- 33	8 ^b 40 ^m a. m.	² 298	² 183
					9 30 a. m.	337	192	- 39	- 9
					10 25 a. m.	361	215	- 63	- 32
					11 30 a. m.	361	210	- 63	- 27
					1 30 p. m.	307	168	- 9	+ 15
					2 30 p. m.	326	166	- 28	+ 17
					3 40 p. m.	373	212	- 75	- 29
					4 45 p. m.	373	200	- 75	- 17
					5 45 p. m.	409	244	-111	- 61
					6 30 p. m.	409	230	-111	- 47
					7 25 p. m.	421	244	-123	- 61
					Average....	368	208	- 70	- 25

¹Differences equal periods 1-2, 1-3, 1-4, etc.²The values in the first period were obtained before the alcohol was given, and are therefore not included in the averages.³Insufficient data.

TABLE 22.—Threshold measurements for Faradic stimulation—Continued.
[Values given in Martin units.]

Subject, date, and number of period.	Normal.				Subject, date, dose, and number of period.	Alcohol.			
	Average.		Difference. ¹			Average.		Difference. ¹	
	Z	β	Z	β		Z	β	Z	β
<i>Subject VII.</i>					<i>Subject VII.</i>				
Oct. 8, 1913:					Oct. 15, 1913:				
Dose A:					Dose A:				
1.....	210	(?)	1.....	³ 177	(?)
2.....	226	(?)	- 16	2.....	195	(?)	- 18
3.....	226	(?)	- 16	3.....	204	(?)	- 27
4.....	221	(?)	- 11	4.....	226	(?)	- 49
Average....	221	- 14	5.....	232	(?)	- 55
Mar. 6, 1914:					6.....				
1.....	173	111	7.....	262	(?)	- 85
2.....	166	58	+ 7	+ 53	8.....	268	(?)	- 91
3.....	204	115	- 31	- 4	Average....	274	(?)	- 97
4.....	215	116	- 42	- 5	Feb. 27, 1914:				
5.....	238	148	- 65	- 37	Dose B:				
6.....	204	100	- 31	+ 11	1.....	³ 232	³ 138
Average....	200	108	- 32	+ 4	2.....	229	132	+ 3	+ 3
<i>Subject VIII.</i>					3.....				
Oct. 9, 1913:					4.....				
1.....	262	(?)	5.....	235	136	- 3	- 2
2.....	268	(?)	- 6	6.....	250	129	- 18	+ 5
3.....	250	(?)	+ 12	7.....	235	101	- 3	- 5
4.....	244	(?)	+ 18	8.....	244	128	- 12	+ 7
Average....	256	+ 8	Average....	239	125	- 7	+ 2
<i>Subject VIII.</i>					<i>Subject VIII.</i>				
Oct. 9, 1913:					Oct. 16, 1913:				
Dose A:					Dose A:				
1.....	262	(?)	1.....	³ 232	(?)
2.....	268	(?)	- 6	2.....	221	(?)	+ 11
3.....	250	(?)	+ 12	3.....	244	(?)	- 12
4.....	244	(?)	+ 18	4.....	281	(?)	- 49
Average....	256	+ 8	5.....	298	(?)	- 66
<i>Subject IX.</i>					6.....				
Oct. 10, 1913:					7.....				
1.....	343	(?)	8.....	268	(?)	- 36
2.....	379	(?)	- 36	Average....	267	- 35
3.....	433	(?)	- 90	<i>Subject IX.</i>				
4.....	445	(?)	- 102	Oct. 20, 1913:				
5.....	445	(?)	- 102	Dose A:				
Average....	409	- 82	1.....	³ 232	(?)
Mar. 3, 1914:					2.....				
1.....	244	132	3.....	274	(?)	- 42
2.....	250	133	- 6	- 1	4.....	268	(?)	- 36
3.....	326	204	- 82	- 72	5.....	262	(?)	- 30
4.....	274	124	- 30	+ 8	6.....	268	(?)	- 36
5.....	316	158	- 72	- 26	7.....	281	(?)	- 49
6.....	297	163	- 53	- 31	Average....	268	- 36
Average....	284	152	- 49	- 25	Feb. 20, 1914:				
					Dose B:				
					1.....				
					2.....				
					3.....				
					4.....				
					5.....				
					Average....				
					367				
					215				
					- 6				
					+ 7				

¹Differences equal periods 1-2, 1-3, 1-4, etc.

²No record.

³The values in the first period were obtained before the alcohol was given, and are therefore not included in the averages.

TABLE 22.—Threshold measurements for Faradic stimulation—Continued.
[Values given in Martin units.]

Subject, date, and number of period.	Normal.				Subject, date, dose, and number of period.	Alcohol.			
	Average.		Difference. ¹			Average.		Difference. ¹	
	Z	β	Z	β		Z	β	Z	β
<i>Subject X.</i> Feb. 23, 1914:					<i>Subject X.</i> Mar. 4, 1914:				
1.....	316	185	Dose A:				
2.....	316	171	0	+ 14	1.....	² 256	² 151
3.....	361	221	- 45	- 36	2.....	281	156	- 25	- 5
4.....	349	205	- 33	- 20	3.....	349	212	- 93	- 61
5.....	361	211	- 45	- 26	4.....	421	244	-165	- 93
6.....	409	252	- 93	- 67	5.....	434	250	-178	- 99
Average....	352	207	- 43	- 27	6.....	463	274	-207	- 123
					Average....	390	227	-134	- 76
PSYCHOPATHIC SUBJECTS.									
<i>Subject XI.</i> Mar. 24, 1914:					<i>Subject XI.</i> Mar. 25, 1914:				
1.....	592	381	Dose A:				
2.....	545	329	+ 47	+ 52	1.....	² 463	² 305
3.....	408	140	+184	+241	2.....	473	313	- 10	- 8
Average....	515	283	+115	+146	3.....	463	296	0	+ 9
Mar. 28, 1914:					4.....	500	318	- 37	- 13
1.....	620	460	Average....	479	309	- 16	- 4
2.....	647	457	- 27	+ 3					
3.....	620	425	0	+ 35					
Average....	629	447	- 13	+ 19					
<i>Subject XII.</i> Mar. 31, 1914:					<i>Subject XII.</i> Apr. 1, 1914:				
1.....	521	325	Dose A:				
2.....	482	301	+ 39	+ 24	1.....	² 373	² 232
3.....	445	242	+ 76	+ 83	2.....	397	240	- 24	- 8
Average....	483	289	+ 57	+ 53	3.....	421	249	- 48	- 17
Apr. 4, 1914:					4.....	463	280	- 90	- 48
1.....	409	261	Average....	427	256	- 54	- 24
2.....	421	260	- 12	+ 1					
3.....	500	328	- 91	- 67					
Average....	443	283	- 51	- 33					
<i>Subject XIV.</i> Apr. 21, 1914:					<i>Subject XIV.</i> Apr. 22, 1914:				
1.....	326	197	Dose A:				
2.....	316	180	+ 10	+ 17	1.....	² 298	² 178
3.....	337	196	- 11	+ 1	2.....	307	175	- 9	+ 3
Average....	326	191	0	+ 9	3.....	349	202	- 51	- 24
Apr. 25, 1914:					4.....	373	222	- 75	- 44
1.....	281	157	5.....	385	217	- 87	- 39
2.....	337	193	- 56	- 36	Average....	353	204	- 55	- 26
3.....	316	167	- 35	- 10					
Average....	311	172	- 45	- 23					

¹Differences equal periods 1-2, 1-3, 1-4, etc.²The values in the first period were obtained before the alcohol was given, and are therefore not included in the averages.

Wherever possible, the results are given in both Z and β units. Z is computed from the reading of the secondary coil by the formula

$$Z = \frac{M}{L} \times I_c.$$

In this formula, $\frac{M}{L}$ is a constant depending on the relation between the primary and secondary coils at that particular position for our inductorium. Its value is given either directly by Professor Martin's calibration of our inductorium, or by interpolation between those values. I_c is the intensity of the primary current in amperes corrected by the empirically determined constant for our inductorium, according to the formula $I_c = I_o (1 + 0.41 I_o)$.

TABLE 23.—Summary of threshold measurements for Faradic stimulation.
[Values given in Martin's Z units.]

Subject.	Average Z differences.			Effect of alcohol. ¹		Percentile effect of alcohol. ²	
	Normal average I and II.	Alcohol.		Dose A.	Dose B.	Dose A.	Dose B.
		Dose A.	Dose B.				
Normal subjects:						<i>p. ct.</i>	<i>p. ct.</i>
II.....	- 2	- 57	-131	- 55	-129	-19	-46
III.....	-13	- 49	- 17	- 36	- 4	-12	- 1
IV.....	-26	-174	-121	-148	- 95	-30	-21
VI.....	-11	-140	- 29	-129	- 18	-48	- 7
VII.....	-23	- 60	- 7	- 37	+ 16	-20	+ 8
VIII.....	+ 8	- 35		- 43		-17	
IX.....	-65	- 36	- 6	+ 29	+ 59	+11	+19
X.....	-43	-134		- 91		-32	
Average.....	-22	- 86	- 52	- 64	- 28	-21	- 8
12 hr. experiment:							
VI.....	-48	³ 70		³ - 22			
Psychopathic subjects:							
XI.....	+51	- 16		- 67		-12	
XII.....	+ 3	- 54		- 57		-13	
XIV.....	-22	- 55		- 33		-11	
Average.....	+11	- 42		- 52		-12	

¹Alcohol values minus normal values.

²Percentile effect equals the effect of the alcohol on the average Z difference divided by the average of the corresponding normals of the day.

³Dose C was given in this experiment.

β is computed from the reading of the position of the secondary coil by Wilbur's simplification of the Martin formula for β as published in "The Nocturnal Variation of the Sensory Threshold," by Martin, Bigelow, and Wilbur.¹

$$\beta = \frac{Zr R' - Zr' R}{R' - R}$$

¹Martin, Bigelow, and Wilbur, *Am. Journ. Physiol.*, 1914, **33**, p. 415.

Z_r is the value of Z at skin resistance.

R is the skin resistance.

Z_r' is the value of Z when the arbitrary known resistance is introduced into the primary circuit.

R' is the total value of the skin and known resistance.

As appears from the above formulæ, the Z values take no account of the changing skin or electrode resistance. Since these changes in the course of our 3-hour experiments were never large, and since Martin had already shown that Z and β values tend to run a parallel course, it is probable that no great violence has been done to the results by computing the effects of alcohol from Z . This course was necessary in the present instance, because measurements of skin-resistance which we made before December 23 were technically unreliable, and in several instances these earlier measurements of Z were the only ones available as a first normal day.

The general effects of alcohol, doses A and B, are tabulated for each subject in the summary (table 23), in both absolute differences and in percentile changes. Inspection of table 23 shows that for both normal and alcohol days, the value of Z in succeeding series of the same day tends to rise. In psychological terms the sensory threshold rises or the sensitivity decreases as the experimental periods of 3 hours progressed. There is, however, a distinct difference between normal and alcohol days in this respect. On alcohol days the sensitivity decreases more than on the normal.

The tendency of the threshold to rise during a normal experimental period is practically explained by the interaction of the daily rhythm. Since most of the measurements here reported were made in the afternoon between 3 and 7, one would expect such a tendency as a result of the daily rhythm which was described by Grabfield and Martin.¹

But our experimental conditions were not strictly analogous to those of Grabfield and Martin. In their case, the experimental measurement of the Faradic threshold was introduced as an interruption to some regular work. In our case, the 3-hour series of measurements permitted only the most restricted activity of the subject. Such pronounced neuro-muscular relaxation as our pulse-records show at the end of the period was probably not duplicated in their experiments. It is still more significant that in spite of quickened heart-rate, the effect of alcohol is still further to decrease sensitivity.

The last two columns of table 23 show the percentile value of this difference for the main group of subjects; it averages 21 per cent of the average normal value of Z , after the ingestion of the smaller dose of alcohol, and 8 per cent after the ingestion of the larger dose. On the basis of our statistical theory, the one exception under dose A, Subject

¹Grabfield and Martin, *Am. Journ. Physiol.*, 1912-13, **31**, p. 300.

IX, is within the expected error. The apparent notable decrease of effect after dose B of alcohol can not be regarded as an accident. It seemed probable that some new factor entered the situation with the larger dose. At first we thought we had come upon an indication of increased stimulation, but the total evidence is against this explanation. While smaller than after dose A, the average is still in the same direction. A change in sign occurs only in one case out of six. We have already mentioned a much more probable explanation of the phenomenon, which at the same time accounts for the individual variation. This is the change in the standard of assurance under alcohol, for which we gave our incomplete introspective and objective evidence in the earlier discussion.

In view of all the facts, we may probably conclude that the sensory threshold for electrical stimulation is raised by moderate doses of alcohol. In other words, the average sensitivity to electrical stimulation is decreased by moderate doses of alcohol. As this is diametrically opposed to the finding of Specht¹ in the case of sound threshold, we may not generalize our data. But we would emphasize the fact that our threshold is uncontaminated by such complex adaptation changes of the sense organ as may supervene in the case of the eye and the ear.

¹Specht, *Archiv. f. d. ges. Psychol.*, 1907, **9**, p. 180.

CHAPTER VII.

EFFECT OF ALCOHOL ON MOTOR COÖRDINATIONS.

GENERAL MOTOR PROCESSES.

The motor side of our original program has suffered abbreviation through our time limits more than any other in this research. The program called for an investigation (1) of muscle threshold, (2) of motor fatigue, (3) of muscle tremor, as well as (4) of the speed of movement. Tentative experiments were made in all these directions. But only in the fourth, which we came to interpret broadly as a measure of motor coördination, did the available technique appear to warrant the inclusion of the measurements in the regular series of experiments.

(1) In our attempts to measure the muscle threshold we used the Martin complex of apparatus as described in Chapter VI. Our first difficulty was to make a satisfactory non-polarizable electrode of uniform surface contact and resistance. After experimenting with various devices, we finally came to use the following relatively satisfactory form: Prepared clay (clay moistened with normal salt solution) was spread to a thickness of about 3 mm. on the bottom of a porous porcelain cup, which was about 2.5 cm. in diameter and about 2 cm. high. An amalgamated zinc electrode wrapped in absorbent cotton which was well moistened with saturated zinc-sulphate solution was placed inside the cup. The clay-covered cup was placed against the appropriate part of the skin, to the configuration of which it readily conformed, and was held in position with an elastic band. With reasonable care this arrangement provided an electrode of uniform size, even contact, and quite regular resistance. As an indifferent electrode we used a fluid, non-polarizable electrode, such as was used in the sensory-threshold experiments. The significant electrode was regularly placed on a point of the left forearm, which preliminary exploration showed to be the common point for the extension of the digits. A finger of the right hand was inserted in the indifferent electrode. In this manner a considerable body of data was collected which was too obviously faulty to be included in this report. The faults depended, first, on the difficulty in observing threshold contraction of the digital extensors. No device which we adopted for registration seemed to work satisfactorily. Observation of the muscle was sometimes more and sometimes less satisfactory than observations of the movements of the fingers. Even with the most favorable conditions for observations we were seldom satisfied that we had a true threshold, either with increasing or with decreasing stimuli. The area of uncertainty would frequently extend over several millimeters of the inductorium scale. This was more

serious, since we had to use a large current in the primary (1 ampere), and even then the muscle threshold at skin resistance was usually found with the primary and secondary coils so close together that a change of a single millimeter made relatively large changes in the intensity of the induced current. On these grounds we feel doubtful if the fingers, in spite of their mobility, are adapted to serve as indicators of muscle threshold to Faradic stimulation by the Martin method. A second difficulty arose out of the required intensity of the current for threshold stimulation. On account of the possible variations of skin and electrode resistance, we felt that only β values could be regarded as significant in these measurements. But on account of the intensity of the current demanded, we found it impracticable to get more than one threshold with known resistance, in addition to the threshold at skin resistance, and this one additional threshold was obtained with the secondary coil at a relatively unreliable part of the scale. The data at hand show no clear tendency of muscle threshold after alcohol, but, as we have indicated, they are too unreliable to be of any real significance.

(2) On the problem of muscle fatigue and recuperation we have no direct data. Prolonged free oscillation of the finger, which we proposed in the program to study in this connection, proved to be complicated by too many capricious factors to be usable. Preliminary records clearly showed that some subjects unconsciously saved themselves at the beginning for the long process. Moreover, they yielded variously to growing discomfort, fatigue, etc. In our experimental series we continued to use the free oscillation of the finger, but only for the initial spurt and in quite another connection. Incidental indications of fatigue from these records will be discussed in the latter part of this chapter.

(3) Attempts to measure muscle-tremors were made by attaching delicate photographic recorders to the finger, wrist, and forearm respectively, with adequate supports for the member that was not under observation. The instrumental technique was accurate. A long lever was placed before a photographic recording-camera in such a position that a shadow of its free end fell across the slit. The limb whose tremors were to be measured was then attached to the lever by a light but rigid connector in such a way that the tremors were magnified ten times. But with this frictionless recording technique the result of the preliminary records gave such wide variations within a few seconds of each other under supposedly normal conditions that we decided to drop the measurements until the sources of variation could be investigated.

(4) The speed of movement developed under our analysis of its conditions to a more significant measurement than we had at first ventured to expect. It takes its proper place with respect to the rest of the neuro-muscular processes only when we regard it as an indicator of primary motor coördination.

MOTOR COÖRDINATIONS.

The fundamental technical problem in any attempt to measure the effect of alcohol on human motor coördination must be to discover some measurable and generally practiced motor process whose character and complexity are definitely known, and whose operation is removed as far as possible from the voluntary or capricious control of the subject.

While the total irritability of nervous arcs is indicated by the latent time of reflex and reaction and by the amount of muscle contraction which follows a definite stimulus, neither of these measurements gives any indication with respect to the adequacy of the central elaboration of the response. As far as our present knowledge goes, we can not regard the adequacy of any simple human reflex as a measurable quality. It would be possible, however, to find an indication of the adequacy of coördination in any one of the more complex reaction processes if we had suitable techniques. For example, the accuracy of fixation in the reactive eye-movements would depend on the adequacy of the oculo-motor coördinations. But unfortunately, as we have pointed out, accurate spatial measurements of the eye-movements present many technical difficulties that are not met in time measurements. For the present experiments, at least, these difficulties seemed to make measurement of the adequacy of visual fixation impracticable. Similarly, the sequence of movements that are involved in speech, as it occurs in word-reactions, would be an excellent indication of the adequacy of a generally practiced coördination process. Such an indication would be of peculiar value in experiments with small doses of alcohol, since there is evidence in the disturbed utterance of patients suffering from acute alcoholism that large amounts of alcohol notably affect the coördinations of speech. But in the case of speech, even more conspicuously than in the case of the eye reactions, the difficulties of adequate registration and measurement are at present prohibitive. Measurements of the effect of alcohol on the coördinations of speech would be further complicated by the wide variations of normal pronunciation.

Much the same difficulty would appear to threaten the attempt to measure the motor coördination in standing, walking, writing, etc. In the more consciously controlled processes of drawing, typewriting, typesetting, etc., new technical difficulties appear in the unknown and unmeasured interplay of interest and effort and the complex group of determinants that we commonly call the will. Such measurements are especially useful as an indication of the effect of alcohol on socially important processes, but their scientific value would be conditioned by a knowledge of the interaction of the several factors that combine to produce any specific performance in these processes.

When we attempt to analyze out of human action the simplest form of motor coördination, which corresponds, in its relation to complex acts, to the relation between the simple reflexes and the complex

reactions, we come upon the reciprocal innervation of the antagonistic muscles that control the movement of a limb.¹

First demonstrated for voluntary antagonistic muscles by Sherrington² in connection with the antagonistic muscles of the eye, it appears that whenever one member of a pair of antagonistic muscles is stimulated to action through the central nervous system, the other member tends to corresponding relaxation. Apparently, all movements of the limbs, voluntary as well as reflex, are conditioned by this reciprocal innervation of antagonistic muscles. Its value to the organism is obvious. Unless the antagonistic muscle relaxed during the contraction of the agonistic, the latter would be operating not only against its load, but also against the tonus of the former. While reciprocal innervation is not a mechanical necessity for the movement of the limbs, it seems to be a physiological device to increase the efficiency of muscle contraction. At any rate, it appears to be a fundamental and universal fact of nervous motor coördination. Measurement of the adequacy of motor coördination, as seen in reciprocal innervation of antagonistic muscles, can not be made in human subjects by the direct methods that are available in animals. A human experiment must depend on the movement of the limb or organ to which the muscles are attached, rather than on the action of extirpated muscle. In the voluntary movements of a limb, the adequacy of reciprocal innervation may be indicated in two ways. In its simplest form, it is indicated by the maximum rapidity of movement, since only by the relaxation of the antagonistic can the agonistic be the most effective in producing rapid motion of the limb. In a succession of most rapid possible movements of a limb, a measure of the adequacy of reciprocal innervation may be found in the rate with which the oscillations of the limb may be produced.

Both of these measurements are complicated under ordinary circumstances by a variety of conditions. The normal speed of voluntary movements varies enormously. One may move the fingers and arms at any one of a large variety of predetermined rates. The maximum velocity is conditioned not merely by the mass of the moving member, the strength of the muscles, and the adequacy of motor coördination between antagonistics, but also by that highly complex mental fact which we call will. If one found in a subject more rapid movements of the arm as a consequence of the ingestion of a small amount of alcohol, the problem of the origin of the change and its consequent significance would involve an equation with an indefinite number of unknown factors. Euphoria, increased determination, adaptation to experimental demands, increased interest or attention, due perhaps to absence of conflicting interests, lack of apprehension of the consequences, indifference to discomfort, as well as increased strength of

¹Compare Isserlin, Kraepelin's *Psychol. Arbeit.*, 1914, 6, p. 1.

²Sherrington, *The Integrative Action of the Nervous System*. New York, 1907. Also notes in *Proc. Royal Soc. of London*, 1887, 42, p. 556, and 1888, 43, p. 407.

muscle, or increased adequacy of coordinated inhibition of antagonists—any or all of these might operate to increase the velocity of movement. A change in the relationship of the different factors which involves the preponderance of any one of the opposing tendencies must decrease or increase the time of movement, according to the direction of the change and the nature of the tendency.

It was in obedience to our fundamental principles for the selection of measurable phenomena that we planned to measure the velocity of movement of the lightest practicable moving member, in an act which was as far as possible removed from arbitrary or voluntary interference. In both respects the organ in which Sherrington first demonstrated the phenomena of reciprocal innervation in voluntary movements is peculiarly satisfactory. The eye is one of the lightest of moving members and the leverage of its muscular attachments is the most favorable for rendering its mass a negligible factor. Eye-movements of the first type, that is, simple movements of the eye in fixating peripherally seen objects, are relatively independent of voluntary control. Moreover, these movements of the eye, in which the point of regard wanders over any relatively fixed section of the field of vision, are doubtless the most numerous, and at the same time the best understood, of all the eye-movements.

EFFECT OF ALCOHOL ON THE VELOCITY OF EYE-MOVEMENTS OF THE FIRST TYPE.

The most important differentiating characteristics of this class of eye-movements were noted by Dodge¹ in his description of the type from photographic records, as follows: The duration of eye-movements of the first type is less than of any other movement of the eye. It varies directly with the angle of displacement, but is approximately constant for each individual under the same conditions of fatigue of the eye-muscles, of original orientation, and of the direction and angle of eye-movement.

If we were dependent on subjective data alone, almost everyone would say without hesitation that he could move his eye across the field of vision rapidly or slowly at will. That is, however, an illusion. The effort to move the eye slowly from one point of regard to another always results in one or more complete stops, of which the subject is never directly conscious until his attention is called to them. The simplest method of convincing oneself of this fact is the method of Brown.² If the attempt be made to move the eyes slowly along a line which passes through a bright light, on closing the eyes a number of well-defined after-images of the light will be observed, clearly indicating that the eye rested at corresponding points along the path. More

¹Dodge, *Am. Journ. Physiol.*, 1903, 8, p. 307.

²Brown, *Nature*, 1895, 52, p. 184.

satisfactory is the evidence obtained by direct observation of another's eyes. If the observer is careful not to look directly at the moving eye, but rather at some point on the eyelid, the alternation of movement and stops, as the subject attempts to move his eye slowly, will be clearly distinguished. Photographic records show that these pauses are of varying length, the shortest being of slightly less than 0.2".

TECHNIQUE FOR MEASURING THE VELOCITY OF EYE-MOVEMENTS.

It is unnecessary to repeat here a critical résumé of the earlier attempts to measure the duration of the eye-movements by optical methods.

The first measurements of the eye-movements from photographic records are reprinted in table 24 from the paper by Dodge and Cline.¹

TABLE 24.—Duration of eye-movements.
[Values given in thousandths of a second.]

Angular lateral displacement.	Relation to primary position.		A			B			C			General average.
			M.	M. V.	No.	M.	M. V.	No.	M.	M. V.	No.	
	<i>L.</i>	<i>R.</i>										
5°	5 + 0		34.5	1.5	8	29.4	2.9	8	22.4	3.3	10	28.8
10°	5 + 5		41.8	1.4	9	40.9	3.8	8	33.7	2.1	5	38.8
15°	10 + 5		46.7	4.5	8	47.9	2.6	10	49.9	3.1	10	48.2
20°	10 + 10		54.5	8.0	8	51.3	3.5	10	58.6	4.1	10	54.8
30°	15 + 15		84.3	8.9	7	74.3	9.3	10	82.5	3.8	10	80.4
40°	20 + 20		100.4	4.5	7	93.4	7.3	10	106.0	8.0	8	99.9

Table 24 shows the mean duration of the eye-movements of three subjects, A, B, and C, through angles varying from 5° to 40°. The two columns at the left give the angular lateral displacement of the line of regard, together with an indication of the orientation of the lateral displacement with relation to the preliminary line of regard. For example, eye-movements of 40° were between two points which were 20° to either side of the primary line of regard. M. signifies the mean value in terms of thousandths of a second, M. V. the mean variation, and No. the number of records from which the mean is reckoned. At the extreme right is given the general average for all three subjects for the various angles of displacement.

The results given in the table indicate that the duration of the movements of any individual eye through a given angle tends to remain constant within the limits of a relatively small variation from the mean. The larger mean variation for the angular movements above 15° is due in part to the differences which were found to exist between the adductive and the abductive movements of the eye.

The table shows further that the duration of eye-movement increases in direct ratio with the angle. Taking the general average of all three

¹Dodge and Cline, *Psychol. Review*, 1901, 8, p. 145.

subjects as a basis for calculation, it would appear that for every 5° added to the amplitude of the eye-movement between 5° and 40° , about 10σ is added to the duration of the movement. But the apparent implication of a fixed maximum velocity of 10σ for each 5° is false. The experiments of Guillery¹ and of Brückner,² as well as Erdmann and Dodge's³ experiments by the Lamansky method, all showed that the maximum velocity of the eye during movements of large amplitude is greater than the maximum velocity during movements of small amplitude. The record of every eye-movement of the first type, between 5° and 40° , shows three distinct phases. The first phase consists of a positive acceleration to a maximum velocity. This is maintained for a considerable angle of movement, and constitutes the second phase, giving place in turn to a negative acceleration phase as the eye comes to rest. The relation of these phases is not constant. In the shortest excursions measured, the second phase is very short, while in the longest excursions, with the exception of a peculiar modification in the abductive movements, the second phase is by far the most conspicuous. Moreover, if one superimposes a curve for a movement of 15° on a curve for a movement of 40° , the second phase of the latter record will be found to incline slightly more to the horizontal. This confirms the law that the maximum as well as the average velocity increases in direct ratio with the angle of movement.

Guillery¹ observed a decided difference between the velocity of the eye at the beginning and at the end of an eye-movement; but his experimental method involved two conditions that tend to distort the relation. In the first place, his eye-movements were uniformly extreme, and involved considerably more muscle strain and effort than the more natural excursions measured by Dodge and Cline, which never exceeded 20° from the primary position of the eye. Still more important is the fact that it is found to be impossible, even under the most favorable conditions, to secure a series of simple direct movements of the eyes from one fixation point to another which is more than 40° distant. This distance is persistently underestimated, and the initial long movement of the first type is succeeded by a shorter corrective movement of the same type. Since Guillery's eye-movements were all 40° or over, it seems probable that his attempt to measure the velocity of the end of the eye-movements was confused by the small corrective movements whose average velocity is comparatively low. In the abductive movements, the photographic records commonly show a marked difference between the velocity of corresponding portions of the first and third phases. This peculiarity of the third phase is sufficient to account for the longer duration of the abductive movements as remarked independently both by Guillery, and by Dodge and

¹Guillery, *Archiv f. d. ges. Physiol.*, 1898, **73**, p. 87.

²Brückner, *Archiv f. d. ges. Physiol.*, 1902, **90**, p. 73.

³Erdmann and Dodge, *Psychologische Untersuchungen über das Lesen*, Halle, 1898.

Cline. Brückner found the relation reversed in his own case, *i. e.*, the adductive movements were longer than the abductive. This led him to conclude that the differences are mere personal peculiarities rather than universal differences of the eye-movements in the two directions.

All these various characteristics of the simple eye-movements have since been confirmed by a wealth of photographic records.¹ They make it clear that the reciprocal innervation of the antagonistic muscles of the eye under normal conditions is a nice adjustment of great regularity in ordinary vision.

We know of no other voluntary action which is so completely withdrawn from voluntary control as the eye-movements. There is scant sensory data concerning them, so scant that ordinarily one is unable to give any subjective account of these movements. Physiologically their velocity is probably determined by visual considerations. Eye-movements exist for the sake of unconfused vision. They should be of such short duration that vision does not seem to be interrupted. They must be rapid enough to prevent the confusion of an apparently moving field. When satisfactorily executed, attention is abstracted from the eye-movements to the clear vision that they condition. For our purposes it is a further advantage of the eye-movements that they are thoroughly habituated.

Moreover, the technique is adequate. The records are photographic. The time is given directly through regular interruption of the recording beam of light by a vibrator in series with a tuning-fork. It should be noted, however, that the photographic procedure is not without some difficulties of its own. The eyelid may droop and interfere with the recording light without parallel interference of vision. Excessive head-movements may render a considerable portion of the plate illegible, or take the subject out of focus of the recording-camera. However, the demands on the subject's intelligence and coöperation are so small that satisfactory sets of eye-movement records were obtained by Diefendorf and Dodge from 40 inmates of the Connecticut Hospital for the Insane, including manic, depressed, epileptic, paralytic, and præcox patients.

Our photographic arrangements for recording the movements of the eye are similar to those for recording eye-reaction, except that instead of the apparatus to expose peripheral objects, two constant fixation marks are shown (F^1 and F^2 , fig. 14). These latter are so oriented that in looking from one to the other the eye of the subject will move through an angle of 40° , *i. e.*, 20° on either side of its primary position, as in the eye-movements of 40° which were measured by Dodge and Cline. The subject occupied position II, figure 1, exactly as in the eye-reaction measurements. The physiological brilliancy of the arc light was stopped down

¹Unfortunately the pretentious work of Koch (Archiv f. d. ges. Psychol., 1908, 13, p. 196) is unreliable. In spite of apparently minute care in determining fixation, he can not prevent inaccuracies of vertical displacement. All such inaccuracies, however, will appear on his records as a modification of the apparent time of movement. The wide individual variation in the velocity of the eye-movements which he found is an instrumental artifact.

with one or more thicknesses of blue glass. The oscillating light-interrupter was set in motion by starting the electrically-driven tuning-fork with which it was in series. The enlarging camera was focused to secure the best image of the arc light as reflected from the cornea of the subject. The shutter dropped and the signal was given to the subject to look from one point of regard to the other, back and forth as rapidly as possible, until the signal to stop was given at the end of 5 seconds.

A typical record of the eye-movements is reproduced in figure 27. The horizontal lines on this record indicate the moments of visual fixation. The oblique lines of dashes indicate movements of the eye from one fixation point to another. Each sweep is usually continuous until near the end, when a sharp break often occurs, followed by one or more short corrective movements. These corrections are usually not over 5° of movement. They are always noted in reading the plates and are recorded in the tables. But their algebraic sums are so nearly constant that no correction of the final values has been attempted on their account. The time interruptions of the record were made by the fork-driven vibrator. They indicate hundredths of a second. Similar time

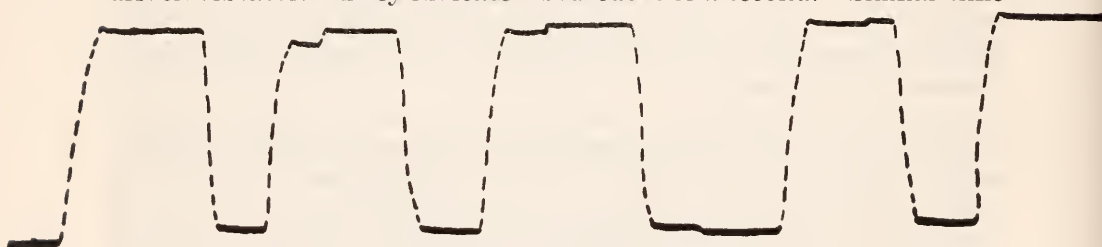

FIG. 27.—Typical eye-movement record.

records appear on the original records in the fixation lines, but there was no particular object in adding to the burden of the reading by counting them. Instead, we took the total number of eye-movements in 5 seconds to be a satisfactory measure of the fixation pauses.

RESULTS.

All our data on the velocity of the eye-movements are collected in table 25, arranged according to the numbers of the subjects. Under movements to the right and left respectively are given the duration of the abductive and adductive eye-movements, together with the extent of the corrective movements. Under the heading "Total movement" is given the sum of the durations of movement to the right and left. This is made the basis of the calculation of the effect of alcohol, in the effort to equalize any fault of muscle-balance that may have been present in any of the subjects, or induced by the experiments. Under "No. of cycles" is entered, as far as data are available, the number of complete cycles of eye-movement and fixation that occurred in 5 seconds of experiment.

TABLE 25.—*Eye-movements.*
[Time units in thousandths of a second.]

Subject and kind of experiment.	Date and number of period.	Movements to right.				Movements to left.				Sum of M. V. to right and left.	Difference (1-2, 1-3, etc.).		
		Dura- tion.	Error (sum).	Difference (1-2, 1-3, etc.).		Dura- tion.	Error (sum).	Difference (1-2, 1-3, etc.).			Total move- ment.	M. V.	Num- ber of cycles.
				Dura- tion.	Error.			Dura- tion.	Error.				
<i>Subject II.</i> Normal I.....	Nov. 14, 1913:	σ	deg.	σ	deg.	σ	deg.	σ	deg.	σ			
		1.....	95	0	86	0	181	0	10	6.25	σ		
		2.....	94	2.6	89	-2.6	183	2.6	11	6.75	-2	-1	-0.5
		4.....	90	0	100	0	190	0	0	6.25	9	+10	0
	Average.....	93	0.9	92	-1.3	185	0.9	-8	7	6.42	5	+4	-0.25
	Nov. 20, 1913:	1.....	285	20	285	25	270	25	20	24.5			
		2.....	86	0	102	0	188	-17	+5	18	18	-21	-1
		3.....	92	0	101	0	193	-16	+5	24	23	-24	-1.5
		4.....	100	0	107	0	207	-22	-35		37	-37	-0.75
		5.....	90	0	120	0	210	-35	+5		40	-40	
Average.....		92	0	107	0	199	-22	-5	22	5.6	29	-22	-1.08
Alcohol (dose A).....	Mar. 10, 1914:	1.....	294	20	283	20	277	20	213	26.0			
		2.....	100	0	115	0	215	-32	0	38	-38		+3.5
		3.....	130	0	116	0	246	-33	0	24	5.0	-69	-11
		4.....	(³)	0	135	0	(270)	-52	0		3.5	(-93)	+2.5
		Average.....	115	0	122	0	230	-39	0		3.67	-67	+2.3
		Normal II.....	Mar. 17, 1914:										
Alcohol (dose B).....	Mar. 17, 1914:	1.....	87	0	84	8	171	8	18	7.0			
		2.....	106	0	95	3	201	-11	+5	30	-30	-18	-0.5
		3.....	108	0	100	2	208	-16	+6	9	5.75	-37	+9
		4.....	92	+4	117	0	212	-33	+8	21	5.75	-41	3
		5.....	85	+2	100	0	191	-7	+8	14	6.5	0	+4
		6.....	96	-8	100	0	196	-16	+8	19	7.5	-25	-1
Average.....	96	-0.33	98	+0.4	193	-16	+7	19	6.7	-27	-2	+0.5	

¹Double exposure in third period; records illegible.
²The values for the first period of the alcohol experiments were obtained before the alcohol was given and are therefore not included in the averages.
³Irregular eye-movements.
⁴In period 5 were four very irregular movements, and only one of normal size. They are consequently not included.

TABLE 25.—*Eye-movements*—Continued.
[Time units in thousandths of a second.]

Subject and kind of experiment.	Date and number of period.	Movements to right.				Movements to left.				Total movement.	Sum of M. V. Num-ber of right and left.	Difference (1-2, 1-3, etc.).					
		Dura-tion.	Error (sum).	Difference (1-2, 1-3, etc.).		Dura-tion.	Error (sum).	Difference (1-2, 1-3, etc.).				Total movement.	M. V.	Num-ber of cycles.			
				σ	deg.			σ	deg.						σ	σ	
<i>Subject III.</i> Normal I.....	Jan. 19, 1914:	σ	deg.	σ	deg.	σ	deg.	σ	deg.	σ	σ	σ	σ	σ	σ	σ	σ
	1.....	96	0	99	9	-3	+7	+11	+8	195	8	7.75	+2	+0.25			
	3.....	102	1	102	2	-3	+7	+8	+9	204	7	7.75	+2	+0.25			
	4.....	99	6	99	0	-3	-6	0	+9	199	11	7.75	-4	+0.25			
	Average.....	99	2.3	100	3	-4.5	-3.5	8		199	9	7.83	0	+0.25			
Alcohol (dose A).....	Jan. 26, 1914:	σ	deg.	σ	deg.	σ	deg.	σ	deg.	σ	σ	σ	σ	σ	σ	σ	σ
	1.....	297	20	297	28	+11	+8	+11	+8	2194	28	8.75	+20	-0.50			
	2.....	88	0	86	0	+8	+9	+8	+9	174	13	8.75	+13	-0.25			
	3.....	91	0	89	-1	+6	0	+8	+8	181	13	8.75	+20	-0.50			
	4.....	91	0	83	0	+13	0	+14	+8	174	11	8.75	+20	-0.50			
	5.....	84	0	83	0	+1	0	0	+8	167	12	9.00	+27	-0.75			
	6.....	98	0	97	0	-1	0	0	+8	195	11	8.75	-1	-0.50			
Average.....	90.4	0	87.6	1	+6.6	0	+9.4	+8.2	178	12	8.75	+16	-0.50				
Alcohol (dose B).....	Feb. 9, 1914:	σ	deg.	σ	deg.	σ	deg.	σ	deg.	σ	σ	σ	σ	σ	σ	σ	σ
	1.....	2100	22	2101	23	-2	+3	-2	+3	201	23	9	0	+1	0		
	2.....	98	0	103	0	+2	+2	+2	+3	208	12	9.25	-7	-0.25			
	3.....	100	0	108	0	-3	+2	-7	+3	211	13	9.25	-10	-0.25			
	4.....	103	0	108	0	-3	+2	-7	+3	207	13	9.17	-6	+0.3			
Average.....	100	0.5	106	0.8	-0.3	+2	-5	+3	207	13	9.17	-6	+0.3				
Normal II.....	Mar. 9, 1914:	σ	deg.	σ	deg.	σ	deg.	σ	deg.	σ	σ	σ	σ	σ	σ	σ	σ
	1.....	100	0	107	0	+2	0	+3	0	207	7	8.75	+5	-0.75			
	2.....	98	0	104	0	+1	0	+4	0	202	11	9.50	+4	-0.75			
	3.....	99	0	103	0	+1.5	0	+3.5	0	203	12	10.25	+4	-1.50			
Average.....	99	0	104.7	0	+1.5	0	+3.5	0	204	10	9.50	+4.5	-1.12				
<i>Subject IV.</i> Normal I.....	Jan. 30, 1914:	σ	deg.	σ	deg.	σ	deg.	σ	deg.	σ	σ	σ	σ	σ	σ	σ	σ
	1.....	109	0	109	0	+7	-4	0	-2	218	12	9.25	+7	+1.25			
	2.....	102	4	109	2	-7	0	-7	-4	232	15	8.25	-14	+1.00			
	3.....	116	0	116	4	-1	0	-10	0	229	18	7.50	-11	+1.75			

5.....	124	0	-15	0	127	0	-18	0	251	19	7.75	-33	7	+1.50
Average.....	112	0.8	-4	-1	116	1.2	-8.7	-1.5	228	16	8.15	-13	-5	+1.37
Feb. 18, 1914:														
1.....	²¹⁰⁸	²⁰			²¹¹¹	²¹⁰			²²¹⁹	²¹¹	^{29.25}			
2.....	121	0	-13	0	122	5	-11	+5	243	14	8.00	-24	-3	+1.25
3.....	131	0	-23	0	144	5	-33	+5	275	16	7.75	-56	-4	+1.50
4.....	143	0	-35	0	158	3	-47	+7	301	15	7.50	-82	-4	+1.75
Average.....	131.7	0	-24	0	141	4.3	-30	+5.7	273	15	7.75	-54	-4	+1.50
Mar. 19, 1914:														
1.....	112	0			117	-2			229	13	8.25			
2.....	113	3	-1	-3	126	4	-9	-6	239	11	8.00	-10	+2	+0.25
3.....	127	0	-15	0	130	3	-13	-5	257	13	7.75	-28	0	+ .50
4.....	125	0	-13	0	134	6	-17	-8	260	22	8.00	-31	-9	+ .25
5.....	123	0	-11	0	133	3	-16	-5	256	15	8.00	-27	-2	+ .25
Average.....	120	0.6	-10	0.75	128	2.8	-14	-6	248	15	8.00	-24	-2	+ .31
Subject VI.														
Normal I.....														
Oct. 22, 1913:														
1.....	108	0			90	0			198	1				
2.....	⁽⁴⁾													
3.....	⁽³⁾													
4.....	95	0	+13	0										
5.....	⁽⁴⁾													
6.....	⁽³⁾				95		-5							
Average.....	101				92									
Alcohol (dose A).....														
Oct. 29, 1913:														
1.....	²⁸⁷	²³	-25	+3	²¹⁰⁷	²²		+2	²¹⁹⁴	²¹⁴	^{25.25}			
2.....	112	0	-3	-7	115	1	-8	+1	205	5	6.25	-11	+9	-1
3.....	90	10	-8	-7	112	9	-5	-7	207	17	5.25	-13	-3	0
4.....	95	10	-8	-3	110	0	-3	+2		⁽³⁾	5.00			-0.25
5.....	⁽⁴⁾	6			⁽³⁾	⁽⁴⁾			⁽³⁾	⁽³⁾	5.00			+0.25
Average.....	99	6.5	-12	-3.5	112	2.5	-5	-0.5	206	11	5.45	-12	+3	-0.20
Jan. 22, 1914:														
1.....	²⁹⁹	²⁴			²¹¹⁷	²⁸			²²¹⁶	²¹⁷	²⁶			
2.....	113	0	-14	+4	130	0	-13	+8	243		4.25	-27		+1.75
3.....	138	2	-39	+2	135	5	-18	+3	273	14	4.25	-57	+3	+1.75
4.....	145	0	-46	+4	138	0	-21	+8	283		5.25	-67		+ .75
5.....	145	0	-46	+4	141	6	-24	+2	286	36	4.25	-70	-19	+1.75
6.....	175	1	-76	+3							4.25			+1.75
Average.....	143	0.6	-44	+3.4	136	2.7	-19	+5.2	271	25	4.45	-55	-8	+1.55

¹Records for period 1 missing.
²The values for the first period of the alcohol experiments were obtained before the alcohol was given and are therefore not included in the averages.
³Illegible.

TABLE 25.—*Eye-movements*—Continued.
[Time units in thousandths of a second.]

Subject and kind of experiment.	Date and number of period.	Movements to right.				Movements to left.				Sum of M. V. to right and left.	Num-ber of cycles.	Difference (1-2, 1-3, etc.).		
		Dura-tion.	Error (sum).	Difference (1-2, 1-3, etc.).		Dura-tion.	Error (sum).	Difference (1-2, 1-3, etc.).				Total move-ment.	M. V.	Num-ber of cycles.
				Dura-tion.	Error.			Dura-tion.	Error.					
<i>Subject IV</i> —con. 12 hr. experiment. Normal.....	Jan. 1, 1914:	σ	deg.	σ	deg.	σ	deg.	σ	deg.	σ		σ		
	1.....	87	11	99	10	186	19	6.25	19	186	19	6.25	0	
	2.....	90	8	116	5	206	19	5.00	19	206	19	5.00	-2	
	3.....	93	8	106	7	199	21	5.50	21	199	21	5.50	-13	
	4.....	93	5	101	1	194	15	5.75	15	194	15	5.75	+4	
	5.....	101	7	117	2	218	19	4.75	19	218	19	4.75	0	
	6.....	117	3	107	8	224	9	5.25	9	224	9	5.25	+10	
	7.....	127	1	117	-3	244	14	4.75	14	244	14	4.75	+5	
	8.....	113	1	120	2	233	11	5.25	11	233	11	5.25	+8	
	9.....	130	0	142	7	272	27	4.75	27	272	27	4.75	-47	
	10.....	107	1	127	0	234	9	5.75	9	234	9	5.75	-86	
Average.....	105.8	4.5	115	3.9	221	16	5.30	16	221	16	5.30	+39		
Alcohol (dose C).....	Jan. 2, 1914:													
1.....	1700	14	1715	10	1915	122	5.75	122	1915	122	5.75	+25		
2.....	89	8	98	15	190	15	5.75	15	190	15	5.75	+7		
3.....	111	2.5	114	-0.5	203	19	6.75	19	203	19	6.75	+1		
4.....	100	0	114	1	214	13	6.75	13	214	13	6.75	+7		
5.....	93	28	115	20	208	21	6.25	21	208	21	6.25	+7		
6.....	88	0	108	1	196	14	6.25	14	196	14	6.25	+19		
7.....	(?)	0	105	0	196	14	5.75	14	196	14	5.75	+8		
8.....	110	0	117	0	227	6	5.75	6	227	6	5.75	-12		
9.....	115	0	130	0	245	15	5.50	15	245	15	5.50	-30		
10.....	98	20	123	10	221	22	4.75	22	221	22	4.75	0		
11.....	120	0	115	0	235	25	5.75	25	235	25	5.75	-20		
Average.....	101	1.8	114	2.7	215	17	5.8	17	215	17	5.8	-0.4		
<i>Subject VII</i> . Normal I.....	Oct. 21, 1913:	97	0	97	0	194	5		194	5		+5.3		

2	100	0	-3	0	95	0	+2	0	195	5	-1	0
3	100	0	-3	0	100	0	-3	0	200	0	-6	+5
4	100	0	-3	0	100	0	-3	0	200	0	-6	+5
5	100	2	-3	-2	97	2	0	-2	197	7	-3	+2
Average	99	0.4	-3	-0.5	98	0.4	-1	-0.5	197	3	-4	+2
Oct. 28, 1913:												
1	190	1-1			194	1/6			1784	16	16.5	
2	90	0	0	-1	102	5	-8	+11	192	8	6.25	-8
3	89	0	+1	-1	110	0	-16	+16	199	5	6.00	-15
4	91	-2	-1	+1	116	5	-22	+11	207	10	6.50	-23
4 ⁶	90	0	0	-1	118	0	-24	+16	208	6	5.25	-24
Average	90	0.5	0	-0.5	111	5.2	-17	+13.5	201	7	5.75	-17
Mar. 13, 1914:												
1	157	1/2			105	1/4			1192	10	14.5	
2	97	0	-10	+12	117	8	-12	-4	214	9	4.25	-22
3	101	2.5	-14	+9.5	127	2.5	-22	+1.5	228	9	4.00	-36
4	108	0	-21	+12	122	1	-17	+3	230	6	3.50	-38
Average	102	3.6	-15	+11.2	122	3.8	-17	-1.7	224	8	3.92	-32
Mar. 20, 1914:												
1	89	0			96	7			185	6	5	
2	90	1	-1	-1	101	3	-5	+4	191	3	5	-6
3	104	0	-15	0	115	7	-19	0	219	6	4.25	-34
4	93	0	-4	0	112	3	-16	+4	205	9	3.75	-20
Average	94	0.25	-7	-0.33	106	5	-13	+2.7	200	6	4.5	-20
Oct. 27, 1913:												
1	87	0			105	8			192	2		
2	90	0	-3	0	105	0	0	+11	195	12	3.25	-3
3	84	0	+3	0	90	0	+15	+8	174	3	6.00	+18
4	90	-3	-3	3	113	0	-8	+8	203	9	4.25	-11
Average	88	-0.7	-1	+1	103	1.2	+2	+9	191	6	4.90	+1
Nov. 3, 1913:												
1	190	1/6			106	1/2			1196	16	15.5	
2	83	1.7	+7	-0.1	114	2.0	-8	-0.8	197	22	3.5	-1
3	93	1.0	-3	+6	138	4.0	-32	-2.8	231	22	3.7	-35
4	97	-2.0	-7	+3.6	118	1.0	-12	+0.2	215	11	4.5	-19
Average	91	0.2	-1	+1.4	123	2.3	-17	-1.1	214	18	3.9	-18

¹The values for the first period of the alcohol experiments were obtained before the alcohol was given and are therefore not included in the averages.

²These records showed several irregular eye-movements.

³Illegible.

⁴Records for period 5 illegible.

TABLE 25.—*Eye-movements*—Continued.
[Time units in thousandths of a second.]

Subject and kind of experiment.	Date and number of period.	Movements to right.				Movements to left.				Total movement.	Sum of M. V. to right and left.	Num-ber of cycles.	Difference (1-2, 1-3, etc.).			
		Dura-tion.	Error (sum).	Difference (1-2, 1-3, etc.).		Dura-tion.	Error (sum).	Difference (1-2, 1-3, etc.).					Total movement.	M. V.	Num-ber of cycles.	
				σ	deg.			σ	deg.							σ
<i>Subject IX</i> —con. Alcohol (dose B).....	Jan. 21, 1914:															
	1.....	192	1+2	σ	deg.	1708	σ	deg.	σ	deg.	1200	σ	14.7	σ	4	
	2.....	95	+4	-3	-2	136	-28	+16	-31	+4	231	12	4.7	-31	+4	0
	3.....	115	-2	-23	+4	160	-52	+10	23	-7	275	23	4.7	-75	7	0
	4.....	119	1	-27	+1	152	0	-44	+8	+8	271	30	5.2	-71	-14	-0.5
	5.....	122	4	-30	-2	184	0	-76	+8	+8	306	22	5.0	-106	6	-0.2
	6.....	106	-2	-14	+4	145	-3	-37	+11	251	20	4.7	51	-51	-4	0.0
	Average.....	111	+1	-19	+1	155	-2.6	-47	+10.6	267	21	4.9	67	-67	-5	-0.1
	<i>12 hr. experiment.</i> Normal.....	Dec. 22, 1913:														
		1.....	95	-5	-4	-6	120	1	+12	+2	215	13	4.75	8	+2	+0.25
		3.....	99	1	+8	-6	108	-1	-6	+2	207	11	4.50	+8	+2	+5
4.....		87	1	+8	-6	126	-1	-6	+2	213	8	4.50	+2	+5	+25	
5.....		90	0	+5	-5	117	0	+3	+1	(^g)	(^g)	(^g)	(^g)	(^g)	(^g)	
6.....		96	2	-1	-7	117	0	+3	+1	213	10	5.00	+2	+3	-25	
7.....		97	2	-2	-2	118	2	+2	-1	215	18	4.75	0	-5	+0.0	
8.....		92	6	+3	-11	115	4	+5	-3	207	14	4.50	+8	-1	+25	
9.....		100	-4	-5	-1	126	0	-6	+7	226	17	5.00	-11	-4	-25	
10.....		96	3	-1	-8	122	0	-2	+1	218	18	5.00	-3	-5	-25	
Average.....		95	0.7	+0.4	-6.4	119	-0.12	+1	+1.3	214	13.6	4.75	+0.9	-0.7	0	
Alcohol (dose C).....	Dec. 23, 1913:															
	1.....	196	14	-18	+4	1720	1-2	-10	-2	1216	112	15.00	28	+1	+0.50	
	2.....	114	0	-18	+3	130	0	-10	-2	244	11	4.50	-28	+1	+0.50	
	3.....	97	1	-1	+3	121	0	-1	-2	219	13	4.25	-3	-1	+75	
	4.....	104	0	-8	+4	121	1	-1	-3	225	14	5.00	-9	-2	+0.0	
	46.....	92	4	+4	0	123	5	-3	-7	215	23	4.50	+1	-11	+50	
	7.....	107	9	-11	-5	127	-4	+7	+2	235	24	4.50	+19	-12	+50	
	8.....	100	8	-4	-4	113	6	+7	-8	213	17	5.00	+3	-5	+0.0	
	9.....	100	7	-4	-3	132	0	-12	-2	232	17	5.25	-16	-5	-25	
	10.....	96	5	0	-1	122	-1	-2	-1	218	26	5.75	-2	-14	-75	
	90.....	90	15	+6	-11	112	0	+8	-2	202	12	5.50	+14	0	-50	
Average.....	100	5.4	-4	-1.4	122	0.8	+2.3	-2.8	223	17.4	4.92	+6.5	-5.4	+0.083		

<i>Subject X.</i>												
Normal.....												
Mar. 11, 1914:												
1.....	92	1.5	+ 2	- 0.5	101	6.5	+ 4	- 6.5	193	9	5.25	+ 2
2.....	90	2	- 3	- 5.5	97	13	- 4	- 5.5	187	7	6.25	+ 6
3.....	95	7	- 16	- 2.5	105	12	- 12	- 6.5	200	13	5.75	- 7
4.....	108	4	- 9	- 3.5	113	13	- 9	- 4.5	221	12	4.75	- 28
5.....	101	5	- 18	+ 2.5	110	11	- 17	- 5.5	211	10	5.50	- 18
6.....	110	- 1	- 18	+ 2.5	118	12	- 17	- 5.5	228	14	5.75	- 35
Average.....	99	3.1	- 9	- 1.9	107	11.25	- 7.6	- 5.7	207	11	5.5	- 16
Alcohol (dose A).....												
Mar. 18, 1914:												
1.....	101	12	- 1	- 6	111	17	- 3	+ 6	212	16	15.75	- 4
2.....	102	8	- 8	- 4	114	11	- 12	+ 11	216	22	5.75	- 4
3.....	103	6	- 2	- 4	123	6	- 9	- 7	(³)	(⁴)	5.75	- 4
4.....	111	5	- 10	- 3	120	20	- 9	- 3	226	12	5.00	- 14
5.....	120	16	- 19	- 14	130	10	- 19	+ 7	230	12	5.75	- 18
6.....	109	8.7	- 8	- 6.7	122	12	- 11	+ 5.2	248	10	5.50	- 36
Average.....	109	8.7	- 8	- 6.7	122	12	- 11	+ 5.2	230	14	5.50	- 18

PSYCHOPATHIC SUBJECTS.

<i>Subject XI.</i>												
Normal.....												
Mar. 26, 1914:												
1.....	92	5	+ 5	+ 1	70	13	- 10	+ 8	162	6		- 5
2.....	87	4	- 10	- 1	80	5	- 13	- 3	167	2		+ 4
3.....	89	4.5	- 11	+ 2.5	75	9	- 18	+ 1	164	4		
Average.....	89	4.5	- 11	+ 2.5	75	9	- 15	- 1	164	4		
Alcohol (dose A).....												
Mar. 27, 1914:												
1.....	190	16	- 12	- 1	182	11	- 13	- 3	172	12		+ 10
2.....	102	7	- 10	- 6	95	4	- 18	+ 1	197	2		- 25
3.....	100	0	- 10	+ 6	100	0	- 18	+ 1	200			- 28
4.....	100	0	- 10	+ 6	100	0	- 15	- 1	198			- 26
Average.....	101	3.5	- 11	+ 2.5	97	2	- 15	- 1	198			- 26
Normal.....												
Mar. 28, 1914:												
1.....	90	3	- 5	+ 1	100	5	- 2	+ 2	185	3		+ 1
2.....	95	2	- 5	+ 1	102	3	- 12	+ 4	195	2		+ 1
3.....	92	2.5	- 5	+ 1	112	1	- 12	+ 4	190	2		+ 1
Average.....	92	2.5	- 5	+ 1	105	3	- 7	+ 3	190	2		+ 1
<i>Subject XII.</i>												
Normal I.....												
Apr. 2, 1914:												
1.....	130	4	+ 18	- 3	113	0	- 7	+ 1	233	26		+ 13
2.....	102	7	+ 10	+ 1	117	0	- 4	0	222	13		+ 6
3.....	110	3	+ 10	+ 1	105	4	+ 8	- 4	227	21		+ 5
4.....	130	0	- 10	+ 4	100	21	+ 13	- 21	230	15		+ 11
5.....	115	3.5	+ 6	+ 0.7	111	4.8	+ 2	- 6	228	19		+ 7
Average.....	115	3.5	+ 6	+ 0.7	111	4.8	+ 2	- 6	228	19		+ 9.7

¹The values for the first period of the alcohol experiments were obtained before the alcohol was given and are therefore not included in the averages.

²Records for period 2 illegible.

³Illegible.

⁴Records for period 5 illegible.

⁵Records for period 1 missing.

TABLE 25.—*Eye-movements*—Continued.
[Time units in thousandths of a second.]
PSYCHOPATHIC SUBJECTS—CONTINUED.

Subject and kind of experiment.	Date and number of period.	Movements to right.				Movements to left.				Total movement.	Sum of M.V. to right and left.	Num-ber of cycles.	Difference (1-2, 1-3, etc.).		
		Dura-tion.	Error (sum).	Difference (1-2, 1-3, etc.).		Dura-tion.	Error (sum).	Difference (1-2, 1-3, etc.).					Total movement.	M. V.	Num-ber of cycles.
				Dura-tion.	Error.			Dura-tion.	Error.						
<i>Subject XVII</i> —con- Alcohol (dose A)	Apr. 3, 1914:	σ	deg.	deg.	σ	deg.	deg.	σ	deg.	σ					
	1.	1100	12	14	1110	12	14	1210	14	114					
	2.	122	2	2	122	0	2	244	3	8					
	3.	125	2	2	130	0	5	241	1	3					
	4.	125	-1	1	124	+3	1	249	+3	16					
	5.	120	0	0	120	+2	7	240	-3	10					
6.	108	2	2	112	0	0	220	+4	20						
Average	120	1	1	121.6	+1	2.8	241.6	+1.2	11.4						
Normal II	Apr. 4, 1914:														
	1.	120	-2	6	120	0	6	240	0	10					
	2.	120	1	-1	123	-3	-1	243	+7	4					
Average	120	-0.5	2.5	121	0	2.5	241	+7	7						
<i>Subject XIV</i> , Normal I	Apr. 23, 1914:														
	1.	90	2	2	90	+2	0	180	+1						
	2.	90	0	0	90	+1	0	180	+1						
	3.	95	1	3	90	+1	0	185	+1						
	4.	92.5	0	1	100	+2	1	182	+1						
Average	92.5	0.7	1.7	92	+1.7	1.7	182	+0.33							
Alcohol (dose A)	Apr. 24, 1914:														
	1.		12	15	180 (?)	+2	7	177	-2	13					
	2.	85	0	4	92	0	4	177	+1						
	3.	95	-1	5	90	+3	8	183	0	11					
	4.	95	2	5	90	0	5	185	0	8					
	5.	92	2	2	90	0	0	182	+5	8					
6.	92	1	1	90	+1	4.2	182	+0.8	10.7						
Average	92	1	1	90	+1	4.2	182	+0.8	10.7						
Normal II	Apr. 25, 1914:														
	2.	97	2	2	85	0	2	182	0	7					
	3.	90	5	1	92	-3	1	182	+1	2					
Average	93	3.5	1.5	88	0	1.5	182	+1	4.5						

¹The values for the first period of the alcohol experiments were obtained before the alcohol was given and are therefore not included in the averages.
²Records for period 1 missing.

TABLE 26.—Summary of eye-movements.
[Average values given in thousandths of a second.]

Subject and kind of experiment.	Movements to right.				Movements to left.				Total duration of movement.	Mean variation.	Number of cycles.	Difference. ¹		
	Duration.	Error.	Difference. ¹		Duration.	Error.	Difference. ¹					Total duration.	Mean variation.	Number of cycles.
			Duration.	Error.			Duration.	Error.						
<i>Normal subjects.</i>														
Normal I and II:	σ	deg.	σ	deg.	σ	deg.	σ	deg.	σ	σ	σ	σ	σ	
II.....	93	0.9	-3	-0.4	92	0.9	-12	+2.8	185	7	6.4	-16	+1	-0.1
	96	-0.33			98	2.2			193	19	6.7			
III.....	99	2.3	-1	-1.7	100	3.7	+1	+4.0	199	9	7.8	-1	-2	-0.4
	99	0			105	0			204	10	9.5			
IV.....	112	0.8	-7	-0.8	116	1.2	-11	-3.7	228	16	8.1	-18	-3	-0.8
	120	0.6			128	2.8			248	15	8.0			
VI.....	101	0	+13	0	92	0	-5	198	1
VII.....	99	0.4	-5	-0.4	98	0.4	-7	+1.1	197	3	-12	+1	+0.7
	94	0.2			106	5.0			200	6	4.5			
IX.....	88	-0.7	-1	+1.0	103	1.2	+2	+9.0	191	6	4.9	+1	-6
X.....	99	3.1	-9	-1.9	107	11.2	-8	-5.7	207	11	5.5	-16	-2	-0.3
Average...	99	1.0	-2	-0.6	101	2.7	-6	+1.2	201	7	6.5	-10	-2	-0.2
	102	0.1			109	2.5			211	12	7.2			
<i>Alcohol (dose A):</i>														
II.....	92	0	-7	0	107	10.0	-22	-5.0	199	22	5.6	-29	-22	-1.1
III.....	90	0	+6	0	88	-2.0	+9	+8.2	178	12	8.7	+16	-4	-0.5
IV.....														
VI.....	99	6.5	-12	-3.5	112	2.5	-5	-0.5	206	11	5.4	-12	+3	-0.2
VII.....	90	0.5	0	-0.5	111	2.5	-17	+13.5	201	7	5.7	-17	-1	+0.7
IX.....	91	0.2	-1	+1.4	123	2.3	-17	-1.1	214	18	3.9	-18	-2	+1.6
X.....	109	8.7	-8	-6.7	122	12.0	-11	+5.2	230	14	5.5	-18	+2	+0.2
Average...	95	2.6	-4	-1.5	110	4.5	-10	+3.4	205	14	5.8	-13	-4	+0.1
<i>Alcohol (dose B):</i>														
II.....	115	0	-21	0	122	0	-39	0	230	3.7	-67	+2.3
III.....	100	0	0	+2.0	106	0	-5	+3.0	207	13	9.2	-6	0	-0.2
IV.....	132	0	-24	0	141	4.3	-30	+5.7	273	15	7.7	-54	-4	+1.5
VI.....	143	0.6	-44	+3.4	136	2.7	-19	+5.2	271	25	4.4	-55	-8	+1.5
VII.....	102	0.8	-15	+11.2	122	3.8	-17	-0.2	224	8	3.9	-32	+2	+0.6
IX.....	111	1.0	-19	+1.0	155	-2.6	-47	+10.6	267	21	4.9	-67	-5	-0.1
X.....														
Average...	117	0.4	-20	+2.9	130	1.4	-26	+4.0	245	16	5.6	-47	-3	+0.9
<i>12 hr. experiments.</i>														
<i>Normal:</i>														
VI.....	106	4.5	-21	+7.2	115	3.9	-18	+6.8	221	16	5.3	-39	+3	+1.0
IX.....	95	0.7	0	-6.4	119	-0.1	+1	+1.3	214	14	4.7	+1	-1	0
Average...	100	2.6	-10	-0.4	117	1.9	-8	+4.0	217	15	5.0	-19	+1	+0.5
<i>Alcohol (dose C):</i>														
VI.....	101	1.8	0	+2.1	114	2.7	+1	-2.7	215	17	5.8	0	+5	-0.1
IX.....	100	5.4	-4	-1.4	122	0.8	-2	-2.8	223	17	4.9	-6	-5	+0.1
Average...	100	3.6	-2	+0.3	118	1.7	0	-2.7	219	17	5.3	-3	0	0
<i>Psychopathic subjects.</i>														
<i>Normal I and II:</i>														
XI.....	89	4.5	0	+1.0	75	9.0	-8	+5.0	164	4	-7	+2
	92	2.5			105	3.0			190	2			
XII.....	115	3.5	+3	-1.1	111	1.0	0	+0.5	228	19	+2	+8
	120	-0.5			121	2.5			241	7			
XIV.....	92	0.7	+1	-0.6	92	1.7	-5	+0.6	182	-2	+5
	93	3.5			88	1.5			182	4			
Average...	99	2.9	+1	-0.2	93	5.2	-4	+2.0	191	11	-2	+5
	102	1.8			105	2.3			204	4			
<i>Alcohol (dose A):</i>														
XI.....	101	3.5	-11	+2.5	97	2.0	-15	-1.0	198	-26	+10
XII.....	120	1.0	-20	+1.0	122	2.8	-12	+1.2	242	11	-32	+3
XIV.....	92	1.0	+1.0	90	4.2	-10	+0.8	182	11
Average...	104	1.8	-15	+1.5	103	3.0	-12	+0.3	207	11	-29	+6

¹Difference equals periods 1-2, 1-3, 1-4, etc.

SUMMARY OF EYE-MOVEMENT DATA.

In view of the fact that reliable data on the eye-movements are relatively few, and in view also of the peculiar importance of this group of measurements, as will appear in the concluding chapter, it seemed advisable to make the summary as complete as possible. A complete statement of all the averages is consequently given in table 26. In this table appear (1) the average duration of the eye-movements; (2) the average errors; and (3) the average differences, under each of the three headings "Movements to the right," "Movements to the left," and "Total," *i. e.*, the sum of the movements in both directions. In the group of data which is indicated as Normal I and Normal II the averages for both normal days are given in a single column. But the durations for the two days are given separately for each subject, whenever available, connected by a bracket. Similarly the averages at the foot of the columns appear double; the upper ones (99, 101, 201) are the average durations of the eye-movements of the group for the first normal day; the lower ones (102, 109, and 211) are the corresponding values for the second normal day. In giving the "differences" for this group of experiments the two normal days have been averaged, since that is the form in which they will be used in the subsequent tables.

The summary of the effect of alcohol on the eye-movements is given in tables 27 and 28. In the former, the effect is computed from the averages according to the formula: the average values after alcohol minus the average values of the two normal days equals the effect of alcohol. From table 27 it appears that the average duration after alcohol is almost uniformly greater than the average duration on normal days. In table 28 the effect of alcohol on the various processes is calculated from the "differences." In the left-hand part of the table the effect is stated in average differences; in the right-hand part it is stated in percentile differences. The formulæ for the two values are given in footnotes to the respective tables.

In order not to complicate our main results and obscure their bearing on the main question at issue, we would for the present abstract from the minor questions of ocular balance, the individual differences in the interaction between the internal and external recti, the amount of fixation error, and the number of cycles for the sake of giving greater emphasis to the most general of all the eye-movement data that are given under the heading of "Total." This averages -2.5 per cent after dose A, and -18.6 per cent after dose B. That is to say, after 30 c.c. of alcohol, eye-movements of 40° , without regard to the direction, took an average of 2.5 per cent longer time than under normal conditions. Similarly, after 45 c.c. of alcohol, they took an average of 18.6 per cent longer time than the normal. It is conspicuous that in all these values there is only one exception, viz, Subject III after dose A. It is further conspicuous that for all the subjects where there are comparable data,

dose B delayed the eye-movements more than dose A. These effects are equally obvious in the effects as calculated from the simple averages which are given in table 27.

The number of cycles in 5'' seems to show a significant change only after dose B, when it is diminished by 15.8 per cent. In this case, the simple averages given in table 27 again furnish corroborative evidence. Taken alone they would have indicated, however, that both doses operate to reduce the number of cycles.

TABLE 27.—Summary of effect of alcohol on the eye-movements as shown by changes in the average values. (Alcohol—normal.)

[Time units given in thousandths of a second.]

Subject and kind of experiment.	Effect on movements to right.		Effect on movements to left.		Effect on total movement.	Effect on mean variation.	Effect on number of cycles.
	Duration of movement.	Error.	Duration of movement.	Error.			
Normal subjects:							
Dose A:	σ	deg.	σ	deg.	σ	σ	
II.....	- 2	-0.3	+12	+8.5	+10	+ 9	-0.9
III.....	- 9	-1.1	-14	-3.8	-23	+ 3	+0.1
VI.....	- 2	+6.5	+20	+2.5	+ 8	+10
VII.....	- 6	+0.2	+ 9	-0.2	+ 3	+ 3	+1.2
IX.....	+ 3	+0.9	+20	+1.1	+23	+12	-1.0
X.....	+10	+5.6	+15	+0.8	+23	+ 3	0
Average.....	- 1	+1.9	+10	+1.5	+ 7	+ 7	-0.1
Dose B:							
II.....	+21	-0.3	+27	-1.5	+41	-2.8
III.....	+ 1	-1.1	+ 4	-1.8	+ 6	+ 4	+0.6
IV.....	+16	-0.7	+19	+2.3	+35	0	-0.3
VI.....	+42	+0.6	+44	+2.7	+73	+24
VII.....	+ 6	+0.5	+20	+1.1	+26	+ 4	-0.6
² IX.....	+23	+1.7	+52	-3.8	+76	+15	0
Average.....	+18	+0.1	+28	-0.2	+43	+ 9	-0.6
12 hr. experiments:							
Dose C:							
VI.....	- 5	-2.7	- 1	-1.2	- 6	+ 1	+0.5
IX.....	+ 5	+4.7	+ 3	+0.9	+ 9	+ 3	+0.2
Average.....	0	+1.0	+ 1	-0.1	+ 1	+ 2	+0.3
Psychopathic subjects:							
XI.....	+11	0	+ 7	-4.0	+21
XII.....	+ 3	-0.5	+ 6	+1.1	+ 8	- 2
XIV.....	0	-1.1	0	+2.6	0	+ 7
Average.....	+ 5	-0.5	+ 4	-0.1	+10	+ 2

¹No measurements of the eye-movements with dose A were made with Subject IV.

²No measurements of the eye-movements with dose B were made with Subject X.

The data for the psychopathic subjects are complete only for Subjects XI and XII. They show a consistent effect of alcohol in the same direction as the normal group, only considerably more in amount, averaging 12.9 per cent after dose A. The incomplete data for Subject XIV are in the same direction as those for Subjects XI and XII.

The two 12-hour experiments show opposite tendencies, as usual in these two subjects.

There is no consistent change in the errors of fixation due to the alcohol dose. Apparently the average error after dose A was materially greater than the normal error, or the error after dose B. The mean variation is increased after both dose A and dose B in table 27, but this change does not stand the test of the computation by differences.

In addition to these generalizations with respect to the effect of alcohol, there are other less important, but none the less interesting, general tendencies of our data. The errors of fixation which occurred in eye-movements to the left (adductive movements) are conspicuously larger than those in the movements to the right (abductive movements). While there are occasional exceptions to this rule, it seems to apply to all subjects, including the psychopaths. In general, the errors of

TABLE 28.—Summary of effect of alcohol on the eye-movements as shown by changes in the differences.
[Time units given in thousandths of a second.]

Subjects.	Effect as shown in average differences. ¹							Effect as shown in percentile differences. ²					
	Movements to right.		Movements to left.		Total.	Mean variation.	Number of cycles.	Movements to right.		Movements to left.		Total.	Number of cycles.
	Duration of movement.	Error.	Duration of movement.	Error.				Duration of movement.	Error.	Duration of movement.	Error.		
Normal:													
Dose A:	σ	deg.	σ	deg.	σ	σ		p. ct.	p. ct.	p. ct.	p. ct.	p. ct.	p. ct.
II.....	-4	+0.4	-10	-7.8	-13	-23	-1.0	-4.5	-11.8	-181.5	-7.5	-1.7
III.....	+7	+1.7	+8	+4.2	+17	-2	-0.1	+7.1	+7.9	+73.7	+8.5	-12.4
³ VI.....	-25	0	-25.8
VII.....	+5	-0.1	-10	+12.4	-5	-2	0	+5.4	+33.3	-10.4	+161.0	-2.6
IX.....	0	+0.4	-19	-10.1	-19	+4	+50.0	-18.1	-220.0	-9.8
X.....	+1	-4.8	-3	+10.9	-2	+4	+0.5	+1.0	-282.0	-2.8	+93.2	-0.9	+9.2
Average.....	-3	-0.5	-6	+1.9	-4	-4	-0.1	-3.4	+66.2	-7.0	-14.7	-2.5	-1.6
Dose B:													
II.....	-18	+0.4	-27	-2.8	-37	+2.4	-19.6	-32.1	-104.0	-29.0	+37.4
III.....	+1	+3.7	-6	-1.0	-5	+2	+0.2	+1.0	+530.0	-5.9	-2.5	-2.5	+2.3
IV.....	-17	+0.8	-19	+9.4	-36	-1	+2.3	-15.6	-17.0	+348.0	-16.2	+25.8
VI.....	-57	-14	-55.3	-13.6
VII.....	-10	+11.6	-10	-1.3	-20	+1	-0.1	-11.0	+290.0	-10.1	-35.2	-10.5	-2.2
⁴ IX.....	-18	0	-49	+1.6	-68	+1	-20.1	-46.2	+20.0	-34.7
Average.....	-19	+3.3	-21	+1.2	-33	+1	+1.2	-20.1	+410.0	-20.8	+45.3	-18.6	+15.8
12 hr. experiments:													
Alcohol:													
VI.....	+21	-5.1	+19	-9.5	+39	+2	-1.1	+22.6	-68.0	+17.7	-190.0	+19.5	-18.3
IX.....	-4	+5.0	-3	-4.1	-7	-4	+0.1	-4.2	-500.0	-2.5	+410.0	-3.3	+2.1
Average.....	+8	0	+8	-6.8	+16	-1	-0.5	+9.2	-284.0	+7.6	+110.0	+8.1	-8.1
Psychopathic:													
XI.....	-11	+1.5	-7	-6.0	-19	+8	-12.1	+32.0	-8.3	-95.2	-11.0
XII.....	-23	+2.1	-12	+0.7	-34	-5	-20.4	+161.5	-10.5	+21.2	-14.9
XIV.....	+1.6	-5	+0.2	+80.0	-5.9	+6.6
Average.....	-17	+1.7	-8	-1.7	-26	+1	-16.2	+91.2	-8.2	-22.5	-12.9

¹Effect on the average difference equals (av. 1-2, 1-3, 1-4, etc., alcohol) minus (av. 1-2, 1-3, 1-4, etc., normal).

²Effect on the percentile difference equals the effect of alcohol on the average difference divided by the average of the corresponding normals of the day.

³No records for Subject IV.

⁴No records for Subject X.

fixation decrease with repetition, as is shown by the comparison of the two normal days. Comparison of the normal days also shows that as a consequence of practice the duration of the eye-movements increases lightly for both groups of subjects. These two changes are probably to be regarded as causally related. With decreased errors of fixation, the eye-movement sweeps become more nearly full 40° and their duration would naturally increase proportionately.

If this connection is admitted, the actual angle velocity of the eye-movements appears to have been unaffected by the experimental repetition under otherwise similar circumstances. In spite of the larger errors, however, the adductive movements average slower than the abductive. This difference does not appear to be due to decreased maximum velocity of the eye-movements, but to a proportionately slower third phase, *i. e.*, the final 5° are slower. Any attempt to explain this peculiarity of our subjects would lead us too far from our main problems.

EFFECT OF ALCOHOL ON THE RECIPROCAL INNERVATION OF THE FINGER.

Eye-movements are not adapted to show the rapidity of free oscillatory movements of a member, and the consequent speed of alternating reciprocal innervations of antagonistic muscles. Successive eye-movements are regularly separated by moments of fixation, seldom less than $0.2''$ in duration. These are moments of significant vision, for the sake of which the eye-movements exist. True oscillatory movements of the eye can not be produced at will without considerable special practice.

In adopting the reciprocal innervation of the middle finger for measuring the speed of alternating reciprocal innervation of antagonistic muscles, we lose the almost ideal conditions with respect to independence of conscious control that obtain in measuring the velocity of the eye-movements. Finger-movements are subject to all sorts of intercurrent, facilitating and inhibiting conscious interference. The conditions which modify the rate of voluntary reciprocal innervations have not all been experimentally located. In long experiments one will expect warming-up, fatigue phenomena, and spurts of various sorts, as well as lapses of attention and interest, and changes due to subjective feelings of discomfort. (Compare Wells.¹) Long-continued finger-movements appear to violate our principle of simplicity at almost as many points as the ergographic experiments.

These considerations, and practical experience in a series of experiments in the fall of 1912, led us to abandon the arrangement of this experiment which was proposed in the program, namely, movements for intervals of $30''$ followed after $5''$ by another group of movements for $5''$. Other things being equal, that would be a most desirable

¹Wells, *Am. Journ. Psychol.*, 1908, **19**, pp. 345 and 437.

arrangement; it would give valuable data not only with respect to oscillation frequency, but with respect to the onset of fatigue and the rapidity of recovery. The insurmountable difficulty in this arrangement was that it proved impossible to secure maintained maximum effort from our subjects for 30 consecutive seconds. Unintentionally perhaps, but none the less really, some tended to adopt an initial speed that they could maintain. Spurts appeared from uncontrolled sources. Some may have been purely physiological. Some were clearly connected with the feeling that the effort had lapsed. In connection with the related but more complex tapping test, Wells states (p. 356): "The feelings of annoyance arising from a long-continued test make it desirable that the experiment should be one giving the requisite data in as short a time as possible." This may be generalized as follows: Every consideration, practical as well as theoretical, demands the shortest experimental period that will give the requisite data. In this particular case, spurts and variability due to discomfort and other causes were enormously reduced by adopting shorter experimental periods of 8". That these shorter periods were in fact more satisfactory than the 30" periods appears from the relative uniformity of the results.

Even in this relatively short experimental time, a regular decrement in the speed of oscillation, as measured by 2" intervals, shows the beginning of a fatigue process. Regularity in the onset of this fatigue process is our best insurance against initial indifference, and sub-maximal finger-movements. If no fatigue occurs, one suspects initial indifference. But if the fatigue drop is regular and normal, initial shirking is improbable, since it is beyond the capacity of an ordinary subject to simulate this gradual onset of fatigue.

Other forms of incomplete adaptation to the experimental conditions are less easily determined. Correlated pulse- and respiration-rate should be worth something in this respect as an indicator, but our knowledge of the pulse-changes due to effort allows at present no numerical correction of results from this source. A variable interplay of changed attention, effort, and adaptation to the experimental conditions must be admitted as a possible, if not an inevitable, source of disturbance of the results of the finger-movement tests. If our cases are sufficiently numerous, however, accidental disturbances of this sort should compensate and leave the general tendency of alcohol, both in direction and amount, clearly marked.

TECHNIQUE.

For purposes of comparison with existing data, our measurements of the most rapid possible reciprocal innervation of the finger may be regarded as the tapping test reduced to its simplest form. As ordinarily used, the "tapping test" measures the number of electric contacts that can be made by the subject, either between a stylus and a plate, or by the closure of a telegraph-key. Several considerations combine to make both of these processes physiologically unsatisfactory:

(1) A succession of taps is physiologically a succession of interrupted reciprocal innervations. Whether the interruption occurs early or late in the process, whether much or little force is exerted in the tap itself, will be an experimental accident which will be likely to suffer more or less irregular changes as the subject's experience suggests possible improvements. Wells¹ found that one effect of practice was to shorten the periods of contact with the key. Langfeld² found that practice tended to lessen the extent of the movement.

(2) A second disadvantage of the finger-taps as recorded by the telegraph-key or stylus, is the difficulty of isolating the finger-movements from other movements of the arm and hand. Probably the interchange of finger, wrist, and arm movements is less apt to occur in short periods than it is in long periods of experiment under the incentive of conscious fatigue. But practice may change the type of movement, and may bring different groups of muscles into use in the succeeding experimental periods. It seems certain that the tapping time of the different limbs is not uniform. In an unpublished experimental study of the finger-movements by Dodge, it proved possible to get a tapping-rate of the arm when all the muscles of the arm were in voluntary tetanus that could not be duplicated with the finger alone. In less degree the same holds true of the wrist-movements. This seems to correspond with the finding of Griffiths,³ that "loaded muscles in tetanus show a higher number of responses per second than unloaded." In the above case, the load was the contraction of the antagonistic muscle.

(3) Moreover, all arrangements for recording the rapidity of the finger-movements by stylus or telegraph-key demand a more or less consciously controlled position of the subject's arm, with a more or less conscious control of the aim of the finger or arm movements. By reducing the tapping test to its lowest physiological term, *i. e.*, the true reciprocal innervation of the finger, we have preserved the freedom of movement of the original experiments by Von Kries,⁴ and of the myographic experiments by Binet and Vaschide,⁵ without introducing the questionable ergographic complication of the latter work.

The reciprocal innervation of the finger, like the tapping test, seems to satisfy our demands for relatively slow practice improvements. As Wells states, "This would seem to indicate that such unsystematic practice in this function as we receive in normal life eliminated the marked gains so frequently seen at the beginning of practice curves."

APPARATUS.

In our experiments records of the finger-movements were never taken separately, but always in conjunction with corresponding pulse-records. The pulse-records are electro-cardiograms. The finger-movements were recorded on the same photographic record by the following device:

¹Wells, *Am. Journ. Psychol.* 1908, **19**, p. 445. ⁴Von Kries, *Archiv f. Physiol.*, 1886, Supplbd., p. 1.

²Langfeld, *Psychol. Review*, 1915, **22**, p. 453. ⁵Binet and Vaschide, *L'Année Psychol.*, 1897, p. 267.

³Griffiths, *Journ. Physiol.*, 1888, **9**, p. 39.

In front of the slit of the photographic recorder of the string galvanometer which recorded the pulse, a light wooden lever was placed so as to throw a shadow across the slit. The other end of this recording lever was attached to the finger by a light rod held against the upper phalanx of the middle finger by the pressure of an elastic band. The axis of the lever was so placed as to decrease the amplitude of the movement in the proportion 5 to 1. The mass of the entire recording system is about 7 grams. Since the leverage is the most favorable possible, both with respect to the recording-lever and its attachment to the finger, interference with the free movement of the finger is objectively and subjectively so slight as to be practically negligible. The finger feels no resistance to starting and no instrumental momentum in stopping.

POSITION OF THE SUBJECT.

For measurements of the finger-movements, the subject was seated in the steamer-chair approximately at position I. But the steamer-chair was so moved by the operator that the subject was nearer the recording-camera of the string galvanometer than in other experiments from position I. A stand with an adjustable arm-rest was so placed that the subject's right arm was comfortably supported with the hand near the edge of the recording-camera table, but slightly above the level of its top. The palm of the hand rested against a vertical wedge-shaped support, against which it was held by the flexible but regular pressure of a broad elastic band. The sharp end of this wedge rested against the palm of the subject's hand, leaving the digits entirely free to move in a horizontal plane. In a relaxed position, the upper phalanx of the middle finger should be perpendicular to the face of the recording-camera, so that when it was attached to the recording levers there would be as little lateral movement of the levers as possible. The operator was always careful that there should be no unnatural or forced position of the hand or fingers, and that the arm was comfortable. There was no restriction of the movement of the other fingers, but their movement did not affect the recording lever.

EXPERIMENTAL PROCEDURE.

While the subject sat in a half-reclining position in the steamer-chair, with electrodes in position, and connected for recording his electrocardiogram as in word-reaction movements, the chair was slid into position by the operator. The subject's arm was placed on the arm-support, so that his fingers were entirely free beyond the edge of the hand-support against which his palm was held by the pressure of the elastic band. A fine rubber band about 1 cm. in diameter was then placed so that it rested on the fold of the skin which separates the first phalanx of the finger from the palm of the hand. This elastic band served to hold an offset from the end of the horizontal member of the recording levers, and thus formed a flexible but close connection between



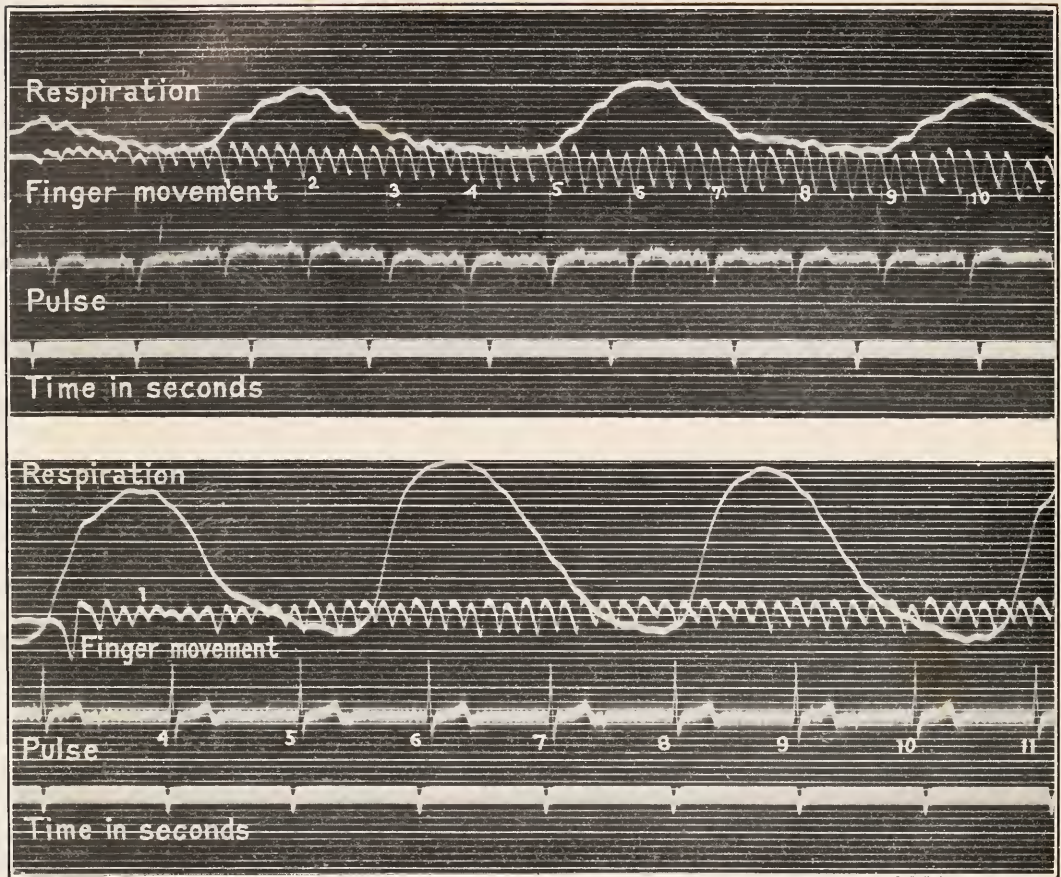

FIG. 28.—Typical records of the finger-oscillations and pulse of two subjects.

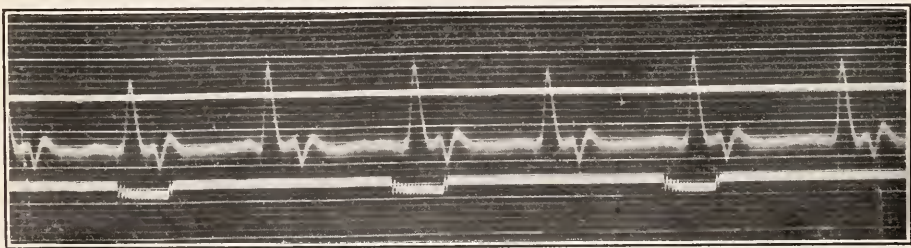

FIG. 29.—Reproduction of a temporal-pulse record as made by the Dodge telephone-recorder in series with the string galvanometer. (See p. 235.)

the finger and the recording levers. The vertical member of the recording levers was then adjusted to cast its shadow on the center of the slit of the recording-camera. The standard instructions were repeated by the operator. While the subject was entirely in position and relaxed as far as practicable, a normal pulse-record was taken without finger-movement. Immediately after this record a combined pulse- and finger-movement record was taken as follows: When the record started the operator said "go," in time with the stroke of a Jaquet clock, beating seconds. After 8'' the operator gave the signal "stop." After a 60'' rest, but without disturbing the position of the subject's arm or finger, a second finger-movement record was taken like the first.

The standard instructions, repeated before each experiment, were as follows: At the signal "go," move the middle finger back and forth as fast as you can until you receive the signal "stop."

Figure 28 reproduces two typical records of the reciprocal innervation of the finger by different individuals. They should be read from left to right. The lower line in each case marks the seconds (Jaquet clock). The next line is an electro-cardiogram (body leads); the upper line is the respiration curve. Inspiration is represented by a rising curve. The oscillating line shows the finger-movements.

Instructions to the assistants who were detailed to read finger-movement records were to commence reading 6 movements from the beginning in order to avoid the initial irregularities, which seem to be a characteristic of the beginning of almost every finger-oscillation curve. The reader then counted the number of complete oscillations in 2'', 4'', 6'', and 8'', respectively. Full 8'' of oscillation were so rarely completed in legible form that they seldom appear in the results. For the sake of uniformity the calculations are all based on 6'' of oscillation.

RESULTS.

The data for the reciprocal innervation of the finger are given in table 29, under the several subjects arranged in numerical order. The number of complete finger oscillations in 2'', 4'', and 6'' is entered in the appropriate columns. In the earliest experiments, as for example those with Subject II on October 8 and September 23, only one record was taken at each experiment. In the later experiments, where two records were taken, the data from both are given, together with their average. Wherever available these averages are used in the elaboration of the results.

TABLE 29.—Measurements of the reciprocal innervation of the middle finger. Complete oscillations.

Normal.				Alcohol.			
Subject, date, and number of period.	2"	4"	6"	Difference (1-2, 1-3, etc.).			
				2"	4"	6"	
<i>Subject I.</i>							
Oct. 8, 1913:							
1.....	12.8	25.0	36.8	-1.8	-1.8	-2.1
2.....	14.6	26.8	38.9	-0.2	0.0	0.0
3.....	13.0	25.0	36.8	-1.0	-0.9	-1.0
Average.....	13.5	25.6	37.5			
Mar. 17, 1914:							
1.....	12.1	23.3	33.9
Av.....	12.3	25.1	37.3
2.....	12.2	24.2	35.6
.....	11.8	24.0	34.5
Av.....	11.4	23.9	35.1
3.....	11.6	23.9	34.8	+0.6	+0.3	+0.8
.....	11.2	22.0	33.3
Av.....	12.1	24.5	35.5
4.....	11.6	23.2	34.4	+0.6	+1.0	+1.2
.....	11.8	23.8	35.1
Av.....	11.4	22.9	33.9	+0.8	+1.3	+1.7
Average.....	11.7	23.5	34.7	+0.7	+0.9	+1.2
<i>Subject II.</i>							
Sept. 23, 1913:							
Dose A:							
1.....	14.0	14.0	14.0
2.....	13.5	27.5	40.7
3.....	13.0	26.3	39.6
4.....	13.7	26.3	38.3
5.....	13.4	26.3	39.8
6.....	13.6	26.7	39.4
7.....	13.5	27.0	40.0
8.....	14.0	27.6	40.3
9.....	13.2	25.8	38.3
10.....	14.3	27.7	41.0
11.....	14.4	27.3	40.3
12.....	14.0	26.4	38.4
13.....	13.7	26.9	39.6
Average.....	13.7	26.9	39.6
Mar. 10, 1914:							
Dose B:							
1.....	13.4	26.2	38.5
.....	12.0	24.2	36.0
Av.....	12.7	25.2	37.2
2.....	12.3	23.9	34.2
.....	11.5	23.4	33.9
Av.....	11.9	23.6	34.0	+0.8	+1.6	+3.2
3.....	11.5	21.9	31.9
.....	11.8	22.5	34.2
Av.....	11.6	22.2	33.0	+1.1	+3.0	+4.2
4.....	12.0	23.1	34.5
.....	10.6	20.7	31.4
Av.....	11.3	21.9	32.9	+1.4	+3.3	+4.3
Average.....	11.6	22.6	33.3	+1.1	+2.6	+3.9

Jan. 28, 1914:									
Dose B:									
1.....	9.3	19.1	28.3						
Av.....	9.9	19.1	28.4						
2.....	19.6	19.1	28.3						
Av.....	9.2	17.7	26.3						
3.....	9.0	17.8	26.1						
Av.....	9.1	17.7	26.2					+0.5	+1.4
4.....	8.7	17.5	25.7						
Av.....	8.5	16.5	24.5					+1.0	+2.1
5.....	8.6	17.0	25.1						
Av.....	8.8	17.5	25.6						
5.....	8.4	16.9	24.6						
Av.....	8.6	17.2	25.1					+1.0	+1.9
5.....	9.5	18.8	28.0						
Av.....	(8.2)								
Av.....	8.4	17.5	25.7					+0.7	+1.0
Av.....	8.9	18.1	26.8					+0.7	+1.5
Average.....									
8.8									
17.5									
25.8									
+0.8									
+1.6									
+2.5									
12 hr. experiment.									
Jan. 2, 1914:									
Dose C:									
1.....	8.9	17.5	26.4						
Av.....	9.6	18.2	27.0						
2.....	19.2	17.8	26.7						
Av.....	9.2	18.0	26.4						
3.....	8.9	17.6	26.4						
Av.....	9.0	17.8	26.4					+0.2	0.0
4.....	9.2	18.2	26.9						
Av.....	8.3	16.9	25.3					+0.5	+0.6
5.....	8.7	17.5	26.1						
Av.....	9.0	17.5	26.2						
6.....	8.6	17.5	26.0						
Av.....	8.8	17.5	26.1					+0.4	+0.3
+0.6									
12 hr. experiment.									
Jan. 1, 1914:									
1.....	9.0	17.5	26.0						
Av.....	8.7	17.5	25.7						
2.....	8.8	17.5	25.8						
Av.....	9.2	17.9	26.5						
3.....	8.5	17.3	26.3						
Av.....	8.8	17.6	26.4					0.0	-0.6
4.....	9.3	18.0	26.4						
Av.....	8.5	17.3	26.3						
5.....	8.9	17.6	26.3					-0.1	-0.5
Av.....	9.4	18.0	26.2						
6.....	9.6	18.7	28.2						
Av.....	9.5	18.3	27.2					-0.7	-1.4

¹The values for the first period of the alcohol experiments were obtained before the alcohol was given and are therefore not included in the averages.

²No records for period 3.

³Very small amplitude.

TABLE 29.—Measurements of the reciprocal innervation of the middle finger. Complete oscillations—Continued.

Normal.				Alcohol.		
Subject, date, and number of period.	2"	4"	6"	Difference (1-2, 1-3, etc.).		
				2"	4"	6"
<i>Subject VI—con.</i>						
<i>12 hr. experiment—con.</i>						
Jan. 1, 1914—con.:						
5.....	9.0	17.9	26.7	10.3	19.9	29.1
Av.....	8.8	17.4	25.6	9.1	18.4	27.5
6.....	8.9	17.6	26.1	9.7	19.1	28.3
Av.....	9.9	19.2	28.4	9.1	17.9	27.0
7.....	8.5	17.1	25.5	9.0	17.9	26.3
Av.....	9.2	18.1	26.9	9.0	17.9	26.6
8.....	8.6	17.0	25.4	8.7	16.9	26.1
Av.....	8.9	17.9	26.9	8.7	17.7	26.1
9.....	8.7	17.4	26.1	8.5	17.0	25.0
Av.....	9.2	17.7	26.2	8.6	17.3	25.5
10.....	8.5	17.0	25.0	9.7	19.0	28.5
Av.....	8.8	17.3	25.6	9.9	18.3	27.2
11.....	8.5	17.6	25.5	9.5	18.9	27.8
Av.....	8.3	16.4	24.4	9.7	18.6	27.5
12.....	8.4	17.0	24.9	9.0	18.4	27.4
Av.....	8.9	17.5	25.9	8.9	17.8	26.4
13.....	8.5	16.5	24.5	8.9	18.1	26.9
Av.....	8.7	17.0	25.2	9.08	17.97	26.8
Average.....	8.8	17.5	26.05	9.08	17.97	26.8
<i>Subject VII.</i>						
Oct. 8, 1913:						
1.....	12.8	25.2	37.1	13.8	26.2	38.8
2.....	12.8	25.5	36.9	13.2	24.9	36.0
3.....	13.0	25.2	37.0	12.0	23.2	34.0
Average.....	12.9	25.3	37.0	13.0	25.0	34.8
Mar. 20, 1914:				13.0	24.2	34.8
1.....	12.5	25.3	37.5	13.0	24.2	34.8
Average.....	12.5	25.3	37.5	13.0	24.2	34.8

Av.	24.8	36.3				6.	12.0	23.0	33.6	+1.8	+3.2	+5.2
2	12.4	36.9				7.	10.2	23.0	33.0	+3.6	+3.2	+5.8
Av.	14.4	41.9				Average.	12.2	23.9	34.4	+1.6	+2.3	+4.4
3	13.1	36.8				Mar 13, 1914:						
4	13.7	39.3	-1.3	-1.8	-2.4	Dose B:						
Av.	13.5	39.1				1.	13.6	26.4	37.9			
5	11.9	35.9				Av.	13.0	25.2	37.5			
Av.	12.7	37.5	-0.3	-0.3	-0.6	2.	12.7	24.3	35.4			
6	13.4	33.5				Av.	11.4	22.0	32.7			
7	11.6	33.5	-0.1	+0.5	+3.4	3.	12.0	23.1	34.0	+1.3	+2.7	+3.7
Av.	12.5	33.5				Av.	10.9	21.9	31.9			
Average.	12.8	36.8	-0.6	-0.5	+0.1	Av.	12.0	23.2	34.0			
						Av.	11.4	22.5	32.9	+1.9	+3.3	+4.8
						Average.	11.7	22.8	33.4	+1.6	+3.0	+4.2
<i>Subject VIII.²</i>						<i>Subject VIII.²</i>						
Oct. 9, 1913:						Oct. 16, 1913:						
1.	12.0	22.9				Dose A:						
2.	12.1	33.8	-0.1	-0.1	-1.6	1.	13.0	25.0	36.5			
3.	11.8	22.8	+0.2	+0.1	-1.6	2.	10.0	21.5	32.3	+3.0	+3.5	+4.2
4.	10.5	31.0	+1.5	+1.9	+1.2	3.	11.0	22.1	32.5	+2.0	+2.9	+4.0
5.	10.8	31.0	+1.2	+1.7	+1.2	4.	11.0	22.0	33.5	+2.0	+3.0	+3.0
Average.	11.4	32.4	+0.7	+0.9	-0.2	5.	10.1	22.4	33.9	+2.9	+2.6	+2.6
						6.	11.4	23.0	33.5	+1.6	+2.0	+3.0
<i>Subject IX.</i>						7.	10.9	21.7	33.0	+2.1	+3.3	+3.5
Oct. 10, 1913:						8.	12.0	23.0	34.0	+1.0	+2.0	+2.5
1.	12.5	23.5				Average.	10.9	22.2	33.2	+2.08	+2.8	+3.3
2.	13.5	27.0	-1.0	-3.5	-7.0	<i>Subject IX.</i>						
3.	13.0	35.2	-0.5	-1.0	-2.4	Oct. 20, 1913:						
4.	13.2	36.8	-0.7	-1.7	-4.0	Dose A:						
5.	12.0	36.0	+0.5	0.0	-3.2	1.	11.9	24.9	37.0	-1.0	+0.7	+1.3
Average.	12.8	36.1	-0.4	-1.5	-4.1	2.	12.9	24.2	35.7	+0.3	+1.9	+3.0
						3.	11.6	23.0	34.0	+0.8	+2.2	+3.2
						4.	11.1	22.7	33.0	-0.1	+2.0	+3.0
						5.	12.0	22.9	33.8	+0.7	+2.4	+3.0
						6.	11.2	22.5	34.0	+0.7	+1.8	+2.9
						Average.	11.7	23.0	34.1	+0.14	+1.8	+2.9

¹The values for the first period of the alcohol experiments were obtained before the alcohol was given and are therefore not included in the averages.

²Subject VIII was unable to complete the series of experiments. His records are consequently omitted from the percentile effects, table 33.

25.....	12.9	25.9			10.7	22.4	+2.4	+2.6
Av.....	12.0	23.6			10.8	23.1	+2.3	+1.9
6.....	12.4	24.7	-2.1	-2.4	11.0	23.5	+2.1	+1.5
Av.....	12.6	24.0			12.2	24.8		
7.....	9.9	21.6	-0.9	-0.5	10.2	22.3	+1.9	+1.5
Av.....	11.2	22.8			11.2	23.5		
8.....	12.9	24.3			311.5	24.0	+1.6	+1.0
Av.....	11.6	23.8	-1.9	-1.7	12.6	25.1		
9.....	12.2	24.0			9.1	19.4		
Av.....	12.4	25.1	-1.7	-2.0	10.8	22.2	+2.3	+2.8
10.....	11.6	23.5			13.0	24.6		
Av.....	12.0	24.3	-1.7	-2.0	10.1	20.6	+1.6	+2.4
11.....	13.4	27.0	-2.1	-2.5	11.5	22.6		
Av.....	11.5	22.6			11.6	21.5		
12.....	12.4	24.8			10.4	21.6	+2.1	+3.5
Av.....	12.1	24.7	-1.1	-1.3	11.0	21.5		
13.....	10.7	22.5			12.4	25.1		
Av.....	11.4	23.6	-1.5	-1.5	10.6	21.5	+1.6	+1.7
Average.....	11.6	23.6			11.24	23.1	+1.86	+1.90
Subject X.								
Feb. 11, 1914:								
1.....	15.4	29.8	44.6		16.0	31.8	46.3	
Av.....	16.0	30.6	45.4		16.5	32.0	45.3	
2.....	15.7	30.2	45.0		16.2	31.9	45.8	
Av.....	16.3	31.5	45.5		16.0	31.8	47.0	
3.....	16.5	31.0	44.5		16.0	31.7	46.7	
Av.....	16.4	31.2	45.0	-0.7	16.0	31.7	46.8	+0.2
4.....	16.0	31.3	45.0		16.2	31.2	45.8	-1.0
Av.....	16.0	31.5	44.8		16.3	31.8	47.5	
5.....	16.0	31.4	44.9	-0.3	16.2	31.5	46.6	0.0
Av.....	16.3	31.5	46.5		15.5	31.2	45.5	+0.4
6.....	16.2	31.3	46.4		16.5	32.2	47.4	
Av.....	16.2	31.4	46.4	-0.5	16.0	31.7	46.4	+0.2
Average.....	16.07	31.05	45.3	-0.5	16.07	31.6	46.6	+0.13
			-1.1	-0.4			+0.3	-0.8

¹The values for the first period of the alcohol experiments were obtained before the alcohol was given and are therefore not included in the averages.

²No records for period 4.

³Finger-movements stopped 0.75%.

TABLE 29.—Measurements of the reciprocal innervation of the middle finger. Complete oscillations—Continued.
PSYCHOPATHIC SUBJECTS.

Normal.				Alcohol.			
Subject, date, and number of period.	2"	4"	6"	Difference (1-2, 1-3, etc.).			6"
				2"	4"	6"	
<i>Subject XI.</i>							
Mar. 24, 1914:							
1.....	11.7	22.8	33.8				
	12.4	23.7	34.4				
Av.....	12.0	23.2	34.1				
Dose A:							
2.....	11.8	23.1	34.0				
	12.3	23.5	34.6				
Av.....	12.0	23.3	34.3	0.0	-0.1	-0.2	
Dose B:							
3.....	11.9	23.0	33.3				
	11.8	23.6	35.3				
Av.....	11.8	23.3	34.3	+0.2	-0.1	-0.2	
Average.....							
	11.9	23.3	34.2	+0.1	-0.1	-0.2	
Mar. 28, 1914:							
1.....	12.5	24.8	37.0				
2.....	13.0	24.8	36.3				
	13.6	25.7	37.3				
Av.....	13.3	25.2	36.8	-0.8	-0.4	+0.2	
Dose C:							
3.....	13.0	25.0	36.8				
	12.7	24.5	36.0				
Av.....	12.8	24.7	36.4	-0.3	+0.1	+0.6	
Average.....							
	12.9	24.9	36.7	-0.6	-0.15	+0.4	
<i>Subject XII.</i>							
Mar. 31, 1914:							
1.....	11.1	21.4	31.5				
	12.0	23.0	33.2				
Av.....	11.5	22.2	32.3				
Dose D:							
2.....	11.1	21.5	31.0				
	10.8	21.5	31.9				
Av.....	10.9	21.5	31.4	+0.6	+0.7	+0.9	
Dose E:							
3.....	10.8	21.0	30.5				
<i>Subject XIII.</i>							
Apr. 1, 1914:							
Dose A:							
1.....				10.5	20.2	29.2	
				10.8	20.7	30.3	
Av.....				10.6	20.4	29.7	
Dose B:							
2.....				10.4	20.3	29.7	
				10.3	20.5	30.8	
Av.....				10.3	20.4	30.2	
Average.....							
				12.4	24.3	35.5	+0.97 +1.7 +2.3

Av	10.5	20.9	30.8	+0.9	+1.2	+1.7	10.4	20.3	30.3	-0.2	-0.9	-2.5
Average	10.6	20.9	30.6	+0.9	+1.2	+1.7	11.2	22.3	34.1	-0.2	-0.9	-2.5
Apr. 4, 1914:	11.0	21.5	31.4	+0.7	+0.9	+1.3	10.8	21.3	32.2	-0.4	-1.4	-2.9
1	10.5	21.3	31.7				11.2	22.2	33.0			
Av	11.3	22.0	32.5				10.8	21.5	32.2			
2	10.9	21.6	32.1				11.0	21.8	32.6			
Av	10.5	21.1	31.7				10.7	21.2	31.7	-0.1	-0.8	-1.9
3	11.4	22.3	31.1									
Av	10.9	21.7	31.4	0.0	-0.1	+0.7						
4	10.8	21.3	31.3									
Av	11.3	22.0	32.4									
5	11.0	21.6	31.8	-0.1	0.0	+0.3						
Average	10.9	21.6	31.8	-0.05	-0.05	+0.5						
Subject XIV.												
Apr. 21, 1914:												
1	12.3	24.7	36.2				13.2	25.7	37.8			
Av	15.5	29.3	41.8				14.3	27.7	40.5			
2	13.9	27.0	39.0				13.7	26.7	39.15			
3	14.5	26.8	39.6				14.5	29.0	41.5			
Av	14.0	27.3	40.0	-0.3	0.0	-0.8	14.4	29.0	42.5			
4	14.25	27.05	39.8				14.45	29.0	42.0	-0.7	-2.3	-2.9
5	14.0	27.5	40.5				13.6	27.5	40.3	+0.1	-0.8	-1.2
Av	14.5	27.5	40.8				14.8	28.6	41.5	-1.1	-1.9	-2.4
	14.25	27.5	40.6	-0.3	-0.5	-1.6	14.8	29.0	42.5			
Average	14.1	27.2	39.8	-0.3	-0.25	-1.2	15.5	30.5	44.2			
Apr. 25, 1914:							15.15	29.7	43.3	-1.4	-3.0	-4.2
1	14.8	30.0	44.0				14.5	28.7	41.8	-0.77	-2.0	-2.7
Av	15.4	30.5	45.3									
2	15.1	30.25	44.6									
3	15.5	30.2	44.0									
Av	16.0	31.4	46.5									
4	15.7	30.8	45.2	-0.6	-0.6	-0.6						
5	16.0	30.8	45.2	-0.9	-0.6	-0.6						
Av	15.4	29.6	44.0									
	15.4	29.4	44.4									
Average	15.45	29.5	44.2	-0.3	+0.7	+0.4						
	15.5	30.3	44.8	-0.6	-0.17	-0.3						

¹The values for the first period of the alcohol experiments were obtained before the alcohol was given and are therefore not included in the averages.

SUMMARY OF FINGER-MOVEMENT DATA.

Summaries of the data on the reciprocal innervation of the finger are given in tables 30 and 31. Table 30 gives the average number of oscillations; table 31 gives the average differences between the first and the succeeding periods of each session. In table 30 the total averages for the normal subjects show how uniform is the fatigue effect even within the 6'' periods of our experiments. The averages of the

TABLE 30.—*Summary of the average number of reciprocal innervations of the middle finger.*

Number of subject.	Normal.			Alcohol (dose A). ¹			Alcohol (dose B)			
	Number of experiment.	2''	4''	6''	2''	4''	6''	2''	4''	6''
Normal subjects:										
II.....	I.....	13.5	25.6	37.5	13.7	26.9	39.6	11.6	22.6	33.3
	II.....	11.7	23.5	34.7						
	Av.....	12.6	24.5	36.1						
III.....	I.....			36.8	13.0	25.1	37.0	12.7	24.3	35.6
	II.....	12.4	24.4	35.8						
	Av.....	12.4	24.4	36.3						
IV.....	I.....			35.7			37.6	12.3	24.4	35.9
	II.....	12.4	24.5	36.4						
	Av.....	12.4	24.5	36.0						
VI.....	I.....	9.6	18.9	27.8	8.4	16.4	24.2	8.8	17.5	25.8
VII.....	I.....	12.8	25.3	37.0	12.2	23.9	34.4	11.7	22.8	33.4
	II.....	12.9	25.4	36.8						
	Av.....	12.8	25.3	36.9						
VIII.....	I.....	11.4	22.2	32.4	10.9	22.2	33.2			
IX.....	I.....	12.8	24.7	36.1	11.7	23.0	34.1	10.8	21.7	31.9
X.....	I.....	16.1	31.0	45.3	16.1	31.6	46.6			
	Total average..	12.5	24.5	35.8	12.3	24.2	35.8	11.3	22.2	32.6
12 hr. experiments:										
VI.....	I.....	8.8	17.5	26.0	19.1	18.0	126.8			
IX.....	I.....	11.6	23.6		11.2	23.1				
	Average..	10.2	20.5	26.0	10.1	20.5	126.8			
Psychopathic subjects:										
XI.....	I.....	12.4	24.1	35.4	12.4	24.3	35.5			
XII.....	I.....	10.9	21.5	31.6	10.7	21.2	31.7			
XIV.....	I.....	14.8	28.7	42.3	14.5	28.7	41.8			
	Average..	12.7	24.8	36.4	12.5	24.1	36.3			

¹Dose C (12 c.c.) was used in the 12-hour experiments.

normal experiments show that in the last 2'' the performance fell off 9.6 per cent of the first 2''. There are no exceptions to the rule among the normal subjects. A similar fatigue process appears after alcohol. But it is conspicuous that it is less than on normal days. After dose A the last period of 2'' differs from the first 2'' by only 5.7 per cent. After dose B the difference is 8 per cent. Without further knowledge

of the conditions that relate initial depression of the performance to decreased fatigue, one must be cautious about ascribing this decreased fatigue after alcohol directly to the alcohol. But it is a rather suggestive fact that the decreased fatigability after dose A changes a depression of the phenomenon at the end of the first 2'' to an equally good performance at the end of 6''. If one might venture a preliminary hypothesis, it looks as though the effect of alcohol on the reciprocal

TABLE 31.—Summary of average differences between the first and succeeding periods of reciprocal innervation of the middle finger.

Number of subject.	Normal.			Alcohol (dose A). ¹			Alcohol (dose B).				
	Number of experiment.	2''	4''	6''	2''	4''	6''	2''	4''	6''	
Normal subjects:											
II	I	-1.0	-0.9	-1.0							
	II	+0.7	+0.9	+1.2							
	Av.	-0.1	0	+0.1	+0.3	+1.6	+2.0	+1.1	+2.6	+3.9	
III	I			+1.4							
	II	0	+0.2	+0.1							
	Av.	0	+0.2	+0.7	+0.5	+1.5	+2.5	-0.6	-0.6	-1.4	
IV	I			-4.0							
	II	-0.1	-0.1	+0.2			+0.4	-0.1	+0.1	+0.2	
	Av.	-0.1	-0.1	-1.9							
VI	I	+0.7	+1.1	+0.9	+1.6	+3.3	+5.3	+0.8	+1.6	+2.5	
	II	-0.1	-0.1	+0.1							
VII	I	-0.6	-0.5	+0.1	+1.6	+2.3	+4.4	+1.6	+3.0	+4.2	
	II	-0.3	-0.3	+0.1							
	Av.	-0.3	-0.3	+0.1							
VIII	I	+0.7	+0.9	-0.2	+2.1	+2.8	+3.3				
IX	I	-0.4	-1.5	-4.1	+0.1	+2.0	+3.0	+1.4	+2.9	+4.9	
X	I	-0.5	-1.1	-0.4	+0.1	+0.3	-0.8				
		Total average.	0	-0.1	-0.6	+0.9	+2.0	+2.7	+0.7	+1.6	+2.4
12 hr. experiments:											
VI	I	-0.1	0	-0.25	+0.1	-0.17	-0.1				
	II	-1.5	-1.5		+1.9	+1.9					
	Average.	-1.3	-0.7		+1.0	+0.8					
Psychopathic subjects:											
XI	I	-0.2	-0.1	+0.1	+1.0	+1.7	+2.3				
	II	+0.3	+0.4	+0.9	-0.1	-0.8	-1.9				
XIV	I	-0.4	-0.2	-0.7	-0.8	-2.0	-3.0				
	II										
	Average.	-0.1	0	+0.1	0	-0.4	-0.9				

¹Dose C was given in the 12-hour experiments.

innervation of the finger was analogous to its action on the reflexes. With a depressed initial performance after alcohol the relative fatigue in subsequent performances is lessened. The summary of average differences confirms this general relationship.

Summaries of the effect of alcohol on the reciprocal innervation of the finger are given in tables 32 and 33. Table 32 is calculated from the

averages and is included here only for comparison with the regular summary from the differences, which is given in table 33. In table 33 we have followed our general custom, showing the effect of alcohol on the average differences on the left and the effect on percentile differences on the right. From this right-hand half of table 33 it appears that the effect of alcohol on the finger-movements is to increase the average differences about 9 per cent for both doses. That is to say, after alcohol the number of reciprocal innervations of the finger is decreased about 9 per cent.

The only exception to this rule after dose A of alcohol is the case of Subject X, who has had considerable practice in playing the piano. In his case the total change is less than 1 per cent gain after alcohol. While this is practically negligible, the exception to the rule in this case is clear. After dose B the exception is Subject III. It is of

TABLE 32.—*Summary of the effect of alcohol on the reciprocal innervation of the middle finger as shown by the averages.*

Number of subject.	Dose A.			Dose B.		
	2"	4"	6"	2"	4"	6"
Normal subjects:						
II.....	+1.1	+2.4	+3.5	-0.1	-1.9	-2.8
III.....	+0.6	+0.7	+0.7	+0.3	-0.1	-0.7
IV.....			+1.6	-0.1	-0.1	-0.1
VI.....	-1.2	-2.5	-3.6	0	-1.4	-2.0
VII.....	-0.6	-1.4	-2.5	-1.1	-2.5	-3.5
VIII.....	-0.5	0	+0.8			
IX.....	-1.1	-1.7	-2.0	-2.0	-3.0	-4.2
X.....	0	+0.6	+1.3			
Average.....	-0.2	-0.3	0	-0.6	-1.5	-2.2
Psychopathic subjects:						
XI.....	0	+0.2	+0.1			
XII.....	-0.2	-0.3	+0.1			
XIV.....	-0.3	0	-0.5			
Average.....	-0.2	0	-0.1			

interest in this latter exception that the subject began the alcohol day with the lowest "normal of the day" of all his experiments. Comparison with his performance after dose A makes it probable that this accidentally low normal of the day is responsible for the apparent exception. It was exactly such accidental values that our insistence on group values was designed to compensate. It is significant that apart from this exceptional case, the average depression of reciprocal innervation is greater with the greater dose of alcohol. Without the negative case in each group, the proportional change would be more symmetrical.

The measurements of the psychopathic group in this test contrast sharply with those of the moderate users. Of the three psychopathic subjects, only one, Subject XI, follows the rule of moderate users, the

others, Subjects XII and XIV, show reversed results. This difference is too clear to be accidental. Together with the other peculiarities of this small group, it points to a probable class difference that constitutes one of the most interesting and important unsolved problems which are suggested by our measurements.

TABLE 33.—*Summary of the effect of alcohol on the reciprocal innervation of the middle finger as shown by the differences.*

Subject and kind of experiment.	Effect as shown in average differences. ¹						Effect as shown in percentile differences. ²					
	Dose A.			Dose B.			Dose A.			Dose B.		
	2"	4"	6"	2"	4"	6"	2"	4"	6"	2"	4"	6"
Normal subjects:												
II.....	+0.4	+1.6	+1.9	+1.2	+2.6	+3.8	+ 3.1	+ 6.2	+ 5.1	+ 9.4	+10.5	+10.4
III.....	+0.5	+1.3	+1.8	-0.6	-0.8	-2.1	+ 3.8	+ 5.1	+ 4.8	- 4.7	- 3.3	- 5.8
IV.....	+2.3	0	+0.2	+2.1	+ 6.4	+ 0.8	+ 6.0
VI.....	+0.9	+2.2	+4.4	+0.1	+0.5	+1.6	+ 9.0	+11.2	+15.2	+ 1.0	+ 2.6	+ 5.6
VII.....	+1.9	+2.6	+4.3	+1.9	+3.3	+4.1	+14.6	+10.1	+11.4	+14.7	+12.9	+10.9
IX.....	+0.5	+3.5	+7.1	+1.8	+4.4	+9.0	+ 4.1	+14.5	+20.4	+14.6	+18.2	+25.6
X.....	+0.6	+1.4	-0.4	+ 3.8	+ 4.5	- 0.9
Average.....	+0.8	+2.1	+3.1	+0.7	+1.7	+3.1	+ 6.4	+ 8.6	+ 8.9	+ 7.0	+ 6.9	+ 8.8
12 hr. experiments:												
VI.....	³ +0.2	³ -0.13	³ +0.15	³ + 2.2	³ - 0.7	³ + 0.6
IX.....	³ +3.4	³ +3.4	³ +29.3	³ +14.2
Average.....	³ +1.8	³ +1.6	³ +15.7	³ + 6.7
Psychopathic subjects:												
XI.....	+1.2	+1.8	+2.2	+ 9.5	+ 7.3	+ 6.1
XII.....	-0.4	-1.2	-2.8	- 3.7	- 5.7	- 9.1
XIV.....	-0.4	-1.8	-2.3	- 3.0	- 6.7	- 5.8
Average.....	+0.1	-0.4	-1.0	+ 0.9	- 1.7	- 4.3

¹Effect on the average difference equals (av. 1-2, 1-3, 1-4, etc., alcohol) minus (av. 1-2, 1-3, 1-4, etc., normal).

²Effect on the percentile difference equals the effect of alcohol on the average difference divided by the average of the corresponding normals of the day.

³Dose C was given in the 12-hour experiments.

The net result of this phase of our experimentation is that the velocity of the eye-movements and the speed of reciprocal innervation of the finger are both regularly decreased by alcohol. As far as these processes are an indication of the adequacy of motor coördination, the effect of alcohol on motor coördination is depressive. The similarity of the average percentile effects of alcohol on the two processes, while the processes themselves represent very different neural centers, makes it probable that our experimental results indicate a widespread impairment of motor coördination as a result of moderate doses of alcohol.

CHAPTER VIII.

EFFECT OF ALCOHOL ON THE PULSE-RATE, DURING MENTAL AND PHYSICAL WORK EXPERIMENTS.

Reports of the effects of alcohol on the circulation are among the earliest and most common data on the physiology and pharmacology of alcohol. But, notwithstanding an enormous amount of experimental material, there is no commonly accepted generalization. The discrepancies and contradictions of the earlier investigations appear in the more recent. Alcohol has been found (1) to increase the pulse-rate, (2) to decrease it, (3) to do neither, and (4) to do both. Some illustrative observations are given on page 187.

Summaries which attempt to generalize at all concerning the effect of alcohol on pulse naturally reflect the experimental discrepancies. Thus Lauder Brunton¹ states that alcohol in moderate doses increases the pulse-rate. Horseley and Sturge² hold that alcohol decreases the pulse-rate. Notnagel and Rossbach,³ and Rosenfeld,⁴ state that it has no significant effect, while Cushny⁵ accepts the view that it both increases and decreases the pulse, according to circumstances, but has no effect on normal quiet subjects. Meyer and Gottlieb,⁶ while classifying alcohol among the heart-accelerating medicaments, appear to hold that its action has not been proved for normal human subjects. Indeed, the more recent general summaries show a conspicuous tendency to regard the effect of moderate doses of alcohol on the human pulse as more or less problematic. This uncertainty seems to be widely reflected in medical practice.

These discrepancies in the traditional data make it all the more necessary to reinvestigate the pulse-changes of human subjects after the ingestion of alcohol under the largest possible number of experimental conditions, with modern recording instruments, as proposed under the Nutrition Laboratory Plan. Such an investigation of the effects of alcohol on the circulation of man is outlined where it obviously belongs, in the physiological program. In its proper place

¹Brunton, *Therapeutics of the Circulation*, London, 1914, p. 178.

²Horseley and Sturge, *Alcohol and the Human Body*, London, 1907.

³Notnagel and Rossbach, *Handbuch der Arzneimittellehre*, Berlin and Vienna, 1894.

⁴Rosenfeld, *Der Einfluss des Alkohols auf den Organismus*, Wiesbaden, 1901.

⁵Cushny, *Pharmacology*, Philadelphia, 1910.

⁶Meyer and Gottlieb, *Die experimentelle Pharmacologie*, 3d ed., Berlin, 1914.

Alcohol was found to increase pulse-rate by:

- Parkes and Wallowicz,¹ 1870. Man; moderately large doses.
 Dogiel² (ref.).* First rise, then fall; no data cited.
 Fraser,³ 1880. Man; 75 c.c., 20 per cent. v. Jaksch,⁴ 1888. Children, 2 to 3 g.
 Binz,⁵ 1888. Dog; 5 c.c.; stomach.
 Swientochowski,⁶ 1902. Patients; 25 to 100 c.c.; 50 per cent.
 Mosso and Galeotti,⁷ 1903. Men; moderate.
 John,⁸ 1909. Men; moderate.

Alcohol was found to have no effect on pulse-rate by:

- Zimmerberg¹³ (ref.), 1869. Various animals 60 c.c.; Man, 40 per cent Al.
 Von der Mühl and Jaquet,¹⁴ 1891. Men, 30 to 100 c.c.
 Bock,¹⁵ 1898. Isolated rabbit heart, 255 c.c.; 10 per cent.
 Wendelstadt,¹⁶ 1899. Men, irregular, 5 to 100 c.c. (actually rose two-thirds cases).
 Rosenfeld,¹⁷ 1901. Dogs, 2 to 29 c.c. A. A.
 Kochmann,¹⁸ 1904-5. Man; moderate, 60 to 80 c.c., 20 per cent; 50 c.c., 30 per cent.
 Wood and Hoyt,¹⁹ 1905. Dogs; various, moderate, irregular.
 Bachem,²⁰ 1907. Rabbits; 0.2 to 1.0 c.c.
 Dixon,²¹ 1907. Man; moderate; dilute.
 Dennig *et al.*,²² 1909. Fever patients; 6 to 40 c.c.
 Woodhead,²³ 1911. Man; moderate.

Alcohol was found to decrease pulse-rate by:

- v. Jaksch,⁴ 1888. Children, 3.2 gr.; patients, 75 per cent of cases.
 Gutnikow,⁹ 1892. Dog; 100 to 250 gr.; 50 to 70 per cent.
 Hascovec,¹⁰ 1900-01. Dog; 5 c.c. A. A., 25 per cent intravenous; 20 c.c. A. A., 33 per cent; 100 c.c. A. A., 50 per cent. stomach.
 Backmann,¹¹ 1906. Isolated rabbit heart, 0.05 to 0.5 per cent.
 Di Cristina and Pentimalli,¹² 1910 (ref.). All doses.

Alcohol was found both to increase and decrease pulse-rate by:

- Maki²⁴ (ref.), 1884. Frog; small doses.
 Weissenfeld,²⁵ Self; 50 to 70 c.c. sherry; irregular.
 Loeb,²⁶ 1905. Frog and cat; inconstant.
 Dixon,²¹ 1907. Frog; first slow, then rapid.
 Brandini,²⁷ 1908. Rabbit and dog; depression moderate; isolated heart.
 Luzzato,²⁸ 1910-11. Men (ref.); 20 to 50 c.c. Al.; individual differences.
 Miller,²⁹ 1910. Animal; transfused; 0.13 to 0.3 per cent stimulated; over 0.3 per cent depressed.
 Downs,³⁰ 1911. Frog; external application to heart; 1 to 2 per cent increased at first; 5 per cent decreased.

*Original not available.

¹Parkes and Wallowicz, Proc. Royal Soc. of London, 1870, **18**, p. 362; Parkes, Proc. Royal Soc. of London, 1874, **22**, p. 172.

²Dogiel, Fourth Congress of Russian Naturalists in Kasan, reported in Archiv f. d. ges. Physiol., 1874, **8**, p. 604.

³Fraser, Alcohol, its function and place, Edinburgh, 1880. (Ref.)

⁴v. Jaksch, Verhdl. des Congresses für innere Medizin, Wiesbaden, 1888, **7**, p. 86.

⁵Binz, Verhdl. des Congresses für innere Medizin, Wiesbaden, 1888, **7**, p. 70.

⁶Swientochowski, Zeitschr. f. klin. Med., 1902, **46**, p. 284.

⁷Mosso and Galeotti, Lab. Sci. Int. du Mont Rosa, 1903. (Published 1904.)

⁸John, Zeitschr. f. exp. Path. u. Ther., 1909, **5**, p. 579.

⁹Gutnikow, Zeitschr. f. klin. Med., 1892, **21**, p. 168.

¹⁰Hascovec, Mitteilungen der böhmischen Akademie, 1900-01.

¹¹Backmann, Skand. Archiv f. Physiol., 1906, **18**, p. 323.

¹²Di Cristina and Pentimalli, Archiv di Fisiol., 1910, **8**, p. 131.

¹³Zimmerberg, Dissertation, Dorpat, 1869. (Ref.)

¹⁴Von der Mühl and Jaquet, Correspond.-Blatt f. schweizer Aerzte, 1891, **21**, p. 457.

¹⁵Bock, Archiv f. exp. Path. u. Pharm., 1898, **41**, p. 158.

¹⁶Wendelstadt, Archiv f. d. ges. Physiol., 1899, **76**, p. 223.

¹⁷Rosenfeld, Der Einfluss des Alkohols auf den Organismus, Wiesbaden, 1901.

¹⁸Kochmann, Archiv. internat. de Pharmacod. et Thérapie, 1904, **13**, p. 329; Deutsch. Med. Wchnsch., Leipsic, 1905, **31**, p. 942.

¹⁹Wood and Hoyt, Mem. Nat. Acad. Sciences (pub. 1905), 1911, **10**, p. 39.

²⁰Bachem, Zentralbl. f. innere Med., 1907, **28**, p. 849.

²¹Dixon, Journ. Physiol., 1907, **35**, p. 346.

²²Dennig *et al.*, Deutsch. Archiv f. klin. Med., 1909, **96**, p. 153.

²³Woodhead, Med. Press and Circ. London, N. S., 1911, **92**, p. 553.

²⁴Maki, Ueber den Einfluss des Camphers, Caffeins und Alkohols auf das Herz. Dissertation, Strassburg, 1884 (cit).

²⁵Weissenfeld, Archiv f. d. ges. Physiol., 1898, **71**, p. 60.

²⁶Loeb, Archiv f. exp. Path. u. Pharm., 1905, **52**, p. 459.

²⁷Brandini, Archiv. Ital. de Biol., 1908, **49**, p. 275.

²⁸Luzzato, Archiv. Ital. de Biol., 1910, **54**, p. 291.

²⁹Miller, Journ. Am. Med. Asso., 1910, **55**, p. 2034.

³⁰Downs, Month. Cycl. and M. Bull., 1911, **4**, p. 153.

it will not be an incident in any other investigation. With modern techniques it will make large demands on time and equipment. To have combined it with the investigation of neuro-muscular processes would have jeopardized both. The demands of the experimental procedure on both subject and experimenter would regularly conflict, since, while complete mental and bodily relaxation is a necessary condition for a pulse base-line, the purpose of the neuro-muscular experiment is to introduce stimuli to action.

Notwithstanding the fact that the main ends of this investigation precluded a systematic study of the pulse, adequate simultaneous pulse-records were believed to be important, both for the neuro-muscular investigation itself, and as a contribution to the systematic investigation of the human pulse. It has been a long-established custom of the Nutrition Laboratory to take pulse-rates during all experiments. There is an important theoretical value of regular pulse-records also in psychological experiments (Dodge.¹) When taken antecedent to the psychological experiment, the pulse is the best available indicator of the general physiological and psychical status of the subject. During the experimental process, pulse-change gives us the simplest means of estimating the general physiological changes, or metabolism, incident to the experiment. Moreover, it is clear that, while a systematic study of pulse must be based on the pulse of relaxation, no investigation of the effect of alcohol on the human pulse will be adequate which limits itself to relaxed subjects. Complete relaxation is an artifact of the laboratory. Theoretically, it is a limit. Practically, it is an ideal which the actual condition of the subject at any given moment may more or less closely approximate. Its main relation to actual conditions of normal or abnormal life is to furnish a theoretical base-line upon which actual conditions may be plotted, from which the deviation of actual conditions may be quantitatively expressed. While any systematic investigation of pulse under alcohol must be based on relaxed subjects, it must also include the effects of alcohol under experimental variations from relaxation. Such pulse-changes should be correlated as closely as possible with the records of actual accomplishment. It is obvious that pulse-records which are taken simultaneously with our neuro-muscular measurements meet these conditions for the particular experimental deviation from relaxation which they accompany. Our pulse-records, then, should constitute data not only for an interpretation of the neuro-muscular work, but also for a contribution to the systematic experimental study of the effect of alcohol on the autonomic system under experimental conditions. They should be regarded as a supplement to the future systematic investigation of pulse, as well as a connecting link between the latter and the present investigation.

¹Dodge, *Psychological Review*, 1913, 20, p. 1.

TECHNIQUES FOR RECORDING THE PULSE DURING PSYCHOLOGICAL EXPERIMENTS.

Three devices were used for obtaining the pulse-records during our experiments: (1) The temporal pulse was recorded by a skeleton telephone-receiver in series with the string galvanometer. (2) During the association experiments the radial pulse was recorded by means of a new electric sphygmograph which was devised to record on a distant kymograph. The electric relay was operated first by the Wiersma hand plethysmograph and later by a Tigerstedt bulb. (3) Except for the association experiments, all our later records were electrocardiograms from body leads through condensers.

TELEPHONE PULSE-RECORDER.

The telephone pulse-recorder was first described by Dodge.¹ In principle it consists of a skeleton telephone-receiver attached to the head, so that the diaphragm or armature rests on the temporal artery. Vibrations of the armature in the field of the small permanent magnet of the receiver set up minute electric currents in the surrounding high-resistance coils. These currents are recorded by the aid of the string galvanometer. Difficulties of adjustment and disturbances due to sudden movements of the head led to the substitution of the electrocardiogram for the pulse-recorder in all pulse-records which were taken subsequent to March 26, 1914.

CONSTRUCTION AND OPERATION OF AN ELECTRICAL SPHYGMOGRAPH FOR RECORDING PULSE-RATE AT A DISTANCE.

In connection with the experiments on association, it was regarded as desirable to have as complete records of physical condition as was practicable. Among other data it seemed desirable, for reasons that we have already mentioned, to take continuous pulse-records throughout the entire association experiments.

As the laboratory was equipped at the end of our year's work, it would have been relatively simple to provide for such continuous pulse-records by the use of the electro-cardiogram from body leads, our third method. When the association experiments were first commenced, however, we were not in a position to take photographic records of the pulse which were longer than 20 cm. Moreover, if the individual pulse-cycles were to be given sufficient length on the record to permit accurate reading, photographic records would be an expensive technique. It is doubtful if the advantage of the method would have warranted the additional expense.

Ordinary direct methods of sphygmography are available only when the subjects are situated in the immediate vicinity of the recording apparatus. In all psychological experiments such proximity to the

¹Dodge, *Psychological Review*, 1913, 20, p. 1.

apparatus is more or less perilous. In association experiments it is particularly inexpedient. It became necessary, therefore, to devise some form of pulse-recorder which would act at a distance, while still permitting definite correlation with the other data of the experiment. As our solution of the problem may be of general use, we shall give it in some detail. The conditions seemed to indicate a device by which the mechanical pulse-wave should break an electric contact, which would in turn activate an electric marker. That was the plan which we adopted. The Wiersma¹ hand sphygmograph gave remarkably large pulse-oscillations and seemed consequently admirably adapted to our purpose. Dr. Wiersma's plan was to bind the hands of the subject around a rubber capsule. Since the bandage was rigid, each pulsation forced the air out of the capsule to the recording tambour. Personal experience with such a binding showed that after 15 minutes it might become almost intolerable. But even if it were quite comfortable, it would obviously be something of an annoyance and a considerable waste of time to bind and unbind a subject's hand several times during the course of a 3-hour experiment. In view of these difficulties, we experimented to find some sort of a clamp which would slip on and off the subject without delaying the experiments.

With the help of Dr. Carl Tigerstedt, at that time Research Associate of the Nutrition Laboratory, we tried various devices of plaster of Paris and other plastic forms. But an even simpler device composed of reinforced felt cushions and a light "C" clamp proved equally satisfactory. As a transmitting capsule we used about 12 cm. of soft-rubber tubing about 2.5 cm. in diameter, which was closed at both ends with rubber stoppers and connected to a Marey tambour by rubber tubing. In use, this transmitting capsule was grasped firmly in the subject's left hand, which was then inserted in the clamp between the felt cushions, and relaxed. Pulse-waves of large amplitude may thus be transmitted to the tambour recorder. Some subjects regularly give much larger oscillations than others. With a recording lever of 10 cm., Dr. Tigerstedt gave curves with an amplitude of more than 2 cm.; 5 to 6 mm. is more common and is satisfactory. An amplitude of less than 4 mm. is sufficient only if the transmitting device is carefully adjusted.

The first device by which these pulse-waves operated to make and break the transmitting electric circuit was a platinum contact between the tambour lever and a horizontal rest which the lever just touched at the lowest point of each oscillation. But when the moving parts were sufficiently delicate so as not greatly to diminish the amplitude

¹Thanks to the kindness of Professor Wiersma, one of us was shown the working of his ingenious hand sphygmograph at Groningen. At the time of our going to press we are acquainted only with the brief description of this apparatus with accompanying curves given in the Program of the Communications and Demonstrations of the Ninth International Congress of Physiologists at Groningen, 1913.

of the pulse-curve by their mass, these contacts proved to be unsafe. Occasionally no proper contacts were made. Occasionally the platinum points stuck and failed to break. To avoid these difficulties we used a mercury cup from which each systole raised the end of a fine platinum wire that was attached to the end of the tambour lever. This lever, an aluminum arm about 10 cm. long, was counterbalanced by a bit of wax, so as to produce the greatest amplitude of movement.

When properly adjusted this apparatus functioned fairly well for normal subjects. Operated chiefly by the capillary pulse, however, it works for some subjects better than for others, and at some times better than at others. On the whole we found it an exacting instrument. In the first place, it must be carefully adjusted to each individual subject, and the optimum relative position of the clamp, hand, and transmitting capsule must be experimentally determined. In general we found it better to leave the thumb free, so that only the fingers and the palm of the hand were in contact with the capsule. The pressure of the clamp that is necessary to get satisfactory results also varies with the individual and his blood-pressure. The best conditions must be found by trial. In cold weather the hand must first be warmed to secure adequate capillary circulation. A third adjustment was the height of the mercury cup. Our experience leads us to say that the optimum height of the cup, when the systolic wave breaks the contact, is where the contact is just broken when the whole system is in equilibrium. If the device is so arranged that the systolic wave shall make the contact, the surface of the mercury should be about 2 mm. below the point of equilibrium. This latter arrangement has some practical advantages, but it is theoretically less satisfactory than the former on account of the normal fluctuation in the height of the systolic wave and the consequent differences in the relative position of the moment of contact. In the final form of this device we used only one mercury cup, carrying the current through the axis of the recorder. We tried using two mercury cups, connecting them with a transverse platinum wire at the end of the recorder. That proved to be inexpedient because of the relatively large, though intrinsically small, surface-tension between the mercury and the platinum wire. Even with one cup, if the mercury is a little too high, the surface tension is sufficient to keep the platinum wire in contact, with consequent failure to record the pulse. A fourth adjustment was necessary in order to avoid the plethysmographic effects, by which the pointer either rises above the mercury with increasing volume of the hand and fails to return to its surface in the diastolic phase of the pulse-wave, or the pointer sinks below the level of the mercury with decreasing volume of the hand and fails to rise above its surface in systole. To avoid these plethysmographic changes we introduced two systematic leaks, as follows: (1) the tambour membrane was pricked by a pin point so as not to be

absolutely tight; (2) in addition we used a spring clamp, operated from the floor below by a cord, to open and to close a T tube which connected the system with the free air. Since this opening was large, an immediate restitution of the equilibrium could be obtained whenever the recorder showed plethysmograph effects. If reasonable care was used in these various adjustments, the device proved usable.

But recurring plethysmographic effects finally led us to abandon this application of the Wiersma instrument. On the advice of Dr. Carl Tigerstedt we substituted in its place a soft-rubber bulb, strapped as flat as possible over the radial artery. The device was first used in Helsingfors by Professor Robert Tigerstedt;¹ but, as far as we can learn, it has never been published in accessible form. The Tigerstedt method properly requires a flat, pear-shaped bulb, but no such bulb could be found commercially in this country. Round bulbs tend to become concave when flattened against the wrist, making the areas of contact uncertain in size and position. To overcome this difficulty, we used the device of folding a round bulb on itself. In effect, this makes a double flat bulb with a dead space where the fold is open to the air; but if the soft bulb is pressed almost flat against the wrist by a suitable bandage, the effect of this dead space is practically eliminated. The resulting movements of the marker proved to be ample in all cases, and not seriously affected either by the plethysmographic changes or by cold. For rapid attachment of the bulb to the wrist, we used an athlete's leather wristband. In this final form the device gave positive results, and caused relatively little trouble.

The pulse-curve was correlated with the giving of the stimulus, as well as with the reaction of the subject, by means of a stimulus and reaction curve, which was superposed on the pulse-record. The arrangement for securing such correlation was as follows: We used a screw-fed Blix-Sandström kymograph, running at the rate of 50 mm. per second, a Dodge duplex recorder, and the electrical sphygmograph as above described. By means of an offset on the shaft, the kymograph broke an electric current with every revolution, *i. e.*, every 10". That break operated a signal-lamp on the desk of the experimenter in the balcony. When the signal-lamp went out, the experimenter gave the stimulus word and at the same time pressed a key through which the current passed to one side of the duplex recorder. This gave a stimulus signal superposed on the continuous sphygmographic record. Immediately, when the subject reacted, the operator released the key and thus broke the reaction-curve circuit, and registered the reaction on the same continuous line with an error equal to his personal equation. The words were given in groups of 5, so that the properly lettered and numbered kymographic records can be immediately correlated with the corresponding reaction experiments. Between each group of 5, a blank

¹Tigerstedt, *Hygiea Festband*, 1908.

line was run on the kymograph, in which there were neither sphygmographic records nor reaction records. Each group of 50 reaction experiments was interrupted in the middle for readjusting the drum. The full length of the drum just sufficed to give 50 reaction lines, plus the blank lines and a few accidental blanks that occurred in the course of the series.

The reading of these records was a painstaking and a time-consuming process, but presented no special difficulties. A small probable error is involved in each pulse-cycle record. It depends on the fact that the pointer will leave the mercury at some point of the systolic rise. It may be near the beginning or it may be near the end. However, since the duration of the systolic rise is relatively short (about $0.08''$), and since extreme positions give no break, the probable error of any one record will not be over $0.02''$. In an evenly running series it is much less. On account of this error it seemed inexpedient to read the curves closer than $0.01''$. For most purposes of correlation this is close enough.

The records are often complicated by movements of the recorder incident to the dicrotic and the post-dicrotic waves, which may give two or three breaks for each pulse-wave. These breaks, however, are usually of regularly decreasing lengths, and seldom interfere with the reading of the record. Gross body-movements, however, produce serious disturbances in the curve, which render a record illegible as long as they persist. Such irregularities are not without their advantage, since they indicate the presence of body-movements and prevent a misinterpretation of physically conditioned pulse-changes.

ELECTRO-CARDIOGRAMS FROM BODY LEADS THROUGH CONDENSERS.

The arrangement is as follows: Instead of taking electro-cardiograms from any of the well-known Einthoven or Waller leads, which require a relatively complete relaxation of the subject and prevent any other use of the limbs, the method we employed attaches the electrodes to the body, on either side, directly under the armpit. For registration of the duration of the pulse, this device has certain advantages over all other forms of recorders: (1) In general, the electro-cardiogram has ideal configuration for accurate measurements. The shape of the curves is relatively constant, and the sharp first systolic spike (Einthoven's *R* spike) is peculiarly clear-cut. (2) Use of the body leads gives electro-cardiograms which can not be used diagnostically because of the uncertainty of the position and contact of the electrodes. On the other hand, they leave the limbs free for any sort of concurrent activity. (3) Situated directly over relatively small trunk-muscles, even violent activity need not interfere with the records. This is a unique advantage of the body leads. As elaborated in the Nutrition Laboratory by the assistance of Professor H. M. Smith and Mr. K. H. Brown, the device gave excellent records of the pulse of a man walking on a treadmill for hours at a time.

For satisfactory operation the following precautions and adjustments are necessary: (1) The galvanometer must be connected in series with from 6 to 12 condensers of 2 microfarads each. These serve to eliminate or enormously reduce body-currents and polarization phenomena. (2) The electrodes should be light, flexible, moist, and evenly pressed against the skin by some elastic device that takes up respiration-movements. We found it satisfactory to cover the surface of thin metal plates, about 10 cm. in diameter, with blotting-paper which was saturated with normal salt solution. These electrodes were mounted on a cork and inserted under the clothing. They could be held in place by a thumb-tack, pressed through the clothing and into the cork. A wide elastic band around the body, over the electrodes, kept the contact sufficiently constant when the band was just tight enough to stay in place.

EFFECT OF ALCOHOL ON THE PULSE-RATE DURING ASSOCIATION EXPERIMENTS.

The pulse-records during the association experiments were made by the electric recording device as described above in method II. They appeared in the kymograph record on a continuous spiral base-line which represented a total experimental period of about 12 minutes. Since the cylinder of the kymograph had a peripheral velocity of 50 mm. per second, each pulse-cycle was from 30 to 60 mm. long on the record, and was read with an average error of 0.005." Each 12-minute record represents an association series of 50 words. The actual duration of each series was usually longer than 12 minutes. There was always a delay of several seconds after the first 25 records to readjust the drum. Occasional delays occurred for taking additional data by Wells and for instrumental adjustments. During these delays the forward progression of the drum was stopped and the spiral record was thus temporarily modified to a circle. Six sets of these records were made in the course of a 3-hour experimental session. The general arrangement of the association experiment, as well as the relative position of subject and experimenter, may be seen from figure 21, opposite page 101. On the table, at the subject's left hand, this figure also shows the electric pulse-transmitter, which was connected with the Tigerstedt bulb on the wrist of the subject. A similar transmitter, shown on the stand at the right, was used for respiration-waves.

A part of a typical kymographic record of the association experiments is shown in figure 30. The entire detached record-sheet would be 50 cm. long and contain 1 line for each of the 50 associations which constituted an experimental series. For reproduction we have chosen that section of the record which shows the reaction-time of the association experiments. If one reads the record from left to right, the small, rhythmically recurring plateaus on each line are pulse-records.

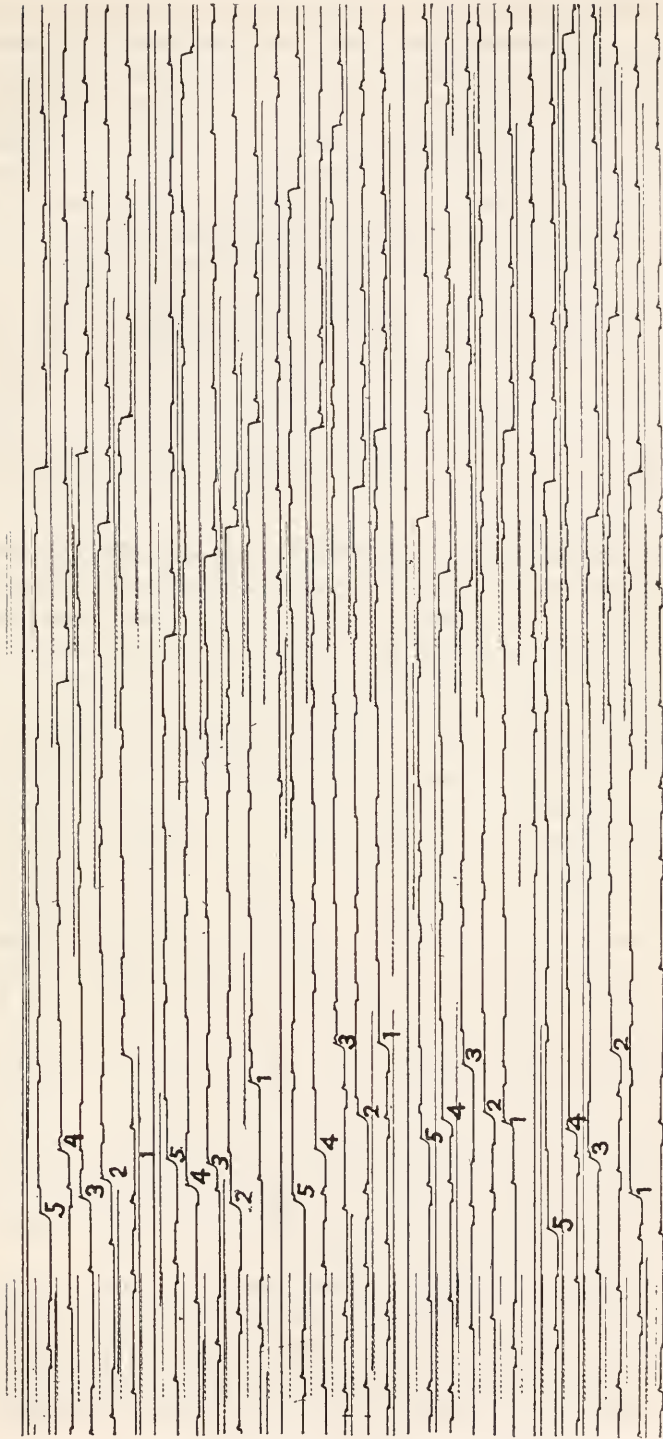

FIG. 30.—Part of an association experiment record.

The first rise in each group of these plateaus corresponds with the systolic wave. The subsequent rises correspond with the diastolic and (occasionally) the post-diastolic waves. The highest plateau on the line, about 3 cm. from the left of the record, indicates the duration of the reaction. The left-hand beginning of this plateau indicates the moment at which the experimenter simultaneously pressed a signal-key and spoke the stimulus word. The end of the plateau shows the moment at which he released the signal-key as the subject reacted. Faint dots in rows about 3 cm. long, one row above the other, constitute a time-record from the pendulum of an accurately running clock. They are 2" apart, and serve to control the kymograph rather than as a basis of measurement. The kymograph is regarded as running satisfactorily if the variation would not affect any unit of measurement. The broken straight lines which appear between the pulse-curves are respiration records. They were transmitted by the same sort of transmitting device that was used for the pulse. Contact of the marker with the records occurred during inspiration.

The complete association-pulse data of one experimental period for one subject (Subject VII), together with his association reactions, are given in table 34. It seemed desirable to give the complete data of one period for some subject to show the actual variations in the pulse, and to illustrate the process of elaboration. The data for Subject VII were chosen because his experimental pulse-changes were the largest of the regular group of subjects. The extreme left-hand column in table 34 shows the groups in which the words were given. The second column contains the reaction-time of each of the 50 associations of one period. The other three columns contain the duration of each pulse-cycle in the corresponding association experiment, arranged according to its place in the pre-stimulation, stimulus to reaction, and post-reaction phase of each experiment. Since the association experiments began at a similar part of each corresponding complete revolution of the kymograph drum, each line of the pulse-record, after it is detached from the drum, is naturally divided into these three periods, of which the most important determinants are the moment of stimulation and the moment of reaction. Pulse-cycles which preceded the movement of stimulation are entered in the "Pre-stimulation" column. Pulse-cycles which lay chiefly between the moment of stimulation and the moment of reaction are entered in the "Stimulus to reaction" column, while those pulse-cycles which occurred immediately after the reaction are entered in the "Post-reaction" column.

The dividing-line between the post-reaction pulse-cycles of one association and the pre-reaction pulse-cycles of the next association is quite arbitrary. Obviously there is no experimental break between them. An apparent break is produced when the record is cut to be removed from the drum. While this break is really artificial, it occurs

TABLE 34.—Association pulse data—Subject VII. (Dec. 10, 1913, Series II, 4^h 50^m p. m.)

[Time units are hundredths of a second.]

Group number.	Reaction time.	Pre-stimulation pulse-cycles.						Stimulus to reaction-cycles.			Post-reaction pulse-cycles.							
1	145	76	72	70	70	70	74	74		73	74	75	75	74	72			
2	182	74	74	70	64	66	64	64	64	63	64	64	68	70	78	76		
3	194	73	76	74	74	73	68	65	60	64	62	62	68	76	79			
4	184	77	78	78	80	80	76	72	68	64	62	69	82	90				
5	156	84	86	87	86	85	80	77	73	70	64	70	73					
1	166	77	78	77	78	76	75	74	71	69	67	70	72	77				
2	214	73	77	77	78	79	75	74	74	70	64	66	69	77	84			
3	180	85	82	80	80	78	77	73	72	69	69	71	75	78				
4	254	78	77	79	79	78	76	71	70	68	64	68	64	83				
5	162	84	82	82	79	80	77	73	72	71	71	71	73	75				
1	164	71	73	72	74	72	75	71		74	72	69	69	67				
2	186	66	69	72	76	75	76	74	69	67	66	67	64	63				
3	226	64	66	68	70	75	70	69	66	64	65	68	69	76				
4	239	82	83	84	82	79	78	74	71	64	62	67	75					
5	240	84	85	85	84	82	79	78	73	71	66	66	68	74				
1	282	73	76	78	78	73	77	78	77	72	68	68	69	72				
2	238	74	71	70	73	75	78	78	76	72	68	63	64	69				
3	182	79	82	82	80	84	83	80	80	75	75	68	70	70	67	70		
4	182	68	69	64	68	69	67	65	65	62	65	66	68	72	76			
5	320	75	74	78	78	78	78	76	73	68	64	64	67	74				
1	326	77	77	75	79	78	80	77	73	70	64	63	67	65				
2	282	86	90	88	88	84	83	79	75	72	69	66	68	74				
3	158	82	82	82	82	81	80	75	72	70	70	68	64	73	86	88		
4	208	92	90	89	88	88	84	81	75	72	68	69	77	82				
5	184	86	86	87	86	86	85	77	74	70	70	70	73					
1	338	64	64	66	67	72	78	81	74	70	69	68	69	74	76			
2	180	76	76	75	74	74	73	73	70	70	66	68	77	88				
3	286	89	89	87	86	84	83	75	72	70	67	68	74	78				
4	393	83	82	81	79	80	79	78	74	72	72	70	69	72	76			
5	274	78	80	82	78	78	77	74	72	70	64	66	72	79				
1	210	78	78	78	80	79	75	63			(?)	(?)	(?)	(?)				
2	212	84	84	84	84	84	84	79	76	73	73	73	74	76				
3	317	78	78	79	80	82	80	80	76	74	68	62	64	64				
4	200	78	82	84	84	84	82	82	76	73	69	67	72	79				
5	179	81	81	79	78	78	79	73	72	67	64	72	67	64				
1	168	78	78	78	78	78	78	76	76	74	71	72	67	70	62	68	69	73
2	232	77	76	72	72	73	73	73	73	65	71	66	64	64	70			
3	211	85	88	86	83	81	81	74	74	72	71	74	78	81				
4	256	83	82	82	80	78	78	78	73	72	68	64	66	69	74			
5	169	80	81	79	78	77	78	74	71	67	66	70	72	77				
1	206	72	72	71	70	69	70	74	71	68	67	67	70	66	65			
2	385	68	68	70	69	70	70	74	75	70	65	64	64	70				
3	318	82	83	83	81	77	75	74	68	69	66	66	69	70				
4	252	73	74	72	71	69	63	65	87	61	58	60	59	58	61	67		
5	218	86	90	91	90	90	90	84	80	75	72	75	80					
6	214	91	90	88	88	88	86	80	76	72	68	79						
1	228	82	78	77	78	77	78	177		74	74	78	79	83	83			
2	254	84	82	80	79	78	77	78	75	76	70	70	73	80				
3	212	85	86	86	84	82	80	78	74	72	68	69	76	82				
4	172	88	88	90	88	88	86	85	79	78	76	76	77					
Av.	225	78.4	79.3	79.16	78.76	78.8	77.4	74.4		68.4	67.4	69.6	73.0					

¹Average of two.

²No record.

at approximately the same point in all records, and consequently permits comparison of approximately the same number of pre-stimulation pulses. The main purpose of the present statistical arrangement of the data is to isolate the post-stimulation pulse-change. On this account, the arbitrary break between the post-reaction pulse of one experiment and the pre-stimulation pulse of the next is without significance. Since all the pulse-waves were read, the data are capable of any other arrangement that statistical interests might demand.

The theory of the statistical elaboration of the pulse data by which we hoped to realize the correlation between the different phases of the experimental process and the pulse-rate probably needs some explanation. An examination of the duration of successive pulse-cycles, as given in table 34, will show that, except by accident, no two successive pulse-cycles take equal times. This corresponds with the well-known physiological laws of the extreme susceptibility of the pulse to waves of nervous excitement. The pulse of relaxed subjects is accelerated by the slightest physical or mental activity. Even without conscious activity, as, for instance, in sleep, it is yet complicated by a considerable group of rhythmic and arrhythmic physiological processes. In normal life there are short rhythms, corresponding to respiration and the Traube-Hering waves. There are longer rhythms corresponding to the ingestion and digestion of food, to work and relaxation, to the sequence of day and night, etc. A constant base-line with clear-cut experimental deviations does not exist in practice. Experimental deviations from the normal, if they occur at all, will be superposed on a complex of the rhythmic and the arrhythmic changes to which the pulse is normally liable. The obvious problem in any statistical treatment of the pulse data for experimental purposes is to disentangle the significant experimental changes from the various rhythms.

Even the most common use of pulse data is not free from the necessity for similar statistical treatment. In the so-called pulse-rate one may not regard as significant the measure of any individual pulse-cycle. However accurate such a measurement might be, it would be meaningless unless it were known in what phase of the various rhythms it occurred. At once a simple and more accurate measure of the pulse-rate is to average such a large number of pulsations that it is safe to assume that the lesser rhythms have run their course a number of times. Under such precautions, the "pulse-rate" of relaxed subjects will be relatively constant, not because the pulse-cycles do not vary, but because their variations in successive periods tend to counterbalance each other. Just how long a period is necessary for such measurements is not a matter of universal agreement. Common practice finds 60'' a convenient and satisfactory unit. In using such a unit, one assumes that in 60 successive pulse-cycles (if 60 happens to be the pulse-rate) the various lesser rhythms have become statistically eliminated by counterbalancing one another.

Our attempt to measure the effect of the association experiment on the pulse-rate rests on a similar theoretical basis. If the pulse data are arranged according to their experimental incidence it may be assumed in this case, as in the case of the pulse-rate, that in a sufficient number of instances the non-experimental rhythms and the accidental variations will tend to balance and leave only the significant experimental change. In other words, in the case of the pulse, as in our general statistical procedure, we postulate that chance variations can not obscure any systematic change in the measurement of a process if the number of cases be sufficiently large. In the measurement of the pulse-cycles during association, the non-experimental rhythms are treated as chance variations. Significant variations would be such as correlate with the reaction process. A comparison of the average of all the pulse-cycles which occur just after the moment of stimulation and the average of all the pulse-cycles which occur just before that moment should give the pulse correlate of the effect of stimulation. While this theory of pulse elaboration is believed to be sound, it may well be questioned if 50 cases are sufficient for the non-experimental rhythms to be eliminated. Our only answer to that objection is that we have no means of knowing. Fifty cases is, however, the best available unit in our experiments, and it is not seriously different from a widely used physiological standard, viz, of pulse-rate per minute.

The experimental pulse-changes in association tests for Subject VII, elaborated according to the foregoing theory, are summarized in table 35. The first column shows the kind of experiment and the number of the word series. The average values of the pulse cycles are entered in the appropriate columns under pre-stimulation pulse-cycles, stimulation to reaction, and post-stimulation pulse-cycles, corresponding to the arrangement of table 34. Thus the right-hand column under pre-stimulation pulse-cycles shows the average duration of the pulse-cycles just before the stimulus words were given for each period of the four experimental days. An average pulse-rate for each experimental period is shown in the extreme right-hand column.

An examination of table 35 shows that in each normal experimental session the average length of the pulse-cycles increases from period to period. What is true of the average is true also at each stage of the experimental cycle, say at the first post-reaction pulse. The same phenomenon appears also on the second normal day. It is less conspicuous after dose A of alcohol, and is often reversed after dose B. That is to say, in Subject VII alcohol tends to prevent the retardation of the pulse which occurs in a "normal" 3-hour experimental session. A second clear indication of table 35 is that there is a conspicuous difference in the course of pulse-changes from pre-stimulation to post-reaction between the normals of the day, 1, 6, 11, 16, and subsequent periods of the same day.

These changes appear more obviously in the curves of figure 31, which were plotted from table 35.

In addition to the phenomena already mentioned, figure 31 brings out several correlations between the course of the experimental process and the pulse. The pulse-changes in the successive periods of the first normal day seem to indicate a gradual process of adaptation to the experiment. In the first period of the first normal day there is a marked pre-stimulation decrease in the length of the pulse-cycles. This pre-stimulation effect clearly diminishes during the session, though the last

TABLE 35.—*Summary of the association pulse data of Subject VII.*

[Length of pulse-cycles given in hundredths of a second.]

Kind of experiment and number of association series.	Pre-stimulation pulse-cycles.	Stimulation to reaction.	Post-reaction pulse-cycles.	Average.
Normal I:				
1.....	74.8 77.0 75.3 75.7 74.9	73.2 70.9	65.8 64.9 67.0 70.0	71.8
2.....	78.4 79.3 79.1 78.7 78.8	77.4 74.4	68.4 67.4 69.6 73.0	75.0
3.....	78.9 79.7 79.5 79.4 79.1	78.0 75.7	72.3 72.0 72.5 75.4	76.6
¹ A.....	83.9 85.2 85.0 88.3 85.9	81.4 81.9	78.8 79.0 80.8	83.0
4.....	87.2 87.1 86.0 84.7	88.5 81.5	79.0 81.0 83.6	84.3
5.....	88.4 87.4 87.1 87.4 87.2	87.0 82.0	81.1 81.6 80.8	85.0
Alcohol (dose A):				
² 6.....	78.8 79.2 79.3 78.5 76.8	75.9 74.0	70.0 71.0 73.0 75.0	75.6
7.....	82.0 83.9 83.7 83.6 81.9	80.9 78.6	72.4 71.9 74.4	79.3
8.....	78.2 79.0 79.0 79.2 78.1	78.1 76.8	72.9 72.8 74.9	76.9
¹ B.....	84.5 85.3 85.4 85.3 85.5	84.5 83.3	80.6 81.4 82.0	83.8
9.....	82.6 82.6 83.5 84.0 83.9	83.0 81.6	78.7 79.2 81.4	82.0
10.....	82.6 83.0 83.5 83.6 83.6	82.8 81.9	81.2 79.9 80.1	82.2
Alcohol (dose B):				
² 11.....	74.4 76.0 76.0 74.6 74.2	75.4 73.1	68.9 68.6 69.9 70.9	72.9
12.....	72.5 71.3 71.6 72.0 73.1	72.9 71.2	68.1 68.2 68.5 69.9	70.8
13.....	68.4 68.8 69.4 69.4 70.6	69.8 70.2	68.8 68.5 68.8 68.6	69.2
¹ A.....	73.3 73.1 72.9 73.7 74.4	73.9 73.1	72.8 72.5 72.7 71.6	73.1
14.....	74.3 74.5 74.8 75.2 75.6	76.0 74.6	74.0 73.2 72.9 72.0	74.3
15.....	70.6 69.6 70.9 69.9 70.8	70.8 69.4	70.5 72.0 70.8 68.5	70.4
Normal II:				
16.....	77.7 79.0 78.4 78.6 79.8	79.0 74.6	72.5 72.6 73.2 72.6	76.2
¹ A.....	80.4 81.5 81.4 82.7 83.7	83.3 79.3	79.3 79.3 78.0	80.9
17.....	82.4 83.3 83.6 83.7 84.3	84.4 81.6	81.8 82.8 82.0	83.0
¹ B.....	86.8 86.3 86.3 86.6 87.3	87.9 85.5	85.7 86.2 85.5	86.4
1.....	89.0 89.7 89.5 90.5	91.0 88.1	87.0 87.7 87.1	88.8
18.....	89.3 91.3 91.6 91.4	91.7 87.9	84.9 85.6 85.8	88.8

¹Kent-Rosanoff series; see p. 120.

²Series 6 and 11 are normals of the day and were taken before the alcohol dose was given.

three periods are too irregular for generalization. Similarly, in the succeeding days, the pulse of the first period (the normal of the day) shows increasing adaptation as the subject gets more and more familiar with the experiment. That is, the normal of the day pulse has slightly less pre-stimulation drop on the second day than on the first. On the third day it shows no pre-stimulation drop, while on the fourth day the greatest relaxation occurs just before the stimulus is given. That this is not an accident is obvious in the configuration of the curves for

Subject VII
 Average duration of pulse cycles in different phases of the association experiment

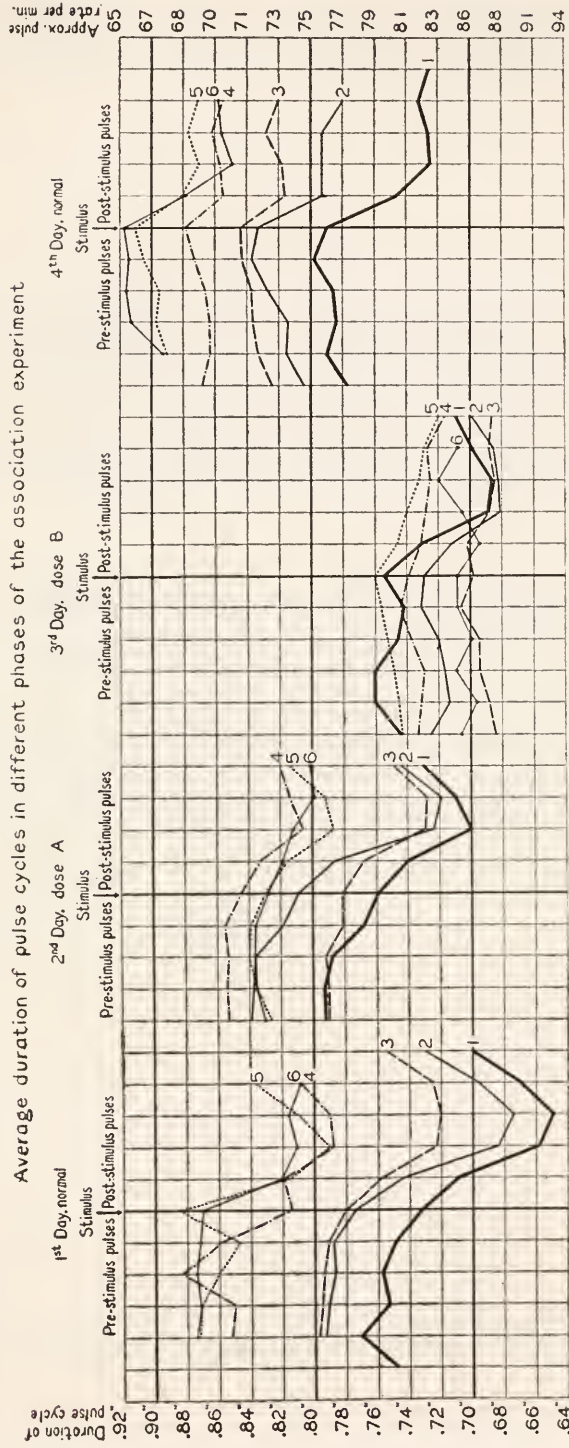

FIG. 31.—Association pulse of Subject VII.

TABLE 36.—*Summary of the pulse data of association experiments.*
 [Length of pulse-cycles given in hundredths of a second.]

Kind of experiment and number of association series.	Pre-stimulation pulse-cycles.	Stimulation to reaction.	Post-reaction pulse-cycles.	Average
<i>Subject II.</i>				
Normal I:				
1.	104.3 102.8 101.4	101.9 100.9	97.6 103.1 100.5 96.4	101.0
2.	105.5 104.9 104.4	104.8 103.8	102.5 104.9 102.2	104.0
3.	106.8 107.3 107.1	106.4 102.6	103.8 105.4 108.6 100.4	105.5
A.	110.0 110.9 109.9	108.8 104.0	112.2 106.6 105.2	108.4
4.	108.1 108.7 108.6	108.5 105.0	108.0 114.6 104.5	108.2
26.	104.5 101.0 101.9	105.9 99.1	103.2 107.1 103.2 96.6	102.5
7.	100.0 100.1 99.2	97.5 97.9	103.6 104.7 99.5	99.9
8.	99.8 101.2 101.7	101.5 96.9	101.9 103.9 91.1	99.7
B.	104.1 101.2 105.0	105.8 105.8	105.5 107.9 107.2	105.3
9.	103.0 102.5 100.5	100.4 98.4	103.4 104.9 100.7	101.7
10.	103.5 100.2 100.7	102.5 102.4	106.0 101.2 99.1	101.8
Alcohol (dose B):				
211.	103.9 106.7 105.6 103.4	108.3 101.9	106.4 107.6	105.5
12.	101.8 102.5 102.6 103.2 102.8	104.2 101.3	104.1 103.5	103.0
13.	102.4 100.4 100.9 101.5 102.1	108.0 100.5	105.5 104.6	102.3
A.	102.3 104.0 103.5 102.4	102.7 101.3	103.7 103.7 101.7	102.8
14.	104.2 103.1 104.2 107.1 107.0	105.3 103.4	107.4 107.8	105.5
15.	107.6 109.8 111.6 110.2	110.5 107.7	107.9 107.2	109.1
Normal II:				
16.	98.6 97.9 97.2	97.8 95.6	97.7 99.2 96.9	97.6
A.	103.7 104.1 102.9	104.3 101.3	102.8 103.0 101.0	102.7
17.	102.7 102.8 103.7	102.9 101.6	105.2 105.8 102.5	103.4
B.	107.9 108.7 107.5	106.9 108.2	108.8 108.3 106.2	107.8
1.	106.3 106.8 105.2	105.0 103.5	106.6 108.4 106.6	106.0
18.	111.0 111.6 110.9	110.9 109.0	112.0 114.0 110.2	109.9
<i>Subject III.</i>				
Normal I:				
1.	67.0 70.0	67.4 65.5	65.1 69.2	67.4
2.	76.0 75.0	74.2 70.0	75.4 77.8	74.7
3.	76.5 76.4 73.9	77.8 73.5	75.4 73.1 70.8	75.3
A.	83.0 80.4 82.6 83.5	82.8 78.3	81.5 82.1 81.6	81.8
4.	83.2 83.8 84.9	85.1 80.6	84.3 82.8 81.3	83.0
5.	87.8 87.1 89.6	87.9 83.4	87.0 85.8 86.5	87.0
18.	86.7 86.5 89.2	89.2 84.9	88.3 88.9 84.0	87.2

Alcohol (dose A):												
26.	70.9	70.2	69.8	70.4	70.8	68.5	69.5	70.9	72.2	70.3	70.3	70.9
7.	71.3	71.9	72.5	74.3	72.7	70.8	73.5	72.9	71.9	70.3	70.7	72.1
8.	80.6	80.0	79.0	81.7	81.5	79.2	82.4	80.4	80.1	80.3
B	81.2	79.6	81.2	83.6	83.4	79.8	81.3	80.6	77.7	75.2	77.3	80.2
9.	79.8	76.2	77.8	79.4	78.4	76.9	80.3	78.4	74.8	71.0	74.6	77.0
10.	83.2	82.6	79.9	83.3	84.5	80.8	83.2	82.9	78.9	75.8	78.5	81.2
Alcohol (dose B):												
211.	83.3	82.2	82.5	83.0	82.5	78.5	82.0	83.5	84.4	82.3
12.	83.2	83.6	83.8	85.4	84.8	83.4	87.2	87.1	84.8
13.	86.6	85.2	86.0	87.6	86.8	86.4	90.5	90.3	87.5
A.	89.2	89.6	86.2	90.1	90.7	86.5	90.2	90.9	88.8
14.	91.2	90.3	88.8	89.9	92.1	89.5	92.7	93.8	91.0
15.	88.4	89.2	87.6	85.8	90.4	87.3	90.7	91.0	88.9
Normal II:												
16.	75.0	76.0	77.0	74.0	71.0	71.0	75.0	75.0	74.2
A.	77.6	75.5	75.9	77.1	79.2	76.1	79.0	77.0	76.4	72.6	74.1	76.2
17.	81.7	81.5	81.2	83.3	85.3	81.6	83.5	81.7	79.8	82.2
B	81.1	80.1	79.4	80.8	81.5	79.9	82.9	80.4	78.1	75.3	79.9
1.	84.7	83.8	83.2	84.8	86.5	85.3	89.4	85.8	85.4
18.	83.5	82.4	81.1	82.3	84.0	81.5	84.9	82.9	80.5	77.9	82.1
Subject IV.												
Normal I:												
1.	76.9	77.9	76.9	76.7	76.3	76.2	73.8	74.8	76.2
2.	90.8	90.0	88.8	89.7	89.4	85.9	84.5	85.3	88.0
3.	95.8	92.2	93.3	95.0	92.3	91.5	91.6	93.1
A.	91.4	94.8	97.7	96.9	95.0	95.0	95.6	91.8	94.7
35.	98.4	98.6	103.8	102.9	99.5	96.4	98.3	94.8	99.1
Alcohol (dose A):												
26.	79.1	77.7	77.0	77.5	76.7	75.2	75.5	76.5	75.5	75.0	76.6
7.	84.2	84.5	85.3	87.0	87.0	85.1	87.1	87.6	83.4	85.7
8.	93.4	92.2	92.3	93.4	93.3	93.5	90.7	92.4	86.8	92.0
B	96.0	92.0	91.0	95.5	94.7	94.1	92.3	95.6	91.5	91.4	93.2
410.	98.4	97.5	99.4	97.4	98.7	99.2	99.1	90.6	97.5
Alcohol (dose B):												
211.	81.9	82.4	81.7	81.1	81.9	81.4	81.2	81.8	80.1	81.5
12.	84.4	85.3	85.4	86.4	86.3	87.2	86.7	87.6	83.6	85.9
13.	87.7	89.1	88.4	88.0	90.3	90.9	92.5	91.6	88.1	89.6
A.	93.0	93.5	92.1	91.4	94.6	95.0	94.5	95.1	91.3	93.4
14.	99.1	101.9	102.6	101.9	104.4	106.4	105.3	104.6	103.3
15.	102.9	101.9	101.0	103.1	103.6	105.7	105.0	98.7	102.7

¹Records for series 5 too irregular to average.

²Series 6 and 11 are normals of the day and were taken before the alcohol was given.

³No records for series 4.

⁴No records for series 9.

TABLE 36.—*Summary of the pulse data of association experiments—Continued.*
 [Length of pulse-cycles given in hundredths of a second.]

Kind of experiment and number of association series.	Pre-stimulation pulse-cycles.	Stimulation to reaction.	Post-reaction pulse-cycles.	Average.
<i>Subject IV—continued.</i>				
Normal II:				
16.....	88.2 87.2 87.6 88.3	86.9 86.5	86.6 86.4 83.9 84.6	86.6
A.....	83.8 83.2 83.7 85.2	85.8 85.8	87.1 86.5 85.5 83.2	85.0
17.....	99.1 98.5 98.7 100.8	99.4 99.0	100.4 100.7 96.7	99.3
B.....	101.3 100.3 103.6	102.7 102.2	102.1 102.6 98.6 97.9	101.3
1.....	101.4 101.9 100.8 101.0	102.7 103.4	102.3 101.8	101.9
18.....	101.2 103.7 103.5 105.1	106.4 105.1	104.7 104.0 98.4	102.6
<i>Subject VI.</i>				
Normal I:				
1.....	77.2 79.2 78.6 77.9	76.2 72.2	65.3 67.1 66.8	73.4
2.....	90.0 89.8 88.6 88.4	88.0 78.9	75.6 78.4 80.6	84.3
3.....	89.4 89.2 89.4 88.7	88.7 81.8	75.3 78.9 81.9	84.8
A.....	94.9 96.1 96.6 94.3	93.9 84.9	86.9 86.2 84.4	90.9
4.....	99.8 98.3 100.2 99.2	97.3 90.3	87.4 91.9 92.2	95.2
5.....	94.4 93.1 96.4 95.7	95.9 86.0	81.2 88.0 87.1	90.9
Alcohol (dose A):				
16.....	78.5 84.6 79.0	82.0 76.4	70.8 70.9 69.9	74.5
17.....	86.1 87.0 87.6 87.3	87.6 82.0	77.8 79.8 79.0	83.0
Alcohol (dose B):				
11.....	71.6 72.2 73.1 71.6 71.3	72.3 69.5	66.4 66.8 67.5	70.2
12.....	81.3 81.6 81.5 80.9 80.3	79.7 76.2	72.3 73.0 82.8 75.5	78.6
13.....	81.7 81.5 82.7 82.8 82.0	82.4 78.2	74.5 75.3 76.3 74.4	79.3
A.....	93.2 94.5 93.7 94.5 94.0	92.8 85.9	87.1 85.3 87.7	90.5
14.....	96.7 101.2 100.1 100.5 102.0	99.3 91.2	89.1 92.4 94.3	96.6
15.....	94.0 96.4 95.5 96.6 98.4	96.9 89.5	88.3 90.6 91.4	93.8
Normal II:				
16.....	61.1 60.9 61.1 61.1 61.1	61.1 60.1 58.5	58.3 57.7 60.0 59.8 59.1 59.2 61.0	60.0
A.....	77.9 77.6 77.8 78.2 76.7	75.8 72.6	68.9 69.0 71.1 70.3 71.0	73.9
17.....	75.0 76.4 76.8 77.0 76.7	75.9 73.0	69.8 70.5 72.5 72.6 72.7 75.2	74.2
B.....	80.6 80.6 80.3 80.1 80.4	79.7 77.0	74.7 75.6 79.7 77.2 77.7	78.5
1.....	80.3 81.0 81.7 82.8 82.3	82.5 78.9	76.2 77.9 79.8 78.3	80.1
18.....	83.5 84.0 84.2 84.4 83.9	83.5 79.6	76.5 78.6 80.5 79.0	81.6
<i>Subject IX.</i>				
Normal I:				
1.....	89.8 90.3 93.0	90.6 88.3 84.5	80.8 82.2	87.4
2.....	100.5 97.8 98.2	100.0 98.0 91.4	90.2 92.3	96.0

3	96.9	96.1	95.8	100.0	95.0	92.0	90.8	93.0	94.9
A	103.2	104.8	104.7	99.3	95.9	95.1	95.0	95.1	100.5
34	101.0	102.0	102.0	103.0	95.0	94.0	95.0	94.0	100.0
Alcohol (dose A):									
16	81.6	82.0	86.2	85.5	85.3	77.7	76.3	79.2	82.3
7	79.8	79.1	81.3	83.4	81.7	82.8	78.9	81.7	80.8
8	84.5	85.1	86.0	87.3	87.4	86.4	84.9	84.8	85.8
B	87.3	87.6	87.7	92.3	91.8	90.1	83.4	86.6	88.0
9	87.6	89.0	90.4	88.9	87.3	90.1	86.1	86.5	88.3
10	91.6	91.7	91.8	97.2	93.9	96.0	87.5	84.8	91.8
Alcohol (dose B):									
16	86.1	86.5	88.1	88.7	87.4	86.2	84.9	84.2	86.6
A	84.5	84.1	85.2	86.1	86.1	84.8	83.8	82.4	83.6
17	77.4	78.1	80.2	82.6	82.5	82.2	80.0	79.9	79.5
B	82.0	83.4	81.2	83.9	84.1	88.8	81.3	79.4	82.6
1	88.7	88.3	90.0	92.1	92.3	90.8	87.6	84.1	89.2
18	84.8	89.5	90.3	88.2	94.4	91.9	90.5	87.8	88.7
Normal II:									
16	87.0	90.5	90.6	92.2	92.7	90.7	87.3	87.2	89.5
A	96.0	96.2	95.2	98.6	99.3	93.8	92.0	94.4	95.0
17	96.5	94.9	94.6	98.0	98.7	93.3	93.0	92.0	94.2
B	102.8	102.5	101.5	104.0	104.9	100.3	99.5	101.5	101.7
1	100.7	104.8	104.6	109.3	109.6	104.3	100.6	103.4	103.6
18	100.9	104.9	103.8	101.7	103.6	105.4	100.3	103.4	103.0
Subject X.									
Normal I:									
1	78.3	78.0	78.5	79.5	79.9	77.7	78.1	78.1	77.9
2	88.4	89.5	87.9	88.4	89.0	86.8	88.6	89.2	88.7
3	88.6	89.2	89.8	89.9	92.7	88.0	91.3	90.9	90.1
A	95.1	97.5	98.1	99.0	99.5	94.9	97.0	96.9	97.2
4	98.4	98.1	97.1	100.4	98.4	96.7	98.5	100.4	98.6
5	93.6	96.2	94.1	96.5	96.7	94.2	95.5	95.5	95.5
Alcohol (dose A):									
16	79.4	79.6	79.4	79.9	81.1	79.0	77.8	77.4	78.8
7	83.8	84.1	84.2	83.7	84.1	85.3	82.9	84.7	84.0
8	88.6	88.7	87.9	88.4	89.0	85.9	86.7	88.3	88.0
B	87.7	88.2	87.6	87.9	89.2	85.9	87.9	89.3	87.9
9	88.3	88.5	88.7	88.7	89.9	86.3	87.9	89.5	88.2
10	90.4	89.3	89.5	90.6	90.7	88.1	89.7	91.7	90.1

¹Normals of the day and taken before alcohol was given. ²No records for series 8, B, 9, and 10. ³No records for series 5.

the succeeding periods. This whole picture of the pulse adaptation in successive periods of the same session and in the first period of successive sessions is a direct analogue to the familiar laws of habit formation, and corresponds with the large practice effect that was actually found to occur in the association experiments (Chapter IV).

Another conspicuous difference in the pulse-reactions on the first and last day is the longer duration of the experimental disturbance on the former. This again is probably an adaptation phenomenon.

To recur to the apparent effect of alcohol on the association pulse, figure 31 makes it clear that gradually increasing pulse-retardation from the beginning to the end of the session is a distinct and characteristic feature of the normal days. The second normal day starts at a slightly different level from the first, but the total relaxation change is practically the same in both days. It is exactly this gradual relaxation which is most obviously modified in the curves for the alcohol pulse. After dose A there is still an increase in the average duration of the pulse-cycles, but it is distinctly less than on the normal days. After dose B, this increase in duration gives place, after the third period of the day, to an irregular decrease. A further conspicuous effect of the larger dose is almost to annihilate the experimental rhythm.

These pulse-changes in Subject VII are too systematically related and too clearly marked to be accidental, but only a few of them are general with the group. While there are points of agreement, several subjects seemed to show more or less persistent pulse-changes in the association test which are purely individual. For some of them, the course of the pulse was quite irregular. Subject VII shows the most pronounced experimental change. Subject IX (a native German), who had considerable difficulty with the association test, shows peculiarly long and relatively large post-stimulation acceleration.

The data of association pulse-changes for all the subjects except Subject VII, which has already been given in the preceding table, are given in table 36. As in table 35, each average represents about 50 pulse-cycles in a corresponding phase of the association experiment. All averages are given in 0.01". The number or letter in the first column designates the series of association words as described in Chapter VI.

Inspection of tables 35 and 36 shows that the pulse of all the subjects is accelerated more or less in the post-stimulation phase of the association experiments. For all subjects, moreover, the post-stimulation pulse-acceleration is greatest on the first normal day. The same kind of adaptation process that appeared conspicuously in the pulse-records of Subject VII appears in the records of all the subjects to some degree. Subjects II, X, and III show a rapid return of the pre-stimulation pulse-length immediately after reaction.

The average post-stimulation acceleration of the pulse is shown in table 37, for both the normal and the alcohol experiments, by the aver-

age decrease in the length of post-stimulation pulse-cycles. For illustration, the post-stimulation pulse-acceleration of Subject II on the first normal day is 0.043'' for the first period (see table 36), 0.023'' for the second, 0.026'' for the third, etc. The average of all periods of the first and second normal day for Subject II is 0.023.'' (See table 37.)

From the averages of table 37 it appears that alcohol tends to decrease the post-stimulation acceleration, though not directly in proportion to the dose. This disproportion depends on two cases, Subjects VI and IX. Unfortunately, the lack of records for Subject VI after dose A unbalances the data here and elsewhere in the association-pulse records. Inspection of the individual records shows that the disproportionate effect of the doses is not general. Doubtless in these, as in

TABLE 37.—*Summary of the post-stimulation acceleration as shown by decreased length of post-stimulation pulse-cycles.*
[Values in hundredths of a second.]

Subject.	Averages.			Difference (1-2, 1-3, etc.).		
	Normal I and II.	Dose A.	Dose B.	Normal I and II.	Dose A.	Dose B.
II.....	2.3	1.3	1.8	1.1	5.5	4.1
III.....	3.3	-2.5	2.3	-0.8	-0.2	1.6
IV.....	3.1	-0.1	-0.9	-2.0	1.6	1.6
VI.....	8.8	8.8	2.0	2.9
VII.....	5.8	5.1	2.1	1.6	0.8	4.4
IX.....	8.2	1.2	7.7	1.3	8.2	-1.3
X.....	3.0	3.1	-1.2	1.9
Average..	4.9	1.3	3.6	0.3	3.0	2.2

other measurements, the "differences" between the normal of the day and subsequent periods is a better expression of the effect of alcohol than the averages. Both expressions agree in their clear indication of a falling-off in the post-stimulation pulse-acceleration after the ingestion of alcohol.

As a contribution to the general theory of association, as well as to the knowledge of the effect of alcohol on the association process, it seemed desirable, if possible, to use our extensive pulse data for a comparison of the other characteristics of the association experiments with the post-stimulation pulse-acceleration. Such a comparison demanded a measure of the experimental acceleration in each association reaction. In view of the previous discussion of the intercurrent pulse-rhythms, and the statistical treatment of our pulse data in the effort to eliminate these rhythms from the average results, the sources of error which are involved in the attempt to isolate the true experimental changes in each experiment need no new emphasis.

While the averages of 50 measurements at each homologous moment in the experiment should give a fairly satisfactory indication of the

tendency of the pulse during the experiment, the course of the pulse in any single experiment would be subject to all possible accidental disturbances. For example, if the post-stimulation acceleration happened to coincide with the inspiration acceleration it would be too large. Conversely, if it happened to coincide with the expiration depression, it would be too small, perhaps even negative. Fortunately, the experimental rhythm, 10'' between stimuli, is quite different from the respiration rhythm, and it seemed possible, consequently, to elaborate the data by using the statistical device which is commonly known as the sliding average to eliminate in part the shorter rhythms, while leaving the longer rhythm relatively undisturbed. For example, a supposititious series of pulse-records may be thus elaborated. We may suppose a pulse-sequence which shows a respiratory pulse-rhythm corresponding to the series, 95, 90, 95, 100, 95. If the experimental acceleration were 10, and the stimulus occurred at 90, the series would read, 95, 90, 85, 90, 85; in which case the apparent post-stimulus acceleration would be only 0.05'', or only 50 per cent of the hypothetical acceleration. If, on the other hand, the stimulus coincided with the value 100, the line would read, 95, 90, 95, 100, 85, 90, etc., and the apparent post-stimulation acceleration would be 0.15'' or 150 per cent of the hypothetical stimulation. The operation of a sliding average of 3 would transform our supposititious pulse-rhythm to 93, 95, 97, 95, and the consequent disturbance of the experimental change occurring at any point would be correspondingly reduced.

The pulse data for the Kent-Rosanoff association series, A and B, were elaborated in this way by substituting the sliding average of three for each measured pulse-length. From the elaborated table the post-stimulation accelerations were computed for each experiment. It is these values which are used in the correlation measurements of pulse and association character as described in Chapter IV. It is obvious that such elaboration of the pulse data does not entirely eliminate the lesser rhythm that it mitigates, and that it leaves all of the larger but probably slower and less disturbing rhythms untouched. Each measurement, consequently, has a relatively large probable error. But the errors were accidentally distributed, and any regular or close connection between an association category and an exaggerated pulse-acceleration should appear as a general tendency in the correlation, if it existed.

In addition to the effect of alcohol on the post-stimulation pulse-acceleration, our data permit us to study the more general effect of the alcohol doses on the course of the pulse from period to period throughout the 3-hour experimental sessions. A summary of the average duration of the pulse-cycles on normal and on alcohol days is given in the first part of table 38, together with the average differences between the normal of the day and subsequent pulse-cycles. In the second part of

table 38 is shown the effect of dose A and dose B on the average pulse and on the average difference respectively.

An inspection of table 38 shows that the general effect of alcohol on the average duration of the pulse-lengths during the 3-hour association experiments is in the direction of pulse-acceleration. The average pulse-cycles are shorter under alcohol than on normal days. In terms of the average differences (1-2, 1-3, etc.), the natural retardation of the pulse in the sequence of the experimental periods is notably diminished by alcohol.

The numerical values of these changes after dose A and dose B are given in the columns under the legends, "Effect of alcohol: dose A,"

TABLE 38.—*Summary of the average length of pulse-cycles during the association experiments*
[Values given in thousandths of a second.]

Subject.	Normal I and II.		Alcohol.				Effect of alcohol (alcohol - normal).			
			Dose A.		Dose B.		Dose A.		Dose B.	
	Average	Average difference.	Average.	Average difference.	Average.	Average difference.	Average.	Average difference.	Average.	Average difference.
II.....	1,050	- 69	1,018	+ 8	1,040	+ 26	- 32	+77	- 10	+ 95
III.....	797	-106	769	- 79	872	- 59	- 28	+27	+ 75	+ 47
IV.....	931	-168	890	-152	927	-114	- 41	+16	- 4	+ 54
V.....	876	-172	849	-173	- 27	- 1
VII.....	816	- 91	799	- 56	728	+ 1.4	- 17	+35	- 88	+ 92
IX.....	968	-102	862	- 44	850	+ 19	-106	+58	-118	+121
IX.....	913	-161	862	- 88	- 51	+73
Average.....	907	-124	867	- 68	878	- 50	- 46	+48	- 29	+ 68

¹One normal day only.

and "dose B" respectively. This table shows that the average normal retardation of the pulse in the 3-hour association experiments is 0.048" more than it is after the 30 c.c. dose, and 0.068" more than it is after 45 c.c. dose of alcohol. In each case where there are data for both doses, the effect varies with the dose. In the entire group of data there is only one negative instance, Subject VI.

In answer to the question whether alcohol accelerated or retarded the pulse during the association experiments, one must say that while an actual acceleration after the dose of alcohol is only occasional, a relative acceleration is almost universal. In other words, under similar conditions, and in homologous periods of the 3-hour experimental sessions, the pulse is faster after alcohol than on normal days.

A comparison of the pulse-lengths of the various periods of the two normal days and after alcohol is given in table 39.

The course of the pulse on the first normal day shows a regular retardation from the first to the last period. A comparison of the

course of the pulse in homologous periods of the first and second normal days shows that the retardation is slightly less in the second normal day, period for period, than it is in the first. The second normal day, moreover, shows a somewhat less regular retardation than the first. Period for period, the alcohol days show less retardation than the normal. As between the different doses of alcohol, the larger dose shows less retardation in homologous periods than the smaller.

TABLE 39.—*Differences between the average pulse-length of the first and of each succeeding period.*
[Values given in thousandths of a second.]

Subject and experiment.	Normal.					Subject and experiment.	Alcohol.				
	1-2	1-3	1-4	1-5	1-6		1-2	1-3	1-4	1-5	1-6
Normal I:						Dose A:					
II.....	- 30	- 45	- 74	- 72	II.....	+ 26	+ 28	- 28	+ 8	+ 7
III.....	- 73	- 79	-144	-166	-196	III.....	- 18	-100	- 99	- 67	-109
IV.....	-118	-169	-189	-229	IV.....	- 89	-152	-164	-207
VI.....	-109	-114	-175	-218	-175	VI.....
VII.....	- 32	- 48	-112	-125	-132	VII.....	- 37	- 13	- 82	- 74	- 76
IX.....	- 86	- 75	-130	-125	IX.....	+ 15	- 35	- 57	- 60	- 95
X.....	-128	-122	-193	-207	-176	X.....	- 52	- 92	- 91	- 94	-113
Average.....	- 82	- 95	-145	-163	-170	Average.....	- 26	- 61	- 87	- 82	- 79
Normal II:						Dose B:					
II.....	- 51	- 58	-102	- 84	-123	II.....	+ 25	+ 32	+ 27	0	- 36
III.....	- 22	- 80	-157	-112	- 79	III.....	- 25	- 52	- 65	- 87	- 66
IV.....	-137	-163	-169	-174	IV.....	- 43	- 81	-119	-212
VI.....	-139	-142	- 85	-201	-216	VI.....	- 82	- 89	-201	-262	-234
VII.....	- 47	- 68	-102	-126	-126	VII.....	+ 71	+ 39	- 2	- 14	+ 25
IX.....	- 56	- 48	-122	-142	-135	IX.....	- 29	- 71	- 40	- 25	- 21
Average.....	- 75	- 93	-140	-140	-136	Average.....	- 22	- 13	- 51	-100	- 66
Total av.....	- 78	- 94	-142	-151	-153	Diff. (A-B)...	- 4	- 48	- 36	+ 18	- 13
Diff. (I-II)...	- 7	- 2	- 5	- 23	- 34	Effect (alcohol -normal).					
						Dose A.....	+ 52	+ 33	+ 55	+ 69	+ 74
						Dose B.....	+ 56	+ 81	+ 91	+ 51	+ 87

In estimating the degree of probability of these results, it should be remembered that they are based on the measurement of over 12,000 pulse-cycles for each subject, except Subjects X and VI. The large number of data, the consistency of the results, and their direct correspondence to the size of the dose satisfy, we believe, the most rigid criteria of experimental evidence for a causal relationship between the ingestion of small doses of alcohol and a relative acceleration of the pulse during the moderate mental activity of the association experiments.

It is worth inquiring further whether there is evidence that the relative acceleration has reached its climax within the experimental session. A comparison of the effects of alcohol on the differences (table 39) shows that there is a regularly increasing relative acceleration after dose A

that is greatest at the end of the session. The evidence is less clear after dose B. But in neither case does it appear clear that a real climax of the acceleration effect has been reached in the 3-hour session.

The question of cause can not be answered from our association-pulse data. These data alone can not even answer the question whether the relative acceleration is a general consequence of the ingestion of alcohol, or a consequence that is peculiar to a special kind of moderate mental activity after taking alcohol. Both of these questions need the additional data from the pulse-records during the other experimental processes.

THE EFFECT OF ALCOHOL ON THE PULSE-RATE DURING WORD-REACTION AND FINGER-MOVEMENT EXPERIMENTS AND ALSO DURING MODERATE MUSCULAR ACTIVITY AND REST.

In accordance with our general program (Appendix I), pulse-records were taken at a variety of homologous points in the course of every experimental session. In the light of the results, it would doubtless be desirable if these records, like those taken during the association experiments, could have been more numerous, or perhaps even continuous. That this was not arranged for was due partly to the enormous additional labor and expense that would have been entailed, partly to the technical difficulties, and partly to the belief that shorter records covering several respiration rhythms at homologous points in the experimental session would contain sufficient pulse data to indicate clearly the effect of alcohol on the pulse frequency during the experiments. With respect to continuous records, it is obvious that they would be useful only if homologous moments of the session were clearly indicated, and only the records of such moments might be compared. Our "sample" records, as we may call them, are theoretically as adequate as any comparable phases of continuous records could be. The only advantage of continuous records would be that the number of phases could be indefinitely extended.

It will be obvious, to all those who have struggled with the difficulties of securing pulse-records during muscular activity, why sphygmographic devices which depend on air transmission were not even considered for the present group of records. The pulse-recording technique first used in these experiments was the Dodge telephone-recorder from the temporal artery, our method I. Later we took electro-cardiograms from body leads through condensers, our method III. Both methods call for the use of a string galvanometer as a recording instrument. Both methods are equally accurate, but in simplicity of adjustment, and dependability under all sorts of conditions, we believe that the latter method has no equal for recording the pulse-rate.

TABLE 40.—Pulse data obtained during mental and physical activity—Average duration.
[Values given in thousandths of a second.]

Subject, kind of experiment, date, and time.	Rest.		Word reaction.		Finger-movements No. 1.		Finger-movements No. 2.		Rising.		60" after rising.		2 genuflections.		60" after 2 genuflections.	
	Average duration.	Mean variation.	Average duration.	Mean variation.	Average duration.	Mean variation.	Average duration.	Mean variation.	Average duration.	Mean variation.	Average duration.	Mean variation.	Average duration.	Mean variation.	Average duration.	Mean variation.
<i>Subject II.</i>																
Alcohol (dose A):																
Sept. 23, 1913:																
8 ^h 10 ^m p. m.	1980	132			1861	142										
8 30 p. m.	(946)	(46)														
8 36 p. m.	919	38			831	67										
8 48 p. m.	981	65			847	42										
8 56 p. m.	979	54			895	82										
9 10 p. m.	968	44			845	42										
9 28 p. m.	1,115	103			864	97										
9 39 p. m.	1,012	48														
9 50 p. m.	1,001	58			842	56										
9 58 p. m.	977	41			893	78										
10 07 p. m.	1,009	71			918	69										
10 15 p. m.	1,068	50			813	41										
10 26 p. m.	968	35			903	79										
10 35 p. m.	1,110	81			907	87										
Average		57				67										
Normal:																
Oct. 8, 1913:																
7 ^h 40 ^m p. m.	1,087	43			927	85										
8 00 p. m.	1,212	137			928	48										
Average		90				66										
Normal:																
Dec. 5, 1913:																
6 ^h 00 ^m p. m.	985	42							691	87	942	23	862	229	958	39
6 35 p. m.	985	40						748	133	938	38	899	213	1,035	24	
7 10 p. m.	843	47						797	140	967	39	866	233	995	99	
7 45 p. m.	1,025	36						783	140	940	36	862	260	962	63	
Average		41				40			125		34			231		56
Alcohol (dose A):																
Dec. 19, 1913:																
5 ^h 30 ^m p. m.	1888	165						1884	125	1815	138	1784	139	1886	131	

TABLE 40.—Pulse data obtained during mental and physical activity—Average duration—Continued.
[Values given in thousandths of a second.]

Subject, kind of experiment, date, and time.	Rest.		Word reaction.		Finger-movements No. 1.		Finger-movements No. 2.		Rising.		60'' after rising.		2 genu-flections.		60'' after 2 genu-flections.	
	Average duration.	Mean variation.	Average duration.	Mean variation.	Average duration.	Mean variation.	Average duration.	Mean variation.	Average duration.	Mean variation.	Average duration.	Mean variation.	Average duration.	Mean variation.	Average duration.	Mean variation.
<i>Subject III—continued.</i>																
Normal:																
Oct. 1, 1913:																
1 ^h 58 ^m p. m.	759	33			671	32										
2 30 p. m.	808	69			752	61										
3 00 p. m.	867	52			792	110										
3 30 p. m.	1,000	50			866	85										
3 42 p. m.	1,008	57			(¹)											
4 10 p. m.	1,072	31			891	100										
4 30 p. m.	1,021	72			872	105										
Average.		52				82										
Normal:																
Jan. 19, 1914:																
5 ^h 10 ^m p. m.	860	35							800	46	665	21	612	9	692	18
5 45 p. m.	826	40	858	61					655	11	733	29	658	20	769	22
6 20 p. m.	680	24	907	72					750	26	616	4	776	29	870	60
6 55 p. m.									781	149	743	26	645	7	829	40
Average.		32		66						62				18		40
Alcohol (dose A):																
Jan. 26, 1914:																
4 ^h 45 ^m p. m.	2760	224							2585	213	2611	213	2580	217	2675	212
5 15 p. m.	715	20							620	16	708	21	571	7	684	28
5 45 p. m.	805	25	765	27					650	17	659	13	596	11	699	35
6 06 p. m.	644	23	768	41					691	23	617	12	671	14	765	26
6 38 p. m.	788	6							631	10	775	47	585	12	668	25
7 05 p. m.	800	19		34					586	12	631	19	586	10		
Average.		18								15				10		28
Alcohol (dose B):																
Feb. 9, 1914:																
4 ^h 30 ^m p. m.	2743	227	2680	226	2677	223								2683	214	
5 30 p. m.	826	26	730	36	716	33								696	20	
6 15 p. m.	837	32	749	29	764	42								728	39	
7 00 p. m.	750	17	736	37												
Average.		25				37									29	

Alcohol (dose A):										
Oct. 15, 1913:										
4 ^b 30 ^m p. m.	1577	1572								
5 30 p. m.	658	14								
5 55 p. m.	676	40								
6 20 p. m.	786	28								
6 45 p. m.	707	90								
7 00 p. m.	756	46								
7 15 p. m.	830	103								
Average.....		53								
Alcohol (dose A):										
Nov. 11, 1913:										
4 ^b 55 ^m p. m.	137	1644	181	1656	169	1694	128			
5 30 p. m.	693	606	117	618	52	674	19			
6 02 p. m.	756	712	127	644	55	693	2			
6 30 p. m.	798	596	94	614	67	708	38			
7 00 p. m.	654	631	109	603	29	741	42			
Average.....		112			50		25			
Alcohol (dose A):										
Dec. 3, 1913:										
4 ^b 35 ^m p. m.	151	1568	164	1655	124	1662	123			
5 10 p. m.	717	606	92	705	32	690	33			
5 37 p. m.	764	593	22	669	12	628	27			
6 00 p. m.	843	651	39	692	39	620	7			
6 25 p. m.	776	637	77	717	35	681	17			
Average.....		35	57		28		21			
Alcohol (dose B):										
Mar. 13, 1914:										
4 ^b 35 ^m p. m.	1795	1730	1704	125						
5 50 p. m.	753	(3)	699	30						
6 40 p. m.	774	734	12	746	16					
7 05 p. m.	764	747								
Average.....		32	12		23					
Normal:										
Mar. 20, 1913:										
4 ^b 25 ^m p. m.	818	802	14	777	43					
5 15 p. m.	908	891	32	714	42					
5 50 p. m.	933	842	47	822	57					
6 35 p. m.	918	901	22	848	18					
Average.....		32	31		40					

The values for the first period of the alcohol experiments were obtained before the alcohol was given and are therefore not included in the averages.
 *5 records at end of plate not strictly comparable with the other data.

³Subject stated that he was thinking of a joke, explaining the pulse accelerations of this period.

³Record illegible.

TABLE 40.—Pulse data obtained during mental and physical activity—Average duration—Continued.
[Values given in thousandths of a second.]

Subject, kind of experiment, date, and time.	Rest.		Word reaction.		Finger-move- ments No. 1.		Finger-move- ments No. 2.		Rising.		60' after rising.		2 genu- flections.		60' after 2 genuflections.	
	Average dura- tion.	Mean vari- ation.	Average dura- tion.	Mean vari- ation.	Average dura- tion.	Mean vari- ation.	Average dura- tion.	Mean vari- ation.	Average dura- tion.	Mean vari- ation.	Average dura- tion.	Mean vari- ation.	Average dura- tion.	Mean vari- ation.	Average dura- tion.	Mean vari- ation.
<i>Subject IX.</i>																
Normal:																
Oct. 10, 1913:																
4 ^h 30 ^m p. m.	931	20			808	48										
5 30 p. m.	961	54			902	32										
6 00 p. m.	883	21			970	54										
6 30 p. m.	1,067	67			942	46										
7 50 p. m.	1,055	73			730	47										
Average.....		47				45										
Alcohol (dose A):																
Oct. 20, 1913:																
4 ^h 32 ^m p. m.	1745	121			1832	161										
5 12 p. m.	800	22			847	47										
5 40 p. m.	825	20			800	28										
5 58 p. m.	859	32			814	59										
6 20 p. m.	866	23			824	40										
6 45 p. m.	896	60			782	52										
7 05 p. m.	914	18			788	49										
Average.....		29				46										
Normal:																
Oct. 27, 1913:																
5 ^h 30 ^m p. m.	906	32														
6 00 p. m.	981	50														
6 20 p. m.	953	24														
6 21 p. m.	962	68														
6 24 p. m.	1,025	42														
6 55 p. m.	986	45														
7 20 p. m.	1,010	53														
Average.....		47														
Normal:																
Nov. 10, 1913:																
5 ^h 12 ^m p. m.	786	60							719	43			602	31	727	18
5 45 p. m.	847	30							660	26			724	40	806	18
6 15 p. m.	870	36							736	134			823	30	798	88

TABLE 40.—Pulse data obtained during mental and physical activity—Average duration—Continued.
[Values given in thousandths of a second.]

Subject, kind of experiment, date, and time.	Rest.		Word reaction.		Finger-movements No. 1.		Finger-movements No. 2.		Rising.		60' after rising.		2 genuflections.		60' after 2 genuflections.	
	Average duration.	Mean variation.	Average duration.	Mean variation.	Average duration.	Mean variation.	Average duration.	Mean variation.	Average duration.	Mean variation.	Average duration.	Mean variation.	Average duration.	Mean variation.	Average duration.	Mean variation.
Subject X.																
Normal:																
Feb. 11, 1914:																
1 ^p 50 ^m p. m.	845	27	728	28	669	15	(1)									
3 00 p. m.	835	13	788	19	706	35	700	26								
3 35 p. m.	846	13	855	21	722	41	707	34								
4 18 p. m.	897	25	861	29	746	36	723	37								
Average		19		24		31		32								
Alcohol (dose A):																
Feb. 18, 1914:																
1 ^p 30 ^m p. m.	2783	212	2746	217	2654	251	2641	242								
3 05 p. m.	864	15	814	25	744	42	737	26								
3 50 p. m.	847	21	866	18												
4 25 p. m.	802	33	855	15												
Average		23		19		42		26								
Normal:																
Mar. 11, 1914:																
2 ^p 20 ^m p. m.	836	14							695	7	708	11	676	9	745	11
2 50 p. m.	812	19							704	16	755	16	653	6	748	17
3 15 p. m.	867	7							745	14	739	9	665	15	746	10
3 45 p. m.	818	25							675	8	735	5	676	10	727	10
4 10 p. m.	756	9							681	11	724	16	643	13	750	9
4 30 p. m.	724	15							666	12	686	17	692	12	784	21
Average		15								11		12		10		13
Alcohol (dose A):																
Mar. 18, 1914:																
1 ^p 36 ^m p. m.	2801	213	2799	217					2702	211	2721	212	2620	24	2740	213
2 45 p. m.	751	3	795	14					666	14	725	11	654	11	743	11
3 20 p. m.	762	15	782	17					641	11	675	11	648	12	726	13
3 45 p. m.	784	9	765	19					632	11	662	11	624	11	681	16
4 10 p. m.	782	10	786	12					652	15	714	7	615	13	746	13
Average		9		15						13		10		12		13

¹Record illegible.
²The values for the first period of the alcohol experiments were obtained before the alcohol was given and are therefore not included in the averages.

The particular phases of the experimental sessions during which "sample" pulse-records were taken varied with the experimental series. In the group of experiments, Series I and IA, pulse-records were taken during the finger-movements and during word-reactions. In all cases, "rest" or no activity records were taken after the subject was in position, but before the experimental process was begun. In the group of experiments, Series II and IIA, pulse-records were taken at rest, *i. e.*, sitting in position, immediately after standing, 60'' after standing, immediately after two double genuflexions, and 60'' thereafter.

The average length of pulse-cycles under these several conditions at various periods of the experimental session is shown in table 40.

A summary of the average pulse-differences during the different experimental processes is given in table 41. Unfortunately, in several instances the data are not complete. This is due to a number of circumstances, but chiefly to our estimate of the relative importance of the main experimental measurements. If a session was overcrowded or if the pulse-recording apparatus failed to function, the main measurements were taken without the pulse. The consequent gaps in the data seemed to make it inexpedient to compare the effects of the different doses on the pulse, except in the pulse-rate of rest and of finger-movement, in which cases the records were more numerous.

TABLE 41.—Pulse data during mental and physical activity—Differences.¹
[Values given in thousandths of a second.]

Subject and kind of experiment.	Date and periods compared.	Rest.	Word-reaction.	Finger-movements No. 1.	Finger-movements No. 2.	Rising.	60'' after rising.	2 genuflexions.	60'' after 2 genuflexions.
<i>Subject II.</i> Alcohol (dose A)..	Sept. 23, 1913:								
	1-3.....	+ 61	+ 30
	1-4.....	- 1	- 14
	1-5.....	+ 1	- 34
	1-6.....	+ 12	+ 16
	1-7.....	-135	- 3
	1-8.....	- 32
	1-9.....	- 21	+ 19
	1-10.....	+ 3	- 32
	1-11.....	- 29	- 57
	1-12.....	- 88	+ 48
	1-13.....	+ 12	- 42
	1-14.....	-130	- 46
	Average.	- 29	- 8
Normal.....	Dec. 5, 1913:								
	1-2.....	0	+ 25	- 57	+ 4	- 37	- 77
	1-3.....	+142	-106	- 25	- 4	- 37
	1-4.....	- 40	- 92	+ 2	0	- 4
Average.	+ 34	+ 25	- 85	- 6	- 13	- 39	
Alcohol (dose A)..	Dec. 19, 1913:								
	1-2.....	- 37	+ 50	+ 87	- 18	+ 50	+ 41
	1-3.....	- 29	+ 97	- 49	- 31	+ 98	+ 47
	Average.	- 33	+ 73	+ 19	- 24	+ 74	+ 44

¹Differences equal periods 1-2, 1-3, 1-4, etc.

TABLE 41.—Pulse data during mental and physical activity—Differences¹—Continued.
[Values given in thousandths of a second.]

Subject and kind of experiment.	Date and periods compared.	Rest.	Word-reaction.	Finger-movements No. 1.	Finger-movements No. 2.	Rising.	60" after rising.	2 genu-flections.	60" after 2 genu-flections.
<i>Subject II</i> —con. Alcohol (dose B)..	Mar. 10, 1914:								
	1-2.....	+ 60	- 32	+ 5	(²)				
	1-3.....	+ 59	- 41	- 33	+ 18				
	1-4.....	- 15	- 32	- 8	+ 22				
	Average.	+ 35	- 35	- 12	+ 20				
Normal.....	Mar. 17, 1914:								
	1-2.....	-105	+ 18	+ 2	- 8				
	1-3.....	-296	- 31	-138					
	1-4.....	(²)	- 98						
	1-5.....	-325	-119	- 59	-140				
Average.	-245	- 57	- 65						
<i>Subject III</i> . Alcohol (dose A)..	Sept. 24, 1913:								
	1- 2.....	+ 25		- 85					
	1- 4.....	+ 21		-106					
	1- 5.....	+ 9		-142					
	1- 6.....	0		-153					
	1- 7.....	0		-190					
	1- 8.....	- 17		-214					
	1- 9.....	- 11		-193					
	1-10.....	- 19							
	1-11.....	- 35		-165					
	1-12.....	- 57		-234					
	1-13.....	- 60		-228					
	1-14.....	- 67		-230					
	1-15.....			-239					
	1-16.....	- 62		-216					
	Average.	- 21		-184					
Normal.....	Oct. 1, 1913:								
	1-2.....	- 49		- 81					
	1-3.....	-108		-121					
	1-4.....	-241		-195					
	1-5.....	-249		(²)					
	1-6.....	-313		-220					
	1-7.....	-262		-201					
	Average.	-204		-164					
Normal.....	Jan. 19, 1914:								
	1-2.....	+ 34	+ 49			+145	- 68	- 46	- 77
	1-3.....	+180				+ 50	+ 49	-164	-178
	1-4.....					+ 19	- 78	- 33	-138
Average.	+107	+ 49			+ 71	- 32	- 81	-130	
Alcohol (dose A)..	Jan. 26, 1914:								
	1-2.....	+ 45	+ 3			- 35	- 97	+ 9	- 9
	1-3.....	- 45				- 65	- 48	- 16	- 24
	1-4.....	+116				-106	- 6	- 91	- 90
	1-5.....	- 28				- 66	-164	- 5	+ 7
	1-6.....	- 40				- 1	- 20	- 6	
Average.	+ 9	+ 3			- 54	- 67	- 21	- 29	
Alcohol (dose B)..	Feb. 9, 1914:								
	1-2.....	- 83	- 50	- 39	- 13				
	1-3.....	- 94	- 69	- 87	- 45				
	1-4.....	- 7	- 56						
Average.	- 61	- 58	- 63	- 29					
Normal.....	Mar. 9, 1914:								
	1-2.....	-147	- 14	-144	-100				
	1-3.....	-281	- 79	- 81	- 60				
	Average.	-214	- 46	-112	- 80				

¹Differences equal periods 1-2, 1-3, 1-4, etc.,²Record illegible.

TABLE 41.—Pulse data during mental and physical activity—Differences¹—Continued.
[Values given in thousandths of a second.]

Subject and kind of experiment.	Date and periods compared.	Rest.	Word-reaction.	Finger-movements No. 1.	Finger-movements No. 2.	Rising.	60'' after rising.	2 genu-flections.	60'' after 2 genu-flections.
<i>Subject IV.</i>									
Alcohol (dose A)..	Sept. 27, 1913:								
	1-2.....	- 51		- 99					
	1-3.....	- 59		- 93					
	1-4.....	-113		-134					
	1-5.....	- 88		- 91					
	Average.	- 78		-104					
Normal.....	Oct. 2, 1913:								
	1-2.....	- 60		- 18				- 63	
	1-3.....	-179		- 38				- 35	
	1-4.....	-246		-191				- 83	
	Average.	-162		- 82				- 60	
Normal.....	Jan. 30, 1914:								
	1-2.....	- 9	- 39			-220	- 77	+ 8	+ 54
	1-3.....	+ 26				-239	- 44	- 78	- 39
	1-4.....	- 79				-221	- 40	+ 28	- 74
	Average.	- 20	- 39			-226	- 53	- 14	- 19
Alcohol (dose B)..	Feb. 13, 1914:								
	1-2.....	- 3	- 74		(²)				
	1-3.....	-114	-138		(²)				
	1-4.....	-225	-150		- 14				
	Average.	-114	-120		- 14				
Normal.....	Mar. 19, 1914:								
	1-2.....	- 96	- 22	- 5	- 76				
	1-3.....	-114	- 64	- 72	- 18				
	1-4.....	-185	- 65	- 49	-100				
	1-5.....	+ 10	-125						
	Average.	-104	- 69	- 42	- 65				
<i>Subject VI.</i>									
Normal.....	Oct. 7, 1913:								
	1-2.....	+ 66		+ 4					
	1-3.....	+ 42		(²)					
	1-4.....	+ 19		(²)					
	1-5.....	+ 89		- 41					
	Average.	+ 54		- 18					
Alcohol (dose A)..	Oct. 14, 1913:								
	1-2.....	+ 74							
	1-3.....	+ 91							
	1-4.....	+ 38							
	1-5.....	+ 80							
	1-6.....	- 11							
	Average.	+ 54							
Normal.....	Oct. 22, 1913:								
	1-2.....	-123							
	1-3.....	- 48							
	1-4.....	- 10							
	1-5.....	-117							
	1-6.....	-120							
	1-7.....	-103							
	1-8.....	-154							
	1-9.....	- 85							
	Average.	- 95							
Alcohol (dose A)..	Oct. 29, 1913:								
	1- 2.....	- 20							
	1- 3.....	+ 16							
	1- 4.....	+ 29							
	1- 5.....	+ 7							
	1- 6.....	+ 48							

¹Differences equal periods 1-2, 1-3, 1-4, etc.

²Record illegible.

TABLE 41.—Pulse data during mental and physical activity—Differences¹—Continued.
[Values given in thousandths of a second.]

Subject and kind of experiment.	Date and periods compared.	Rest.	Word-reaction.	Finger-movements No. 1.	Finger-movements No. 2.	Rising.	60'' after rising.	2 genu-flections.	60'' after 2 genu-flections.	
<i>Subject VI</i> —con. Alcohol (dose A) —con.	Oct. 29, 1913:									
	1-7.....	+133								
	1-8.....	+14								
	1-9.....	+108								
	1-10.....	+135								
	Average.	+52								
	Normal.....	Nov. 5, 1913:								
	1-2.....	+50						+29	-14	
	1-3.....	-10				+113		+53	+89	
	Average.	+20				+113		+41	+37	
	Alcohol (dose A)..	Nov. 12, 1913:								
	1-2.....	-27				+51		-17	-101	
	1-3.....	-17				-49		-81	-21	
	1-4.....	-5				-15		-99	+19	
	1-5.....	+13				-60		-94	-9	
	Average.	-9				-18		-73	-28	
Normal.....	Nov. 19, 1913:									
1-2.....	+86	-62			-22	-22	-1	+34		
1-3.....	+95	-62			-20		-9	+26		
Average.	+90	-62			-21	-22	-5	+30		
Alcohol (dose A)..	Dec. 2, 1913:									
1-2.....	+120				-24	+6	-32	+86		
1-3.....	+97				-22	+40	-62	+89		
1-4.....	+109				-13	+41	+8	+58		
1-5.....	+162				-9	+44	+20	+43		
Average.	+122				-17	+33	-16	+69		
Alcohol (dose B)..	Jan. 22, 1914:									
1-2.....	+30				+7	-43	-21	-21		
1-3.....	+80				-166	+1	-34	-39		
1-4.....	+60				-20	-72	-33	+25		
1-5.....	+39				-2	-3	+19	+23		
1-6.....	+13				-5	+40	+14	+33		
Average.	+44				-37	-15	-11	+4		
Alcohol (dose B)..	Jan. 23, 1914:									
1-2.....	+71			-6						
1-3.....	+31		+42	+6						
1-4.....	+111		+8	+6						
1-5.....	-204		-109	-44						
Average.	+2		-19	-9						
Alcohol (dose A)..	Feb. 12, 1914:									
1-2.....	0	+7	+28	-95						
1-3.....	-74	+13	-20	-38						
Average.	-37	+10	+4	-66						
<i>Subject VII.</i> Normal.....	Oct. 8, 1913:									
	1-2.....	-101		-130						
	1-3.....	-110								
	1-4.....	-177		(²)						
	Average.	-129		-130						
	Alcohol (dose A)..	Oct. 8, 1913:								
	1-2.....	-69								
	1-3.....	-76								
	1-4.....	-122								
	1-5.....	-82								
	1-6.....	+4								
	1-7.....	-164								
	1-8.....	-76								
	Average.	-83								

¹Differences equal periods 1-2, 1-3, 1-4, etc.²Record illegible.

TABLE 41.—Pulse data during mental and physical activity—Differences¹—Continued.
[Values given in thousandths of a second.]

Subject and kind of experiment.	Date and periods compared.	Rest.	Word-reaction.	Finger-movements No. 1.	Finger-movements No. 2.	Rising.	60'' after rising.	2 genu-flections.	60'' after 2 genu-flections.
<i>Subject VII—con.</i>									
Alcohol (dose A)..	Oct. 15, 1913:								
	1-2	- 47		- 81					
	1-3	- 1		- 71					
	1-4	- 38		-209					
	1-5	-117		-130					
	1-6	-203		-179					
	1-7	-166		-253					
	Average.	- 95		-154					
Alcohol (dose A)..	Nov. 11, 1913:								
	1-2	+ 42				+ 38		+ 38	+ 20
	1-3	- 21				- 68		+ 12	+ 1
	1-4	- 63				+ 48		+ 42	- 14
	1-5	+ 81				+ 13		+ 53	- 47
	Average.	+ 9				+ 8		+ 36	- 10
Alcohol (dose A)..	Dec. 3, 1913:								
	1-2	+ 31				- 38	- 50	- 59	- 28
	1-3	- 16				- 25	- 14	- 66	-113
	1-4	- 95				- 83	- 37	- 58	- 53
	1-5	- 28				- 69	- 62	-119	-129
	Average.	- 27				- 54	- 40	- 75	- 80
Alcohol (dose B)..	Mar. 13, 1914:								
	1-2	+ 42	+ 16	+ 5					
	1-3	+ 21	- 31	- 4	- 42				
	1-4	+ 31	- 19						
	Average.	+ 31	- 11	- 4	- 18				
Normal	Mar. 20, 1914:								
	1-2	- 90	- 57	- 89	+ 63				
	1-3	-115	- 53	- 40	- 45				
	1-4	-100	- 92	- 24	- 71				
	Average.	-101	- 67	- 51	- 18				
<i>Subject IX.</i>									
Normal	Oct. 10, 1913:								
	1-2	- 30		- 94					
	1-3	+ 48		-162					
	1-4	-136		-134					
	1-5	-124		+ 78					
	Average.	- 60		- 78					
Alcohol (dose A)..	Oct. 20, 1913:								
	1-2	- 55		- 15					
	1-3	- 80		+ 32					
	1-4	-114		+ 18					
	1-5	-121		+ 8					
	1-6	-151		+ 50					
	1-7	-169		+ 44					
	Average.	-115		+ 23					
Normal	Oct. 27, 1913:								
	1-2	- 75							
	1-3	- 47							
	1-4	- 56							
	1-5	-119							
	1-6	- 80							
	1-7	-104							
	Average.	- 80							
Normal	Nov. 10, 1913:								
	1-2	- 61				+ 59		-122	- 79
	1-3	- 84				- 17		-221	- 71
	1-4	-123				- 13		-155	- 96
	Average.	- 89				+ 9		-166	- 82

¹Differences equal periods 1-2, 1-3, 1-4, etc.

TABLE 41.—Pulse data during mental and physical activity—Differences¹—Continued
[Values given in thousandths of a second.]

Subject and kind of experiment.	Date and periods compared.	Rest.	Word-reaction.	Finger-movements No. 1.	Finger-movements No. 2.	Rising.	60" after rising.	2 genu-flec-tions.	60" after 2 genu-flec-tions.
<i>Subject IX</i> —con.									
Alcohol (dose A)..	Nov. 17, 1913:								
	1-2.....	+ 58				+ 4		- 2	- 70
	1-3.....	- 86				+ 14		- 33	-172
	1-4.....	- 25				- 2		- 99	-123
	1-5.....	+ 10				- 20		- 80	-161
	Average.	- 10				- 1		- 53	-131
Normal.....	Nov. 24, 1913:								
	1-2.....	+ 23	- 35			- 10	- 1	- 18	+ 16
	1-3.....	- 85				- 43	-101	- 18	- 5
	1-4.....	-155	+ 15			-103	- 73	-100	- 60
	Average.	- 72	- 10			- 52	- 58	- 45	- 16
Alcohol (dose A)..	Dec. 1, 1913:								
	1-2.....	- 14				- 29	+ 39	+ 43	- 99
	1-3.....	+ 85				+ 49	+ 70	+ 26	- 79
	1-4.....	+ 58				+ 27	- 36	+ 61	- 50
	1-5.....					+ 58	0	+ 69	-132
	Average.	+ 43				+ 26	+ 18	+ 49	- 90
Alcohol (dose B)..	Jan. 21, 1914:								
	1-2.....	- 41							
	1-3.....	+ 29				- 33	- 13	- 72	+ 6
	1-4.....	- 86				- 66	- 9	- 81	- 9
	1-5.....	- 62				+ 25	+ 18	+ 39	+ 10
	1-6.....	- 92				- 34	+ 47	- 46	- 74
	1-7.....	+ 13				- 1	- 83	- 4	- 46
	Average.	- 39.8				- 22	- 8	- 33	- 23
Alcohol (dose B)..	Jan. 29, 1914:								
	1-2.....	- 41		- 49	- 20				
	1-3.....	+ 5		- 40	+ 18				
	1-4.....	- 70		-140	+ 29				
	1-5.....	- 49		- 15	+ 2				
	Average.	- 36		- 61	- 1.7				
<i>Subject X.</i>									
Normal.....	Feb. 11, 1914:								
	1-2.....	+ 10	- 60	- 37					
	1-3.....	- 1	-127	- 53					
	1-4.....	- 52	-133	- 77					
	Average.	- 14	-107	- 56					
Alcohol (dose A)..	Feb. 18, 1914:								
	1-2.....	- 81	- 68	- 90	- 96				
	1-3.....	- 64	-120						
	1-4.....	- 19	-109						
	Average.	- 55	- 99	- 90	- 96				
Normal.....	Mar. 11, 1914:								
	1-2.....	+ 24				- 50	- 47	+ 23	- 33
	1-3.....	- 31				- 9	- 31	+ 11	- 1
	1-4.....	+ 18				+ 20	- 27	0	+ 18
	1-5.....	+ 80				+ 14	- 16	+ 33	- 5
	1-6.....	+112				+ 29	+ 22	- 16	- 39
	Average.	+ 40				+ 0.8	- 19	+ 10	- 6
Alcohol (dose A)..	Mar. 18, 1914:								
	1-2.....	+ 50	+ 4			+ 36	- 4	- 34	- 3
	1-3.....	+ 39	+ 17			+ 61	+ 46	- 28	+ 14
	1-4.....	+ 17	+ 34			+ 70	+ 59	- 4	+ 59
	1-5.....	+ 36	+ 68			+ 50	+ 7	+ 5	- 6
	Average.	+ 35	+ 17			+ 54	+ 27	- 15	+ 16

¹Differences equal periods 1-2, 1-3, 1-4, etc.

Probably the most insistent impression from a casual inspection of table 41 will be the enormous variability of the pulse in the same individual under what might appear to be identical conditions. In the case of Subject II, for example, the normal rest-pulse has an average difference in one case (December 5) of +34 and in the other case (March 17) of -245. No changes due to the effect of alcohol exceed this change on different normal days. It might seem that out of such chaotic data nothing could be learned. But the data are not so chaotic as they might seem at the first uncritical glance. If one refers to the other average normal differences for Subject II (December 5 and March 17) which are given in table 41, it will be noted that the rest-pulse differences of +34 and -245 belong to quite different series of experiments. The former corresponds to an experimental series which included the relatively vigorous muscular activities which are involved in rising from the steamer-chair, standing, and the double genuflexions. The latter corresponds to an experimental series in which there was a minimum of physical activity. We would not deny that there is large, even gross, variability in the pulse differences under what were intended to be similar circumstances. It was something of a revelation to us that apparently similar conditions could be so different. But the accidental variations are only a small fraction of the apparent variations which are really due to the differences in the experimental series.

In view of these differences, it may be questioned if we are not committing a gross statistical blunder by combining into a single table results which developed under such various conditions. In answer, let us insist that, except in rare instances, normal and alcohol data both appear for each set of conditions. Since data from each set of conditions are obviously directly comparable with respect to the effect of alcohol, when the different sets of conditions are added together the alcohol differences will not thereby disappear or be quantitatively changed. One will merely average the changes due to alcohol which occurred in the rest-pulse of all the experimental series. We have a right to assume that the effects, which result from differences in the experimental series, will balance. Changes which are due to accidental disturbances would also tend to balance the more completely the greater the number of instances. The changes which represent the real tendency of alcohol should therefore most clearly appear in the total averages of all the results which were obtained under all the different sets of homologous conditions.

An inspection of the general averages of the differences given in the extreme right-hand column of table 42 shows that in this group of experimental circumstances, just as in the association experiments, there was a gradual retardation of the pulse during the 3-hour session. On normal days this retardation averaged greatest in the finger-movement experiment, and least in the more violent muscular activities.

Apparently standing and the genuflections are accompanied by about the same pulse-rate at the end as at the beginning of a 3-hour session. It is undoubtedly owing to the interplay of these same physical activities that the average retardation in the normal rest-pulse of these experiments is approximately one-third of what it was in the association experiments which were free from violent physical activity.

Notwithstanding this difference in the experimental conditions, it is conspicuous that in every case the average retardation after alcohol is

TABLE 42.—*Summary of average pulse differences.*¹
[Values given in thousandths of a second.]

Conditions.	Subject II.	Subject III.	Subject IV.	Subject VI.	Subject VII.	Subject IX.	Subject X.	Average.
Rest:								
Normal	+ 34	+107	-162	+ 20	-129	- 60	- 14	-62
	-245	-204	-104	+ 90	-101	- 80	+ 40	
		-214	- 20	+ 54		- 89		-18
				- 95		- 72		
Dose A	- 33	+ 9	- 78	- 9	- 95	-115	- 55	-17
	- 29	- 21		+122	- 83	- 10	+ 35	
				+ 54	+ 9	+ 43		-48
				- 37	- 27			
Dose B	+ 35	- 61	-114	+ 44	+ 31	- 36		-28
				+ 2		- 40		
Word-reaction:								
Normal	+ 25	- 46	- 69	- 62	- 67	- 10	-107	-48
	- 57		- 39					
Alcohol	+ 73	- 58	-120	+ 10	- 11		- 99	-23
	- 35						+ 17	
Finger-movements:								
Normal	- 65	-164	- 82	- 18	-130	- 78	- 56	-73
	- 66	- 80	- 42		- 51			
		-112	- 65		- 18			-75
Dose A	- 8	-184	-104	+ 4	-154	+ 23	- 90	
				- 66			- 96	-23
Dose B	- 12	- 63	- 14	- 19	- 4	- 61		
	- 20	- 29		- 09	- 18	- 2		
Rising:								
Normal	- 85	+ 71	-226	+113		+ 9	+ 1	-24
				- 21		- 52		
Alcohol	+ 19	- 54		- 18	+ 8	- 1	+ 54	- 9
				- 37	- 54	- 22		
60'' after rising:								
Normal	- 6	- 32	- 53	- 22		- 58	- 19	-32
Alcohol	- 24	- 67		- 15	- 40	+ 18	+ 27	
				+ 33		- 8		- 9
2 genuflections:								
Normal	- 13	- 81	- 60	+ 41		-166	+ 10	-37
			- 14	- 5		- 45		
Alcohol	+ 74	- 21		- 73	+ 36	- 53	- 15	- 9
				- 16	- 75	- 33		
				- 11		+ 49		-28
60'' after 2 genuflections:								
Normal	- 39	-130	- 19	+ 37		- 82	- 6	-22
				+ 30		- 16		
Alcohol	+ 44	- 29		- 28	- 10	-131	+ 16	-22
				+ 4	- 80	- 23		
				+ 69		- 90		

¹Differences equal periods 1-2, 1-3, 1-4, etc.

less than on normal days, just as it was in the association experiments. In the wide variety of mental and muscular activities which are represented by these measurements, making very different demands on the heart, the effect of alcohol is always in the same direction. Individual exceptions to the rule are more numerous than in the association experiments, but they are negligible in view of the uniform tendency in the averages.

The greatest average relative acceleration effect of alcohol appears in the rest-pulse, where it is 5.3 per cent of the average length of the pulse-cycles.¹ After standing quietly for 60'' subsequent to the double genuflexion experiment, the average accelerating effect of alcohol is least, being 0.8 per cent. Between these two extremes the order of effect is 4.1 per cent for the double genuflexions; 3.2 per cent for the finger-movements; 3.1 per cent for the standing rest subsequent to the rising; 2.4 per cent for the word-reactions; and 2.2 per cent for the rising. The average effect of alcohol in all these experiments is 3 per cent of the normal pulse-cycles.

An indication of the relative demands of the various experimental processes on the pulse is shown in the summary of the normals of the day for each of the experiments. (See table 43.)

From a comparison of the averages of table 43, it appears that the word-reactions accelerate the pulse 1.1 per cent; finger-movements 9.3 per cent; rising 21.6 per cent; two double genuflexions, 18.5 per cent; while 60'' after rising and the genuflexions the acceleration is slightly less than 11 per cent in both cases. The word-reaction acceleration is conspicuously less than that of muscular work; it appears to be less also than the acceleration of the association measurements. These latter values are, however, not strictly comparable, since the word-reaction pulse was not correlated with the process of reacting, as was the association acceleration. We were content in the former case with the average pulse of the experimental process.

The amount of experimental acceleration bears no fixed relation to the percentile effect of alcohol in the several instances. The disproportion is greatest and probably also the most significant in the pulse-acceleration 60'' after the more violent muscular activities of rising and the double genuflexions. We would not imply that our data in this respect are numerous enough or sufficiently followed up by related experiments to be conclusive, but taken together with other data they form part of the cumulative evidence that the effect of alcohol on the pulse-changes incident to physical as well as to mental work manifests itself in a slowness or sluggishness of response. In the association

¹The percentile average relative acceleration of the pulse effected by alcohol is calculated from the data of tables 42 and 43. For example: the normal rest retardation of the pulse during the three hours experiment averages 0.062'' (table 42); the alcohol retardation under similar circumstances averages 0.0175'', giving a relative acceleration of 0.0445'', or 5.3 per cent of the average normal of the day pulse during rest as given in table 43.

TABLE 43.—*Summary of the average duration of the pulse-cycles during each of the experimental processes for the first period or normal of the day.*

[Values given in thousandths of a second.]

Subject.	Rest.	Word-reaction.	Finger.	Rising.	60'' after rising.	2 genu-flections.	60'' after genu-flections.	
II . . .	1,087	927	
	980	861	
	1,030	968	962	
	961	898	865	
	985	691	942	862	958	
III . . .	971	969	848	944	848	952	
	888	884	815	784	886	
	860	853	800	665	612	690	
	760	765	585	611	580	675	
	759	671	
IV . . .	687	506	
	743	680	677	
	798	805	772	
	835	820	
	837	786	
V . . .	797	780	860	
	809	890	814	
	881	870	617	810	778	806	
	794	736	
	787	
VI . . .	872	
	867	847	778	
	901	784	
	788	
	875	738	689	766	
	827	677	673	726	
	858	582	683	638	690	
	851	577	709	625	690	
	814	749	602	695	629	715	
	930	747	600	666	657	726	
	717	643	
	634	590	
	703	626	
	655	
	675	577	
VII . . .	795	728	730	
	818	809	802	
	735	644	656	690	
	748	820	568	655	562	662	
	700	843	565	654	561	668	
	839	683	731	698	743	
	829	660	782	719	786	
	1,001	1,061	774	860	804	719	
	906	649	663	616	
	786	719	602	727	
	906	
	940	771	
	745	832	
	931	808	
	888	870	
IX . . .	815	809	
	817	728	669	
	783	746	654	
	836	695	708	676	745	
	801	799	702	721	620	740	
	Average.	835	826	757	675	745	681	744

experiments this was shown in a flattening out of the experimental change after alcohol. In the pulse-acceleration of physical work the effect of alcohol is greater immediately after the exercise; 60'' later it is conspicuously less.

CAUSE OF THE RELATIVE ACCELERATION OF THE PULSE AFTER ALCOHOL.

While a positive acceleration of the pulse after the ingestion of alcohol is found only occasionally in the succeeding periods of our experimental sessions, relative acceleration is, as we have seen, almost universal. By relative acceleration we mean a more rapid pulse than occurs at homologous periods of normal days.

It seems possible that some part of the discrepancies in the literature which we cited in the first section of this chapter, with respect to the effect of alcohol on the pulse-rate of both man and animals, results from a confusion between positive and relative acceleration. In the ordinary course of investigation it requires especial and insistent emphasis on normal experiments to detect relative acceleration. In operative techniques it is often difficult if not impracticable to secure homologous normal experiments in sufficient number for the detection of relative changes. Even when practicable it often seems like a waste of material. But where the alcohol effects are small and necessarily superposed on normal or other experimental rhythms, we believe that our data show the value of careful comparative treatment. To indicate a probable partial cause in the discrepancies of traditional data we believe to be almost as useful as direct data in our attempt to solve the alcohol problem. Other and more significant causes of discrepancy will appear in the following discussion.

In our experiments at least, relative acceleration of the pulse occurs in greater or less degree in all subjects as a part of the effect of alcohol on the pulse during a considerable variety of mental and physical activities. The large number of our records and the variety of the processes permit us to make the following generalization: A regular effect of moderate doses of alcohol on temperate non-abstainers during intermittent mental and physical activity is a relative acceleration of the pulse. The fact is quite unequivocal in our records, but it constitutes a clear exception to our other experimental results. In no other case have we found consistent increase of a function as a result of the ingestion of alcohol.

The cause of the relative acceleration of the pulse after alcohol thus becomes a question of considerable theoretical importance. As is well known there are two reciprocating mechanisms that determine the rate of heart-contraction. The classical paper of Reid Hunt¹ is generally credited with the demonstration that increased pulse-rate after the beginning of muscular activity is commonly produced by a depression of the heart inhibitor as well as by a stimulation of the accelerator.

¹Hunt, *Am. Journ. Physiol.*, 1899, 2, p. 395.

Practically it might make no difference whether a given acceleration was produced by one mechanism or the other; but for the theory of the effect of alcohol on neuro-muscular tissue it is of the utmost importance whether or not the autonomic system reacts in a directly opposite way to that of the cerebro-spinal. For theoretical reasons we are under obligations to ask the bearing of our data on the question whether the pulse-acceleration as effected by alcohol is due to a positive stimulation of the cardiac accelerator or to a partial paralysis of the cardiac inhibiting mechanism.

In the conflicting answers of traditional experiments to the fundamental direction of the effect of alcohol on the human pulse, it is not surprising that there is scant experimental evidence with respect to the origin of that effect. Dixon,¹ Reid Hunt,² and Lauder Brunton³ hold that in view of the reflex acceleration of the heart from the stimulation of various afferent nerves, the acceleration of the heart by alcohol is a reflex of the vasomotor center to the local irritation of the mouth and stomach. But apparently the evidence for this view is indirect rather than direct. Our own data can not be harmonized with this hypothesis. If the relative acceleration were a reflex to local irritation, it should be most pronounced soon after the ingestion of alcohol, and should gradually decrease as the alcohol is absorbed. Our association data, on the contrary, show a relatively small effect in the first half hour and a gradually increasing relative acceleration up to the end of the 3-hour experimental session, when the alcohol by absorption and dilution may be supposed to have lost a large part or all of its effect on the stomach-walls as a local irritant.

Hascovec⁴ found with dogs that atropin, which specifically paralyzes the vagus endings in the heart, increases heart-rate after alcohol. But even that, if it were conclusively demonstrated for humans, would hardly answer our question.

The observations of Reid Hunt² on the differential effect of accelerator and inhibitor mechanisms on the relative length of systole and diastole give us the only non-operative technique which is commonly accepted as proving the involvement of either of the two heart-regulating systems. Hunt found that after stimulating the accelerator both diastole and systole decrease together, while as a result of the loss of vagus tone the chief loss is in diastole. In this manner he proved that chloral, chloroform, and ether affect chiefly the cardio-inhibitory center, and seem to have but little effect on the accelerator center. The chief difficulty in applying the method of Hunt to ordinary sphygmograms is the indistinctness and uncertainty of the separation between systole and diastole, which is incident to the interaction of the natural

¹Dixon, *Journ. Physiol.*, 1907, **35**, p. 346.

²Hunt, *Am. Journ. Physiol.*, 1899, **2**, p. 395.

³Brunton, *Therapeutics of the Circulation*, London, 1914, p. 178.

⁴Hascovec, *Wiener med. Wehnsch.*, 1909, **59**, p. 457.

period of the registering system, as well as to the broadness of the dicrotic notch.

Fortunately the Dodge temporal-pulse recorder, in series with the string galvanometer, gave sphygmograms which are peculiarly adapted to the differentiation of systole and diastole. Not only is the string galvanometer an aperiodic recorder, but the form of the pulse-wave is such as to emphasize the beginning of systole and the dicrotic incisure. Without going into the details of the construction and operation of the recorder, let us recapitulate its principles. The string galvanometer is affected by minute electric currents which are generated in a telephone-receiver, when the little armature which rests on the artery moves towards or away from the permanent magnet of the receiver. The action of the armature on the field of the receiver and consequently on the string of the galvanometer depends on the speed and direction of its movement. If the armature is at rest or moves only slowly, as in the systolic plateau, the string returns to its zero-point, from which it moves in the opposite direction at the beginning of the dicrotic incisure. A pulse-record from this instrument consists chiefly of a large systolic spike and a small inverted spike at the dicrotic notch, as represented by a specimen record in figure 29 (opposite page 171).

The only limitations to the accurate reading of such records are their length and the care of the reader; the points are clearly enough marked to read thousandths of a second. In the records at our disposal, however, the speed of the photographic paper was adjusted for reading not closer than 0.005".

Pursuant to the theory of Hunt, a number of our temporal-pulse records were re-read with reference to the relative length of systole and diastole. The records that we happened to read first were those of Subject III and they will serve very well as an illustration. Three records from the normal rest pulse of Subject III on March 9 gave the following averages:

5 ^h 00 ^m p. m.	Av. systole 313 σ .	Av. diastole 556 σ .
6 00 p. m.	Av. systole 315 σ .	Av. diastole 639 σ .
6 35 p. m.	Av. systole 301 σ .	Av. diastole 781 σ .

In this normal session the retardation of the pulse, amounting to 42 per cent, was entirely due to longer diastole; that is, according to the theory of Professor Hunt, the retardation was chiefly or exclusively due to increased action of the heart inhibitor, probably to increased vagus tone. A conspicuously different picture is presented by records from the alcohol day, February 9. One of the pre-alcohol records, record 1, showed at 4^h 15^m p. m., average systole 278 σ ; average diastole, 407 σ . Twenty minutes after dose B of alcohol, at

5 ^h 20 ^m p. m.	Av. systole 278 σ .	Av. diastole 515 σ .
6 30 p. m.	Av. systole 300 σ .	Av. diastole 543 σ .

That is, after alcohol an increase in diastole of about 33 per cent corresponded with an increase in systole of about 8 per cent. This appears

to show some depression of accelerator tone, but in nothing like the proportion that should theoretically obtain in a pure accelerator depression. It is noteworthy that the normal of the day on the alcohol day shows a rapid pulse. Even at 6^h30^m p. m. the duration of systole is slightly less than on the normal day. The failure of the pulse on the alcohol day to reach the retardation of the normal day was consequently due solely to a less rapid lengthening of diastole. In other words, after alcohol the normal inhibitor tone was less completely or less rapidly established. Whatever evidence this illustrative case may give seems to indicate that the relative acceleration effected by alcohol is due to a lessened responsiveness of the cardio-inhibitory mechanism. The argument, however, is not entirely clear, since we are dealing with two variables in the relative acceleration: (1) the alcohol change, and (2) the normal relaxation change. In view of the consequent ambiguity of interpretation, we hesitated to have all the pulse-records re-read to find the relative change in the duration of systole and diastole. It is possible that this ought to be done, but we believe that other and less ambiguous data will be more convincing.

Even in the association-pulse there were some indications that the effect of alcohol was a partial paralysis of the cardio-inhibitory mechanism. First, it will be remembered that there was little or no positive acceleration of the pulse after alcohol. Our "relative acceleration" is really a failure of the pulse to develop its normal retardation. That seems less like the effect of positive stimulation than it does like a partial paralysis of the depressor. Secondly, we noted that alcohol flattened out the response of the pulse to the association process. It will be remembered that the association rhythm was completely changed after dose B, in Subject VII (see fig. 31). Now, it seems to be well established that rapid adjustments of the pulse-rate to varying demands of work and rest are effected by the inhibitor (Hunt,¹ Aulo²). The accelerator reacts more slowly, with a latency of the order of 10'', when it reacts at all. Since the entire association cycle occupied only 10'', the post-stimulation change in the association pulse can not be a phenomenon of the slow-acting accelerator, but must on the contrary be conditioned by the cardio-inhibitor mechanism. The elimination of the post-stimulation pulse-change after alcohol must consequently be due to a decreased responsiveness of the cardio-inhibitor mechanism.

It was these considerations of the different latencies of the accelerator and depressor mechanisms that gave special significance to a phenomenon that was incidentally observed during the re-reading of the records for the relative length of systole and diastole. It was observed that on the normal day of Subject III, the mean variation of the diastolic pulse-phases was approximately 10 per cent of the total length of diastole.

¹Hunt, *Am. Journ. Physiol.*, 1899, 2, p. 395.

²Aulo, *Skand. Archiv f. Physiol.*, 1911, 25, p. 347.

Av. diastole 556σ; M. V. 63σ. Av. diastole 639σ; M. V. 68σ. Av. diastole 781σ; M. V. 77σ.

Similarly the normal of the day on the alcohol day showed about the same percentile mean variation:

Av. diastole 407σ; M. V. 42σ.

After alcohol, however, the mean variation dropped to 5 per cent and less:

Av. diastole 514σ; M. V. 23σ. Av. diastole 543σ; M. V. 20σ.

TABLE 44.—Average mean variations of the pulse-cycles under varying conditions.
[Values given in thousandths of a second.]

Conditions.	Subject II.	Subject III.	Subject IV.	Subject VI.	Subject VII.	Subject IX.	Subject X.	Average.
Rest:								
Normal	41	32	32	25	33	47	19	} 35
	46	52	42	30	32	47	15	
		58		30	26	41		
				28		36		
Dose A	38	18	31	17	25	29	23	} 21
	57	27		15	17	39	9	
				19	20	44		
Dose B	57	25	47	32	23	36		} 35
				30		33		
Word-reaction:								
Normal	40	66	37	34	24	68	24	} 41
	38	49	32					
Alcohol	41	34	30	28	35	37	19	} 32
	46	34		21	24	39		
Finger-movements:								
Normal	44	82	69	49	34	45	31	} 46
	61	50	40		31		32	
		47	33		40			
Dose A	67	39	62	49	53	46	42	} 48
							26	
Dose B	33	37	20	41	12	65		} 40
	77	29	52	43	23	43		
Rising:								
Normal	125	62	¹ (31)	40		63	11	} 54
						21		
Alcohol	184	15		90		17	13	} 44
				19		14		
				12		28		
60'' after rising:								
Normal	34	59	¹ (40)	23		18	12	} 29
Alcohol	30	22		19		17	10	} 19
				16		22		
				16				
2 genuflections:								
Normal	231	18	38			39	10	} 55
			24			25		
Alcohol	81	10	49			22	12	} 36
			34			77		
			14			30		
60'' after 2 genuflections:								
Normal	56	40	31			17	13	} 29
			23			25		
Alcohol	27	28	24			25	13	} 25
			25			29		
			14			37		

¹Bracketed normal mean variations had no corresponding alcohol measurements and are consequently excluded from the averages.

This change was so marked and consistent in this subject, and in several others that were sampled, that we reviewed the whole pulse data to collect the mean variations of the pulse-cycles of each record. The pulse-changes that commonly occur within the limits of our 12" records are on the one hand the respiration rhythms, and on the other hand such arrhythmic changes as are produced by the experimental processes. In both cases the long cardio-accelerator latency obviously precludes the accelerator mechanism from participation in these short rhythmic and arrhythmic changes in the pulse frequency. Consistent change in the mean variation of the pulse or its absence seemed to us to be a most important indicator of the responsiveness of the cardio-inhibitor mechanism. The relevant data are collected in table 44 and summarized with respect to the influence of alcohol in table 45.

TABLE 45.—*Summary of the effect of alcohol on the mean variation of the pulse-cycles.*

Condition.	Effect of alcohol as shown by the mean variation.		Percentage effect.
Rest:	σ	σ	<i>p. ct.</i>
Dose A.....	Decreased from 35.5	to 21.5	40
Dose B.....	Decreased from 35.5	35.4	0
Word-reaction.....	Decreased from 41	32	22
Finger-movements:			
Dose A.....	Increased from 46	48	- 4
Dose B.....	Decreased from 46	40	13
Rising.....	Decreased from 54	44	18
60" after rising.....	Decreased from 29	19	33
Genueflections.....	Decreased from 55	36	35
60" after genuflections.....	Decreased from 29	25	13
Average decrease.....			19

Notwithstanding large individual variations, and considerable variability in records from the same individual, which follow inevitably from the varying conditions under which the records were taken, the average changes, which alone are significant, indicate a persistent tendency for alcohol to diminish the mean variation of the pulse-cycles within the limits of our "sample" records. In only one instance, finger-movements after dose A, is the average mean variation larger after alcohol than on the normal days, and in this case the percentile change is conspicuously small. The average decrease in the mean variation of the pulse-cycles after alcohol is 19 per cent. It should be noted that these percentages are based on the entire pulse-cycle, and not on the diastole, as in the discussion of the relative changes in systole and diastole of Subject III.

It may be held that the smaller mean variation after alcohol is due to the relative acceleration of the pulse after alcohol. This could not explain it. The changes in mean variation are absolute, not relative, and occur even in those cases in which there is no absolute acceleration. Moreover, the average acceleration was only 3 per cent (p. 231), while the average decreased mean variation is 19 per cent. The decreased

mean variation of the pulse-cycles after alcohol must consequently be regarded as a real effect of alcohol.

The bearing of this fact on the evidence for alcoholic partial paralysis of the heart inhibitory mechanism depends on the previously discussed difference between the latency of inhibitor and accelerator. Let us repeat: Accelerator latency is 10'' and over; inhibitor latency is less than 1''. Consequently the first response of the heart to increased muscular activity with a latency of less than one pulse-cycle is not an accelerator impulse, but a release of the heart from the inhibitory influence of the vasomotor centers. Similarly, normal respiratory pulse-rhythms follow expiration and inspiration within one pulse-cycle. Inspiration, the active phase of respiration, accelerates the heart with a latent time of less than 1''. Expiration retards the pulse with a similar latent time. Such latency corresponds with the known latency characteristic of the vagus, and fixes the respiratory rhythm as a function of the inhibitory mechanism. The accelerator latency of 10'' absolutely precludes its participation in the pulse-changes corresponding to our experimental processes, or to the respiratory rhythms of rest. The flattening out of the respiratory and experimental rhythms after alcohol is consequently due to a partial paralysis of the inhibitor.

It might be objected that some other influences could produce the same effect, as, for example, decreased depth of respiration. Such a change in the respiration would be the exact opposite of that found by Wilmanns¹ and Weissenfeld.² Unfortunately, our respiratory data are too few to give us any clue to the situation. But even if it were proved to exist, such a far-reaching flattening-out of respiration would be as significant as the changes in the pulse. Instead of one being referred to the other, doubtless both would have to be referred to a common cause. Moreover, the pulse-changes after experimental movements and other definite amounts of physical activity give us a clear guarantee that we are not dealing with a mere accident of modified respiration. The pulse-changes at the beginning of physical work have a latency that shows them to be due to changes in the vagus tone. And these work accelerations suffer even greater loss after the ingestion of alcohol than the respiratory rhythm of rest.

It should be noted that the inhibitor paralysis as affected by 30 and 45 c.c. of alcohol is not complete, but only partial. Even after 45 c.c. of alcohol, increased activity still produced a faster pulse. This is in line with other experimental facts. Gutnikow³ showed that the vagus could be stimulated by electricity in alcoholic narcosis; but in our experiments the accelerating effect of muscular action is less after alcohol, and the decreased mean variation indicates that its beginning is more sluggish. The whole picture of the effect of alcohol on the

¹Wilmanns, *Archiv f. d. ges. Physiol.*, 1897, **66**, p. 167.

²Weissenfeld, *Archiv f. d. ges. Physiol.*, 1898, **71**, p. 60.

³Gutnikow, *Zeitschr. f. klin. Med.*, 1892, **21**, p. 168.

depressor corresponds point for point with the effect of alcohol on the reflex mechanisms of the cord and basal ganglia. The extent of the reflex response was lessened and the latent time was lengthened. Hence it should not surprise us that the cardio-inhibitory reflexes of the medulla show similar effects of alcohol.

The question as to why alcohol in moderate doses acts selectively on the heart inhibitor rather than on the accelerator is one that properly belongs to general physiology rather than to this investigation. It may be noted, however, that alcohol in this respect, as in others, appears to follow its pharmacological relatives, ether and chloroform (Hunt¹). Moreover, it seems that the inhibitor is in general more susceptible to disturbing influences than the accelerator. It acts quicker and responds to less vigorous stimuli (Hunt,¹ Aulo,² Krogh and Lindhard³). But we expressly limit our generalizations as to the effect of alcohol on pulse frequency to the dosage and other conditions of our experiments. There is, indeed, some probability that the curve which represents a direct proportion between the dose and pulse frequency for 30 and 45 c.c. would follow the same direction above and below these limits. But our actual data are limited to our two doses; and theoretically there is no guarantee that a cusp in the curve or a change in its direction might not occur at any point. In fact, Dixon⁴ definitely voices a common conviction that in the qualitative pulse-changes produced by different doses, alcohol is unique. Moreover, if alcohol is a general depressant, as our evidence shows, there is no reason why it should not also partially paralyze the cardio-accelerator as well as the cardio-inhibitor mechanism. Indeed certain of our results, viz, the relatively large loss in rhythmic, respiratory, and experimental changes in the pulse variability, as compared with the slight acceleration changes, suggest that the effects of a decreased irritability of the cardio-inhibitory center are contaminated, even in our data, by a decreased accelerator tone.

That under our experimental circumstances the inhibitor mechanism suffers the greater depression seems to be clear from our data. But different circumstances might supposedly alter the balance of the effects in the two systems so as to produce no change at all in the pulse-rate or even to produce a pulse retardation instead of an acceleration after alcohol. Something of that sort apparently happened in the case of Subject IV in the association-pulse after dose B. The commonly accepted doctrine that alcohol retards the pulse of fever patients may be another case to the point. Mosso and Galeotti⁵ remarked the similarity of the alcohol pulse to the fever pulse. It seems plausible that if the cardio-inhibitor center has already been notably depressed before the alcohol is given, its further depression

¹Hunt, *Am. Journ. Physiol.*, 1899, **2**, p. 395.

²Aulo, *Skand. Archiv f. Physiol.*, 1911, **25**, p. 347.

³Krogh and Lindhard, *Journ. Physiol.*, 1913, **47**, p. 120 (esp.).

⁴Dixon, *Journ. Physiol.*, 1907, **35**, p. 346.

⁵Mosso and Galeotti, *Lab. Sci. Int. du Mont Rosa*, 1903. (Published 1904.)

might be relatively slow, thus bringing into prominence a coincident depression of the accelerator. Further support for this general relationship appears in the antagonism between atropin and alcohol (Hascovec). Moreover, the effect of alcohol on the pulse-rate has been found to persist after the vagi are cut (Hascovec¹ and Dixon²). Such an event would be inexplicable if the inhibitor center alone were affected. We suggest that in this probable effect of alcohol on both antagonistic mechanisms, combined with the failure to differentiate absolute and relative acceleration, there is ample opportunity for all the various experimental results that were noted from the alcoholic tradition in the first part of this chapter. Reversal of effect on the pulse-rate would seem to be theoretically probable, if ether or chloroform had been administered previous to alcohol or in febrile cases.

The contention of Cushny³ that the pulse-acceleration effected by alcohol is due to increased muscular activity, and not to any direct action on the regulating mechanisms, is not supported by our data. One might have criticised any data that were obtained during mental experiments alone, on the ground that while the subjects seemed to be quieter after alcohol than on normal days, there might have been increased muscular activity that we did not notice. The fact that similar changes accompany definite physical tasks leaves such an objection improbable. We have no disproof, however, of the hypothesis that without any mental or physical activity the pulse-rate might remain unchanged. We would again insist that the changes in the pulse-rate herein described belong to experimental conditions of moderate mental or physical activity. They should not be uncritically transferred either to intense activity or to complete relaxation, for reasons that we have already discussed. But whether the relative acceleration results or not, the effect of alcohol on the cardio-inhibitory center ought to be demonstrable wherever it occurs by a depression of the normal rhythms.

In view of the large amount of our pulse data, and the thoroughness with which it was read and elaborated, we believe that the accelerating tendency of alcohol on the pulse-rate of normal human subjects, during moderate mental and physical activity, may be regarded as certain. We also believe that the evidence is sufficient to show that such relative acceleration must be referred to a partial paralysis of the cardio-inhibitor centers.

But whether these generalizations be accepted or not, the experimental fact remains that generally decreased irritability of a considerable number of related neuro-muscular processes consequent to the ingestion of alcohol was regularly accompanied by a relative acceleration of the pulse-rate. These two facts taken together we must regard as a clear indication of decreased organic efficiency as a result of moderate doses of alcohol.

¹Hascovec, Wiener med. Wehnsch., 1909, 59, p. 457.

²Dixon, Journ. Physiol., 1907, 35, p. 346.

³Cushny, Pharmacology, Philadelphia, 1910.

CHAPTER IX.

SUMMARIES AND CORRELATIONS.

DIFFERENTIAL INCIDENCE OF THE EFFECTS OF ALCOHOL.

The first attempt to measure the relative incidence of the effect of alcohol on various fundamental mental processes is the classical work of Kraepelin.¹ In this task he was a pioneer. Since his work there have been numberless special investigations of the action of alcohol on various mental operations, but there have been no systematic groups of experiments that permitted an inference as to the relative incidence of the alcohol effect.

The well-known conclusions of Kraepelin may be condensed as follows: All doses of alcohol depress the intellectual processes of apprehension, memory, and judgment. Small doses facilitate motor discharge at first and subsequently depress it. Large doses depress both intellectual and motor processes from the first. The nature and amount of the effects depend on the characteristics of the individual and on his condition.

Certain apparent discrepancies between our results and his led us to a careful review of Kraepelin's original arguments. In that review two factors challenged our attention, viz, (1) the neural complexity of all his experimental processes, and (2) the unsatisfactoriness of some of his analyses as judged by present standards. For example: As experimenter and as theorist, Kraepelin worked under the tradition of a complete differentiation of the sensory and motor factors in reaction. Choice and discrimination were for him real factors in the reactions called by these respective names. It is now generally realized, however, that choice is not discoverable in the consciousness that accompanies the practiced so-called choice reaction, and that the discrimination reaction is complicated by notable inhibitory tendencies that are in their nature motor rather than discriminatory. But from his standpoint, Kraepelin was able to say without hesitation that the difference between the results of the discrimination reaction and those of the simple reaction can be referred only to the new factor which it was intended to introduce into the process, viz, the discrimination. Consequently, since the "discrimination" appears to be lengthened by alcohol, he holds that the intellectual factor in reaction processes is paralyzed by alcohol. Similarly, since the intentionally new factor in the choice reaction is primarily a motor process, and since the choice reactions are shorter in his experiments after alcohol, he held that the discharge of motor processes is facilitated by moderate doses of alcohol. Con-

¹Kraepelin, *Wundt's Phil. Studien*, I, 1883, p. 573. Ueber die Beeinflussung einfacher psychischer Vorgänge durch einige Arzneimittel. Jena, 1892.

tributory evidence for these conclusions he found in his other experiments, as well as in acute alcoholic intoxication, and in the interrelation between the effects of alcohol and disease processes, particularly in relation with epilepsy.

The conception of all sensory and motor processes as a resultant of complex stimulating and inhibiting factors was not as well established in the psychophysiological tradition when Kraepelin did his experimental work and made his first analyses, as it is at present. His own analysis of the work curve, for example, was a later development. While we can no longer regard discrimination and choice as adequately describing the characteristics of the "discrimination" and "choice" reactions, we have come to regard the conditions of neural processes on a scheme of reciprocating mechanisms, as a complex of exciting and controlling tendencies, with great variability of the adequacy and completeness of the controls.

In contrast to the experimental processes of the Kraepelin series, our experiments were planned expressly to test the conditions of the nervous system at widely different levels in the simplest practicable processes. The question of the incidence of the effect of alcohol on the different levels is not merely an effort to explain our data. It was a direct problem from the beginning of our investigation and served as one of the principles that determined the choice of measurable processes.¹ But, even more than the direct measurement of the effects of alcohol on the various processes, we believe that their interrelations and experimental analyses give us the conditions for a more definite answer to the problem of the incidence of the effects of alcohol within the physiological schema of nervous action than could have been given by a less systematically organized group of processes.

The relevant data with respect to the incidence of the effect of alcohol are collected in table 46, arranged in the order of previous discussion. From this table it appears that the most marked effects of alcohol are shown in the knee-jerk, where alcohol increased the average latent time 10 per cent and decreased the average extent of muscle-thickening 46 per cent. This extreme effect, it will be remembered, made it impracticable to measure the knee-jerk of several subjects after the larger dose (dose B).

The second largest effect is produced in the lid-reflex, which shows an average increased latency of 7 per cent and decreased extent of movement of 19 per cent. These changes vary directly with the dose of alcohol, and must satisfy the most exacting demands of reliability. The change would be much larger, save for the two exceptional cases of Subjects X and IV whose lid reflexes were small in amplitude by reason of inheritance, or training, or both. In explanation of these two cases,

¹See Psychological Program, p. 273, (2) and (3).

in view of the general effects of alcohol, and in view of the specific evidence that in the pulse apparent facilitation in response to alcohol was proved to result from a paralysis of inhibitors, the most practical hypothesis is, as we have seen, that alcohol diminished the controlling influence of the particularly prominent inhibiting mechanism.

The third largest change was produced in the sensory threshold for electrical stimulation. The threshold was raised an average of 14

TABLE 46.—Summary of the effect of alcohol on the various experimental processes in percents.¹

Subject.	Dose.	Reflexes.				Reactions.		Mem-ory.	Far-adic thresh-old.	Coördina-tions.	
		Patellar.		Lid.		Eye.	Word.			Fin-ger.	Eye.
		R.	H.	R.	H.						
Normal subjects:											
II.....	A	-20	+165	0	+ 4	- 1	+ 1	-19	+ 5	- 7
	B	- 1	+50	-14	-17	-46	+10	-29
III.....	A	+105	-19	+20	+ 6	- 2	-12	+ 5	+ 8
	B	-23	+14	- 3	0	- 1	- 6	- 2
IV.....	A	- 19	-30	+ 6
	B	- 9	+ 68	+ 1	-43	-12	- 4	-21	+ 6	-16
VI.....	A	0	- 13	+ 4	+18	+ 9	+ 5	+ 9	-48	+15
	B	+ 6	- 37	- 1	+19	- 6	- 5	- 7	+ 6
VII.....	A	- 7	+110	-19	+26	+11	- 1	-13	-20	+11	- 3
	B	-14	+34	- 9	- 5	+ 8	+11	-10
IX.....	A	-17	- 14	-14	+38	+15	+ 5	- 4	+11	+20	-10
	B	-20	+ 47	-19	+97	-49	- 6	+19	+26	-35
X.....	A	+13	-42	-15	- 6	+ 7	-32	- 1	- 1
Average.....	A	- 6	+11	+ 5	0	0	-21	+ 9	- 3
	B	- 9	+28	-16	- 6	- 8	+10	-19
Total average.....		-10	+ 46	- 7	+19	- 5	- 3	-14	+ 9	-11
Psychopathic subjects:											
XI.....	A	- 5	+ 31	-46	+85	- 2	- 1	- 1	-12	+ 6	-11
XII.....	A	+ 7	+ 36	- 3	- 9	+15	- 1	+16	-13	- 9	-15
XIV.....	A	- 1	+ 2	- 6	-11	+ 2	+ 4	(²)	-11	- 6	(²)
Average.....		0	+ 23	-12	+22	+ 5	+ 1	+ 7	-12	- 3	-13

¹The plus and minus signs in this table must be taken in the light of their origin on the basis of our statistical conventions. We express the effect of alcohol throughout this investigation by the formula "Effect of alcohol equals the average difference on alcohol days minus the average difference on normal days" (see page 29). That is, if the effect of alcohol has a plus sign, then the average difference between the normal of the day and subsequent periods on alcohol days is greater than the average difference on normal days, *i. e.*, the alcohol tended to reduce the measurements.

²Records too few for inclusion but in the same direction as the average.

per cent, but this effect is irregularly distributed between doses A and B, showing the interaction of some new factor with the higher dose. As we have already seen, this is partially if not wholly accounted for by a modified critical demand of the subject.

Fourth in extent is the effect on coördinated movements as seen in the speed of the eye-movements, which average 11 per cent slower

under alcohol. The effect of alcohol on the eye-movements varies directly with the size of the dose.

A close fifth is the speed of reciprocal innervation of the finger, which is decreased by an average of 9 per cent.

Sixth and seventh in the list are the changes in the reaction-time of the eye and speech organs, an increase in the latent time of 5 and 3 per cent respectively.

Finally, there is practically no change at all in the memory. But our memory experiments did not include dose B.

The natural grouping of the processes with respect to the magnitude of the percentile effects of alcohol, viz, first, the two reflexes; second, the sensory threshold; third, the two motor coördinations; fourth, the two elaborated reactions; and fifth, the memory, is too consistent to be accidental. It is confirmatory evidence of the reliability of our results, that similar processes yield similar results.

It is noteworthy that 5 of the 6 processes, in which there are comparable data, show a greater average effect of the larger dose. The one exception is in the sensory threshold, where, as we have seen, the results are probably complicated by the interaction of at least two different processes.

The group of psychopathic or reformed alcoholic subjects is too small and the experimental days are too few to give data of similar reliability to that of the normal subjects. On the whole, however, it may be regarded as probable that the general effect of dose A on the reformed alcoholic is not fundamentally different from that on normals. The average effect on the lid-reflex is greater than in normals. The change in the eye-reaction and word-reaction is identical with that of normals for dose A. The effect on the Faradic threshold is consistent, and while less than the effect of dose A on normals, is more than that of dose B. The effect on the finger-movements is reversed, but the effect on the eye-movements in the two cases in which the data are complete is relatively large and in the same direction. As we shall see later, the eye-movements are of especial significance. The average improvement of the eye-reaction after dose A is similar to that of normal subjects. It is probable that the improvement has a similar basis in the two groups. The most pronounced difference between the normal and the psychopathic subjects appears in the case of the finger-movements. For this difference we have no satisfactory explanation.

Taken altogether, our data leave no doubt that alcohol shows a real difference of incidence in its effects on different levels of the nervous system of both normal and psychopathic subjects. The lower centers are depressed most and the highest least. This is entirely contrary to our traditions. But as Professor Hunt remarked in an informal discussion of these results: "If alcohol had selectively narcotized the

higher centers it would have been used as an anæsthetic centuries ago." It can not be an experimental accident that all the cerebral reaction processes, eye-reaction, word-reaction, memory, and the free-association experiments are in a class by themselves with respect to the small percentile change effected by moderate doses of alcohol. In direct contradiction to the Kraepelin contention that motor discharge is facilitated by alcohol, are the regular and self-consistent data that the simplest possible movements are much more seriously depressed by alcohol than the more distinctly intellectual processes. Kraepelin's sensory-motor schema of the effect of alcohol arose from a questionable interpretation of the complex reaction forms. It proves utterly inadequate for the facts. We believe that the incidence of alcohol on the nervous system is a much more complex problem than that simple schema would indicate.

In view of the self-consistent differences of the effect on the different levels, we must ask whether alcohol has a specific action at these different levels, or whether the differences in its action are due to a differential organization of the processes. It is to be noted that the greatest and most persistent change consequent to alcohol is in the processes which are most completely withdrawn from voluntary reinforcement and voluntary control. The higher centers alone show capacity for autogenic reinforcement. In spite of sleepiness, pain, or sensory distraction, and even narcosis, one can reëstablish the normal controls on occasion, and make a fair showing, especially when the results would be serious if one let oneself go. Indeed, there is a widespread popular belief that persons in acute alcoholic intoxication may be sobered by some unusual circumstance if the shock is intense enough. It seems to be common experience for the excessive user on occasion to struggle to remain master of himself. He finally succumbs to alcoholic narcosis only when the autogenic reinforcements fail.

There is direct evidence in the experience of our subjects that cerebral autogenic reinforcement did in fact occur to modify the effect of alcohol. One of the subjects remarked with surprise how "sleepy" he could be and yet "pull himself together" at the signal for the word-reaction. A similar phenomenon was noted in the discussion of the free association experiments, in which a subject went to sleep for a few seconds and failed to hear one stimulus word, and 10" later, after being awakened, responded normally both as to the latent time and the character of the associate word. The capacity for pulling oneself together with alternating periods of relaxation is a familiar expression of the same rhythmic reinforcement that conditions attention waves and "spurts" of various kinds. But in spite of the autogenic reinforcement, with one exception the performance after alcohol was not superior to normal. Reinforcement in these cases seems to consist chiefly of an arousal to more or less

normal performance. There is, however, one exception to this rule, and that is the eye-reaction. Here, at least, there seems to be a definite corroboration of the Kraepelin contention that the choice reaction is facilitated by moderate doses of alcohol. The case will receive our most careful attention (see pages 250 and 251).

But granting the exception as a real one, there can be no doubt concerning the general experimental depression of the various processes. With only one apparent exception (the eye-reaction after dose A), alcohol regularly tends to depress neuro-muscular action. But so does sleep. The statement of the tendency gives no clue to its physiological character. Depression of neuro-muscular action may be due to any one of a considerable variety of antagonistic conditions. The same is true of facilitation. The unanalyzed question whether alcohol effects a positive or negative increment in the capacity of the subject for any specific mental performance or group of performances is scientifically crude. We would not appear to deny the practical importance of such a question. Both morally and economically it may be useful to know whether an individual can do more or harder work after taking alcohol as a part of his food or as a condiment. But the practical capacity for effective work of any definite sort is scientifically the product of an indefinite number of interacting neural facilitations and inhibitions. In this complex and relatively unexplored interplay of psycho-physiological processes, the balance in any direction can rarely be predicted with scientific accuracy. In no single case do we know accurately either the number or the relative force of the various factors. Conversely, any specific outcome may be the resultant of an indefinite number of various configurations of the polygon of forces which may be in operation. In ergographic accomplishment, for example, a specific increase in the work done may be due to an actual increase of the available muscular energy, to a spurt, to increased interest and determination; or it may be due to decreased susceptibility to the normal inhibiting influence of muscular discomfort or pain. Similarly, a decreased reaction time may be due to increased attention, to real facilitation of the motor discharge; or it may be due to careless reaction to some accidental pre-stimulation cue that the true stimulus is about to come, or even to some arbitrary simplification of the reaction modes, such as the change from a sensory to a motor type. Only correlated data can determine which of the interacting tendencies is actually responsible for the increased output. The naïve assumptions that increased physiological action is always organically beneficent, as well as that depression of physiological action is always organically disadvantageous, are merely popular prejudices.

Let us represent in schematic form some of the possible conditions of variations in the action of an indicator consequent to the ingestion of a drug.

Apparent reinforcements of a process might be due to:

- A. Increased action at some point in the direct process.
- B. The decreased action of some inhibiting factor.

Under the first condition, *i. e.*, increased action at some point in the direct process:

1. The drug may stimulate the indicator directly. (Pilocarpin on the ciliary muscle.)
 2. It may make the indicator more susceptible to its normal stimuli. (Eserin.)
 3. It may really depress the indicator, but the depression may at first produce Frölich's¹ "scheinbare Erregbarkeitssteigerung" due to the summation of delayed processes. (Action of CO₂ and fatigue products on muscle, nerve, and nerve centers.)
 4. The drug may act on some of the central links of the neuro-muscular arc, (1) to stimulate them directly, (2) to make them more susceptible to stimulation, or (3) to produce "scheinbare Erregbarkeitssteigerung." (Caffeine on central nervous system; strychnine on the cord; CO₂ and fatigue products on central nervous system.)
 5. It may supply some condition of metabolism, *i. e.*, the drug may be a food, or, like adrenalin, may facilitate the liberation of stored foods.
 6. It may facilitate the diffusion of food or oxygen, by increased osmotic pressure, or by decreased resistance of permeable membranes.
 7. It may facilitate the distribution of food or oxygen by increasing the flow of blood. (Increased pulse-rate.)
- B. Similarly the drug may depress inhibiting or controlling mechanism in some of the ways described under depression and so facilitate the process that serves as indicator.

Apparent depression of a process might be due to:

- A. Decreased action at some point in the direct process.
- B. The increased action of some inhibiting factor.

Under the first condition of direct depression:

1. The drug may narcotize the indicator directly. (Like curare on motor-nerve endings, or cocaine on pain-receptors.)
 2. It may make the indicator more susceptible to depressing condition. (Increased fatigability after strychnine.)
 3. It may directly increase the conservative processes in the indicator by delaying metabolism. (The best example is not a drug, but cold.)
 4. It may act on some remote point of the neuro-muscular arc (1) to narcotize it directly, (2) to make it more susceptible to inhibiting stimuli, or (3) to increase in it some conservative process. (Morphine on central nervous system; unknown to writers if any drug has this specific action; extreme form in normal sleep.)
 5. The drug may destroy or render unavailable some normal food or oxygen supply. (Nerve-tissue under chloroform narcosis.)
 6. It may hinder the diffusion of food or oxygen, by decreasing osmotic pressure.²
 7. It may decrease the distribution of food or oxygen by decreasing the blood flow, or by affecting the hemoglobin, as CO.
- B. Similarly it may stimulate the inhibiting and controlling mechanism in some of the ways described under stimulation of the direct process.

Even this analysis does not exhaust the possibilities of complication; but it serves to illustrate the difficulties of the task of interpreting the meaning of any specific increase or decrease in the operation of an indicator. What we know of the physiological oxidation and pharmacology of alcohol makes it clear that some of these complications really exist in

¹Frölich, *Zeitschr. f. allg. Physiol.*, 1909, 9, p. 1.

its action. Quite apart from the question of any hypothetical selective effect, alcohol is known to be a source of energy, which some tissues at least seem able to use directly (perfused heart). Under certain conditions it is known to act as a local irritant. In large doses at least it is known to be a narcotic belonging pharmacologically to the chloroform group.

Following the general outline of problems that is indicated by our schema, the action of alcohol is first of all a problem of the resultant of its various possible effects on any given process, as a source of energy, local irritant, and narcotic. For human subjects our data seem to show rather conclusively that in the several neuro-muscular processes which we have investigated, depression overbalances all other effects of alcohol. But we are bound to ask whether the apparent depression is due to a real paralysis of some factor in the direct process, or whether in part or in whole it may not be due to the stimulation of inhibitory mechanisms. In either case we must inquire further whether the effect is peripheral or central; that is, whether the alcohol directly affects the end links in the neural chain, or whether it affects coordination processes in nervous centers. Finally, since the activity of nervous tissue as a whole is modified by the interaction of other tissues, a complete account of the action of alcohol on any given indicator involves the coordinate action of alcohol on all the several processes that may influence the indicator or the central nervous mechanism that operates it.

This final problem will not be solved until the whole alcohol program is completed. But in the systematic interrelation of the processes which we have measured, as well as in the variation of the dose, we hoped that our present data would permit some definite contribution to the final solution. With the total problem in mind, our first task is to scrutinize our data for whatever indication they may give with respect to the fundamental interpretative question as to whether or not the apparent depression is due to a stimulation of inhibitory mechanisms. The second question that we must face is as to whether the alcoholic depression may not be regarded as conservative or recuperative. Thirdly, we shall look for a possible interrelationship of the processes through differences in their temporal incidence, and finally, we shall inquire which of the various effects which we have measured represents the central tendency most completely. This should not only show us something of the general reliability of the measurements for the estimation of personal differences; it should also indicate whether the effects of alcohol are predominantly sensory, motor, or central.

EVIDENCE FOR ALCOHOLIC STIMULATION.

There is in the scientific literature concerning the effect of alcohol a large body of experimental evidence that, like the mass of common non-experimental experience, seems to point to an initial neuro-muscular excitation, resulting from small or moderate doses of alcohol (school of Binz¹). Thus in excised muscles, the work of Scheffer² and of F. S. Lee³ and his collaborators seems to have demonstrated that a small amount of alcohol "is capable of augmenting the work of a skeletal muscle." Increased excitability after alcohol was found in frog nerves (Mommensen,⁴ Efron,⁵ and Breyer⁶). The reinforcing action of alcohol on the exhausted perfused heart may be regarded as demonstrated (Loeb,⁷ Wood and Hoyt,⁸ and Dixon⁹). The reaction experiments by Kraepelin and various ergographic studies are commonly cited in support of a short stimulatory effect of moderate doses on the central nervous system. Evidence is not wanting, on the other hand, that much of the augmenting effect of alcohol is really due to secondary or remote effects (school of Schmiedeberg,¹⁰ Bunge,¹¹ *et al.*). The most carefully controlled ergographic work of Rivers¹² is entirely negative. In our own material, the chief evidence for neuro-muscular excitation is found in the latent time of the eye-reactions. They alone show consistent improvement after the smaller dose of alcohol. In 4 out of 5 available cases the result of alcohol was facilitation. The greatest individual improvement was 15 per cent. The average improvement for the group was 5 per cent. Similarly, for the psychopathics, 2 out of 3 cases show decrease in the latency of the eye-reaction as a result of the smaller dose of alcohol. The facts are clear enough. It is no argument against them that they are unique in our experiments. But it should not be forgotten that 15 c.c. more of alcohol, *i. e.*, a dose of 45 c.c. conditioned a delay in the eye-reaction three times greater than the improvement produced by the smaller dose. The average result of both alcohol doses on the eye-reactions is to lengthen their latency about 5 per cent.

But it would be unjust to our data and to our problem to consider only the general average. Exceptions to a general tendency, provided they are genuine, are theoretically as important as the generalization.

¹Binz, Grundzüge der Arzneimittellehre, Berlin, 1901.

²Scheffer, Archiv f. exp. Path. u. Pharm., 1900, **44**, p. 24.

³Lee and Salant, Am. Journ. Physiol., 1903, **8**, p. 61; Lee and Levine, Am. Journ. Physiol., 1912, **30**, p. 389.

⁴Mommensen, Virchow's Archiv, 1881, **83**, p. 273.

⁵Efron, Archiv f. d. ges. Physiol., 1885, **36**, p. 467.

⁶Breyer, Archiv f. d. ges. Physiol., 1903, **99**, p. 481.

⁷Loeb, Archiv f. exp. Path. u. Pharm., 1905, **52**, p. 459.

⁸Wood and Hoyt, Mem. Nat. Acad. of Sci. (pub. 1905), 1911, **10**, p. 39.

⁹Dixon, Journ. Physiol., 1907, **35**, p. 346.

¹⁰Schmiedeberg, Grundriss der Pharmakologie, Leipsic, 1902.

¹¹Bunge, Lehrbuch der Physiologie des Menschen, Leipsic, 1905, 2d ed.; Die Alkoholfrage, Leipsic, 1887.

¹²Rivers, The Influence of Alcohol and other Drugs on Fatigue, London, 1908.

While they do not affect the general tendency, they do save generalizations from the error of artificial simplicity. We are consequently under a double obligation to examine in some detail the apparent exception to the main tendency of our results.

In discussing our eye-reaction technique, we found some grounds for dissatisfaction owing to the limited number of positions for the peripheral object of regard, and the consequent possibility of anticipatory reactions. The same fault will be found (p. 89) to have produced an unexpected practice effect in the eye-reactions on normal days. We can not agree with a supposititious critic who, on the ground of this practice effect, might hold that the eye-reaction fails to fulfill our demands for a thoroughly practiced experimental process. That which is thoroughly practiced in this reaction is, however, the differential coördination of the eye-muscles to bring the line of regard to any one of an indefinite number of positions. Our experiment was an artificial simplification of natural conditions. Instead of an indefinite number of possible positions we used only 6. Apparently all our subjects learned by experience during the experiments to respond to one of the 6 new positions more rapidly than they were in the habit of responding to an indefinite number. Doubtless this should have been foreseen in planning the experiment. In excuse one can only say that the data on normal eye-movements are not very abundant and the particular point had never arisen before. Dodge¹ had found that in the course of over 10 years of eye-reaction records his eye-reaction had not materially changed and we failed to realize that in his experiments a great variety of positions were used. It is not impossible that indefinite variation of the eye-reactions would have been open to more serious criticism because of lack of uniformity on the different experimental days. After all, as far as the main results are concerned, a moderate practice effect is not serious. It was provided for by the distribution of normal days. This type of reaction gave comparable values for all sorts of untrained subjects, and the effect of repetition is clearly represented on the normal base-line.

Our facilitation-inhibition problem, however, gives the possibility of simplified elaboration of reaction a more serious aspect. We may indicate its bearing by a question: "What would have happened if we had still further simplified the motor elaboration of the eye-reaction by reducing the number of stimulus positions to one instead of six?" The answer to this question we know from accidental experience. Such simplification would have led to frequent if not to regular anticipatory reactions. The voluntary control of our eye-movements is meager at best. If we know where an object is about to appear it takes a great deal of practice and an entirely artificial inhibition to prevent looking at the expected place. The artificial development of such inhibitions

¹Dodge, Monograph Supplement of the Psychol. Review, 1907, No. 35.

would have produced a most unnatural reaction type. Similarly, by analogy with all known "choice" reactions the simplification of the possible modes of reaction from infinity to six would also tend to reduce the reaction time. Now it is not inconceivable, and indeed, from the numerous indications of our experimental results, it seems probable, that the more elaborate controls often suffer earlier than the function itself. This tendency appeared in the highly inhibited reflexes (Subjects X and IV), where the inhibition suffered first. It appeared in the memory experiments of Subject VII, when the complex associative "story" suffered far more than simple perseveration. Indeed, the suppression of distraction in one instance seemed to aid the perseveration process. This tendency appeared also in the threshold to Faradic stimulation, where alcohol disturbed the subject's caution and produced more numerous false reactions, *i. e.*, reactions when there were no stimuli. The more exact elaboration of the motor response which brings the eye to a new point of regard in a single sweep also involves a complex control, and less careful elaboration would permit a quicker response.

Whether or not the eye-movements after 30 c.c. of alcohol are in fact less accurately adjusted than normal could be finally settled only by experimental measurement. But unfortunately spatially quantitative techniques would be vastly more exacting than our temporally quantitative technique. It is somewhat doubtful if it could be applied indiscriminately to untrained subjects, such as those with whom we dealt. However that may be, the records at hand were not taken with spatially quantitative results in view. Consequently our results may not be directly interpreted in spatial terms. But in the absence of direct measurements it was obviously necessary to bring whatever indirect evidence we possessed to bear on the problem of the apparent exception.

It is not without significance that under almost identical circumstances of a complex "choice" reaction in the process of training, Frankfurter¹ found typewriting errors enormously increased by alcohol, while the speed was occasionally increased (*cf.* his 41st day, pp. 436-437). His introspection is not irrelevant (p. 455): "I had the feeling that the fingers ran faster than I could find the right spot for the stroke. I often struck keys against my will, so that I must voluntarily inhibit the movements in order not to make a mistake at every letter."²

There can be little doubt that even in small experimental doses along with and as a part of the general depression we have clear indications of a paralysis of inhibitory or controlling factors. These may on occasion suffer greater relative depression than the direct process, as in the pulse. When this depression of controls is combined with a reinforcement caused by the experimental instructions, suitable conditions are provided for the slight reinforcements of reactions that rapidly pass over into

¹Frankfurter, *Psychol. Arbeit.*, 1914, 6, p. 419.

²Translated by authors.

depression with slightly larger doses. It seems probable, too, that we have herewith come upon the grounds for a wide variety of effects which are commonly observed in the social use of alcohol, when circumstances give the reinforcement and alcohol reduces the inhibitions.

Whatever may be the effect in isolated tissue, our data give clear and consistent indications that the apparent alcoholic depression of neuromuscular processes is a genuine phenomenon that can not be reduced to the excitation of inhibitory processes; but that, conversely, whenever apparent excitation occurs as a result of alcohol it is either demonstrably (pulse-rate, reflexes, memory, and threshold) or probably (eye-reaction) due to a relatively overbalancing depression of the controlling and inhibitory processes.

IS ALCOHOLIC DEPRESSION A CONSERVATIVE PROCESS?

One factor in our related group of measurements was expressly introduced for its indication of general physiological conditions. That factor is the pulse-rate. There are grounds for believing that the pulse-rate is the best index of the general metabolic demands that is available in psychological experiments (Dodge¹).

It would doubtless be better if the psychological experiments could be carried out coincidentally with respiration experiments, or some other means for determining total metabolism during the mental activity. Such an arrangement, however, would present the greatest technical difficulties both from the standpoint of the psychological experiments and from the standpoint of total metabolism experiments. With respect to the psychological experiments, it would be a questionable procedure to add the insistently obvious and not too comfortable attachments for respiration experiments in the expectation of getting natural psychological reactions. With respect to the metabolic experiments, it would not be easy to arrange a technique to measure the differential metabolism for the few minutes that are involved in the psychological experiments. Probably both difficulties could be overcome by sufficient sacrifice of time and money, but the satisfactory simultaneous operation of the two elaborate techniques would always be a difficult task. Fortunately for provisional experiments, at least, there are scientific grounds for believing that changes in general metabolism are indicated by the pulse-rate.

The experience of the Nutrition Laboratory in its studies of the relationship between pulse-rate and metabolism is best expressed by the following quotations:

“A comparison of this pulse-rate with the total heat-production shows a striking uniformity in fluctuations and similar comparisons with other experiments show in nearly every instance a parallelism.”²

¹Dodge, *Psychol. Review*, 1913, 20, p. 1.

²Benedict, *The Influence of Inanition on Metabolism*, Carnegie Inst. Wash. Pub. No. 77, 1907, p. 488.

"In the course of experiments it has been observed that with very slight activity the pulse and the metabolism are at a minimum. When the activity is increased, the pulse-rate is likewise accelerated, and there is an increase in the total metabolism. It has furthermore seemed clear that the increase in the pulse-rate is relatively proportional to the increase in the actual muscular activity observed." (Benedict and Carpenter.¹) Again (p. 249): "Pulse-rate increases during the waking hours of the day as compared with the night. We can obtain an approximate idea of the total metabolism from the pulse-rate of a subject, although the rate per minute of itself is not necessarily a general index of the katabolism for all individuals."

Still more recently Murlin and Greer² wrote:

"Experiments on dogs were devised in which the absorption of oxygen and the output of carbon dioxide were determined by means of a small Benedict respiration apparatus attached directly to the dog's trachea. Simultaneously the blood-pressure was recorded. The effects of anesthesia were controlled. Similar experiments on several different men in widely different nutritive conditions and in varying degrees of muscular activity (lying on a bed, standing, standing and lifting weights, shivering, etc.) were also done by means of the same respiration apparatus and the Erlanger sphygmomanometer. The results show a fairly close correlation in the same individual between the heart-output expressed as the product of the pulse-pressure and the heart-rate on the one hand, and the absorption of oxygen and the elimination of carbon dioxide on the other. The relation between carbon-dioxide elimination and heart-action is on the whole a little more constant than that between the oxygen absorption and heart action."

Quite recently observations by Professor H. M. Smith, of the Nutrition Laboratory, have shown that during walking the metabolism may increase 250 per cent without any increment in pulse-rate. This striking exception to the rule makes us very cautious in drawing unsupported inferences from the pulse-rate to metabolism, in spite of the fact that all the other experience of the Laboratory is to the effect that increased muscular activity correlates with an increased pulse.

The existence of some intimate connection between pulse and mental states is a commonly accepted fact of great antiquity. Mosso³ and his followers found in the relative distribution of the blood to the brain and other parts of the body a measure of mental activity. Seriously controlled attempts to correlate definite circulatory changes with definite mental processes find their most important expression in the work of Lehmann.⁴ An enormous amount of data still leaves the question open whether any specific mental state can be absolutely correlated with any specific change in pulse or respiration, in the sense that the one can be inferred from the other. Indeed, in our knowledge of the nervous conditions of vasomotor innervation there seems to be no good reason for definite correlation with specific cerebral processes. That

¹Benedict and Carpenter, *The Metabolism and Energy Transformations of Healthy Man during Rest*, Carnegie Inst. Wash. Pub. No. 126, 1910, p. 248.

²Murlin and Greer, *Am. Journ. Physiol.*, 1910-11, **27**, p. xviii.

³Mosso, *Ueber den Kreislauf des Blutes im menschlichen Gehirn*, Leipsic, 1881.

⁴Lehmann, *Die körperlichen Aeusserungen psychischer Zustände*, Leipsic, 1899-1905.

the circulatory system responds with great delicacy and complexity of adjustment to waves of nervous excitation is an empirical fact. But the mechanism of those adjustments is as little known to us as the nervous conditions of thought itself. As mere expressions of mental states they probably have no peculiar analytic function in psychology which may not equally well be assumed for a considerable number of involuntary muscles and glands.

The biological function of the circulatory system, however, gives it a unique connection with the nervous as well as with the muscular activities of the body. Since the blood-currents supply the conditions of all metabolism, in any adequately organized body within the limits of physiological efficiency there must be a general correspondence between need and supply. This theoretical assumption is borne out by the experimental evidence. Muscular activity in any part of the body almost immediately increases the heart-rate over the rate during relaxation. In any individual under normal circumstances, the heart-rate is more or less closely proportional to the amount of activity.

Apparently for considerable periods of sustained work the correspondence between metabolism and the heart-rate is much closer than for short periods. Grounds for the unreliability of short periods are easily discoverable. The biological correspondence between need and response can not be a coördinate or a preliminary adjustment. No automatic vasomotor or cardiac excitation could be based on prophecy of action without the need of constant readjustment. No adjustment could be based on the actual need without a certain lag of latent time. So whatever the mechanism, whether one of preparation or one of reaction, we would expect oscillatory variations about the line of actual need. This gives rise to a serious limitation of the use of heart-rate as an indicator of metabolism in mental activity. To assume that the intense disturbances of short duration that occur in emotion exactly correspond to metabolic demands would be unwarranted by any of the present evidences of correlation. It is not impossible. Since the emotions represent moments of active readjustment, there is some ground for suspecting that they will make their own peculiar demands on metabolism. But correlations are matters of fact, not of probability. A direct study of metabolism would seem to be a desideratum in the dynamic psychology of the emotions. Similarly, to assume that every change in the heart-rate is significant of some definite though uncleared mental state would be unwarranted. Lehmann some time ago abandoned his early supposition to this effect. The rhythmic changes in heart-rate due to respiration give an illustration of the danger of attempting to isolate short intervals experimentally.

Furthermore, the pulse-rate never gives direct and absolute values—only relative and comparative. The pulse of muscular work is commonly known to be both larger and faster than that of muscular relaxation. The amount of acceleration produced by any given quan-

tity of muscular work is a purely individual matter and varies within wide limits in different individuals. It is a significant factor in the organic personal equation of the individual. At different times and under different conditions of health the pulse of the same individual shows changes of excitability. But, other conditions being constant within the same organic equation, two different kinds of work giving rise to the same pulse conditions may be provisionally expected to be physiological equivalents. Conversely, if the kind of work remains the same, difference in the pulse in successive experiments will indicate subjective changes.

Such subjective changes are clearly shown in our records in the adaptive process, as indicated by the pulse during the association experiments. That the same moderate physical activity is accompanied by a higher pulse-rate after alcohol is abundantly proved by our pulse-records. Still more significant is the fact that notwithstanding depressed neuro-muscular action the pulse-rate is uniformly higher for the same kind of mental work after alcohol than it is without it. It does not seriously modify the meaning of the correlation if we should abandon the probable but debatable implication of increased metabolism for a given amount of mental work. Even if it should prove true that the local action of alcohol on the circulation centers disturbed the normal correlation between metabolism and the heart-rate, the fact of increased heart-rate for a given kind and amount of mental work absolutely prohibits us from regarding the neuro-muscular depression incident to alcohol as a conservative process like sleep.

TEMPORAL INCIDENCE OF THE EFFECT AFTER THE INGESTION OF ALCOHOL.

The beginning of the effect of alcohol on our measurements is found within the 30-minute period after ingestion. Our experiments were not designed for a closer approximation. It is doubtful if, with our present techniques, the problem of a differential beginning of the effects of alcohol can be investigated profitably, since the first relatively slight effects will be obscured by, or confused with, the normal accidental variations. The beginning of the effect of alcohol will probably be studied in the future as in the past on some particularly favorable indicator. As will appear later in this chapter, of all the techniques which are used in this investigation, the eye-movements are not only the most consistent for the entire group, but they correlate most closely with the average results for each individual, and can be repeated indefinitely without significant practice effects. Of all our measurements they are consequently the most likely to show the beginning of the effects of alcohol. That, however, is a problem for the future.

In addition to the fact that the beginning of the effect of alcohol occurs within the first period, our present data show that the maximum effect and the beginning of recovery usually occurs within the 3-hour

session. The incidence of the maximum effect appears to differ somewhat for the different processes, as is shown in table 47.

The general time of incidence of the maximum effect of alcohol, as shown by table 47, is surprisingly uniform within the limits of the half-hour periods in which the measurements were repeated. While there are apparently some individual differences, the averages show considerable uniformity. The most conspicuous exception to the average incidence is found in the case of the eye-movements. The alcoholic disturbance, as shown in these most complex of the coördination processes which we attempted to measure, increased up to the last period of the session. This disturbance of the eye-movements may partially account for the subjective impression of several of our subjects that they found it less easy to study effectively during the evening after an experimental session when dose B was given. In general it appears that the

TABLE 47.—*Time of incidence of the maximum depressive effect of alcohol.*
[Values in minutes after ingestion of alcohol.]

Measurement.	Time.
Patellar reflex:	
Reaction time.....	95
Extent of contraction.....	65
Lid reflex:	
Reaction time.....	90
Extent of contraction.....	100
Eye-reaction.....	90
Word-reaction.....	95
Faradic threshold.....	100
Finger-movements.....	100
Eye-movements.....	120

reflexes begin to recover first. It would be an easy hypothesis that the more primitive processes should show the earliest recovery. On the other hand, in the intricate interconnection of neural processes which we must take into account, it would be uncritical to assume that the relatively early maximum effect of alcohol on the reflexes and a consequent relatively early commencement of recovery is really an indication of particularly rapid recuperation of the reflex arcs from the effects of alcohol. It is not impossible that the partial recovery of sensitivity of the lower is due to the increasing paralysis of the higher centers. It is physiological commonplace that reflexes are quicker, more pronounced, and more regular when the lower centers are freed from the inhibiting action of the higher. Against this hypothesis, however, is the fact that the knee-jerk is depressed or lost in sleep, notwithstanding the extreme depression of the cerebral processes. Conversely, mental excitement commonly increases the amplitude of the jerk. Mere attention to the process may reinforce it. Direct evidence that might decide the question as to the conditions of the variation in incidence in our experiments is entirely lacking. It is doubtful if it can be

produced without operative technique. But whatever may be found to be the conditions, it seems to be of considerable theoretical and practical importance that the lower reflex centers begin to recover from the depressive action of moderate doses of alcohol while the disturbance of the more complex coördinating centers is still increasing.

It is an important psycho-physiological question whether alcohol effects permanent residual modification of any neuro-muscular processes in the direction of the original disturbance or not; and if not, whether the subsequent recovery just reaches the normal base-line or crosses it. This question is directly related to the problem of tolerance, increased susceptibility, and secondary reactions to the alcoholic dose. It is also related to the theoretical question of the consequences incident to the disturbance and the permeability of the limiting membrane of the cell and the solution of lipid substances (Meyer¹ and Overton²). Minute permanent lesions, if they exist as the consequence of a small dose of alcohol, could scarcely be detected by any available technique. They would be swamped by uncontrollable accidental variations incident to other conditions of development and by the inevitable environmental changes. That permanent anatomical and physiological changes may and do follow long-continued use of even moderate doses of alcohol seems to be supported by a mass of clinical and experimental evidence. Such permanent changes, however, are certainly not uniformly in the direction of the immediate changes produced by alcohol. Excessive patellar reflexes, for example, are not uncommon in confirmed alcoholics. Unfortunately our experimental sessions did not last long enough to follow any of the recovery processes to their base-line. This is another of our unsolved problems. However, two indications in our data are relevant. First, the refractoriness of the lid-reflexes is inversely proportional to the decrease in the initial response after alcohol. In view of the demonstrated relationship (Verworn³) between refractoriness and fatigue, the depression of reflex processes as the result of alcohol can not be regarded as due to exhaustion of available material, but chiefly to a decrease in its immediate accessibility. The alcoholic effect is, then, not due to exhaustion, but to decreased irritability. It is consequently a plausible expectation that in all fatiguing experimental processes the recovery after alcoholic depression should give relatively better results than the normal values after a corresponding period of relatively more fatiguing maximum responses. There are indications in ergographic experiments that something of this kind is true. In our own experiments, something of this sort was found in the finger-movements. Even the fatigue of the 3-hour experimental session without exhausting work may properly be expected to

¹Meyer, *Archiv f. exp. Path. u. Pharm.*, 1899, 42, p. 109.

²Overton, *Studien über die Narkose*, Jena, 1901.

³Verworn, *Erregung und Lähmung*, Jena, 1914.

show similar results in some cases at least. The difference between the beginning of recovery of the simple reflexes and of the complex coördination processes is again relevant. While the first effects are not so great in the case of coördinations, they are more persistent, and the probability of their passing their base-line in recovery would seem to be less. Moreover, it is in the direction of coördination of nervous processes that one would reasonably expect the most serious and lasting effects in the higher mental processes.

There is no measurable difference in our records between the incidence of the maximum effect after the smaller and after the larger dose. Under comparable conditions the maximum effect came earlier after dose B in approximately the same proportion of instances as after dose A.

EFFECT OF REPETITION ON THE VARIOUS MEASUREMENTS.

The effect of repetition on the various measurements is a matter of some interest in forming an opinion of the applicability of the various techniques for untrained subjects. The relevant data are given in tables 48 and 49.

From tables 48 and 49 it appears that the latent time of the reflex lid-movement shows the smallest average percentile change of all the comparable processes as a result of repetition. It is not zero for any individual, but in this case, as in the general interpretation of our data, we must not lose sight of our statistical principles that individual variation must be expected from numerous interacting tendencies. Only in the group or in a considerable number of cases may these accidental variations be expected to neutralize each other and disclose the systematic or experimental change.

The extent of the reflex lid-movement, on the other hand, decreased more than any other measured phenomena, especially in the psychopathic subjects. The general apprehensiveness of the psychopaths on their first day in the laboratory would have given us a reasonable ground for this change on the plausible, though unproved, assumption that the protective reflexes would be increased in activity if the mental "set" were in the direction of suspicion and fear. Partridge¹ held that a diminished lid-reflex after alcohol was entirely accounted for by the increased indifference of the subject. In the present case, however, this ground becomes most problematical, inasmuch as the lid-reflex was not measured until the third day of the series, when the apprehensive attitude of the subjects had largely subsided. But as the data stand it is doubtful if the two can be wholly divorced.

The second smallest percentile effect of repetition in the main group of subjects appears in the case of the word-reactions. This is a striking confirmation of our previous experience and theoretical expectation, to the effect that in the case of reading familiar words the few repetitions

¹Partridge, *Studies in the Psychology of Intemperance*, New York, 1912.

of the experimental session would be a relatively insignificant addition to the sum of past experience. In only one subject does the effect of repetition approximate 10 per cent in this measurement, and that is the case of Subject VII, a native German with noticeable limitations in his use of English.

Practically as satisfactory in this respect for the main group of subjects was the reciprocal innervation of the finger. Its average practice change in these experiments was 4 per cent.

TABLE 48.—*Effect of repetition on the various measurements. (Normal I minus Normal II.)*
[σ equals 0.001¹.]

Measurement.	Normal subjects.						Average effect.	Per-centile effect.
	II	III	IV	VI	VII	IX		
Lid-reflex:								
R' (σ).....	+ 8	- 3	- 3	- 6	+ 6	+ 4	0	0
H' (mm.).....	- 8.1	+ 5.7	+ 0.7	+12	0	+ 4.8	+ 2.5	+17
Eye-reaction (σ).....	+45	+14	+16	+13	+14	+ 37	+23	+11
Word-reaction (σ).....	-31	+17	+29	+18	+19	+ 43	+16	+ 3.5
Threshold for Faradic stimulation (in Z units).....	- 3	- 1	+53	+50	+21	+115	+39	+12
Finger-movements ¹	+ 2.8	+ 1.0	- 0.7	+ 1.1	+ 0.2	+ 4.2	+ 1.4	+ 4
Eye-movements (σ).....	- 8	- 5	-20	-28	- 3	- 23	-14	- 7
Measurement.	Psychopathic subjects.			Average effect.	Per-centile effect.			
	XI	XII	XIV					
Lid-reflex:								
R' (σ).....	+ 4	+ 2	+ 5	+ 4	+10			
H' (mm.).....	+ 0.9	+ 1.8	+ 7.6	+ 3.4	+80			
Eye-reaction (σ).....	+ 31	-20	+28	+13	+ 6			
Word-reaction (σ).....	- 7	+ 3	-10	- 5	- 1			
Threshold for Faradic stimulation (in Z units).....	-114	+40	+15	-20	- 4			
Finger-movements ¹	- 2.9	- 1.1	- 7.7	- 3.9	-11			
Eye-movements (σ).....	- 26	-13	0	-13	- 7			

¹Number in 6 seconds.

TABLE 49.—*Order of the measurements with respect to the effect of repetition with normal subjects.*

Measurement.	Basis of measurement.	Percentage effect (Normal I - Normal II).
Lid-reflex.....	Latency.....	<i>p. ct.</i> 0
Word-reaction.....	Latency.....	+ 3.5
Finger-movements.....	Number.....	+ 4.0
Eye-movements.....	Duration.....	- 7.0
Eye-reaction.....	Latency.....	+11.0
Faradic threshold.....	Z units.....	+12.0
Lid-reflex.....	Extent.....	+17.0

The most consistent effect of repetition, though not the least, appears in the case of the eye-movements. Its direction, however, is reversed. That is, instead of being shortened by repetition, as one might expect, the average duration of the eye-movements is increased 7 per cent in both normal and psychopathic subjects from the first to the last normal day. There are no published data which would have led us to expect this apparent reversal of practice. Its probable explanation is to be found in the increased accuracy of the eye-movements of 40° after practice in looking from one fixation-point to the other. Since the errors of fixation are due in general to an underestimation of the distance, and are commonly corrected by positive corrective movements in the same direction as the main eye-movement, the practice that results in increased accuracy of movement would produce longer arcs of movements. But longer arcs of eye-movement regularly take longer times. That something of this sort actually did take place is indicated by the record of decreased length in the corrective movements which is found in the full tables. Making allowance for these changes in the arc of movement it appears that the actual angle velocity of the eye-movements is practically free from practice effect during our experiments.

The effect of repetition on the eye-reactions is relatively large. This appears not only in a comparison of the first and last normal days, but also in the relation between normal and alcohol days. If one notes the following summary of eye-reaction averages, it will be seen that the gradual decrease of latency appears quite independent of the alcohol dose.

	Normal I.	Dose A.	Dose B.	Normal II.
Av. . . .	0.216"	0.206"	0.201"	0.193"

These results were unexpected. Previous experiments with the ocular reactions led us to expect no effect of repetition. Theoretically it seemed to us that the long training of practical life would make the relatively small number of laboratory cases entirely insignificant. The cause of the discrepancy between our expectation and the results in this case is probably to be found, as we have already noted, in the small number of positions for the eccentric visual stimuli to which the eyes moved. The effect of repetition in this case constitutes probable cause for an effort to improve the technique. If it is finally found to be expedient, it should not be difficult to arrange apparatus so that each peripheral stimulus should occupy a different position in the field of vision. The reduction of the number of positions to 6 in the present experiments was made to gain uniformity of succeeding series. It was not necessary and possibly it was not expedient. Given the effect of repetition, it is not surprising that the first alcohol day should show a marked improvement in the reaction-time after the first series. Such an improvement would follow the general rules of habit formation. In our case it would work directly opposed to such a depressing influ-

ence of alcohol as we might reasonably expect from other tests. That in spite of this repetition effect dose B shows a unanimous depressing effect of alcohol as measured by the differences, giving an average of 14.5 per cent, is all the more striking. So, as we have already pointed out, the 5.36 per cent shortening of the reaction time after dose A must not be regarded uncritically as a reversal of the sign of the effect of a small dose. It is due in part at least to the position of the experiment with dose A in the group of repetitions. From all the data taken together it is clear, however, that the effect of 30 c.c. of alcohol on the eye-reaction time must be exceedingly slight.

The relatively large average difference between the two normal days in the threshold for Faradic stimulation (Z values) is less easily explained. It is probably not so much an average effect of repetition as it is a result of gross change in a single individual (Subject IX). Into the conditions that govern the changes in the threshold to Faradic stimulation we have too fragmentary an insight to venture a hypothesis in this case. We have already seen that changes in the degree of assurance which is demanded by the subject may seriously influence the apparent results. The influence of other mental or physiological factors are evident in the daily rhythm. Effects of fatigue or the disturbance of accidentally distracting noises are difficult to eliminate or to equalize.

As compared with the measurements on which most of the classical work on the effect of drugs has been done, all of our measurements show conspicuously little effect of practice. Least affected are the latency of the lid-reflex and the angle velocity of the eye-movements.

CORRELATION OF THE VARIOUS MEASUREMENTS WITH THE AVERAGE.

Of practical as well as of theoretical interest is the question which of the various measurements shows the closest correspondence with the average performance of the various subjects. This is of importance, in the first place, in the effort to estimate the relative value of the different measurements as an indicator of individual differences. It is of importance, in the second place, as an indicator of the central tendency of the effects of alcohol, if there is any such thing. In table 50 we give the variations of the several normal subjects from the average of the group in the several kinds of measurements.

A plus sign (+) before a value in table 50 shows that the individual's performance in that test after alcohol varied in the same direction as the average of the group, but more in amount. Conversely, a minus sign (−) shows that the individual's performance after alcohol showed less change than the average of the group or that it was in the opposite direction. Thus the signs of the values entered opposite Subject II show that in all but two tests the effect of alcohol was greater on this

subject than on the average of the group. Subject III, on the other hand, was affected by alcohol less than the average of the group in all but one case. On this basis it would be possible to arrange our normal subjects in a series according to their susceptibility to the depressing effects of alcohol. The total position of each individual with respect to the average of the group is shown in the extreme right-hand column.

The several values may be regarded as an index to the personal equation of each subject with respect to the particular process which is involved. The value at the extreme right thus becomes a sort of alcohol coefficient of the individual. Of course these particular values are entirely relative, *i. e.*, relative to the rest of the group and to the kind of measurements. But if the number of subjects and the kinds of measurements were sufficiently numerous the deviation of the individuals from the average would approximate a true coefficient. It seems

TABLE 50.—Variations from the average measurements shown by the individual subjects as calculated from the percentile effects of alcohol.

Subject.	Patellar reflex.	Lid-reflex.	Eye-reaction.	Word-reaction.	Memory.	Faradic thresh-old.	Finger-movements.	Eye-movements.	Average.
II	+10	- 7	+ 9	+6	+ 5	+18	- 2	+ 2	+5.1
III	+16	- 6	-1	- 8	- 9	-14	-3.7
IV	- 5	- 8	+ 7	+1	+11	- 3	+ 5	+1.1
VI	-13	- 6	- 6	-3	+ 8	+12	+ 1	-1.0
VII	- 3	+ 7	- 6	+1	-13	0	+ 2	- 5	-2.1
IX	+ 8	+12	+ 7	-2	- 5	-29	+14	+11	+2.0
X	-20	+10	+3	+ 6	+18	-10	-10	-0.4

to us that we are already justified in using our average percentile effects of alcohol as a provisional standard for the estimation of the susceptibility, not only of our present subjects, but as well of those subjects that may serve in later tests. For such a comparative estimate, however, it would be of great advantage if there were some process whose measurement might be taken to represent the average without the laborious and time-consuming measurements of our entire series of tests. In the effort to discover if any of our values would qualify for such a purpose we have plotted the various values of table 50 in figure 32.

Doubtless the first impression from figure 32 is that the several values are quite irregular and unrelated. A more careful inspection, however, will show that there is a fairly close correspondence between the curves for similar kinds of measurement, especially for the reciprocal innervation of the finger and that for the velocity of the eye-movements. Furthermore, both of these curves resemble more or less closely the curve for the total results. These three curves are not identical. One could scarcely expect that, even if they were curves of the same identical process. But the eye-movement curve is sufficiently similar to the

curve for the total results so that subjects above the average and below the average are identical in both. Moreover, the values below the average are closely proportional in both. Taken together with the similarity of the total percentile effects of alcohol on the finger and eye movements, these resemblances can not be accidental. They strongly suggest the possibility that the percentile effect of alcohol on the eye-movements might be made to serve a very practical end as the best available test of the susceptibility of the individual to the effects of

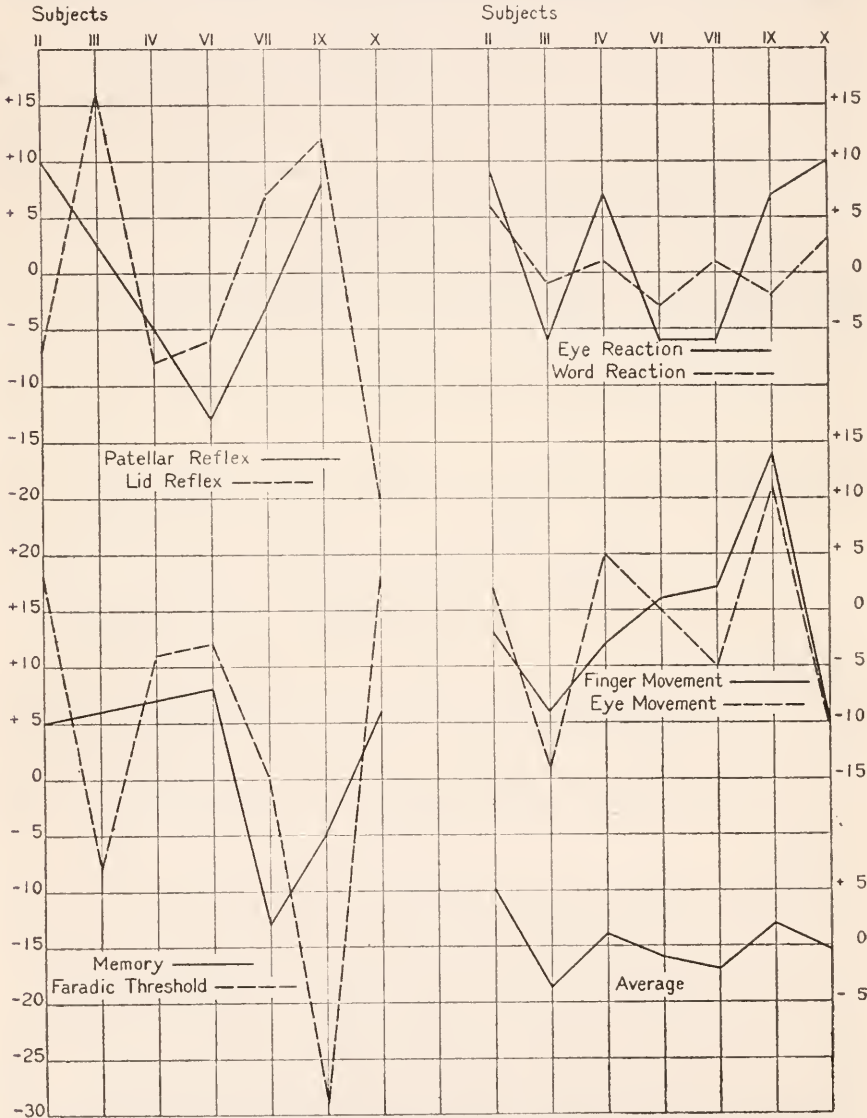

FIG. 32.—Variations of the normal subjects from the average of the group for various measurements.

alcohol. That finger-movements would be serviceable in considerably less degree for a general test, when for any reason the eye-movements were not available, is obvious if one remembers the gross differences in the pre-experimental practice of the finger-movements of different individuals, and the relative ease with which they can be arbitrarily modified. In every respect we believe that the eye-movements are the most reliable and the most important measurements of the group. They are least open to arbitrary modification, vary directly with the dose of alcohol, come closest to the total average of all the tests, cover the most general characteristics, and come nearest to being a true test of the individual's susceptibility to the effects of alcohol.

Aside from the practical value of this correspondence between the effects of alcohol on the coördination processes and the average effects, it has a rather far-reaching theoretical implication. If, in all the diverse processes which we have measured, the coördination processes represent a central numerical tendency, it must be that they correspond in some closer way than the rest to a real central tendency of the alcohol effect. It would seem to indicate that the alcohol change in the average performance of our subjects is a function of central coördination. If this indication is substantiated by later investigations it should prove to be not only of the utmost importance for an understanding of the various manifestations of the effect of alcohol in individual cases and for the general phenomena that accompany its excessive use, but it would throw a flood of light on the complex organization of normal psychophysical processes, as well as on the effects of fatigue and other depressing agents.

NUTRITION LABORATORY OF THE
CARNEGIE INSTITUTION OF WASHINGTON,
Boston, Massachusetts, May, 28, 1915.

APPENDIX I.

REPRINT OF THE TENTATIVE PLAN FOR A PROPOSED INVESTIGATION INTO THE PHYSIOLOGICAL ACTION OF ETHYL ALCOHOL IN MAN. PROPOSED CORRELATIVE STUDY OF THE PSYCHOLOGICAL EFFECTS OF ALCOHOL ON MAN.

[Nutrition Laboratory, Carnegie Institution of Washington, Vila Street,
Boston, Mass., U. S. A., January 1, 1913.]

PROPOSED TENTATIVE PROGRAM FOR AN INVESTIGATION OF THE PHYSIOLOGICAL EFFECTS OF ALCOHOL TO BE CARRIED OUT IN THE NUTRITION LABORATORY OF THE CARNEGIE INSTITUTION OF WASHINGTON, BOSTON, MASSACHUSETTS.

It is a well-established fact that ethyl alcohol, when taken in small doses, the total amount per day not exceeding 75 grams, is completely oxidized in the body and thereby replaces nutrients as a source of energy. This fact suggests a large number of experimental problems in the domains of physiology and physiological chemistry which, when studied by the newer methods, should give results of fundamental importance. The calorimetric researches of Professor Atwater and his associates in Middletown, Connecticut, were extended over long periods, usually of 24 hours. The evidence regarding the rapidity of the combustion of alcohol is very uncertain and it therefore seems desirable to again study this source of energy and to determine if possible its relation to severe muscular work.

The Nutrition Laboratory is especially well fitted for studying problems regarding body temperature, the respiratory exchange, and calorimetry, both during rest and during severe muscular work. Furthermore, with the recent introduction of the string galvanometer and photographic registration apparatus, many observations which have hitherto never been made of the influence upon physiological processes of the ingestion of alcohol may be accurately recorded. Concurrently, there has been established in the Nutrition Laboratory an equipment for psychophysical studies based upon the investigations of Professor Raymond Dodge. The extensive research on the metabolism during severe muscular work carried out at the Nutrition Laboratory during the winter of 1911-1912 by Dr. E. P. Cathcart has considerably illuminated our knowledge of the metabolism under these conditions, and the possibility of altering the metabolism by the ingestion of varying amounts of alcohol should prove a most practical field for research.

Believing that a fundamental investigation by modern technique of the influence of moderate amounts of alcohol upon the body processes is of great importance, it is planned to begin such a study in the fall of 1913. In accordance with plans which have been formulating during the last two or more years, I have prepared an outline for this research which I propose to submit to the leading physiologists throughout the world, many of whom I shall personally see on a forthcoming tour of Europe. It is my hope to secure from these men adverse criticism of the plan, together with suggestions for any changes or additions which may seem desirable, so that on my return a revised schedule can be prepared which can truthfully be said to meet the consensus of opinion of practically all physiologists and physiological chemists. If this plan can be successfully carried out, the investigation ought to be undertaken under the best auspices and with the most careful planning of any alcohol investigation thus far attempted. The resources of the Laboratory can be devoted to this investigation for a sufficient length of time to satisfy the majority of scientists

as to the accuracy of the results obtained. The investigation may require a considerable proportion of the time for a number of years.

In thus preparing this elaborate program, there is not the slightest desire to preempt any portion of the field, for, as Professor Lusk recently said: "The importance of the problem is too great not to have the work repeated in as large a measure as possible in at least two different laboratories."

I shall appreciate most fully any adverse criticisms that you may see fit to make of this program. Any additions to it will be most gratefully received, and obviously full credit will be given for such suggestions.

Will you not kindly send to this laboratory copies of such reprints as you have available bearing in any way upon the subject here outlined. Such reprints will materially lighten our work and insure a correct and adequate consideration of your own researches.

The investigation will be undertaken primarily to establish the important physiological relationships existing between the ingestion of alcohol and the metabolism and the activities of the body functions.

As an important correlative investigation, it is planned to carry out simultaneously an investigation on the psychological effects of alcohol, employing the technique that will make the results as objective as possible.

The program for the psychological study to accompany this research has been prepared by Professor Raymond Dodge, the experimental psychologist of the Nutrition Laboratory.

FRANCIS G. BENEDICT.

PHYSIOLOGICAL PROGRAM.

I. *Subjects (numcrous in each class):*

1. Non-users of alcohol.
2. Moderate occasional users.
3. Habitual drinkers (exceeding 30 c.c. absolute alcohol per day).
4. Excessive drinkers (with whom the effects of abstinence should be likewise studied).

II. *Alcohol doses. Controls if possible under conditions in which the subject will not know when alcohol is administered!*

1. Ethyl alcohol in various forms.

Pure alcohol, distilled spirits, wines, champagne, beers, ales, and hard cider should be used.

The variation in effects of the different kinds of liquors, *if any*, to be determined on one or two simple physiological or metabolic processes. If the effects in the above are *not* found directly proportional to the amount of absolute alcohol present, this fact should be elaborated in a subsequent research, and this present investigation should adhere to pure ethyl alcohol + water.

2. Doses, amounts.

- a. One single dose, varying amounts.
- b. Repeated doses at varying intervals.

3. How administered.

- a. By mouth (drinking).
- b. By mouth (stomach tube).
- c. Rectal enema.
- d. Inhalation of alcohol vapor. (Leonard Hill.)
- e. By the skin.

Immerse hand or arm in vessel (arm plethysmograph) containing moderately dilute alcohol. Is there any cutaneous absorption?

Perhaps stimulate cutaneous circulation by massage or electricity and note alcohol absorption.

4. When administered.

- a. Empty stomach (cocktail) between meals drinking.
- b. With food.
 1. With protein.
 2. With fats.

II. *Alcohol doses*—continued.4. When administered—*continued*.b. With food—*continued*.

3. With carbohydrates.

4. With condiments.

5. With glucose or nutritive enemata.

6. After or with a very hearty meal, *i. e.*, when stimulated by large amounts of protein, and by large amounts of food with little protein or little stimulation.

c. During fatigue.

1. Mental fatigue.

2. Physical fatigue.

d. During sleep (wake up from sound sleep and take dose and sleep afterwards).

III. *Absorption of alcohol*:

1. Absorption rate.

a. From stomach. After introduction into stomach, use stomach pump. (Lavage.)

b. From colon. After enemata, irrigate, determining alcohol in residue after varying lengths of time.

c. By digestive tract *vs.* by respiratory tract. Which is quicker? Results to be noted by respiratory exchange. (Leonard Hill.)

2. Completeness of absorption to be ascertained.

No alcohol in urine, feces, etc.?

3. Absorption by skin to be tested.

IV. *Circulation*:

1. Heart-beat and pulse.

a. Graphic tracings by sphygmograph.

Radial artery.

Carotid artery.

Capillary plethysmograph.

Electro-cardiograms.

Studying changes in the character and in rate of propagation of pulse-waves.

Effect of irritation of the stomach on the heart-beat.

b. Pulse-rate.

(1) Resting subject, nüchtern, lying quietly until pulse has reached minimum level before alcohol is administered.

(a) Use minute pulse as unit.

(b) Use pulse in two respiratory rhythms as a unit (electro-cardiogram).

(2) During sleep, if possible.

(3) During muscular work.

(a) Riding a bicycle ergometer at definite rate of revolution and degree of resistance. Ride till pulse constant, then take alcohol while riding.

(b) Is maximum pulse level affected by alcohol taken just prior to muscular work? Time to reach same or actual level.

(c) Is time of return to minimum pulse lying down after work altered? Is actual level after work altered?

(4) During various forms of mental activity.

2. Vasomotor reactions.

a. Plethysmograph observations.

b. Blood-pressure.

(1) Resting.

(2) Severe muscular work.

Quasi-continuous records (Erlanger sphygmomanometer). After rectal administration.

c. Note alteration in cutaneous circulation.

Is parallelism noted in temperature curves from rectum, groin, axilla affected? (Also skin temperature curve if possible.) (See Body temperature.)

d. Effect of alcohol on splanchnic circulation. Rapidity of stomach and intestinal movements. (See Digestion.)

3. Rate of blood flow (Krogh.)

IV. *Circulation*—continued.

4. Blood.

a. Morphology.

b. Blood gases.

Note effect of alcohol on tissue respiration. Is dissociation curve of blood changed?

V. *Respiration*:

1. Respiratory center.

Does alcohol affect the sensitivity of the respiratory center (Lindhard)?

2. Alveolar air.

Does alcohol affect the alveolar air?

a. By reason of respiratory center changes or

b. By affecting the alkalinity of the blood?

3. Volume of lungs.

Does alcohol affect elasticity of bronchial passage or alveoli?

a. Tidal air.

b. Vital capacity, etc.

c. Dead space in breathing.

4. Respiration-rate, depth, rhythm.

Spirometer tracings under all conditions (best done in connection with experiments on gaseous exchange).

5. Rich oxygen mixtures.

Is respiratory quotient altered by breathing oxygen-rich mixtures, when the (easily and rapidly?) oxidizable alcohol is present? (Pulmonary combustion.)

6. Holding the breath.

Does alcohol alter "breaking point"—

a. After breathing high oxygen?

b. After forced deep breathing?

Paying special attention to inhaling oxygen containing alcohol vapor. (Leonard Hill.)

VI. *Digestion and secretion*:

1. Motility of stomach.

a. X-ray studies.

b. Effect of alcohol on rapidity of movements and continuance of movements.

c. Hunger. (Cannon, Carlson.)

2. Diuresis.

VII. *Nutrition (Metabolism)*:

1. Alcohol and general and total metabolism.

Effect on character of katabolism.

a. Respiratory quotient as index.

If man at rest on high carbohydrate diet on preceding days has respiratory quotient nüchtern of 0.90, how will alcohol ingestion affect the respiratory quotient?

Is there a selective combustion for alcohol? If so, respiratory quotient should approach 0.666.

b. If a nüchtern quotient of 0.78 is obtained by regulation of diet on preceding days and alcohol + sugar is given, will quotient—

(1) Rise, indicating prevailing carbohydrate combustion?

(2) Or fall, indicating prevailing combustion of alcohol?

c. Relative combustion rates of alcohol and various sugars as determined by above method. What amount of various sugars will offset the ingestion of alcohol to prevent lowering the quotient?

Effect on amount of katabolism and energy output.

a. Series of nüchtern experiments with respiration apparatus, subject very quiet, pulse minimum, etc.

Then alcohol and note effect on total katabolism on—

(1) Carbon-dioxide production.

(2) Oxygen absorption.

VII. *Nutrition (Metabolism)*—continued.1. Alcohol and general total metabolism—*continued*.

This experiment can be advantageously made simultaneous with observations on pulse, temperature, and respiration.

Is intensity of effect proportional to dose?

Is duration of effect proportional to dose?

For example, will a 50-gram dose double the effect on the katabolism noted by a 25-gram dose, or will it simply prolong it twice as long?

b. If any effect on metabolism, is there a compensatory effect later, *i. e.*, is there an after-effect? What is its nature?

c. Protein ingestion results in a greatly stimulated katabolism.

What is effect of alcohol on this increase? Study effect on rapidity of beginning of initial increase, intensity of rise, prolongation of effect, and return to normal base-line.

d. Ingestion of cane sugar or levulose likewise increases noticeably the total katabolism.

Has alcohol any effect on this increase?

2. Alcohol and carbohydrate and fat metabolism.

Effect of alcohol on the tolerance of various sugars.

Influence of alcohol upon the amount of reducing material in the urine (Peters's method).

Study this from the standpoint of the influence of alcohol upon the oxidative powers of the body. If alcohol given simultaneously with sugars and alcohol burned first, then possible lowering of sugar tolerance. To what degree? Are various sugars affected differently?

3. Acidosis.

a. Meat-fat diet or non-carbohydrate diet induces an acidosis in normal man.

(1) Will alcohol ingestion retard or hasten the onset of the acidosis?

(2) In such an acidosis what is effect of alcohol ingestion?

(3) Alcohol + large amounts of protein in an acidosis. Is increased metabolism due to protein ingestion plus the increased metabolism of acidosis affected by the alcohol?

Will the body burn alcohol and facilitate the storage of the de-aminized portions of the protein molecule?

b. Alveolar air and respiration volume.

By Haldane's apparatus and by the spirometer on the universal respiration apparatus study the relationship between alcohol ingestion and the alveolar air in respiration, also the respiratory volume.

4. Protein metabolism.

a. Nitrogen output.

Probably affected by alcohol diuresis.

If an increase, is it due to—

(1) Washing out, or

(2) Increased cell katabolism?

Controls should be made with distilled water diuresis.

Nitrogen partition in blood may be studied by Folin's methods.

b. Purine metabolism.

(1) Uric acid in blood.

By Folin's new colorimetric method; study effect of alcohol on uric acid in blood.

(2) Urine. On purine-free diet.

With large volumes of urine by diuresis produced by alcohol and control by drinking large amounts of water.

(3) Does alcohol ingestion alter exogenous or endogenous purine metabolism? (Beebe.)

c. Effect of alcohol on the nitrogen partition and the total N balance on—

(1) Starch-cream diet.

(2) Protein-rich mixed diet.

(3) Meat-fat diet. (Kayser's work.)

VII. *Nutrition (Metabolism)*—continued.4 Protein metabolism—*continued*.

d. After-effect of severe muscular work on N output. Is it affected by alcohol ingestion?

Is it exaggerated or not?

Compare also N partition under these conditions.

5. Intermediary metabolism.

a. Carbonaceous material in urine.

Any change in character of solids in urine.

C : N ratio. Cal : N ratio.

A possible index of a perturbed intermediary metabolism (Higgins and Benedict).

6. Energy metabolism.

a. Muscle tonus. Is it altered? Muscle hardness. (Exner.)

b. As muscular work demands a rapid oxidation of material, increases the ventilation of the lungs, quickens the circulation, and there is in part at least a selective combustion of carbohydrate, a series of experiments to study the oxidation of alcohol by the body under the influence of intense muscular activity is of fundamental importance.

(1) Is there a selective combustion for alcohol during severe muscular work? With no alcohol the respiratory quotient always tends to rise during severe work. If alcohol is burned in preference to protein, fat, or carbohydrates, the quotient would be markedly lowered.

(2) When alcohol and carbohydrates are ingested and muscular work follows, is the metabolism chiefly of carbohydrate, with high quotient or of alcohol with low quotient?

(3) In a body depleted of glycogen by severe muscular work—

(a) Is the carbohydrate first stored if fed together with alcohol, *i. e.*, does the respiratory quotient remain low?

(b) When alcohol is given is there any evidence of formation of glycogen from either protein or fat to replace the store, the maintenance-combustion being from alcohol?

(4) Does muscular work increase the capacity of the body to burn alcohol? To what extent?

Maximum amount burned?

During muscular work are larger amounts tolerated before signs (incipient) of intoxication appear?

(5) Is appearance of "second wind" quickened or retarded by alcohol ingestion?

(6) After-effects of muscular work as influenced by alcohol?

(a) Rapidity of return to normal metabolism.

Is rate of return altered, *i. e.*, does alcohol help out on the rapidity of recuperation?

Is pulse base-line lower or the same after work as without alcohol?

Do alcohol and glucose superimpose their effects on after-work period or is glucose stored and alcohol burned? Is a larger amount of alcohol burned per hour after work when glycogen supply is low?

(7) Heart-beat, character of wave, etc., after severe muscular work. Does alcohol alter it?

Electro-cardiograms, etc.

(8) Intensity of work. Capacity for work. Endurance.

Is it affected? Can subject do more or less with alcohol? Maximum working capacity. Bicycle ergometer sprint!! How long and how high revolutions per minute? Is the efficiency of the body as a machine based upon the rate of speed with a constant load altered by taking alcohol? Any compensating after-effects?

In a prolonged fatigue experiment, *i. e.*, riding strong pace and load. How test endurance? Ratio of external muscular work and total energy output?

VII. *Nutrition (Metabolism)*—continued.

7. Heat regulation.

a. On resting subject. Secure normal diurnal variation, *i. e.*, after lying down for some time to avoid temperature rise due to muscular activity.

- (1) Does alcohol administration alter character of the curve taken from minute to minute? Rectal temperature by thermo-element.
- (2) Body-temperature rise produced by muscular work.
Is it affected in intensity or time by alcohol?
- (3) Body-temperature fall after work.
(a) Rapidity of fall.
(b) Level after work.
- (4) Sensitivity to temperature. Local plotting of skin area to temperature reaction. (Tigerstedt's lab. technique.) Is physiological zero altered? (Aesthesiometer tests should be of interest.)
- (5) Reaction to exposure to cold air 15° C.
Shivering keeps up temperature.
Will shivering take place after alcohol is given?
Get body-temperature curve of subject and expose to cold air by disrobing. Is curve altered?
Is alcohol given before it is altered?
Same experiments on drunken man. What effect of disrobing on temperature curve?

PSYCHOLOGICAL PROGRAM.

[PREPARED BY RAYMOND DODGE, EXPERIMENTAL PSYCHOLOGIST OF THE NUTRITION LABORATORY.]

It is assumed without discussion that any complete investigation of the effects of the ingestion of ethyl alcohol must include not only its immediate and remote effects on the general metabolism of the body, but also, as far as possible, its effects on special tissues that are influenced in any peculiar way by that particular kind of alcohol.

It seems obvious further that among those special tissues, nervous tissue and the end organs of sense and motion are of particular importance because of their intimate connection with intelligence, personality and conduct, and their bearing on social welfare and economic efficiency. Unfortunately, only the simpler and the more elementary neuro-muscular processes can be studied directly by present laboratory technique. Of the important higher mental and moral processes there is at present scant probability for securing experimental data of scientific reliability. Modifications of the moral controls, of business judgment, tact and reliability, of mental stability and balance, are not experimentally measurable in any direct way. They must be studied, if at all, by some indirect method. This technical defect is a serious limitation to all experimental investigations of the psychological effects of the ingestion of alcohol since it is in precisely these directions that general experience indicates that the effects of alcohol are probably most serious. It is consequently all the more necessary to choose the lines of direct

investigation with experimental tact for probable correlations. The direct investigations must not only be reliable in themselves, but they should indicate as much of the higher and more complex mental mechanism as possible. Consequently, of the indefinite number of experimental facts concerning elementary processes that might be collected, actual experimentation should be determined by the following principles:

(1) The technique must be scientifically adequate to the precise purpose in view and reliable with respect to instrumental constants, latency, variability, etc.

(2) Relatively elementary neuro-muscular processes should be investigated in their simplest forms so far as possible. Complex processes should be so chosen as to be definitely related to the elementary processes and directly or indirectly analyzable into their several factors.

(3) All experiments should directly contribute to a systematic analysis of neuro-muscular processes and their variations. The real value of an adequate test consists in its correlations or possibility of correlation.

(a) It is of the utmost importance that there should be the highest possible comparability of data obtained from different individuals and from the same individuals under different conditions. All instrumental constants should be known and the technique should be reproducible.

(b) Unless the personal peculiarities and idiosyncracies of voluntary attention and effort are directly the subject of investigation or are otherwise capable of estimation, experiments should be as independent as possible of the caprice of the subject. This is particularly true of the elementary processes. Uncontrolled complex tests, such as ergographic experiments, addition and multiplication experiments, are particularly questionable. One must know whether decrease of achievement is due to decreased specific capacity or to fatigue of general psychological controls, such as interest and incentive.

(c) All experiments should be as free as possible from practice effects. Thoroughly practiced processes that require no special training should be chosen wherever possible. This excludes most of the common reaction experiments except for a few trained subjects. Under all circumstances base-lines should be complete enough to include a measure of any practice effects that may develop.

(d) In all psychological experiments it is desirable, and in the investigation of processes subject to the caprice of the individual it is essential, that the ingestion of alcohol of one subject or set of subjects should be rigidly controlled by other normal subjects and by the same subjects under normal circumstances.

(e) I believe that the ingestion of alcohol should be *masked* as completely as possible. I do not know the best technique. Suggestions on this matter are especially requested.

(f) It seems desirable also to obtain quantitative data wherever possible of remote neuro-muscular effects; especially should this be studied with reference to the deterioration of memory residua, and associations established under alcoholic use, and conversely.

(g) I regard it as extremely important that experiments be made on habitual moderate and excessive users of alcohol under *abstinence*. It seems to me highly important to study the psycho-physiology of the facts whose extreme form is represented in the mental complex by *crawing*.

SECTION I.—SENSITIVITY OF THE END ORGANS OF SENSE AND MOTION.

Since all stimuli must be given through the end organs of sense, and since muscular contraction is the most accessible indicator of nervous action, the influence of alcohol on the organs of sense and motion is a primary, though probably not a very important consideration.

(a) For most accurately reproducible threshold experiments I propose the use of Martin's electrical threshold apparatus and technique. Aesthesiometric and pain threshold tests depend on a large number of variables extremely difficult to control. Sound, taste, smell, and muscular sense thresholds do not seem to be of sufficient probable significance to warrant special investigation. The pain threshold, on the contrary, is not unimportant. It may be that many changes in the higher complexes depend on modified sensitivity to pain. Suggestions for technique would be especially welcome.

(b) Since vision will be the sense most used in the higher tests I recommend tests for changes in visual acuity, preferably the E test, after proper correction of the subject for astigmatism.

(c) The following muscle conditions should be determined: (1) muscle threshold for

electrical stimulus (Faradic current); (2) fatigue and recuperation. The development and duration of relatively permanent muscle contraction as the result of work. I propose the use of reciprocal innervation of the antagonistics of the middle finger moving back and forth as rapidly as possible for 30'', a rest of 5'' and renewed innervation for 5''. This is a modification of the tapping test, eliminating the stop; (3) steadiness of muscle contraction, either visual nystagmus in lateral fixation or direct measurement of involuntary movements of the hand; (4) velocity of muscle contraction. In order to eliminate voluntary control I suggest photographic registration of eye-movements, for reasons explained in "The Ocular Reactions of the Insane"¹ by Diefendorf and Dodge; (5) the corresponding metabolic demands should be measured directly or by their effect on the pulse-rate. In fact, pulse-rate should be taken with every test. I regard this as of the utmost importance, as indicated in my paper on "Mental Work,"² (6) most of these muscle and threshold experiments should be made before and after severe physical work and periods of rest.

¹An experimental study of the ocular reactions of the insane from photographic records. *Brain*, 1909, 31, p. 451.

²*Psychol. Review*, 1913, 20, p. 1.

SECTION II.—LATENCY, SENSITIVITY, CONFIGURATION, REFRACTORY PHASE, AND RECUPERATION OF THE SIMPLE REFLEXES.

Since the entire psychophysical mechanism must be studied as a complication of nervous arcs, the nervous arc should be studied in its simplest form, according to principle (3), *i. e.*, in the simple reflexes. The refractory phase may be of peculiar importance in connection with the problem of fatigability and recuperation. Because of the adequacy of the respective techniques I suggest particular study of the knee-jerk and the protective wink-reflexes.

(1) The knee-jerk should be measured by muscle thickening, with special reference to latent time, sensitivity, height and configuration of the curve, and the duration of its

return to the base-line from which it starts. For reasons described in my "Systematic Exploration of the Knee Jerk"¹ I prefer a pendulum hammer stimulus and direct registration of the muscle curve; (2) the protective wink-reflex should be studied with special reference to latent time, sensitivity, height and configuration of the curve, and the duration and completeness of the subsequent refractory period. For reasons described in my paper on the "Refractory phase of the protective wink-reflexes"² the stimulus should be a sound stimulus and the registration should be photographic.

SECTION III.—COMPLICATED REACTION ARCS.

Practiced reactions of more complex arcs which would be comparable in different individuals are relatively few. I suggest (1) eye-reactions to suddenly appearing peripheral visual stimuli. These are in the nature of choice reactions and demand a definite space complication of the muscular response. They are thoroughly practiced for all normal adults and relatively independent of the caprice of the subject (see "Ocular reactions

of the insane"). (2) Since speech is the best practiced universal (for literates) reaction, I should combine these records of the eye-movements with speech-reactions, naming the letter presented (one of 2 or 4), as carried out in my "Experimental study of visual fixation."³ (3) I believe further that in specially trained individuals their regular business reactions should be studied as in the Kraepelin and Aschaffenberg experiments.

SECTION IV.—MEMORY AND ASSOCIATION TESTS.

Since distinctively mental functions chiefly involve memory and association,⁴ some approved form of memory and association tests should be used. They should not be too time-consuming or too exacting for the subject. (a) For memory I suggest the speech reaction to a "normal" series of 12 *gradually* appearing words; three repetitions of the series should show a quantitative perseveration value without actually learning the series. This test has the tentative approval of G. E. Müller (Gottingen). (b) Controlled

association test should be made either in the form of Kraepelin mathematical tests or some similar method. Pulse-rate must be taken with these tests.⁵ Free association tests for the possible changes in the character of the associates should be made with special reference to time of response and pulse-rate. (c) I also recommend tests on the rapidity of reading aloud, including photographic registration of the fixation pauses of the eyes (Dodge and Dearborn) and a record of the pulse-rate.

¹A systematic exploration of a normal knee-jerk, its technique, the form of the muscle contraction, its amplitude, its latent time, and its theory. *Verworn's Zeitsch. f. allg. Physiol.* 1910, 12, p. 1.

²The refractory phase of the protective wink-reflex. *Am. Journ. Psychol.*, 1913, 24, p. 1.

³An experimental study of visual fixation. Monograph supplements of the *Psychol. Review*, 8, No. 4, esp. pp. 53-55.

⁴A working hypothesis for inner psychophysics. *Psychol. Review*, 1911, 18, p. 167.

⁵Mental work. A study in psychodynamics. *Psychol. Review*, 1913, 20, p. 1.

SECTION V.

Correlated with the above experiments there should be some investigation of the *perseverance* of the subject, *i. e.*, of the fatigability of the higher psychological controls involved in persistent effort and prolonged voluntary attention.

(a) In connection with experiment 2, section I, I propose reciprocal innervation of one finger to the "breaking-point," *i. e.*, where the subject stops. This might be studied in connection with the "breaking point" of inhibited respiration.

(b) In connection with photographic registration of the eye-movements, I propose persistent fixation of a given mark under experimental change of the visual environment.

(c) If a satisfactory analysis of the McDougall test could be made, I should favor its use.

The above outline particularly disclaims being a catalogue of all mental and physio-

logical investigations that might be undertaken with scientific profit. Of the infinite number of possible observations, selection has been made: first, on the basis of technique; second, on the basis of simplicity of the elementary processes; and third, on the basis of an attempt at a systematic exploration of the effect of alcohol on psychophysical processes.

The purpose in printing this outline is that it may be submitted to the leading physiologists, psychologists, physiological psychologists, neurologists, and neuro-pathologists in the hope that we may have the benefit of any adverse criticism and any suggestions for changes or additions that may occur to them. It is particularly desirable that the final program shall meet the consensus of opinion of experts throughout the world. Naturally, credit for suggestions and changes will be given with scrupulous care.

APPENDIX II.

FAMILY AND PERSONAL HISTORIES OF THE SUBJECTS.¹

SUBJECT II.

Date.—September 23, 1913.

Family history.—Father, American (Scotch-Irish); uncle, hard drinker; mother, American (English descent); brother, hard drinker; father and mother married 31 years. One sister, 27 years old.

Does not know whether father took alcohol, but probably did in last two years of his life, during illness. Mother took practically none; wine 4 or 5 times a year; sisters practically none. No habitual use of drugs by any member of family. Grandfather on father's side died in "melancholia."

Personal data.—Age, 29 years; height, 182.2 cm.; weight, 74.8 kilos. Occupation, student. Sport, gymnastics.

Education.—Williams College, 1905; high scholarship; best in sciences, worst in languages.

Memory.—Visual; fairly quick; fairly long (fixed if seen); fairly responsive; high in accuracy.

Very moderate user, in part for practical reasons; does not care for alcoholic drinks. Has occasionally taken wine, 5 glasses a year, at banquets, etc., with no effect. Largest amount, pint bottle of blackberry brandy as medicine, with no effect. Last use, 10 days previous, 1½ glasses wine at dinner. Never intoxicated; not affected by amounts taken.

Tea and coffee.—Very little of either; occasionally weak coffee for hay fever.

Life insurance.—Last examined in 1907. Northwestern Mutual and Connecticut Mutual Life Insurance Companies. Accepted by both.

SUBJECT III.

Date.—September 9, 1913.

Family history.—Father, American; mother, American; father and mother married 27 years. One sister, 22 years old.

None of the family take alcohol or use drugs of any kind. No insanity in the family.

Personal data.—Age, 25 years; height, 176.5 cm.; weight, 67.5 kilos. Occupation, physician. Sport, tennis, an hour at a time.

Education.—Dartmouth College, 1909, and Boston University. Tenth in class of 200 members. No special preference for any study.

Memory.—Very quick, accurate, responsive, but forgets easily.

Non-abstainer.—Drinks beer, a quart in two weeks; no effect except geniality. Largest amount of alcoholic liquor taken, about 1 pint of whisky in highballs at a banquet; "head" next morning. Last use, bottle of beer September 8. Never intoxicated.

Quickly affected by alcoholic liquor. It produces excitement, though subject is normally quiet; no talkativeness, but a feeling of happiness; no physical sensations; does not affect affection or temper; effect on routine work not known; no effect on digestion; occasionally increases the flow of urine.

Tea and coffee.—Uses neither, but tobacco in excess.

Life insurance.—Examined in 1903. Mutual Life Insurance Company of Montpelier. Accepted.

¹The histories of three subjects are not included because the experimental sessions in which they served were too few for statistical treatment with the group (Subjects I and V), or because it proved impracticable to carry out the experimental program for some other reason (Subject XIII). The last mentioned was a hard drinker who refused to give us non-alcohol or normal days. The first two broke off the experiments to meet business engagements.

SUBJECT IV.

Date.—September 25, 1913.

Family history.—Father, American (Scotch descent); mother, American; father and mother married 34 or 35 years. Two brothers, 33 and 32 years old. Three sisters, all younger.

Father takes whisky to excess at the end of the week; makes him ugly. Mother takes gin, rarely to excess, occasionally at period. One brother heavy drinker; no special kind of liquor; drinks frequently; to excess once a week. Other brother moderate drinker, but never intoxicated. Sisters abstainers. No insanity in family.

Personal data.—Age, 27 years; height, 181.6 cm.; weight, 73 kilos. Occupation, student. Sport, football coach.

Education.—Colby College. Average scholarship; best in sciences, worst in languages.

Memory.—Quick and accurate when he remembers at all; slow in response; does not retain for any length of time.

Non-abstainer.—Drinks beer three or four times a week at dinner. It exhilarates at first, but later makes him drowsy. Largest amount taken, 2 or 3 bottles of beer and fancy drinks at a banquet. Last taken September 24, 1 liter of beer at dinner. Never intoxicated; makes him sick first. Can take 1 liter of beer without noticeable effect.

First noticeable effects are exhilaration, though subject is normally quiet; more talkative than usual, normally moderate in speech; gives feeling of happiness, though normally depressed. No peculiar sensations except a blurring of vision. No effect on the flow of ideas; softens the temper; produces a tendency to looseness of morals; no effect on the digestion or on the urine.

Tea and coffee.—Two cups of strong coffee a day.

Life insurance.—Examined in 1911. Mutual Benefit Life Insurance Company of New Jersey. Accepted.

SUBJECT VI.

Date.—October 7, 1913.

Family history.—Both father and mother American, Scotch descent; married 28 years. One brother, not living, 21 years.

None of the family take alcohol or drugs. There is no insanity in the family, and no alcoholism in the collateral branches.

Personal data.—Age, 25 years; height, 164 cm.; weight, 68 kilos. Occupation, student, second year medical school. Sport, walking 2 miles a day.

Education.—Oklahoma Agricultural College. Average scholarship; best in biology, worst in English grammar.

Memory.—Poor, verbal. Not quick, accurate, long, or responsive.

Non-abstainer.—Drinks beer, etc., at banquets; 1 or 2 glasses at a time; effect, stupefying. Largest amount ever taken, 10 or 12 glasses, mixed drinks, in the evening, one year previous; "attempted to get drunk"; stupefying effect; only time ever intoxicated. Last used, October 3, 1913, one glass of beer. Two glasses of beer can be taken on a full stomach without noticeable effect.

First noticeable effects are drowsiness and unsteadiness. Produces no excitement, though subject is normally nervous; causes talkativeness, normally moderate in speech; produces a feeling of elation, normally cheerful. No peculiar sensations. Seems to increase the flow of ideas. No effect on the affections, but sweetens the temper. Effect on routine work not known, as he never takes it when working. No effect on morals. One glass aids digestion; two glasses retard it; no effect upon the urine.

Tea and coffee.—One cup strong coffee every morning.

Life insurance.—Examined for life insurance a year previous. Northwestern Mutual Life Insurance Company. Accepted.

SUBJECT VII.

Date.—October 8, 1913.

Family history.—Father and mother both American; married 29 years. One brother, 22 years.

Neither the father nor the mother takes alcohol, nor the brother so far as known. No habitual use of drugs by any member of the family. Paternal grandmother had psychosis at menopause.

Personal data.—Age, 26 years; height, 177.8 cm.; weight, 67.5 kilos. Occupation, student, medical school. Sport, tennis.

Education.—Grinnell College, 1907. Scholarship, Phi Beta Kappa. Best in sciences, worst in languages.

Memory.—Good “crammer.” Fairly quick, more accurate than the average. quick to memorize but as quickly lost, responsiveness above average.

Non-abstainer.—Drinks beer (not more than a pint at a time) irregularly; acts as a “narcotic, more sedative than stimulating.” Largest amount ever taken, 2 quarts of beer at an evening party; “stimulation from social suggestion.” Last used, October 4, 1913, 400 c.c. of beer in the afternoon; no effects observed. Intoxicated once, January 1911; took 1 quart of beer, 1½ glass whisky, and ½ glass port. Can take one glass (½ pint) of beer after supper without noticeable effect.

First noticeable effects, acts as narcotic; tends to talkativeness if more is taken; produces a feeling of happiness; when subject is in bed, alcohol produces a sensation of floating; seems to make the ideas flow more easily. He becomes mellower, more affectionate, but there is no effect upon the temper. Seems to help physical pain; never taken for mental pain. Feels “like dancing the tango;” sense of conventionality lessened. Only physical effect is that beer sometimes causes fermentation.

Tea and coffee.—Coffee every day, not too strong; seldom tea.

Life insurance.—Examined spring of 1909. Union Central Life Insurance Company. Accepted.

SUBJECT VIII.

Date.—October 9, 1913.

Family history.—Father, American (Scotch-Irish); mother, American (Pennsylvania Dutch); father and mother married in 1886. Two brothers, 26 and 13 years; one sister, 17 years.

Father takes beer moderately, not with meals. Mellowing effect; intoxicated twice a year. Mother abstainer. Older brother, moderate amounts; younger brother and sister, abstainers. No habitual use of drugs by any member of the family. No insanity in the family.

Personal data.—Age, 24 years; height, 178.4 cm.; weight, 74.8 kilos. Occupation, student, third year medical school. Sport, walking at present, 3 miles a day.

Education.—University of California. Scholarship, high honors. Best in sciences, worst in mathematics and English.

Memory.—Very quick, accurate, not very long, moderately responsive.

Total abstainer.—Reasons, more particularly moral, but also scientific, practical, and family (mother).

At 10 years of age, accidental overdose of whisky. Lost equilibrium on coming home, was put to bed and was sick for several days. Tried beer since, but did not like the taste.

Tea and coffee.—Moderate amount of coffee about four times a week.

Life insurance.—Never examined. Medical examination, June 1913; jaundice, at City Hospital.

SUBJECT IX.

Date.—October 10, 1913.

Family history.—Father, South German; mother, South German. Father and mother married in 1890. One brother, 20 years old.

Father takes wine and beer, 1 bottle at a time in the evening; no effects observed. Brother takes beer, 2 or 3 bottles at a time. No habitual use of drugs, no nervous or mental disease, and so far as known, no excessive use of alcohol in family history.

Personal data.—Age, 22 years; height, 174 cm.; weight, 63.5 kilos. in July 1913, after losing 10 kilos. Occupation, student, dental school. Sport, football; tennis previously.

Education.—Gymnasium, Wiesbaden. Scholarship, average. Best in gymnastics and languages, worst in mathematics.

Memory.—Rather quick, usually accurate, forgets quickly, no special difficulties in response.

Non-abstainer.—Drinks $\frac{1}{2}$ to 1 bottle of wine or beer a day now, but previously 3 bottles a day, in the evening; no general effects. Largest amount taken, 4 bottles beer in the evening; did not feel intoxicated, but vomited. Last use, previous evening 1 bottle of beer; no effects. Never intoxicated. 2 or 3 liters of beer could be taken in the evening without noticeable effects. Sometimes produced vomiting next day. In excess of 2 or 3 liters it acted as a diuretic.

Tea and coffee.—One or the other taken at every meal; amount, one cup.

Life insurance.—Examined, July 1913. Stuttgarter Lebensversicherung. Accepted.

SUBJECT X.

Date.—February 10, 1914.

Family history.—Father and mother, American, married in 1868. Two brothers, 41 and 39 years.

Not known as to whether father took alcohol; probably took small amounts rarely. Mother, abstainer. One brother, abstainer; other probably does not take alcohol. No knowledge of habitual use of drugs by any member of the family. No nervous or mental disease or excessive use of alcohol in the family history.

Personal data.—Age, 43 years; height, 182.9 cm.; weight, 85 kilos. Occupation, scientist. Sport, no systematic exercise.

Education.—Harvard University. Scholarship, A. Best in sciences, worst in languages.

Memory.—Verbal, good. Memory for poetry poor; memory for figures phenomenal.

Abstainer, but not total. Reasons, moral, scientific, practical, social. Occasionally takes small amount of wine at dinners. Effects rarely noticeable; has produced flushing, with a distinct desire for fresh air; is not loquacious by design; never appears to affect reasoning. Largest amount ever taken and last time used, December 15, 1913, 2 glasses of champagne at dinner. Never intoxicated.

First noticeable effects: No noticeable excitement or increased flow of ideas; so far as known, does not cause talkativeness or feeling of happiness, or affect routine work, the sense of propriety, the affections, or the urine. No effect on the digestion has been observed. Only peculiar sensation observed was (once) the flushing referred to.

Tea and coffee.—A moderate use of coffee; two cups a day.

Life insurance.—Last examined, 1907. Provident Life and Trust Company. Accepted for two policies.

PSYCHOPATHIC PATIENTS.

SUBJECT XI.

Date.—March 24, 1914.

Family history.—Father and mother, English; date of marriage unknown. Three brothers, four sisters.

Father heavy drinker, often intoxicated; probably drank ale. Mother, moderate drinker; takes ale and porter; never intoxicated. Brothers, moderate drinkers; three or four drinks a year. Sisters, very moderate drinkers. Never heard of an habitual use of drugs by any member of the family. No nervous or mental disease or the excessive use of alcohol in the family history was reported.

Personal data.—Age, 51 years; height, 161.3 cm.; weight, 55.8 kilos. Occupation, grocery clerk. Sport, none.

Education.—Common schools from 5 to 11 years. No high school or college education.

Memory.—Excellent for long poetic citations; not good for proper names; indifferent for figures.

Non-abstainer.—Last use, November 1913, drank to excess 7 to 10 days, this leading him to go to the Psychopathic Hospital. At present abstainer, under hospital supervision. Previously took perhaps 2 glasses of whisky and 7 glasses of ale a day. Very little affects him very quickly. One glass of ale makes his head dull; feels the effect of one glass of whisky for whole day. When he once begins drinking, continues until intoxicated.

First noticeable effects: Head dull with ale; whisky makes him talkative. Requires 3 or 4 glasses of ale to produce a feeling of happiness, but only 1 glass of whisky. Is not conscious that he is becoming intoxicated until he has reached that state. Drinking causes a flow of ideas; "could make a speech," as words come easily. Does not make him quarrelsome. Does not drink to dull mental or physical pain. Drinking incapacitates him for work; he can not reason, and makes blunders. Produces a feeling of independence, but does not affect morals. Has no appetite after a day's drinking. Ale increases the flow of urine.

Tea and coffee.—Drinks coffee only on Sunday, strong. Tea freely, strong; 6 cups a day with no effect.

Life insurance.—Examined, 1912; John Hancock Life Insurance Company; accepted. Examined, also, at the Psychopathic Hospital, to which he has been admitted twice for delirium tremens.

Physical defects.—Left eye has scar on cornea; vision impaired; right eye, ordinary vision. Front teeth bad, preventing clear utterance of words in reaction experiments.

SUBJECT XII.

Date.—March 31, 1914.

Family history.—Both father and mother mulatto; date of marriage unknown, probably 1849.

Three brothers, 54, 52, and 37 years; two sisters, 58 and 46 years.

Father drinks considerable of any kind of liquor, when his work permits; makes him somewhat ugly. Mother total abstainer. Only one brother drinks occasionally, but not affected by it. Sisters, abstainers. No habitual use of drugs by any member of the family or nervous or mental disease in the family history; no knowledge of excessive use of alcohol in the family history.

Personal data.—Age, 40 years; height, 169.1 cm.; weight, 68.1 kilos. Occupation, night watchman, railroad station. Same place for 4 years. Sleeps 6 p. m. to 12 midnight; works midnight to 10 a. m. Has worked nights all of his life on Pullman cars.

Sport.—Used to run a great deal, but had pain in his heart after running and the “physician told him that the valves were clogged.”

Education.—Five years in common schools. Halifax, Nova Scotia; also attended evening school, Boston, one winter.

Memory.—Fairly good.

Non-abstainer.—At present abstainer, under hospital supervision. Previously drank anything, in any amount, at any time. Largest amount ever taken, 10 to 15 glasses of whisky. Made him “shaky”; unable to sleep afterwards. Last use 8 months previous, except at Christmas, when he took a glass of wine and an eggnog. Regular dose used to be 4 to 5 glasses of whisky or several bottles of cheap wine. Has always been able to get home, even when drinking heavily. Not affected by 2 or 3 glasses of whisky. Insists that stopping affects him more than drinking; makes his hand tremble.

First noticeable effects: Makes him sleepy; does not cause talkativeness; naturally of a happy temperament and the liquor does not increase the feeling of happiness. No peculiar sensations; no effect on the flow of ideas or on the temper. Never had physical pain, so is unable to say what would be the effect of drinking upon it. Two or three glasses of whisky does not affect his work. No effect upon morals or digestion, except that he loses his appetite when he stops drinking. Whisky does not affect the amount of urine, but wine does to some extent.

Tea and coffee.—Three cups of coffee per day; sometimes takes tea instead of coffee.

Life insurance.—Was examined for some company, the name of which has been forgotten, and was admitted, but did not pay his premiums.

SUBJECT XIV.

Date.—April 21, 1914.

Family history.—Both father and mother Irish; married about 1864. Seven in family; subject next to the youngest; one brother.

Father drank whisky, but worked steadily; effects unknown. Not known whether mother took alcohol or not. Brother drank heavily once a week; made him “soft.” Sisters practically temperate. No habitual use of drugs by any member of the family. Grandfather had traumatic disturbance as a result of a blow on the head. No excessive use of alcohol in the family history.

Personal data.—Age, 39 years; height, 166.6 cm.; weight, 67.6 kilos. Occupation, bottler, but has not been employed for 6 months.

Education.—Educated in Ireland to second highest grade in national school; scholarship good.

Memory.—Average; not forgetful.

Non-abstainer.—At present abstainer, under hospital supervision. Previously, drank three-quarters of a bottle of beer every hour, about 8 bottles a day. Became intoxicated only when he drank whisky in addition to the beer. Largest amount ever taken, perhaps a pint of whisky at Christmas. Last use, 6 months previous, led to admission to the Psychopathic Hospital. Occasionally intoxicated, after using whisky and beer. Never dizzy, but had heartburn and fermentation.

First noticeable effects: Drinking made him “full of fun,” talkative, happy, and argumentative. Did not drink to dull mental pain. Did not prevent him from doing his work. No noticeable effect on the urine.

Tea and coffee.—Takes both tea and coffee now, of moderate strength, 5 cups a day.

Life insurance.—Examined for life insurance in Metropolitan Life Insurance Company and Knights of Columbus; for the latter about 1894 or 1895. Accepted.

MBL/WHOI LIBRARY



WH 186E 2

4236

