



STUDIES ON SOLUTION IN ITS RELATION TO LIGHT  
ABSORPTION, CONDUCTIVITY, VISCOSITY,  
AND HYDROLYSIS

A REPORT

UPON

A NUMBER OF EXPERIMENTAL INVESTIGATIONS CARRIED  
OUT IN THE LABORATORY OF THE LATE  
PROFESSOR HARRY C. JONES

---

COMPILED BY PAUL B. DAVIS



CARNEGIE INSTITUTION OF WASHINGTON

1918

CARNEGIE INSTITUTION OF WASHINGTON

PUBLICATION No. 260

17996

PRESS OF GIBSON BROTHERS  
WASHINGTON, D. C.

## PREFACE.

The several chapters comprising this report represent the various lines of investigation pursued under the direction of the late Professor Harry C. Jones during the year 1915-16 and in the case of the work of Davis and Johnson continued in 1916-17. Although somewhat diverse in nature, they all bear directly or indirectly upon the conceptions of solution in general and of solvation in particular which have been developed in this laboratory during the past fifteen years.

Dr. Hulburt and Dr. Hutchinson have measured the absorption coefficient of solutions of a number of salts in different solvents for monochromatic radiation. They have calculated from this the molecular absorption coefficient for such solutions and have made a careful comparative study of the molecular absorption-concentration curves.

The investigation of formamid as a solvent, begun by Davis and Putnam, has been continued by Dr. Davis and Dr. Johnson. In addition to observing the behavior of a series of nitrates and formates in this solvent, they have determined the conductivity and viscosity of solutions of a number of salts of the organic acids and have also studied several representative salts in mixtures of formamid with ethyl alcohol.

Dr. Davis has also made some observations on the viscosity of cesium salts in binary mixtures of glycerol and of formamid with water.

Dr. Lloyd and Dr. Pardee have extended the work in absolute ethyl alcohol to include a study of the conductivities of the sodium salts of a number of organic acids and have succeeded in applying the formula of Noyes and Johnston for aqueous solutions to the calculation of dissociation in this solvent.

Dr. Ordeman has completed his study of the relative dissociating power of free and combined water reported on in part in Publication No. 230 of the Carnegie Institution of Washington.

Dr. Connolly has investigated the different chemical activity of free and semi-combined water, using as an illustration the effect of neutral salts in the hydrolysis of acetic anhydride. A preliminary paper on this work is also to be found in Publication No. 230.

The results of all these investigations, which have been carried out with aid of generous grants from the Carnegie Institution of Washington, are recorded in this volume. The writer also wishes to thank that Institution for making possible the completion of certain investigations left unfinished by the untimely death of Professor Jones, and the Chemical Staff of this University for their courtesy in extending the facilities of the laboratory.

PAUL B. DAVIS.

THE JOHNS HOPKINS UNIVERSITY, *June 1917.*





# CONTENTS.

## CHAPTER I.

### THE ABSORPTION COEFFICIENT OF SOLUTION FOR MONO-CHROMATIC RADIATION:

	PAGE.
Introduction.....	6
Statement of the problem.....	9
Historical.....	10
Apparatus.....	12
Procedure.....	14
Errors and corrections.....	17
THE ABSORPTION COEFFICIENT OF THE SOLVENTS:	
Water.....	18
Methyl alcohol.....	20
Ethyl alcohol.....	21
Propyl alcohol.....	21
Iso-butyl alcohol.....	21
Iso-amyl alcohol.....	21
Discussion of results with the solvents.....	21
THE ABSORPTION COEFFICIENT OF THE SOLUTIONS:	
Cobalt chloride in water.....	23
Cobalt chloride in methyl alcohol.....	26
Cobalt chloride in ethyl alcohol.....	29
Cobalt chloride in propyl alcohol.....	31
Cobalt chloride in iso-butyl alcohol.....	32
Cobalt chloride in iso-amyl alcohol.....	33
Discussion of results for cobalt chloride.....	35
Cobalt chloride in methyl alcohol with water.....	36
Cobalt chloride in ethyl alcohol with water.....	37
Cobalt chloride in propyl alcohol with water.....	40
Cobalt nitrate in water.....	40
Cobalt sulphate in water.....	43
Nickel chloride in water.....	47
Hydrated nickel chloride in the alcohols.....	51
Nickel nitrate in water.....	54
Nickel sulphate in water.....	59
Ferric ammonium sulphate in water.....	62
Chromium chloride in water.....	64
Chromium nitrate in water.....	66
Chromium sulphate in water.....	67
Potassium permanganate in water.....	67
Conclusion.....	69

## CHAPTER II.

### THE CONDUCTIVITY AND VISCOSITY OF CERTAIN ORGANIC AND INORGANIC SALTS IN FORMAMID AND IN MIXTURES OF FORMAMID WITH ETHYL ALCOHOL:

Introduction.....	71
Experimental.....	72
Preparation of the solvents.....	72
Preparation of the salts.....	73
Preparation of the solutions.....	73
Apparatus.....	73
Procedure.....	75

Tables:	PAGE.
Ammonium nitrate in formamid.....	76
Potassium nitrate in formamid.....	77
Sodium nitrate in formamid.....	77
Calcium nitrate, barium nitrate.....	78
Strontium nitrate.....	79
Rubidium formate.....	79
Ammonium formate.....	80
Sodium formate.....	80
Lithium formate.....	81
Barium formate.....	81
Strontium formate.....	82
Sodium benzoate.....	82
Sodium metabrombenzoate.....	83
Sodium metamido benzoate.....	83
Sodium dinitro benzoate.....	84
Sodium salicylate.....	84
Sodium benzene sulphonate.....	85
Sodium succinate.....	85
Tetraethylammonium iodide in formamid with alcohol.....	86
Rubidium iodide in formamid with alcohol.....	87
Lithium nitrate in formamid with alcohol.....	89
Calcium nitrate in formamid with alcohol.....	90
Discussion of results.....	91

### CHAPTER III.

#### A NOTE ON THE VISCOSITY OF CÆSIUM SALTS IN GLYCEROL-WATER MIXTURES:

Cæsium chloride.....	97
Cæsium nitrate.....	98

### CHAPTER IV.

#### A STUDY OF THE ELECTRICAL CONDUCTANCE OF THE SODIUM SALTS OF CERTAIN ORGANIC ACIDS IN ABSOLUTE ETHYL ALCOHOL AT 15°, 25°, AND 35°:

Introduction.....	99
Historical.....	99
Experimental.....	103
Reagents.....	103
Apparatus.....	105
Procedure.....	106
Measurements:	
Explanation of tables.....	109
Sodium formate and acetate.....	109
Sodium monochloro, dichloro, trichloro, and phenyl acetates: propionate and ido-propionate; butyrate and oxy isobutyrate.....	110
Sodium benzoate; ortho amido and p-amido benzoates, m- and p-brombenzoates; o-, m-, and p-chlorobenzoates.....	111
Sodium salicylate; m- and p-hydroxybenzoates; acetyl, iodo and sulphosalicylates; o- and meta nitrobenzoates.....	112
Sodium p-nitro and 2.4 dinitro benzoates, ortho, meta, and paratoluates and picrate.....	113
Discussion of results.....	113
Summary.....	118

CHAPTER V.

A STUDY OF THE DISSOCIATING POWER OF FREE AND OF COMBINED WATER:		PAGE.
Introduction.....		119
Experimental.....		119
Apparatus.....		119
Solvents.....		121
Salts.....		122
Solutions.....		123
Procedure.....		124
Measurements.....		125
Tables.....	125-127	
Discussion of results.....		127

CHAPTER VI.

THE DIFFERENCE IN CHEMICAL ACTIVITY OF FREE AND SEMI-COMBINED WATER AS ILLUSTRATED BY THE EFFECT OF NEUTRAL SALTS ON THE HYDROLYSIS OF ACETIC ANHYDRIDE:		
Hydrolysis.....		131
Hydrolysis of acetic anhydride.....		131
Hydrolysis of salts.....		134
Neutral salt action.....		134
Effect of neutral salts on catalytic activity of acids.....		135
Effect of neutral salts on hydrolysis by water alone.....		135
Statement of the problem.....		137
Experimental:		
Purification of acetic anhydride.....		137
Purification of salts.....		138
Apparatus.....		138
Solutions.....		138
Method of procedure.....		139
Calculations.....		140
Data.....	140-143	
Discussion of results.....		143



---

---

STUDIES ON SOLUTION IN ITS RELATION TO LIGHT  
ABSORPTION, CONDUCTIVITY, VISCOSITY,  
AND HYDROLYSIS

---

A REPORT UPON A NUMBER OF EXPERIMENTAL INVESTIGA-  
TIONS CARRIED OUT IN THE LABORATORY OF THE  
LATE PROFESSOR HARRY C. JONES

---

Compiled by PAUL B. DAVIS



## CHAPTER I.

### THE ABSORPTION COEFFICIENT OF SOLUTION FOR MONOCHROMATIC RADIATION.

---

BY E. O. HULBURT AND J. F. HUTCHINSON.

---

#### INTRODUCTION.

##### STATEMENT OF THE PROBLEM.

Experiments have shown that in the case of certain solutions the absorption of monochromatic radiation may be represented by the formula

$$I = I_0 \times 10^{-\alpha t} \quad (1)$$

where  $I_0$  is the original intensity of the radiation,  $I$  is the intensity of the radiation after passing through a layer of solution of thickness  $t$  millimeters, and  $\alpha$  is a quantity, called the *absorption coefficient* of the solution for the specified frequency of radiation.

Experiments have also shown that different values of  $\alpha$  are obtained if there is any change in:

- (a) the nature of the solvent or of the dissolved substance.
- (b) the concentration of the solution.
- (c) the temperature.
- (d) the wave-length of the radiation, etc.

To solve the problem of light-absorption in solutions it is necessary to determine the explicit form of the relation between the absorption coefficient  $\alpha$  and the quantities of which it is a function. At present our knowledge is far too meager to indicate more than a qualitative idea of the nature of this relation.

In the present investigation  $\alpha$  has been measured in those regions of the spectrum where the pure solvents possess appreciable absorption. It is assumed that the total absorption of the solution is the sum of two parts, the first being the absorption due to the presence of the salt, the second being the absorption due to the pure solvent. In calculating this second part, it is assumed that the absorption due to the solvent is the same as it would be if there were no dissolved salt present. We therefore write

$$\alpha = A c + \alpha_0$$

where  $\alpha_0$  is the absorption coefficient for the pure solvent,  $c$  is the concentration in gram-molecules of salt per liter of solution, and  $A$  is called the *molecular absorption coefficient* of the salt in the solution. From this relation it follows that

$$A = \frac{\alpha - \alpha_0}{c} \quad (2)$$

The present investigation has consisted of a systematic and thorough study of the absorption coefficient  $\alpha$ . This quantity has been measured at intervals of  $20\mu\mu$  to  $40\mu\mu$  throughout the region of the spectrum from  $600\mu\mu$  to  $1,300\mu\mu$  for many solutions. The work has been restricted to a study of inorganic salts in aqueous and alcoholic solution. All the measurements have been carried out with solutions at room temperature. The values of  $\alpha$ , when plotted as ordinates against the corresponding wave-lengths as abscissas, form the *absorption curve*. For each salt a series of solutions varying in concentration from saturation to moderate dilution was prepared and the *absorption curve* has been drawn for each solution. From the measured values of  $\alpha$  and  $\alpha_0$  and from the known value of  $c$ ,  $A$  has been calculated for each wave-length by means of formula (2). The values of  $A$  for a given wave-length have been plotted as ordinates against the corresponding values of  $c$  as abscissas. The curves thus formed will be referred to as the  $A$ - $c$  curves. It was the purpose of the present investigation to determine the form of the  $A$ - $c$  curves.

#### HISTORICAL.

The general problem of the absorption of radiation by solutions has been the subject of many investigations. Only those papers are of primary interest here which concern determinations of the numerical values of the absorption coefficient as a function of the concentration.

Beer<sup>1</sup> measured the absorption coefficient for red light of a number of aqueous solutions of inorganic salts. The results of his experiments showed that within the error of experiment  $A$  was a constant with respect to  $c$ . The statement that " $A$  is a constant" has been mentioned by subsequent workers in this field as "*Beer's law*." This "*law*" has since been shown to be the exception rather than the rule, and therefore in this paper but few references have been made to "*Beer's law*."

A paper by Rudorf<sup>2</sup> entitled "*Lichtabsorption in Lösungen vom Standpunkt der Dissociationstheorie*" reviews the literature up to the year 1904 and gives a very good statement of the conclusions reached at that time. Rudorf concluded the section of his paper concerning Beer's law with the following observation:

---

<sup>1</sup>Pogg. Ann., **86**, 78 (1882).

<sup>2</sup>Sammlung Chemischer und Chemisch-Technischer Vorträge, **9**, 1 (1904).



"We have seen that in general Beer's law can be true only within certain limits, though many observers believe that it holds accurately within wide limits. The experimental data is in many cases unsatisfactory, and in still others contradictory."

A survey of the literature since 1904 bearing on the relation between  $A$  and  $c$  yields few definite conclusions. The reason for the unsettled state of the problem is not difficult to find. None of the researches has been carried out with the necessary completeness. The investigators have been content with a determination of the molecular absorption coefficient  $A$  for a few concentrations at a very limited number of points of the spectrum.

In 1906 Müller<sup>1</sup> measured  $A$  for three solutions of copper chloride in water. The values of  $A$  were determined for 5 wave-lengths in that part of the visible region of the spectrum where this solution was fairly transparent. Müller's results showed that  $A$  was not only variable with  $c$ , but also that the rate of variation was different for each wave-length.

Hantzsch<sup>2</sup> and his co-workers (the reference is to the final one of a series of papers) have recorded the value of  $A$  for a number of solutions of inorganic colored salts.  $A$  was measured for a single wave-length for a few concentrations and was found in general to decrease with  $c$  in the case of the monochromates, the ferrocyanides, and the permanganates of the alkali metals, and to be fairly constant for dilute solutions of certain organic colored salts.

Sheppard,<sup>3</sup> in his researches, has included determinations of  $A$  for alcoholic solutions of a few dyes. The values of  $A$  were constant within the error of experiment, except for the most dilute solutions, where they experienced a perceptible increase, which was ascribed to chemical change taking place in the solution.

Garrett<sup>4</sup> has recorded the values of  $A$  for aqueous solutions of a number of salts of copper.  $A$  was determined for 3 wave-lengths on the violet side of the red absorption band for 3 concentrations and was found in all cases to decrease with dilution.

In the work thus far cited the values of  $A$  have been determined for wave-lengths lying in the visible region of the spectrum by means of a visual spectro-photometer.

The photographic method of testing Beer's law, as used by previous workers in this laboratory,<sup>5</sup> is applicable to both the ultra-violet and visible regions of the spectrum. This method, however, yields information concerning the variations of  $A$  with  $c$  only for those wave-lengths on the edge of an absorption band. In studying a large number of solutions in this way, many bands were found whose edges obeyed Beer's law and many more whose edges did not.

---

<sup>1</sup>Ann. d. Phys., **21**, 515 (1906).

<sup>4</sup>Zeit. Elektrochem., **19**, 1 (1913).

<sup>2</sup>Zeit. phys. chem., **84**, 321 (1913).

<sup>5</sup>Carnegie Inst. Wash. Pub. Nos. 110, 130, 160, 190.

<sup>3</sup>Journ. Chem. Soc., **95**, 15 (1909); Proc. Roy. Soc., **82-A**, 256 (1909).

A very important quantitative study of the light-absorption of solutions has been carried out by Houstoun and his co-workers<sup>1</sup> (the reference is to the last of a series of eleven papers). Many phases of the general problem were considered and frequent reference will be made here to the separate papers. His work is unique in that it is the only record we have of the determination of  $A$  for solutions for wave-lengths in the infra-red. Even this work, although of a more complete character than any of the researches hitherto attempted, did little more than touch upon the relation between  $A$  and  $c$ . The absorption curves were determined for the region of the spectrum from  $645\mu\mu$  to  $1,270\mu\mu$  for the chloride, bromide, iodide, nitrate, and sulphate of cobalt.<sup>2</sup> This was done for a strong and for a dilute aqueous solution of each salt. In all cases the values of  $A$  for the more concentrated solution were found to be greater than the corresponding values for the dilute solution.

Houstoun also made a further study of the chloride and bromide of cobalt, nickel, iron, and copper.<sup>3</sup> Solutions of each salt were prepared varying in concentration from saturation to moderate dilution.  $A$  was determined for a single wave-length lying on the edge of an absorption band. The results for nickel chloride as an example are given in table 1. The values of  $A$  are seen to decrease with dilution reaching a minimum value, and then to remain fairly constant. Table 1 and other similar tables show that  $A$  increased again for the more dilute solutions. This increase was considered either as within the error of experiment or due to the chemical change taking place in the solution.

In all of Houstoun's work  $A$  was determined by comparing a cell containing the solution with a cell of the same thickness containing the pure solvent. This method is open to criticism, but the difference between the  $A$  thus determined and the true value was probably less than the errors in the values of  $A$  due to other experimental causes.

TABLE 1.—*Nickel Chloride in Water.*  
Wave-length  $434\mu\mu$ .

$C$	$A$
4.09	0.0265
3.07	0.0164
2.27	0.0127
2.05	0.0117
0.76	0.0103
0.34	0.0096
0.17	0.0094
0.085	0.0104

#### APPARATUS.

The apparatus used for determining the coefficient of light-absorption has been developed by previous workers in the Johns Hopkins laboratory. The quantitative work was begun by Guy,<sup>4</sup> who built a sensitive radiomicrometer and used this in connection with a glass-prism spectrograph. The apparatus was greatly improved by Shaeffer<sup>5</sup> during the following year, and the apparatus used in the present investigation and described in this paper is the same in all respects, except for minor details, as that used by Shaeffer and his co-workers.

<sup>1</sup>Proc. Roy. Soc. Edinburgh, **33**, 156 (1912-13). <sup>2</sup>*Ibid.*, **31**, 521 (1910-11). <sup>3</sup>*Ibid.*, **33**, 147 (1912-13).

<sup>4</sup>Carnegie Inst. Wash. Pub. No. 190, 29 (1913).

<sup>5</sup>*Ibid.*, 230, 44 (1915).

The arrangement of the apparatus is shown in figure 1. The light from a Nernst glower  $g$ , operated at 110 volts on 0.8-ampere direct current from a constant potential storage battery, was rendered parallel by a lens  $l_1$ , 3.8 cm. in diameter and with a focal length of 20 cm. The light after passing through cell  $K'$  was focussed on the slit  $A$  of the spectrograph by a second lens  $l_2$ , 3.8 cm. in diameter and with a focal length of 20 cm. A shutter  $s$  was placed between the glower  $g$  and lens  $l_1$ , by means of which the light could be turned on and off.

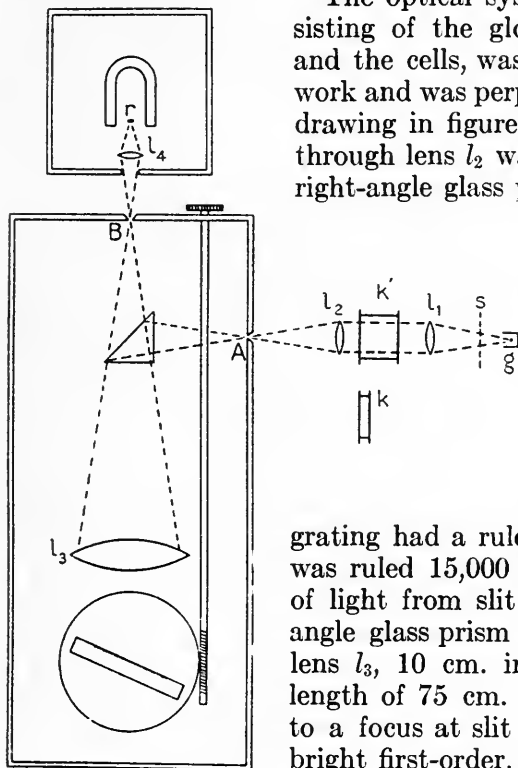

FIG. 1.—Schematic diagram of apparatus.

wide a beam of light containing a wave-length range of  $20 \text{ \AA}$ . or  $2\mu\mu$  passed through. In this work both slit  $A$  and slit  $B$  were always 1 mm. in width. The grating was mounted on a turntable, which was rotated from the outside by a worm-screw, thus causing various wave-lengths to pass through slit  $B$ . The approximately monochromatic beam of light from slit  $B$  was focussed on the junction of the radiomicrometer  $r$  by a lens  $l_4$ , 3.5 cm. in diameter and with a focal length of 6 cm.

A complete description of the construction of the radiomicrometer is given in Shaeffer's paper.<sup>1</sup> To eliminate the drift of the zero-point

The optical system thus far described, consisting of the glower, the two lenses  $l_1$  and  $l_2$ , and the cells, was held by a solid metal framework and was perpendicular to the plane of the drawing in figure 1. The light after passing through lens  $l_2$  was reflected onto slit  $A$  by a right-angle glass prism (not shown in figure 1) close to slit  $A$ .

The temperature of the solution was recorded by a thermometer not placed in the solution but fastened on the metal frame supporting the cells.

The spectrograph consisted of the Littrow mounting of a plane grating. The grating had a ruled area 6 cm. by 7.5 cm. and was ruled 15,000 lines to the inch. The cone of light from slit  $A$  was reflected by a right-angle glass prism through the large achromatic lens  $l_3$ , 10 cm. in diameter and with a focal length of 75 cm. The spectrum was brought to a focus at slit  $B$ . The grating possessed a bright first-order, and this first-order spectrum was used throughout the present work. The dispersion was such that with slit  $B$  1 mm.

<sup>1</sup>Carnegie Inst. Wash. Pub. No. 230, p. 44.

of the instrument, due to temperature changes in the air of the room, it was encased in a large box surrounded with an excelsior packing. When the room temperature was kept fairly constant, the drift was negligible. Occasionally readings were taken in the presence of a slight drift, and in this case the zero was redetermined after each deflection and one-half the drift added to the observed deflection. The deflections of the radiomicrometer were observed on a ground-glass scale at a distance of 5 meters. This scale was placed on the table on which was mounted the Nernst glower and cells. This arrangement enabled a single observer to carry out all the measurements, *i. e.*, to manipulate the cells, to watch the glower current, and to read the deflections.

The cells, which were made by Shaeffer<sup>1</sup> and described in his paper, were used in the present work on a few salts only. These cells, which were of brass, gold-plated, and of adjustable depth, although perfectly workable, were found to be somewhat clumsy for this investigation. A cell was required which could be easily and quickly opened, cleaned, and filled. The form of cell finally chosen was very satisfactory. This cell (fig. 2) consisted simply of a glass ring, 4.2 cm. in diameter, closed on each end by a plane-parallel plate of glass 2 mm. thick. The glass ring was ground to a uniform thickness within

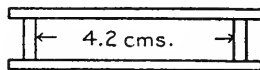

FIG. 2.—Cross-section of cell.

0.001 inch. It was found unnecessary to cement the glass plates on the glass ring. To fill the cell the glass ring was placed on the bottom plate, the solutions poured in, and the upper plate slid on. In the case of water solutions, the cell thus filled was quite tight and remained free from bubbles for several hours; in the case of solutions of methyl alcohol small bubbles appeared in about half an hour. It was sometimes convenient to seal the bottom plate on to the glass ring with rubber cement. Six cells were made varying in thickness from 1.844 to 21.996 mm. A thick cell  $K'$  and a thin cell  $K$  (fig. 1), were held in a frame (not shown in fig. 1) and either in turn could be quickly interposed in the path of the light.

#### PROCEDURE.

The solution for which  $\alpha$  was to be determined was placed in two cells exactly alike, except that one was thin and the other thick. The energy  $I$  of the monochromatic beam of light after passing through the thin cell containing a thickness  $h$  of solution, and the energy  $I'$  after passing through the thick cell containing a thickness  $h'$  of solution, were measured in arbitrary units—*i. e.*, deflections of the radiomicrom-

<sup>1</sup>Carnegie Inst. Wash. Pub. No. 230, p. 50.

eter. If the initial intensity,  $I_0$ , of the light falling on the cell was the same in each case:

$$I = I_0 \times 10^{-ah} \quad I' = I_0 \times 10^{-ah'} \quad \therefore \alpha = \frac{1}{h' - h} \log_{10} \frac{I}{I'} \quad (3)$$

or

$$\alpha = \frac{1}{t} \log_{10} \frac{d}{d'}$$

where  $d$  and  $d'$  are the deflections produced by  $I$  and  $I'$ , respectively, and  $t$  is the difference in thickness in millimeters of the two cells. This method eliminated all corrections for reflections from the glass surfaces and thus gave  $\alpha$  directly.

For the study of each salt, solutions of the salt in the solvent were prepared varying in concentration from saturation to moderate dilution. The absorption curve for each solution was then drawn. This involved the determination of  $\alpha$  at intervals of  $20\mu\mu$  to  $40\mu\mu$  throughout the available region of the spectrum—*i. e.*, from  $600\mu\mu$  to  $1,300\mu\mu$ .

The experimental procedure was as follows: The two cells, filled with the solution whose absorption was to be measured, were mounted in place in their frame and were adjusted until the image of the Nernst glower on slit  $A$  suffered no displacement when either cell was interposed in the path of the light. The zero-reading of the radiomicrometer was taken, and then the deflections were noted for each cell in turn in the path of the light. This was done for each wave-length, the shutter ( $s$ , fig. 1) being closed, usually after every four readings, to see if the zero remained unchanged. Readings were taken for wave-length intervals of  $20\mu\mu$  to  $40\mu\mu$  throughout the entire available spectrum, and the whole set was repeated in reverse order. Thus each point on an absorption curve, *i. e.*, each measurement of  $\alpha$ , was the mean of two, and often more, separate determinations.

As an illustration of the method of procedure, the complete readings for a solution of  $\text{NiSO}_4$  in water are given in table 2.

The data from which the curves have been plotted are arranged in tables. For each solution the following data are recorded in these tables: the temperature of the solution in degrees centigrade;  $t$ , the difference in thickness of the two cells;  $c$ , the concentration in gram-molecules of salt per liter of solution; the values of  $\alpha$  calculated from equation (3); and the values of  $A$  calculated from equation (2).

The short-wave limit of the absorption curves is at about  $600\mu\mu$  because the deflections of the radiomicrometer for light of wave-length shorter than  $600\mu\mu$  are too small to give accurate values of  $\alpha$ . The long-wave limit is at about  $1,200\mu\mu$ , although the limit set by the transparency of glass is at about  $2,000\mu\mu$ . The reason for this was that in order to study regions beyond  $1,200\mu\mu$  a color screen had to be used. Wave-length  $1,200\mu\mu$  in the first-order is overlapped by wave-length  $600\mu\mu$  of the second-order. A thin layer of a strong solution of chro-

mium chloride in water served as a color screen, and such a screen was used whenever  $\alpha$  was determined for wave-lengths greater than  $1,200\mu\mu$ . This absorbs the light up to  $700\mu\mu$  (see fig. 24) and is transparent for wave-lengths above this. Water itself is quite opaque above  $1,300\mu\mu$  (see fig. 3) and hence this screen cut down the deflections to such an extent that the values for  $\alpha$  were liable to great inaccuracy. In most cases, therefore, the long-wave limit of the absorption curves is at about  $1,200\mu\mu$ .

TABLE 2.—*Nickel Sulphate in Water.*  
Temperature  $18.6^\circ$ .  $t=10$  mm.  $c=0.4$ .

Wave-length.	Deflections of radiomicrometer, in millimeters.				$d/d'$		$d/d'$	$\alpha$
	Cell of thickness =11 mm.		Cell of thickness =1 mm.					
	$d'$		$d$				Mean.	
545 $\mu\mu$	30	30	37	37	1.25	1.25	1.25	0.0097
865	38	38	49	50	1.29	1.31	1.30	0.0114
585	38	38	59	63	1.55	1.66	1.55	0.0204
605	34	35	71	74	2.08	2.10	2.09	0.0320
625	25	25	82	77	3.28	3.08	3.18	0.0502
644	17	17	89	89	5.22	4.94	5.09	0.0707
664	19	17	110	95	5.80	5.60	5.70	0.0756
684	21	19	131	110	6.22	5.80	6.01	0.0779
704	20	19	142	127	7.10	6.68	6.89	0.0838
724	20	21	156	140	7.80	6.67	7.23	0.0859
744	26	27	171	168	6.58	6.22	6.40	0.0806
764	41	43	188	186	4.58	4.33	4.45	0.0648
783	55	63	178	198	3.24	3.15	3.20	0.0505
803	81	91	192	212	2.37	2.33	2.35	0.0371
823	110	117	207	221	1.88	1.89	1.89	0.0277
842	130	141	215	230	1.66	1.63	1.65	0.0218
861	151	158	223	234	1.48	1.48	1.48	0.0170
881	158	165	227	236	1.44	1.43	1.44	0.0158
901	159	158	232	229	1.46	1.45	1.46	0.0164
920	149	149	233	228	1.57	1.53	1.55	0.0190
940	129	123	232	222	1.80	1.81	1.81	0.0258
960	85	86	221	214	2.60	2.49	2.55	0.0407
979	74	78	222	233	3.00	2.98	2.99	0.0476
998	63	70	216	229	3.43	3.26	3.34	0.0524
1018	61	58	220	212	3.61	3.64	3.63	0.0560
1037	52	53	211	207	4.06	3.90	3.98	0.0600
1056	41	43	185	196	4.51	4.56	4.53	0.0656
1076	33	37	177	190	5.36	5.13	5.24	0.0719
1095	28	27	173	177	6.18	6.56	6.37	0.0804
1115	23	24	168	167	7.30	6.96	7.13	0.0853

Kahlbaum materials were used, and when possible the salts were purified by recrystallization. In preparing the solutions a uniform method was adopted. A solution saturated at room temperature was prepared, and the concentration was determined by a standard method. The solutions of lower concentration were then prepared by diluting this mother solution.

## ERRORS AND CORRECTIONS.

The values of  $a$  and of  $A$  have been plotted against wave-length and concentration respectively. It was thought better to connect the plotted points by straight lines rather than to draw smooth curves through them. A glance at the figures shows that the absorption curves—*i. e.*, the curves of  $a$  against wave-length—are fairly smooth, but that the curves of  $A$  against  $c$  are quite irregular. The inaccuracy in the values of  $A$ , as shown by the irregularities in the curves, is quite large. In many cases the deviations of the broken line indicate as much as 10 per cent variations in  $A$ . The causes of such errors are many. Without going into tedious and obvious details, it is only necessary to state that the accurate determination of  $a$  depended upon the proper choice of cell depth, which was regulated by the actual value of the absorption coefficient, as well as upon the care used in preparing the solutions and in cleaning and adjusting the cells. Errors also resulted from the poor keeping qualities of certain solutions. The deflections of the radiomicrometer could be duplicated to within a millimeter. Hence the ratio of the deflections for each cell was usually accurate to within 2 per cent. In cases where the absorption coefficient was large, the deflection for the thick cell was small and the error proportionately greater. The values of  $a$  in the tables are considered to be accurate to within 3 per cent, the error being greater for very high and very low values of  $a$ .  $A$  was calculated from formula (2) and deviations of 5 to 10 per cent were within the error of experiment. The chance for error in  $A$  was much greater for the dilute solutions than for the more concentrated ones, so that it was the practice to make up the solutions below a concentration  $c=1$  in smaller steps than in the case of solutions for which  $c$  was greater than 1. The calculations of  $a$  and  $A$  have been carried out to three figures in most cases, although quite often the third figure is not significant.

The concentration  $c$  is defined to be the number of gram-molecules of salt per liter of *solution*, and the solutions were prepared in conformity with this. The calculation for  $A$ , however, has been made on the basis that  $c$  is the concentration in gram-molecules of salt per liter of *solvent*.

The procedure of calculating  $A$  by formula (2) presupposes that in 1 mm. layer of solution there is a 1 mm. layer of solvent plus the dissolved salt. This, however, is not strictly true, because the addition of the salt to the solvent produces sometimes expansion and sometimes contraction. The error in the value of  $A$  due to this is, however, negligible in comparison with the errors arising in other ways. For example, consider the case of an aqueous solution of  $\text{CoCl}_2$ , when  $c=1.90$ . At wave-length  $979\mu\mu$ ,  $a=0.0742$ . Assuming no expansion upon dissolving,

$$A = \frac{0.0742 - 0.0206}{1.90} = 0.0282$$

Correcting for expansion upon dissolving, using data from Landolt and Börnstein, we have

$$A = \frac{0.0742 - 0.0200}{1.90} = 0.0285$$

In this case the correction amounts to 1 per cent. Furthermore, the example just cited is one in which this correction is at its maximum. In the cases for solutions which are more dilute and for wave-lengths where the water absorption is smaller, this correction is much less.

In measuring absorption bands which are narrow in comparison with the range of wave-lengths passing through the second slit of the spectrograph, a correction for the finite width of the slit must be made. All of the bands studied in this investigation were so broad as to make such a correction negligible.

It should be noted that the spectrograph and radiomicrometer of this investigation are useful for a detailed quantitative study of band structure. At no time in the present work has the full resolving power of the instrument been called upon. Readings could be taken at wave-length intervals of  $4\mu\mu$  without fear of measuring overlapping regions of the spectrum.

## THE ABSORPTION COEFFICIENT OF THE SOLVENTS.

### WATER.

The water used throughout this investigation was the same as that used in the work on conductivity carried on in this laboratory. The water was dust-free and had a mean specific conductivity of  $1.8 \times 10^{-6}$  reciprocal ohms. In view of the fact that the values of  $a_0$  for water are used in the calculations of  $A$  for all the water solutions, the absorption curve of water was repeated 6 times, and the recorded values are thus each a mean of 12 separate measurements.

The absorption curve for water in this region of the spectrum has been drawn by one other observer, Aschkinass.<sup>1</sup> His curve is also plotted on figure 3 for the sake of comparison. The lack of agreement in the location of the position of the bands at  $979\mu\mu$  and at  $1,190\mu\mu$  is probably due to the fact that Aschkinass used a quartz-prism spectrograph. The determination of wave-lengths in this region of the spectrum is more uncertain in the case of the prism than the grating spectrograph. The values of  $a_0$  for the maximum of the sharp band at  $979\mu\mu$  given by Aschkinass are lower and those for the minimum at  $1,070\mu\mu$  higher than the corresponding values recorded in the present

<sup>1</sup>Wiedem. Ann., 55, 401 (1895).



work. These discrepancies between the values of  $\alpha_0$  are such as arise from the use of an instrument of low dispersion with relatively wide slit-widths. Although Aschkinass does not record the width of the slits, it is believed that the employment of different spectrographs is the cause of the differences in the values of  $\alpha_0$ .

For wave-lengths shorter than  $900\mu\mu$  the values of  $\alpha_0$  recorded here are much greater than those found by Aschkinass. The absorption of water is quite small in this region and probably Aschkinass is more nearly correct, for he was able to use longer cells for the measurements. However, the values of  $\alpha_0$  found in this work are the ones used for the calculations of  $A$ .

TABLE 3.—The Absorption Coefficient of the Solvents (Fig. 3).

Wave-length.	Water. Temp. = 20.0° $t=20$ mm.	Methyl alcohol. Temp. = 19.2° $t=20.2$ mm.	Ethyl alcohol. Temp. = 18.9° $t=20.2$ mm.	Propyl alcohol. Temp. = 19.5° $t=20.2$ mm.	Iso-butyl alcohol. Temp. = 18.9° $t=20.2$ mm.	Iso-amyl alcohol. Temp. = 18.0° $t=20.2$ mm.
605 $\mu\mu$	.....	.....	.....	.....	0.0002	.....
625	.....	.....	.....	.....	.0002	.....
644	.....	.....	.....	.....	.0004	.....
664	.....	.....	.....	.....	.0006	.....
684	.....	.....	.....	.....	.0006	.....
704	0.0010	0.0004	.....	.....	.0008	.....
724	.0015	.0004	.....	.....	.0010	.....
744	.0020	.0010	.....	.....	.0012	.....
764	.0020	.0007	.....	.....	.0012	.....
783	.0018	.0007	.....	.....	.0010	0.0002
803	.0017	.0010	.....	.....	.0010	.0004
823	.0018	.0012	.....	.....	.0010	.0004
842	.0026	.0010	0.0005	0.0004	.0010	.0004
861	.0028	.0010	.0015	.0009	.0012	.0004
881	.0032	.0016	.0016	.0012	.0018	.0010
901	.0036	.0043	.0045	.0034	.0038	.0028
920	.0046	.0052	.0038	.0055	.0046	.0050
940	.0082	.0027	.0036	.0030	.0038	.0028
959	.0191	.0034	.0028	.0026	.0028	.0022
978	.0206	.0055	.0036	.0026	.0024	.0016
998	.0181	.0071	.0051	.0043	.0041	.0032
1018	.0139	.0084	.0061	.0055	.0056	.0048
1037	.0099	.0081	.0058	.0053	.0048	.0043
1056	.0075	.0071	.0056	.0048	.0046	.0038
1075	.0071	.0063	.0050	.0045	.0045	.0032
1095	.0084	.0051	.0045	.0038	.0034	.0024
1114	.0106	.0045	.0038	.0036	.0030	.0022
1133	.0161	.0083	.0056	.0050	.0045	.0038
1151	.0430	.0192	.0138	.0157	.0160	.0151
1170	.0525	.0248	.0272	.0256	.0269	.0261
1190	.0532	.0495	.0495	.0536	.0583	.0599
1210	.0530	.0403	.0394	.0422	.0420	.0450
1229	.0521	.0243	.0306	.0314	.0318	.0311
1248	.0489	.0200	.0196	.0204	.0175	.0176
1267	.0467	.0192	.0154	.0151	.0130	.0122
1287	.0494	.0151	.0123	.0130	.0094	.0089
1306	.0564	.0135	.0111	.0103	.0081	.0074
1325	.0680	.0164	.0106	.0107	.0075	.0075
1344	.0685	.0262	.0149	.0132	.0111	.0102

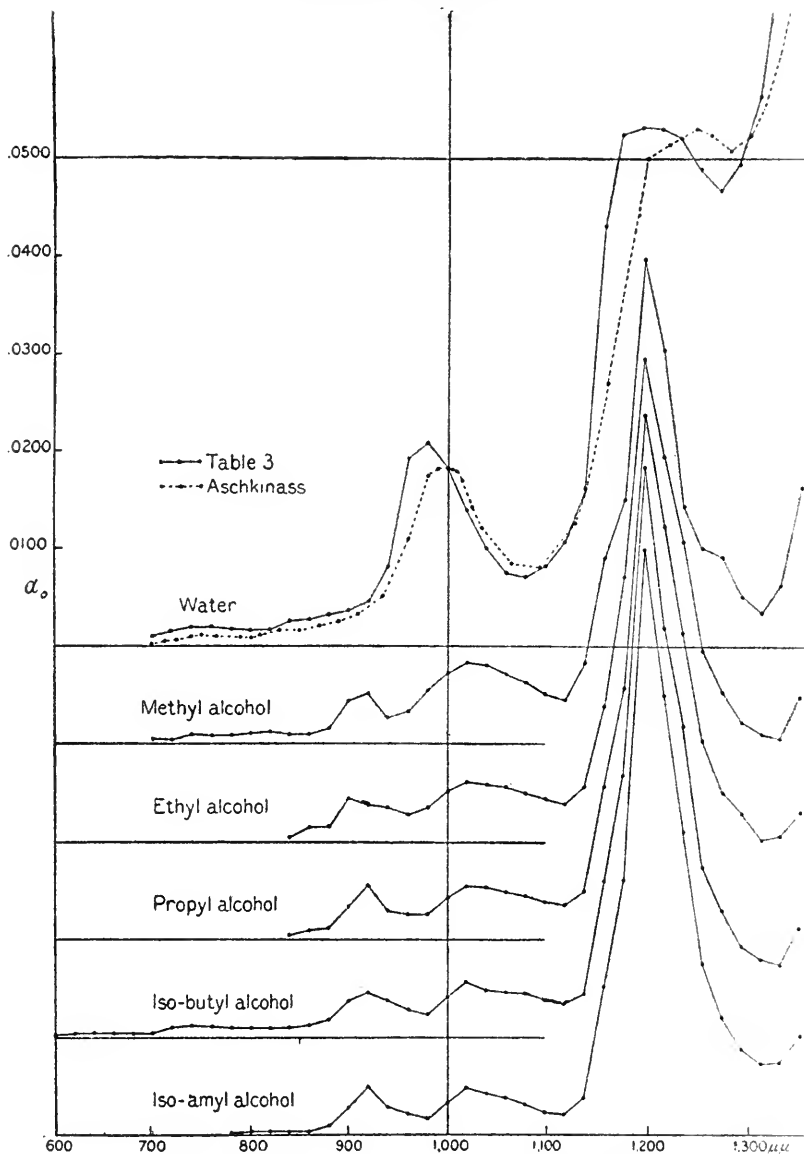

FIG. 3.—The Absorption Curves for the Solvents.

#### METHYL ALCOHOL.

The methyl alcohol was refluxed and distilled twice over lime and once over metallic calcium. Its specific gravity at 15° referred to water at 15° was 0.7956. The figure for anhydrous methyl alcohol given by the Bureau of Standards, Bulletin 19, page 22 (1916), is 0.79647. This indicates that the methyl alcohol used in this work was free from water. The absorption curve for this alcohol also indicates absence

of water, for the curve shows that the alcohol becomes transparent again at  $1,320\mu\mu$ , which would perhaps not be the case if water were present even in small quantities, as pure water is quite opaque at this point. Therefore it is believed that the maxima shown by this curve are characteristic of the alcohol and not of any impurity.

#### ETHYL ALCOHOL.

The ethyl alcohol was refluxed and distilled repeatedly over lime. Its density at  $25^\circ$  referred to water at  $4^\circ$  was 0.7851, which compares favorably with the figure 0.78506 given by the Bureau of Standards, Bulletin 19, page 7 (1916).

#### PROPYL ALCOHOL.

The propyl alcohol was refluxed and distilled once over lime. Its density at  $20^\circ$  referred to water at  $4^\circ$  was 0.8037. The figure for the anhydrous propyl alcohol given in Van Nostrand's Chemical Annual, 1913, page 312, is 0.80358.

#### ISO-BUTYL ALCOHOL.

The iso-butyl alcohol was refluxed and distilled twice over lime. Its specific gravity at  $20^\circ$  referred to water at  $20^\circ$  was 0.8033. The figure given by Biedermann, Chemiker Kalender, 1915, page 96, is 0.8031. This alcohol showed signs of slight cloudiness in the cell. The absorption curve also shows general slight absorption in the visible region of wave-lengths.

#### ISO-AMYL ALCOHOL.

The iso-amyl alcohol was refluxed and distilled once over lime. Its density at  $20^\circ$  referred to water at  $4^\circ$  was 0.8111. The figure given in Van Nostrand's Chemical Annual, 1913, page 278, is 0.8104.

#### DISCUSSION OF RESULTS WITH THE SOLVENTS.

The absorption curves for water and the five alcohols have been plotted together for the sake of comparison as shown in figure 3. All the curves have a common axis of ordinates; the zero of the ordinate axis is different for each curve, so that as a result each curve is transposed a convenient distance above the neighboring curve. The similarity in the positions of the maxima and minima of the curves and the concordance in the values of  $a_0$  at these points are interesting. Although the infra-red transmission of the alcohols has been studied by a number of observers,<sup>1</sup> no determinations of the absorption coefficients in the region from  $600\mu\mu$  to  $1,300\mu\mu$  have been recorded. The absorption spectra of the above five alcohols and many other substances have been photographed by Abney and Festing.<sup>2</sup> In their work the light was passed through a thickness of 3 inches or more of

<sup>1</sup>Kayser, Handbuch, vol. 3, p. 304.

<sup>2</sup>Phil. Trans. 172, 887 (1881).

liquid, and the spectrum was photographed throughout the region from  $600\mu\mu$  to  $1,280\mu\mu$  on special plates with a glass-prism spectroscope. Their spectrograms of the five alcohols used in this investigation show the existence of a very complicated set of absorption bands and sharp lines in this region of the spectrum. It was not possible, however, to identify any of these bands and lines with the maxima of the curves in figure 3, for these absorption curves have not been drawn with the necessary detail.

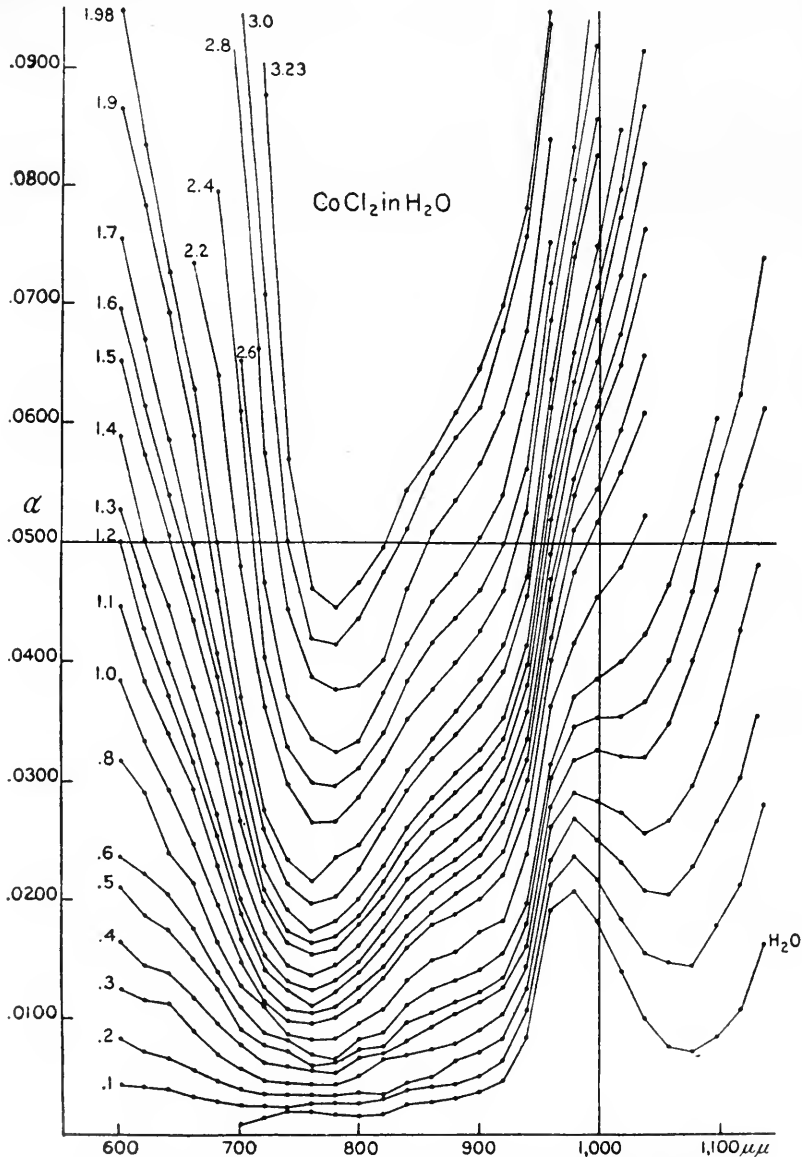

FIG. 4.—The Absorption Curves for Cobalt Chloride in Water.

## THE ABSORPTION COEFFICIENT OF THE SOLUTIONS.

### COBALT CHLORIDE IN WATER.

Twenty-three solutions were prepared varying in concentration from  $c=3.23$  to  $c=0.1$ . The more concentrated solutions were quite stable and showed no signs of decomposition, even after standing in the bottles for several days. In the more dilute solutions, however, there appeared a flocculent precipitate which increased their absorption materially. On this account a second set of solutions, whose concentrations varied from  $c=1.0$  to  $c=0.1$ , was prepared and the measurements of these appear in table 4.

The absorption curves include the long-wave side of the yellow-green cobalt absorption band and the short-wave side of the infra-red band, and show the region of transmission between the two bands. The minimum of absorption is at  $764\mu\mu$ .

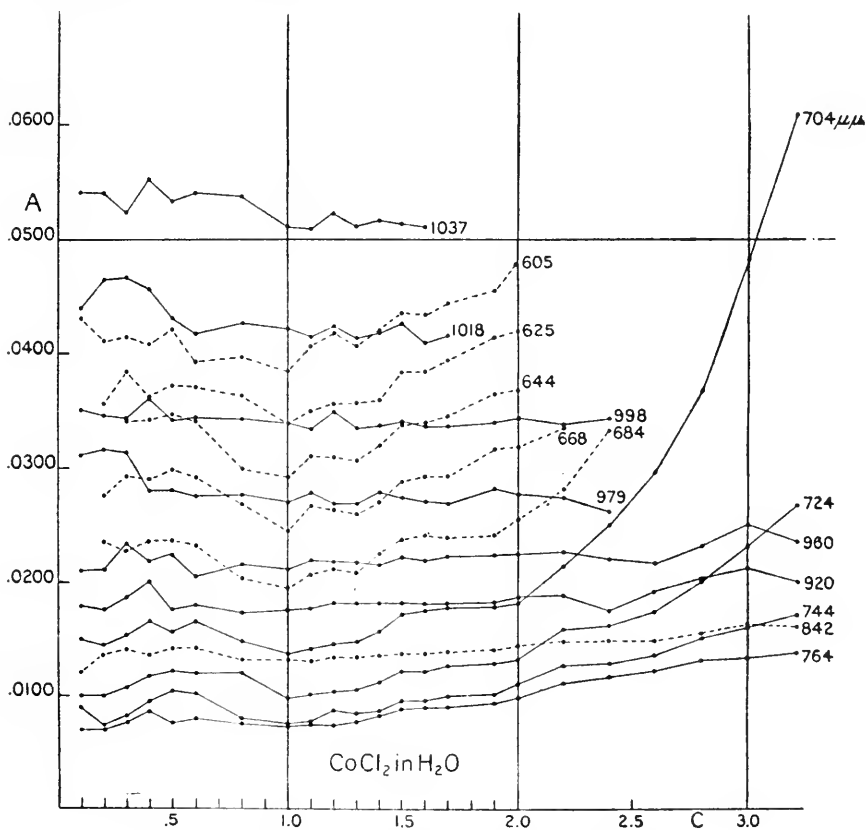

FIG. 5.—The A-c Curves for Cobalt Chloride in Water.

TABLE 4.—Cobalt Chloride in Water (Figs. 4 and 5).

Wave-length.	Temp. = 16.5° <i>t</i> = 5 mm. Conc. = 3.227		Temp. = 15.7° <i>t</i> = 5 mm. Conc. = 3.0		Temp. = 15.7° <i>t</i> = 5 mm. Conc. = 2.8		Temp. = 15.9° <i>t</i> = 5 mm. Conc. = 2.6		Temp. = 17.8° <i>t</i> = 10 mm. Conc. = 2.4		Temp. = 18.3° <i>t</i> = 10 mm. Conc. = 2.2	
	<i>a</i>	<i>A</i>	<i>a</i>	<i>A</i>	<i>a</i>	<i>A</i>	<i>a</i>	<i>A</i>	<i>a</i>	<i>A</i>	<i>a</i>	<i>A</i>
664 $\mu$	.....	.....	.....	.....	.....	.....	.....	.....	0.0795	.....	0.0735	0.0334
684	.....	.....	.....	.....	.....	.....	.....	.....	0.0331	.....	0.0640	0.0281
704	0.197	0.0609	0.146	0.0483	0.0104	0.0367	0.0652	0.0297	0.0610	0.0250	0.0480	0.0214
724	0.0876	0.0268	0.0708	0.0231	0.0578	0.0201	0.0466	0.0174	0.0403	0.0162	0.0362	0.0158
744	0.0571	0.0171	0.0501	0.0161	0.0444	0.0151	0.0370	0.0135	0.0328	0.0128	0.0296	0.0126
764	0.0461	0.0138	0.0418	0.0133	0.0387	0.0131	0.0335	0.0122	0.0298	0.0116	0.0265	0.0111
783	0.0445	0.0133	0.0413	0.0132	0.0376	0.0128	0.0324	0.0118	0.0296	0.0116	0.0265	0.0112
803	0.0466	0.0139	0.0435	0.0140	0.0380	0.0129	0.0334	0.0122	0.0311	0.0122	0.0286	0.0122
823	0.0496	0.0148	0.0475	0.0152	0.0401	0.0137	0.0374	0.0137	0.0340	0.0134	0.0316	0.0136
842	0.0545	0.0161	0.0512	0.0162	0.0461	0.0155	0.0415	0.0149	0.0383	0.0149	0.0352	0.0148
861	0.0576	0.0170	0.0558	0.0177	0.0510	0.0172	0.0450	0.0162	0.0416	0.0162	0.0376	0.0158
881	0.0610	0.0179	0.0590	0.0186	0.0536	0.0180	0.0474	0.0170	0.0437	0.0169	0.0398	0.0167
901	0.0647	0.0190	0.0615	0.0193	0.0568	0.0190	0.0505	0.0180	0.0460	0.0177	0.0426	0.0177
920	0.0701	0.0200	0.0680	0.0212	0.0610	0.0201	0.0542	0.0191	0.0500	0.0175	0.0460	0.0188
940	0.0783	0.0218	0.0760	0.0225	0.0680	0.0213	0.0626	0.0209	0.0564	0.0201	0.0526	0.0202
960	0.0950	0.0235	0.0940	0.0250	0.0841	0.0232	0.0755	0.0217	0.0720	0.0220	0.0689	0.0226
979	.....	.....	.....	.....	.....	.....	.....	.....	0.0834	0.0261	0.0807	0.0274
998	.....	.....	.....	.....	.....	.....	.....	.....	0.100	0.0342	0.0921	0.0336

Wave-length.	Temp. = 21.3° <i>t</i> = 10 mm. Conc. = 1.98		Temp. = 22.0° <i>t</i> = 10 mm. Conc. = 1.9		Temp. = 22.8° <i>t</i> = 10 mm. Conc. = 1.7		Temp. = 23.4° <i>t</i> = 10 mm. Conc. = 1.6		Temp. = 23.8° <i>t</i> = 10 mm. Conc. = 1.5		Temp. = 22.3° <i>t</i> = 10 mm. Conc. = 1.	
	<i>a</i>	<i>A</i>	<i>a</i>	<i>A</i>	<i>a</i>	<i>A</i>	<i>a</i>	<i>A</i>	<i>a</i>	<i>A</i>	<i>a</i>	<i>A</i>
605 $\mu$	0.0948	0.0478	0.0865	0.0455	0.0755	0.0444	0.0695	0.0434	0.0652	0.0435	0.0589	0.0420
625	0.0834	0.0418	0.0783	0.0413	0.0670	0.0391	0.0614	0.0384	0.0574	0.0383	0.0502	0.0359
644	0.0726	0.0366	0.0692	0.0364	0.0587	0.0345	0.0540	0.0338	0.0506	0.0337	0.0446	0.0319
664	0.0629	0.0317	0.0590	0.0315	0.0498	0.0293	0.0471	0.0294	0.0434	0.0289	0.0378	0.0270
684	0.0500	0.0255	0.0458	0.0241	0.0407	0.0239	0.0387	0.0241	0.0357	0.0237	0.0315	0.0225
704	0.0370	0.0182	0.0349	0.0179	0.0315	0.0179	0.0290	0.0175	0.0267	0.0171	0.0229	0.0156
724	0.0276	0.0132	0.0260	0.0129	0.0229	0.0126	0.0208	0.0121	0.0198	0.0122	0.0172	0.0112
744	0.0233	0.0108	0.0213	0.0101	0.0191	0.0100	0.0173	0.0096	0.0164	0.0096	0.0144	0.0087
764	0.0215	0.0098	0.0197	0.0093	0.0173	0.0090	0.0164	0.0090	0.0153	0.0089	0.0136	0.0083
783	0.0235	0.0110	0.0201	0.0096	0.0181	0.0096	0.0168	0.0094	0.0159	0.0094	0.0143	0.0089
803	0.0246	0.0116	0.0225	0.0109	0.0200	0.0108	0.0187	0.0106	0.0178	0.0107	0.0161	0.0103
823	0.0275	0.0130	0.0259	0.0127	0.0228	0.0124	0.0215	0.0125	0.0202	0.0123	0.0188	0.0121
842	0.0309	0.0143	0.0292	0.0140	0.0260	0.0138	0.0247	0.0138	0.0232	0.0137	0.0217	0.0136
861	0.0336	0.0156	0.0318	0.0153	0.0285	0.0151	0.0271	0.0152	0.0256	0.0152	0.0234	0.0147
881	0.0358	0.0165	0.0339	0.0162	0.0307	0.0162	0.0290	0.0162	0.0270	0.0159	0.0250	0.0156
901	0.0384	0.0175	0.0362	0.0171	0.0327	0.0171	0.0310	0.0171	0.0290	0.0170	0.0269	0.0167
920	0.0414	0.0186	0.0392	0.0182	0.0353	0.0181	0.0336	0.0181	0.0320	0.0182	0.0301	0.0182
940	0.0472	0.0197	0.0456	0.0197	0.0414	0.0195	0.0398	0.0198	0.0381	0.0199	0.0358	0.0198
960	0.0638	0.0224	0.0615	0.0223	0.0558	0.0222	0.0541	0.0218	0.0522	0.0221	0.0492	0.0215
979	0.0754	0.0276	0.0742	0.0282	0.0661	0.0268	0.0637	0.0270	0.0618	0.0274	0.0596	0.0278
998	0.0858	0.0342	0.0826	0.0338	0.0751	0.0335	0.0716	0.0335	0.0688	0.0338	0.0653	0.0336
1018	.....	.....	.....	.....	0.0848	0.0415	0.0798	0.0408	0.0776	0.0425	0.0725	0.0418
1037	.....	.....	.....	.....	.....	.....	0.0916	0.0510	0.0870	0.0513	0.0820	0.0516

TABLE 4.—Cobalt Chloride in Water—Continued.

Wave-length.	Temp. = 18.9° <i>t</i> = 10 mm. Conc. = 1.3		Temp. = 20.7° <i>t</i> = 10 mm. Conc. = 1.2		Temp. = 20.5° <i>t</i> = 10 mm. Conc. = 1.1		Temp. = 20.3° <i>t</i> = 20 mm. Conc. = 1.0		Temp. = 20.2° <i>t</i> = 20 mm. Conc. = 0.8		Temp. = 19.8° <i>t</i> = 20 mm. Conc. = 0.6	
	<i>a</i>	<i>A</i>	<i>a</i>	<i>A</i>	<i>a</i>	<i>A</i>	<i>a</i>	<i>A</i>	<i>a</i>	<i>A</i>	<i>a</i>	<i>A</i>
605 $\mu$	0.0528	0.0406	0.0500	0.0417	0.0447	0.0406	0.0384	0.0384	0.0317	0.0396	0.0235	0.0392
625	.0463	.0356	.0427	.0355	.0384	.0349	.0334	.0338	.0290	.0362	.0222	.0370
644	.0398	.0306	.0371	.0308	.0340	.0309	.0292	.0292	.0239	.0299	.0204	.0340
664	.0338	.0260	.0317	.0264	.0293	.0267	.0246	.0246	.0214	.0269	.0175	.0292
684	.0272	.0209	.0254	.0212	.0228	.0207	.0195	.0195	.0163	.0204	.0139	.0232
704	.0200	.0146	.0187	.0145	.0165	.0141	.0147	.0137	.0127	.0148	.0109	.0165
724	.0152	.0105	.0140	.0104	.0126	.0101	.0114	.0099	.0110	.0120	.0087	.0120
744	.0130	.0085	.0123	.0088	.0107	.0079	.0097	.0077	.0085	.0081	.0081	.0102
764	.0123	.0078	.0110	.0075	.0104	.0076	.0095	.0075	.0081	.0076	.0068	.0080
783	.0131	.0087	.0122	.0088	.0109	.0083	.0100	.0082	.0082	.0080	.0065	.0078
803	.0147	.0100	.0139	.0102	.0125	.0098	.0114	.0097	.0095	.0098	.0082	.0108
823	.0173	.0119	.0162	.0120	.0143	.0113	.0133	.0115	.0106	.0110	.0087	.0115
842	.0202	.0135	.0185	.0133	.0169	.0130	.0159	.0133	.0131	.0131	.0111	.0142
861	.0220	.0148	.0205	.0146	.0189	.0145	.0178	.0150	.0149	.0151	.0124	.0160
881	.0234	.0155	.0221	.0157	.0205	.0157	.0187	.0155	.0155	.0154	.0132	.0167
901	.0252	.0174	.0237	.0168	.0218	.0165	.0200	.0164	.0172	.0170	.0140	.0173
920	.0281	.0181	.0265	.0182	.0241	.0177	.0221	.0175	.0181	.0174	.0154	.0180
940	.0335	.0195	.0319	.0194	.0302	.0200	.0276	.0194	.0239	.0196	.0197	.0192
960	.0472	.0216	.0453	.0218	.0422	.0219	.0402	.0211	.0363	.0215	.0314	.0205
979	.0555	.0268	.0541	.0269	.0512	.0278	.0476	.0270	.0417	.0276	.0371	.0275
998	.0615	.0334	.0598	.0348	.0546	.0333	.0518	.0337	.0455	.0342	.0387	.0343
1018	.0676	.0413	.0648	.0424	.0596	.0414	.0560	.0421	.0480	.0426	.0400	.0417
1037	.0767	.0511	.0726	.0522	.0658	.0509	.0610	.0511	.0525	.0536	.0423	.0540
1056	.....	.....	.....	.....	.....	.....	.....	.....	.....	.....	.0466	.0652
1076	.....	.....	.....	.....	.....	.....	.....	.....	.....	.....	.0528	.0762
1095	.....	.....	.....	.....	.....	.....	.....	.....	.....	.....	.0607	.0872

Wave-length.	Temp. = 20.0° <i>t</i> = 20 mm. Conc. = 0.5		Temp. = 20.0° <i>t</i> = 20 mm. Conc. = 0.4		Temp. = 20.4° <i>t</i> = 20 mm. Conc. = 0.3		Temp. = 20.0° <i>t</i> = 20 mm. Conc. = 0.2		Temp. = 20.4° <i>t</i> = 20 mm. Conc. = 0.1	
	<i>a</i>	<i>A</i>	<i>a</i>	<i>A</i>	<i>a</i>	<i>A</i>	<i>a</i>	<i>A</i>	<i>a</i>	<i>A</i>
605 $\mu$	0.0210	0.0420	0.0163	0.0408	0.0124	0.0413	0.0082	0.0410	0.0043	0.0430
625	.0186	.0371	.0144	.0360	.0115	.0383	.0071	.0355	.0042	.0420
644	.0173	.0346	.0137	.0342	.0102	.0340	.0065	.0325	.0040	.0400
664	.0149	.0298	.0116	.0290	.0088	.0293	.0055	.0275	.0033	.0330
684	.0123	.0246	.0095	.0242	.0068	.0227	.0047	.0235	.0028	.0280
704	.0088	.0156	.0076	.0165	.0056	.0153	.0039	.0145	.0025	.0150
724	.0076	.0122	.0062	.0117	.0047	.0107	.0035	.0100	.0025	.0100
744	.0072	.0104	.0058	.0095	.0045	.0083	.0035	.0075	.0024	.0090
764	.0058	.0076	.0055	.0087	.0043	.0077	.0034	.0070	.0027	.0070
783	.0063	.0090	.0052	.0085	.0043	.0083	.0034	.0080	.0027	.0090
803	.0074	.0113	.0065	.0120	.0050	.0110	.0036	.0095	.0027	.0100
823	.0075	.0114	.0070	.0130	.0065	.0156	.0034	.0080	.0032	.0140
842	.0097	.0142	.0080	.0135	.0068	.0140	.0045	.0135	.0038	.0120
861	.0104	.0152	.0091	.0157	.0073	.0150	.0049	.0105	.0041	.0120
881	.0113	.0162	.0103	.0177	.0078	.0153	.0064	.0160	.0043	.0110
901	.0121	.0190	.0114	.0195	.0088	.0173	.0070	.0170	.0050	.0140
920	.0134	.0176	.0126	.0200	.0102	.0186	.0081	.0175	.0064	.0180
940	.0180	.0196	.0160	.0195	.0144	.0207	.0124	.0210	.0106	.0240
960	.0303	.0224	.0278	.0219	.0261	.0233	.0233	.0210	.0212	.0210
979	.03 6	.0280	.0318	.0280	.0290	.0313	.0269	.0315	.0237	.0310
998	.0354	.0346	.0326	.0362	.0284	.0343	.0250	.0345	.0216	.0350
1018	.0354	.0430	.0321	.0455	.0279	.0467	.0232	.0465	.0183	.0440
1037	.0366	.0534	.0320	.0552	.0255	.0523	.0207	.0540	.0153	.0540
1056	.0401	.0652	.0348	.0682	.0267	.0640	.0204	.0645	.0147	.0720
1076	.0459	.0776	.0402	.0827	.0297	.0753	.0228	.0785	.0144	.0730
1095	.0548	.0928	.0460	.0890	.0359	.0917	.0266	.0910	.0178	.0940
1115	.0626	.104	.0550	.111	.0427	.140	.0313	.104	.0212	.106
1134	.0742	.116	.0615	.109	.0483	.107	.0405	.122	.0280	.119

The  $A - c$  curves for wave-lengths  $605\mu\mu$  to  $764\mu\mu$ , inclusive, lying on the edge of the yellow-green band, show that  $A$  decreases in a marked manner with dilution and reaches a minimum value at about  $c = 1.0$ . Below  $c = 1.0$ ,  $A$  shows a slight increase.

The  $A - c$  curves for those wave-lengths in the region of transparency, from  $842\mu\mu$  to  $979\mu\mu$ , are straight lines parallel to the abscissæ, showing that  $A$  in this region is constant for all concentrations. For wave-lengths greater than  $979\mu\mu$ , which lie on the edge of the infra-red band,  $A$  is a constant within the error of experiment. The two band-edges in question are thus seen to behave quite differently as dilution proceeds.

Houstoun<sup>1</sup> has drawn the absorption curves for two solutions of cobalt chloride in water, and table 5 shows the comparison between his values and the values interpolated from table 4.

TABLE 5.— $A$  for Cobalt Chloride in Water.

Wave-length.	$c = 0.65$		$c = 3.10$	
	Houstoun.	From table 4.	Houstoun.	From table 4.
$645\mu\mu$	0.041	0.0340	.....	.....
684	.024	.0232	0.200	.....
720	.031	.0123	.041	0.0330
750	.028	.0090	.037	.0150
794	.028	.0109	.016	.0138
850	.028	.0147	.018	.0165
910	.028	.0175	.029	.0198
980	.040	.0275	.038	.....
1070	.070	.0762	.074	.....

The agreement between Houstoun's values and the values of  $A$  found in the present investigation is far from satisfactory. However, both sets indicate similar changes in  $A$  with  $c$ .

#### COBALT CHLORIDE IN METHYL ALCOHOL.

Seven solutions were prepared varying in concentration from  $c = 0.7$  to  $c = 0.1$ . The solutions appeared to keep very well, and no such precipitate was formed as was noticed in the aqueous solutions. The absorption curves show that the character of the absorption of the alcohol solutions was quite different from that of the aqueous solutions, the absorption curve for the alcohol solution being shifted towards the red, so that the minimum of absorption was now at  $842\mu\mu$ , the shift thus amounting to about  $80\mu\mu$ . The shift towards the red of the edge of the band in the green was sufficient to make this band absorb nearly all of the visible red light. (Instead of speaking of the "shift of a band," some have preferred to speak of the bands in the

<sup>1</sup>Proc. Roy. Soc. Edinburgh, **31**, 521 (1910-11).



different solvents as entirely different bands.) As a consequence, the more concentrated solutions appeared a deep purple, becoming more and more pink as the dilution increased.

The  $A - c$  curve for  $744\mu\mu$  shows that  $A$  decreases by a large amount with dilution, dropping from 0.128 for  $c=0.7$  to 0.080 for  $c=0.1$ . This is the only  $A - c$  curve which has been plotted for a wave-length

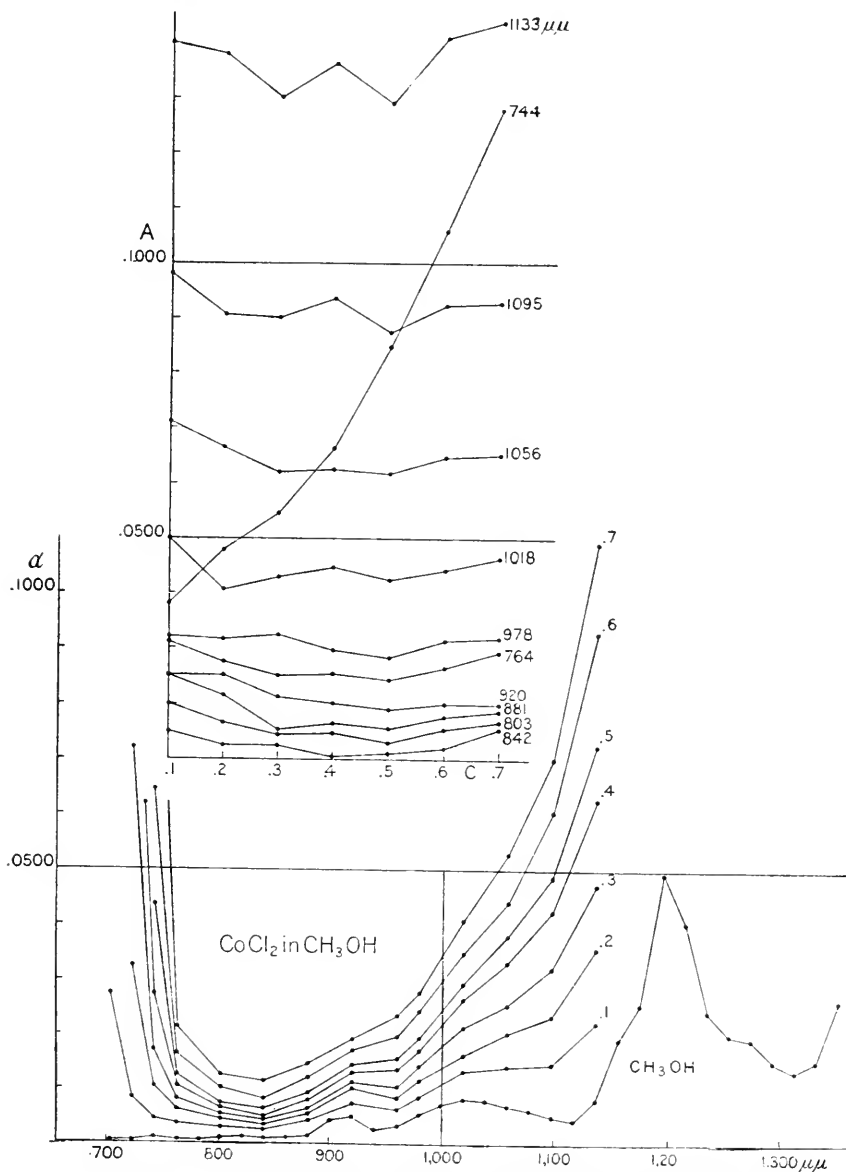

FIG. 6.—The  $A - c$  and Absorption Curves for Cobalt Chloride in Methyl Alcohol.

TABLE 6.—Cobalt Chloride in Methyl Alcohol (Fig. 6).

Wave-length.	Temp. = 21.5° <i>t</i> = 10.5 mm. Conc. = 0.7		Temp. = 21.0° <i>t</i> = 10.5 mm. Conc. = 0.6		Temp. = 20.9° <i>t</i> = 10.5 mm. Conc. = 0.5		Temp. = 20.7° <i>t</i> = 10.5 mm. Conc. = 0.4		Temp. = 21.0° <i>t</i> = 10.5 mm. Conc. = 0.3		Temp. = 19.8° <i>t</i> = 20.2 mm. Conc. = 0.2		Temp. = 19.0° <i>t</i> = 20.2 mm. Conc. = 0.1	
	<i>a</i>	<i>A</i>	<i>a</i>	<i>A</i>	<i>a</i>	<i>A</i>	<i>a</i>	<i>A</i>	<i>a</i>	<i>A</i>	<i>a</i>	<i>A</i>	<i>a</i>	<i>A</i>
704 $\mu$	.....	.....	.....	.....	.....	.....	.....	.....	.....	.....	.....	.....	0.0274	0.270
724	0.0806	0.128	0.0646	0.106	0.0434	0.0848	0.125	0.310	0.0722	0.239	0.0326	0.161	0.0084	0.080
764	.0214	.0294	.0167	.0266	.0128	.0242	.0108	.0253	.0082	.0250	.0062	.0275	.0038	.031
803	.0128	.0169	.0102	.0154	.0075	.0130	.0069	.0148	.0054	.0143	.0043	.0165	.0030	.020
842	.0118	.0154	.0082	.0120	.0065	.0110	.0051	.0103	.0047	.0123	.0035	.0125	.0025	.015
881	.0148	.0189	.0121	.0176	.0095	.0158	.0082	.0165	.0067	.0153	.0059	.0215	.0041	.025
920	.0191	.0199	.0172	.0200	.0147	.0190	.0133	.0203	.0115	.0210	.0102	.0250	.0077	.025
959	.0237	.0290	.0197	.0276	.0159	.0250	.0139	.0263	.0106	.0240	.0087	.0265	.0066	.032
978	.0278	.0319	.0242	.0312	.0196	.0282	.0173	.0295	.0142	.0323	.0118	.0315	.0087	.032
1018	.0408	.0463	.0349	.0441	.0296	.0424	.0263	.0448	.0213	.0430	.0165	.0405	.0134	.050
1056	.0528	.0653	.0440	.0649	.0380	.0618	.0332	.0628	.0257	.0620	.0204	.0665	.0142	.071
1095	.0700	.0927	.0604	.0921	.0488	.0874	.0425	.0935	.0321	.0900	.0232	.0905	.0149	.098
1133	.109	.144	.0929	.141	.0726	.129	.0628	.136	.0473	.130	.0358	.138	.0223	.140

TABLE 7.—Cobalt Chloride in Ethyl Alcohol (Fig. 7).

Wave-length.	Temp. = 20.0° <i>t</i> = 6.36 mm. Conc. = 0.40		Temp. = 20.2° <i>t</i> = 6.36 mm. Conc. = 0.30		Temp. = 20.4° <i>t</i> = 10.5 mm. Conc. = 0.20		Temp. = 20.3° <i>t</i> = 10.5 mm. Conc. = 0.10		Temp. = 20.6° <i>t</i> = 2.73 mm. Conc. = 0.08		Temp. = 21.2° <i>t</i> = 2.73 mm. Conc. = 0.06	
	<i>a</i>	<i>A</i>	<i>a</i>	<i>A</i>	<i>a</i>	<i>A</i>	<i>a</i>	<i>A</i>	<i>a</i>	<i>A</i>	<i>a</i>	<i>A</i>
724 $\mu$	.....	.....	.....	.....	.....	.....	.....	.....	0.0504	0.63	0.0366	0.61
744	0.0953	0.238	0.0787	0.196	0.0357	0.179	0.0136	0.136	.0105	.13	.....	.....
764	.0249	.062	.0184	.061	.0124	.062	.0047	.047	.....	.....	.....	.....
803	.0175	.044	.0131	.044	.0093	.047	.0035	.035	.....	.....	.....	.....
842	.0175	.042	.0124	.040	.0088	.042	.0039	.034	.....	.....	.....	.....
881	.0191	.044	.0147	.037	.0102	.043	.0047	.031	.....	.....	.....	.....
920	.0244	.051	.0205	.056	.0148	.055	.0086	.048	.....	.....	.....	.....
959	.0272	.061	.0225	.066	.0165	.069	.0089	.061	.....	.....	.....	.....
978	.0316	.070	.0253	.072	.0190	.077	.0115	.079	.....	.....	.....	.....
1018	.0459	.099	.0382	.107	.0293	.116	.0190	.129	.....	.....	.....	.....
1056	.0666	.152	.0570	.171	.0418	.181	.0266	.210	.0237	.22	.0208	.25
1095	.106	.252	.0857	.271	.0648	.301	.0400	.355	.0314	.34	.0289	.38
1133	.170	.410	.143	.457	.0943	.493	.0645	.589	.0543	.61	.0475	.68

Wave-length.	Temp. = 20.7° <i>t</i> = 7.39 mm. Conc. = 0.05		Temp. = 21.5° <i>t</i> = 11.55 mm. Conc. = 0.04		Temp. = 21.7° <i>t</i> = 11.55 mm. Conc. = 0.03		Temp. = 21.2° <i>t</i> = 11.55 mm. Conc. = 0.02		Temp. = 21.3° <i>t</i> = 11.55 mm. Conc. = 0.01		Temp. = 21.3° <i>t</i> = 11.55 mm. Conc. = 0.005	
	<i>a</i>	<i>A</i>	<i>a</i>	<i>A</i>	<i>a</i>	<i>A</i>	<i>a</i>	<i>A</i>	<i>a</i>	<i>A</i>	<i>a</i>	<i>A</i>
704 $\mu$	.....	.....	.....	.....	0.0922	3.1	0.0527	2.6	0.0225	2.3	0.0094	1.9
724	0.0291	0.58	0.0203	0.51	.0172	0.57	.0081	0.40	.0042	0.42	.0022	0.44
1056	.0174	.22	.0164	.27	.0110	.18	.0106	.26	.0078	.22	.0069	.26
1095	.0214	.34	.0204	.39	.0148	.34	.0138	.46	.0081	.36	.0065	.40
1133	.0357	.60	.0316	.65	.0246	.63	.0192	.67	.0142	.86	.0103	.94

lying on the edge of the red-yellow absorption band, for this edge is extremely sharp compared to the edge of the analogous band of the water solution. The  $A - c$  curves for the region of transmission  $764\mu\mu$  to  $920\mu\mu$ , and for the edge of the infra-red band  $920\mu\mu$  to  $1,134\mu\mu$ , show that  $A$  for these regions of the spectrum remains approximately constant for all concentrations.

COBALT CHLORIDE IN ETHYL ALCOHOL.

Four solutions were prepared varying in concentration from  $c=0.4$  to  $c=0.1$ . A month later a second series of more dilute solutions, for which  $c$  was 0.08, 0.06, 0.05, 0.04, 0.03, 0.02, 0.01, 0.005, were prepared; their absorption curves were drawn only in the region of moderate absorption, from  $1,056\mu\mu$  to  $1,134\mu\mu$  and for  $724\mu\mu$  and  $704\mu\mu$ ; in the other regions they either absorbed too much or too little, so that no confidence could be placed in the values of  $A$ .

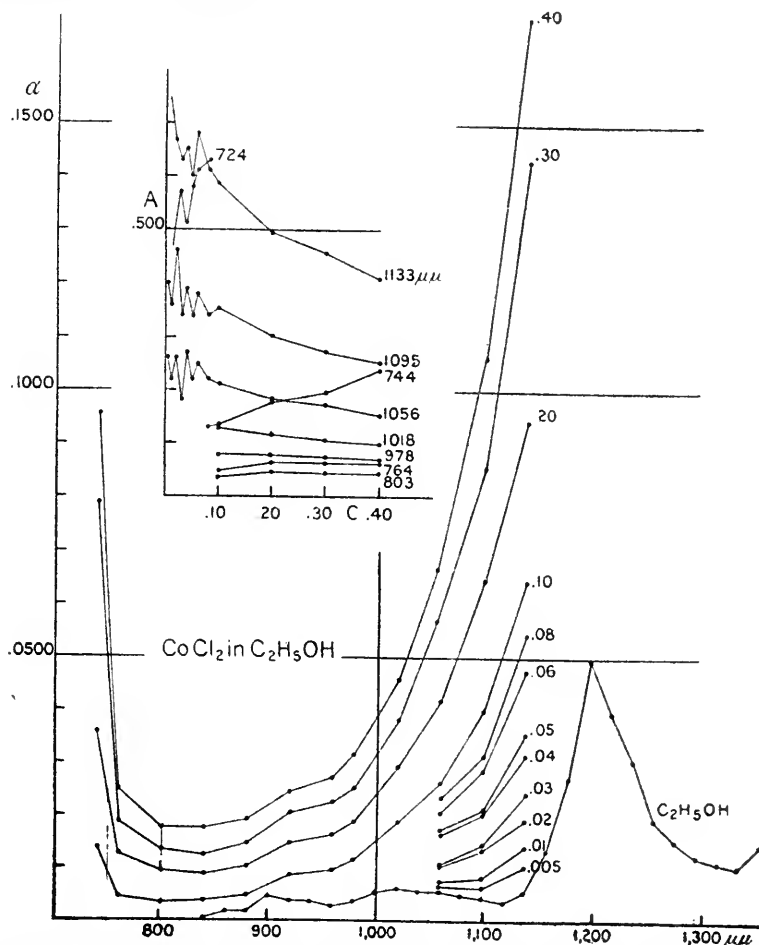

FIG. 7.—The  $A - c$  and Absorption Curves for Cobalt Chloride in Ethyl Alcohol.

The absorption curves for the solutions of ethyl alcohol are similar in their general character to those for methyl alcohol. The minimum of absorption occurs in the same place, at  $842\mu\mu$ , and the steepness of the edges of the bands is much the same. The ethyl-alcohol solutions were of a pure deep-blue in the higher concentrations, becoming a greenish blue as dilution increased.

The  $A-c$  curves for  $724\mu\mu$  and  $744\mu\mu$  show that  $A$  decreases with dilution, and the decrease in this case is far greater than in the case of methyl alcohol. For wave-lengths  $764\mu\mu$  to  $979\mu\mu$  in the region of transmission,  $A$  is fairly constant. For the region on the edge of the infra-red band,  $1,018\mu\mu$  to  $1,134\mu\mu$ , the  $A-c$  curves show that  $A$  increases with dilution. These last-mentioned curves illustrate the magnitude of the error in the determination of  $A$  in the case of very dilute solutions.

TABLE 8.—Cobalt Chloride in Propyl Alcohol (Fig. 8).

Wave-length.	Temp. = $22.0^\circ$ $t = 10.5$ mm. Conc. = 0.434		Temp. = $21.5^\circ$ $t = 10.5$ mm. Conc. = 0.40		Temp. = $21.9^\circ$ $t = 10.5$ mm. Conc. = 0.35		Temp. = $22.1^\circ$ $t = 10.5$ mm. Conc. = 0.30	
	$\alpha$	$A$	$\alpha$	$A$	$\alpha$	$A$	$\alpha$	$A$
$744\mu\mu$	0.107	0.246	0.0992	0.223	0.0797	0.227	0.0642	0.214
764	.0250	.0575	.0205	.0549	.0197	.0578	.0189	.0630
803	.0159	.0365	.0142	.0355	.0142	.0405	.0133	.0443
842	.0153	.0344	.0139	.0338	.0136	.0377	.0121	.0390
881	.0176	.0378	.0156	.0360	.0162	.0428	.0142	.0433
920	.0252	.0454	.0232	.0443	.0227	.0491	.0213	.0527
959	.0277	.0578	.0254	.0570	.0241	.0613	.0227	.0663
978	.0320	.0675	.0295	.0673	.0278	.0719	.0254	.0760
1018	.0460	.0908	.0439	.0960	.0418	.104	.0384	.109
1056	.0704	.151	.0662	.153	.0631	.169	.0568	.173
1095	.114	.253	.107	.258	.0976	.267	.0917	.292

Wave-length.	Temp. = $22.3^\circ$ $t = 10.5$ mm. Conc. = 0.25		Temp. = $20.0^\circ$ $t = 10.5$ mm. Conc. = 0.20		Temp. = $19.5^\circ$ $t = 10.5$ mm. Conc. = 0.15		Temp. = $19.7^\circ$ $t = 20.2$ mm. Conc. = 0.10	
	$\alpha$	$A$	$\alpha$	$A$	$\alpha$	$A$	$\alpha$	$A$
$744\mu\mu$	0.0512	0.205	0.0357	0.178	0.0236	0.158	0.0160	0.160
764	.0148	.0592	.0115	.0575	.0082	.0547	.0064	.0640
803	.0111	.0445	.0089	.0445	.0065	.0434	.0052	.0520
842	.0106	.0408	.0086	.0410	.0065	.0407	.0061	.0570
881	.0118	.0424	.0102	.0450	.0079	.0447	.0073	.0610
920	.0183	.0512	.0159	.0520	.0142	.0580	.0122	.0670
959	.0194	.0672	.0165	.0695	.0128	.0680	.0106	.0800
978	.0228	.0808	.0190	.0820	.0150	.0822	.0123	.0970
1018	.0311	.112	.0297	.121	.0246	.127	.0197	.142
1056	.0505	.183	.0440	.196	.0355	.211	.0275	.227
1095	.0816	.301	.0654	.308	.0549	.342	.0418	.380

COBALT CHLORIDE IN PROPYL ALCOHOL.

Eight solutions were prepared varying in concentration from  $c = 0.434$  to  $c = 0.10$ . The character of the absorption curves is the same as that of the ethyl-alcohol solutions, the minimum of absorption occurring again at  $842\mu\mu$  and the steepness of the edges of the bands being similar. The propyl-alcohol solutions were also deep blue, becoming a greenish blue upon dilution. The absorption curve for  $c = 0.434$  has been drawn in greater detail, readings having been taken at every  $10\mu\mu$ .

The  $A - c$  curve for  $744\mu\mu$ , lying on the edge of the yellow-red absorption band, shows that  $A$  decreases greatly with dilution. This

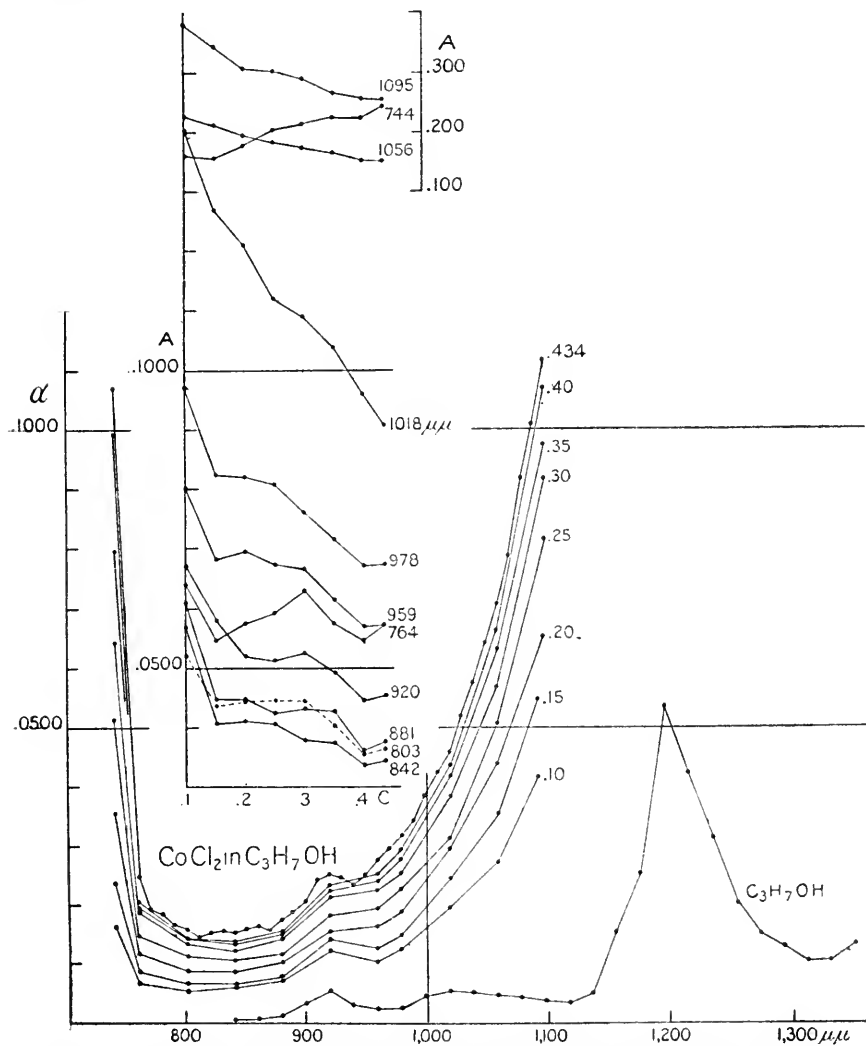

FIG. 8.—The  $A - c$  and Absorption Curves for Cobalt Chloride in Propyl Alcohol.

curve (and the  $A - c$  curves for  $1,056\mu\mu$  and  $1,095\mu\mu$ ) have been plotted on a scale of ordinates one-tenth as great as the other  $A - c$  curves. For wave-lengths in the region of low absorption,  $764\mu\mu$  to  $842\mu\mu$ ,  $A$  is approximately constant, although in this region the values of  $\alpha$  are so small that the values of  $A$  are liable to considerable inaccuracy. The  $A - c$  curves for wave-lengths  $920\mu\mu$  to  $1,095\mu\mu$ , on the edge of the infra-red band, show that  $A$  increases rapidly with dilution.

## COBALT CHLORIDE IN ISO-BUTYL ALCOHOL.

Four solutions were prepared varying in concentration from  $c = 0.194$  to  $c = 0.05$ . The absorption curves have the same character as those for the ethyl-alcohol solutions and the color of the solutions in the bottles was the same, being a deep blue which changed to a greenish

TABLE 9.—Cobalt Chloride in Iso-butyl Alcohol (Fig. 9).

Wave-length.	Temp. = 20.2° $t = 10.5$ mm. Conc. = 0.194		Temp. = 20.8° $t = 10.5$ mm. Conc. = 0.15		Temp. = 21.0° $t = 10.5$ mm. Conc. = 0.10		Temp. = 21.2° $t = 20.2$ mm. Conc. = 0.05	
	$\alpha$	$A$	$\alpha$	$A$	$\alpha$	$A$	$\alpha$	$A$
734 $\mu\mu$	0.0873	0.443	0.0634	0.416	0.0370	0.359	0.0155	0.288
744	.0316	.157	.0247	.157	.0148	.136	.0884	.144
754	.0128	.0598	.0115	.0686	.0075	.0630	.0056	.0880
764	.0075	.0325	.0075	.0420	.0051	.0390	.0048	.0720
803	.0054	.0227	.0054	.0293	.0035	.0250	.0041	.0620
842	.0051	.0211	.0051	.0273	.0035	.0250	.0041	.0620
881	.0065	.0242	.0065	.0313	.0043	.0250	.0046	.0560
920	.0109	.0325	.0102	.0373	.0036	.0400	.0081	.0700
959	.0118	.0464	.0102	.0493	.0086	.0580	.0069	.0820
978	.0133	.0561	.0115	.0607	.0089	.0650	.0071	.0940
1018	.0231	.0903	.0197	.0940	.0150	.0940	.0119	.126
1056	.0351	.157	.0281	.157	.0217	.171	.0142	.192
1095	.0568	.275	.0441	.271	.0319	.275	.0191	.314
1133	.0954	.468	.0738	.461	.0538	.493	.0302	.514

blue upon dilution. In preparing the solutions the usual procedure was followed, namely, to make the dilutions by adding pure alcohol to the saturated mother solution. It was found that a precipitate appeared immediately upon dilution. The solutions were then filtered and the concentrations were measured by a determination of the density. The value of the concentration determined in this way was found to agree within the error of experiment with the concentration calculated from the known amount of dilution. This showed that the loss by precipitation was either negligible or that the precipitate contained nearly equal parts of cobalt chloride and iso-butyl alcohol. The filtered solutions appeared quite free from any visible particles. In the cells they had a somewhat cloudy appearance, suggestive of

a colloid condition. They showed slightly a Tyndall cone in blue light. An examination of these freshly filtered iso-butyl alcohol (and also the iso-amyl alcohol) solutions with the ultra-microscope showed that they were not colloidal in nature, but that they contained a number of particles. Whether these particles were newly formed precipitate or some impurity is unknown.

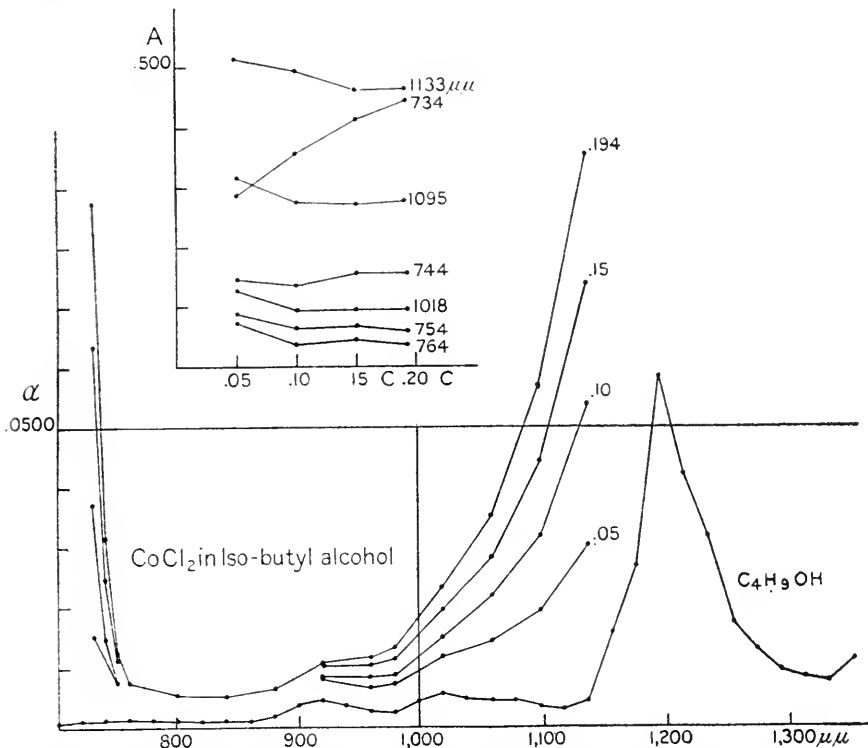

FIG. 9.—The  $A-c$  and Absorption Curves for Cobalt Chloride in Iso-Butyl Alcohol.

The  $A-c$  curves for  $734\mu\mu$  and  $744\mu\mu$  wave-lengths lying on the edge of the yellow-red absorption band show again that  $A$  decreases rapidly with dilution. For the wave-lengths  $754\mu\mu$  and  $764\mu\mu$  in the region of transmission  $A$  is constant. The behavior of the edge of the infra-red band is similar to the case of the propyl-alcohol solutions, for  $A$  increases with dilution, as shown by the rise in the  $A-c$  curves for wave-lengths  $1,018\mu\mu$  to  $1,133\mu\mu$ .

#### COBALT CHLORIDE IN ISO-AMYL ALCOHOL.

Six solutions were prepared varying in concentration from  $c=0.064$  to  $c=0.010$ . The solutions in the bottles were of a deep blue in the higher concentrations, which changed to a greenish blue upon dilution.

The general character of the absorption curves is the same as that of the ethyl-alcohol solutions.

The iso-amyl alcohol solutions exhibited the same phenomenon of precipitation upon dilution as has been described in the case of the iso-butyl alcohol solutions. They also had the same appearance in the cells and under the ultra-microscope.

TABLE 10.—Cobalt Chloride in Iso-Amyl Alcohol (Fig. 10).

Wave-length.	Temp. = 22.1° <i>t</i> = 10.5 mm. Conc. = 0.064		Temp. = 23.4° <i>t</i> = 10.5 mm. Conc. = 0.05		Temp. = 21.4° <i>t</i> = 10.5 mm. Conc. = 0.04		Temp. = 21.4° <i>t</i> = 10.5 mm. Conc. = 0.03		Temp. = 21.9° <i>t</i> = 20.2 mm. Conc. = 0.02		Temp. = 23.8° <i>t</i> = 20.2 mm. Conc. = 0.01	
	<i>a</i>	<i>A</i>	<i>a</i>	<i>A</i>	<i>a</i>	<i>A</i>	<i>a</i>	<i>A</i>	<i>a</i>	<i>A</i>	<i>a</i>	<i>A</i>
704 $\mu\mu$	.....	.....	.....	.....	.....	.....	.....	.....	.....	.....	0.0278	2.78
714	.....	.....	.....	.....	0.0680	1.70	0.0455	1.52	0.0267	1.34	0.0112	1.12
724	0.0569	0.89	0.0395	0.79	.0269	0.67	.0181	0.60	.0113	0.56	.0051	0.51
734	.0242	.38	.0156	.31	.0108	.27	.0079	.26	.0060	.30	.0039	.39
744	.0095	.15	.0075	.15	.0050	.13	.0069	.23	.0045	.22	.0032	.32
764	.0031	.05	.0031	.06	.0028	.07	.0028	.08	.0030	.15	.0024	.24
803	.0028	.05	.0028	.05	.0028	.07	.0024	.07	.0022	.09	.0024	.20
842	.0031	.05	.0031	.05	.0031	.08	.0028	.08	.0023	.10	.0034	.30
881	.0054	.08	.0059	.10	.0050	.10	.0050	.13	.0046	.18	.0056	.46
920	.0118	.11	.0118	.14	.0118	.17	.0121	.24	.0148	.49	.0129	.79
959	.0156	.21	.0145	.25	.0145	.31	.0148	.42	.0149	.63	.0148	1.26
978	.0187	.27	.0174	.32	.0170	.38	.0168	.51	.0169	.76	.0169	1.53
1018	.0342	.45	.0296	.49	.0290	.61	.0285	.79	.0279	1.15	.0255	2.07
1056	.0482	.69	.0412	.75	.0392	.88	.0380	1.14	.0351	1.56	.0295	2.57
1095	.0658	.99	.0530	1.01	.0509	1.21	.0472	1.49	.0453	2.09	.0313	2.89
1133	.0877	1.31	.0698	1.32	.0636	1.49	.0574	1.78	.0514	2.38	.0346	3.08

A study was made of the precipitate which was thrown down in these solutions, for the deposit in the case of the iso-amyl alcohol solutions was more abundant than in the case of the deposits in the other cobalt-chloride solutions. The solution was allowed to stand for two weeks and the precipitate filtered off. This precipitate consisted of blue needle crystals mixed with a flocculent scale-like residue. Analysis showed that in this flocculent residue there was present 54 per cent by weight of cobalt chloride; if this precipitate was a compound of the cobalt chloride and the alcohol, this percentage of the chloride would indicate that the compound contained 2 molecules of the chloride to 3 of the alcohol.

The *A* - *c* curves for the edge of the yellow-red absorption band, at 714 $\mu\mu$  and 724 $\mu\mu$ , show that *A* decreases with dilution. In the region of transparency between the two bands, as shown by the *A* - *c* curves for 734 $\mu\mu$  and 744 $\mu\mu$ , the *A* - *c* curves for the edge of the infra-red band show that *A* increases very rapidly with dilution.



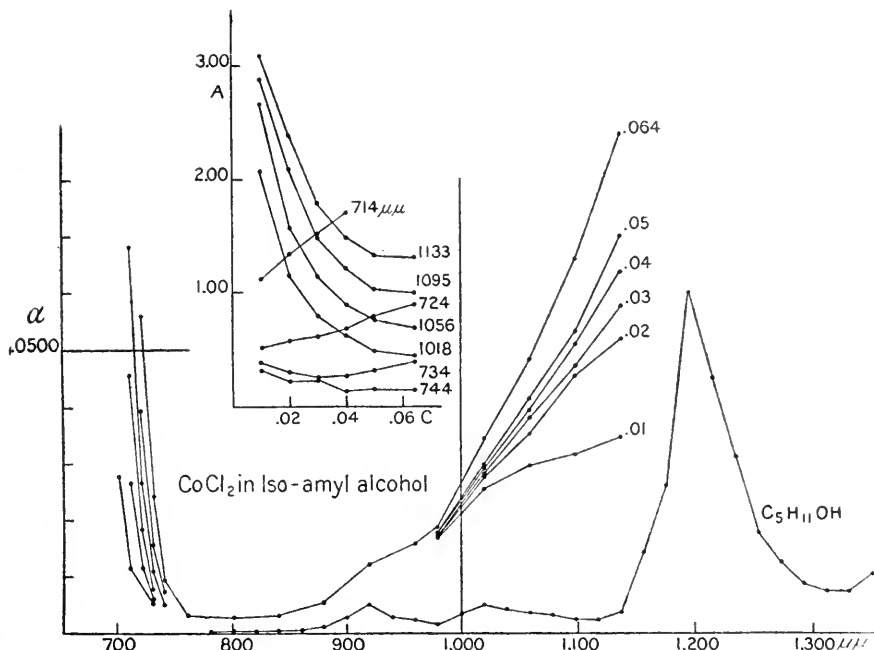

FIG. 10.—The  $A-c$  and Absorption Curves for Cobalt Chloride in Iso-amyl Alcohol.

#### DISCUSSION OF RESULTS FOR COBALT CHLORIDE.

The study of cobalt chloride in water and alcoholic solution brings out the following facts:

For the region of the spectrum lying on the long wave-length edge of the yellow-red absorption band, the  $A-c$  curves show that  $A$  decreases with dilution. The decrease in  $A$  observed in the case of the aqueous solution is considerable, and in the case of the alcoholic solutions this decrease becomes more and more marked as the molecular complexity of the alcohol increases. Jones and Anderson<sup>1</sup> studied solutions of cobalt chloride in water, methyl alcohol, and ethyl alcohol. Plates 2, 4, and 5 of their paper show that (in the region of the spectrum under discussion)  $A$  decreases with dilution, and also that this decrease is much more marked for the cases of the alcoholic solutions than for the case of the water solution. This is in accord with the facts brought out by the measurements discussed in the preceding paragraphs. In the region of low absorption between the two bands it is concluded that  $A$  is constant with respect to  $c$ . As has been mentioned already, in the section concerning cobalt chloride in propyl alcohol, the values of  $\alpha$  for the region between the two bands are so small that the values of  $A$  are in many cases worthless.

<sup>1</sup>Carnegie Inst. Wash. Pub. No. 110.

In the region of wave-lengths lying on the edge of the infra-red band,  $A$  experiences deviations from a constant value, and again these deviations show a certain regularity concomitant with the increasing molecular complexity of the solvent. In this region  $A$  is nearly constant for the water solutions, but increases with dilution for the alcohol solutions, the increase becoming greater as the molecular weight of the alcohol increases.

#### COBALT CHLORIDE IN THE ALCOHOLS WITH WATER.

The striking color changes which take place when water is added to an alcoholic solution of cobalt chloride are well known. Donnan and Bassett<sup>1</sup> came to the conclusion that the blue color of certain solutions of cobalt salts is due to the formation of complex anions containing cobalt. In an interesting paper by A. R. Brown<sup>2</sup> the disappearance of the intense red absorption band, which takes place when the alcoholic cobalt-chloride solution is diluted with water, is attributed to the formation of a complex composed of cobalt chloride and water molecules. A series of ethyl-alcohol solutions containing increasing quantities of water was prepared, and from the measurements of  $\alpha$  at the summit of the red absorption band, making certain assumptions for which the original paper should be consulted, Brown has calculated that the complex contains 1 molecule of cobalt chloride associated with about 15 molecules of water.

The present work yields information concerning the behavior of the edges of two bands. It would have been more satisfactory if the behavior of the tops of the bands could have been studied. The summits of the bands, however, were inaccessible. Brown's calculation was applied to the values of  $\alpha$  measured for wave-lengths lying on the edge of the red absorption band. This was done for the cases of the three sets of alcoholic mixtures studied. The calculations gave as a result that with 1 molecule of cobalt chloride there was associated a large number of water molecules. The number varied from 30 to 500, depending on the wave-length and the set of solutions selected for the calculation. It seems, therefore, that one is not justified in applying Brown's calculation to the values of  $\alpha$  determined on the edge of the band. It should be stated, however, that the accuracy of the values of  $\alpha$  is really not sufficient to do complete justice to the problem.

#### COBALT CHLORIDE IN METHYL ALCOHOL WITH WATER.

Three methyl-alcohol solutions were prepared containing cobalt chloride and water. In table 11, the concentration of the cobalt chloride, denoted by  $c_1$ , was 0.5 for each solution. The concentrations of the water, denoted by  $c_2$ , were 2.78, 5.55, and 8.32. The values of  $\alpha$  for the pure alcohol and pure water solutions were taken from the work on cobalt chloride in these solvents.

<sup>1</sup>Journ. Chem. Soc., **81**, 939 (1902).

<sup>2</sup>Proc. Roy. Soc. Edinburgh, **32**, 50 (1911-12).

The pure-alcohol solution was a deep purple, changing by successive stages to pink as the concentration of the water increased. The fourth solution, for which  $c_2=8.32$ , was very nearly the same color as the pure-water solution. These mixtures decomposed upon standing, in a manner similar to the pure-water solutions, yielding a flocculent precipitate.

TABLE 11.—Cobalt Chloride in Methyl Alcohol with Water (Fig. 11).

Wave-length.	Temp. = 20.9° $t=10.5$ mm. $c_1=0.5$ $c_2=0$		Temp. = 18.8° $t=10.5$ mm. $c_1=0.5$ $c_2=2.78$		Temp. = 18.0° $t=20.2$ mm. $c_1=0.5$ $c_2=5.55$		Temp. = 17.6° $t=20.2$ mm. $c_1=0.5$ $c_2=8.32$		Temp. = 18.1° $t=20.0$ mm. $c_1=0.5$ $c_2=18.0$	
	$\alpha$	$\alpha - \alpha_0$	$\alpha$	$\alpha - \alpha_0$	$\alpha$	$\alpha - \alpha_0$	$\alpha$	$\alpha - \alpha_0$	$\alpha$	$\alpha - \alpha_0$
704 $\mu\mu$	.....	.....	0.129	0.129	0.0467	0.0462	0.0211	0.0206	0.0088	0.0078
724	0.125	0.124	.0339	.0334	.0143	.0137	.0092	.0087	.0076	.0061
744	.0275	.0265	.0128	.0117	.0083	.0071	.0078	.0066	.0072	.0052
764	.0108	.0101	.0089	.0081	.0069	.0061	.0068	.0059	.0058	.0038
803	.0069	.0059	.0072	.0061	.0063	.0052	.0066	.0054	.0074	.0057
842	.0051	.0041	.0075	.0064	.0069	.0067	.0074	.0061	.0097	.0071
881	.0082	.0066	.0102	.0085	.0090	.0073	.0089	.0070	.0113	.0081
920	.0133	.0081	.0141	.0091	.0128	.0078	.0130	.0079	.0134	.0088
959	.0139	.0105	.0156	.0114	.0145	.0095	.0156	.0098	.0303	.0112
978	.0173	.0118	.0192	.0130	.0188	.0117	.0197	.0119	.0346	.0140
1018	.0263	.0179	.0285	.0198	.0274	.0184	.0294	.0202	.0354	.0215
1056	.0332	.0261	.0348	.0277	.0347	.0275	.0371	.0300	.0401	.0326
1095	.0425	.0374	.0437	.0385	.0437	.0383	.0460	.0404	.0548	.0464
1134	.0628	.0545	.0593	.0506	.0602	.0509	.0620	.0525	.0742	.0581

The absorption curves have not been plotted. From each value of  $\alpha$  has been subtracted the absorption  $\alpha_0$ , due to the solvent. The value of  $\alpha_0$  has been calculated from the known amounts of water and alcohol present in the solution. The values of  $\alpha - \alpha_0$  have been plotted as ordinates against wave-lengths as abscissas. These are the curves which appear in figure 11. These curves show the well-known subsiding of the edge of the red absorption band as the amount of water present in the alcoholic solution increases; also that the edge of the infra-red band, between 978 $\mu\mu$  and 1,134 $\mu\mu$ , is practically the same in methyl alcohol as in water solutions, and hence is uninfluenced by the addition of water to the methyl-alcohol solution.

COBALT CHLORIDE IN ETHYL ALCOHOL WITH WATER.

Five ethyl-alcohol solutions were prepared containing cobalt chloride and water. The concentration of the cobalt chloride, denoted by  $c_1$  in table 12, was 0.08 for each solution. The concentrations of the water, denoted by  $c_2$ , were 1.29, 2.78, 4.16, 5.55, and 6.94. The values of  $\alpha$  for the pure-alcohol and pure-water solutions were interpolated from the work on cobalt chloride in these solvents.

The pure-alcohol solution was a deep blue, which changed with the addition of water through a series of purple shades, until the color became the pink hue characteristic of the aqueous cobalt-chloride solutions. This change was nearly complete for  $c_2 = 6.94$ . These mixtures decomposed upon standing, yielding a precipitate in a manner similar to the pure-water solutions.

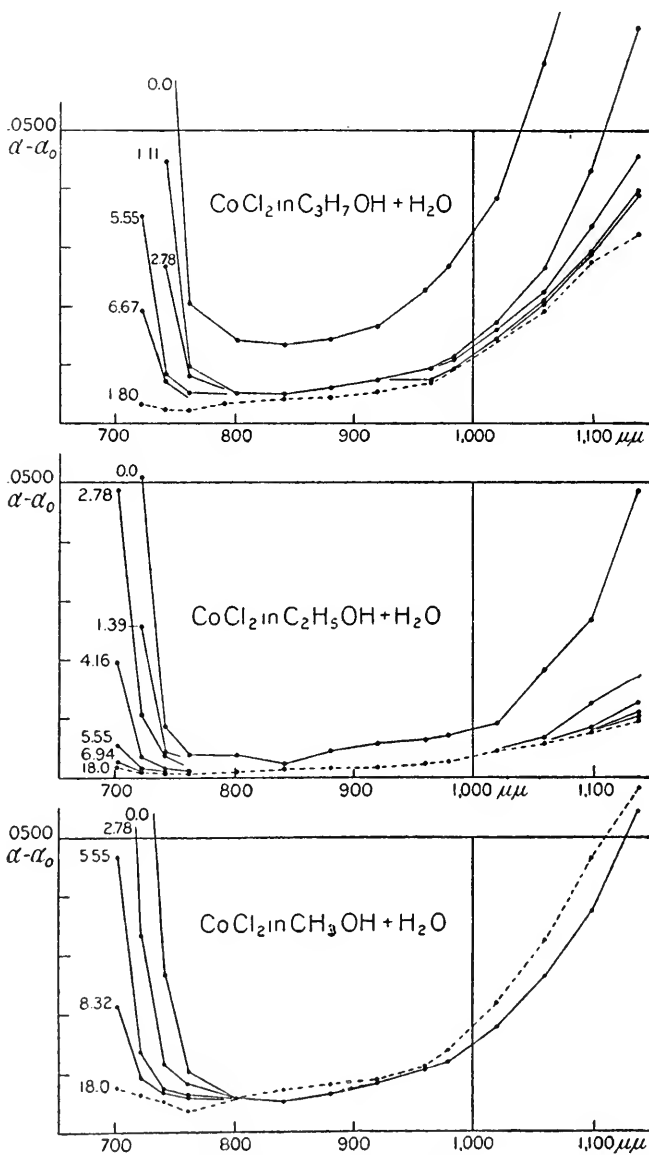

—Curves showing the Differences in Absorption between Solvent and Solutions for Cobalt Chloride in Mixtures of the Alcohols with Water.

TABLE 12.—Cobalt Chloride in Ethyl Alcohol with Water (Fig. 11).

Wave-length.	Temp. = 20.7° <i>t</i> = 7.39 mm. <i>c</i> <sub>1</sub> = 0.08 <i>c</i> <sub>2</sub> = 0		Temp. = 20.1° <i>t</i> = 20.2 mm. <i>c</i> <sub>1</sub> = 0.08 <i>c</i> <sub>2</sub> = 1.39		Temp. = 20.2° <i>t</i> = 20.2 mm. <i>c</i> <sub>1</sub> = 0.08 <i>c</i> <sub>2</sub> = 2.78		Temp. = 20.2° <i>t</i> = 20.2 mm. <i>c</i> <sub>1</sub> = 0.08 <i>c</i> <sub>2</sub> = 4.16		Temp. = 20.3° <i>t</i> = 20.2 mm. <i>c</i> <sub>1</sub> = 0.08 <i>c</i> <sub>2</sub> = 5.55		Temp. = 20.5° <i>t</i> = 20.2 mm. <i>c</i> <sub>1</sub> = 0.08 <i>c</i> <sub>2</sub> = 6.94		Temp. = 20.1° <i>t</i> = 20.2 mm. <i>c</i> <sub>1</sub> = 0.08 <i>c</i> <sub>2</sub> = 18.0		
	<i>a</i>	<i>a</i> - <i>a</i> <sub>0</sub>	<i>a</i>	<i>a</i> - <i>a</i> <sub>0</sub>	<i>a</i>	<i>a</i> - <i>a</i> <sub>0</sub>	<i>a</i>	<i>a</i> - <i>a</i> <sub>0</sub>	<i>a</i>	<i>a</i> - <i>a</i> <sub>0</sub>	<i>a</i>	<i>a</i> - <i>a</i> <sub>0</sub>	<i>a</i>	<i>a</i> - <i>a</i> <sub>0</sub>	<i>a</i>
704 $\mu\mu$	.....	.....	.....	.....	0.0488	0.0488	0.0197	0.0196	0.0053	0.0052	0.0026	0.0024	0.0025	0.0015	0.0015
724	0.0504	0.0504	0.0259	0.0259	.0107	.0106	.0035	.0034	.0016	.0014	.0012	.0010	.0027	.0012	.0012
744	.0085	.0085	.0043	.0042	.0038	.0037	.0016	.0015	.0014	.0012	.0012	.0010	.0028	.0010	.0008
764	.0037	.0037	.0016	.0015	.0028	.0027	.0011	.0010	.0014	.0012	.0012	.0010	.0028	.0010	.0008
803	.0037	.0037	.0016	.0015	.0028	.0027	.0011	.0010	.0014	.0012	.0012	.0010	.0027	.0010	.0010
842	.0027	.0022	.0014	.0008	.0026	.0020	.0016	.0009	.0020	.0013	.0016	.0008	.0039	.0013	.0013
881	.0058	.0042	.0028	.0012	.0038	.0021	.0016	.0009	.0028	.0010	.0026	.0008	.0047	.0015	.0015
920	.0094	.0056	.0053	.0014	.0063	.0024	.0049	.0010	.0055	.0015	.0049	.0008	.0063	.0017	.0017
960	.0090	.0062	.0050	.0026	.0062	.0026	.0049	.0011	.0057	.0013	.0058	.0003	.0213	.0022	.0022
979	.0106	.0070	.0053	.0010	.0072	.0027	.0067	.0020	.0074	.0021	.0075	.0012	.0234	.0028	.0028
1018	.0151	.0090	.0111	.0046	.0121	.0056	.0104	.0038	.0110	.0041	.0109	.0038	.0182	.0043	.0043
1056	.0237	.0181	.0123	.0065	.0113	.0056	.0105	.0048	.0109	.0051	.0106	.0048	.0133	.0058	.0058
1095	.0314	.0269	.0170	.0123	.0124	.0077	.0114	.0066	.0113	.0064	.0113	.0063	.0159	.0075	.0075
1134	.0543	.0487	.0232	.0172	.0190	.0129	.0172	.0110	.0164	.0097	.0160	.0101	.0256	.0095	.0095

The *a* - *a*<sub>0</sub> curves (see paragraph on cobalt chloride in methyl alcohol with water, p. 36) show that as the amount of water present in the ethyl-alcohol solution increases the absorption at the edge of the red band becomes less, and also that the edge of the infra-red band behaves in a similar manner. The behavior of the infra-red band in the ethyl-alcohol mixture is thus seen to differ materially from that for the methyl-alcohol mixtures.

COBALT CHLORIDE IN PROPYL ALCOHOL WITH WATER.

Four propyl-alcohol solutions were prepared containing cobalt chloride and water. The concentration of the cobalt chloride, denoted by *c*<sub>1</sub> in table 13, was 0.3 for each solution. The concentrations of the water, denoted by *c*<sub>2</sub>, were 1.11, 2.78, 5.55, and 6.67. The values of *a* for the pure-alcohol and pure-water solutions were taken from the work on cobalt chloride in these solvents.

As in the case of the methyl-alcohol mixtures, the pure propyl-alcohol solution was a deep blue, which changed with the addition of water through a series of purples, until the color became the pink hue characteristic of the aqueous cobalt-chloride solutions. This change was nearly complete for *c*<sub>2</sub> = 1.11.

The *a* - *a*<sub>0</sub> curves (see paragraph on cobalt chloride in methyl alcohol with water) show that as the amount of water present in the propyl-alcohol solution increases the absorption at the edge of the red band becomes less, and also that the edge of the infra-red band behaves in a similar manner. The behavior of the edge of the infra-red band is thus seen to be much the same in the cases of the methyl-alcohol and ethyl-alcohol mixtures.

TABLE 13.—Cobalt Chloride in Propyl Alcohol with Water (Fig. 11).

Wave-length.	Temp. = 22.1° <i>t</i> = 10.5 mm. <i>c</i> <sub>1</sub> = 0.3 <i>c</i> <sub>2</sub> = 0		Temp. = 19.6° <i>t</i> = 10.5 mm. <i>c</i> <sub>1</sub> = 0.3 <i>c</i> <sub>2</sub> = 1.11		Temp. = 19.8° <i>t</i> = 10.5 mm. <i>c</i> <sub>1</sub> = 0.3 <i>c</i> <sub>2</sub> = 2.78		Temp. = 19.8° <i>t</i> = 10.5 mm. <i>c</i> <sub>1</sub> = 0.3 <i>c</i> <sub>2</sub> = 5.55		Temp. = 20.1° <i>t</i> = 10.5 mm. <i>c</i> <sub>1</sub> = 0.3 <i>c</i> <sub>2</sub> = 6.67		Temp. = 19.4° <i>t</i> = 20.0 mm. <i>c</i> <sub>1</sub> = 0.3 <i>c</i> <sub>2</sub> = 18.0	
	<i>a</i>	<i>a</i> - <i>a</i> <sub>0</sub>	<i>a</i>	<i>a</i> - <i>a</i> <sub>0</sub>	<i>a</i>	<i>a</i> - <i>a</i> <sub>0</sub>	<i>a</i>	<i>a</i> - <i>a</i> <sub>0</sub>	<i>a</i>	<i>a</i> - <i>a</i> <sub>0</sub>	<i>a</i>	<i>a</i> - <i>a</i> <sub>0</sub>
724 $\mu\mu$	.....	.....	.....	.....	.....	.....	.....	.....	.....	.....	.....	.....
744	0.0992	0.0992	0.0446	0.0446	0.0268	0.0268	0.0353	0.0352	0.0191	0.0189	0.0047	0.0032
764	.0205	.0205	.0099	.0099	.0082	.0081	.0086	.0084	.0072	.0070	.0045	.0025
803	.0142	.0142	.0051	.0051	.0061	.0060	.0050	.0048	.0058	.0056	.0050	.0033
842	.0139	.0135	.0054	.0050	.0065	.0060	.0062	.0055	.0065	.0058	.0068	.0042
881	.0156	.0144	.0075	.0062	.0077	.0065	.0072	.0059	.0075	.0062	.0078	.0046
920	.0232	.0177	.0131	.0076	.0130	.0076	.0118	.0063	.0124	.0069	.0102	.0056
959	.0254	.0228	.0124	.0095	.0128	.0093	.0115	.0073	.0128	.0081	.0261	.0070
978	.0295	.0269	.0145	.0116	.0145	.0110	.0139	.0095	.0148	.0097	.0290	.0094
1018	.0439	.0384	.0222	.0171	.0219	.0160	.0205	.0141	.0214	.0149	.0279	.0140
1056	.0662	.0614	.0313	.0264	.0281	.0222	.0261	.0210	.0274	.0223	.0267	.0192
1095	.107	.103	.0470	.0432	.0376	.0336	.0335	.0293	.0339	.0296	.0359	.0275
1134	.....	.....	.0730	.0678	.0515	.0459	.0460	.0399	.0457	.0393	.0483	.0322

## COBALT NITRATE IN WATER.

Twenty-three solutions were prepared, varying in concentration from  $c = 3.205$  to  $c = 0.10$ . The  $A - c$  curves for all wave-lengths show that  $A$  is nearly constant for all concentrations. The  $A - c$  curves for the higher values of  $A$  indicate a very slight decrease in  $A$  as dilution proceeds. This decrease is small, being of about the same magnitude as the error in the determination of  $A$ .

TABLE 14.—Cobalt Nitrate in Water (Figs. 12 and 13).

Wave-length.	Temp. = 19.7° <i>t</i> = 6.36 mm. Conc. = 3.205		Temp. = 20.2° <i>t</i> = 6.36 mm. Conc. = 3.0		Temp. = 20.7° <i>t</i> = 6.36 mm. Conc. = 2.8		Temp. = 21.8° <i>t</i> = 6.36 mm. Conc. = 2.6		Temp. = 22.2° <i>t</i> = 6.36 mm. Conc. = 2.4		Temp. = 22.2° <i>t</i> = 6.36 mm. Conc. = 2.2	
	<i>a</i>	<i>A</i>	<i>a</i>	<i>A</i>	<i>a</i>	<i>A</i>	<i>a</i>	<i>A</i>	<i>a</i>	<i>A</i>	<i>a</i>	<i>A</i>
605 $\mu\mu$	0.130	0.0405	0.121	0.0402	0.104	0.0371	0.106	0.0407	0.0933	0.0389	0.0807	0.0367
645	.112	.0360	.102	.0338	.0881	.0314	.0865	.0333	.0802	.0334	.0703	.0319
684	.0693	.0216	.0645	.0215	.0583	.0208	.0563	.0217	.0509	.0212	.0453	.0206
724	.0413	.0124	.0401	.0129	.0359	.0123	.0338	.0124	.0313	.0124	.0282	.0122
764	.0325	.0095	.0305	.0095	.0287	.0095	.0277	.0099	.0249	.0095	.0225	.0093
803	.0367	.0109	.0355	.0113	.0321	.0109	.0304	.0110	.0282	.0110	.0258	.0109
842	.0464	.0137	.0438	.0137	.0391	.0130	.0371	.0133	.0354	.0137	.0325	.0136
881	.0513	.0150	.0493	.0154	.0457	.0152	.0436	.0156	.0398	.0153	.0374	.0155
920	.0597	.0172	.0576	.0177	.0530	.0173	.0494	.0176	.0459	.0176	.0431	.0179
959	.0908	.0223	.0860	.0223	.0806	.0219	.0771	.0223	.0732	.0225	.0684	.0224
978	.109	.0275	.106	.0286	.0978	.0275	.0953	.0287	.0888	.0284	.0819	.0279
1018	.150	.0423	.148	.0445	.132	.0422	.129	.0442	.118	.0434	.110	.0438
1056	.212	.0640	.207	.0665	.183	.0627	.169	.0619	.166	.0662	.149	.0643

TABLE 14.—Cobalt Nitrate in Water (Figs. 12 and 13)—Continued.

Wave-length.	Temp. =21.3° <i>t</i> =6.36 mm. Conc. =2.0		Temp. =21.4° <i>t</i> =6.36 mm. Conc. =1.8		Temp. =20.7° <i>t</i> =10.5 mm. Conc. =1.6		Temp. =21.1° <i>t</i> =10.5 mm. Conc. =1.4		Temp. =21.8° <i>t</i> =10.5 mm. Conc. =1.2		Temp. =22.8° <i>t</i> =10.5 mm. Conc. =1.0	
	<i>a</i>	<i>A</i>	<i>a</i>	<i>A</i>	<i>a</i>	<i>A</i>	<i>a</i>	<i>A</i>	<i>a</i>	<i>A</i>	<i>a</i>	<i>A</i>
605 $\mu$	0.0745	0.0373	0.0658	0.0365	0.0563	0.0352	0.0504	0.0360	0.0437	0.0364	0.0359	0.0359
645	.0639	.0320	.0548	.0305	.0511	.0319	.0434	.0310	.0382	.0319	.0312	.0312
684	.0409	.0205	.0362	.0201	.0324	.0203	.0289	.0206	.0241	.0201	.0194	.0194
724	.0244	.0115	.0221	.0114	.0200	.0116	.0173	.0113	.0151	.0113	.0128	.0113
764	.0202	.0091	.0168	.0082	.0165	.0091	.0139	.0085	.0124	.0087	.0106	.0086
803	.0221	.0102	.0200	.0102	.0189	.0107	.0148	.0094	.0139	.0102	.0111	.0094
842	.0291	.0133	.0263	.0132	.0232	.0129	.0200	.0124	.0176	.0125	.0151	.0125
881	.0332	.0150	.0318	.0149	.0268	.0147	.0236	.0146	.0207	.0146	.0176	.0144
920	.0379	.0167	.0361	.0175	.0316	.0169	.0276	.0164	.0246	.0167	.0212	.0166
959	.0627	.0218	.0581	.0217	.0538	.0217	.0485	.0210	.0438	.0206	.0407	.0216
978	.0760	.0277	.0689	.0268	.0652	.0279	.0586	.0271	.0528	.0269	.0471	.0265
1018	.0964	.0413	.0893	.0419	.0808	.0418	.0734	.0425	.0638	.0416	.0538	.0399
1056	.137	.0648	.123	.0642	.108	.0625	.0923	.0606	.0823	.0623	.0697	.0622

Wave-length.	Temp. =22.7° <i>t</i> =10.5 mm. Conc. =0.9		Temp. =22.9° <i>t</i> =20.2 mm. Conc. =0.8		Temp. =22.5° <i>t</i> =20.2 mm. Conc. =0.7		Temp. =22.2° <i>t</i> =20.2 mm. Conc. =0.6		Temp. =22.3° <i>t</i> =20.2 mm. Conc. =0.5		Temp. =22.5° <i>t</i> =20.2 mm. Conc. =0.4	
	<i>a</i>	<i>A</i>	<i>a</i>	<i>A</i>	<i>a</i>	<i>A</i>	<i>a</i>	<i>A</i>	<i>a</i>	<i>A</i>	<i>a</i>	<i>A</i>
605 $\mu$	0.0326	0.0361	0.0278	0.0347	0.0248	0.0354	0.0206	0.0343	0.0177	0.0354	0.0146	0.0365
645	.0283	.0314	.0255	.0319	.0221	.0316	.0187	.0315	.0158	.0316	.0126	.0315
684	.0184	.0204	.0155	.0194	.0139	.0199	.0118	.0197	.0100	.0204	.0084	.0210
724	.0115	.0111	.0107	.0115	.0086	.0101	.0077	.0103	.0075	.0120	.0055	.0100
764	.0092	.0080	.0086	.0083	.0075	.0079	.0068	.0080	.0060	.0080	.0051	.0078
803	.0106	.0099	.0097	.0100	.0084	.0094	.0072	.0092	.0063	.0092	.0055	.0095
842	.0139	.0126	.0124	.0123	.0110	.0120	.0100	.0123	.0086	.0120	.0074	.0120
881	.0162	.0144	.0146	.0143	.0129	.0139	.0118	.0143	.0101	.0138	.0096	.0160
920	.0205	.0177	.0174	.0160	.0155	.0156	.0148	.0170	.0125	.0158	.0119	.0183
959	.0381	.0211	.0356	.0206	.0331	.0200	.0316	.0208	.0293	.0204	.0278	.0218
978	.0457	.0279	.0411	.0256	.0381	.0250	.0363	.0262	.0345	.0278	.0316	.0275
1018	.0500	.0401	.0447	.0385	.0407	.0383	.0372	.0388	.0342	.0406	.0294	.0388
1056	.0628	.0614	.0576	.0626	.0493	.0597	.0443	.0613	.0384	.0618	.0320	.0613

Wave-length.	Temp. =22.5° <i>t</i> =20.2 mm. Conc. =0.3		Temp. =22.6° <i>t</i> =20.2 mm. Conc. =0.25		Temp. =22.7° <i>t</i> =20.2 mm. Conc. =0.20		Temp. =22.7° <i>t</i> =20.2 mm. Conc. =0.15		Temp. =21.6° <i>t</i> =20.2 mm. Conc. =0.10	
	<i>a</i>	<i>A</i>	<i>a</i>	<i>A</i>	<i>a</i>	<i>A</i>	<i>a</i>	<i>A</i>	<i>a</i>	<i>A</i>
605 $\mu$	0.0114	0.0380	0.0092	0.0368	0.0074	0.0370	0.0060	0.0400	0.0043	0.0430
645	.0098	.0327	.0080	.0320	.0064	.0320	.0049	.0333	.0039	.0390
684	.0063	.0210	.0056	.0224	.0041	.0205	.0036	.0240	.0028	.0280
724	.0041	.0087	.0039	.0096	.0030	.0075	.0028	.0087	.0024	.0090
764	.0048	.0093	.0039	.0076	.0030	.0050	.0028	.0053	.0026	.0060
803	.0041	.0080	.0039	.0088	.0032	.0075	.0026	.0060	.0020	.0030
842	.0060	.0113	.0056	.0120	.0043	.0085	.0041	.0100	.0030	.0040
881	.0074	.0140	.0066	.0136	.0055	.0115	.0048	.0107	.0039	.0070
920	.0095	.0163	.0087	.0164	.0084	.0190	.0069	.0153	.0063	.0170
959	.0258	.0223	.0239	.0192	.0227	.0180	.0217	.0173	.0213	.0220
978	.0292	.0287	.0273	.0268	.0255	.0245	.0245	.0260	.0235	.0290
1018	.0257	.0393	.0235	.0384	.0212	.0365	.0194	.0367	.0178	.0390
1056	.0258	.0610	.0225	.0600	.0191	.0630	.0162	.0580	.0136	.0610

Houstoun has measured two solutions of cobalt nitrate in water. His values are given in table 15, for the sake of comparison.

The agreement, though poor, is better than the agreement in the case of the cobalt chloride. Plate 19 of the paper by Jones and Anderson shows that  $A$  is constant with respect to  $c$  for wave-lengths on the red edge of the yellow-green absorption band of an aqueous solution of cobalt nitrate.

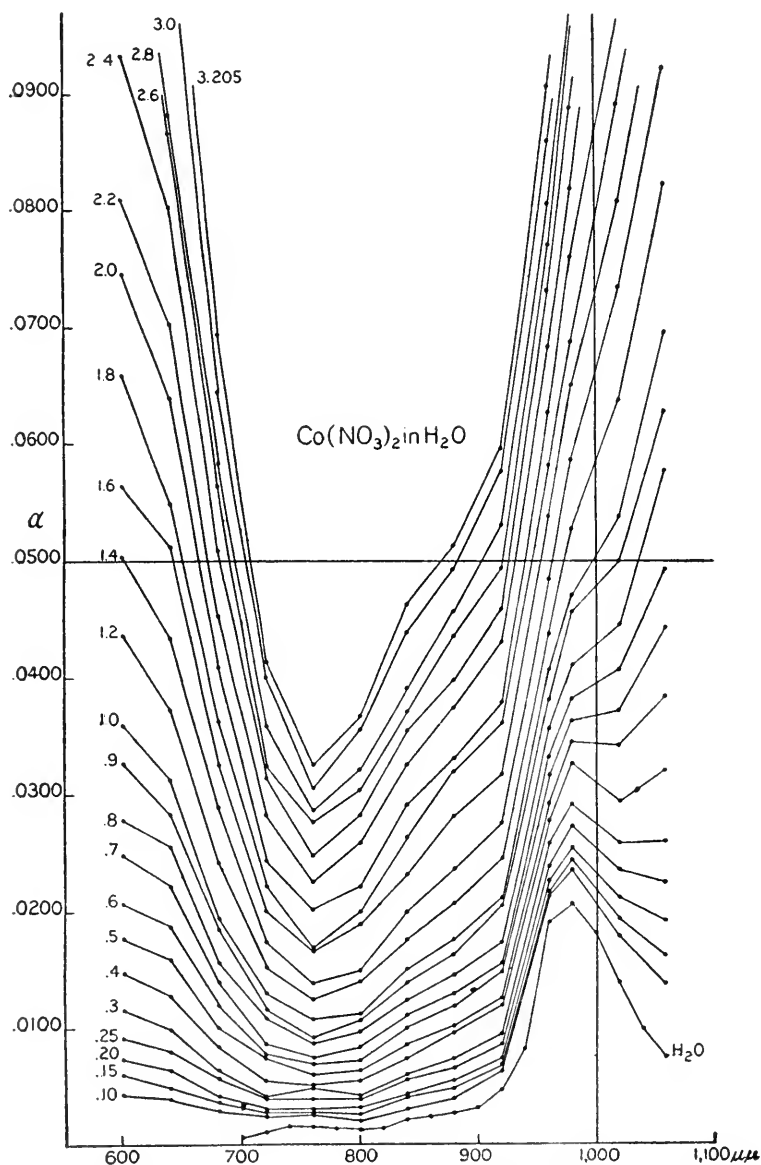

FIG. 12.—The Absorption Curves for Cobalt Nitrate in Water.



TABLE 15.—*A* for Cobalt Nitrate in Water.

Wave-length.	<i>c</i> = 0.67		<i>c</i> = 3.66	
	Houstoun.	From table 14.	Houstoun.	Remarks.
684	0.011	0.0198	0.020	No data for comparison.
720	.010	.0102	.010	
750	.010	.0082	.009	
794	.012	.0091	.012	
850	.013	.0125	.016	
910	.018	.0181	.017	
980	.033	.0256	.031	

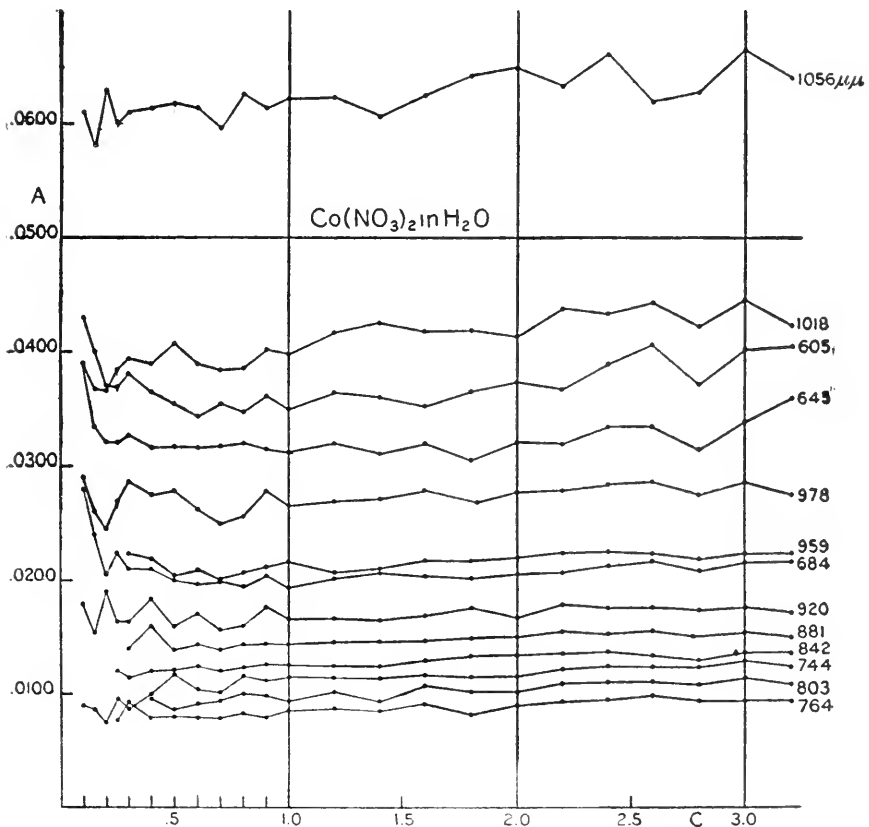

FIG. 13.—The *A*-*c* Curves for Cobalt Nitrate in Water.

COBALT SULPHATE IN WATER.

Seventeen solutions were prepared, varying in concentration from *c* = 2.06 to *c* = 0.10. The *A* - *c* curves show that throughout the whole region of wave-lengths studied *A* is a constant for all values of *c*.

TABLE 16.—Cobalt Sulphate in Water (Figs. 14 and 15).

Wave-length.	Temp. = 21.4° <i>t</i> = 10.5 mm. Conc. = 2.06		Temp. = 22.4° <i>t</i> = 10.5 mm. Conc. = 1.8		Temp. = 18.5° <i>t</i> = 10.5 mm. Conc. = 1.6		Temp. = 19.4° <i>t</i> = 10.5 mm. Conc. = 1.4		Temp. = 20.8° <i>t</i> = 10.5 mm. Conc. = 1.2		Temp. = 20.3° <i>t</i> = 10.5 mm. Conc. = 1.0	
	<i>a</i>	<i>A</i>	<i>a</i>	<i>A</i>	<i>a</i>	<i>A</i>	<i>a</i>	<i>A</i>	<i>a</i>	<i>A</i>	<i>a</i>	<i>A</i>
605 $\mu$ m	0.0729	0.0361	0.0668	0.0371	0.0557	0.0348	0.0504	0.0360	0.0428	0.0356	0.0372	0.0372
625	.0730	.0361	.0613	.0341	.0577	.0360	.0509	.0363	.0400	.0334	.0349	.0349
644	.0681	.0336	.0652	.0362	.0562	.0351	.0484	.0346	.0413	.0344	.0348	.0348
664	.0594	.0284	.0508	.0282	.0463	.0289	.0403	.0288	.0353	.0294	.0295	.0395
684	.0507	.0251	.0431	.0240	.0375	.0234	.0324	.0231	.0283	.0236	.0238	.0238
704	.0433	.0201	.0349	.0188	.0299	.0181	.0278	.0191	.0231	.0184	.0202	.0192
724	.0364	.0173	.0309	.0163	.0259	.0153	.0236	.0158	.0200	.0154	.0174	.0159
744	.0312	.0144	.0274	.0141	.0231	.0132	.0207	.0133	.0176	.0130	.0153	.0133
764	.0285	.0131	.0248	.0127	.0215	.0122	.0194	.0124	.0162	.0118	.0145	.0125
783	.0274	.0127	.0238	.0122	.0207	.0118	.0184	.0119	.0159	.0117	.0139	.0121
803	.0287	.0133	.0252	.0131	.0219	.0126	.0192	.0125	.0168	.0126	.0142	.0125
823	.0303	.0141	.0259	.0134	.0227	.0131	.0207	.0135	.0179	.0134	.0151	.0133
842	.0331	.0151	.0287	.0145	.0257	.0144	.0227	.0144	.0200	.0145	.0171	.0145
861	.0351	.0160	.0301	.0152	.0269	.0151	.0241	.0152	.0213	.0154	.0184	.0156
881	.0364	.0164	.0323	.0162	.0291	.0162	.0254	.0159	.0225	.0161	.0189	.0157
901	.0391	.0175	.0335	.0166	.0299	.0164	.0264	.0163	.0231	.0162	.0207	.0171
920	.0422	.0186	.0374	.0182	.0339	.0183	.0303	.0183	.0261	.0179	.0229	.0183
940	.0 92	.0203	.0442	.0200	.0389	.0192	.0359	.0198	.0324	.0202	.0283	.0201
960	.0657	.0230	.0603	.0229	.0532	.0213	.0494	.0216	.0457	.0222	.0426	.0235
979	.0768	.0278	.0703	.0276	.0644	.0274	.0608	.0287	.0551	.0288	.0488	.0282
998	.0905	.0357	.0820	.0355	.0720	.0337	.0663	.0344	.0610	.0357	.0547	.0366
1018	.105	.0450	.0916	.0432	.0838	.0437	.0741	.0430	.0656	.0431	.0575	.0436
1037	.124	.0563	.110	.0556	.0975	.0547	.0867	.0548	.0739	.0533	.0628	.0529

Wave-length.	Temp. = 18.5° <i>t</i> = 10.5 mm. Conc. = 0.9		Temp. = 18.7° <i>t</i> = 10.5 mm. Conc. = 0.8		Temp. = 20.5° <i>t</i> = 10.5 mm. Conc. = 0.7		Temp. = 21.2° <i>t</i> = 20.2 mm. Conc. = 0.6		Temp. = 21.3° <i>t</i> = 20.2 mm. Conc. = 0.5		Temp. = 16.3° <i>t</i> = 20.2 mm. Conc. = 0.4	
	<i>a</i>	<i>A</i>	<i>a</i>	<i>A</i>	<i>a</i>	<i>A</i>	<i>a</i>	<i>A</i>	<i>a</i>	<i>A</i>	<i>a</i>	<i>A</i>
605 $\mu$ m	0.0333	0.0370	0.0285	0.0356	0.0264	0.0377	0.0220	0.0367	0.0189	0.0378	0.0147	0.0368
625	.0314	.0349	.0295	.0369	.0259	.0370	.0213	.0355	.0180	.0360	.0138	.0345
644	.0312	.0347	.0281	.0351	.0236	.0337	.0209	.0348	.0175	.0350	.0137	.0342
664	.0261	.0290	.0241	.0302	.0207	.0296	.0183	.0305	.0153	.0310	.0121	.0303
684	.0207	.0230	.0182	.0227	.0162	.0231	.0145	.0241	.0122	.0244	.0099	.0248
704	.0173	.0181	.0156	.0183	.0131	.0173	.0122	.0185	.0100	.0180	.0086	.0190
724	.0148	.0148	.0136	.0151	.0115	.0143	.0106	.0151	.0093	.0156	.0072	.0138
744	.0133	.0126	.0121	.0126	.0109	.0127	.0099	.0181	.0087	.0134	.0072	.0130
764	.0124	.0116	.0115	.0119	.0096	.0109	.0089	.0115	.0080	.0120	.0063	.0108
783	.0121	.0115	.0115	.0121	.0096	.0111	.0087	.0115	.0078	.0120	.0063	.0113
803	.0124	.0119	.0115	.0123	.0096	.0113	.0089	.0120	.0077	.0120	.0063	.0115
823	.0133	.0128	.0121	.0129	.0102	.0120	.0097	.0115	.0090	.0144	.0069	.0128
842	.0148	.0136	.0136	.0138	.0115	.0127	.0106	.0133	.0096	.0140	.0077	.0128
861	.0159	.0146	.0148	.0150	.0124	.0137	.0114	.0143	.0101	.0146	.0086	.0145
881	.0171	.0155	.0156	.0155	.0133	.0144	.0120	.0148	.0109	.0154	.0094	.0155
901	.0184	.0165	.0168	.0165	.0145	.0156	.0135	.0165	.0117	.0162	.0103	.0168
920	.0205	.0177	.0187	.0176	.0159	.0162	.0150	.0173	.0134	.0176	.0114	.0170
940	.0257	.0195	.0236	.0193	.0218	.0191	.0200	.0197	.0182	.0200	.0163	.0203
960	.0389	.0220	.0371	.0225	.0355	.0234	.0324	.0221	.0302	.0222	.0271	.0200
979	.0457	.0279	.0428	.0278	.0402	.0280	.0376	.0283	.0348	.0284	.0316	.0275
998	.0496	.0350	.0462	.0351	.0420	.0341	.0392	.0351	.0356	.0350	.0317	.0340
1018	.0528	.0433	.0487	.0435	.0429	.0414	.0401	.0437	.0352	.0426	.0312	.0433
1037	.0565	.0518	.0527	.0536	.0474	.0536	.0422	.0538	.0368	.0538	.0319	.0550

TABLE 16.—Cobalt Sulphate in Water (Figs. 14 and 15)—Continued.

Wave-length.	Temp. = 18.2° <i>t</i> = 20.2 mm. Conc. = 0.3		Temp. = 18.3° <i>t</i> = 20.2 mm. Conc. = 0.25		Temp. = 14.3° <i>t</i> = 20.2 mm. Conc. = 0.2		Temp. = 14.6° <i>t</i> = 20.2 mm. Conc. = 0.15		<i>t</i> = 20.2 mm. Conc. = 0.1	
	<i>a</i>	<i>A</i>	<i>a</i>	<i>A</i>	<i>a</i>	<i>A</i>	<i>a</i>	<i>A</i>	<i>a</i>	<i>A</i>
605 $\mu\mu$	0.0113	0.0377	0.0097	0.0388	0.0077	0.0385	0.0061	0.0407	0.0045	0.045
625	.0102	.0340	.0090	.0360	.0071	.0355	.0060	.0400	.0038	.038
644	.0105	.0350	.0083	.0332	.0069	.0345	.0056	.0373	.0034	.034
664	.0089	.0297	.0050	.0320	.0060	.0300	.0046	.0307	.0034	.034
684	.0075	.0250	.0063	.0252	.0045	.0225	.0039	.0260	.0026	.026
704	.0058	.0160	.0051	.0164	.0038	.0140	.0032	.0147	.0022	.012
724	.0059	.0147	.0048	.0132	.0036	.0105	.0036	.0140	.0022	.007
744	.0055	.0117	.0046	.0104	.0038	.0090	.0036	.0107	.0024	.004
764	.0055	.0117	.0046	.0104	.0034	.0070	.0032	.0080	.0024	.004
783	.0049	.0103	.0043	.0100	.0036	.0090	.0032	.0093	.0024	.006
803	.0051	.0113	.0043	.0104	.0034	.0085	.0032	.0100	.0022	.005
823	.0055	.0123	.0046	.0112	.0038	.0100	.0032	.0093	.0024	.006
842	.0063	.0123	.0055	.0116	.0045	.0095	.0041	.0100	.0030	.004
861	.0068	.0133	.0058	.0120	.0049	.0105	.0045	.0113	.0034	.006
881	.0074	.0140	.0064	.0128	.0055	.0115	.0051	.0127	.0036	.004
901	.0081	.0150	.0074	.0152	.0063	.0135	.0056	.0133	.0046	.010
920	.0097	.0170	.0087	.0164	.0074	.0140	.0068	.0147	.0058	.010
940	.0139	.0190	.0128	.0184	.0111	.0145	.0107	.0162	.0096	.014
960	.0254	.0210	.0244	.0212	.0220	.0145	.0214	.0153	.0202	.011
979	.0284	.0260	.0281	.0300	.0253	.0235	.0247	.0273	.0225	.019
998	.0282	.0337	.0269	.0352	.0247	.0330	.0233	.0347	.0210	.029
1018	.0259	.0400	.0252	.0452	.0225	.0430	.0201	.0413	.0177	.038
1037	.0256	.0514	.0232	.0533	.0198	.0495	.0175	.0507	.0146	.047

Houstoun has measured two solutions of cobalt sulphate in water. His values are given in table 17, for the sake of comparison.

TABLE 17.—*A* for Cobalt Sulphate in Water.

Wave-length.	<i>c</i> = 0.67		<i>c</i> = 2.00	
	Houstoun.	From table 16.	Houstoun.	From table 16.
684	0.014	0.0233	0.0117	0.0253
720	.005	.0140	.0078	.0175
750	.003	.0126	.0057	.0137
794	.007	.0123	.0073	.0133
850	.012	.0137	.0136	.0155
910	.012	.0162	.0114	.0180
980	.022	.0281	.0211	.0278

Houstoun's values for *A* are in general much lower than the values recorded in table 16. His values indicate, however, that *A* is a constant with respect to *c* at all points in the spectrum, which is in agreement with the results of the present work. Plate 21 of the paper by

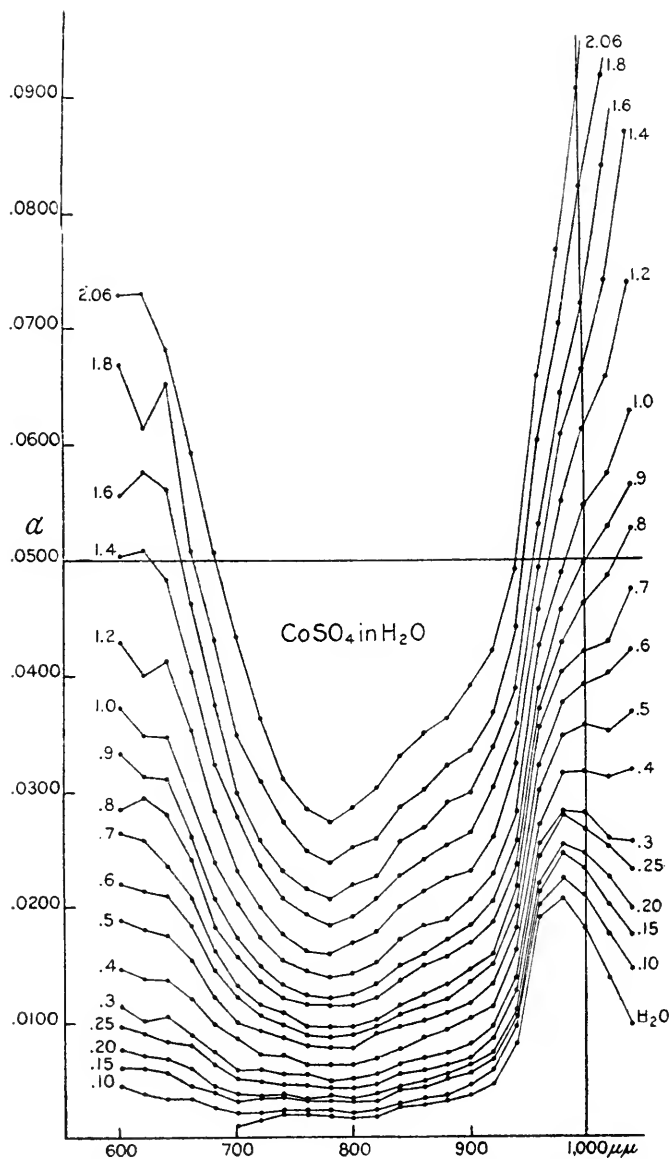

FIG. 14.—The Absorption Curves for Cobalt Sulphate in Water.

Jones and Anderson<sup>1</sup> also shows the constancy of  $A$  for wave-lengths on the long wave-length side of the yellow-green absorption band of an aqueous solution of cobalt sulphate.

<sup>1</sup>Carnegie Inst. Wash. Pub. No. 110.

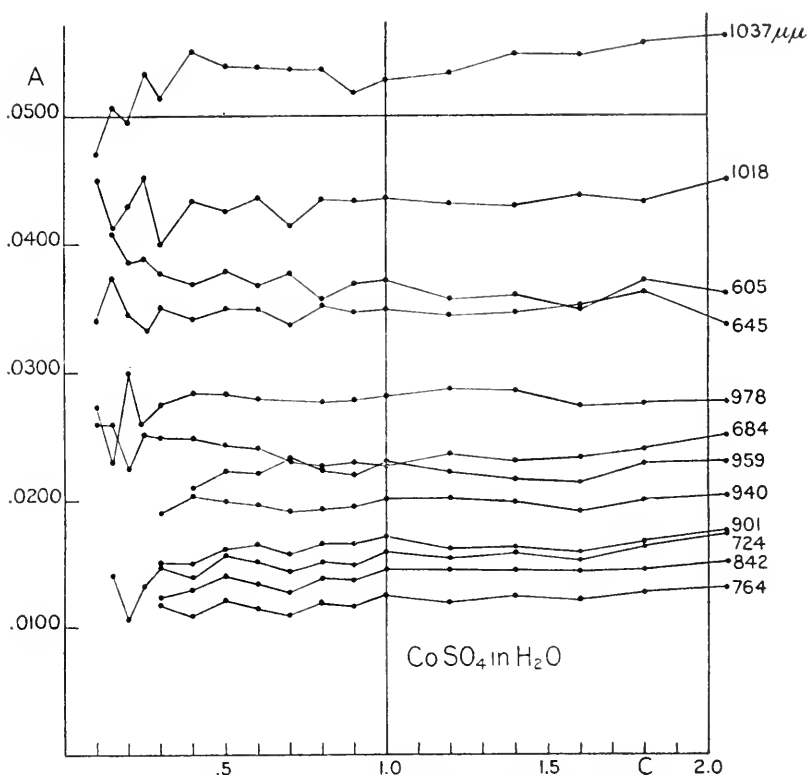

Fig. 15.—The  $A-c$  Curves for Cobalt Sulphate in Water.

#### NICKEL CHLORIDE IN WATER.

Nineteen solutions were prepared, varying in concentration from  $c=3.945$  to  $c=0.05$ . The absorption curves cover the region from  $550\mu\mu$  to  $1,150\mu\mu$ . In this region the water solutions of nickel chloride have an absorption band in the red with its maximum at  $744\mu\mu$ , a region of transmission with minimum absorption at about  $880\mu\mu$ , and absorption again beyond this.

The  $A-c$  curves show that the values of  $A$  undergo changes with  $c$  depending upon the wave-length. For wave-lengths  $565\mu\mu$  and  $605\mu\mu$ , which lie nearly in the region of green transmission,  $A$  is a constant for all concentrations. For wave-lengths  $645\mu\mu$  and  $684\mu\mu$ , which are on the short-wave side of the red absorption band,  $A$  increases with dilution. At the top of the band, at  $724\mu\mu$ ,  $A$  is again constant. For wave-lengths  $803\mu\mu$  to  $920\mu\mu$ , which lie on the long-wave side, the red absorption band decreases with dilution. The result of these changes is to shift the band as a whole towards the blue with dilution. The

$A - c$  curves for wave-lengths beyond  $978\mu\mu$ , on the edge of the infra-red absorption band, show that  $A$  is a constant for all values of  $c$ .

The shift of the red band may also be seen from an inspection of the absorption curves. This is seen, not by looking at the summit of the band, which remains unchanged in position of the minimum of absorption, which is situated at  $920\mu\mu$  for  $c$  greater than 2.5, and at  $881\mu\mu$  for  $c$  less than 2.5.

TABLE 18.—Nickel Chloride in Water (Figs. 16 and 17).

Wave-length.	Temp. = 20.3° $t = 2.73$ mm. Conc. = 3.945		Temp. = 20.3° $t = 2.73$ mm. Conc. = 3.5		Temp. = 20.3° $t = 2.73$ mm. Conc. = 3.0		Temp. = 20.5° $t = 2.73$ mm. Conc. = 2.5		Temp. = 20.8° $t = 2.73$ mm. Conc. = 2.0		Temp. = 21.5° $t = 2.73$ mm. Conc. = 1.5		Temp. = 21.5° $t = 6.36$ mm. Conc. = 1.0	
	$a$	$A$	$a$	$A$	$a$	$A$	$a$	$A$	$a$	$A$	$a$	$A$	$a$	$A$
565 $\mu\mu$	0.0945	0.0243	0.0872	0.0249	0.0746	0.0249	0.0568	0.0227	0.0555	0.0278	0.0454	0.0303	0.0258	0.0258
605	.....	.....	.....	.....	.....	.....	.176	.0703	.160	.0798	.114	.0763	.0681	.0681
764	.....	.....	.....	.....	.....	.....	.....	.....	.....	.....	.260	.172	.153	.151
803	.....	.....	.....	.....	.....	.....	.268	.107	.217	.108	.149	.0978	.0899	.0882
842	.353	.0887	.274	.0774	.206	.0678	.151	.0593	.114	.0556	.0816	.0527	.0513	.0487
881	.198	.0494	.156	.0437	.121	.0391	.0963	.0375	.0666	.0317	.0523	.0327	.0341	.0309
920	.164	.0404	.138	.0380	.115	.0368	.0956	.0362	.0769	.0362	.0578	.0355	.0371	.0325
959	.221	.0517	.200	.0516	.172	.0510	.155	.0544	.125	.0527	.0971	.0520	.0685	.0494
978	.265	.0620	.248	.0648	.213	.0641	.182	.0645	.153	.0662	.122	.0672	.0822	.0616
1018	.....	.....	.....	.....	.290	.0919	.250	.0940	.225	.105	.170	.104	.1185	.104
1056	.....	.....	.....	.....	.....	.....	.....	.....	.....	.....	.221	.142	.137	.129
1095	.....	.....	.....	.....	.....	.....	.....	.....	.....	.....	.257	.165	.149	.141

Wave-length.	Temp. = 22.0° $t = 6.36$ mm. Conc. = 0.9		Temp. = 20.4° $t = 6.36$ mm. Conc. = 0.8		Temp. = 20.2° $t = 6.36$ mm. Conc. = 0.7		Temp. = 21.0° $t = 6.36$ mm. Conc. = 0.6		Temp. = 21.5° $t = 6.36$ mm. Conc. = 0.5		Temp. = 22.7° $t = 6.36$ mm. Conc. = 0.4	
	$a$	$A$	$a$	$A$	$a$	$A$	$a$	$A$	$a$	$A$	$a$	$A$
565 $\mu\mu$	0.0263	0.0292	0.0225	0.0281	0.0225	0.0321	0.0191	0.0318	0.0125	0.0250	0.0125	0.0313
605	.0652	.0723	.0563	.0704	.0494	.0706	.0453	.0755	.0332	.0764	.0304	.0760
645	.....	.....	.....	.....	.114	.163	.0931	.155	.0787	.158	.0685	.171
684	.....	.....	.....	.....	.125	.178	.106	.177	.0890	.178	.0750	.188
724	.....	.....	.....	.....	.145	.204	.125	.205	.105	.206	.0850	.207
764	.138	.151	.129	.158	.115	.162	.0933	.152	.0793	.155	.0635	.153
803	.0816	.0888	.0750	.0916	.0638	.0887	.0557	.0900	.0456	.0878	.0300	.0908
842	.0470	.0493	.0406	.0475	.0343	.0453	.0313	.0478	.0268	.0484	.0230	.0510
881	.0309	.0308	.0272	.0300	.0230	.0283	.0216	.0307	.0180	.0296	.0146	.0285
920	.0346	.0333	.0308	.0328	.0268	.0317	.0249	.0338	.0211	.0330	.0169	.0383
959	.0608	.0463	.0589	.0498	.0522	.0473	.0494	.0505	.0445	.0508	.0390	.0498
978	.0775	.0633	.0715	.0636	.0642	.0623	.0598	.0653	.0527	.0642	.0459	.0633
1018	.100	.0960	.0927	.0985	.0803	.0949	.0723	.0973	.0630	.0982	.0538	.0998
1056	.121	.127	.114	.134	.0973	.128	.0873	.133	.0757	.0364	.0621	.137
1095	.145	.152	.135	.158	.117	.154	.107	.164	.0906	.164	.0763	.170
1133	.....	.....	.....	.....	.....	.....	.....	.....	.....	.....	.0894	.183

TABLE 18.—Nickel Chloride in Water (Figs. 16 and 17)—Continued.

Wave-length.	Temp. =23.3° <i>t</i> =6.36 mm. Conc. =0.3		Temp. =23.3° <i>t</i> =10.5 mm. Conc. =0.25		Temp. =23.0° <i>t</i> =10.5 mm. Conc. =0.20		Temp. =21.0° <i>t</i> =20.2 mm. Conc. =0.15		Temp. =20.2° <i>t</i> =20.2 mm. Conc. =0.10		Temp. =20.2° <i>t</i> =20.2 mm. Conc. =0.05	
	<i>a</i>	<i>A</i>	<i>a</i>	<i>A</i>	<i>a</i>	<i>A</i>	<i>a</i>	<i>A</i>	<i>a</i>	<i>A</i>	<i>a</i>	<i>A</i>
565 $\mu$	0.0102	0.0307	0.0079	0.0316	0.0062	0.0310	0.0038	0.0246	0.0036	0.0360	0.0022	0.0440
605	.0239	.0797	.0187	.0748	.0153	.0765	.0113	.0752	.0083	.0830	.0043	.0860
645	.0513	.171	.0417	.167	.0345	.173	.0265	.177	.0168	.168	.0089	.178
684	.0573	.191	.0457	.183	.0377	.189	.0294	.196	.0193	.193	.0099	.198
724	.0645	.210	.0533	.207	.0443	.214	.0321	.204	.0225	.210	.0113	.196
764	.0485	.155	.0405	.154	.0335	.158	.0243	.149	.0174	.154	.0093	.0460
803	.0291	.0913	.0236	.0876	.0190	.0865	.0143	.0840	.0105	.0890	.0055	.0760
842	.0169	.0477	.0139	.0452	.0115	.0445	.0086	.0400	.0074	.0480	.0043	.0340
881	.0125	.0310	.0099	.0268	.0086	.0270	.0066	.0226	.0060	.0280	.0041	.0180
920	.0146	.0333	.0128	.0328	.0106	.0300	.0089	.0286	.0078	.0320	.0058	.0240
959	.0346	.0517	.0312	.0484	.0289	.0490	.0257	.0440	.0238	.0470	.0209	.0360
978	.0406	.0667	.0368	.0648	.0335	.0645	.0302	.0640	.0266	.0600	.0232	.0520
1018	.0439	.100	.0381	.0968	.0329	.0950	.0284	.0967	.0237	.0930	.0178	.0780
1056	.0477	.134	.0410	.134	.0359	.142	.0277	.135	.0215	.140	.0137	.124
1095	.0595	.170	.0504	.168	.0427	.172	.0337	.169	.0256	.172	.0160	.152
1133	.0723	.187	.0622	.184	.0546	.193	.0436	.184	.0347	.186	.0255	.188

Houstoun has measured two solutions of nickel chloride in water. His values are shown in table 19 for the sake of comparison, and it is seen that the two sets of values are not greatly at variance.

TABLE 19.—*A* for Nickel Chloride in Water.

Wave-length.	<i>c</i> =0.757		<i>c</i> =4.09	
	Houstoun.	From table 16.	Houstoun.	Remarks.
684	0.19	0.178	0.229	No data for comparison.
720	.19	.200	.258	
750	.146	.160	.168	
794	.071	.090	.101	
850	.033	.042	.045	
910	.030	.030	.039	
980	.062	.047	.089	
1070	.146	.140	.170	

Houstoun's values indicate that *A* decreases considerably with dilution, which is contradictory to the results of the present work. Plate 25 of the paper by Jones and Anderson<sup>1</sup> would seem to indicate that *A* is very nearly constant, possibly decreasing slightly with dilution, for wave-lengths on the short wave-length side of the red absorption band. However, they state that the photographic method, such as they used, is not the best method for studying a band whose edge is hazy and not sharply defined as is the case for this nickel band.

<sup>1</sup>Carnegie Inst. Wash. Pub. No. 110.

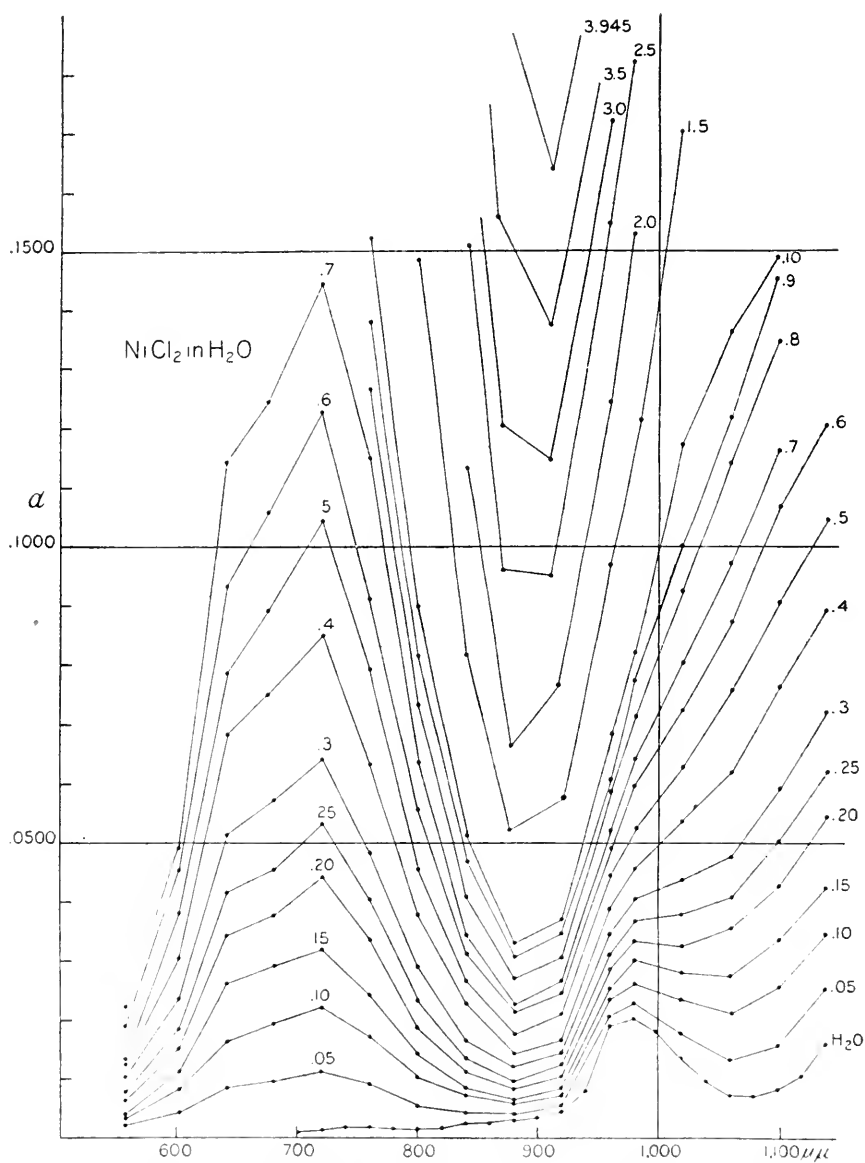

FIG. 16.—The Absorption Curves for Nickel Chloride in Water.



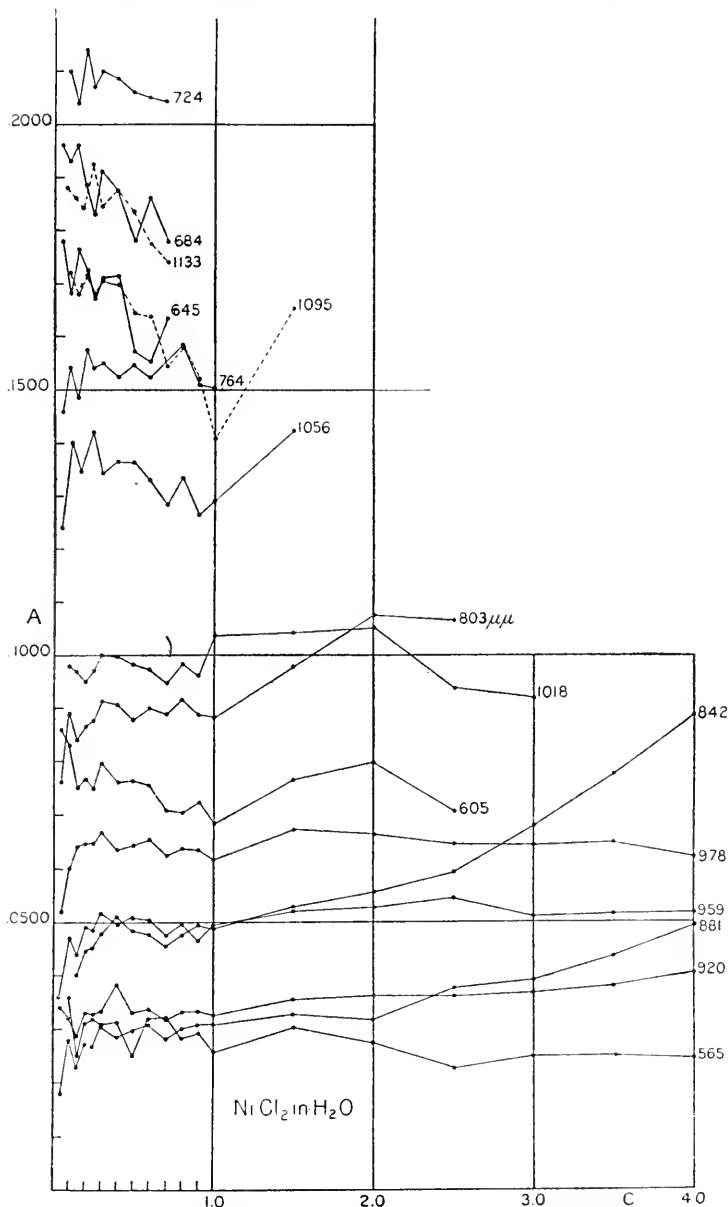

FIG. 17.—The A-c Curves for Nickel Nitrate in Water.

NiCl<sub>2</sub>·6H<sub>2</sub>O IN ALCOHOLS.

In view of the fact that the cobalt bands exhibit such interesting changes with the character of the solvent, an attempt was made to prepare alcoholic solutions of nickel chloride. The dehydrated salt, however, did not dissolve perceptibly in any of the three lower alcohols.

In the case of the methyl alcohol, a pale greenish-yellow solution resulted after the salt had been allowed to remain in the alcohol for several days. It is believed that this was due to traces of water, for the addition of the slightest amount of water produced a similar greenish-yellow solution. The ethyl and propyl alcohols remained colorless even after standing above the salt for days. Three solutions of unknown concentration were prepared by dropping a few crystals of the hydrate  $\text{NiCl}_2 \cdot 6\text{H}_2\text{O}$  into methyl, ethyl, and propyl alcohols. The resulting solutions all showed the green color characteristic of the aqueous solution.

TABLE 20.— $\text{NiCl}_2 \cdot 6\text{H}_2\text{O}$  in Alcohols (Fig. 18).

Wave-length.	$\text{NiCl}_2$ in $\text{H}_2\text{O}$ .	$\text{NiCl}_2 \cdot 6\text{H}_2\text{O}$ in $\text{CH}_3\text{OH}$ .	$\text{NiCl}_2 \cdot 6\text{H}_2\text{O}$ in $\text{C}_2\text{H}_5\text{OH}$	$\text{NiCl}_2 \cdot 6\text{H}_2\text{O}$ in $\text{C}_3\text{H}_7\text{OH}$ .
	Temp. = $21.5^\circ$ $t = 6.36$ mm. Conc. = 0.5	Temp. = $21.6^\circ$ $t = 6.36$ mm. Conc. unknown.	Temp. = $21.4^\circ$ $t = 6.36$ mm. Conc. unknown.	Temp. = $21.3^\circ$ $t = 6.36$ mm. Conc. unknown.
	$\alpha$	$\alpha$	$\alpha$	$\alpha$
605 $\mu\mu$	0.0382	.....	.....	.....
615	.....	.....	.....	.....
625	.0593	.....	.....	.....
635	.....	.....	.....	.....
645	.0787	0.0428	0.0550	0.0215
655	.....	.0489	.0607	.0257
664	.0851	.0555	.0700	.0268
674	.....	.0577	.0740	.0295
684	.0890	.0626	.0781	.0308
694	.....	.0624	.0740	.0282
704	.0962	.0640	.0661	.0264
714	.....	.0647	.0621	.0239
724	.105	.0710	.0593	.0230
734	.....	.0720	.0560	.0230
744	.0979	.0745	.0587	.0258
754	.....	.0729	.0607	.0263
764	.0793	.0682	.0615	.0258
774	.....	.0668	.0591	.0258
783	.0638	.0597	.0569	.0243
794	.....	.0543	.0533	.0243
803	.0456	.0505	.0518	.0210
813	.....	.0442	.0435	.0195
823	.....	.0390	.0415	.0174
833	.....	.0350	.0413	.0157
842	.....	.0308	.0332	.0146

The absorption curves for these three solutions show that the band in the red possesses two maxima. The absorption curve of nickel chloride in water,  $c = 0.5$ , is also plotted in figure 18 for the sake of comparison. The absorption band for the aqueous solution has a single maximum at  $724\mu\mu$ . In the curve for the methyl-alcohol solution this maximum has been shifted to  $744\mu\mu$  and there appears a second small maximum at  $684\mu\mu$ . The curve for the ethyl-alcohol solution shows that the first peak has experienced a still further shift towards the red to  $764\mu\mu$ , and that the second peak at  $684\mu\mu$  has

greatly increased in height. In the curve for the propyl-alcohol solution the positions and relative height of the two peaks are much the same as in the case of the ethyl-alcohol solution.

In this connection a paper by T. R. Merton<sup>1</sup> deserves mention. The absorption curves for solutions of uranous chloride in various solvents were drawn, and the bands were shown to undergo interesting modifications, depending on the solvent used. Of course the cases of

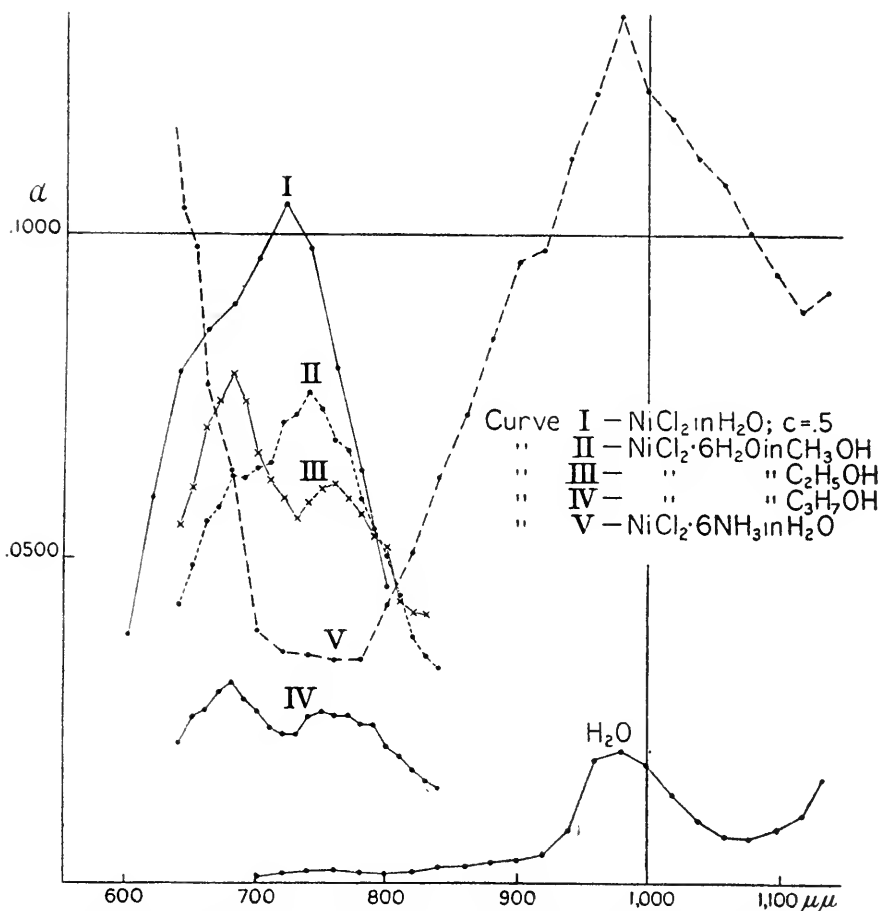

FIG. 18.—Comparison of the Absorption Curves of Nickel Salts in Water and the Alcohols.

the uranous chloride and the nickel chloride hydrate solutions are not exactly comparable, for the uranous chloride actually does dissolve in the solvents, and in the light of other work we are not surprised at the difference in the character of the bands, but the nickel chloride goes into solution in the alcohols only in the presence of water. Under such

<sup>1</sup>Proc. Roy. Soc. A, 87, 138 (1912).

conditions we would perhaps not expect to find such changes as have been observed above in the case of the nickel band. Possibly similar examples of this same phenomenon may be found.

A solution of  $\text{NiCl}_2 \cdot 6\text{NH}_3$  in water of unknown concentration was measured, and its absorption curve also appears in figure 18.

NICKEL NITRATE IN WATER.

Twenty-four solutions were prepared, varying in concentration from  $c=4.2$  to  $c=0.05$ . As was the case in the aqueous nickel-chloride solutions, the  $A-c$  curves show that the values of  $A$  experience changes, with  $c$  depending upon the wave-length. The changes in the case of the nitrate, however, although similar in their general character, are nowhere so marked as in the case of the chloride. Throughout the region from  $565\mu\mu$  to  $724\mu\mu$ , which includes the short wave-length side

TABLE 21.—*Nickel Nitrate in Water (Figs. 19 and 20).*

Wave-length.	Temp. = 20.8° $t=2.73$ mm. Conc. = 4.13		Temp. = 19.5° $t=2.73$ mm. Conc. = 3.8		Temp. = 19.8° $t=2.73$ mm. Conc. = 3.5		Temp. = 19.8° $t=2.73$ mm. Conc. = 3.2		Temp. = 20.2° $t=2.73$ mm. Conc. = 2.9		Temp. = 20.5° $t=2.73$ mm. Conc. = 2.6	
	$\alpha$	$A$	$\alpha$	$A$	$\alpha$	$A$	$\alpha$	$A$	$\alpha$	$A$	$\alpha$	$A$
565 $\mu\mu$	0.110	0.0267	0.103	0.0271	0.0960	0.0274	0.0820	0.0256	0.0758	0.0262	0.0678	0.0260
605	.....	.....	.....	.....	.....	.....	.....	.....	.....	.....	.215	.0827
803	.....	.....	.....	.....	.349	.101	.306	.0950	.277	.0948	.248	.0949
842	.210	.0501	.192	.0497	.182	.0511	.162	.0496	.142	.0513	.128	.0480
881	.138	.0328	.132	.0340	.116	.0382	.102	.0311	.0906	.0309	.0865	.0320
920	.168	.0395	.147	.0373	.141	.0388	.132	.0396	.110	.0361	.0970	.0355
959	.279	.0631	.243	.0590	.229	.0600	.204	.0578	.175	.0538	.164	.0558
978	.....	.....	.....	.....	.275	.0726	.257	.0737	.226	.0706	.207	.0716
Wave-length.	Temp. = 24.8° $t=6.36$ mm. Conc. = 2.3		Temp. = 23.9° $t=6.36$ mm. Conc. = 2.0		Temp. = 24.5° $t=6.36$ mm. Conc. = 1.7		Temp. = 24.7° $t=6.36$ mm. Conc. = 1.4		Temp. = 22.0° $t=6.36$ mm. Conc. = 1.1		Temp. = 22.1° $t=6.36$ mm. Conc. = 1.0	
	$\alpha$	$A$	$\alpha$	$A$	$\alpha$	$A$	$\alpha$	$A$	$\alpha$	$A$	$\alpha$	$A$
565 $\mu\mu$	0.0596	0.0259	0.0508	0.0254	0.0379	0.0233	0.0338	0.0278	0.0303	0.0275	0.0262	0.0262
605	.....	.....	.....	.....	.124	.0728	.0917	.0654	.0887	.0806	.0749	.0749
764	.....	.....	.....	.....	.....	.....	.....	.....	.....	.....	.158	.158
803	.209	.0900	.176	.0870	.145	.0868	.127	.0893	.0981	.0878	.0900	.0883
842	.110	.0478	.0926	.0450	.0795	.0452	.0667	.0459	.0516	.0446	.0501	.0475
881	.0706	.0337	.0601	.0285	.0544	.0302	.0436	.0288	.0346	.0283	.0316	.0284
920	.0819	.0336	.0710	.0332	.0593	.0315	.0519	.0332	.0406	.0328	.0362	.0316
959	.139	.0521	.118	.0494	.105	.0505	.0905	.0510	.0738	.0488	.0703	.0511
978	.165	.0627	.152	.0655	.127	.0624	.109	.0632	.0931	.0659	.0870	.0664
1018	.....	.....	.....	.....	.....	.....	.152	.0986	.119	.105	.111	.0971
1056	.....	.....	.....	.....	.....	.....	.....	.....	.144	.133	.139	.131

TABLE 21.—Nickel Nitrate in Water (Figs. 19 and 20)—Continued.

Wave-length.	Temp. = 22.5° <i>t</i> = 6.36 mm. Conc. = 0.9		Temp. = 22.5° <i>t</i> = 6.36 mm. Conc. = 0.8		Temp. = 18.3° <i>t</i> = 6.36 mm. Conc. = 0.7		Temp. = 18.5° <i>t</i> = 6.36 mm. Conc. = 0.6		Temp. = 19.8° <i>t</i> = 6.36 mm. Conc. = 0.5		Temp. = 20.0° <i>t</i> = 6.36 mm. Conc. = 0.4	
	<i>a</i>	<i>A</i>	<i>a</i>	<i>A</i>	<i>a</i>	<i>A</i>	<i>a</i>	<i>A</i>	<i>a</i>	<i>A</i>	<i>a</i>	<i>A</i>
565 $\mu\mu$	0.0286	0.0318	0.0204	0.0255	0.0153	0.0218	0.0174	0.0257	0.0102	0.0204	0.0107	0.0267
605	.0697	.0775	.0596	.0745	.0518	.0740	.0484	.0866	.0371	.0742	.0338	.0845
645	.....	.....	.....	.....	.....	.....	.106	.177	.0889	.178	.0689	.172
684	.....	.....	.....	.....	.....	.....	.....	.....	.0978	.196	.0786	.195
724	.....	.....	.....	.....	.....	.....	.....	.....	.107	.210	.0868	.213
764	.142	.148	.121	.151	.108	.152	.0950	.155	.0817	.159	.0651	.158
803	.0810	.0881	.0703	.0857	.0595	.0826	.0502	.0808	.0456	.0878	.0382	.0913
842	.0437	.0457	.0386	.0450	.0325	.0427	.0281	.0425	.0239	.0426	.0211	.0463
881	.0281	.0277	.0258	.0283	.0220	.0267	.0190	.0263	.0184	.0304	.0157	.0313
920	.0338	.0325	.0272	.0283	.0258	.0202	.0228	.0310	.0204	.0316	.0184	.0345
959	.0641	.0501	.0589	.0473	.0512	.0457	.0489	.0497	.0446	.0510	.0397	.0515
978	.0791	.0628	.0717	.0637	.0657	.0644	.0608	.0670	.0534	.0656	.0458	.0630
1018	.102	.0979	.0956	.102	.0856	.102	.0743	.101	.0616	.0954	.0550	.103
1056	.125	.130	.115	.134	.101	.134	.0906	.139	.0788	.143	.0636	.140
1095	.152	.161	.132	.156	.117	.156	.111	.171	.0978	.179	.0759	.169

Wave-length.	Temp. = 20.5° <i>t</i> = 10.5 mm. Conc. = 0.3		Temp. = 20.2° <i>t</i> = 10.5 mm. Conc. = 0.25		Temp. = 20.0° <i>t</i> = 10.5 mm. Conc. = 0.2		Temp. = 20.8° <i>t</i> = 10.5 mm. Conc. = 0.15		Temp. = 21.5° <i>t</i> = 20.2 mm. Conc. = 0.10		Temp. = 21.4° <i>t</i> = 20.2 mm. Conc. = 0.05	
	<i>a</i>	<i>A</i>	<i>a</i>	<i>A</i>	<i>a</i>	<i>A</i>	<i>a</i>	<i>A</i>	<i>a</i>	<i>A</i>	<i>a</i>	<i>A</i>
565 $\mu\mu$	0.0071	0.0237	0.0072	0.0284	0.0065	0.0325	0.0047	0.0319	0.0025	0.0250	0.0015	0.0300
605	.0237	.0790	.0205	.0820	.0150	.0750	.0124	.0326	.0075	.0750	.0053	.106
645	.0524	.175	.0429	.171	.0352	.176	.0265	.176	.0173	.173	.0101	.202
684	.0585	.195	.0478	.191	.0386	.193	.0275	.184	.0186	.186	.0114	.228
724	.0672	.219	.0556	.216	.0432	.209	.0335	.213	.0217	.202	.0134	.240
764	.0496	.159	.0412	.157	.0336	.158	.0262	.160	.0167	.147	.0104	.168
803	.0294	.0923	.0241	.100	.0195	.0890	.0154	.109	.0100	.0830	.0058	.0820
842	.0158	.0440	.0139	.0452	.0121	.0475	.0089	.0420	.0064	.0380	.0046	.0400
881	.0128	.0320	.0095	.0242	.0089	.0285	.0069	.0253	.0052	.0200	.0041	.0040
920	.0148	.0340	.0124	.0328	.0109	.0315	.0089	.0277	.0071	.0250	.0056	.0200
959	.0354	.0543	.0308	.0468	.0287	.0480	.0266	.0500	.0231	.0400	.0212	.0420
978	.0412	.0673	.0369	.0668	.0328	.0610	.0302	.0640	.0270	.0640	.0238	.0640
1018	.0448	.103	.0379	.0960	.0333	.0970	.0298	.106	.0229	.0900	.0187	.0960
1056	.0502	.142	.0424	.140	.0349	.137	.0285	.13	.0203	.128	.0148	.146
1095	.0586	.167	.0501	.167	.0423	.160	.0347	.176	.0246	.162	.0175	.182

of the red absorption band, the *A* - *c* curves show that *A* is a constant. From 803 $\mu\mu$  to 978 $\mu\mu$ , a region including the long wave-length side of the red band and the region of low absorption beyond this, the *A* - *c* curves show that *A* decreases with dilution. Beyond 1,018 $\mu\mu$ , on the edge of the infra-red, again *A* is a constant for all values of *c*.

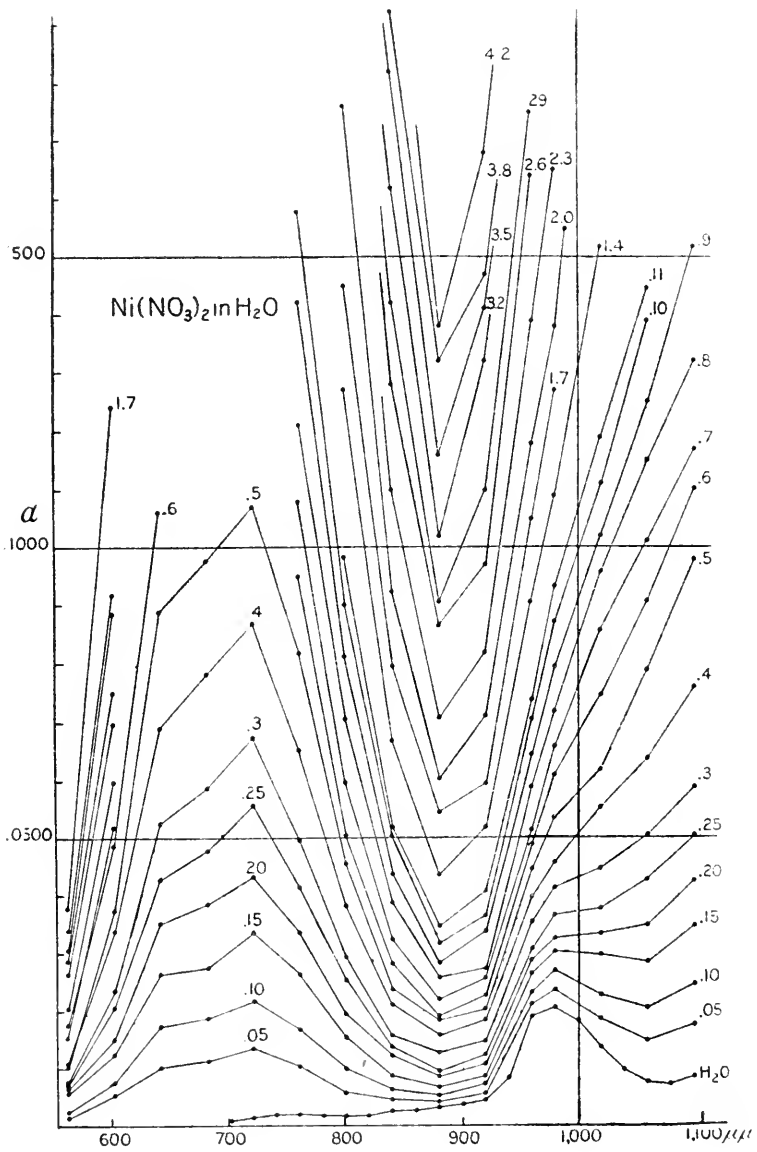

FIG. 19.—The Absorption Curves for Nickel Nitrate in Water.

Table 22 shows the comparison between Houston's measurements and those of table 21.

TABLE 22.—*A* for Nickel Nitrate in Water (Figs. 19 and 20).

Wave-length.	<i>c</i> = 0.52	
	Houstoun.	From table 18.
684	0.182	0.196
720	.173	.200
750	.126	.173
794	.065	.0882
850	.032	.0416
910	.024	.0310
980	.058	.0656
1070	.128	.152

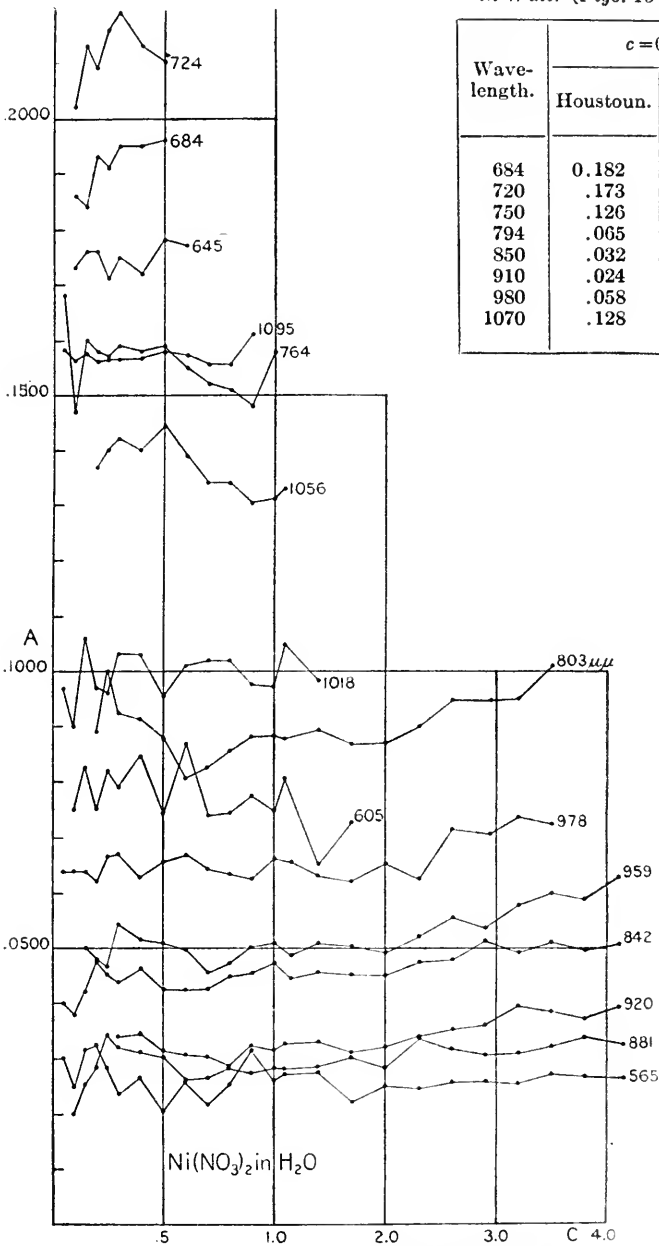

FIG. 20.—The *A*-*c* Curves for Nickel Nitrate in Water.

TABLE 23.—Nickel Sulphate in Water (Figs. 21 and 22).

Wave-length.	Temp. = 20.9° =10 mm. Conc. = 2.33		Temp. = 18.5° t = 10 mm. Conc. = 2.0		Temp. = 18.6° t = 10 mm. Conc. = 1.8		Temp. = 18.6° t = 10 mm. Conc. = 1.6		Temp. = 18.3° t = 10 mm. Conc. = 1.4		Temp. = 19.3° t = 10 mm. Conc. = 1.2	
	a	A	a	A	a	A	a	A	a	A	a	A
555 $\mu$	.....	.....	0.0391	0.0195	0.0335	0.0186	0.0290	0.0181	0.0253	0.0180	0.0236	0.0197
565	.....	.....	.0498	.0249	.0477	.0265	.0403	.0252	.0332	.0237	.0297	.0247
585	.....	.....	.0820	.0410	.0732	.0406	.0690	.0431	.0611	.0437	.0505	.0421
605	.....	.....	.....	.....	.....	.....	.1146	.0716	.1114	.0790	.0868	.0722
803	.....	.....	.....	.....	.....	.....	.1462	.0906	.1207	.0850	.1114	.0914
823	0.1532	0.0650	.1230	.0656	.1201	.0658	.1013	.0621	.0880	.0615	.0769	.0626
842	.1152	.0483	.0959	.0466	.0856	.0461	.0766	.0462	.0662	.0454	.0575	.0456
861	.0840	.0348	.0713	.0342	.0638	.0338	.0571	.0339	.0504	.0340	.0443	.0345
881	.0741	.0304	.0627	.0298	.0578	.0303	.0511	.0298	.0439	.0290	.0393	.0300
901	.0749	.0307	.0634	.0299	.0575	.0298	.0515	.0298	.0450	.0295	.0403	.0305
920	.0859	.0349	.0700	.0347	.0667	.0345	.0601	.0326	.0524	.0341	.0461	.0346
940	.1072	.0391	.0919	.0418	.0825	.0407	.0749	.0392	.0660	.0415	.0583	.0417
959	.....	.....	.1207	.0507	.1130	.0521	.0991	.0500	.0877	.0490	.0804	.0511
978	.....	.....	.....	.....	.....	.....	.1182	.0610	.1072	.0617	.0992	.0653
998	.....	.....	.....	.....	.....	.....	.....	.....	.1225	.0748	.1121	.0782

Wave-length.	Temp. = 18.9° t = 10 mm. Conc. = 1.0		Temp. = 18.2° t = 10 mm. Conc. = 0.9		Temp. = 18.4° t = 10 mm. Conc. = 0.8		Temp. = 16.0° t = 10 mm. Conc. = 0.7		Temp. = 17.4° t = 10 mm. Conc. = 0.6		Temp. = 18.3° t = 10 mm. Conc. = 0.5	
	a	A	a	A	a	A	a	A	a	A	a	A
555 $\mu$	0.0190	0.0190	0.0170	0.0190	0.0155	0.0194	0.0143	0.0204	0.0111	0.0185	0.0127	0.0254
565	.0250	.0250	.0292	.0325	.0188	.0235	.0182	.0260	.0149	.0248	.0149	.0298
585	.0459	.0459	.0348	.0397	.0354	.0443	.0283	.0404	.0260	.0433	.0246	.0492
605	.0786	.0786	.0732	.0813	.0606	.0758	.0545	.0794	.0438	.0730	.0386	.0772
625	.....	.....	.....	.....	.....	.....	.0871	.124	.0681	.113	.0623	.124
645	.....	.....	.....	.....	.....	.....	.....	.....	.....	.....	.0829	.166
664	.....	.....	.....	.....	.....	.....	.....	.....	.....	.....	.0941	.188
684	.....	.....	.....	.....	.....	.....	.....	.....	.....	.....	.0912	.182
704	.....	.....	.....	.....	.....	.....	.....	.....	.....	.....	.1045	.207
724	.....	.....	.....	.....	.....	.....	.....	.....	.....	.....	.1033	.203
744	.....	.....	.....	.....	.....	.....	.....	.....	.....	.....	.0993	.195
764	.....	.....	.....	.....	.....	.....	.1072	.150	.0933	.152	.0802	.156
783	.1286	.1268	.1111	.122	.0984	.121	.0860	.120	.0744	.121	.0641	.125
803	.0921	.0904	.0816	.0898	.0731	.0896	.0623	.0866	.0544	.0878	.0474	.0914
823	.0653	.0635	.0596	.0642	.0547	.0661	.0455	.0624	.0393	.0625	.0362	.0688
842	.0481	.0455	.0444	.0462	.0398	.0465	.0354	.0454	.0312	.0477	.0281	.0510
861	.0378	.0350	.0346	.0353	.0314	.0358	.0277	.0354	.0265	.0395	.0228	.0400
881	.0324	.0292	.0303	.0301	.0274	.0303	.0260	.0326	.0218	.0310	.0201	.0338
901	.0335	.0299	.0308	.0302	.0279	.0304	.0250	.0306	.0220	.0307	.0204	.0336
920	.0389	.0343	.0362	.0351	.0324	.0349	.0297	.0358	.0260	.0357	.0238	.0384
940	.0498	.0416	.0467	.0428	.0428	.0433	.0384	.0431	.0326	.0407	.0314	.0464
959	.0712	.0521	.0680	.0543	.0617	.0533	.0567	.0537	.0501	.0517	.0474	.0566
978	.0859	.0653	.0810	.0670	.0728	.0653	.0683	.0681	.0597	.0652	.0560	.0708
998	.0980	.0799	.0942	.0851	.0814	.0791	.0783	.0860	.0673	.0820	.0620	.0878
1018	.....	.....	.1019	.101	.0935	.100	.0853	.102	.0744	.101	.0668	.106
1037	.....	.....	.....	.....	.....	.....	.....	.....	.0807	.118	.0725	.125
1056	.....	.....	.....	.....	.....	.....	.....	.....	.0903	.138	.0806	.146
1075	.....	.....	.....	.....	.....	.....	.....	.....	.0980	.151	.0855	.157
1095	.....	.....	.....	.....	.....	.....	.....	.....	.....	.....	.0919	.167
1114	.....	.....	.....	.....	.....	.....	.....	.....	.....	.....	.0971	.173



TABLE 23.—Nickel Sulphate in Water (Figs. 21 and 22)—Continued.

Wave-length.	Temp. = 18.2° <i>t</i> = 10 mm. Conc. = 0.4		Temp. = 18.9° <i>t</i> = 10 mm. Conc. = 0.3		Temp. = 18.9° <i>t</i> = 10 mm. Conc. = 0.2		Temp. = 19.5° <i>t</i> = 10 mm. Conc. = 0.1		Temp. = 20.4° <i>t</i> = 10 mm. Conc. = 0.05		Temp. = 20.6° <i>t</i> = 10 mm. Conc. = 0.025	
	<i>a</i>	<i>A</i>	<i>a</i>	<i>A</i>	<i>a</i>	<i>A</i>	<i>a</i>	<i>A</i>	<i>a</i>	<i>A</i>	<i>a</i>	<i>A</i>
555 $\mu$	0.0097	0.0242	0.0065	0.0217	0.0061	0.0305	0.0029	0.0290	0.0029	0.0580	0.0017	0.0680
565	.0114	.0285	.0104	.0347	.0079	.0395	.0037	.0370	.0029	.0580	.0021	.0840
585	.0204	.0510	.0149	.0497	.0114	.0570	.0049	.0490	.0033	.0660	.0025	.100
605	.0320	.0800	.0250	.0833	.0170	.0850	.0083	.0830	.0045	.0900	.0025	.100
625	.0502	.126	.0389	.130	.0272	.136	.0134	.134	.0076	.152	.0049	.196
645	.0707	.177	.0529	.173	.0366	.184	.0179	.179	.0093	.186	.0061	.244
664	.0756	.189	.0569	.190	.0395	.198	.0196	.196	.0114	.228	.0068	.272
684	.0779	.195	.0586	.195	.0396	.198	.0204	.204	.0117	.234	.0068	.272
704	.0838	.207	.0638	.209	.0422	.206	.0225	.215	.0130	.240	.0072	.248
724	.0859	.211	.0672	.219	.0450	.217	.0238	.223	.0137	.244	.0079	.256
744	.0806	.197	.0617	.199	.0425	.202	.0225	.205	.0140	.240	.0079	.236
764	.0648	.157	.0500	.160	.0346	.163	.0190	.170	.0137	.234	.0068	.192
783	.0505	.122	.0386	.123	.0272	.127	.0158	.140	.0107	.178	.0065	.188
803	.0371	.0885	.0301	.0947	.0210	.0965	.0124	.107	.0079	.124	.0049	.128
823	.0277	.0648	.0230	.0707	.0155	.0685	.0093	.0750	.0068	.100	.0049	.124
842	.0218	.0480	.0185	.0530	.0134	.0540	.0083	.0570	.0065	.0780	.0049	.0820
861	.0170	.0355	.0158	.0433	.0117	.0445	.0079	.0510	.0063	.0700	.0049	.0840
881	.0158	.0315	.0140	.0360	.0107	.0375	.0076	.0440	.0060	.0560	.0049	.0680
901	.0164	.0320	.0143	.0357	.0107	.0355	.0079	.0430	.0065	.0580	.0061	.100
920	.0190	.0360	.0167	.0403	.0130	.0420	.0097	.0510	.0079	.0660	.0068	.0880
940	.0258	.0440	.0230	.0493	.0176	.0470	.0140	.0580	.0121	.0780	.0107	.100
959	.0407	.0540	.0355	.0547	.0308	.0585	.0253	.0620	.0223	.0640	.0215	.0960
978	.0476	.0675	.0422	.0720	.0344	.0690	.0288	.0820	.0255	.0980	.0238	.128
998	.0524	.0858	.0450	.0897	.0356	.0875	.0279	.098	.0248	.134	.0220	.156
1018	.0560	.105	.0464	.108	.0356	.109	.0250	.111	.0207	.136	.0176	.148
1037	.0600	.125	.0482	.127	.0360	.130	.0230	.131	.0173	.148	.0143	.172
1056	.0656	.145	.0522	.149	.0387	.156	.0228	.153	.0161	.172	.0124	.196
1075	.0719	.161	.0566	.165	.0408	.169	.0248	.177	.0164	.186	.0121	.200
1095	.0804	.180	.0630	.182	.0433	.175	.0267	.183	.0185	.202	.0143	.212
1114	.0853	.187	.0679	.191	.0497	.196	.0309	.203	.0210	.208	.0167	.244

NICKEL SULPHATE IN WATER.

Eighteen solutions were prepared, varying in concentration from  $c=2.3$  to  $c=0.025$ . The  $A-c$  curves show that  $A$  is a constant for values of  $c$  greater than 0.6, and for values of  $c$  less than 0.6 that  $A$  increases with dilution. This increase in  $A$  for the more dilute solutions is common to all the wave-lengths studied.

The five upper strips of plate 28 B of the paper by Jones and Anderson<sup>1</sup> indicate, though none too plainly, that for wave-lengths lying on the short wave-length side of the red, nickel band  $A$  increases with dilution for concentrations below  $c=0.5$ .

<sup>1</sup>Carnegie Inst. Wash. Pub. No. 110.

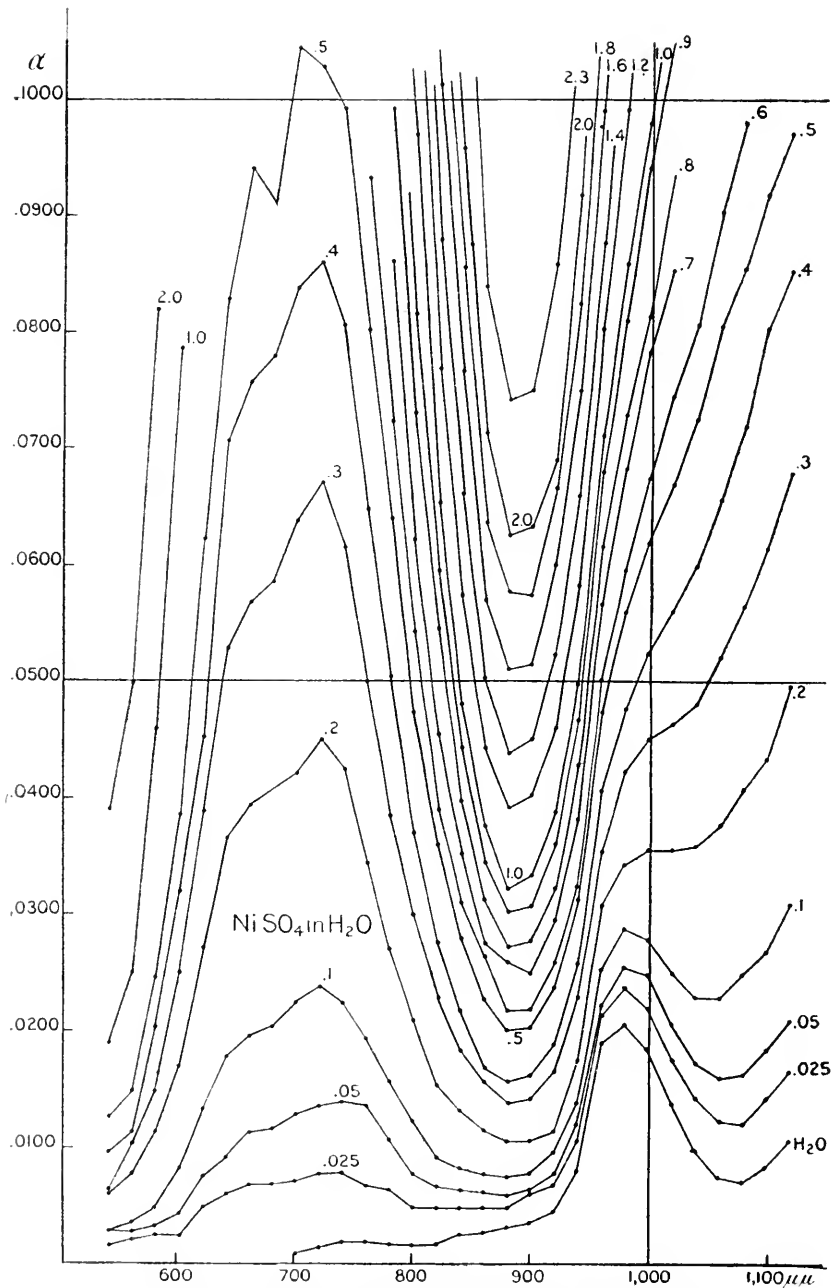

FIG. 21.—The Absorption Curves for Nickel Sulphate in Water.

Table 24 shows the comparison between Houston's measurements and those of table 23.

TABLE 24.—*A* for Nickel Sulphate in Water (Figs. 21 and 22).

Wave-length.	<i>c</i> = 0.35	
	Houston.	From tabl. 23.
684	0.196	0.195
720	.197	.217
750	.1 1	.190
794	.070	.100
850	.0 4	.0403
910	.028	.0372
980	.061	.0637
1070	.142	.163

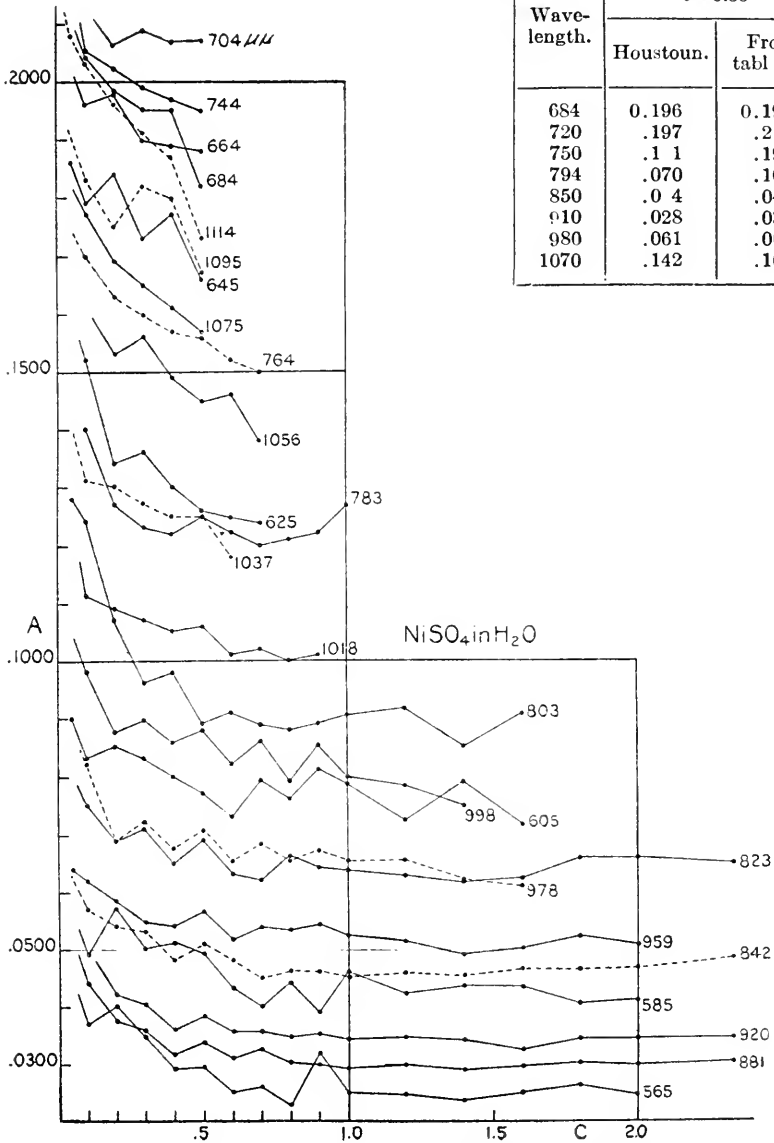

FIG. 22.—The *A-c* Curves for Nickel Sulphate in Water.

## FERRIC AMMONIUM SULPHATE IN WATER.

Twelve solutions were prepared, varying in concentration from  $c = 1.0$  to  $c = 0.10$ . The absorption curves show that the aqueous solutions of ferric ammonium sulphate possess a broad, rather feeble absorption band just beyond the visible red, whose maximum is at  $842\mu\mu$ , and become transparent beyond this. The transmission curve of an aqueous solution of this salt has been roughly drawn in this region of the spectrum by Coblentz<sup>1</sup> and by Nichols.<sup>2</sup> The  $A - c$  curves for  $605\mu\mu$

TABLE 25.—Ferric Ammonium Sulphate in Water (Fig. 23).

Wave-length.	Temp. = 20.0° $t = 10.5$ mm. Conc. = 1.0		Temp. = 20.8° $t = 10.5$ mm. Conc. = 0.9		Temp. = 21.1° $t = 10.5$ mm. Conc. = 0.8		Temp. = 21.6° $t = 10.5$ mm. Conc. = 0.7		Temp. = 22.0° $t = 10.5$ mm. Conc. = 0.6		Temp. = 22.0° $t = 10.5$ mm. Conc. = 0.5		Temp. = 18.9° $t = 20.2$ mm. Conc. = 0.4	
	$a$	$A$	$a$	$A$	$a$	$A$	$a$	$A$	$a$	$A$	$a$	$A$	$a$	$A$
605 $\mu\mu$	0.0238	0.0238	0.0222	0.0252	0.0219	0.0274	0.0202	0.0286	0.0153	0.0255	0.0136	0.0272	0.0113	0.0283
645	.0139	.0139	.0133	.0148	.0128	.0160	.0112	.0160	.0086	.0143	.0075	.0150	.0058	.0145
684	.0133	.0133	.0124	.0138	.0124	.0155	.0099	.0141	.0082	.0137	.0069	.0138	.0055	.0138
724	.0200	.0185	.0192	.0189	.0176	.0201	.0148	.0190	.0121	.0177	.0106	.0182	.0086	.0178
764	.0310	.0290	.0288	.0298	.0264	.0305	.0230	.0300	.0194	.0290	.0159	.0278	.0129	.0273
803	.0366	.0349	.0349	.0369	.0321	.0380	.0281	.0377	.0234	.0362	.0194	.0354	.0155	.0345
842	.0394	.0368	.0363	.0374	.0339	.0391	.0297	.0387	.0252	.0377	.0214	.0376	.0174	.0370
881	.0359	.0327	.0324	.0324	.0305	.0341	.0269	.0338	.0230	.0330	.0194	.0324	.0157	.0313
920	.0291	.0245	.0264	.0242	.0252	.0257	.0231	.0264	.0197	.0252	.0168	.0244	.0139	.0233
959	.0329	.0138	.0312	.0134	.0312	.0151	.0301	.0157	.0276	.0142	.0261	.0142	.0242	.0128
978	.0323	.0122	.0305	.0110	.0303	.0121	.0301	.0136	.0283	.0130	.0268	.0124	.0253	.0118
1018	.0207	.0068	.0197	.0064	.0205	.0084	.0197	.0083	.0184	.0075	.0173	.0068	.0163	.0060
1056	.0121	.0046	.0109	.0038	.0124	.0061	.0118	.0061	.0106	.0052	.0099	.0048	.0093	.0048
1095	.0111	.0027	.0102	.0020	.0115	.0039	.0111	.0039	.0102	.0030	.0099	.0030	.0090	.0015

Wave-length.	Temp. = 19.6° $t = 20.2$ mm. Conc. = 0.35		Temp. = 20.2° $t = 20.2$ mm. Conc. = 0.30		Temp. = 20.6° $t = 20.2$ mm. Conc. = 0.25		Temp. = 21.3° $t = 20.2$ mm. Conc. = 0.20		Temp. = 21.5° $t = 20.2$ mm. Conc. = 0.15		Temp. = 21.8° $t = 20.2$ mm. Conc. = 0.10	
	$a$	$A$	$a$	$A$	$a$	$A$	$a$	$A$	$a$	$A$	$a$	$A$
605 $\mu\mu$	0.0104	0.0297	0.0089	0.0297	0.0078	0.0312	0.0075	0.0375	0.0060	0.0400	0.0051	0.0510
645	.0053	.0152	.0048	.0160	.0041	.0164	.0036	.0180	.0028	.0186	.0026	.0260
684	.0050	.0143	.0045	.0150	.0039	.0156	.0034	.0170	.0026	.0173	.0022	.0220
724	.0075	.0172	.0069	.0180	.0058	.0172	.0049	.0170	.0039	.0160	.0032	.0170
764	.0115	.0271	.0101	.0287	.0089	.0296	.0078	.0290	.0060	.0267	.0046	.0260
803	.0142	.0357	.0123	.0353	.0105	.0352	.0090	.0365	.0069	.0347	.0053	.0360
842	.0152	.0360	.0138	.0372	.0118	.0372	.0101	.0395	.0082	.0374	.0058	.0320
881	.0144	.0320	.0125	.0310	.0114	.0328	.0100	.0340	.0082	.0333	.0064	.0320
920	.0124	.0251	.0117	.0237	.0107	.0244	.0097	.0255	.0083	.0247	.0068	.0220
959	.0235	.0126	.0225	.0113	.0222	.0124	.0219	.0140	.0210	.0120	.0204	.0130
978	.0247	.0117	.0237	.0104	.0235	.0116	.0231	.0125	.0224	.0120	.0221	.0150
1018	.0164	.0071	.0158	.0063	.0156	.0068	.0150	.0055	.0146	.0047	.0147	.0080
1056	.0093	.0051	.0087	.0040	.0087	.0048	.0083	.0040	.0080	.0033	.0080	.0050
1095	.0093	.0026	.0089	.0017	.0092	.0032	.0089	.0025	.....	.....	.0084	.....

<sup>1</sup>Bull. Bureau of Standards, 7, 619 (1911).<sup>2</sup>Phys. Rev., I, 1 (1896).

and  $645\mu\mu$ , on the edge of the band in the yellow show that  $A$  increases with dilution. Throughout the remaining region from  $724\mu\mu$  to  $1,095\mu\mu$ , which includes the weak infra-red band,  $A$  is a constant for all values of  $c$ .

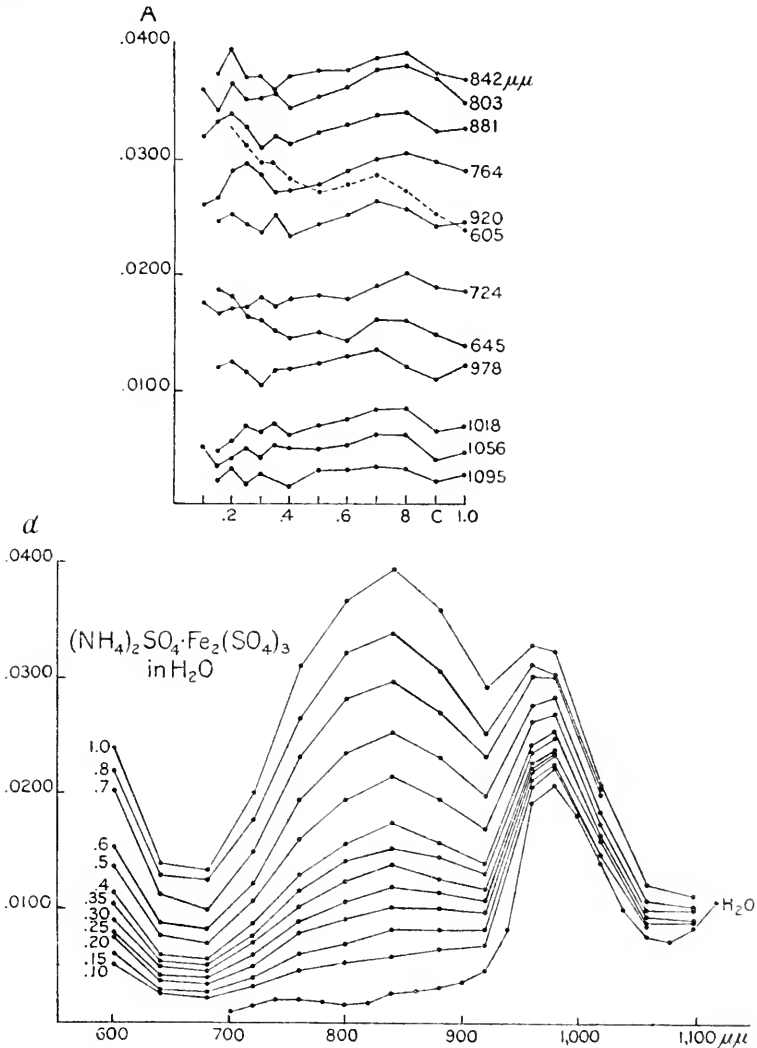

FIG. 23.—The  $A$ - $c$  and Absorption Curves for Ferric Ammonium Sulphate in Water.

An attempt was made to carry out measurements on solutions of ferric chloride. The attempt failed because the precipitate of ferric hydroxide appeared in such quantities after the solutions had remained in the cells for fifteen minutes that any measurements of  $a$  were meaningless.

## CHROMIUM CHLORIDE IN WATER.

Twenty-one solutions were prepared, varying in concentration from  $c=2.06$  to  $c=0.028$ . The absorption curves show that the edge of the green chromium absorption band at  $750\mu\mu$  is very abrupt, and that beyond  $800\mu\mu$  a solution, for which  $c=0.557$ , is almost as transparent as water. The  $A-c$  curves have been drawn only 3 wave-lengths on the edge of the band at  $724\mu\mu$ ,  $744\mu\mu$ , and  $764\mu\mu$ . At all other parts of the spectrum the values of  $\alpha$  are either too large or too small to be useful for the calculation of  $A$ . These three  $A-c$  curves show that  $A$  decreases

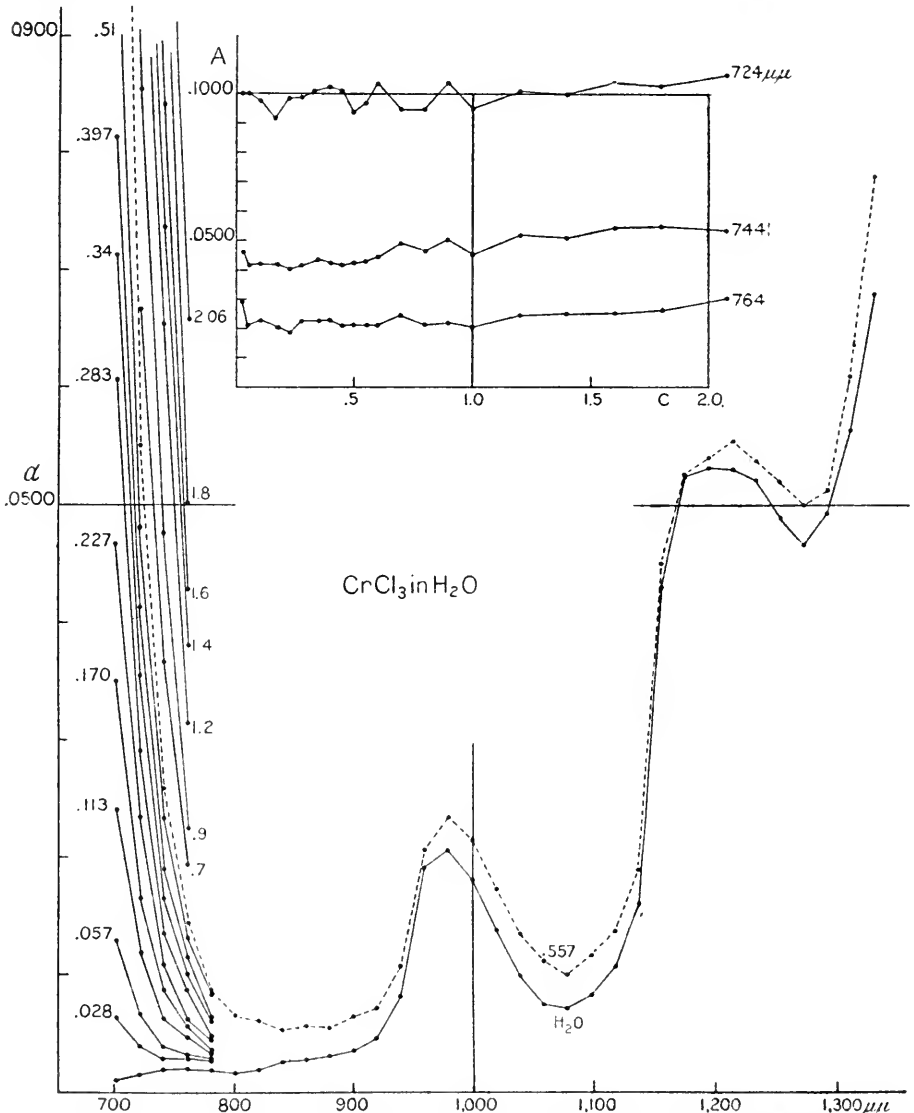

FIG. 24.—The  $A-c$  and Absorption Curves for Chromium Chloride in Water.

slightly with dilution. Plate 56 of the paper by Jones and Anderson shows that for wave-lengths on the edge of the green chromium band *A* is a constant.

TABLE 26.—Chromium Chloride in Water (Fig. 24).

Wave-length.	Temp. = 19.2° <i>t</i> = 2.73 mm. Conc. = 2.06		Temp. = 19.3° <i>t</i> = 2.73 mm. Conc. = 1.8		Temp. = 19.0° <i>t</i> = 2.73 mm. Conc. = 1.6		Temp. = 19.0° <i>t</i> = 2.73 mm. Conc. = 1.4		Temp. = 19.1° <i>t</i> = 2.73 mm. Conc. = 1.2		Temp. = 19.1° <i>t</i> = 2.73 mm. Conc. = 1.0	
	<i>a</i>	<i>A</i>	<i>a</i>	<i>A</i>	<i>a</i>	<i>A</i>	<i>a</i>	<i>A</i>	<i>a</i>	<i>A</i>	<i>a</i>	<i>A</i>
704 $\mu\mu$	0.355	0.171	0.278	0.159	0.287	0.179	0.283	0.201	0.235	0.195	0.191	0.190
724	.228	.107	.187	.103	.169	.104	.141	.100	.124	.101	.0953	.0938
744	.113	.0537	.100	.0543	.0890	.0543	.0736	.0511	.0653	.0526	.0476	.0456
764	.0658	.0308	.0501	.0267	.0428	.0255	.0380	.0257	.0314	.0245	.0223	.0203

Wave-length.	Temp. = 19.2° <i>t</i> = 2.73 mm. Conc. = 0.9		Temp. = 19.3° <i>t</i> = 2.73 mm. Conc. = 0.8		Temp. = 19.5° <i>t</i> = 2.73 mm. Conc. = 0.7		Temp. = 19.5° <i>t</i> = 2.73 mm. Conc. = 0.6		Temp. = 19.3° <i>t</i> = 10 mm. Conc. = 0.557	
	<i>a</i>	<i>A</i>	<i>a</i>	<i>A</i>	<i>a</i>	<i>A</i>	<i>a</i>	<i>A</i>	<i>a</i>	<i>A</i>
684 $\mu\mu$	.....	.....	.....	.....	.....	.....	.....	.....	0.110	0.198
704	0.191	0.211	0.158	0.196	0.139	0.198	0.126	0.208	.0550	.0971
724	.0953	.104	.0759	.0930	.0666	.0930	.0619	.104	.0258	.0438
744	.0476	.0501	.0392	.0465	.0366	.0494	.0287	.0445	.0143	.0222
764	.0223	.0225	.0194	.0217	.0194	.0249	.0150	.0215	.0086	.....

Wave-length.	Temp. = 20.5° <i>t</i> = 10 mm. Conc. = 0.51		Temp. = 21.4° <i>t</i> = 10 mm. Conc. = 0.453		Temp. = 20.5° <i>t</i> = 10 mm. Conc. = 0.397		Temp. = 21.4° <i>t</i> = 10 mm. Conc. = 0.340		Temp. = 20.8° <i>t</i> = 10 mm. Conc. = 0.288	
	<i>a</i>	<i>A</i>	<i>a</i>	<i>A</i>	<i>a</i>	<i>A</i>	<i>a</i>	<i>A</i>	<i>a</i>	<i>A</i>
684 $\mu\mu$	0.100	0.195	0.0919	0.202	0.0813	0.204	0.0721	0.213	0.0606	0.213
704	.0480	.0940	.0467	.101	.0413	.102	.0354	.101	.0290	.0991
724	.0233	.0426	.0204	.0417	.0190	.0427	.0164	.0438	.0134	.0420
744	.0130	.0215	.0117	.0214	.0114	.0236	.0100	.0235	.0086	.0233
764	.0079	.....	.0064	.....	.0064	.....	.0060	.....	.0049	.....

Wave-length.	Temp. = 21.3° <i>t</i> = 20 mm. Conc. = 0.227		Temp. = 17.9° <i>t</i> = 20 mm. Conc. = 0.170		Temp. = 18.3° <i>t</i> = 20 mm. Conc. = 0.113		Temp. = 19.2° <i>t</i> = 20 mm. Conc. = 0.057		Temp. = 19.4° <i>t</i> = 20 mm. Conc. = 0.028	
	<i>a</i>	<i>A</i>	<i>a</i>	<i>A</i>	<i>a</i>	<i>A</i>	<i>a</i>	<i>A</i>	<i>a</i>	<i>A</i>
684 $\mu\mu$	0.0467	0.206	0.0349	0.205	0.0240	0.213	0.0129	0.227	0.0063	0.225
704	.0234	.0987	.0165	.0912	.0119	.0965	.0067	.100	.0038	.100
724	.0107	.0406	.0087	.0424	.0063	.0425	.0039	.0420	.0028	.0464
744	.0062	.0185	.0055	.0206	.0046	.0230	.0032	.0210	.0028	.0285
764	.0043	.....	.0036	.....	.0032	.....	.0028	.....	.0027	.....

## CHROMIUM NITRATE IN WATER.

Seventeen solutions were prepared, varying in concentration from  $c = 2.0$  to  $0.10$ . The general character of the absorption for the nitrate is the same as that of the chromium-chloride solutions, and therefore

TABLE 27.—Chromium Nitrate in Water (Fig. 25).

Wave-length.	Temp. = 19.3° $t = 2.73$ mm. Conc. = 2.005		Temp. = 19.5° $t = 2.73$ mm. Conc. = 1.8		Temp. = 19.7° $t = 2.73$ mm. Conc. = 1.6		Temp. = 19.7° $t = 2.73$ mm. Conc. = 1.4		Temp. = 19.7° $t = 2.73$ mm. Conc. = 1.2		Temp. = 19.8° $t = 2.73$ mm. Conc. = 1.0	
	$\alpha$	$A$	$\alpha$	$A$	$\alpha$	$A$	$\alpha$	$A$	$\alpha$	$A$	$\alpha$	$A$
684 $\mu\mu$	0.247	0.123	0.218	0.121	0.203	0.127	0.178	0.127	0.151	0.126	0.126	0.126
704	.0943	.0466	.0816	.0447	.0706	.0435	.0621	.0436	.0523	.0427	.0446	.0436
724	.0314	.0149	.0277	.0146	.0237	.0139	.0223	.0149	.0194	.0149	.0165	.0150
744	.0136	.0058	.0120	.0056	.0106	.0054	.0092	.0051	.0092	.0060	.0092	.0072
Wave length.	Temp. = 19.9° $t = 6.36$ mm. Conc. = 0.9		Temp. = 20.1° $t = 6.36$ mm. Conc. = 0.8		Temp. = 20.0° $t = 6.36$ mm. Conc. = 0.7		Temp. = 20.3° $t = 6.36$ mm. Conc. = 0.6		Temp. = 20.3° $t = 6.36$ mm. Conc. = 0.5		Temp. = 20.2° $t = 6.36$ mm. Conc. = 0.4	
	$\alpha$	$A$	$\alpha$	$A$	$\alpha$	$A$	$\alpha$	$A$	$\alpha$	$A$	$\alpha$	$A$
664 $\mu\mu$	.....	.....	.....	.....	.....	.....	0.133	0.222	0.111	0.222	0.0865	0.216
684	0.107	0.119	0.0933	0.117	0.0786	0.112	.0698	.116	.0564	.114	.0476	.1190
704	.0365	.0395	.0320	.0387	.0276	.0380	.0224	.0357	.0195	.0370	.0169	.0398
724	.0131	.0129	.0113	.0123	.0063	.0069	.0077	.0103	.0065	.0100	.0067	.0130
744	.0058	.0042	.0044	.....	.....	.....	.....	.....	.....	.....	.....	.....
Wave-length.	Temp. = 20.2° $t = 10.5$ mm. Conc. = 0.3		Temp. = 20.1° $t = 10.5$ mm. Conc. = 0.25		Temp. = 20.1° $t = 10.5$ mm. Conc. = 0.20		Temp. = 20.3° $t = 20.2$ mm. Conc. = 0.15		Temp. = ---° $t = ---$ mm. Conc. = 0.10			
	$\alpha$	$A$	$\alpha$	$A$	$\alpha$	$A$	$\alpha$	$A$	$\alpha$	$A$		
664 $\mu\mu$	0.0663	0.221	0.0552	0.221	0.0448	0.224	0.0334	0.223	0.0222	0.222		
684	.0349	.116	.0297	.119	.0238	.119	.0178	.119	.0122	.122		
704	.0130	.0400	.0109	.0396	.0089	.0395	.0069	.0393	.0048	.0380		
724	.0044	.0097	.0047	.0128	.0039	.0120	.0032	.0113	.0024	.0090		

the absorption curves have not been plotted. The  $A-c$  curves for 684 $\mu\mu$ , 704 $\mu\mu$ , and 724 $\mu\mu$  show that  $A$  decreases slightly with dilution. This same decrease in  $A$  with dilution for wave-lengths on the red edge of the green chromium absorption band is shown by Plate 58-A of the paper by Jones and Anderson.



CHROMIUM SULPHATE IN WATER.

Twelve solutions were prepared, varying in concentration from  $c=0.7$  to  $c=0.025$ . The general character of the absorption for the sulphate is the same as that of the chromium-chloride solutions, and therefore the absorption curves have not been plotted. The  $A-c$  curves for  $704\mu\mu$ ,  $724\mu\mu$ , and  $744\mu\mu$ , on the red edge of the green absorption band show that in this region of the spectrum  $A$  is a constant for all values of  $c$ .

TABLE 28.—Chromium Sulphate in Water (Fig. 25).

Wave-length.	Temp. = 17.2° $t=2.73$ mm. Conc. = 0.663		Temp. = 17.4° $t=2.73$ mm. Conc. = 0.6		Temp. = 17.5° $t=2.73$ mm. Conc. = 0.5		Temp. = 17.7° $t=2.73$ mm. Conc. = 0.4		Temp. = 17.8° $t=2.73$ mm. Conc. = 0.35		Temp. = 18.2° $t=2.73$ mm. Conc. = 0.30	
	$\alpha$	$A$	$\alpha$	$A$	$\alpha$	$A$	$\alpha$	$A$	$\alpha$	$A$	$\alpha$	$A$
704 $\mu\mu$	0.273	0.410	0.264	0.438	0.229	0.456	0.172	0.432	0.164	0.465	0.137	0.453
724	.123	.183	.121	.199	.0978	.193	.0825	.203	.0696	.195	.0623	.203
744	.0613	.0891	.0568	.0913	.0465	.0890	.0366	.0865	.0302	.0806	.0289	.0913

Wave-length.	Temp. = 19.2° $t=6.36$ mm. Conc. = 0.25		Temp. = 21.2° $t=6.36$ mm. Conc. = 0.20		Temp. = 18.7° $t=6.36$ mm. Conc. = 0.15		Temp. = 18.8° $t=10.5$ mm. Conc. = 0.10		Temp. = 18.7° $t=10.5$ mm. Conc. = 0.05		Temp. = 18.6° $t=20.2$ mm. Conc. = 0.025	
	$\alpha$	$A$	$\alpha$	$A$	$\alpha$	$A$	$\alpha$	$A$	$\alpha$	$A$	$\alpha$	$A$
684 $\mu\mu$	.....	.....	.....	.....	0.122	0.812	0.0827	0.827	0.0433	0.866	0.0213	0.852
704	0.110	0.436	0.0810	0.400	.0642	.421	.0426	.416	.0225	.430	.0109	.396
724	.0471	.182	.0390	.188	.0291	.184	.0191	.176	.0109	.198	.0055	.160
744	.0220	.0800	.0216	.0980	.0135	.0766	.0099	.0790	.0058	.0760	.0034	.0560

POTASSIUM PERMANGANATE IN WATER

Eleven solutions were prepared, varying in concentration from  $c=0.278$  to  $c=0.005$ . The absorption curves show the sharp edge at about  $800\mu\mu$  of the green absorption band, for which  $c=0.25$  shows that this solution is nearly as transparent as pure water.

In making up the mother solution of the potassium permanganate care was taken to prepare the solution free from manganese dioxide. The dilutions were then made, and the solutions in the bottles seemed to keep well as long as they remained in the dark. During the course of a measurement, however, the solution in the cells became rapidly permeated with a black precipitate of manganese dioxide, which appeared to be caused by the action of the light. Curve I, figure 25, is for the fresh solution, for which  $c=0.25$ ; curves II, III, and IV are plotted from measurements made at 30-minute intervals after

the initial filling of the cells. It is seen that the absorption increased rapidly as the chemical change progressed. Under such conditions the values of  $a$  were perhaps not very accurate. All that could be done

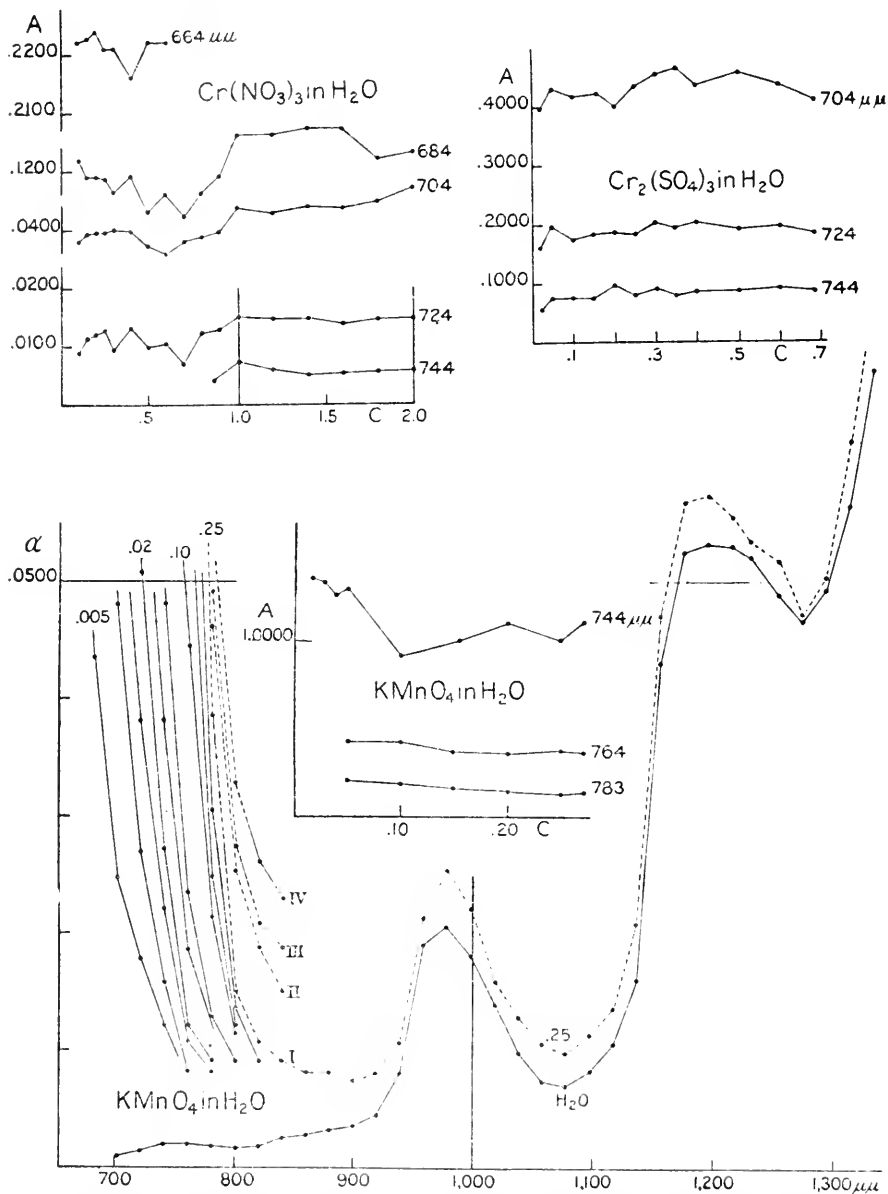

FIG. 25.—The  $A-c$  Curves for Chromium Nitrate, Chromium Sulphate, and Potassium Permanganate in Water; the Absorption Curves for Potassium Permanganate in Water.

was to fill the cells and then make the few necessary measurements as quickly as possible. The  $A-c$  curves for wave-lengths 744 $\mu\mu$ , 764 $\mu\mu$ ,

and 783 $\mu\mu$ , the region on the long wave-length edge of the green absorption band, show that  $A$  is a constant with respect to  $c$  for concentrations greater than  $c=0.05$ . The increase observed in  $A$  for solutions of lower concentration than this is very probably due to the effect of decomposition.

TABLE 29.—Potassium Permanganate in Water (Fig. 25).

Wave-length.	Temp. = 19.5° $t=5$ mm. Conc. = 0.278		Temp. = 21.1° $t=5$ mm. Conc. = 0.250		Temp. = 18.8° $t=5$ mm. Conc. = 0.200		Temp. = 18.8° $t=5$ mm. Conc. = 0.150		Temp. = 18.9° $t=5$ mm. Conc. = 0.100		Temp. = 18.5° $t=5$ mm. Conc. = 0.050	
	$\alpha$	$A$	$\alpha$	$A$	$\alpha$	$A$	$\alpha$	$A$	$\alpha$	$A$	$\alpha$	$A$
724 $\mu\mu$	.....	.....	.....	.....	.....	.....	.....	.....	.....	.....	0.115	2.28
744	.....	.....	.....	.....	0.2228	1.10	0.160	1.05	0.112	1.10	0.481	0.92
764	0.102	0.358	0.0954	0.374	.0753	0.352	.0571	0.368	.0445	0.425	.0235	.43
783	.0397	.136	.0386	.117	.0305	.143	.0248	.167	.0214	.196	.0129	.22
803	.0166	.0535	.0150	.053	.0136	.059	.0121	.....	.0114	.....	.0091	.....
823	.0083	.....	.0106	.....	.0091	.....	.0067	.....	.0098	.....	.0067	.....

Wave-length.	Temp. = 18.2° $t=5$ mm. Conc. = 0.025		Temp. = 18.0° $t=5$ mm. Conc. = 0.020		Temp. = 18.2° $t=5$ mm. Conc. = 0.015		Temp. = 17.5° $t=5$ mm. Conc. = 0.010		Temp. = 17.5° $t=5$ mm. Conc. = 0.005	
	$\alpha$	$A$	$\alpha$	$A$	$\alpha$	$A$	$\alpha$	$A$	$\alpha$	$A$
645 $\mu\mu$	.....	.....	.....	.....	.....	.....	.....	.....	0.0816	.....
664	.....	.....	.....	.....	.....	.....	0.120	.....	.0657	.....
684	.....	.....	0.167	.....	0.122	.....	.0813	.....	.0435	.....
704	0.1204	4.77	.0872	4.31	.0704	4.63	.0481	4.71	.0248	4.76
724	.0639	2.49	.0508	2.46	.0381	2.44	.0270	2.55	.0178	3.26
744	.0381	1.32	.0273	1.26	.0221	1.34	.0158	1.38	.0121	2.00
764	.0187	0.67	.0121	.....	.0106	.....	.0083	.....	.0098	.....
783	.0129	.....	.0091	.....	.0083	.....	.....	.....	.....	.....
803	.0091	.....	.....	.....	.....	.....	.....	.....	.....	.....
823	.0083	.....	.....	.....	.....	.....	.....	.....	.....	.....

### CONCLUSION.

The relation between  $A$ , the molecular light-absorption coefficient of the solution, defined by formula 2, and  $c$ , the concentration of the solution in gram-molecules of salt per liter of solution, has been determined. It has been found that in general  $A$  is not a constant. In certain cases  $A$  decreases with dilution, in other cases  $A$  increases with dilution, and still other cases as dilution proceeds  $A$  decreases to a minimum, and then increases again. Another possible combination, namely, that  $A$  should increase to a maximum and then decrease, was not met with. The deviations from a constant value observed in  $A$  were usually comparatively small, except at certain points in the

spectrum for the cases of certain solutions. These points have been spoken of by Houstoun<sup>1</sup> as "sensitive points." These sensitive points have been found in general to be situated at the edges of absorption bands.

At present there is no adequate theory to explain the facts which have been recorded here. The fact that  $A$  varies with the concentration has been probably correctly attributed by Jones and Anderson and others to the formation of complexes, which were considered to be loose chemical compounds of molecules of the salt with molecules of the solvent. Undoubtedly the changes in  $A$  with  $c$  observed in this investigation may be explained in a qualitative manner by the hypothesis of complexes, or "solvates" as they have been called; but before it can be useful for the interpretation of quantitative data, the solvate hypothesis must be couched in more mathematical terms.

---

<sup>1</sup>Proc. Roy. Soc. Edinburgh, **33**, 151 (1912-13).

## CHAPTER II.

### THE CONDUCTIVITY AND VISCOSITY OF CERTAIN ORGANIC AND INORGANIC SALTS IN FORMAMID AND IN MIXTURES OF FORMAMID WITH ETHYL ALCOHOL.

---

BY P. B. DAVIS AND H. I. JOHNSON.

---

#### INTRODUCTION.

The study of the conductivity and viscosity of salts in formamid as a solvent was begun in the Johns Hopkins Laboratory in 1915 by Davis, Putnam, and Jones.<sup>1</sup> In the report on their investigations a comprehensive survey is made of the work of previous experimenters on formamid as well as a detailed comparison of the physical and chemical properties of this solvent with those of water. Their work comprised at first a study of the methods available for obtaining formamid of sufficiently low specific conductivity. Repeated fractional distillation *in vacuo* was finally adopted as the most suitable process and an efficient vacuum distillation apparatus was devised and constructed. This apparatus and the scheme of fractionation are described in detail in their paper.

Having obtained pure formamid in sufficient quantity for conductivity purposes, a preliminary study was made of the conductivity, dissociation and viscosity of electrolytes in this solvent. They found that in general conductivity values are much lower in formamid than in water, but that complete dissociation is reached at a much lower dilution. The first fact is attributed to the greater viscosity of formamid as compared with water, the second to its higher dielectric constant and greater association factor. From a study of the temperature coefficients some evidence was also obtained for the formation of solvates.

The viscosities of solutions of all the salts studied were greater than that of formamid itself. Even caesium salts, which produce the greatest lowering in the viscosity of water and glycerol, increase the viscosity of formamid, although to a lesser extent than the other salts of the alkalis.

The present investigation, which is a continuation of the earlier work, has comprised a study of the conductivity and viscosity of (1) salts with a common anion—*i. e.*, a series of nitrates of the inorganic salts and of formates of the organic salts; (2) salts with a common cation—*i. e.*, the sodium salts of the organic acids; (3) a study of the behavior of certain representative salts in mixtures of formamid with ethyl alcohol.

---

<sup>1</sup>Carnegie Inst. Wash. Pub. No. 230, 16.

## EXPERIMENTAL.

## PREPARATION OF THE SOLVENTS.

*Formamid.*—The formamid used in this work was prepared in the same manner as that used by Davis and Putnam—*i. e.*, the so-called c. p. material was subjected to repeated fractionation in the vacuum distilling apparatus described by them. By this method it was possible to obtain formamid of a specific conductivity comparable to that of water with a minimum loss of material.

The conductivity values for the solvent used in this work was somewhat lower than that used earlier, ranging from 0.7 to  $1.5 \times 10^{-5}$  as compared with  $2.7 \times 10^{-5}$ . The average density was 1.130 at 25°, the viscosity 0.0332 at the same temperature. A very small fraction, representing only about one-tenth of the original volume, was obtained after about three fractionations more than required for preparing the solvent in large quantities which had a specific conductivity of about  $2 \times 10^{-6}$ , a viscosity of 0.03358, and a density of 1.1331. Merry and Turner<sup>1</sup> mention having obtained a similar fraction by repeated crystallization with a viscosity of 0.03359 and density of 1.1312.

After formamid had been recovered from salts used in making about 15 "sets"<sup>2</sup> of solutions, it was found by continued fractionation that a product could be obtained which showed a specific conductivity of  $0.83 \times 10^{-5}$  at 25°. This value is quite comparable with those obtained when formamid is purified from the commercial product. The inference drawn from this observation is that the salts do not alter the purity of the solvent. It was also observed that formamid upon standing in sealed glass-stoppered Erlenmeyer flasks for a period of four months, June–October 1916, in a dark closet, increased in specific conductivity only about ten-fold. The values observed were  $0.7 \times 10^{-5}$  and  $0.97 \times 10^{-4}$  at 25°.

Formamid with a specific conductivity of  $0.70 \times 10^{-5}$  at 25° offers no great advantage over that with an average specific conductivity of about  $1.5 \times 10^{-5}$  at 25°, with the important exception of a lower solvent correction.

When the formamid was recovered from mixtures with ethyl alcohol its specific conductivity would reach a value of the order of  $1.5 \times 10^{-5}$  at 25° in about the same number of fractionations as when recovered from pure formamid solutions, but on standing the specific conductivity soon increased and in the course of 3 or 4 days became too large for conductivity measurements. This suggests a possible reaction between formamid and alcohol, the products of which are more difficult to remove by fractionation than the traces of ammonium formate resulting from hydrolysis of pure formamid by moisture from the air. Fur-

<sup>1</sup>Journ. Chem. Soc., **106**, 748 (1914).

<sup>2</sup>By "set" is meant all the solvent required for the solutions of various dilutions.

ther fractionation, however, yielded a product which maintained a high specific conductivity during the same interval of time as the pure solvent.

*Ethyl Alcohol.*—The ethyl alcohol used in preparing the mixed solvents was obtained by refluxing a good grade of commercial alcohol over lime for about 24 hours, then distilling. The middle fraction of about seven-tenths of the total distillate was collected and kept in receiver similar to that described by Lloyd and Pardee. (See Chapter III.) It had a mean specific conductivity of  $4.1 \times 10^{-7}$  at 25° and a density of 0.78506 to 0.78507 at the same temperature.

*Mixed Solvents.*—The mixed solvents containing formamid and alcohol were prepared by weighing directly into glass-stoppered flasks the quantities of each component to make a mixture of the desired weight per cent of each, all weighings being reduced to a vacuum.

#### SALTS.

As in the earlier work, all salts used were carefully recrystallized and dried to constant weight at a suitable temperature depending upon the nature of the salt. In the case of calcium nitrate, the salt was prepared from the purified carbonate, the solution evaporated to dryness, and the salt heated to constant weight at 150°, since it was practically impossible to recrystallize it. The aqueous solution showed only traces of alkalinity.

The formates and the sodium salts of the other organic acids were purified by recrystallization or were prepared from the purified acids. Just before using they were dried to constant weight in the vacuum drying-oven described under the head of apparatus. In the case of all hygroscopic salts the drying process was repeated after weighing out the required amount of salt for the solutions.

#### SOLUTIONS.

All solutions were made up at 20°, the more concentrated by direct weighing, those below one-tenth molar by dilution. Special precautions were used to protect both solvent and solutions from access of moisture, the procedure followed being essentially that outlined by Davis and Putnam; 25 to 50 cubic centimeters only of each solution were prepared, as this amount was sufficient both for conductivity and viscosity measurements.

#### APPARATUS.

The conductivity apparatus used was identical with that employed in the earlier work. The plate type of cell, previously described, served for measuring the conductivities of solutions both in pure formamid and in the mixed solvents. The cells were carefully standardized at regular intervals.

The viscosity measurements were obtained in a modified form of the Ostwald viscosimeter, the diameter and length of the capillary being adjusted so as to render the instrument suitable for measuring liquids more viscous than water. The viscosimeters were calibrated according to the more accurate method proposed by Thole,<sup>1</sup> using as calibrating liquids ethyl, propyl, and isobutyl alcohols, 30, 40, and 50 per cent by weight mixtures of ethyl alcohol and water and a 40 per cent solution of pure sucrose. The values for the density and viscosity of these calibrating liquids were obtained from the data compiled by Thole, Bingham,<sup>2</sup> and others from the most reliable measurements of various investigators. The average constant obtained for each instrument with this method gave somewhat larger values for the viscosity of formamid solutions than when calibrated with water alone, the time of flow of water being too short for accurate measurements—*i. e.*, less than 100 seconds. The following will serve as an example of the constants obtained:

VISCOSIMETER I<sub>A</sub>.

	$\eta_{25^\circ}$	$D_{25^\circ}/4^\circ$	$K \times 10^{-4}$
Ethyl alcohol.....	0.001096	0.78506	1.253
30 p. ct. ethyl alcohol.....	.00218	.95967	1.243
40 p. ct. ethyl alcohol.....	.00235	.93148	1.248
40 p. ct. sucrose.....	.005187	1.10188	1.244
			Av. 1.247

All measurements, both of conductivity and viscosity, were carried out in the thermostats described in a previous paper, in which a constant temperature to within  $0.01^\circ$  was maintained.

In order to obtain completely anhydrous samples of the salts studied a vacuum drying-oven was designed and constructed with the aid of Dr. Pardee. This apparatus consisted of a tubulated bell-jar 18 cm.  $\times$  24 cm. mounted on a heavy iron vacuum-plate. Two pairs of electrical connections lead into the center of the plate through a rubber stopper, one pair to a stove consisting of a 50-watt carbon-filament lamp incased in a metal chimney open at the top and having a circular window near the bottom, the other pair leading to a miniature fan motor in series with an 8 candle-power carbon lamp placed on the outside base. The fan maintained circulation within the oven by driving the air through the open side of the chimney, up around the lamp, and then out over two dishes containing either sulphuric acid or phosphorus pentoxide. The material to be desiccated was placed in watch crystals on perforated trays set above the motor and chimney. The tubular in the

<sup>1</sup>Journ. Chem. Soc., **105**, 2009 (1914).

<sup>2</sup>Zeit. Phys. Chem. **83**, 614 (1913); Bureau Standards Scientific Paper No. 298.



bell-jar was closed with a rubber stopper carrying the thermometer and pump connection. At about 90 mm. of mercury water boils at 49.6°. The heater maintained a temperature of 65°, the suction pump a vacuum of 70 to 80 mm., so that with the rapid circulation of the warm residual air over the material and the drying agent all traces of moisture could be removed from a sample with much greater ease than in an ordinary vacuum desiccator.

#### PROCEDURE.

Each "set" (*i. e.*, M/2, M/4, M/10, M/50, etc.) of solutions in pure formamid were made up the day before the conductivity measurements were taken, since experiments showed that measuring the solutions on the same day they were prepared did not increase the accuracy of the work. In the case of mixed solvents, however, it was necessary to make up the solutions and measure them the same day.

Cells were read consecutively in the 15°, 25°, and 35° baths. This order was always followed. The bridge readings, however, could be duplicated for the more concentrated solutions when allowed to come to temperature again in the 15° or 25° baths.

The molecular conductivity values were repeated for a number of salts, representing each series measured, to within 0.5 mm. reading on the bridge for all more concentrated solutions. Therefore, considering the errors in making up "check" solutions, the values below should be approximately correct.

In the tables all conductivity values are expressed in reciprocal ohms and are the molecular conductivities of gram-molecular weights of the various salts. These molecular conductivities ( $\mu_v$ ) were calculated from the formula  $\mu_v = K \frac{va}{Rb}$ , where  $K$  represents the cell constant,  $v$  the volume of concentration,  $R$  the resistance in ohms as measured by the rheostat, ( $a$ ) and ( $b$ ) the readings on the two sides of the bridge. The percentage dissociation,  $\alpha$ , was calculated from the equation  $\alpha = \frac{\mu_v}{\mu_\infty} \times 100$ , where  $\mu_\infty$  is the highest value of  $\mu_v$  obtained.

The temperature coefficients in conductivity units ( $T$ ) were derived by means of the formula  $\frac{\mu_v t - \mu_v t'}{t - t'} = T$ , in which  $\mu_v t$  represents the molecular conductivity at the higher temperature  $t$ , and  $\mu_v t'$  at the lower temperature  $t'$ . The coefficients expressed as percentages were calculated from the formula  $\Delta = \frac{T}{\mu_v t'}$ .

The values representing the molecular conductivity in these tables are mean of three bridge-readings involving different values for  $R$ . The

term  $V$  in the tables represents the number of liters containing a gram-molecular weight of the solute.  $K$  expresses the specific conductivity of the solvent.

The viscosity data were calculated from the formula  $\eta = K \cdot d \cdot t$ , where  $\eta$  presents the viscosity coefficient,  $k$  the constant of the instrument determined by calibration with a number of liquids of known viscosity,  $d$  the density of the solution at the temperature in question, and  $t$  the time of flow of the liquid or solution under investigation at that temperature. The fluidity  $\varphi$  is the reciprocal of the viscosity. The temperature coefficients represent the percentage increase in fluidity between the different temperatures studied—*i. e.*, 15° to 25° and 25° to 35°.

TABLE 30.—Ammonium Nitrate in Formamid.

V	Molecular Conductivity.			Dissociation.			Temperature Coefficients of Conductivity.			
	15°	25°	35°	15°	25°	35°	Per cent.		Conductivity Units.	
							15-25°	25-35°	15-25°	25-35°
2	17.45	22.29	27.50	69.5	69.2	69.3	0.0277	0.0233	0.484	0.521
4	19.39	25.08	31.07	77.3	77.3	78.4	.0293	.0235	.569	.599
10	22.00	28.00	34.75	87.7	87.7	87.7	.0273	.0241	.600	.675
50	24.26	30.91	34.48	96.7	96.7	97.1	.0281	.0244	.665	.757
100	24.34	31.20	38.64	97.0	97.0	97.5	.0286	.0239	.686	.744
200	24.79	31.76	39.29	98.8	98.8	99.2	.0285	.0237	.697	.753
400	25.08	32.21	39.59	100.0	100.0	100.0	.0284	.0235	.713	.738
				$K = 0.94 \times 10^{-5}$	$1.24 \times 10^{-5}$	$1.52 \times 10^{-5}$				

Mol. Conc.	Viscosity and Fluidity.							Temperature Coefficient ( $\varphi$ ).	
	$D_{25^\circ/4^\circ}$	$\eta_{15^\circ}$	$\eta_{25^\circ}$	$\eta_{35^\circ}$	$\varphi_{15^\circ}$	$\varphi_{25^\circ}$	$\varphi_{35^\circ}$	15-25°	25-35°
0.5	1.1436	0.04679	0.03515	0.02826	21.37	28.45	35.39	0.0331	0.0244
.25	1.1376	.04546	.03409	.02746	22.00	29.33	36.42	.0332	.0242
.10	1.1330	.04474	.03384	.02746	22.35	29.55	36.42	.0322	.0232
Solv.	1.1302	.04369	.03298	.02632	22.89	30.32	37.99	.0325	.0252

TABLE 31.—Potassium Nitrate in Formamid.

V	Molecular Conductivity.			Temperature Coefficients of Conductivity.			
				Per cent.		Conductivity Units.	
	15°	25°	35°	15-25°	25-35°	15-25°	25-35°
2	14.08	18.17	22.72	0.0290	0.0250	0.409	0.455
4	16.67	21.62	26.82	.0297	.0240	.495	.520
10	19.04	24.39	30.30	.0280	.0242	.535	.591
50	21.27	27.29	33.90	.0283	.0242	.602	.661
100	21.90	28.14	34.85	.0284	.0238	.624	.671
200	22.48	29.05	36.18	.0292	.0245	.657	.713
400	23.70	30.53	37.84	.0288	.0239	.683	.731
		$K = 0.945 \times 10^{-5}$		$1.24 \times 10^{-5}$		$1.52 \times 10^{-5}$	

Mol. Conc.	Viscosity and Fluidity.							Temperature Coefficients ( $\varphi$ ).	
	$D_{25^\circ/4^\circ}$	$\eta_{15^\circ}$	$\eta_{25^\circ}$	$\eta_{35^\circ}$	$\varphi_{15^\circ}$	$\varphi_{25^\circ}$	$\varphi_{35^\circ}$	15-25°	25-35°
0.5	1.1570	0.05166	0.03858	0.03040	19.36	25.92	32.89	0.0339	0.0269
0.25	1.1444	.04836	.03611	.02819	20.68	27.69	35.47	.0339	.0281
0.10	1.1359	.04591	.03450	.02751	21.78	28.99	36.35	.0331	.0254
Solv.	.....	.04369	.03298	.02632	22.89	30.32	37.99	.0325	.0253

TABLE 32.—Sodium Nitrate in Formamid.

V	Molecular Conductivity.			Dissociation.			Temperature Coefficients of Conductivity.			
							Per cent.		Conductivity Units.	
	15°	25°	35°	15°	25°	35°	15-25°	25-35°	15-25°	25-35°
2	12.96	16.74	21.13	60.8	60.4	61.3	0.0291	0.0260	0.378	0.439
4	15.44	20.23	24.69	72.4	72.9	71.6	.0310	.0220	.479	.446
10	17.72	23.32	29.72	83.1	84.0	86.2	.0317	.0273	.560	.640
50	19.38	25.03	31.62	90.9	90.2	91.7	.0291	.0263	.565	.659
100	20.05	26.18	33.01	94.1	94.4	95.7	.0305	.0260	.613	.683
200	20.35	26.62	33.20	95.5	95.9	96.3	.0306	.0247	.627	.658
400	20.77	27.14	33.98	97.5	97.8	98.5	.0305	.0251	.637	.684
800	21.30	27.73	34.47	100.0	100.0	100.0	.0302	.0243	.643	.674
1600	21.26	27.56	34.38	.....	.....	.....	.0295	.0247	.630	.682
		$K = 0.67 \times 10^{-5}$		$0.87 \times 10^{-5}$		$1.07 \times 10^{-5}$				

Mol. Conc.	Viscosity and Fluidity.							Temperature Coefficients ( $\varphi$ )	
	$D_{25^\circ/4^\circ}$	$\eta_{15^\circ}$	$\eta_{25^\circ}$	$\eta_{35^\circ}$	$\varphi_{15^\circ}$	$\varphi_{25^\circ}$	$\varphi_{35^\circ}$	15-25°	25-35°
0.5	1.1542	0.05585	0.04112	0.03223	17.91	24.32	31.03	0.0358	0.0276
0.25	1.1429	.05012	.03726	.02972	19.95	26.84	33.65	.0345	.0254
0.10	1.1361	.04651	.03509	.02785	21.50	28.50	35.91	.0326	.0260
Solv.	1.1314	.04403	.03338	.02665	22.71	29.96	37.52	.0319	.0252

TABLE 33.—Calcium Nitrate in Formamid.

V	Molecular Conductivity.			Temperature Coefficients of Conductivity.			
				Per cent.		Conductivity Units.	
	15°	25°	35°	15-25°	25-35°	15-25°	25-35°
10	30.44	39.50	49.37	0.0297	0.0249	0.906	0.987
50	37.80	48.56	60.71	.0284	.0250	1.076	1.215
100	41.18	52.98	66.56	.0286	.0256	1.180	1.358
200	42.55	54.89	70.13	.0290	.0274	1.234	1.524
400	43.46	55.90	72.15	.0286	.0271	1.244	1.625
1600	46.03	58.54	75.44	.0272	.0306	1.251	1.690
	$K = 1.41 \times 10^{-5}$	$1.91 \times 10^{-5}$	$2.34 \times 10^{-5}$				

TABLE 34.—Barium Nitrate in Formamid.

V	Molecular Conductivity.			Temperature Coefficients of Conductivity.			
				Per cent.		Conductivity Units.	
	15°	25°	35°	15-25°	25-35°	15-25°	25-35°
4.....	20.90	27.19	34.14	0.0300	0.0255	0.629	0.695
10.....	28.20	36.93	47.08	.0309	.0274	.873	1.015
50.....	36.79	47.73	60.77	.0298	.0273	1.094	1.304
100.....	39.73	51.91	65.05	.0306	.0257	1.218	1.314
200.....	40.86	53.16	66.52	.0300	.0251	1.230	1.336
400.....	41.53	53.94	67.39	.0299	.0249	1.241	1.345
800.....	44.20	57.51	71.90	.0300	.0250	1.331	1.439
1600.....	45.24	58.78	74.05	.0296	.0259	1.354	1.527
		$K = 0.79 \times 10^{-5}$		$1.99 \times 10^{-5}$	$1.27 \times 10^{-5}$		

Mol. Conc.	Viscosity and Fluidity.							Temperature Coefficients ( $\varphi$ ).	
	$D_{25^\circ/4^\circ}$	$\eta_{15^\circ}$	$\eta_{25^\circ}$	$\eta_{35^\circ}$	$\varphi_{15^\circ}$	$\varphi_{25^\circ}$	$\varphi_{35^\circ}$	15-25°	25-35°
0.25	1.1785	0.05815	0.04286	0.03393	17.20	22.33	29.47	0.0298	0.0306
0.10	1.1501	.04903	.03688	.02933	20.40	27.11	34.09	.0329	.0257
Solv.	1.1313	.04440	.03328	.02651	22.52	30.05	37.72	.0334	.0255

TABLE 35.—Strontium Nitrate in Formamid.

V	Molecular conductivity.			Dissociation.			Temperature Coefficients of Conductivity.			
							Per cent.		Conductivity Units.	
	15°	25°	35°	15°	25°	35°	15-25°	25-35°	15-25°	25-35°
4	22.62	30.18	37.62	52.6	53.0	52.7	0.0334	0.0246	0.756	0.744
10	29.46	39.24	49.77	68.6	68.5	69.0	.0326	.0269	.958	1.053
50	37.73	49.73	62.99	87.0	87.0	87.4	.0319	.0265	1.205	1.326
100	39.18	51.29	64.82	91.2	90.1	90.7	.0309	.0263	1.211	1.353
200	41.09	53.75	67.51	95.6	94.4	94.5	.0308	.0256	1.266	1.370
400	42.87	56.75	70.84	99.8	99.7	99.2	.0320	.0248	1.388	1.409
800	42.94	56.91	71.38	100.0	100.0	100.0	.0325	.0254	1.391	1.447
1600	42.47	55.74	69.30	.....	.....	.....	.....	.....	.....	.....
			$K = 1.25 \times 10^{-5}$	$1.32 \times 10^{-5}$	$1.96 \times 10^{-5}$					

Mol. Conc.	Viscosity and Fluidity.							Temperature Coefficients ( $\varphi$ ).	
	$D_{25^\circ/4^\circ}$	$\eta_{15^\circ}$	$\eta_{25^\circ}$	$\eta_{35^\circ}$	$\varphi_{15^\circ}$	$\varphi_{25^\circ}$	$\varphi_{35^\circ}$	15-25°	25-35°
0.25	1.1676	0.05758	0.04259	0.03354	17.37	23.48	29.82	0.0352	0.0270
0.10	1.1457	.04947	.03686	.02956	20.21	27.13	33.83	.0342	.0247
Solv.	1.1310	.04405	.03319	.02642	22.70	30.13	37.85	.0327	.0253

TABLE 36.—Rubidium Formate in Formamid.

V	Molecular Conductivity.			Dissociation.			Temperature Coefficients of Conductivity.			
							Per cent.		Conductivity Units.	
	15°	25°	35°	15°	25°	35°	15-25°	25-35°	15-25°	25-35°
10	Saturated solution.									
50	13.34	16.97	20.90	99.3	98.2	97.1	0.0272	0.0231	0.363	0.393
200	13.44	17.30	21.52	100.0	100.0	100.0	.0287	.0243	.386	.422
400	12.70	16.41	19.84	.....	.....	.....	.....	.....	.....	.....
			$K = 0.77 \times 10^{-5}$	$0.99 \times 10^{-5}$	$1.24 \times 10^{-5}$					

Mol. Conc.	Viscosity and Fluidity.		
	$D_{25^\circ/4^\circ}$	$\eta_{25^\circ}$	$\varphi_{25^\circ}$
0.25	1.1462	0.03561	28.08
0.10	1.1370	.03432	29.14
Solv.	1.1213	.03286	30.43

TABLE 37.—Ammonium Formate in Formamid.

F	Molecular Conductivity.			Dissociation.			Temperature Coefficients of Conductivity.			
							Per cent.		Conductivity Units.	
	15°	25°	35°	15°	25°	35°	15-25°	25-35°	15-25°	25-35°
10	18.82	24.22	29.99	79.9	80.1	80.9	0.0287	0.0238	0.540	0.577
50	21.86	28.09	34.68	91.2	92.9	93.0	.0285	.0234	.623	.659
200	23.24	29.82	36.82	97.0	98.7	99.4	.0281	.0234	.653	.700
400	23.97	30.21	37.04	100.0	100.0	100.0	.0260	.0226	.624	.683
				$K = 2.01 \times 10^{-5}$	$2.51 \times 10^{-5}$	$3.34 \times 10^{-5}$				
Mol. Conc.	Viscosity and Fluidity.							Temperature Coefficients ( $\varphi$ ).		
	$D_{25^\circ/4^\circ}$	$\eta_{15^\circ}$	$\eta_{25^\circ}$	$\eta_{35^\circ}$	$\varphi_{15^\circ}$	$\varphi_{25^\circ}$	$\varphi_{35^\circ}$	15-25°	25-35°	
0.25	1.1324	0.04734	0.03544	0.02829	21.12	28.22	35.35	0.0336	0.0253	
0.10	1.1310	.04497	.03403	.02720	22.24	29.39	36.76	.0322	.0251	
Solv.	1.1303	.04389	.03332	.02640	22.78	30.01	37.88	.0317	.0262	

TABLE 38.—Sodium Formate in Formamid.

F	Molecular Conductivity.			Dissociation.			Temperature Coefficients of Conductivity.			
							Per cent.		Conductivity Units.	
	15°	25°	35°	15°	25°	35°	15-25°	25-35°	15-25°	25-35°
2	10.32	13.67	17.24	55.8	56.6	56.9	0.0324	0.0261	0.335	0.357
4	12.76	16.48	21.46	68.9	68.2	70.8	.0302	.0290	.372	.498
10	15.22	19.91	25.00	82.1	82.4	82.5	.0309	.0256	.469	.509
50	17.35	22.64	28.44	93.8	93.8	93.8	.0305	.0255	.529	.580
100	18.07	23.61	29.62	97.6	97.7	97.7	.0305	.0254	.553	.601
200	18.50	24.15	30.29	100.0	100.0	100.0	.0300	.0254	.565	.614
400	18.45	24.01	30.21	.....	.....	.....	.....	.....	.....	.....
				$K = 0.8 \times 10^{-5}$	$1.03 \times 10^{-5}$	$1.27 \times 10^{-5}$				
Mol. Conc.	Viscosity and Fluidity.							Temperature Coefficients ( $\varphi$ ).		
	$D_{25^\circ/4^\circ}$	$\eta_{15^\circ}$	$\eta_{25^\circ}$	$\eta_{35^\circ}$	$\varphi_{15^\circ}$	$\varphi_{25^\circ}$	$\varphi_{35^\circ}$	15-25°	25-35°	
0.50	1.1469	0.05869	0.04299	0.03348	17.04	23.26	29.87	0.0365	0.0284	
0.25	1.1393	.05166	.03812	.03037	19.36	26.23	32.93	.0355	.0255	
0.10	1.1345	.04672	.03510	.02798	21.40	28.49	35.74	.0331	.0254	
Solv.	1.1314	.04403	.03338	.02665	22.71	29.96	37.52	.0319	.0252	

TABLE 39.—*Lithium Formate in Formamid.*

V	Molecular Conductivity.			Dissociation.			Temperature Coefficients of Conductivity.			
							Per cent.		Conductivity Units.	
	15°	25°	35°	15°	25°	35°	15-25°	25-35°	15-25°	25-35°
4	10.42	13.47	16.83	56.5	56.6	57.0	0.0293	0.0249	0.306	0.335
10	13.00	16.82	20.97	70.9	70.9	71.0	.0293	.0246	.381	.416
50	16.53	21.22	26.49	89.6	89.4	89.8	.0283	.0248	.438	.449
100	17.24	22.31	27.56	93.4	94.4	93.4	.0293	.0235	.507	.525
200	17.79	22.90	28.35	96.4	96.3	96.2	.0287	.0238	.546	.511
400	18.03	23.25	28.88	97.7	98.1	97.8	.0289	.0242	.454	.564
800	18.26	23.51	29.18	99.0	98.9	98.9	.0287	.0241	.548	.567
1600	18.44	23.55	29.50	100.0	100.0	100.0	.0289	.0232	.533	.572
			$K = 0.54 \times 10^{-5}$ $0.71 \times 10^{-5}$ $0.87 \times 10^{-5}$							

Mol. Conc.	Viscosity and Fluidity.							Temperature Coefficients ( $\varphi$ ).	
	$D_{25^\circ/4^\circ}$	$\eta_{15^\circ}$	$\eta_{25^\circ}$	$\eta_{35^\circ}$	$\varphi_{15^\circ}$	$\varphi_{25^\circ}$	$\varphi_{35^\circ}$	15-25°	25-35°
0.5	1.1399	0.05680	0.04224	0.03358	17.61	23.67	29.78	0.0344	0.0258
0.25	1.1358	.05091	.03787	.03043	19.64	26.41	32.86	.0345	.0256
0.15	1.1328	.04637	.03495	.02791	21.57	28.61	35.83	.0326	.0252
Solv.	1.1314	.04403	.03338	.02665	22.71	29.96	37.52	.0319	.0252

 TABLE 40.—*Barium Formate in Formamid.*

V	Molecular Conductivity.			Temperature Coefficients of Conductivity.			
				Per cent.		Conductivity Units.	
	15°	25°	35°	15-25°	25-35°	15-25°	25-35°
50	33.55	43.48	53.72	0.0296	0.0235	0.993	1.024
200	37.26	48.87	60.52	.0311	.0238	1.161	1.165
400	37.94	49.93	61.69	.0316	.0236	1.199	1.176
800	38.59	50.63	62.64	.0311	.0236	1.204	1.201
1600	39.27	51.67	63.71	.0316	.0233	1.240	1.204
			$K = 0.77 \times 10^{-5}$ $.99 \times 10^{-5}$ $1.24 \times 10^{-5}$				

TABLE 41.—Strontium Formate in Formamid.

V	Molecular Conductivity.			Dissociation.			Temperature Coefficients of Conductivity.				
							Per cent.		Conductivity Units.		
	15°	25°	35°	15°	25°	35°	15-25°	25-35°	15-25°	25-35°	
50	Saturated solution.			77.8	76.2	76.8	0.0281	0.0241	0.912	1.000	
200	32.42	41.54	51.54	90.2	89.4	90.6	.0298	.0248	1.119	1.207	
400	39.14	51.60	63.72	94.1	94.7	95.2	.0318	.0234	1.246	1.212	
800	40.37	52.97	65.25	97.1	97.2	97.3	.0312	.0232	1.260	1.228	
1600	41.59	54.48	67.05	100.0	100.0	100.0	.0310	.0231	1.289	1.257	
				$K = 0.54 \times 10^{-5}$ $0.71 \times 10^{-5}$ $0.87 \times 10^{-5}$							

TABLE 42.—Sodium Benzoate in Formamid.

V	Molecular Conductivity.			Dissociation.			Temperature Coefficients of Conductivity.				
							Per cent.		Conductivity Units.		
	15°	25°	35°	15°	25°	35°	15-25°	25-35°	15-25°	25-35°	
4	9.24	12.41	15.73	57.6	60.1	62.1	0.0353	0.0267	0.317	0.332	
8	10.94	14.51	18.37	68.2	70.3	72.5	.0326	.0266	.357	.386	
10	11.40	15.03	19.15	71.1	72.8	75.6	.0319	.0273	.363	.412	
50	13.22	17.54	22.25	82.5	85.0	87.8	.0326	.0268	.432	.471	
200	14.22	18.58	23.46	88.7	90.1	92.6	.0306	.0263	.436	.488	
400	14.45	18.81	23.67	90.2	91.2	93.3	.0294	.0259	.436	.486	
1600	16.02	20.62	25.33	100.0	100.0	100.0	.0287	.0223	.460	.471	
				$K = 0.6 \times 10^{-5}$ $0.8 \times 10^{-5}$ $1.06 \times 10^{-5}$							

Mol. Conc.	Viscosity and Fluidity.							Temperature Coefficients ( $\varphi$ ).	
	$D_{25^\circ}/4^\circ$	$\eta_{15^\circ}$	$\eta_{25^\circ}$	$\eta_{35^\circ}$	$\varphi_{15^\circ}$	$\varphi_{25^\circ}$	$\varphi_{35^\circ}$	15-25°	25-35°
0.25	1.1392	0.05492	0.04047	0.03164	18.21	24.71	31.61	0.0357	0.0279
0.10	1.1342	.04808	.03604	.02853	20.80	27.75	35.05	.0334	.0263
Solv.	1.1295	.04402	.03319	.02678	22.72	30.13	37.34	.0326	.0239



TABLE 43.—Sodium-Meta-Brom-Benzoate in Formamid.

V	Molecular Conductivity.			Temperature Coefficients of Conductivity.			
				Per cent.		Conductivity Units.	
	15°	25°	35°	15-25°	25-35°	15-25°	25-35°
10	10.47	13.92	17.69	0.0330	0.0271	0.345	0.377
50	14.95	19.50	24.73	.0313	.0264	.477	.527
		$K = 0.8 \times 10^{-6}$		$1.06 \times 10^{-5}$	$1.32 \times 10^{-5}$		

TABLE 44.—Sodium Metamido Benzoate in Formamid.

V	Molecular Conductivity.			Temperature Coefficients of Conductivity.			
				Per cent.		Conductivity Units.	
	15°	25°	35°	15-25°	25-35°	15-25°	25-35°
10.....	10.83	14.34	18.20	0.0325	0.0269	0.351	0.394
50.....	14.06	18.53	23.34	.0318	.0260	.447	.481
200.....	18.31	23.96	30.23	.0308	.0261	.565	.627
400.....	23.89	31.17	39.16	.0304	.0256	.728	.799
1600.....	56.24	73.13	91.30	.0300	.0254	.689	.817
		$K = 0.8 \times 10^{-5}$		$1.06 \times 10^{-5}$	$1.32 \times 10^{-5}$		

Mol. Conc.	Viscosity and Fluidity.						Temperature Coefficients ( $\varphi$ ).		
	$D_{25^\circ/4^\circ}$	$\eta_{15^\circ}$	$\eta_{25^\circ}$	$\eta_{35^\circ}$	$\varphi_{15^\circ}$	$\varphi_{25^\circ}$	$\varphi_{35^\circ}$	15-25°	25-35°
0.10	1.1353	0.04884	0.03678	0.02910	20.48	27.19	34.36	0.0328	0.0264
Solv.	1.1307	.04409	.03325	.02655	22.68	30.08	37.66	.0326	.0252

TABLE 45.—Sodium-Dinitro-Benzoate (1, 3, 5) in Formamid.

V	Molecular Conductivity.			Temperature Coefficients of Conductivity.			
				Per cent.		Conductivity Units.	
	15°	25°	35°	15-25°	25-35°	15-25°	25-35°
10.....	10.43	13.95	17.73	0.0337	0.0269	0.352	0.375
50.....	13.09	17.32	22.08	.0323	.0274	.423	.476
200.....	16.18	21.42	27.12	.0323	.0266	.524	.570
400.....	21.64	28.50	36.06	.0320	.0262	.694	.748
1600.....	47.08	60.66	74.82	.0288	.0233	1.358	1.416
	$K = 0.80 \times 10^{-5}$			$1.06 \times 10^{-5}$		$1.32 \times 10^{-5}$	

Mol. Conc.	Viscosity and Fluidity.							Temperature Coefficients ( $\varphi$ ).	
	$D_{25^\circ/4^\circ}$	$\eta_{15^\circ}$	$\eta_{25^\circ}$	$\eta_{35^\circ}$	$\varphi_{15^\circ}$	$\varphi_{25^\circ}$	$\varphi_{35^\circ}$	15-25°	25-35°
0.10 Solv.	1.1395 1.1307	0.04943 .04409	0.03682 .03325	0.02947 .02655	20.23 22.68	27.16 30.08	33.93 37.66	0.0343 .0326	0.0249 .0252

TABLE 46.—Sodium Salicylate in Formamid.

V	Molecular Conductivity.			Temperature Coefficients of Conductivity.			
				Per cent.		Conductivity Units.	
	15°	25°	35°	15-25°	25-35°	15-25°	25-35°
4.....	9.65	13.06	16.56	0.0353	0.0267	0.341	0.350
10.....	11.74	15.51	19.79	.0321	.0276	.377	.428
50.....	13.70	18.04	22.95	.0317	.0272	.434	.491
200.....	14.49	19.01	24.12	.0312	.0269	.452	.511
400.....	14.80	19.27	24.40	.0300	.0266	.447	.513
1600.....	17.10	22.13	27.26	.0295	.0232	.503	.513
	$K = 0.68 \times 10^{-5}$			$0.83 \times 10^{-5}$		$1.06 \times 10^{-5}$	

Mol. Conc.	Viscosity and Fluidity.							Temperature Coefficients ( $\varphi$ ).	
	$D_{25^\circ/4^\circ}$	$\eta_{15^\circ}$	$\eta_{25^\circ}$	$\eta_{35^\circ}$	$\varphi_{15^\circ}$	$\varphi_{25^\circ}$	$\varphi_{35^\circ}$	15-25°	25-35°
0.25	1.1417	0.05374	0.03988	0.03136	18.61	25.08	31.89	0.0348	0.0272
0.10	1.1345	.04787	.03571	.02859	20.89	28.00	34.98	.0340	.0249
Solv.	1.1306	.04379	.03317	.02648	22.84	30.15	37.76	.0320	.0252

TABLE 47.—Sodium Benzene Sulphonate in Formamid.

V	Molecular Conductivity.			Temperature Coefficients of Conductivity.				
				Per cent.		Conductivity Units.		
	15°	25°	35°	15-25°	25-35°	15-25°	25-35°	
10	12.05	15.87	20.21	0.0317	0.0273	0.382	0.434	
50	13.90	18.23	23.06	.0301	.0265	.433	.483	
200	14.52	19.01	24.00	.0309	.0262	.449	.499	
400	14.76	19.04	24.39	.0290	.0280	.428	.547	
1600	16.40	20.90	26.82	.0274	.0283	.450	.592	
			$K = 0.8 \times 10^{-5}$		$1.06 \times 10^{-5}$		$1.32 \times 10^{-5}$	

Mol. Conc.	Viscosity and Fluidity.							Temperature Coefficients ( $\varphi$ ).	
	$D_{25^\circ/4^\circ}$	$\eta_{15^\circ}$	$\eta_{25^\circ}$	$\eta_{35^\circ}$	$\varphi_{15^\circ}$	$\varphi_{25^\circ}$	$\varphi_{35^\circ}$	15-25°	25-35°
0.10 Solv.	1.1360 1.1306	0.04727 .04379	0.03554 .03317	0.02836 .02648	21.17 22.84	28.14 30.15	35.26 37.76	0.0329 .0320	0.0253 .0252

TABLE 48.—Sodium Succinate in Formamid.

V	Molecular Conductivity.			Dissociation.			Temperature Coefficients of Conductivity.			
							Per cent.		Conductivity Units.	
	15°	25°	35°	15°	25°	35°	15-25°	25-35°	15-25°	25-35°
10	21.72	28.71	36.59	62.2	64.3	66.6	0.0321	0.0274	0.699	0.788
50	29.54	38.82	49.04	84.4	87.0	89.2	.0314	.0263	.928	1.012
200	32.56	42.67	53.84	90.3	95.6	97.9	.0308	.0252	1.011	1.117
400	33.20	43.32	54.24	90.5	97.1	98.6	.0304	.0252	1.012	1.092
1600	34.88	44.59	54.95	100.0	100.0	100.0	.0298	.0233	.979	1.036
			$K = 0.6 \times 10^{-4}$		$0.8 \times 10^{-5}$		$1.06 \times 10^{-5}$			

Mol. Conc.	Viscosity and Fluidity.							Temperature Coefficients ( $\varphi$ ).	
	$D_{25^\circ/4^\circ}$	$\eta_{15^\circ}$	$\eta_{25^\circ}$	$\eta_{35^\circ}$	$\varphi_{15^\circ}$	$\varphi_{25^\circ}$	$\varphi_{35^\circ}$	15-25°	25-35°
0.10 Solv.	1.1381 1.1295	0.05254 .04402	0.03907 .03319	0.03110 .02678	19.03 22.72	25.60 30.13	32.15 37.34	0.0345 .0326	0.0256 .0239

TABLE 49.—*Tetraethylammonium Iodide.*

In 7 per cent formamid and 25 per cent ethyl alcohol.  
Specific conductivity 25°. Formamid,  $14 \times 10^{-5}$ . Ethyl alcohol,  $4.1 \times 10^{-7}$ .

V	Molecular Conductivity.			Temperature Coefficients of Conductivity.			
				Per cent.		Conductivity Units.	
	15°	25°	35°	15-25°	25-35°	15-25°	25-35°
4 .....	13.31	17.13	21.14	0.0287	0.0234	0.382	0.401
10 .....	19.96	25.70	31.72	.0287	.0234	.374	.602
50 .....	23.38	29.76	36.86	.0274	.0328	.638	.710
100 .....	24.64	31.44	38.91	.0276	.0237	.680	.747
200 .....	24.75	31.69	39.15	.0280	.0236	.694	.746
400 .....	24.96	31.95	39.53	.0280	.0237	.699	.758
1600 .....	24.82	31.95	39.24	.....	.....	.....	.....
	$K = 1.0 \times 10^{-5} \quad 1.25 \times 10^{-5} \quad 1.57 \times 10^{-5}$						

Mol. Conc.	Viscosity and Fluidity.							Temperature Coefficients ( $\phi$ ).	
	$D_{25^\circ/4^\circ}$	$\eta_{15^\circ}$	$\eta_{25^\circ}$	$\eta_{35^\circ}$	$\phi_{15^\circ}$	$\phi_{25^\circ}$	$\phi_{35^\circ}$	15-25°	25-35°
0.25	1.0436	0.03639	0.02763	0.02228	27.48	36.19	44.88	0.0317	0.0240
0.10	1.0330	.03469	.02651	.02132	28.83	37.72	46.90	.0308	.0243
Solv.	1.0260	.03389	.02577	.02066	29.51	38.80	48.40	.0315	.0247

In 50 per cent formamid and 50 per cent ethyl alcohol.

V	Molecular Conductivity.			Temperature Coefficients of Conductivity.			
				Per cent.		Conductivity Units.	
	15°	25°	35°	15-25°	25-35°	15-25°	25-35°
4 .....	18.80	23.29	28.59	0.0239	0.0227	0.449	0.530
10 .....	22.23	27.92	33.94	.0250	.0219	.559	.613
50 .....	27.24	34.01	41.30	.0248	.0214	.677	.729
100 .....	29.49	36.71	44.67	.0245	.0215	.722	.796
200 .....	29.96	37.24	45.26	.0245	.0215	.734	.802
400 .....	31.00	38.64	46.95	.0246	.0215	.765	.831
	$K = 1.01 \times 10^{-5} \quad 1.24 \times 10^{-5} \quad 1.40 \times 10^{-5}$						

Mol. Conc.	Viscosity and Fluidity.							Temperature Coefficients ( $\phi$ ).	
	$D_{25^\circ/4^\circ}$	$\eta_{15^\circ}$	$\eta_{25^\circ}$	$\eta_{35^\circ}$	$\phi_{15^\circ}$	$\phi_{25^\circ}$	$\phi_{35^\circ}$	15-25°	25-35°
0.25	0.9570	0.02666	0.02086	0.01707	37.51	47.94	58.58	0.0278	0.0222
.10	.9437	.02571	.02002	.01631	38.90	49.95	61.31	.0284	.0227
.02	.9369	.02494	.01953	.01597	40.10	51.20	62.62	.0277	.0223
Solv.	.9346	.02488	.01939	.01580	.....	.....	.....	.0283	.0227

TABLE 49.—*Tetraethylammonium Iodide*—Continued.

In 25 per cent formamid and 75 per cent ethyl alcohol.

V	Molecular Conductivity.			Temperature Coefficients of Conductivity.			
				Per cent.		Conductivity Units.	
	15°	25°	35°	15-25°	25-35°	15-25°	25-35°
4	Saturated solution.						
10	22.28	27.86	33.92	0.0219	0.0208	0.482	0.560
50	29.21	35.56	42.61	.0219	.0198	.635	.705
100	32.43	39.41	47.17	.0215	.0194	.698	.776
200	34.08	41.34	49.36	.0213	.0194	.726	.802
400	36.04	43.79	52.29	.0215	.0194	.775	.850
800	36.72	44.46	53.15	.0210	.0195	.774	.869
1600	38.13	46.08	54.90	.0209	.0191	.795	.882
	$K = 1.56 \times 10^{-6}$			$1.80 \times 10^{-5}$	$1.99 \times 10^{-5}$		

Mol. Conc.	Viscosity and Fluidity.							Temperature Coefficients ( $\varphi$ ).	
	$D_{25}^{\circ}/4^{\circ}$	$\eta_{15}^{\circ}$	$\eta_{25}^{\circ}$	$\eta_{35}^{\circ}$	$\varphi_{15}^{\circ}$	$\varphi_{25}^{\circ}$	$\varphi_{35}^{\circ}$	15-25°	25-35°
0.10	0.8663	0.01828	0.01474	0.01257	54.70	67.84	80.84	0.0240	0.0192
.02	.8580	.01795	.01438	.01197	55.71	69.54	83.54	.0248	.0168
Solv.	0.8554	.01761	.01412	.01174	56.79	70.82	85.18	.0247	.0203

 TABLE 50.—*Rubidium Iodide*.

In 75 per cent formamid and 25 per cent ethyl alcohol.

 Specific conductivity 25°. Formamid,  $1.6 \times 10^{-5}$ . Ethyl alcohol,  $4.1 \times 10^{-7}$ .

V	Molecular Conductivity.			Temperature Coefficients of Conductivity.			
				Per cent.		Conductivity Units.	
	15°	25°	35°	15-25°	25-35°	15-25°	25-35°
4	20.00	25.71	31.55	0.0285	0.0227	0.571	0.584
10	22.30	28.45	35.15	.0275	.0235	.615	.670
50	24.70	31.45	38.75	.0273	.0232	.675	.730
100	25.69	32.78	40.50	.0275	.0235	.709	.772
200	25.92	33.04	40.88	.0275	.0237	.712	.784
400	26.25	33.48	41.50	.0275	.0239	.723	.803
1600	26.73	34.12	42.27	.0276	.0239	.739	.815
	$K = 0.75 \times 10^{-5}$			$0.96 \times 10^{-5}$	$1.21 \times 10^{-6}$		

Mol. Conc.	Viscosity and Fluidity.							Temperature Coefficients ( $\varphi$ ).	
	$D_{25}^{\circ}/4^{\circ}$	$\eta_{15}^{\circ}$	$\eta_{25}^{\circ}$	$\eta_{35}^{\circ}$	$\varphi_{15}^{\circ}$	$\varphi_{25}^{\circ}$	$\varphi_{35}^{\circ}$	15-25°	25-35°
0.10	1.0417	0.03468	0.02657	0.02147	28.84	37.64	46.58	0.0297	0.0245
.02	1.0300	.03394	.02598	.02086	29.46	38.49	47.94	.0306	.0246
Solv.	1.0257	.03366	.02573	.02070	29.71	38.87	48.31	.0308	.0243

TABLE 50.—*Rubidium Iodide*—Continued.  
In 50 per cent formamid and 50 per cent ethyl alcohol.

$\nu$	Molecular Conductivity.			Temperature Coefficients of Conductivity.			
				Per cent.		Conductivity Units.	
	15°	25°	35°	15-25°	25-35°	15-25°	25-35°
4	21.39	26.83	32.60	0.0254	0.0215	0.544	0.577
10	24.59	30.64	37.12	.0246	.0211	.605	.648
50	28.47	35.41	43.00	.0244	.0214	.694	.759
100	29.50	36.75	44.58	.0245	.0213	.725	.783
200	30.25	37.69	45.83	.0245	.0216	.744	.815
400	30.90	38.47	46.71	.0244	.0214	.757	.824
1600	32.02	39.77	48.12	.0242	.0210	.775	.835
	$K = 0.35 \times 10^{-5}$			$0.70 \times 10^{-5}$	$0.8 \times 10^{-5}$		

Mol. Conc.	Viscosity and Fluidity.							Temperature Coefficients ( $\varphi$ ).	
	$D_{25^\circ/4^\circ}$	$\eta_{15^\circ}$	$\eta_{25^\circ}$	$\eta_{35^\circ}$	$\varphi_{15^\circ}$	$\varphi_{25^\circ}$	$\varphi_{35^\circ}$	15-25°	25-35°
0.25	0.9763	0.02790	0.02190	0.01769	35.84	45.66	56.53	0.0274	0.0238
.10	.9515	.02572	.02031	.01647	38.88	49.24	60.72	.0266	.0233
Solv.	.9345	.02471	.01934	.01577	40.47	51.71	63.41	.0278	.0226

In 25 per cent formamid and 75 per cent ethyl alcohol.

$\nu$	Molecular Conductivity.			Temperature Coefficients of Conductivity.			
				Per cent.		Conductivity Units.	
	15°	25°	35°	15-25°	25-35°	15-25°	25-35°
4	20.92	25.27	30.03	0.0208	0.0188	0.436	0.476
10	24.75	29.98	35.61	.0211	.0187	.523	.563
50	30.49	37.06	44.05	.0215	.0188	.627	.699
100	32.80	39.85	47.40	.0215	.0189	.705	.755
200	34.06	41.44	49.38	.0216	.0191	.738	.793
400	35.13	42.75	51.02	.0216	.0193	.762	.826
1600	36.69	44.54	53.28	.0214	.0194	.785	.878
	$K = 0.425 \times 10^{-5}$			$0.515 \times 10^{-5}$	$0.608 \times 10^{-5}$		

Mol. Conc.	Viscosity and Fluidity.							Temperature Coefficients ( $\varphi$ ).	
	$D_{25^\circ/4^\circ}$	$\eta_{15^\circ}$	$\eta_{25^\circ}$	$\eta_{35^\circ}$	$\varphi_{15^\circ}$	$\varphi_{25^\circ}$	$\varphi_{35^\circ}$	15-25°	25-35°
0.25	0.8984	0.01996	0.01580	0.01309	50.12	63.29	76.39	0.0263	0.0207
.10	.8723	.01898	.01483	.01229	52.69	67.43	81.37	.0280	.0207
.02	.8588	.01777	.01433	.01189	56.27	69.78	84.10	.0240	.0205
Solv.	.8549	.01756	.01414	.01178	56.95	70.72	84.89	.0242	.0200

TABLE 51.—Lithium Nitrate.

In 75 per cent formamid and 25 per cent ethyl alcohol.  
 Specific conductivity 25°. Formamid,  $1.62 \times 10^{-5}$  Ethyl alcohol,  $4.1 \times 10^{-7}$ .

Γ	Molecular Conductivity.			Temperature Coefficients of Conductivity.			
				Per cent.		Conductivity Units.	
	15°	25°	35°	15-25°	25-35°	15-25°	25-35°
10 .....	18.71	23.70	29.12	0.0266	0.0228	0.499	0.542
50 .....	21.43	27.08	33.30	.0263	.0229	.565	.622
200 .....	22.76	28.83	35.41	.0269	.0228	.607	.658
400 .....	22.83	29.08	33.81	.0273	.....	.625	.....
1600 .....	22.79	29.04	.....	.....	.....	.....	.....
	$K = 0.84 \times 10^{-5}$		$1.09 \times 10^{-5}$	$1.37 \times 10^{-5}$			

Mol. Conc.	Viscosity and Fluidity.							Temperature Coefficients (φ).	
	$D_{25^\circ/4^\circ}$	$\eta_{15^\circ}$	$\eta_{25^\circ}$	$\eta_{35^\circ}$	$\varphi_{15^\circ}$	$\varphi_{25^\circ}$	$\varphi_{35^\circ}$	15-25°	25-35°
0.25	1.0353	0.03800	0.02879	0.02312	26.32	34.73	43.25	0.0320	0.0245
.10	1.0292	.03522	.02711	.02169	28.39	36.89	46.10	.0299	.0252
Solv.	1.0249	.03373	.02576	.02091	29.65	38.82	47.87	.0309	.0232

In 50 per cent formamid and 50 per cent ethyl alcohol.

Γ	Molecular Conductivity.			Temperature Coefficients of Conductivity.			
				Per cent.		Conductivity Units.	
	15°	25°	35°	15-25°	25-35°	15-25°	25-35°
10 .....	20.95	24.74	29.92	0.0180	0.0209	0.379	0.518
50 .....	23.72	29.57	35.87	.0204	.0214	.485	.630
200 .....	25.87	32.09	39.03	.0240	.0216	.622	.694
400 .....	26.41	33.04	40.26	.0251	.0218	.663	.722
1600 .....	27.74	35.11	43.35	.0265	.0234	.737	.824
	$K = 0.75 \times 10^{-5}$		$0.93 \times 10^{-5}$	$1.21 \times 10^{-5}$			

Mol. Conc.	Viscosity and Fluidity.							Temperature Coefficients (φ).	
	$D_{25^\circ/4^\circ}$	$\eta_{15^\circ}$	$\eta_{25^\circ}$	$\eta_{35^\circ}$	$\varphi_{15^\circ}$	$\varphi_{25^\circ}$	$\varphi_{35^\circ}$	15-25°	25-35°
0.25	0.9457	0.02861	0.02219	0.01809	34.95	45.07	55.28	0.0289	0.0227
.10	.9392	.02623	.02083	.01674	38.12	48.01	59.74	.0259	.0244
Solv.	.9344	.02472	.01932	.01575	40.45	51.76	63.49	.0280	.0227

TABLE 51.—Lithium Nitrate—Continued.

In 25 per cent formamid and 75 per cent ethyl alcohol.

V	Molecular Conductivity.			Temperature Coefficients of Conductivity.			
				Per cent.		Conductivity Units.	
	15°	25°	35°	15-25°	25-35°	15-25°	25-35°
10 .....	19.61	23.81	28.12	0.0214	0.0181	0.420	0.431
50 .....	25.49	30.85	36.82	.0210	.0193	.536	.597
200 .....	28.57	34.84	41.53	.0219	.0192	.627	.669
400 .....	29.64	36.23	43.27	.0222	.0194	.659	.704
1600 .....	30.63	38.24	46.53	.0248	.0217	.761	.829
	$K = 0.64 \times 10^{-5}$			$0.74 \times 10^{-5}$		$0.94 \times 10^{-5}$	

Mol. Conc.	Viscosity and Fluidity.							Temperature Coefficients ( $\varphi$ ).	
	$D_{25^\circ/4^\circ}$	$\eta_{15^\circ}$	$\eta_{25^\circ}$	$\eta_{35^\circ}$	$\varphi_{15^\circ}$	$\varphi_{25^\circ}$	$\varphi_{35^\circ}$	15-25°	25-35°
0.25	0.8674	0.02123	0.01680	0.01397	47.10	59.52	71.58	0.0264	0.0203
.10	.8600	.01895	.01522	.01260	52.77	65.70	79.37	.0245	.0208
Solv.	.8547	.01755	.01411	.01172	56.98	70.87	85.32	.0244	.0204

TABLE 52.—Calcium Nitrate.

In 75 per cent formamid and 25 per cent ethyl alcohol.

Specific conductivity 25°. Formamid,  $1.62 \times 10^{-5}$ . Ethyl alcohol,  $1.41 \times 10^{-7}$ .

V	Molecular Conductivity.			Temperature Coefficients of Conductivity.			
				Per cent.		Conductivity Units.	
	15°	25°	35°	15-25°	25-35°	15-25°	25-35°
10 .....	31.02	39.41	48.39	0.0274	0.0227	0.839	0.898
50 .....	41.57	52.82	65.03	.0270	.0231	1.125	1.221
100 .....	44.79	56.99	70.15	.0272	.0231	1.220	1.316
200 .....	46.43	59.07	72.79	.0272	.0232	1.264	1.372
400 .....	48.90	61.92	76.56	.0266	.0236	1.302	1.464
1600 .....	49.36	61.57	78.40	.0269	.0273	1.321	1.683
	$K = 1.80 \times 10^{-5}$			$2.40 \times 10^{-5}$		$3.00 \times 10^{-5}$	

Mol. Conc.	Viscosity and Fluidity.							Temperature Coefficients ( $\varphi$ ).	
	$D_{25^\circ/4^\circ}$	$\eta_{15^\circ}$	$\eta_{25^\circ}$	$\eta_{35^\circ}$	$\varphi_{15^\circ}$	$\varphi_{25^\circ}$	$\varphi_{35^\circ}$	15-25°	25-35°
0.10	1.0362	0.03738	0.02834	0.02278	26.75	35.28	43.90	0.0310	0.0253
.01	1.0278	.03455	.02642	.02110	28.94	37.86	47.39	.0308	.0252
Solv.	1.0250	.03372	.02591	.02078	29.66	38.60	48.22	.0301	.0249



TABLE 52.—Calcium Nitrate—Continued.

In 50 per cent formamid and 50 per cent ethyl alcohol.

V	Molecular Conductivity.			Temperature Coefficients of Conductivity.			
				Per cent.		Conductivity Units.	
	15°	25°	35°	15-25°	25-35°	15-25°	25-35°
10	27.58	34.30	41.36	0.0243	0.0205	0.672	0.706
50	41.14	50.97	61.63	.0238	.0209	.983	1.066
100	43.18	53.30	64.60	.0234	.0213	1.012	1.130
200	49.54	61.66	74.50	.0244	.0208	1.212	1.284
400	52.03	65.14	78.41	.0251	.0203	1.311	1.327
1600	54.62	68.51	81.48	.0254	.0189	1.389	1.297
	$K = 1.50 \times 10^{-5}$			$1.90 \times 10^{-5}$	$2.40 \times 10^{-5}$		

Mol. Conc.	Viscosity and Fluidity.						Temperature Coefficients ( $\varphi$ ).		
	$D_{25^\circ/4^\circ}$	$\eta_{15^\circ}$	$\eta_{25^\circ}$	$\eta_{35^\circ}$	$\varphi_{15^\circ}$	$\varphi_{25^\circ}$	$\varphi_{35^\circ}$	15-25°	25-35°
0.10	0.9463	0.02774	0.02158	0.01755	36.05	46.34	56.98	0.0285	0.0230
.02	.9376	.02560	.01976	.01610	39.06	50.61	62.11	.0296	.0227
Solv.	.9342	.02475	.01934	.01567	40.40	51.71	63.82	.0280	.0234

In 25 per cent formamid and 75 per cent ethyl alcohol.

V	Molecular Conductivity.			Temperature Coefficients of Conductivity.			
				Per cent.		Conductivity Units.	
	15°	°	35°	15-25°	25-35°	15-25°	25-35°
10	19.48	23.37	27.72	0.0199	0.0185	0.389	0.435
50	32.03	38.2	45.07	.0192	.0177	.618	.686
100	37.69	45.08	52.78	.0196	.0170	.739	.770
200	43.17	51.78	60.70	.0199	.0172	.861	.892
400	48.19	57.93	68.35	.0202	.0179	.974	1.042
1600	55.88	67.36	79.66	.0205	.0182	1.148	1.230
	$K = 1.05 \times 10^{-5}$			$1.30 \times 10^{-5}$	$1.54 \times 10^{-5}$		

DISCUSSION OF RESULTS.

In tables 30 to 35, inclusive, are given the conductivity and viscosity data for the ammonium, sodium, potassium, calcium, barium, and strontium nitrates at the different temperatures studied. The conductance values at infinite dilution were reached at dilutions below M/600 for all except barium and calcium nitrates. Beyond this dilution no measurements were made, since in most cases the solvent correction becomes equal to or greater than one-half the observed conductances.

In table 53 a comparison is made of the conductances and dissociation of these nitrates in formamid with similar results in water as the solvent. While the two sets of results are based on different schemes of dilution (M/10 and M/8), the two concentrations are sufficiently close together to permit a general comparison. From the data in the table it appears that the molecular conductivity values for these nitrates in formamid are much smaller than in water, although the order of increasing conductivity is the same in both solvents.

The greater dissociating power of formamid as compared with water is also shown by the table. It is further illustrated by the fact that complete dissociation is reached by these salts at much lower dilution than in water. For example, sodium nitrate is completely dissociated in formamid at M/800, while in water this is not reached until M/2048.

TABLE 53.—Comparison of the Conductivity and Dissociation of the Alkali and Alkaline Earth Nitrates in Formamid and in Water at 25° C.

Nitrate.	Formamid.		Water.	
	M <sub>10</sub>	$\alpha$	M <sub>8</sub>	$\alpha$
Lithium....	21.88	87.0	84.7	79.5
Sodium.....	23.32	84.0	96.6	77.9
Potassium..	24.38	80.0	117.99	79.5
Rubidium..	25.59	90.0	125.54	....
Cæsium....	25.76	87.0	127.56	....
Ammonium..	28.00	87.0	120.65	82.0
Barium.....	36.93	63.0	155.62	61.1
Strontium..	39.24	69.0	164.34	64.6
Calcium....	39.50	68.0	167.21	64.8

Lithium nitrates crystallize with water of crystallization, while sodium, potassium, and ammonium nitrates do not. According to the theory of Jones and others, this is an indication that the lithium ion is more solvated in solution than are the ions of sodium, potassium, or ammonium. The effect of such solvation is that lithium ions move more slowly than those of the other alkali ions, and consequently the conductivities are much smaller. The solvate theory is a plausible explanation for the smaller conductivity values of lithium salts, regardless of the much smaller mass and atomic volume of lithium as compared with the other alkali metals.

The conductivities of the nitrates of barium, strontium, and calcium in formamid are analogous in every respect to the conductivity phenomena of these salts in water—*i. e.*, they show evidence for the formation of complexes with the solvent. As an indication of this, the temperature coefficients of conductivity expressed in conductivity units are higher for these salts than for the alkali nitrates, which have

little or no solvating power. This may be accounted for upon the basis of a decrease in the complexity of the solvate with rise in temperature, giving greater mobility to the ions.

The viscosities of the solutions of these nitrates in formamid increase in numerical value as we pass from the alkalis to the alkaline earths—*i. e.*, the effect of the anion being the same, the viscosity varies with the size of the cation, the increase in viscosity being less in the case of the salts of cæsium, rubidium, and ammonium and becoming greater as we pass through those of potassium and sodium to calcium, barium, and strontium. There are two ways of viewing this phenomenon. From the standpoint of the theory of Jones and Veazey, the smaller increment in the viscosity of the solvent caused by the salts of the first three alkali metals is due to their large atomic volume, which produces a decrease in the total fractional surfaces of the particles in a given volume of the solution. On the other hand, it has been shown that substances with the largest molecules give the *greatest increase* in the viscosity of the medium and that by increasing the complexity of the solvent the viscosity of the solution becomes greater. From this standpoint it would appear that the small increment in the viscosity of formamid caused by salts of cæsium, rubidium, and ammonium is due to the slight solvation of their cations, while the greater value obtained for the other alkalis and for the salts of the alkaline earths is due to the increase in the complexity of the solute due to solvation, the resulting complex being larger than the non-solvated ions of the alkali metals. Previous work in this laboratory has supported the view of Jones and Veazey, but the work in mixed solvents containing formamid to be discussed later seems to favor the latter hypothesis.

TABLE 54.—Comparison of Conductivity and Dissociation of Formates in Formamid and in Water at 25° C.

Formate.	Formamid.		Water. <sup>1</sup>	
	M <sub>50</sub>	$\alpha$	M <sub>52</sub>	$\alpha$
Rubidium . .	16.97	98.0	.....	.....
Lithium . . . .	21.22	89.4	.....	.....
Sodium . . . .	22.64	93.8	138.4	87.9
Ammonium . .	28.09	92.9	.....	.....
Strontium . .	41.54	76.0	.....	.....
Barium . . . .	43.48	84.0	170.7	76.5

<sup>1</sup>Carnegie Inst. Wash. Pub. Nos. 170 and 230.

A glance at table 54 will show that these salts of a strong organic acid exhibit similar characteristics in formamid to the nitrates—*i. e.*, they are more strongly dissociated at low dilutions than in water, although the actual conductance is much less. The temperature

coefficients of conductivity expressed in conductivity units (see tables 36 to 41) are all of the same order of magnitude for the alkalis, but again are larger in the case of the alkaline earths.

Owing to the limited solubility of these salts in formamid, viscosity measurements were made only on the alkali formates. Rubidium and ammonium formates increase the viscosity of the solvent to a less extent than do sodium and lithium formates; this behavior being analogous to that of the nitrates.

TABLE 55.—*Comparison of Conductivity and Dissociation of Sodium Salts of Organic Acids in Formamid and in Water at 25° C.*

Sodium Salt.	Formamid.		Water. <sup>1</sup>	
	M <sub>50</sub>	$\alpha$	M <sub>32</sub>	$\alpha$
m-brombenzoic acid.....	13.92	....	67.2	....
1, 3, 5 di-nitrobenzoic acid....	13.95	....	....	....
m-aminobenzoic acid.....	14.34	....	65.9	....
Benzoic acid.....	15.03	....	68.7	....
Salicylic acid.....	15.51	....	68.3	....
Benzene sulphonic acid.....	15.87	76.0	69.1	....
Succinic acid.....	28.71	....	81.7	....

<sup>1</sup>Bull. Imp. Acad. Sci. St. Petersburg (1911). Translation in German.

Table 55 brings out very clearly that the conductance capacity of the first three salts is approximately equal, and the same is true of the next three. All of the monobasic salts have very nearly the same conductance, while the dibasic salt, being a ternary electrolyte, has about twice their conductance. The same fact is brought out by the recent work of Lloyd and Pardee in their data for conductivity in pure alcohol. (See Chapter III.)

The conductivity of the first three salts in the table showed a remarkable increase in dilute solutions. The sodium salts of these organic acids tend to increase in conductivity upon standing. Apparently no relation is brought out by the conductivity values in regard to the constitution of the organic salts.

An attempt was made to measure the conductivity of benzoic and salicylic acids in formamid, with the result that the conductivity values increased at the rate of about one integer an hour. Walden, however, has measured the conductivity of some aliphatic acids and does not mention this phenomenon.

The viscosity values (see tables 42 to 48) for solutions of these organic salts in formamid are all of the same order of magnitude, with the exception of sodium succinate, a ternary electrolyte, which gives larger values. As in the case of the conductivity data, there is little evidence for any relation between viscosity and constitution, although the viscosity appears to become greater with increasing complexity of the acid.

Tables 49 to 52 show the molecular conductivity and viscosity of tetraethyl ammonium iodide, rubidium iodide, lithium nitrate, and calcium nitrate in binary mixtures containing formamid and ethyl alcohol. In table 56 a comparison is made at 25° between the conductivities in these mixtures and in the pure solvents.

TABLE 56.—Comparison of Molecular Conductivity in Mixtures of Formamid and Ethyl Alcohol at 25°.

	$\nu$	HCONH <sub>2</sub> 100 p. ct.	HCONH <sub>2</sub> 75 p. ct.	HCONH <sub>2</sub> 50 p. ct.	IICONH <sub>2</sub> 25 p. ct.	C <sub>2</sub> H <sub>5</sub> OH 100 p. ct.
Tetraethyl ammonium iodide.....	10	20.31	25.70	27.92	27.86	Insol.
	50	22.69	29.76	34.01	35.56	"
	100	23.79	31.44	36.71	39.41	"
	200	24.28	31.69	37.21	41.34	"
	400	.....	31.95	38.64	43.79	"
	1,600	.....	31.95	.....	46.08	"
Rubidium iodide.....	10	24.00	28.45	30.64	29.98	"
	50	25.27	31.45	35.41	37.06	"
	100	26.06	32.78	36.75	39.85	"
	200	26.41	33.04	37.69	41.44	"
	400	.....	33.48	38.47	42.73	"
	1,600	.....	34.12	39.77	44.54	"
Lithium nitrate.....	10	20.58	23.70	24.74	23.81	18.25
	50	22.29	27.07	29.57	30.85	26.47
	200	23.66	28.83	32.09	34.84	32.31
	400	23.63	29.08	33.04	36.23	34.12
	1,600	.....	29.04	35.11	38.24	37.63
Calcium nitrate.....	10	39.50	39.41	34.30	23.37	8.36
	50	48.56	52.82	50.97	38.21	15.83
	100	52.98	56.99	53.30	45.08	19.56
	200	54.89	59.07	61.66	51.78	23.81
	400	55.90	61.92	65.14	57.93	25.19
1,600	58.54	61.57	68.51	67.36	35.40	

<sup>1</sup>Carnegie Inst. Wash. Pub. No. 80, 84.

<sup>2</sup>*Ibid.*, 97.

One of the most important facts brought out in this table is that tetraethyl ammonium iodide, rubidium iodide, and lithium nitrate show an increase in molecular conductivity up to a concentration of 25 per cent formamid and 75 per cent ethyl alcohol mixture. Lithium nitrate was the only salt of these three whose conductivity values in ethyl alcohol were available, and as these values are about of the same order of magnitude as those in pure formamid, it appears that a *maximum* is reached in conductivity. This relation interpreted in terms of previous work on other solvents means that there is an increase either in the mobility of the ions or in the dissociation in mixtures with 75 per cent ethyl alcohol and 25 per cent formamid, or both. From the viscosity data discussed below the first assumption seems to be the most probable.

The viscosities of mixtures of formamid with ethyl alcohol as well as those with water show only a slight deviation from the normal values for mixtures, being always somewhat less than the calculated, giving rise to a sagged curve. This has been observed by Merry and Turner,<sup>1</sup> who studied the viscosities of binary mixtures of formamid with methyl and ethyl alcohols and with water. They have shown this deviation to be due to decrease in the association of one or the other components or of both. It is not possible to account for this phenomenon by the theory of Jones and Veazey, since from this standpoint a maximum in the viscosity curve would be expected.

The conductivity values for mixtures containing calcium nitrate give evidence of greater variation than the other salts in analogous mixtures. It is seen in table 56 that the maximum in the values for molecular conductivity does not occur in 25 per cent formamid and 75 per cent ethyl alcohol mixtures as for the other salts, but the maxima appear in the concentrated formamid mixture and in the concentrated solutions. The conductivity is greater in the 75 per cent to 25 per cent mixture than in the formamid itself.

The viscosity of the solutions of the four salts studied in these mixtures are all greater than those of the solvents. The change in the association of the two components is evidently so slight that apparently the size of these molecular aggregates is always greater than that of the molecules or ions of the solute. Rubidium and tetraethyl ammonium iodides have about the same effect on the viscosity of these mixtures. Lithium nitrate and calcium nitrate produce a much larger increment in these mixed solvents analogous to that in pure formamid. The actual increase in the viscosity of the mixtures for any one salt becomes greater in passing from the mixture containing the larger percentage of formamid to that containing the larger percentage of alcohol.

A few measurements were made on the viscosity of mixtures of formamid and water, the results confirming those obtained by Merry and Turner<sup>2</sup>—*i. e.*, the viscosities for these mixtures show a much greater deviation from the law of mixtures than do mixtures of formamid and alcohol, their viscosities being much less than those calculated from averages. Cæsium, rubidium, and potassium salts lower the viscosity of water, but increase that of formamid. Therefore a curve for the viscosities of solutions of these salts in formamid-water mixtures would cross that of the solvent. A study of such curves would yield some interesting results and probably furnish a means of determining the validity of the hypothesis of Jones and Veazey, which has been questioned recently.<sup>3</sup> It is hoped that we may be able to take up this problem at some future time.

<sup>1</sup>Journ. Chem. Soc., **106**, 748 (1914).

<sup>2</sup>Journ. Chem. Soc., **106**, 748 (1914).

<sup>3</sup>*Cf.* Bramley: The Study of Binary Mixtures. Journ. Chem. Soc., **109**, 462 (1916).

## CHAPTER III.

### A NOTE ON THE VISCOSITY OF CÆSIUM SALTS IN GLYCEROL-WATER MIXTURES.

BY P. B. DAVIS.

The study of the viscosity of solution in glycerol and in binary mixtures containing glycerol was begun in this laboratory by Schmidt and Jones<sup>1</sup> a number of years ago. They noted that among the salts measured potassium-iodide solutions lowered the viscosity of water and mixture of glycerol and water up to 50 per cent glycerol, although this salt increased the viscosity of pure glycerol.

Guy and Jones<sup>1</sup> extended this work in connection with a study of the conductivity and dissociation of electrolytes in glycerol as a solvent and noted that solutions of sodium nitrate, ammonium bromide and iodide, and rubidium iodide all lowered the viscosity of pure glycerol and of its mixtures with water.

These results led Davis and Jones<sup>1</sup> to investigate the behavior of glycerol of those salts known to decrease the viscosity of water. They measured the viscosity of solution of certain rubidium and ammonium salts in pure glycerol and in mixtures of glycerol with water and found that the salts of rubidium and ammonium iodide produced a phenomenal lowering of the viscosity of glycerol, the molecular conduc-

TABLE 57.—*Viscosity and Fluidity of Cæsium Chloride.*

	Mol. Conc.	η <sub>25°</sub>	η <sub>35°</sub>	φ <sub>25°</sub>	φ <sub>35°</sub>	Temp. Coeff. (φ). 25–35°
In 75 per cent glycerol with water.....	{ 0.5	0.3092	0.1945	3.234	5.141	0.590
	.25	.3184	.1983	3.141	5.043	.606
	.10	.3242	.2016	3.085	4.960	.608
	Solv.	.3303	.2207	3.028	4.531	.496
In 50 per cent glycerol with water.....	{ 0.50	0.05974	0.04336	16.74	23.06	0.378
	.25	.06127	.04477	16.32	22.34	.369
	.10	.06189	.04478	16.16	22.33	.388
	Solv.	.06255	.04536	15.99	22.05	.379
In 75 per cent glycerol with water.....	{ 0.50	0.02019	0.01597	49.53	62.62	0.264
	.25	.02052	.....	48.73	.....	.....
	.10	.02063	.01619	48.47	61.77	.274
	Solv.	.02070	.01260	48.31	61.73	.278

<sup>1</sup>Carnegie Inst. Wash. Pub. No. 180.

tivity of these salts being materially increased in concentrated solutions on account of the greater fluidity of the solution.

In order to complete the series of salts lowering the viscosity of these solvents, caesium compounds remained to be measured. A supply of caesium carbonate was finally obtained and converted into the nitrate and chloride. The viscosities of these salts have already been measured in water and in mixtures of water with methyl alcohol, ethyl alcohol, and acetone. Tables 57 and 58 give similar results in mixtures of glycerol and water. The viscosities were measured in the apparatus described in the preceding chapter on formamid.

TABLE 58.—*Viscosity and Fluidity of Caesium Nitrate.*

	Mol. Conc.	$\eta_{25^\circ}$	$\eta_{35^\circ}$	$\varphi_{25^\circ}$	$\varphi_{35^\circ}$	Temp. Coeff. ( $\varphi$ ). 25–35°
In 75 per cent glycerol with water.....	0.25	0.3089	0.1933	3.237	5.173	0.598
	.10	.3207	.1990	3.118	5.025	.612
	Solv.	.3303	.2207	3.028	4.531	.496
In 50 per cent glycerol with water.....	0.50	0.05774	0.04223	17.32	23.68	0.367
	.25	.06043	.04407	16.55	22.69	.371
	.10	.06149	.04443	16.26	22.51	.384
	Solv.	.06255	.04536	15.99	22.05	.379
In 25 per cent glycerol with water.....	0.50	0.01981	0.01566	50.48	63.86	0.265
	.25	.02031	.01611	49.24	62.07	.261
	.10	.02056	.01615	48.64	61.92	.273
	Solv.	.02070	.01615	48.31	61.92	.282

It will be seen from tables 57 and 58 that caesium salts decrease the viscosities of glycerol-water mixtures, the decrement being greater, however, than in the case of rubidium salts. It should also be noted that when salts of both metals increase the viscosity of a solvent, as in the case of certain mixtures of water with acetone and the alcohols, the caesium salts produce a smaller increment than rubidium salts.



## CHAPTER IV.

### A STUDY OF THE ELECTRICAL CONDUCTANCE OF THE SODIUM SALTS OF CERTAIN ORGANIC ACIDS IN ABSOLUTE ETHYL ALCOHOL AT 15°, 25°, AND 35°.

---

BY H. H. LLOYD AND A. M. PARDEE.

---

#### INTRODUCTION.

In the Johns Hopkins laboratory, for some years past, a comprehensive study has been made of the electrical conductance and dissociation of various organic acids in aqueous solution.<sup>1</sup> This work was extended to absolute-alcohol solutions by Wightman, Wiesel, and Jones,<sup>2</sup> and by Lloyd, Wiesel, and Jones.<sup>3</sup> These investigators were unable to obtain, or even to approach, experimentally  $\Lambda_0$ , the equivalent conductance at zero concentration. The authors have therefore investigated the behavior of the sodium salts of the organic acids in absolute alcohol in order to obtain first the  $\Lambda_0$  values for these salts and then, by substitution in the Kohlrausch equation,<sup>4</sup> the  $\Lambda_0$  values for the acids themselves. The writers are interested also in the accumulation of accurate conductance data, as well as in such questions as temperature coefficients of conductance, conductance in relation to chemical constitution, limits of experimental accuracy in working with dilute solutions in absolute alcohol, and the general phenomenon of alcoholysis.

#### HISTORICAL.

The measurement of the electrical conductance of the sodium salts of organic acids in absolute alcohol up to the present time has received but scant attention. With few exceptions, all investigations were incidental in nature and the compounds studied were chosen simply as types of organic salts.

Dutoit and Rappeport,<sup>5</sup> in a study of the limiting conductances of some electrolytes in absolute alcohol, measured sodium acetate, among other salts, evidently taking the same as an example of the salts of organic acids. They subjected their results to some rather interesting deductions, but their conductances were measured at 18°, mak-

---

<sup>1</sup>Carnegie Inst. Wash. Pub. No. 170, part II; No. 210, chap. II.

<sup>2</sup>Carnegie Inst. Wash. Pub. No. 210, chap. III; Journ. Amer. Chem. Soc. **36**, 2243 (1914).

<sup>3</sup>Carnegie Inst. Wash. Pub. No. 230, chap. VII; Journ. Amer. Chem. Soc. **38**, 121 (1916).

<sup>4</sup>W. Ostwald: Zeit. physik. Chem., **2**, 561 (1888); **3**, 170 (1889); Amer. Chem. Journ. **46**, 66 (1914).

<sup>5</sup>Jour. chem. Phys. **6**, 545 (1908).

ing exact comparison with those at 25° an impossibility. They interpreted their results in a manner similar to that of Goldschmidt, and so their deductions are really illustrated in the latter's communication.

Dhar and Bhattacharyya<sup>1</sup> carried on some work in alcohol with various salts and studied among others the following organic derivatives: sodium propionate, sodium benzoate, and sodium salicylate. Their measurements at odd concentrations and temperatures render comparison impossible.

Heinrich Goldschmidt,<sup>2</sup> incidental to his study of the esterification of organic acids in absolute alcohol, found it necessary to measure the conductances at 25° of a number of sodium salts of these acids. The salts were made by neutralizing the alcoholic solutions of the acids with an alcoholic solution of sodium ethylate. Goldschmidt measured the conductances from N/10 to N/5120 concentrations, and the values determined for five different salts are shown in tables 59 to 63. These results are given to enable us to discuss them and the deductions leading from them, as well as to point out later wherein we differ from him as to certain conclusions. These salts are sodium trichloroacetate, dichloroacetate, picrate, salicylate, and sulphosalicylate. There is appended to each table his calculation of  $\Lambda_0$  for the salt at specified dilutions.

TABLE 59.—Sodium Trichloroacetate.

V	$\Lambda_I$	$\Lambda_{II}$
10	11.07	.....
20	13.95	.....
40	17.27	17.33
80	20.99	20.96
160	24.94	25.12
320	28.83	29.04
640	32.39	32.50
1280	35.28	35.29
2560	37.61	37.48
5120	39.23	38.92

$$\Lambda_0 \frac{1}{2}(320-1280) = 46.10$$

$$\Lambda_0 \frac{1}{2}(640-2560) = 46.20$$

$$\Lambda_0 \frac{1}{2}(1280-5120) = 45.52$$

$$\text{Mean } \Lambda_0 = 46$$

TABLE 60.—Sodium Dichloroacetate.

V	$\Lambda_I$	$\Lambda_{II}$	$\frac{1}{2} \Lambda_{III}$
10	.....	.....	9.85
20	.....	.....	12.64
40	16.11	15.95	15.86
80	19.78	19.59	19.53
160	23.78	23.65	23.54
320	28.00	27.70	27.52
640	31.96	31.51	31.49
1280	35.66	34.87	34.96
2560	38.42	37.74	38.02
5120	.....	40.71	40.86

$$\Lambda_0 \frac{1}{2}(320-1280) = 48.54 \quad \text{I}$$

$$\Lambda_0 \frac{1}{2}(640-2560) = 49.43 \quad \text{I}$$

$$\Lambda_0 \frac{1}{2}(320-1280) = 47.68 \quad \text{II}$$

$$\Lambda_0 \frac{1}{2}(640-2560) = 48.36 \quad \text{II}$$

$$\Lambda_0 \frac{1}{2}(1280-5120) = 50.64 \quad \text{III}$$

$$\Lambda_0 \frac{1}{2}(320-1280) = 47.36 \quad \text{III}$$

$$\Lambda_0 \frac{1}{2}(640-2560) = 49.14 \quad \text{III}$$

$$\Lambda_0 \frac{1}{2}(1280-5120) = 50.90 \quad \text{III}$$

$$\text{Value } \Lambda_0 = 52$$

<sup>1</sup>Zeit. anorg. Chem. 82, 357 (1913).<sup>2</sup>Zeit. physik. Chem. 89, 129 (1914); 91, 46 (1916).

TABLE 61.—Sodium Salicylate.

V	$\Lambda$
10	9.57
20	12.21
40	15.27
80	18.78
160	22.67
320	26.58
640	30.14
1280	33.20
2560	35.48
5120	36.29

$$\Lambda_0 \text{ (320-1280)} = 44.58$$

$$\Lambda_0 \text{ (640-2560)} = 44.7$$

$$\Lambda_0 \text{ (1280-5120)} = 41.55$$

Most probable value = 44.5

TABLE 62.—Sodium Sulphosalicylate.

V	$\Lambda_I$	$\Lambda_{II}$	Mean.
40	13.56	13.54	13.5
80	16.72	16.74	16.7
160	20.21	20.18	20.2
320	23.76	23.69	23.7
640	27.06	27.02	27.0
1280	30.0	30.03	30.0
2560	32.22	32.23	32.2
5120	33.84	34.12	34.0

$$\Lambda_0 \text{ (320-1280)} = 40.7$$

$$\Lambda_0 \text{ (640-2560)} = 41.1$$

$$\Lambda_0 \text{ (1280-5120)} = 40.8$$

$$\Lambda_0 = 40.9$$

TABLE 63.—Sodium Picrate.

V	$\Lambda_I$	$\Lambda_{II}$
40	18.04	18.14
80	22.06	22.11
160	26.34	26.34
320	30.61	30.64
640	34.59	34.59
1280	37.94	38.07
2560	40.43	40.65
5120	42.03	42.75

$$\left. \begin{aligned} \Lambda_0 \text{ (320-1280)} &= 50.42 \\ \Lambda_0 \text{ (640-2560)} &= 50.10 \\ \Lambda_0 \text{ (1280-5120)} &= 48.99 \end{aligned} \right\} \text{I}$$

$$\left. \begin{aligned} \Lambda_0 \text{ (320-1280)} &= 50.72 \\ \Lambda_0 \text{ (640-2560)} &= 50.97 \\ \Lambda_0 \text{ (1280-5120)} &= 50.72 \end{aligned} \right\} \text{II}$$

Selected value = 51

Goldschmidt thought that it was evident, after carrying his dilutions to 5,120 liters, that  $\Lambda_0$  could not be reached by ordinary experimental methods. He attempted to calculate  $\Lambda_0$  for these organic salts and expected to obtain the relative velocity of the organic anion from the salt and introduce the same into the equation

$$\Lambda_0 = a + c$$

To determine  $\Lambda_0$  for the organic salt he made use of the Kohlrausch formula<sup>1</sup>

$$\Lambda_0 = \Lambda + a \sqrt[3]{\frac{1}{v}}$$

in which  $\Lambda_0$  is the unknown conductance at infinite dilution,  $\Lambda$  the conductance at a known dilution  $v$ , and  $a$  an unknown constant. Two equations involving the use of different  $\Lambda$  values are equated, the  $\Lambda_0$  being the same in both cases, and the expression solved for the value  $a$ . Once having this, it is a simple matter to solve for  $\Lambda_0$  in one of the two

<sup>1</sup>Wied. Ann. 26, 161 (1885).

original equations. By reference to the tables quoted above we can observe how such values are derived. It is to be noticed that alternate  $\Lambda$  values are equated. This is done so that the difference may be of sufficient degree of magnitude and that any inaccuracy in an individual measurement may not affect two successive derivations.

A glance at the tables and calculations will show that the calculated values of  $\Lambda_0$  are by no means concordant. The higher the value of  $\Lambda$  used in the equation, the lower becomes the calculated  $\Lambda_0$ . His final conclusions are vague and inconclusive. The value chosen for  $\Lambda_0$  must be regarded as only approximate; it was usually the highest possible.

Goldschmidt seems to have overlooked the very exact and admirable piece of work done on the subject of the limiting conductance and degree of ionization of alcoholic solutions by B. B. Turner<sup>1</sup> in the Johns Hopkins laboratory. Turner carried his dilutions to far greater limits, as table 64 illustrates. We have repeated this work and have every reason to believe that it is unquestioned and is remarkably accurate, especially when one considers that it was done without the more recent conductivity apparatus now at our disposal.

Turner showed that up to 5,000 liters dilution it is easy to obtain concordant results; but the values for  $\Lambda_0$  as calculated according to the Kohlrausch method are not constant for these higher dilutions. Like those of Goldschmidt, they decrease the higher the values of  $\Lambda$  used in the equation. Turner also showed that plotting  $\Lambda$  against the reciprocal of the cube root of the volume does not give a straight line as in aqueous solutions of equal dilutions, but rather a smooth curve slightly convex towards the dilution axis. He therefore assumed that the Kohlrausch method fails to answer the requirements of absolute alcoholic solutions. Extrapolation of his results with the formula would give us a value of 56 for  $\Lambda_0$  instead of the experimental value of 48.5 obtained. He thought that accidental introduction of water into his solutions might affect the readings, and to test this he added as much as 0.2 to 0.3 per cent of water by weight to his alcoholic solutions, with a variation in conductivity of only  $0.01 \times 10^{-6}$  units, showing that no accidental experimental error of this nature had crept in.

Furthermore, Dutoit and Rappeport<sup>2</sup> showed identically the same phenomenon with a number of inorganic salts in work to which reference has already been made (page 99). This work, like that of Turner,

TABLE 64.—*KI in Absolute Alcohol Conductances in mhos at 25°.*

V	$\Lambda$
10	22.2
12	23.0
16	24.1
32	27.5
64	31.1
128	35.0
250	38.2
500	41.4
1000	44.0
5000	47.8
10000	48.4
20000	48.5
$\infty$	48.5 $\pm$ 0.5

<sup>1</sup>Amer. Chem. Journ. 40, 558 (1908).

<sup>2</sup>Journ. chem. Phys. 6, 545 (1908).

seems to have escaped the notice of Goldschmidt, as he does not mention either piece of work in any of his papers.

In other words, the problem as undertaken by Goldschmidt is very incomplete from this standpoint. No reason can be given why he should use arbitrarily chosen limits for  $v$  in applying the Kohlrausch formula, nor is it shown how accurately measured conductances up to 20,000 liters dilution can be reconciled with such a falling-off in the calculated  $\Lambda_0$  for the salt.

Whether such a method could be applied or not, or whether another can be substituted in its place, is a question of very great importance. Furthermore, Goldschmidt based his conclusions on the results of only six or seven salts. It was therefore deemed advisable by the present writers, in the first place, to obtain more conductance data on a larger number of salts, and, in the second place, to make these measurements at several temperatures in order to look at this subject in a broad way.

## EXPERIMENTAL.

### REAGENTS.

The alcohol used in this investigation was prepared in the following manner: Ordinary 95 per cent ethyl alcohol was heated for several days with lime in a copper tank with a glass condenser attached. A minimum of refluxing in the condenser was obtained by inserting into the tank through the stopper a coil of 3/16-inch lead-pipe containing running water and serving to cause condensation immediately below the reflux tube. The alcohol was distilled off, using a glass still-head with a bulb blown in it and containing glass wool soaked in alcohol in order to prevent any dusting over of the dry calcium hydroxide. The middle fraction was treated in the same manner as above and again fractionated. This process was continued until a specific gravity of 0.78507 was obtained, the extreme limits of variation being 0.78505 to 0.78510, which, according to Circular No. 19 of the Bureau of Standards, corresponds to a purity of from 100 to 99.987 per cent. The specific conductance of the alcohol varied with the different samples from 0.46 to  $1.6 \times 10^{-7}$  mhos. Upon the final distillation the alcohol was collected in a 6-liter alcohol-extracted Jena bottle with a sealed stopper carrying a siphon for drawing off the liquid, a calcium chloride-soda lime tube, and an adapter with a ground-glass stopcock. Alcohol prepared and stored in this manner, after several days following the distillation, remained practically unchanged as to its conductance for a period of several weeks. It was found that our discarded alcoholic solutions and washings, when distilled once in a glass vessel with a few drops of concentrated sulphuric acid before the final lime treatment, produced a very superior grade of "absolute" alcohol, being generally better than that obtained from fresh supplies of the 95 per cent material.

The organic salts used in this investigation were prepared by adding the necessary amount of sodium ethylate in absolute alcohol to the organic acid in alcoholic solution, as advised by Goldschmidt and previously mentioned in the historical section (page 100). The acids employed were taken from the various samples purified in the work of Lloyd, Wiesel, and Jones. When such were lacking new material was obtained from well-known firms and purified in the following manner: Whenever possible the acid was recrystallized from hot absolute-alcoholic solution, but when necessary a small amount of water was added. In every case the fractionation was carried out several times. The halogen-substituted aliphatic acids were fractionally crystallized from hot benzol, placed in a sulphuric-acid desiccator, and the final traces of benzol were removed by introducing into the container pieces of paraffine, which acted as an absorbent for the solvent. To purify the liquid aliphatic acids we resorted to both fractional crystallization by means of a refrigerant and repeated distillations under reduced pressure, in the latter case collecting the various fractions in a specially constructed receiver for small quantities.

The ethylate was prepared as needed in the following manner, as suggested by J. H. Shrader:<sup>1</sup> A special grade of metallic sodium, free from other metals, was wiped carefully with filter paper, the approximate amount was pared to fresh surfaces, and in small pieces was put first in a good grade of alcohol, then transferred into some conductivity alcohol for final washing, and finally dropped into a measuring flask of the best alcohol, so that upon solution it could be made up to the mark. With practice it was possible to estimate successfully the amount of sodium to produce a nearly N/10 solution. This solution was standardized and used within an hour or two for the salt preparation. It was found necessary to use the ethylate immediately, as evidences of decomposition giving a straw color to the solution appeared within 24 hours of its preparation, and even sooner in the case of more concentrated solutions.

This ethylate solution was immediately standardized by means of an N/10 aqueous solution of hydrochloric acid. This latter reagent was prepared by the method of Hulett and Bonner,<sup>2</sup> lately extended by Hendrixson.<sup>3</sup> As a check on this solution four series of silver chloride gravimetric analyses were made at various times throughout the year, none of which varied more than 0.1 per cent.

Phenolphthalein served as the indicator for the various titrations, special precautions—noted in a later paragraph—being used to prevent the interference of carbon dioxide from the atmosphere. As a final proof of the correctness of our choice of indicators, the ethylate was standardized with hydrochloric acid, using in this case methyl red as

<sup>1</sup>J. H. Shrader: Dissertation, Johns Hopkins University 14-16 (1913).

<sup>2</sup>Journ. Amer. Chem. Soc. **31**, 390 (1909).

<sup>3</sup>Journ. Amer. Chem. Soc. **37**, 2352 (1915).

an indicator, and it showed results concordant with the phenolphthalein values previously obtained. The methyl red naturally was useless in the titration of most of the organic acids, so its use was abandoned after proving the value of the phenolphthalein procedure.

In order to dry completely our various pieces of apparatus, acetone was used, as suggested by Barnebey.<sup>1</sup> The acetone was dehydrated over calcium chloride and then redistilled.

#### APPARATUS.

The cylindrical type of conductivity cells was used in all save the more concentrated solutions, where the ordinary plate type was adopted. The reason for using the cylindrical cell lies in the fact that the organic salts in absolute alcohol, although having greater conductance than the organic acids, are nevertheless of sufficient resistance to warrant such a procedure. White<sup>2</sup> and Wightman<sup>3</sup> have described the method for obtaining the constants of these cells.

Both the temperature coefficients of expansion of alcohol and the temperature coefficients of conductance of substances in it as a solvent are so large that it was especially necessary to maintain the solutions at a constant temperature to within 0.01°. The thermometers were of the differential Beckmann type and were carefully compared with a standard Reichsanstalt instrument which had in turn been calibrated at the Bureau of Standards. The combined gas-regulator and thermo-regulator was devised by Davis and Hughes.<sup>4</sup> The improved form of constant-temperature bath, as devised by Davis,<sup>5</sup> was used in our investigation. These baths are capable of even finer temperature adjustment than that stated above as employed in our work.

The resistance-box used throughout this work was calibrated at the Bureau of Standards. The improved Kohlrausch slide-wire bridge was employed, by means of which it was possible to read distances on the slide wire corresponding to tenths of a millimeter (the total length of the wire being 5 meters). Special precautions were taken to remove all external resistance in the circuit. No. 10 B. & S. insulated copper wire was used, and all leads coming to the bridge were dipped into a mercury-contact rocking commutator.

In the volumetric work Jena flasks were employed (50, 100, 200, 250, 500, 1,000 c.c.) which had been previously calibrated in this laboratory and recalibrated by ourselves, using weight methods. Reichsanstalt double-mark pipettes were recalibrated before use. In filling and draining the pipette the following device was suggested by Dr. Davis. It consisted of a right-angled T-tube with a glass stopcock on the base of the T, the pipette being attached by rubber to one end of

<sup>1</sup>Journ. Amer. Chem. Soc. **37**, 1835 (1915).

<sup>2</sup>Amer. Chem. Journ. **42**, 527 (1909).

<sup>3</sup>Amer. Chem. Journ. **44**, 64 (1911).

<sup>4</sup>Zeit. physik. Chem. **85**, 519 (1913).

<sup>5</sup>Carnegie Inst. Wash. Pub. No. 210, 21 (1914).

the cross-piece, held vertically with the regulating finger on the opposite end of the cross-piece. The control finger is maintained throughout the operation at this opening and the danger of contamination by suction is removed. A tube filled with a mixture of calcium chloride and soda lime is inserted in the rubber tube leading from the glass stop-cock on the base of the T to the mouth, for obvious reasons. The 50 c.c. burettes adopted were calibrated at 2 c.c. intervals by weight.

In order to titrate with phenolphthalein in an atmosphere free from carbon dioxide the following apparatus was constructed, partially as suggested by Hendrixson:<sup>1</sup> A carboy was connected to an ordinary tire pump and served as a gas reservoir. The air was led through three wash bottles, the first containing concentrated potassium hydroxide solution, the second a more dilute solution, and the third pure water. The titration was effected in an Erlenmeyer flask closed with a rubber stopper, which in turn was fitted loosely around the burette tip, serving in this way as a vent for the stream of air passed slowly through the solution.

The difficulty in desiccating our acids when once purified was solved by means of a vacuum drying-oven designed by Dr. Davis and constructed with the help of the authors (see Chapter II). In this apparatus the lamp heating-unit maintained a temperature of 65° and an ordinary suction-pump kept a reduced pressure of 70 to 80 mm., so it is easily seen that with the added help of a strong dehydrating agent, such as sulphuric acid or phosphorus pentoxide, all traces of the crystallizing solvent could be removed, since water boils at about 47° at this pressure. In proof of this practically all the organic acids titrated theoretically.

#### PROCEDURE.

The sodium ethylate was standardized by titration with N/10 HCl in a carbon-dioxide-free atmosphere, as described previously. When the ethylate was standardized, the organic acid from which the salt was to be made was weighed out in quantity sufficient to give 100 c.c. N/10 salt solution and this weight was confirmed by titration, which showed a very general concordance, giving added proof of the purity of the acids. In dealing with very deliquescent substances, as trichloroacetic acid for example, we weighed by difference, making approximate standard solutions rather than exactly N/10 strengths; but even in this case we obtained confirmation of our work. The non-deliquescent, crystalline acids were weighed on a watch crystal, the deliquescent ones in glass-stoppered weighing bottles; but in both cases the acids were washed through a funnel into the 100 c.c. measuring flasks with conductivity alcohol and made up to mark at 25°. Several

---

<sup>1</sup>Journ. Amer. Chem. Soc. 37, 2352 (1915).



salts of N/50 dilution were made up in this same manner at the beginning of our work, but this dilution was omitted later as unnecessary.

Let us notice a few of the necessary steps in the titrations. All such were made in 70 c.c. solution (50 c.c. water, 10 c.c. acid, and approximately 10 c.c. ethylate). The carbon-dioxide-free air was allowed to bubble through the solution for 2 minutes before titration. It was found that the presence of some alcohol retarded the end-point and a number of titrations were made throughout the year to enable us to correct for this. We found as a result of our work:

70 c.c. water and 0 c.c. alcohol required 0.03 c.c. to produce color.

60 c.c. water and 10 c.c. alcohol required 0.04 c.c.

50 c.c. water and 20 c.c. alcohol required 0.05 c.c.

Therefore it was necessary to apply this correction, as our accuracy in titration was made to check to 0.02 c.c.

After calculating the amounts necessary, 100 c.c. N/100 salt solution in absolute alcohol at 25° was prepared, placed in a 150 c.c. glass-stoppered Erlenmeyer flask, and sealed with rubber cement until the conductances were to be determined. It was possible to make up three or four different mother solutions of various organic salts in one day, another day being devoted to the dilution down to weaker concentrations, measurement of the conductances, and calculation of results for each salt. These last three operations on a single salt at various dilutions we have designated as a "run."

It is deemed advisable at this point to introduce an example of the calculations upon which a single salt was prepared as described above:

Acid orthonitrobenzoic,  $C_7H_5O_4N$ .

Strength of standard HCl, 0.10027.

I. *Standardization of the Ethylate.*  
10.005 c.c. HCl used in each titration.

II. *Standardization of the Organic Acid.*  
10.005 c.c. acid used in each titration.

Ethylate burette.

Ethylate burette.

Readings.	Corrected.	Difference.
c.c.	c.c.	c.c.
2.77	2.76	....
10.84	10.83	8.07
10.85	10.84	....
18.91	18.92	8.08
18.92	18.93	....
26.99	27.02	8.09

Readings.	Corrected.	Difference.
c.c.	c.c.	c.c.
1.98	1.98	....
10.03	10.02	8.04
10.03	10.02	....
18.05	18.07	8.05
18.05	18.07	....
26.08	26.11	8.04

Mean 8.08 less 0.04 correction = 8.04  
c.c. ethylate.

$10.005 : 8.04 :: x : 0.10027$

$x = 0.1248$  normality of the ethylate.  
To make 100 c.c. N/100 salt solution  
requires 8.015 c.c.

Mean 8.04 less 0.04 correction = 8.00  
c.c. ethylate.

$8.04 : 8.00 :: 0.10027 : x$

$x = 0.09977$  normality of organic acid.  
To make 100 c.c. N/100 salt solution  
requires 10.02 c.c. plus 0.01 c.c.;  
excess equals 10.03 c.c.

It should be mentioned that this work was carried on in a rather small room with one window and one door at opposite ends of the room, so that with care it was possible to keep the room temperature at  $25^\circ$  with less than  $0.3^\circ$  variation. Thus it was possible to measure out the solutions in burettes and pipettes, provided that such were not handled unnecessarily to cause heating and were always kept dry to prevent cooling in evaporation. All burettes and pipettes were connected with a tube filled with a mixture of calcium chloride and soda lime to prevent contamination from moisture and carbon dioxide.

In handling the "run" the  $N/100$  solution of one of the salts served as a basis for the preparation of all the more dilute solutions. The following scheme represents the method by which these solutions were prepared:

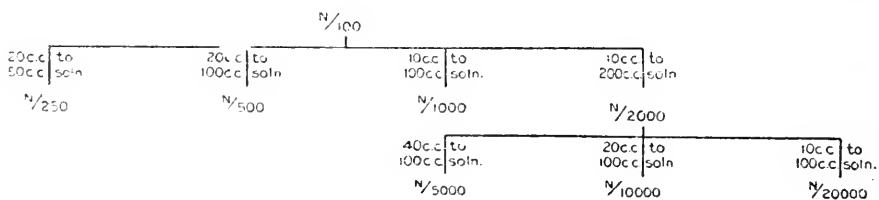

After a number of experiments it was deemed inadvisable to wash the measuring flasks with water; they were therefore rinsed with a good grade of alcohol and then three times with conductivity alcohol. The cells were filled with conductivity water until several hours before use. They were then rinsed three times with good alcohol. Each cell was finally washed three times with the solution of the particular dilution to be "run" in that cell before filling. These cells, together with one containing the conductivity alcohol, were then introduced into the  $15^\circ$  bath, gently agitated twice within an hour's time to insure absence of bubbles as well as to hasten diffusion, and then read. They were placed successively in the  $25^\circ$  and  $35^\circ$  baths, allowing for the same time and procedure as in the  $15^\circ$  bath.

It will be remembered that the solutions were made up at  $25^\circ$  and that the molecular conductances were measured at  $15^\circ$ ,  $25^\circ$ , and  $35^\circ$ . Alcohol has such an appreciable temperature coefficient of expansion that it was necessary to correct for the contraction and expansion at the other temperatures. One liter of alcohol at  $25^\circ$  expands to 1.01114 liters at  $35^\circ$  and contracts to 0.98923 liter at  $15^\circ$ . Therefore, to obtain the molecular conductance at  $35^\circ$ , one must multiply the specific conductance at that temperature by the product of the molecular volume and the factor 1.01114. Likewise, to obtain the molecular conductance at  $15^\circ$ , the specific conductance at that temperature must be multiplied by the product of the molecular volume and the factor 0.98923.

## MEASUREMENTS.

## EXPLANATION OF TABLES.

In the following tables  $V$  signifies the volume at which a solution was made up,  $\Lambda$  the molecular conductance of that solution at the various temperatures. The method of calculating  $\Lambda$  is thoroughly familiar. Corrections were applied as described, allowing for the contraction and expansion of the solutions. (The solutions were so dilute that their volume changes with variation in temperature were assumed to be the same as that of pure alcohol.) The values of  $\Lambda$  25°, therefore, represent the molecular conductance of a solution of volume  $V$  at 25°. The values of  $\Lambda$  15° and  $\Lambda$  35°, however, represent the molecular conductance of a solution of volume 0.98923  $V$  at 15° and 1.01114  $V$  at 35°. Only the one value  $V$  is given in the tables to save space. All conductances are expressed in reciprocal ohms.

Concerning the calculation of the temperature coefficients of conductance, we have adopted this expression:

$$T = \frac{\Lambda t' - \Lambda t}{t' - t}$$

where  $\Lambda t'$  and  $\Lambda t$  represent the molecular conductivities of the same solution at  $t'$  and  $t$  ( $t' > t$ ), and  $T$  the temperature coefficient of conductance. To find the percentage coefficient of conductance we have used the formula

$$\Delta = \frac{T}{\Lambda t}$$

where  $\Delta$  is the percentage coefficient and  $\Lambda t$  the conductivity at the lower temperature. At first the values of  $\Lambda t$  and  $\Lambda t'$  at 15° and 35° were corrected for the difference in volume between 0.98923  $V$  and  $V$ , and 1.01114  $V$  and  $V$ , respectively. This was done in order that comparison might be made between solutions of the same volume. Later this correction was omitted because of its small value.

TABLE 65.—Sodium Formate.

$V$	$\Lambda_{25^\circ}$	$\Lambda_{35^\circ}$	$\Delta_{25-35^\circ}$
100	20.09	22.70	1.30
250	25.03	28.53	1.40
500	28.48	33.25	1.67
1,000	32.62	38.13	1.69
2,000	35.34	41.88	1.85
5,000	37.75	44.67	1.83
10,000	39.03	46.35	1.88
20,000	39.76	47.24	1.88

TABLE 66.—Sodium Acetate.

$V$	$\Lambda_{25^\circ}$	$\Lambda_{35^\circ}$	$\Delta_{25-35^\circ}$
100	17.20	19.10	1.10
250	22.20	25.08	1.30
500	26.07	29.76	1.42
1,000	29.99	34.67	1.56
2,000	32.80	38.54	1.75
5,000	35.42	41.62	1.75
10,000	36.36	42.84	1.78
20,000	36.79	42.95	1.67

TABLE 67.—*Sodium Chloroacetate.*

V	$\Lambda_{15^\circ}$	$\Lambda_{25^\circ}$	$\Lambda_{35^\circ}$	$\Delta_{15-25^\circ}$	$\Delta_{25-35^\circ}$
50	12.92	14.66	16.40	1.35	1.19
100	16.15	18.45	20.74	1.42	1.24
250	20.52	23.76	26.92	1.58	1.33
500	23.76	27.79	32.04	1.70	1.53
1,000	26.51	31.34	36.56	1.82	1.67
2,500	29.19	34.79	41.00	1.92	1.81
5,000	30.73	36.81	43.83	1.98	1.91
10,000	31.53	37.84	45.02	2.00	1.90

TABLE 68.—*Sodium Dichloroacetate.*

V	$\Lambda_{15^\circ}$	$\Lambda_{25^\circ}$	$\Lambda_{35^\circ}$	$\Delta_{15-25^\circ}$	$\Delta_{25-35^\circ}$
100	18.12	20.84	23.67	1.50	1.36
250	22.38	26.06	29.91	1.64	1.48
500	25.55	30.00	34.92	1.74	1.64
1,000	28.36	33.61	39.40	1.85	1.72
2,000	30.30	36.12	42.79	1.92	1.85
5,000	32.16	38.62	46.01	2.01	1.91
10,000	33.08	39.77	.....	2.02	.....
20,000	33.97	40.67	48.71	1.97	1.98

TABLE 69.—*Sodium Trichloroacetate.*

V	$\Lambda_{15^\circ}$	$\Lambda_{25^\circ}$	$\Lambda_{35^\circ}$	$\Delta_{15-25^\circ}$	$\Delta_{25-35^\circ}$
100	19.03	22.05	25.13	1.59	1.40
250	23.26	27.24	31.36	1.71	1.51
500	26.18	30.94	36.10	1.82	1.67
1,000	28.80	34.31	40.31	1.91	1.75
2,000	30.36	36.40	43.04	1.99	1.82
5,000	32.24	38.79	46.12	2.03	1.89
10,000	33.02	39.84	47.39	2.07	1.90
20,000	33.71	40.54	48.39	2.03	1.94

TABLE 70.—*Sodium Phenylacetate.*

V	$\Lambda_{15^\circ}$	$\Lambda_{25^\circ}$	$\Lambda_{35^\circ}$	$\Delta_{15-25^\circ}$	$\Delta_{25-35^\circ}$
50	11.14	12.44	13.60	1.17	0.93
100	13.86	15.58	17.16	1.24	1.01
250	17.96	20.51	22.91	1.42	1.09
500	21.03	24.31	27.58	1.56	1.35
1,000	24.09	28.23	32.36	1.72	1.46
2,500	26.68	31.60	36.82	1.84	1.65
5,000	28.06	33.46	39.31	1.92	1.75
10,000	28.40	34.06	40.25	1.99	1.82

TABLE 71.—*Sodium Propionate.*

V	$\Lambda_{15^\circ}$	$\Lambda_{25^\circ}$	$\Lambda_{35^\circ}$	$\Delta_{15-25^\circ}$	$\Delta_{25-35^\circ}$
100	14.68	16.50	18.18	1.24	1.02
250	18.80	21.41	23.95	1.39	1.19
500	22.16	25.71	28.95	1.60	1.29
1,000	25.13	29.38	33.85	1.68	1.52
2,000	27.35	32.28	37.66	1.80	1.67
5,000	29.26	34.73	40.64	1.87	1.70
10,000	30.27	36.11	42.52	1.93	1.77
20,000	30.52	36.23	42.41	1.87	1.71

TABLE 72.—*Sodium B-iodopropionate.*

V	$\Lambda_{15^\circ}$	$\Lambda_{25^\circ}$	$\Lambda_{35^\circ}$	$\Delta_{15-25^\circ}$	$\Delta_{25-35^\circ}$
50	15.25	17.67	21.25	1.59	2.03
100	18.54	21.67	26.48	1.69	2.22
250	22.59	26.70	33.27	1.82	2.46
500	25.51	30.47	38.13	1.94	2.51
1,000	27.91	33.55	42.09	2.02	2.55
2,500	30.18	36.45	45.50	2.08	2.48
5,000	31.39	37.91	47.39	2.07	2.50
10,000	31.93	38.69	48.06	2.12	2.43

TABLE 73.—*Sodium Butyrate.*

V	$\Lambda_{15^\circ}$	$\Lambda_{25^\circ}$	$\Lambda_{35^\circ}$	$\Delta_{15-25^\circ}$	$\Delta_{25-35^\circ}$
100	14.39	16.16	17.82	1.23	1.03
250	18.50	21.03	23.49	1.37	1.17
500	21.79	24.97	28.36	1.46	1.36
1,000	24.74	28.89	33.30	1.68	1.53
2,000	26.93	31.80	37.07	1.81	1.66
5,000	28.95	34.29	40.16	1.84	1.82
10,000	29.85	35.67	42.06	1.95	1.79
20,000	30.27	35.98	42.41	1.89	1.79

TABLE 74.—*Sodium Oxylsbutyrate.*

V	$\Lambda_{15^\circ}$	$\Lambda_{25^\circ}$	$\Lambda_{35^\circ}$	$\Delta_{15-25^\circ}$	$\Delta_{25-35^\circ}$
50	12.28	14.21	16.13	1.57	1.35
100	15.39	17.87	20.32	1.61	1.37
250	19.73	23.07	26.51	1.69	1.49
500	22.74	26.81	31.11	1.79	1.60
1,000	25.71	30.52	35.76	1.87	1.72
2,500	28.07	33.46	39.52	1.92	1.81
5,000	29.34	35.07	41.74	1.95	1.90
10,000	30.23	36.05	42.97	1.93	1.92

TABLE 75.—Sodium Benzoate.

V	$\Lambda_{15^\circ}$	$\Lambda_{25^\circ}$	$\Lambda_{35^\circ}$	$\Delta_{15-25^\circ}$	$\Delta_{25-35^\circ}$
100	.....	.....	.....	.....	.....
250	18.94	21.66	24.29	1.45	1.21
500	22.11	25.66	29.21	1.61	1.38
1,000	25.03	29.40	33.93	1.75	1.54
2,000	27.00	31.99	37.39	1.85	1.69
5,000	29.18	34.78	40.83	1.92	1.74
10,000	30.01	35.80	42.20	1.92	1.82
20,000	30.41	36.18	42.64	1.90	1.79

TABLE 76.—Sodium Orthoamidobenzoate.

V	$\Lambda_{15^\circ}$	$\Lambda_{25^\circ}$	$\Lambda_{35^\circ}$	$\Delta_{15-25^\circ}$	$\Delta_{25-35^\circ}$
100	13.19	14.84	16.37	1.25	1.07
250	17.24	19.60	21.86	1.37	1.15
500	20.76	23.94	26.99	1.53	1.27
1,000	23.90	27.82	31.92	1.64	1.47
2,000	26.17	30.81	35.75	1.77	1.60
5,000	28.44	33.54	38.91	1.79	1.60
10,000	29.29	34.71	40.68	1.85	1.72
20,000	29.52	34.82	40.50	1.80	1.63

TABLE 77.—Sodium *p*-amidobenzoate.

V	$\Lambda_{15^\circ}$	$\Lambda_{25^\circ}$	$\Lambda_{35^\circ}$	$\Delta_{15-25^\circ}$	$\Delta_{25-35^\circ}$
100	12.26	13.64	14.92	1.13	0.94
250	16.30	18.50	20.34	1.35	0.99
500	.....	.....	.....	.....	.....
1,000	22.54	26.13	29.81	1.59	1.41
2,000	24.87	29.20	33.80	1.74	1.58
5,000	27.37	32.37	37.52	1.79	1.63
10,000	28.33	(33.21)	(39.58)	(1.72)	(1.92)
20,000	28.92	34.16	(40.01)	(1.81)	(1.71)

TABLE 78.—Sodium *m*-brombenzoate.

V	$\Lambda_{15^\circ}$	$\Lambda_{25^\circ}$	$\Lambda_{35^\circ}$	$\Delta_{15-25^\circ}$	$\Delta_{25-35^\circ}$
100	14.64	16.66	18.67	1.38	1.21
250	18.52	21.35	24.20	1.53	1.33
500	.....	.....	.....	.....	.....
1,000	23.94	28.20	32.86	1.78	1.65
2,000	25.55	30.38	35.80	1.89	1.78
5,000	27.56	32.85	38.83	1.92	1.82
10,000	28.30	33.93	40.20	1.99	1.85
20,000	29.06	34.71	41.15	1.94	1.86

TABLE 79.—Sodium *p*-brombenzoate.

V	$\Lambda_{15^\circ}$	$\Lambda_{25^\circ}$	$\Lambda_{35^\circ}$	$\Delta_{15-25^\circ}$	$\Delta_{25-35^\circ}$
100	15.71	17.94	20.11	1.42	1.21
250	19.78	22.83	26.00	1.54	1.39
500	22.84	26.76	30.89	1.72	1.51
1,000	25.37	30.02	34.94	1.83	1.64
2,000	27.19	32.46	38.15	1.94	1.75
5,000	28.62	34.31	40.59	1.99	1.84
10,000	29.41	(35.09)	42.05	.....	.....
20,000	29.84	35.75	42.73	2.01	1.89

TABLE 80.—Sodium Orthochlorobenzoate.

V	$\Lambda_{15^\circ}$	$\Lambda_{25^\circ}$	$\Lambda_{35^\circ}$	$\Delta_{15-25^\circ}$	$\Delta_{25-35^\circ}$
100	14.54	16.49	18.34	1.34	1.12
250	18.71	21.52	24.25	1.50	1.27
500	21.90	25.44	29.09	1.62	1.43
1,000	24.83	29.23	33.86	1.77	1.58
2,000	26.85	31.96	37.42	1.90	1.71
5,000	28.82	34.65	40.85	2.02	1.79
10,000	29.97	36.04	.....	2.03	.....
20,000	30.26	36.76	43.59	2.15	1.86

TABLE 81.—Sodium Metachlorobenzoate.

V	$\Lambda_{15^\circ}$	$\Lambda_{25^\circ}$	$\Lambda_{35^\circ}$	$\Delta_{15-25^\circ}$	$\Delta_{25-35^\circ}$
100	15.53	17.69	19.82	1.39	1.20
250	19.74	22.76	25.80	1.53	1.34
500	22.83	26.62	30.59	1.66	1.49
1,000	25.60	30.18	35.15	1.79	1.65
2,000	27.38	32.68	38.36	1.94	1.74
5,000	29.55	35.40	41.81	1.98	1.81
10,000	30.51	36.49	43.40	1.96	1.89
20,000	31.01	37.03	43.87	1.94	1.85

TABLE 82.—Sodium *p*-chlorobenzoate.

V	$\Lambda_{15^\circ}$	$\Lambda_{25^\circ}$	$\Lambda_{35^\circ}$	$\Delta_{15-25^\circ}$	$\Delta_{25-35^\circ}$
100	15.80	18.04	20.22	1.42	1.21
250	19.92	23.04	26.18	1.57	1.36
500	22.91	26.78	30.90	1.69	1.54
1,000	25.65	30.37	35.39	1.84	1.65
2,000	.....	.....	.....	.....	.....
5,000	29.25	35.27	41.64	2.06	1.81
10,000	30.17	(36.24)	43.13	(2.02)	(1.90)
20,000	30.33	36.80	43.42	2.13	1.80

TABLE 83.—*Sodium Salicylate.*

V	Λ15°	Λ25°	Λ35°	Δ15-25°	Δ25-35°
50	14.19	16.32	18.42	1.51	1.29
100	17.19	19.87	22.58	1.56	1.36
250	21.52	25.13	28.84	1.67	1.48
500	24.56	28.92	33.60	1.78	1.62
1,000	27.48	32.62	38.31	1.87	1.74
2,000	29.18	34.87	41.18	1.95	1.81
2,500	30.00	35.92	42.45	1.97	1.82
5,000	31.20	37.47	44.57	2.01	1.87
10,000	31.90	38.38	45.61	2.03	1.88
20,000	32.38	38.99	46.36	2.04	1.89

TABLE 84.—*Sodium m-hydroxybenzoate.*

V	Λ15°	Λ25°	Λ35°	Δ15-25°	Δ25-35°
50	.....	.....	.....	.....	.....
100	13.61	15.31	16.97	1.25	1.08
250	17.64	20.13	22.51	1.41	1.18
500	.....	.....	.....	.....	.....
1,000	23.61	27.61	31.85	1.69	1.54
2,000	25.62	30.27	35.42	1.81	1.70
2,500	.....	.....	.....	.....	.....
5,000	27.67	32.88	38.51	1.88	1.71
10,000	28.33	33.97	39.98	1.99	1.77
20,000	29.02	34.65	40.78	1.94	1.77

TABLE 85.—*Sodium p-hydroxybenzoate.*

V	Λ15°	Λ25°	Λ35°	Δ15-25°	Δ25-35°
50	.....	.....	.....	.....	.....
100	12.54	14.04	15.21	1.20	0.83
250	16.63	18.84	20.93	1.33	1.11
500	19.39	22.31	25.21	1.51	1.30
1,000	22.31	26.05	29.85	1.68	1.46
2,000	24.17	28.82	33.50	1.92	1.62
5,000	26.27	31.58	36.73	2.02	1.63
10,000	27.28	32.95	38.74	2.08	1.76
20,000	27.34	33.27	(38.69)	2.17	.....

TABLE 86.—*Sodium Acetylsalicylate.*

V	Λ15°	Λ25°	Λ35°	Δ15-25°	Δ25-35°
50	14.16	16.29	18.38	1.50	1.28
100	17.16	19.81	22.50	1.54	1.36
250	21.50	25.08	28.71	1.67	1.45
500	24.44	28.73	33.41	1.76	1.63
1,000	27.62	32.76	38.36	1.86	1.71
2,500	30.06	35.89	42.38	1.94	1.81
5,000	31.28	37.44	44.56	1.97	1.90
10,000	32.56	38.97	46.45	1.97	1.92
25,000	32.73	39.17	46.70	1.97	1.92

TABLE 87.—*Sodium Iodosalicylate.*

V	Λ15°	Λ25°	Λ35°	Δ15-25°	Δ25-35°
50	.....	.....	.....	.....	.....
100	17.66	20.47	23.44	1.59	1.45
250	21.93	25.67	29.59	1.71	1.53
500	25.07	29.55	34.49	1.79	1.67
1,000	27.48	32.67	36.28	1.89	1.73
2,000	29.24	34.95	41.23	1.95	1.80
2,500	.....	.....	.....	.....	.....
5,000	30.89	37.17	44.03	2.03	1.85
10,000	31.38	37.69	45.08	2.01	1.96
20,000	31.57	38.35	.....	2.15	.....

TABLE 88.—*Sodium Sulphosalicylate.*

V	Λ15°	Λ25°	Λ35°	Δ15-25°	Δ25-35°
50	12.38	14.28	16.21	1.53	1.35
100	15.30	17.73	20.29	1.59	1.44
250	19.19	22.48	25.92	1.71	1.53
500	21.92	25.90	30.22	1.82	1.67
1,000	24.34	29.00	34.11	1.95	1.76
2,000	26.12	31.27	37.11	1.97	1.87
2,500	26.58	31.93	37.86	2.01	1.86
5,000	28.18	33.88	40.42	2.02	1.93
10,000	29.37	35.47	42.41	2.08	1.97
20,000	30.65	37.13	44.16	2.11	1.89

TABLE 89.—*Sodium Orthonitrobenzoate.*

V	Λ15°	Λ25°	Λ35°	Δ15-25°	Δ25-35°
50	11.81	13.28	14.62	1.24	1.01
100	14.79	16.73	18.59	1.31	1.11
250	18.94	21.76	24.45	1.49	1.24
500	22.13	25.69	29.34	1.61	1.42
1,000	24.87	29.26	33.82	1.77	1.56
2,500	27.60	32.83	38.51	1.89	1.73
5,000	29.10	34.89	41.29	1.99	1.83
10,000	30.04	36.07	42.89	2.00	1.89

TABLE 90.—*Sodium m-nitrobenzoate.*

V	Λ15°	Λ25°	Λ35°	Δ15-25°	Δ25-35°
50	13.61	15.55	17.49	1.43	1.25
100	16.43	16.94	21.44	1.53	1.32
250	(20.13)	(23.09)	26.52	(1.47)	1.49
500	23.32	27.54	31.95	1.81	1.60
1,000	26.16	31.08	36.44	1.88	1.72
2,500	28.41	33.89	40.05	1.93	1.82
5,000	29.52	35.21	42.12	1.93	1.96
10,000	29.80	35.66	42.95	1.97	2.04

TABLE 91.—*Sodium Paranitrobenzoate.*

V	$\Lambda_{15^\circ}$	$\Lambda_{25^\circ}$	$\Lambda_{35^\circ}$	$\Delta_{15-25^\circ}$	$\Delta_{25-35^\circ}$
50	14.31	16.47	18.61	1.51	1.30
100	17.22	19.96	22.72	1.59	1.38
250	21.04	.....	28.19	.....	.....
500	23.98	28.36	33.09	1.83	1.67
1,000	26.59	31.69	37.30	1.84	1.77
2,500	28.63	34.25	40.51	1.96	1.83
5,000	29.75	35.66	42.53	1.99	1.93
10,000	30.70	36.98	44.10	2.05	1.93

TABLE 92.—*Sodium 2, 4, Dinitrobenzoate.*

V	$\Lambda_{15^\circ}$	$\Lambda_{25^\circ}$	$\Lambda_{35^\circ}$	$\Delta_{15-25^\circ}$	$\Delta_{25-35^\circ}$
100	18.20	21.09	24.09	1.59	1.42
250	22.18	25.98	29.93	1.71	1.52
500	24.95	29.45	34.39	1.80	1.69
1,000	27.41	32.52	38.33	1.86	1.79
2,000	28.74	34.42	40.88	1.98	1.88
5,000	30.45	36.63	43.71	2.03	1.93
10,000	31.21	37.66	44.94	2.07	1.93
20,000	31.80	38.27	45.86	2.03	1.98

TABLE 93.—*Sodium Orthotoluate.*

V	$\Lambda_{15^\circ}$	$\Lambda_{25^\circ}$	$\Lambda_{35^\circ}$	$\Delta_{15-25^\circ}$	$\Delta_{25-35^\circ}$
50	11.42	12.80	14.11	1.22	1.01
100	14.19	16.03	17.81	1.30	1.11
250	18.32	21.07	23.67	1.50	1.23
500	21.28	24.69	28.16	1.60	1.41
1,000	24.53	28.80	33.24	1.74	1.54
2,500	27.17	32.19	37.52	1.85	1.66
5,000	28.63	34.23	40.23	1.96	1.75
10,000	29.56	35.36	41.75	1.96	1.81
25,000	.....	.....	.....	.....	.....

TABLE 94.—*Sodium m-toluate.*

V	$\Lambda_{15^\circ}$	$\Lambda_{25^\circ}$	$\Lambda_{35^\circ}$	$\Delta_{15-25^\circ}$	$\Delta_{25-35^\circ}$
50	11.16	12.46	13.64	1.16	0.97
100	14.16	15.92	17.57	1.24	1.04
250	18.26	20.85	23.32	1.42	1.18
500	21.42	24.75	28.17	1.55	1.38
1,000	24.10	28.24	32.55	1.72	1.53
2,500	26.60	31.52	36.74	1.85	1.66
5,000	27.97	33.38	39.36	1.93	1.79
10,000	28.68	34.24	40.33	1.94	1.78
25,000	29.36	35.05	41.22	1.94	1.76

TABLE 95.—*Sodium Paratoluate.*

V	$\Lambda_{15^\circ}$	$\Lambda_{25^\circ}$	$\Lambda_{35^\circ}$	$\Delta_{15-25^\circ}$	$\Delta_{25-35^\circ}$
50	11.25	12.53	13.74	1.14	0.96
100	14.05	15.79	17.43	1.24	1.04
250	18.11	20.68	23.00	1.42	1.12
500	21.14	24.45	27.75	1.57	1.35
1,000	24.15	28.29	32.55	1.71	1.51
2,500	26.64	31.46	36.62	1.82	1.64
5,000	28.00	33.29	39.21	1.89	1.78
10,000	28.49	33.80	39.91	1.86	1.81
40,000	.....	.....	.....	.....	.....

TABLE 96.—*Sodium Picrate.*

V	$\Lambda_{15^\circ}$	$\Lambda_{25^\circ}$	$\Lambda_{35^\circ}$	$\Delta_{15-25^\circ}$	$\Delta_{25-35^\circ}$
100	19.77	23.28	27.09	1.78	1.64
250	24.49	28.93	33.80	1.81	1.68
500	27.81	33.04	38.79	1.88	1.74
1,000	30.65	36.56	43.24	1.93	1.83
2,000	32.78	39.24	46.60	1.97	1.88
5,000	34.73	41.67	49.85	2.00	1.96
10,000	35.73	42.91	51.46	2.01	1.99
20,000	36.32	43.63	52.43	2.01	2.02
40,000	.....	43.86	.....	.....	.....

## DISCUSSION OF RESULTS.

The most apparent observation from tables 65 to 96 is the great similarity in amount of conductance of these organic salts in alcohol. At  $25^\circ$  in a 1,000-liter dilution the extreme limits for the conductance are from 26 to 36 mhos, with an average value from 28 to 33. The obvious reason for this is the uniform effect of the sodium ion in the solution and the similarity in the velocities of the organic anions. As naturally expected, the conductances of these salts are much greater than those of the corresponding acids.

Very little can be said as to the relation between chemical composition and conductance. The aliphatic and aromatic derivatives show no

difference, and the conductance of the aromatic compounds seems to be independent of the position of the various substituent groups. Sodium picrate has a much larger conductance than any other salt, and the monosodiumsulphosalicylate at high dilutions gives abnormally large and increasing conductance values, due probably to the secondary ionization of the carboxyl group at these high dilutions.

In discussing the temperature coefficient of conductance it is to be noticed that this value becomes gradually larger with increase in dilution, and at the highest dilutions approximates the value 0.0200. Just as in the conductance results, there is here no definite relation between the values for the temperature coefficient and chemical composition.

It is of importance to note that this work on the sodium salts of the organic acids in absolute alcohol has been greatly restricted, owing to the almost complete insolubility of a great many of these salts in this solvent. If the work were carried out in alcohol which was not absolute, practically all the salts could be studied, for it is necessary to add only a very small amount of water to obtain a sufficient degree of solubility. We have approximately covered the field of available compounds. It is of interest to note that the polybasic acids of both the aliphatic and aromatic series are excluded from study for this reason, as well as all unsaturated acids of both series. A number of salts of aromatic acids with di- and tri-substitutions in the ring were likewise impossible to study.

Reference has already been made (see pages 100–103) to the work of Heinrich Goldschmidt on the conductance of alcoholic solutions of sodium salts. We have purposely investigated most of the salts which he studied. A comparison of these results is conveniently made by reference to the following tables:

Salt.	Goldschmidt.	Authors.
Sodium dichloroacetate...	Table 60, p. 100	Table 68, p. 110
Sodium trichloroacetate...	59, 100	69, 110
Sodium salicylate.....	61, 101	83, 112
Sodium sulphosalicylate..	62, 101	88, 112
Sodium picrate.....	63, 101	96, 113

It can be seen from these tables that the two series of conductance values are in accordance, but an exact comparison can not be made because of the fact that the values of  $\Lambda$  in the two series refer to somewhat different concentrations. In order to make an effective comparison we have plotted the values of  $\Lambda$  against the logarithms of the volume  $V$  in the case of sodium trichloroacetate (see fig. 26). The points circled refer to the data of Goldschmidt and the crosses to



data obtained in the present work. With few exceptions all the points lie on one curve, and the slight deviations which occur are within the limits of error of the conductance method. The four other salts give similar results; therefore their graphs are omitted.

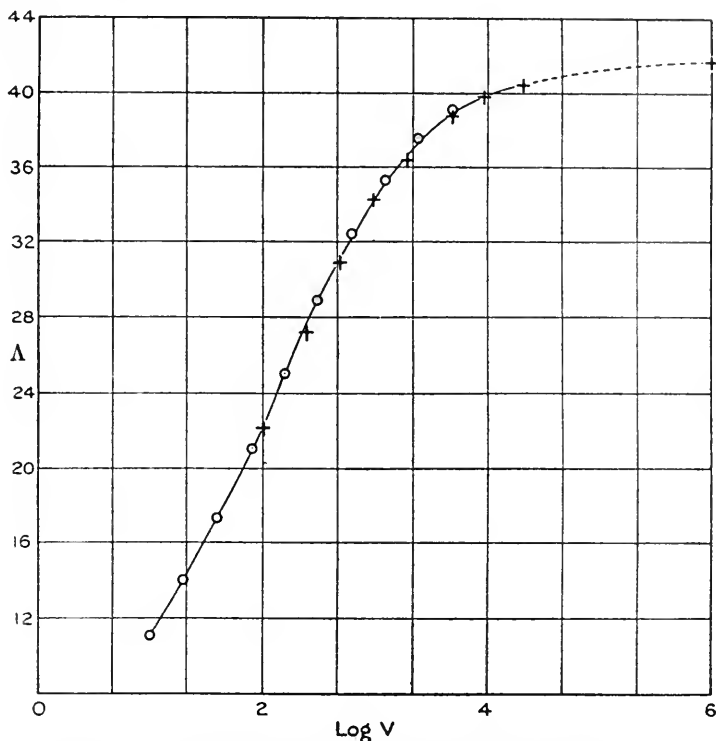

FIG. 26.—Comparison of Conductance Values in Absolute Alcohol.  
o = Goldschmidt; x = Lloyd and Pardee.

It has been found impossible to obtain, experimentally, a value for the limiting conductance, although measurements have been carried out to 10,000 and 20,000 liter dilutions. It is therefore necessary to determine  $\Lambda_0$  by some method of extrapolation. It will be recalled that Goldschmidt used the Kohlrausch formula for this purpose (see page 101), although its applicability to alcoholic solutions and even to aqueous solutions<sup>1</sup> had been previously questioned. We applied this formula to our experimental data with a similarly unsatisfactory result. The calculated values of  $\Lambda_0$  vary to such an extent that it is impossible to make a selection.

A function of another form, suggested by A. A. Noyes,<sup>2</sup> which has been successfully used in connection with researches upon the electrical

<sup>1</sup>A. A. Noyes: Journ. Amer. Chem. Soc. **30**, 344 (1908).

<sup>2</sup>Journ. Amer. Chem. Soc. **30**, 335 (1908).

conductance of aqueous solutions, presented a possible means of determining  $\Lambda_0$  in alcoholic solutions. This function has the form

$$1/\Lambda = 1/\Lambda_0 + K(c\Lambda)^{n-1}$$

where  $\Lambda$  is the equivalent conductance at the concentration  $c$  ( $1/V$ ).  $K$  is a constant, and  $n$  is a number which, for aqueous solutions, lies between 1.3 and 1.7. The value of  $n$  is so chosen that the graph obtained by plotting the reciprocal of the equivalent conductance ( $1/\Lambda$ ) at the various concentrations ( $c$ ) against  $(c\Lambda)^{n-1}$  is nearly a straight line. Two other graphs corresponding to neighboring values of  $n$ , on opposite sides of the first line, are also drawn so as to aid in determining the most probable point at which the graphs cut the  $1/\Lambda$  axis.<sup>1</sup> This point is  $1/\Lambda_0$ , the reciprocal of the limiting conductivity.

This procedure was followed, using the data at 25° of sodium trichloroacetate, salicylate, orthonitrobenzoate, 2, 4 dinitrobenzoate, and picrate. The graphs obtained are in every respect similar to those for aqueous solutions, except that the value of  $n$  lies between 1.7 and 1.8. The values of  $\Lambda_0$  obtained for the above salts at 25° are:

Sodium trichloroacetate.....	41.6
Sodium salicylate.....	39.9
Sodium orthonitrobenzoate.....	38.0
Sodium 2, 4 dinitrobenzoate.....	39.2
Sodium picrate.....	44.7

From these figures the percentage dissociation of these salts is obtained by means of the familiar formula  $\alpha = \frac{\Lambda}{\Lambda_0}$ .

While the procedure outlined above is thus proved to give satisfactory results in alcoholic solutions, the calculations are quite laborious, and advantage is taken of a much shorter method of approximating  $\Lambda_0$ , suggested by Randall.<sup>2</sup> It is a fact that as the zero of concentration (infinite dilution) is approached, the difference in the percentage ionization of all salts approaches zero.

Randall makes the provisional assumption that the ionization of salts of the same type (such as thallos chloride and potassium chloride) is the same. Knowing the percentage dissociation of potassium chloride at various dilutions very accurately, he calculates the value of  $\Lambda_0$  for thallos chloride by means of the equation

$$\Lambda_0 = \Lambda/\alpha'$$

in which  $\alpha'$  is the percentage dissociation of KCl at any given dilution and  $\Lambda$  is the molecular conductance of TlCl at the same dilution. Such a calculation gives values for  $\Lambda_0$  which approach a constant figure with increasing dilution.

<sup>1</sup>See J. Johnston: Journ. Amer. Chem. Soc. **31**, 1010 (1909).

<sup>2</sup>Journ. Amer. Chem. Soc. **38**, 788 (1916).

In applying this method to our results we have made use of the values of percentage dissociation obtained by means of the equation of Noyes. It has been found that the three salts, sodium trichloroacetate, salicylate, and orthonitrobenzoate, include examples of all the various types of salts encountered in the present investigation.

The calculation of  $\Lambda_0$  is illustrated by table 97

TABLE 97.

V	100 $\alpha$ 25° Sodium Salicylate.	$\Lambda$ 25° Sodium Acetate.	$\Lambda$ Sodium Acetate.
			$\alpha$ Sodium Salicylate.
100	49.8	17.20	34.5
250	63.0	22.20	35.2
500	72.5	26.97	35.9
1,000	81.8	29.99	36.6
2,000	87.4	32.80	37.5
5,000	94.0	35.42	37.7
10,000	96.3	36.36	37.8
20,000	97.8	36.79	37.7

Probable  $\Lambda_0 = 37.8$ .

Table 98 contains the most probable values of  $\Lambda_0$  at 25° for all the salts studied by the authors and calculated in the manner just indicated.

TABLE 98.

Sodium.	$\Lambda_0$	Sodium.	$\Lambda_0$	Sodium.	$\Lambda_0$
Formate.....	40.7	Orthoamidobenzoate..	36.6	Iodosalicylate.....	39.2
Acetate.....	37.8	Para-amidobenzoate..	35.0	Sulphosalicylate.....	.....
Chloroacetate.....	39.5	Metabrombenzoate...	35.6	Orthonitrobenzoate..	38.0
Dichloroacetate.....	41.6	Parabrombenzoate...	36.9	Metanitrobenzoate...	37.3
Trichloroacetate.....	41.6	Orthochlorobenzoate..	37.9	Paranitrobenzoate...	38.7
Phenylacetate.....	35.6	Metachlorobenzoate..	38.0	2, 4 dinitrobenzoate..	39.2
Propionate.....	37.3	Paraehlorobenzoate...	37.9	Orthotoluate.....	37.0
$\beta$ -iodopropionate.....	40.2	Salicylate.....	39.9	Metatoluate.....	35.7
Butyrate.....	37.0	Metahydroxybenzoate.	35.7	Paratoluate.....	35.6
Oxyisobutyrate.....	37.6	Parahydroxybenzoate.	35.0	Picrate.....	44.7
Benzoate.....	37.4	Acetylsalicylate.....	39.9		

The values of  $\Lambda_0$  for the organic acids are calculated from those of the sodium salts by means of the following equation:

$$\Lambda_0 \text{ acid} = \Lambda_0 \text{Na salt} + \Lambda_0 \text{HCl} - \Lambda_0 \text{NaCl}$$

The values of  $\Lambda_0 \text{HCl}$  and  $\Lambda_0 \text{NaCl}$  have been obtained from the conductance data of Goldschmidt<sup>1</sup> by means of the equations of Noyes and of Randall.  $\Lambda_0 \text{HCl}$  can be very precisely fixed at 82.0 mhos.  $\Lambda_0 \text{NaCl}$  is most probably 42.0 mhos, with a possible variation of  $\pm 0.5$  mho. Substituting these values in the equation above, we have

$$\Lambda_0 \text{ acid} = \Lambda_0 \text{Na salt} + 40$$

<sup>1</sup>Zeit. physik Chem. 89, 131, 142 (1914).

Table 99 contains the probable values of  $\Lambda_0$  at 25° for the organic acids, calculated in the manner just indicated.

TABLE 99.

Acid.	$\Lambda_0$	Acid.	$\Lambda_0$	Acid.	$\Lambda_0$
Formic.....	80.5	Orthoamidobenzoic...	76.5	Iodosalicylic.....	79.0
Acetic.....	78.0	Meta-amidobenzoic...	75.0	Sulphosalicylic.....	.....
Chloroacetic.....	79.5	Para-amidobenzoic...	75.5	Orthonitrobenzoic...	78.0
Dichloroacetic.....	81.5	Orthochlorobenzoic...	77.5	Metanitrobenzoic...	77.5
Trichloroacetic.....	81.5	Metachlorobenzoic...	78.0	Paranitrobenzoic...	78.5
Phenylacetic.....	75.5	Parachlorobenzoic...	78.0	2, 4 dinitrobenzoic...	79.0
Propionic.....	77.5	Salicylic.....	80.0	Orthotoluic.....	77.0
$\beta$ -iodopropionic.....	80.0	Metahydroxybenzoic...	75.5	Metatoluic.....	75.5
Butyric.....	77.0	Parahydroxybenzoic...	75.0	Paratoluic.....	75.5
Oxyisobutyric.....	77.5	Acetylsalicylic.....	80.0	Pieric.....	84.5
Benzoic.....	77.5				

## SUMMARY.

The authors have prepared absolute alcohol solutions of 32 sodium salts of organic acids, and have measured the electrical conductance of these solutions at 15°, 25°, and 35°, over a concentration range extending from N/50 to N/20000. Five of the salts had been previously studied by Goldschmidt and his pupils, and our results present a striking confirmation of their data.

The  $\Lambda_0$  values for the salts can not be obtained experimentally, although they may be closely approached in many instances; they must therefore be obtained by some method of extrapolation. Goldschmidt used the Kohlrausch formula

$$\Lambda_0 = \Lambda_v + a\sqrt{\frac{1}{v}}$$

In common with Turner and with Dutoit and Rapoport we have been unable to get satisfactory results with this formula. We have been entirely successful, however, in the use of a function developed for aqueous solutions by A. A. Noyes and J. Johnston:

$$1/\Lambda = 1/\Lambda_0 + K(c\Lambda)^{n-1}$$

By means of this function we have obtained the  $\Lambda_0$  values at 25° for all of the salts which have been studied. By combining these values with  $\Lambda_0\text{HCl}$  and  $\Lambda_0\text{NaCl}$  we have been able to calculate the limiting conductance at 25° of 31 organic acids in absolute alcohol solution. These  $\Lambda_0$  values, in the case of the 5 acids studied also by Goldschmidt, are uniformly lower than those obtained by the latter.

With a knowledge of the  $\Lambda_0$  values of the organic acids, it will be possible to estimate the dissociation and affinity constants of these acids in absolute alcohol solution.

## CHAPTER V.

### A STUDY OF THE DISSOCIATING POWERS OF FREE AND OF COMBINED WATER.

BY G. FRED. ORDEMAN.

#### INTRODUCTION.

The work of Uhler,<sup>1</sup> Anderson,<sup>2</sup> Strong,<sup>3</sup> Guy and Shaeffer,<sup>4</sup> and Paulus<sup>5</sup> on the absorption spectra of solutions in their relation to the phenomenon of solvation has been reviewed in a preliminary paper on this subject.<sup>6</sup> These investigators having found a marked physical difference between free water and combined or water of hydration in their behavior towards light, it was believed that a determination of the dissociation power of this combined water might lead to the establishment of further differences between it and free water. A few preliminary measurements showed the probability of such a difference in dissociating power. The present investigation is a continuation of this work along somewhat broader lines. For the sake of completeness, certain details of the method, although described in the preliminary paper, are repeated here. The object has been to ascertain the difference, if any, between the dissociating power of combined water or water of hydration and the dissociating power of uncombined or free water.

#### EXPERIMENTAL.

##### APPARATUS.

*Conductivity Apparatus.*—The improved slide-wire bridge used for the conductivity measurements was manufactured by The Leeds and Northrup Company, of Philadelphia. In this instrument the resistance wire, 5 meters in length, is wrapped around a porcelain drum. Readings were made corresponding in most cases to at least 0.25 mm. The resistance box had been standardized by the Bureau of Standards, Washington. An alternating current was supplied by an induction coil specially constructed for such work. The coil was actuated by a single lead accumulator and the strength of the current was regulated by adjusting the length of a thin manganin wire inserted between battery and coil. A telephone receiver was employed to determine the point of equilibrium. A double system of wiring was used between the

<sup>1</sup>Carnegie Inst. Wash. Pub. No. 60, 160 (1907). <sup>2</sup>*Ibid.*, 130 (1910). <sup>3</sup>*Ibid.*, 210, 9 (1915).

<sup>4</sup>*Ibid.*, 110 (1909).

<sup>5</sup>*Ibid.*, 190 (1913).

<sup>6</sup>*Ibid.*, 230, 161 (1915).

rheostat, bridge, and cell. Thus, by means of a rocking commutator with mercury contacts, the positions of rheostat and cell relative to the bridge could be interchanged so that both *a* and *b* could be read directly. All copper wire in the external circuit was of such a gage that the resistance was negligible. All connections were soldered.

*Cells.*—Because of the high resistance of the water used a special "water cell"<sup>1</sup> having large electrodes was necessary. The electrodes consist of two concentric platinum cylinders held in position by small drops of fusion glass in such a manner that they are about 1 mm. apart.

Because of the large conductivity of the solutions measured a different type of cell was demanded. The cell finally adopted for this work was that which has been previously used in this laboratory<sup>2</sup> for measurements of the conductivity of concentrated solutions. It consisted of a U-shaped tube made of difficultly soluble glass and fitted with ground-glass stoppers. A glass tube carrying a small platinum electrode is sealed by means of sealing-wax into the hole bored in the center of each stopper. The tubes were first held in position by tamping wet asbestos between them and the walls of the stoppers. The distance between the electrodes can be changed by removing the wax, adjusting the tubes, and resealing. The platinum plates are coated with platinum black. Numbers are etched upon the stoppers and the corresponding arms of the U-tubes, so that the electrodes will always be placed in the same U-tube and in the same position.

*Constant Temperature Bath.*—A constant temperature was maintained by the application of a principle most clearly stated by Morse:<sup>3</sup>

"If all the water or air in a bath is made to pass rapidly (1) over a continuously cooled surface which is capable of reducing the temperature slightly below that which it is desired to maintain, then (2) over a heated surface which is more efficient than the cooled one but which is under the control of a thermostat, and (3) again over the cooled surface, etc., it should be practicable to maintain in the bath any temperature for which the thermostat is set, and the constancy of the temperature should depend only on the sensitiveness of the thermostat and the rate of flow of the water or air."

The bath used is fully described by Davis and Putnam.<sup>4</sup> By means of an improved toluene-mercury thermo-regulator<sup>5</sup> and an electrically controlled gas valve<sup>6</sup> the temperature was maintained constant to within 0.01°.

A Beckmann thermometer graduated to 0.05° was used in the bath. Comparison was made with a thermometer recently standardized at the Bureau of Standards, Washington.

*Glassware.*—Measuring flasks, burettes, and pipettes were recalibrated by direct weighing. Jena glass bottles were used for keeping the solutions.

<sup>1</sup>Carnegie Inst. Wash. Pub. No. 180, 89 (1913); Amer. Chem. Journ., 45, 282 (1911).

<sup>2</sup>Zeit. physik. Chem., 49, 389 (1904).

<sup>4</sup>Carnegie Inst. Wash. Pub. No. 210, 119 (1915).

<sup>3</sup>Carnegie Inst. Wash. Pub. No. 198, 56 (1914). <sup>5</sup>*Ibid.*, 230, 13 (1915). <sup>6</sup>*Ibid.*, 210, 121 (1915).

## SOLVENTS.

*Water.*—The water was purified by the method of Jones and Mackay<sup>1</sup> as modified by Schmidt,<sup>2</sup> and had a mean specific conductivity of  $1.8 \times 10^{-6}$  at 25° C.

*Isohydic Solutions.*—If two solutions of electrolytes are mixed the conductivity of the mixture is, in general, less than the mean of the conductivities of the constituents. If the two solutions contain a common ion, however, there are concentrations at which they can be mixed without affecting each other's conductivity. This fact was first explained by Arrhenius.<sup>3</sup> He showed that if equal volumes of two solutions of acids of certain concentrations be mixed, the conductivity of the mixture is the mean of the conductivities of the solutions, provided there be no appreciable change in volume. Such solutions are said to be *isohydic*. Arrhenius<sup>4</sup> defines them as follows:

“Two solutions of acids are isohydic whose conductivity, or in other words, whose electrolytic dissociation, is not changed if they are mixed.”

Arrhenius worked out the condition for two solutions containing a common ion to be isohydic and has expressed it thus:

$$\frac{m\alpha}{v_1} = \frac{n\beta}{v_2} \quad (1)$$

In this equation,  $\alpha$  = percentage dissociation of the salt in solution,  $v_1$  = number of liters of solution containing a gram-molecular weight of the salt,  $m$  = number of common ions in each molecule of the salt.  $\beta$ ,  $v_2$ , and  $n$  are the respective symbols for the second solution.

It was further shown by Arrhenius that two acids are isohydic if in a unit volume they contain the same number of hydrogen ions. With this principle in mind the investigator, in the course of his work, determined the concentrations of five different pairs of salt solutions when they fulfill the condition of being isohydic. This method follows.

In calculating the percentage dissociation by the conductivity method

$$\alpha = \frac{\mu'}{\mu'_{\infty}} \quad \beta = \frac{\mu''}{\mu''_{\infty}} \quad (2)$$

Here,  $\mu'$  and  $\mu''$  = molecular conductivities of the two solutions;  $\mu'_{\infty}$  and  $\mu''_{\infty}$  = the conductivities at infinite dilution.

From the method of Kohlrausch for calculating conductivity

$$\mu' = k_1 \frac{a_1 v_1}{b_1 w_1} \quad \mu'' = k_2 \frac{a_2 v_2}{b_2 w_2} \quad (3)$$

<sup>1</sup>Amer. Chem. Journ., **19**, 90 (1897).

<sup>2</sup>Carnegie Inst. Wash. Pub. No. 180, 135 (1913).

<sup>3</sup>Wied. Ann., **30**, 51 (1887).

<sup>4</sup>Zeit. physik. Chem., **2**, 284 (1888).

$k_1$  and  $k_2$  are cell constants.  $a_1$ ,  $b_1$ , and  $a_2$  and  $b_2$  are the respective readings on the bridge for the resistances  $w_1$  and  $w_2$ .

Substituting the values of (3) in (2), we obtain

$$\alpha = \frac{k_1 a_1 v_1}{b_1 w_1} \quad \beta = k_2 \frac{a_2 v_2}{b_2 w_2} \quad (4)$$

Substituting now the values of (4) in (1)

$$\frac{m k_1 a_1 v_1}{b_1 w_1 \mu''_{\infty} v_1} = \frac{n k_2 a_2 v_2}{b_2 w_2 \mu''_{\infty} v_2} \quad (5)$$

If the same cell be used in determining the conductivities of the two solutions, then  $k_1$  equals  $k_2$ , and simplifying (5) we obtain

$$\frac{m a_1}{b_1 w_1 \mu'_{\infty}} = \frac{n a_2}{b_2 w_2 \mu''_{\infty}} \quad (6)$$

This is the general equation, which becomes further simplified for a particular case. A single illustration will make its meaning clear.

What concentration is necessary for a calcium nitrate solution that it be isohydric with regard to a molar solution of potassium nitrate? At 25° C., and this temperature was used throughout the work, for calcium nitrate,  $\mu'_{\infty}$  equals 257.99,<sup>1</sup> and for potassium nitrate,  $\mu''_{\infty}$  equals 148.39. Considering the nitrate ion,  $m = 2$  and  $n = 1$ . Therefore

$$\frac{2 a_1}{257.99 b_1 w_1} = \frac{a_2}{148.39 b_2 w_2}$$

Whence

$$\frac{a_1}{b_1 w_1} = .8693 \frac{a_2}{b_2 w_2}$$

Now by measuring  $a$  and  $b$  of the molar solution of potassium nitrate for the resistance  $w_2$ , the right-hand side of the equation becomes a constant. A concentrated solution of calcium nitrate was taken in different portions and diluted until, by trial, that concentration was found such that  $\frac{a_1}{b_1 w_1}$  became equal to the value for the right-hand side of the equation.

The concentration of the calcium nitrate was found to be 0.698 molar. And so a calcium nitrate solution of this concentration contains the same number of nitrate ions per unit volume as a molar solution of potassium nitrate.

#### SALTS.

The majority of the salts used were the purest obtainable from Kahlbaum. All the non-hydrated salts were carefully recrystallized from conductivity water and thoroughly dried at the temperature best

<sup>1</sup>All  $\mu_{\infty}$  values were taken from Carnegie Inst. Wash. Pub. No. 170 (1912), but are expressed here in reciprocal ohms instead of in Siemens units.



suiting to each salt. The hydrated salts, being so soluble, were in most cases not recrystallized, but dissolved in conductivity water, filtered, and used as concentrated solutions.

#### SOLUTIONS.

Solutions for the first three salts in table 100 were made as follows. Quantities of the isohydric solutions of the two chlorides were made. The amount of added salt necessary for each concentration was weighed upon a watch glass and introduced into a calibrated flask through a short-stemmed funnel. The salt was dissolved by one of the isohydric solutions and the flask placed in the bath regulated for 25° C. When the solution had come to temperature it was diluted to the mark with more of the isohydric solution. The process was now repeated, using the same flask and the other isohydric solution. But it was found that the volume change caused by the added salts was considerable. This means that the solutions when made would be of the proper strength for the added salt but weaker for the isohydric solutions. The results are, however, still comparable, as the volume change in the two isohydric solutions was found to be about the same.

Solutions for the other three salts in table 100 were made in a different manner. Instead of using the stock isohydric solutions, they were made up as needed. The amount of potassium chloride necessary to make the isohydric solution molar was weighed into the flask. The added salt, being a hydrated one, could not be weighed directly. It was added in the form of a concentrated solution of known strength from a small burette. The solutions were finally brought to the mark with conductivity water. For a comparable solution the necessary number of cubic centimeters of a concentrated calcium chloride solution of known strength to make the solution 0.6951 molar was used in place of potassium chloride. In this way solutions were obtained accurate with respect to the isohydric solutions but not with regard to the added salt, because of the errors due to improper drainage of concentrated solutions in a burette of such small bore.

It was finally decided to take the densities of the various concentrated solutions and to add these solutions by weight rather than by volume. The densities were taken with a pycnometer. The solutions were added to the weighed flasks (capacity 25 c.c.) from a burette with a finely drawn tip. With care the solutions could be weighed to within 1 or 2 mg., and this proved to be the most accurate method of handling these salts. As before the same flask was used for comparable solutions and the possibility of errors was thus, in part, avoided.

The strengths of the different concentrated solutions of the chlorides were determined by an estimation of the chlorine as silver chloride. The other concentrated solutions were analyzed for the cations. All solutions were made up at 25° C.

## PROCEDURE.

Six U-shaped cells were used in this work. Five of them had constants in the neighborhood of 14,000, while the sixth cell had a constant of 29,941. The constants were determined by means of a half-molar solution of potassium chloride. The molecular conductivity of this solution was found to be 115.71 reciprocal ohms at 25° C.

Two solutions were first made isohydric by the means described above. The specific conductivities of these solutions were measured by the usual method and calculated from the formula  $s = k \frac{a}{bw}$ . The same cell was employed for both solutions, so that any change in the cell constant or any error in its determination would be eliminated for comparison. Pairs of solutions were made which were isohydric with regard to each other and of a known molarity for an added salt. Three concentrations of each added salt were used. The specific conductivities of these solutions were now determined. When the conductivity of a solution, say molar with regard to potassium nitrate and half-molar with regard to sodium nitrate, had been measured, the cell was thoroughly cleaned and dried. The same cell was now used for the determination of the conductivity of a solution 0.6984 molar with respect to calcium nitrate—that is, isohydric with potassium nitrate and half-molar in regards to sodium nitrate. Thus possible errors were avoided.

The increase in conductivity of each isohydric solution was calculated for each added salt at every concentration and results are given in the third and fifth columns of each of the following tables. The difference between the increases for comparable solutions is found in the last column of each table. At the top of each table the concentrations of the two solutions which were isohydric are given.

In all cases the numbers given for conductivities are in reciprocal ohms and represent the mean of at least three readings on the bridge for different resistances.

## MEASUREMENTS.

The headings in tables 100 to 104 require some explanation. The two main headings in each table are the concentrations of the two solutions which were made isohydric;  $s$  and  $s'$  are the specific conductivities of solutions, say for 111.78 in table 100, molar for KCl and eighth-molar for NaCl.  $\Delta s$  and  $\Delta s'$  are the results obtained by subtracting from  $s$  and  $s'$  the specific conductivities of the corresponding isohydric solutions.  $\Delta s - \Delta s'$  is the difference in the increases  $\Delta s$  and  $\Delta s'$ .

TABLE 100.  
Molar for KCl; 0.695 molar for CaCl<sub>2</sub>.

Added salt.	V	$s$	$\Delta s$	$s'$	$\Delta s'$	$s - \Delta s'$
NaCl	8	118.82	8.70	106.91	7.92	0.78
NaCl	2	144.33	34.21	127.91	28.92	5.28
NaCl	1	172.30	62.17	151.66	52.67	9.50
KCl	8	122.65	12.52	109.86	10.87	1.65
KCl	2	158.12	47.99	140.91	41.92	6.07
KCl	1	203.76	93.63	180.69	81.70	11.93
NH <sub>4</sub> Cl	8	122.56	12.44	109.75	10.77	1.67
NH <sub>4</sub> Cl	2	157.59	47.46	140.38	41.29	6.18
NH <sub>4</sub> Cl	1	202.12	91.99	180.69	81.70	10.29
MgCl <sub>2</sub>	8	124.39	14.27	110.58	11.60	2.67
MgCl <sub>2</sub>	2	157.44	47.31	139.66	40.67	6.64
MgCl <sub>2</sub>	1	185.54	75.41	158.21	59.22	16.19
CaCl <sub>2</sub>	8	126.47	16.34	112.39	13.40	2.93
CaCl <sub>2</sub>	2	166.88	56.75	147.27	48.28	8.47
CaCl <sub>2</sub>	1	204.78	94.65	177.69	78.70	15.95
SrCl <sub>2</sub>	8	125.82	15.69	112.43	13.45	2.24
SrCl <sub>2</sub>	2	166.13	56.00	145.86	46.88	9.12
SrCl <sub>2</sub>	1	204.47	94.34	177.83	78.84	15.50

TABLE 101.  
Molar for NaCl; 0.597 molar for CaCl.

Added salt.	V	$s$	$\Delta s$	$s'$	$\Delta s'$	$\Delta s - \Delta s'$
NaCl	8	93.21	8.87	97.38	8.59	0.28
NaCl	8	117.77	33.42	119.70	30.91	2.51
NaCl	1	146.76	62.41	147.31	58.52	3.89
NH <sub>4</sub> Cl	8	97.17	12.82	99.67	10.87	1.95
NH <sub>4</sub> Cl	2	132.59	48.24	133.06	44.26	3.98
NH <sub>4</sub> Cl	1	177.05	92.70	175.16	86.37	6.33
MgCl <sub>2</sub>	8	98.05	13.70	101.16	12.36	1.34
MgCl <sub>2</sub>	2	129.95	45.60	129.80	41.01	4.59
MgCl <sub>2</sub>	1	157.52	73.17	164.44	65.65	7.52
CaCl <sub>2</sub>	8	99.37	15.02	102.72	13.93	1.09
CaCl <sub>2</sub>	2	138.24	53.89	138.73	49.94	3.95
CaCl <sub>2</sub>	2	175.42	91.07	172.73	83.93	7.13
SrCl <sub>2</sub>	8	99.79	15.45	103.16	14.37	1.07
SrCl <sub>2</sub>	2	138.74	54.39	139.10	50.31	4.08
SrCl <sub>2</sub>	1	175.88	91.53	110.22	85.21	6.32
KNO <sub>3</sub>	8	94.69	10.34	98.17	99.38	0.97
KNO <sub>3</sub>	2	122.59	38.24	122.52	33.73	4.51
KNO <sub>3</sub>	1	156.38	72.03	151.31	62.52	9.51

TABLE 102.

Molar for  $\text{NaNO}_3$ ; 0.681 molar for  $\text{Ca}(\text{NO}_3)_2$ .

Added salt.	V	s	$\Delta s$	$s'$	$\Delta s'$	$\Delta s - \Delta s'$
$\text{NaNO}_3$	8	81.77	7.25	83.53	6.06	1.19
$\text{NaNO}_3$	2	101.13	26.62	98.83	21.36	5.26
$\text{NaNO}_3$	1	123.40	48.89	116.71	39.24	9.65
$\text{KNO}_3$	8	83.49	8.97	84.92	7.45	1.52
$\text{KNO}_3$	2	108.83	34.31	105.44	27.97	6.35
$\text{KNO}_3$	1	138.18	63.66	129.79	52.32	11.34
$\text{NH}_4\text{NO}_3$	8	84.83	10.31	86.52	9.05	1.27
$\text{NH}_4\text{NO}_3$	2	114.10	39.59	111.81	34.33	5.25
$\text{Mg}(\text{NO}_3)_2$	8	87.01	12.49	87.52	10.05	2.44
$\text{Mg}(\text{NO}_3)_2$	2	116.62	41.11	109.53	32.06	9.05
$\text{Mg}(\text{NO}_3)_2$	1	140.45	65.94	128.26	50.79	15.15
$\text{Ca}(\text{NO}_3)_2$	8	85.28	10.77	86.00	8.53	2.24
$\text{Ca}(\text{NO}_3)_2$	2	109.01	34.49	104.34	26.87	7.62
$\text{Ca}(\text{NO}_3)_2$	1	125.69	51.17	115.68	38.20	12.97
$\text{Sr}(\text{NO}_3)_2$	8	84.00	9.48	85.01	7.54	1.95
$\text{Sr}(\text{NO}_3)_2$	2	104.46	29.94	99.74	22.27	7.67
$\text{Sr}(\text{NO}_3)_2$	1	115.42	41.23	106.92	29.44	11.78
KCl	8	84.81	10.29	87.01	99.54	0.75
KCl	2	115.09	40.57	113.72	36.25	4.33
KCl	1	155.72	81.20	149.74	72.27	8.93

TABLE 103.

0.5 molar for  $\text{NaNO}_3$ ; 0.310 molar for  $\text{Ca}(\text{NO}_3)_2$ .

Added salt.	V	s	$\Delta s$	$s'$	$\Delta s'$	$\Delta s - \Delta s'$
$\text{NaNO}_3$	8	50.78	8.43	51.78	7.67	0.75
$\text{NaNO}_3$	2	74.56	32.21	73.73	29.63	2.58
$\text{NaNO}_3$	1	101.50	59.15	98.06	53.96	5.19
$\text{KNO}_3$	8	52.68	10.33	53.67	9.57	0.77
$\text{KNO}_3$	2	81.80	39.45	80.72	36.62	2.83
$\text{KNO}_3$	1	115.64	73.29	111.90	67.80	5.50
$\text{NH}_4\text{NO}_3$	8	53.58	11.23	54.44	10.33	0.89
$\text{NH}_4\text{NO}_3$	2	86.60	44.25	85.36	41.26	3.00
$\text{NH}_4\text{NO}_3$	1	126.48	84.13	122.66	78.56	5.57
$\text{Mg}(\text{NO}_3)_2$	8	57.33	14.98	57.83	13.72	1.25
$\text{Mg}(\text{NO}_3)_2$	2	94.39	52.04	91.71	47.60	4.44
$\text{Mg}(\text{NO}_3)_2$	1	126.18	83.83	120.63	76.53	7.30
$\text{Ca}(\text{NO}_3)_2$	8	56.12	13.77	56.72	12.62	1.15
$\text{Ca}(\text{NO}_3)_2$	2	88.13	45.78	86.46	42.36	3.42
$\text{Ca}(\text{NO}_3)_2$	1	112.60	70.25	108.49	64.39	5.87
$\text{Sr}(\text{NO}_3)_2$	8	55.13	12.78	56.01	11.91	0.87
$\text{Sr}(\text{NO}_3)_2$	2	83.23	40.88	81.96	37.85	3.03
$\text{Sr}(\text{NO}_3)_2$	1	103.27	60.92	99.05	54.95	5.97
KCl	8	53.94	11.59	55.14	11.03	0.55
KCl	2	89.30	46.95	88.67	44.56	2.39
KCl	1	132.99	90.64	130.94	86.84	3.81

TABLE 104.

Molar for  $\text{KNO}_3$ ; 0.698 molar for  $\text{Ca}(\text{NO}_3)_2$ .

Added salt.	$V$	$s$	$\Delta s$	$s'$	$\Delta s'$	$s - \Delta s'$
$\text{NaNO}_3$	8	97.84	7.09	84.69	5.80	1.29
$\text{NaNO}_3$	2	116.64	25.89	98.83	20.94	4.95
$\text{NaNO}_3$	1	138.90	48.15	117.73	38.84	9.31
$\text{KNO}_3$	8	100.08	9.33	86.26	7.34	1.95
$\text{KNO}_3$	2	125.02	34.26	106.61	27.83	6.43
$\text{KNO}_3$	1	155.41	64.66	131.04	52.15	12.51
$\text{Sr}(\text{NO}_3)_2$	8	99.75	9.00	86.00	7.11	1.89
$\text{Sr}(\text{NO}_3)_2$	2	117.89	27.14	100.25	21.37	5.77
$\text{Sr}(\text{NO}_3)_2$	1	128.86	38.11	108.09	19.20	8.91
$\text{KCl}$	8	102.38	11.63	88.13	9.25	2.38
$\text{KCl}$	2	136.72	45.97	115.05	36.16	9.81
$\text{KCl}$	1	180.38	89.63	150.27	71.38	18.25
$\text{NaCl}$	8	100.08	9.33	86.08	7.20	2.14
$\text{NaCl}$	2	125.94	35.20	107.22	28.34	6.86
$\text{NaCl}$	1	156.15	65.41	131.75	52.86	12.54

## DISCUSSION OF RESULTS.

The conductivity values to be found in the second and fourth columns of tables 100 to 104 are not the sums of the specific conductivities of the two salts present in each case, but are less than this sum because of the common ion effect. Furthermore, since the two solutions in any given case contain the same number of anions, the added salt not being considered, the driving back of the dissociation of the added salt by these anions, other things being equal, would be the same. An inspection of the tables will show that for every pair of solutions studied this suppression is more pronounced in the hydrated solutions. Or, stating it in another way, the increase in conductivity caused by the addition of the same amount of added salt is always greater in the non-hydrated solutions. This means that the added salts dissociate more in the last-named solutions than in the comparable isohydric solutions of hydrated salts.

A closer inspection of the tables reveals the fact that the driving back of the ionization of the hydrated salts added is much greater than the driving back of comparable quantities of non-hydrated salts in both isohydric solutions of every pair studied. A comparison of tables 102 and 103 will show that for any one added salt the difference in the increases of conductivity in table 102 is approximately double the corresponding difference in table 103. Finally, a few salts were added which do not have ions in common, and these behaved in somewhat the same manner as the other added salts, though the results are somewhat irregular. How can all these facts be explained?

A tentative explanation based upon these somewhat limited observations is offered which is by no means final. When a salt is added to water or to the solution of another added salt, the added salt is dissociated by the water present. It is believed that combined water—*i. e.*, water of hydration—in the solution of hydrated salts possesses less ionizing power than the uncombined water, in which case the salts added would be less dissociated. And further, this effect would be greater the greater the concentration, since more combined water would then be present. The hydrated salts used as added salts are less dissociated than the other added salts because water of hydration now exists in both of any pair of solutions. However, the dissociation is always less in the case of the hydrated salt of any pair because of the less dissociating power of the water of hydration already present in that solution.

These results and conclusions which follow are to be regarded as preliminary. The nitrates and chlorides have been used and not the sulphates, principally because they are less liable to form double salts. But in the concentrated solutions it can not be said with certainty that no complexes were present.

Values for the degree of dissociation based upon the equation  $\alpha = \frac{\mu}{\mu_{\infty}}$  are somewhat open to doubt.<sup>1</sup> The conductivity of a solution (apart from experimental errors) is dependent to a greater or less extent upon the viscosity of the medium and the migration velocity of the ions. The latest relation between viscosity and conductivity has been deduced by Washburn and Clark.<sup>2</sup> Unfortunately this is of little value in applying a viscosity correction, since one of the factors is dependent upon the nature of the medium and there is at present no means of evaluating it for solutions of strong electrolytes.

Considering the speed of the ions, no quantitative correction can be made. It will be noticed that normal solutions of sodium and potassium nitrates have been paired with calcium nitrate solutions. The migration velocity of potassium is greater, while that of sodium is less than the migration velocity of  $\frac{1}{2}$  calcium, yet this fact hardly affects the results. Lewis<sup>3</sup> has recently held that the speed of ions actually increases rather than decreases with increasing concentration, and so the degree of dissociation based upon the conductance ratio is always too high. The evidence either way, however, is not conclusive.

From his extensive work upon dielectric properties of solutions, Walden<sup>4</sup> concludes that the presence of salts in solutions increases the ionizing power of the solvent. With this granted, the hydrated salts may be said to alter the dielectric constant differently from the non-

<sup>1</sup>Journ. Amer. Chem. Soc., 38, 788 (1916).

<sup>2</sup>*Ibid.*, 38 (1916).

<sup>3</sup>*Ibid.*, 37, 1043 (1915).

<sup>4</sup>Zeit. physik. Chem., 55, 683 (1906).

hydrated salts, since we believe their ionizing powers to be different. This does not mean that the combined water is more or less associated, for while the dissociating solvents with highest dielectric constants are usually most highly associated, the principle is not without exception.

The results presented here are relative. It would be interesting to make a further study along the same lines, but eliminating any influence of viscosity by the use of some indifferent substance such as sucrose. Then, too, a determination of the dielectric constants of the various pairs of solutions by one of the methods suggested by Drude<sup>1</sup> or Smale<sup>2</sup> should lead one to a more definite statement.

---

<sup>1</sup>Wied. Ann., **59**, 17; **60**, 600.    <sup>2</sup>*Ibid.*, **57**, 215; **60**, 625.





## CHAPTER VI.

### THE DIFFERENCE IN CHEMICAL ACTIVITY OF FREE AND SEMI-COMBINED WATER AS ILLUSTRATED BY THE EFFECT OF NEUTRAL SALTS ON THE HYDROLYSIS OF ACETIC ANHYDRIDE.<sup>1</sup>

BY GERALD C. CONNOLLY.

#### INTRODUCTION

##### HYDROLYSIS.

The term "hydrolysis" is applied to a number of chemical reactions in which there is first the addition of water to a complex, and then the decomposition of the product into simpler substances. From this definition it is evident that the reactions included under hydrolysis are numerous and varied. There are, in general, four main divisions of hydrolysis:

- (1) Hydrolysis of metallic salts.
- (2) Hydrolysis of esters and closely associated substances, such as amides, nitriles, acid chlorides, acid anhydrides, etc.
- (3) Hydrolysis of complex carbohydrates and glucosides.
- (4) Hydrolysis of polypeptides and proteins.

In this discussion we will confine ourselves almost entirely to the first two divisions, for these are the only forms of hydrolysis which come within the scope of this investigation.

##### HYDROLYSIS OF ACETIC ANHYDRIDE.

The hydrolysis of acetic anhydride has been studied by several investigators with varying degrees of success. The term "hydrolysis of acetic anhydride" is used here in preference to the term "hydration of acetic anhydride" used by other investigators, since it is more in accordance with the definition of hydrolysis previously stated. The work of previous investigators has been carefully reviewed in a preliminary paper on this subject. Therefore it need only be referred to here when bearing directly on the present work.

Menschutkin and Vasilieff,<sup>2</sup> in studying the decomposition of acetic anhydride by water, found that with a mixture of equal portions of acetic anhydride and water at 19° only about one-half the anhydride was hydrolyzed at the end of 6 hours, and 11 days were necessary for complete hydrolysis. In table 105, taken from their work, a comparison is made between the velocities of decomposition of acetic

<sup>1</sup>See preliminary paper on this subject in Carnegie Inst. Wash. Pub. No. 230.

<sup>2</sup>Jour. Russ. Phys. Chem. Soc., **21**, 188 (1889).

anhydride, acetamide, and ethyl acetate by 1 gram-equivalent of water at 100° under the same conditions. The experiments were carried out in the presence of acetic acid.

TABLE 105.<sup>1</sup>

Substance . . . . .	Acet. Anhyd. +1 H <sub>2</sub> O	Acetamide. +1 H <sub>2</sub> O	Ethyl Acetate. +1 H <sub>2</sub> O
Acetic acid added	<i>Per cent.</i> 11.86	<i>Per cent.</i> 15.85	<i>Per cent.</i> 11.45
Decomposition:			
1 min.	25.68	4.51	0.2
11	83.9	4.64	.5
61	98.5	4.94	.87
121	99.5	5.82	.99
181	99.7	6.41	...

The acetic anhydride was almost entirely decomposed at the end of 1 hour, while the decomposition of the acetamide was slight and that of the ethyl acetate had hardly begun.

A. and L. Lumiere and Barbier showed that when acetic anhydride is dissolved in water the solution possesses practically all the properties of acetic anhydride itself, but that if more than 12 parts of the anhydride are used solution is incomplete. Table 106 shows their results with 5 and 10 per cent solutions of the anhydride in cold water. Aliquot parts of each solution were withdrawn at 10-minute intervals and added to a known slight excess of aniline, which reacted quantitatively with the nonhydrolyzed portion of the acetic anhydride, forming acetanilid and an equivalent of acetic acid. Subsequent titration with a normal solution of sodium by dioxide gave the total acid present, from which the degree of hydrolysis of the acetic anhydride was calculated. From their results it can be seen that the rate of hydrolysis is fairly rapid at first and then gradually decreases. It is the more rapid the greater the initial dilution of the anhydride and the higher the temperature.

TABLE 106.—*Hydrolysis of Acetic Anhydride by Water.*

Time	5 per cent Solution.		10 per cent Solution.	
	15°	0°	15°	0°
0	9.2	4.6	11.5	9.8
10	52.5	35.0	58.2	34.6
20	74.2	48.4	71.0	51.1
30	89.7	60.8	78.9	60.0
40	95.7	69.0	86.6	67.0
50	100.0	76.2	91.7	73.3
60	....	80.4	93.3	77.9
70	....	85.5	94.6	81.5
80	....	89.6	96.4	85.1
90	....	93.8	97.9	88.9
100	....	96.9	100.0	92.8
110	....	100.0	....	94.8
120	....	....	....	95.8
140	....	....	....	98.5
160	....	....	....	100.0

Alcoholic solutions of the anhydride were also prepared, and it was found that when molecular proportions were used, esterification was incomplete, even after a month.

<sup>1</sup>Bull. Soc. Chim. (III) 33, 783 (1905); 35, 625 (1906).

Orton and M. Jones, in addition to studying the velocity of hydrolysis of acetic anhydride in acetic acid and water, investigated the effect of catalysts. It was found that acids are powerful catalysts of the hydrolysis. The effect is most noticeable in media containing but little water, and diminishes as the proportion of the water increases, being least obvious in pure water. The value of the velocity factor is a linear function of the concentration of the acid. Alkalis and hydrolyzed salts were also found to act as strong catalysts of the hydrolysis in aqueous solutions. The following equations were given to represent the mechanism of the hydrolysis:

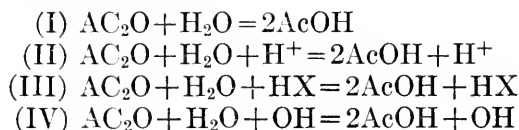

Any one of the four forms could predominate, according to the conditions, medium, etc. In aqueous solutions the choice lies between (I), (II), and (IV).

#### HYDROLYSIS OF SALTS.

It is a well-known fact that certain salts, even though they contain the strictly equivalent quantities of acid and base required for "neutrality," when dissolved in water are not neutral to indicators, but react either acid or alkaline. This was first noticed by H. Rose, in working with certain basic salts, but was not explained satisfactorily until Arrhenius proposed his theory of electrolytic dissociation. In the light of this theory acidity is due to the presence of an excess of hydrogen ions, while alkalinity is due to the presence of an excess of hydroxyl ions. These ions can not be accounted for by the salts themselves; therefore they must be accounted for by the water.

Water must contain both hydrogen and hydroxyl ions. The ionization constant of water can be calculated by the equation

$$\frac{\text{H}^+ \times \text{OH}^-}{\text{H}_2\text{O}} = k$$

Since the active mass of the nonionized water is so great in comparison with the active mass of the ions, it may be considered constant. We then have  $\text{H}^+ \times \text{OH}^- = k \text{H}_2\text{O}$ , the value of  $k$  being  $1.2 \times 10^{-14}$  at  $25^\circ$ . This ionization is the same in all aqueous solutions. The value  $k_{\text{H}_2\text{O}}$ , however, increases with rise in temperature. This increase is most probably due to the breaking down of the associated molecules into the simpler ones, which are more easily dissociated. Pure water contains an equal number of hydrogen and hydroxyl ions, and therefore must react neutral. Furthermore, this relation holds for any neutral solution. To be acidic, a solution must contain an excess of

hydrogen ions; to be basic, an excess of hydroxyl ions. To determine whether a solution is neutral or not, we therefore make use of indicators, such as litmus, methyl orange, phenolphthalein, which give evidence by their color changes.

When a normal salt is dissolved in water, partial hydrolysis takes place, yielding free acid and free base. Whether the solution will react acid or alkaline will depend on the degree of dissociation of these products of hydrolysis. It follows, therefore, that there are four types of salts which may undergo hydrolysis: (1) salts derived from strong acids and strong bases; (2) salts of weak acids and strong bases; (3) salts of strong acids and weak bases; (4) salts of weak acids and weak bases. All salts except those of the first type are hydrolyzed to a considerable extent, due to the small degree of dissociation of one or of both of the products of hydrolysis. Salts of strong acids and strong bases under ordinary conditions do not undergo hydrolysis.

The determination of the degree of hydrolysis is not accomplished without difficulty. The free acid or base can not be directly titrated with a standard solution, for equilibrium would be destroyed at once and neutrality would be reached only when the salt was completely decomposed. A method must then be employed which will not destroy the hydrolytic equilibrium. The methods most generally used are:<sup>1</sup> (1) the determination of the velocity constant for the hydrolysis of an ester, for this is proportional to the amount of free acid or alkali present; (2) the determination of the rate of inversion of cane sugar; (3) the determination of the electrical conductivity of the solution; (4) the determination of the coefficient of distribution between two solvents. There are also many other methods of more or less limited applicability.

Only those salts were used in this investigation which were proved by the above methods to be nonhydrolyzed. For these salts the values of  $k$  calculated according to the equation

$$\frac{(\text{Salt})}{(\text{Acid}) \times (\text{Base})} = \frac{k}{k_{\text{H}_2\text{O}}}$$

are so small that they need not be taken into account. The salts were further tested according to an observation made by Salm,<sup>2</sup> that salts which give no reaction with litmus have a concentration of  $\text{H}^+$  and  $\text{OH}^-$  ions less than  $1 \times 10^{-6}$ , a value so small that it is negligible.

#### NEUTRAL SALT ACTION.

In a discussion of neutral salt action one must distinguish clearly between the effect produced by a neutral salt on the catalytic activity of an acid (or alkali), and the effect of the neutral salt on hydrolysis by water alone. It is the latter effect in which we are most interested

<sup>1</sup>R. C. Farmer: B. A. Reports, 240 (1901).

<sup>2</sup>Zeit. physik. Chem. 57, 471 (1907).

in this investigation, although the former is what is generally understood by the term "neutral salt action."

#### EFFECT OF NEUTRAL SALTS ON THE CATALYTIC ACTIVITY OF ACIDS.

It was early found<sup>1</sup> that the addition of a substance which is largely ionized in aqueous solution alters the rate of hydrolysis of esters or of carbohydrates by strong acids. This has been proved by the addition of metallic chlorides to mixtures in which hydrochloric acid is the catalyst, the addition of bromides to hydrobromic acid, and of nitrates to nitric acid. Those chlorides which are highly dissociated have much the same effect, while a salt like mercuric chloride, which is only partially ionized, has a much feebler action. Non-electrolytes, such as the alcohols of sugars, have but little effect on the hydrolytic activity of the hydrogen ions.

The action of the neutral salt is not always to accelerate the hydrolysis; often there is a retardation. There are also well-defined differences between the influence of neutral salts on the rate of inversion of cane sugar in the presence of acids and their influence in the catalytic hydrolysis of esters. The velocity of the inversion of cane sugar is increased to a much greater extent by the addition of certain concentrations of salts than is the velocity of the hydrolysis of esters.

Neutral salts have in general a retarding effect upon the hydrolysis of esters and amides by alkalis. Senter,<sup>2</sup> however, found that the hydrolysis of sodium chloroacetate by sodium hydroxide was greatly accelerated by the presence of neutral salts. It has been shown that neutral salt action is independent of the concentration of the compound hydrolyzed, is proportionally greater the more dilute the acid solution, is not greatly influenced by temperature or pressure, and is independent of the nature of the acid employed as catalyst.

In addition, Poma<sup>3</sup> has determined that the intensity of the action developed by neutral salts bears a strict relation to the chemical nature of the ions of the salts and diminishes in passing from chlorides to bromides to nitrates to iodides, in succession; that it is independent of the chemical nature of the cations; and, finally, that it seems to be proportional, not to the concentration of the salt in the solution, but to the concentration of the ions.

#### EFFECT OF NEUTRAL SALTS ON HYDROLYSIS BY WATER ALONE.

Probably the first work done on neutral salt action in the absence of an acid was by Smith,<sup>4</sup> who investigated the effect of neutral salts on the rate of inversion of cane sugar. He found that salts of weak acids had almost no effect, while potassium chloride and sodium sulphate, the more nearly neutral salts, had considerable effect.

<sup>1</sup>Journ. prakt. Chem. **85**, 321, 401 (1862).

<sup>3</sup>Medd. K. Vetenskapsakad. Nobelinst., **2**, No. 11, 1-28.

<sup>2</sup>Journ. Chem. Soc. **91**, 473 (1907).

<sup>4</sup>Zeit. physik. Chem. **25**, 144 (1898).

Senter showed that neutral salts have practically no effect on the decomposition of sodium chloroacetate by water.

Kellogg<sup>1</sup> studied the effect of the neutral salts, potassium chloride, potassium bromide, and potassium iodide on the velocity of the hydrolysis of ethyl acetate. The reactions were carried out in sealed tubes at 100°, using a fixed quantity of ester and varying concentrations of the salt solution. The results obtained show that the specific influence of salts is greater in somewhat dilute solutions. As the concentration is increased, the effect gradually becomes less until it reaches zero, and then becomes negative in character; for example, a 4-normal solution of potassium chloride hydrolyzes the ester more slowly than pure water itself. Kellogg found a decrease in the accelerating power from chloride to bromide to iodide, which is in reverse order to their stability.

Henderson and Kellogg<sup>2</sup> continued the investigation, using the chlorides of sodium, lithium, calcium, strontium, and barium, and the chloride and iodide of cadmium. They carried out the work under the same conditions as before and also measured the conductivities and viscosities of the solutions at the concentrations and temperatures employed in the experiments; and from these calculated the degree of ionization. They found that the salts which produce the greatest effect are those which are the least ionized. The accelerating effect of lithium chloride is greater than that of sodium chloride, although the degree of ionization of the former is less, while the chlorides of calcium, barium, and strontium have a greater effect than either sodium chloride or potassium chloride, although they too are less ionized. Cadmium chloride, the least ionized of all the chlorides studied, produced the greatest effect, due probably to the hydrolysis of the salt. Henderson and Kellogg concluded that the effect produced by a neutral salt on the hydrolysis of ethyl acetate is due to a specific influence on the non-ionized portion of the salt, rather than to any function of the ions.

There have been several suggestions put forward to explain neutral salt action. Arrhenius<sup>3</sup> proposed that the salts may affect the substance which is being hydrolyzed; that there may be present in the solution an equilibrium between an active and an inactive form of the substrate, and that this equilibrium may be altered through changes of temperature or ionic concentration. Armstrong and Caldwell concluded that the salts act by removing part of the water in the form of definite hydrated compounds, and in this manner increase the concentration of the reacting substance. Stieglitz explained salt effect in general by the theory that the presence of salts in the solution increases the dielectric constant, or at any rate the ionizing power of the solvent. All of these theories are plausible, but it is highly improbable that neutral salt action is due to any one cause exclusively.

---

<sup>1</sup>Journ. Amer. Chem. Soc. **31**, 403, 886 (1909).   <sup>3</sup>Zeit. phys. Chem. **4**, 226 (1889).

<sup>2</sup>*Ibid.*, **35**, 396 (1913).

## STATEMENT OF THE PROBLEM.

The object of this investigation and the methods used were fully outlined in the preliminary paper. However, in order that the completed work may be more readily understood, they are repeated here in some detail.

The studies on the absorption spectra of solutions carried out in this laboratory by Anderson, Strong, Guy, Shaeffer, and others led to the conclusion that a marked physical difference exists between free and combined water. It seemed desirable, therefore, to determine whether a similar chemical difference was to be found. With this in view, Holmes and Jones<sup>1</sup> took up a study of the action of strongly hydrated salts and slightly hydrated salts on the hydrolysis of methyl acetate and methyl formate. The method used consisted in measuring the velocity of hydrolysis of the ester by pure water and by solutions of slightly and strongly hydrated salts. The solutions were prepared in such a way that the amount of water in each was the same and was equal to the amount of pure water employed. Taking into account the hydrolysis of the strongly hydrated salts, they found that these salts hydrolyzed the ester much more rapidly than pure water itself.

The reaction studied by Holmes and Jones was a very slow one and indicated that combined water has greater activity than free water. We wished to investigate the same problem, using a reaction that proceeded much more rapidly; therefore we chose the reaction involving the conversion of acetic anhydride into acetic acid.

## EXPERIMENTAL.

## PURIFICATION OF ACETIC ANHYDRIDE.

Pure acetic anhydride was necessary for the work. The physical properties as described in the literature vary greatly. The boiling-points given range anywhere from 135° to 140° at 760 mm. pressure. The densities given vary between 1.07 and 1.09. From this it can be seen that it was impossible to test its purity by the ordinary simple means. Acetic acid is the impurity most likely to be present in the anhydride, and is very difficult to detect if only small amounts are present. 0.51 gram of pure acetic anhydride, when completely hydrolyzed, is equivalent to 100 c.c. N/10 solution of sodium hydroxide, while the same weight of a mixture containing 1 per cent of acetic acid is equivalent to 99.85 c.c. This is within the experimental error.

Methods of finding the actual percentage of acetic acid and anhydride in a mixture have been given by Pickering,<sup>2</sup> Menshutkin and Vasilieff,<sup>3</sup> Treadwell,<sup>4</sup> Edwards and Orton,<sup>5</sup> and Orton and Jones.<sup>6</sup> Pickering

<sup>1</sup>Carnegie Inst. Wash. Pub. No. 230 (1915).

<sup>2</sup>Journ. Chem. Soc. **63**, 1000 (1893).

<sup>3</sup>Journ. Russ. Phys. Chem. Soc. **21**, 190 (1889).

<sup>4</sup>Analytical Chemistry, 1914, vol. 11.

<sup>5</sup>Journ. Chem. Soc. **99**, 1181 (1911).

<sup>6</sup>*Ibid.*, **101**, 1720 (1912).

determined the freezing-points of the solutions of anhydride and water, and compared them with the freezing-points of known concentrations of acetic acid. Menschutkin and Vasilieff treat with aniline and water, and determine the acidity after the reaction



has taken place. Treadwell recommends treatment with barium-hydroxide solution and titration of the excess of the latter, while Edwards and Orton convert the anhydride into acetanilid, the latter into phenylacetylchloramine, and then determine the chloramine volumetrically.

The method finally adopted to purify the acetic anhydride was that of repeated distillation, using a 5-bulb distilling head and discarding the first and last fractions. This gave an anhydride which distilled practically constant at 138° to 139°. Specific gravity determinations, using a 10 c.c. pycnometer, gave a mean value of 1.0852 at 15°/4°. The acetic anhydride was further tested by titrating weighed samples both directly and by the method advocated by Menschutkin and Vasilieff.

#### PURIFICATION OF SALTS.

Only the purest salts obtainable were used. They were usually Kahlbaum preparations, although some of other well-known firms were used. These salts were dissolved in conductivity water, filtered from any foreign matter present, and then recrystallized one or more times.

#### APPARATUS.

*Thermostats.*—The constant-temperature baths were of the improved form designed by Davis<sup>1</sup> of this laboratory. The thermometers were of the differential Beckmann type. They were compared with a standard thermometer, which had been calibrated at the Bureau of Standards. Flasks, pipettes, and burettes for measuring purposes were all carefully calibrated by weight. All bottles used (varying in content from 50 to 6.1 c.c.) and all measuring flasks were of Jena glass. A special apparatus was used for the alkali solution, to protect it from carbon dioxide and water vapor in the air.

#### SOLUTIONS.

The water used in the preparation of the solutions was purified by the method of Jones and Mackay<sup>2</sup> as modified by Schmidt.<sup>3</sup> It had a conductivity at no time greater than  $2 \times 10^{-6}$ .

The aniline used to combine with the excess of acetic anhydride was the purest obtainable. It was further distilled as many times as necessary to remove all decomposition products. The slightly colored product was then kept in a cupboard protected from light.

<sup>1</sup>Carnegie Inst. Wash. Pub. No. 210 (1914).

<sup>3</sup>*Ibid.*, 19, 90 (1897).

<sup>2</sup>Amer. Chem. Journ., 17, 83 (1895).



The solutions of the non-hydrated salts were made up directly by weight, while those of the hydrated salts were analyzed gravimetrically and diluted to the required strengths. The chlorides of barium, strontium, calcium, and magnesium were determined as silver chloride and the sulphates of sodium and magnesium were determined as barium sulphate.

The solution of sodium hydroxide used in titrating the acetic acid formed by the hydrolysis of the acetic anhydride was made up approximately half-normal, using "sodium hydroxide from alcohol." It was preserved in an apparatus protected from the impurities in the air. It was standardized by titration against a solution of sulphuric acid of about the same strength (0.4115 N). The sulphuric acid had been standardized as barium sulphate.

The indicator used was phenolphthalein, as it gives the best results in titrating a weak acid with a strong alkali, the only objection being that it is also sensitive to carbonic acid. Corallin had been tried, but was not so satisfactory.

#### METHOD OF PROCEDURE.

The method in principle is a modification of that of Menschutkin and Vasilieff,<sup>1</sup> and later employed by A. and L. Lumiere and Barbier.<sup>2</sup> In order that the results should be comparable, the amount of water present must be kept constant; therefore the specific gravity of the salt solution was first taken, giving the weight of 1 c.c. From analysis, that part of the weight due to the anhydrous salt alone was known for each cubic centimeter. This known weight of salt, subtracted from the weight of 1 c.c. of solution, gave the weight due to the pure water alone. This, divided into the weight of 1 c.c. of pure water at that temperature, gave the amount of solution in cubic centimeters equivalent to 1 c.c. of pure water. The amount of solution thus calculated was pipetted into a 250 c.c. Jena bottle. An equivalent of 100 c.c. of pure water was taken in all determinations. The bottle was suspended in the constant-temperature bath. There was also placed in the bath a bottle containing the anhydride and a number of small empty bottles of 50 c.c. capacity.

When all had come to the temperature of the bath, the bottle was removed and 5 c.c. of the anhydride introduced. Time was reckoned from when the anhydride was first added. Solution took place immediately on shaking, except in the case of the very concentrated solutions. Aliquot portions were removed and placed in the small 50 c.c. bottles, the whole being kept in the bath. These small bottles were removed, first every 5, then every 10 minutes, and a slight known

<sup>1</sup>Carnegie Inst. Wash. Pub. No. 60, 160 (1907).

<sup>2</sup>*Ibid.*, 130 (1910); 190 (1910).

excess of aniline added. On shaking, this combines with the residual acetic anhydride, precipitating acetanilid and liberating an equivalent of acetic acid. In one bottle of each series the reaction was allowed to go to completion without the addition of aniline, so as to control the results obtained.

The total amount of acetic acid was then determined in the bottle by titration with the half-normal solution of sodium hydroxide in the presence of phenolphthalein as indicator. Never less than 10 c.c. nor more than 25 c.c. of alkali, as measured in a 50 c.c. burette, was required to neutralize the acetic acid.

Two temperatures, 15° and 25°, were employed. Only one concentration of acetic anhydride was used (approximately 5 per cent), because if two were employed the results would not be comparable on account of volume changes. For the salts molar, half-molar, and quarter-molar solutions were taken in all cases, and whenever possible solutions of greater concentration.

Measurements of the velocity were not taken for longer than 60 minutes at 15° and 40 minutes at 25°, for it was found that the hydrolysis of the acetic anhydride by water was then practically complete.

#### CALCULATIONS.

From the total amount of acetic acid, as determined by titration with the alkali, that due to the water alone must be calculated. The simple formula  $y = 2z - x$  is used, where  $y$  is the amount of acetic acid due to the water alone,  $z$  is the total amount of acetic acid measured by titration, and  $x$  is the total amount of acid that can be formed if all the acetic anhydride has been hydrolyzed.

The results obtained for the "control" bottles, when substituted in the formula, should give the same values for  $x$  and  $y$ , which would be equivalent to 100 per cent hydrolysis.

#### DATA.

In tables 107 to 116 the concentrations of salt solutions are M, molar; M/2, half-molar, etc. Time is expressed in minutes. All results are expressed in percentages, 100 per cent meaning complete hydrolysis of the acetic anhydride. In each table there is placed for comparison a column showing the percentage decomposition of acetic anhydride by water alone.



TABLE 111.

Time.	Concentration—Barium Chloride at 15°.				Concentration—Barium Chloride at 25°.			
	Water.	M	M/2	M/4	Water.	M	M/2	M/4
5	30.99	30.51	31.49	34.48	44.54	39.57	42.04	46.89
10	54.15	50.56	54.98	56.88	72.76	68.43	73.23	75.90
20	78.43	74.68	78.60	81.05	93.71	91.25	92.00	93.94
30	90.22	86.83	90.30	91.09	98.31	97.85	97.99	98.19
40	96.87	92.96	95.76	96.20	99.53	98.44	98.72	98.85
50	98.18	97.09	97.66	98.10	.....	.....	.....	.....
60	99.01	98.10	99.10	99.88	.....	.....	.....	.....

TABLE 112.

Time.	Concentration—Strontium Chloride at 15°.					Concentration—Strontium Chloride at 25°.				
	Water.	2 M	M	M/2	M/4	Water.	2 M	M	M/2	M/4
5	30.99	20.80	27.44	32.33	35.22	44.54	31.40	41.11	47.17	47.89
10	54.15	39.43	48.17	55.15	57.00	72.76	57.58	72.15	74.35	76.01
20	78.43	63.31	74.88	78.86	80.89	93.71	84.43	90.86	92.87	94.37
30	90.22	76.46	87.19	90.56	92.07	98.31	94.38	96.47	98.79	98.85
40	96.87	84.93	94.40	95.89	96.30	99.53	98.19	98.71	99.58	99.64
50	98.18	89.84	97.28	98.00	98.43	.....	.....	.....	.....	.....
60	99.01	92.18	98.42	99.08	99.32	.....	.....	.....	.....	.....

TABLE 113.

Time.	Concentration.—Sodium Sulphate at 15°.				Concentration.—Sodium Sulphate at 25°.			
	Water.	M	M/2	M/4	Water.	M	M/2	M/4
5	30.99	.....	38.98	37.16	44.54	61.51	54.62	50.52
10	54.15	.....	65.30	60.57	72.76	87.56	82.84	79.32
20	78.43	.....	86.15	83.74	93.71	98.16	96.95	96.02
30	90.22	.....	94.07	93.27	98.31	99.38	99.22	99.16
40	96.87	.....	96.64	96.43	99.53	99.83	99.71	99.63
50	98.18	.....	98.32	98.13	.....	.....	.....	.....
60	99.01	.....	99.65	98.97	.....	.....	.....	.....

TABLE 114.

Time.	Concentration—Magnesium Sulphate at 15°.				Concentration—Magnesium Sulphate at 25°.			
	Water.	M	M/2	M/4	Water.	M	M/2	M/4
5	30.99	41.62	41.88	37.99	44.54	56.61	50.98	55.23
10	54.15	66.49	67.34	61.09	72.76	84.26	78.72	80.46
20	78.43	86.65	88.45	83.71	93.71	95.49	95.82	95.99
30	90.22	92.71	96.43	93.33	98.31	96.48	98.17	98.29
40	96.87	94.85	98.30	96.96	99.53	98.13	99.71	99.82
50	98.18	97.44	98.83	98.96	.....	.....	.....	.....
60	99.01	98.37	99.13	99.43	.....	.....	.....	.....

TABLE 115.

Time.	Concentration—Potassium Nitrate at 15°.					Concentration—Potassium Nitrate at 25°.				
	Water.	2 M	M	M/2	M/4	Water.	2 M	M	M/2	M/4
5	30.99	21.93	26.50	30.59	31.78	44.54	34.44	35.56	37.03	41.64
10	54.15	36.35	44.79	51.24	53.35	72.76	51.90	54.37	65.93	69.71
20	78.43	58.29	64.15	74.33	77.15	93.71	77.03	82.07	88.45	90.92
30	90.22	71.53	80.91	86.18	88.76	98.31	88.69	94.58	96.48	98.01
40	96.87	81.37	87.11	92.74	94.85	99.53	94.94	97.30	98.60	98.84
50	98.18	89.93	93.80	95.91	97.20	.....	.....	.....	.....	.....
60	99.01	92.27	96.14	97.43	98.49	.....	.....	.....	.....	.....

TABLE 116.

Time.	Concentration.—Sodium Nitrate at 15°.					Concentration.—Sodium Nitrate at 25°.				
	Water.	2 M	M	M/2	M/4	Water.	2 M	M	M/2	M/4
5	30.99	21.69	26.38	32.36	33.66	44.54	33.14	36.80	41.07	41.64
10	54.15	36.23	45.73	53.12	54.52	72.76	54.72	63.93	69.01	69.94
20	78.43	59.80	70.35	77.27	79.14	93.71	80.20	86.68	90.58	90.92
30	90.22	73.51	81.95	87.93	89.11	98.31	91.87	95.77	97.06	97.54
40	96.87	81.49	91.10	93.61	94.85	99.53	96.59	97.89	98.24	98.83
50	98.18	89.11	94.38	97.81	96.85	.....	.....	.....	.....	.....
60	99.01	92.47	97.01	98.07	98.37	.....	.....	.....	.....	.....

## DISCUSSION OF RESULTS.

There is one difficulty in the study of this problem that must first be pointed out, *i. e.*, the use of a strong alkali solution (half-normal NaOH) with which to titrate the acetic acid formed. This necessarily introduces some error, since a difference of 0.1 c.c. in reading the burette would make a difference of over 1 per cent. A more dilute solution of alkali could not be used, since too large a quantity of such a solution would be required.

As noted in the preliminary paper on this subject, the rate of decomposition of the acetic anhydride is at first very rapid, being almost complete at 25° in 5 minutes and nearly three-quarters complete at the end of 10 minutes, then gradually decreasing as the reaction approaches completion. In this respect the reaction differs from similar ones studied, such as the hydrolysis of esters, since in these cases the reactions are reversible. Temperature has a marked accelerating influence on the hydrolysis, the velocity of the reaction as a whole and the increase for succeeding intervals of time being much greater at 25° than at 15°.

All the salts studied, with the exception of sodium sulphate and perhaps also magnesium sulphate, have in the case of the greater concentrations a retarding influence on the hydrolysis. This retardation diminishes as the salt solution becomes more and more dilute. With sodium sulphate solutions the reverse is true—the more concentrated the solution the greater is the accelerating effect. This is also true to a certain extent with magnesium sulphate, although the effect is not so pronounced.

In the case of both magnesium salts studied, magnesium chloride and magnesium sulphate, it was difficult to get clear, clean-cut results. In titrating the acetic acid with the alkali in the presence of these salts a good end-point could not be reached. The color of the indicator, phenolphthalein, appeared to be masked, especially in the more concentrated solutions.

All the non-hydrated salts studied have a hindering effect on the hydrolysis. The amount of this hindrance under the same conditions is practically the same for the four salts studied, there being at no time a variance of more than a few per cent. With the most dilute solutions studied, quarter-molar, the results for the decomposition are practically the same as for pure water.

The hydrated salts, with the exception of magnesium chloride, all give results for the decomposition greater than those of the non-hydrated ones, while with the more dilute solutions there is an appreciable acceleration of the hydrolysis of the acetic anhydride over that due to pure water alone. Sodium sulphate and magnesium sulphate at all concentrations studied have a very marked accelerating effect on the hydrolysis. Greater concentrations of these salts were not used for the reason that they do not mix with the anhydride at once on simple shaking. Calcium chloride, strontium chloride, and barium chloride also have an accelerating influence on the hydrolysis in the more dilute solution. Magnesium chloride acts as do the non-hydrated salts, having a retarding influence at all dilutions.







MBL WHOLE LIBRARY



WH 18H4 -

14996

