

DISPLACEMENT INTERFEROMETRY APPLIED TO ACOUSTICS AND TO GRAVITATION

By CARL BARUS

*Hazard Professor of Physics and Dean of the Graduate Department
in Brown University*



PUBLISHED BY THE CARNEGIE INSTITUTION OF WASHINGTON
WASHINGTON, 1921

159
CARNEGIE INSTITUTION OF WASHINGTON

PUBLICATION No. 310

PRINTED BY J. B. LIPPINCOTT COMPANY
AT THE WASHINGTON SQUARE PRESS
PHILADELPHIA, U. S. A.

PREFACE.

The experiments of the present volume are either direct applications of displacement interferometry or they embody the correlative work which has grown out of such applications, often at widely different times. In the arrangement of the chapters it has therefore been expedient to depart from chronological order in favor of an arrangement of subjects which belong together.

In a former report* I had already used a U-tube in connection with the interferometer, but the design of the apparatus was limited in scope. In the present paper (Chapter I) the open mercury manometer is made directly available for pressure measurement, and as the attainable sensitiveness is easily a few hundred thousandths of a centimeter of mercury per fringe displacement, it is well worth while to see what can be gained by using it. The applications to air thermometry on a micrometric scale and an attempt to revive the old absolute electrometer in Chapter II are merely incidental, though in each case much more may be done than I have here attempted, as I hope to show at some other opportunity. The manometer also admits of further improvement in ways which can not be included in the present report.

A more suitable field for testing the immediate capabilities of the mercury U-tube is detailed in Chapters III and IV, where the endeavor is made to give an account of the pressures and dilatations observable in a region vibrating acoustically. If this is quite closed or quite open to the atmosphere, the record of the U-tube within is without interest; but if the region is all but closed up—open, for instance, through a pin-hole less than 0.5 mm. in diameter—the gage shows pronounced fringe displacements as a rule and particularly at the frequency of the harmonics. If the sound generator is a telephone, the displacements are proportional to the effective currents actuating it and at the harmonics much more than 10,000 ohms may be put in circuit before the fringes cease to move appreciably. Similarly under low resistance, very small fractions of a semi-tone are registered and the ear becomes a poor apparatus for discrimination. The investigations are made along two lines, in the first of which the sound generator and the U-tube lie within the boundary carrying the pin-hole; in the second the sound generator lies without and is independent, so that the pin-hole valve carried on a long tube becomes an appropriate probe, or sonde, for the pressures within sounding pipes and cavities. As all the harmonics are thus saliently registered, there should be no serious difficulty in exploring the acoustics of the mouth cavity uttering word sounds, for instance. A curious result of the survey of the distribution of pressure increments in relation to pitch is the replacement of pressures by dilatations in different orders of frequency.

* Carnegie Inst. Wash. Pub., No. 249, II, Chap. V, 1917; *ibid*, Chap. VI, § 72.

In Chapter V, on the direct interferometry measurements of the compression of a sound-wave, much of my work has been superfluous, as it was anticipated in an admirable paper by Raps, using the Jamin interferometer. I have therefore given only as much as is necessary for the coordination of the other chapters. My method, however, is, I think, superior, owing to its much greater flexibility and the ease with which fringes in any orientation may be produced and shortened to a string of silvery beads. The simple organ-pipe blower or adjustable embouchure much used in the chapter will, I think, be found serviceable for many purposes, both of research and instruction.

As the telephone is an indispensable convenience throughout these chapters, it was thought necessary to begin an interferometer investigation on the vibrations of the plate of that remarkable instrument. What comes out definitely in the research, Chapter V, is the readiness of the plate to quiver in overtones. A small mirror at the center is not therefore displaced, as a rule, translationally, but rather rotationally, giving rise to very complicated wave-forms, difficult to analyze. In corroboration of this, it was found (in Chapters IV and V, for instance) that a telephone current may often be commutated.

In the endeavor to place the Foucault mirror on the interferometer I have thus far, for incidental reasons, failed of achievement; but as different apparatus useful in experiments of the present kind were tried out in the course of the work, I have given a brief account of it in Chapter VII. In Chapters VIII and IX, in deference to the wishes of Dr. R. S. Woodward, I have begun a search for methods of measuring the acceleration of gravity other than those classically in use. Such an inquiry necessarily consists in referring gravitational forces to forces generated in other mechanisms. An interferometer torsion-balance is first tested, but the results are found to contain relatively large and uncontrollable temperature coefficients, both of rigidity and viscosity, even if the ordinary effects of viscosity can be allowed for. The other (pneumatic) method for g , in which gravitational pull is referred to the pressure of a gas, has at the outset much to recommend it, for it admits of rough handling in spite of the otherwise surprising precision of results. The two errors which offer a serious menace to the accurate hydraulic weighing of the Cartesian diver, viz, the diffusion and solution discrepancies, though at first approach apparently insuperable, may not remain so indefinitely. At least, in experiments on the diffusion and convection of gases in narrow tubes, made in the lapse of years, coefficients of a negligibly small order of value were obtained. Though the work is very laborious, I think it will be worth while to carry it further.

The remainder of the volume is largely concerned with work (Chapters XI and XII) bearing on the constant of gravitation. The object of these experiments was at the outset a mere endeavor to read the deflections of the gravitation needle by displacement interferometry. The plan succeeded at once, almost beyond my expectations; but on computing the Newtonian constant it came out actually several times too large. It was obvious that this could

be explained only by the presence of relatively large radiant forces. Noticing, in the course of the work, that the latter, in some mysterious way, almost always acted in the same sense as gravitation, I became much interested in the endeavor to trace the radiant forces to their source and if possible to learn to control them. Much of Chapter XI is given to work of this kind, and among other things the attempt is made to refer the constant of gravitation to the viscosity of the medium in which the needle moves. The most curious results in relation to the radiant forces were obtained by submerging the whole of the gravitational apparatus in a capacious water-bath well stirred, so that the temperature varied but a few tenths of a degree per day. Notwithstanding these apparently ideal conditions, the needle simply drifted and showed no response to gravitation whatever. The best method of reducing the radiation discrepancy in question, thus far found, consists in the exhaustion of the case containing the needle. Results so found came within 1 per cent of the normal value, but were still in excess. No doubt this is far from precision, but it is a great advance from an error of several hundred per cent of excess. The further development of the method of attack I hope to complete this summer, by making the exhaustion as rigorous as possible.

In the last chapter I have put together a number of incidental results, bearing (as in Chapter VIII) on the breakdown of molecular instabilities evidenced by the peculiar phenomena of residual viscosity. In a similar experiment, showing the magnetic set in iron produced by an electrical current passing through it, we have, as it were, an element of hysteresis. A useful method for the production of two groups of independent fringes, present in the same field, is also given.

My thanks are due to Miss Rachel Tupper Easterbrooks for efficient assistance throughout the editorial work necessary for the preparation of the present report.

CARL BARUS.

BROWN UNIVERSITY, *June 1921.*

CONTENTS.

CHAPTER I.—*The Open Mercury Manometer read by Displacement Interferometry.*

	PAGE
1. Apparatus.....	I
2. Experiments.....	1
3. Equations and pressure observations.....	2
4. Air thermometer.....	3
5. Acoustic pressure, etc.....	4

CHAPTER II.—*The Interferometer U-tube used as an Absolute Electrometer.*

6. Electrical condenser.....	5
7. Fringes from a free mercury surface.....	6
8. Equations.....	6
9. Specific inductive capacity.....	9
10. Allowance for the electrometer.....	10
11. Absolute values.....	11
12. Improvements and miscellaneous experiments.....	12

CHAPTER III.—*Acoustic Pressures and Dilatations chiefly in Reservoirs.*

13. Introductory. Apparatus.....	14
14. Observations. Closed and open resonators.....	15
15. Resonator all but closed.....	15
16. Pressure depending on the frequency and on the intensity of vibration.....	16
17. Fringe deflection varies as current intensity.....	16
18. Pin-hole sound-leaks.....	17
19. Effect of resonance.....	18
20. Inside and outside stimulation.....	20
21. Apparent removal of pressure decrements.....	21
22. Reversal of poles of telephones changes sign of fringe deflection.....	23
23. Change of volume of reservoir.....	24
24. U-tube used differentially.....	24
25. Conical vents reversible. Periodicity.....	26
26. Resonators of very large capacity.....	27
27. Resonators of very small capacity.....	28

CHAPTER IV.—*The Pin-hole Probe for Sound Pressures.*

28. The pin-hole sonde, or probe.....	31
29. Pressures in smooth, straight pipes.....	33
30. Symmetrical induction.....	35
31. Closed region with pipe.....	36
32. Closed organ-pipe.....	37
33. Open pipes and adjutages.....	37
34. Reversal of poles of telephone.....	38
35. Open pipe on the interferometer.....	40
36. Helmholtz spherical resonator.....	41
37. Correlative experiments with the torsion balance.....	43
38. Conclusion.....	44

CHAPTER V.—*The Compression of a Sound Wave in Diapason Pipes.*

39. Introduction.....	46
40. Apparatus.....	46
41. Observations with crossed pipes.....	47
42. Deductions.....	47
43. Stroboscopic and other secondary phenomena.....	48
44. Observations with longitudinal pipes.....	49
45. Organ-pipe blower.....	50
46. Interference.....	51
47. Reed pipes, voice.....	52
48. General result.....	53

CHAPTER VI.—*The Vibration of the Telephone Plate.*

	PAGE
49. Phenomena.....	55
50. Interpretation. Lines. Oscillation about a vertical axis.....	56
51. Shadow waves. Oscillation about horizontal axes.....	58
52. Beating fringe-waves.....	58
53. Effect of temperature. Miscellaneous observations.....	59
54. Synchronism. Iron screw-core.....	61
55. Shattered fringes.....	62
56. Wave frequencies. Musical notes.....	63

CHAPTER VII.—*Experiments Made in the Endeavor to Place the Revolving Mirror on the Interferometer.*

57. Apparatus. Revolving mirror normal.....	65
58. Lens train.....	66
59. Estimate.....	66
60. The inclined revolving mirror and interferometer.....	67
61. The revolving telescope objective.....	68
62. Control fringes.....	69
63. Sensitiveness.....	69
64. Experiments with the rotating telescope. Fringes on washed images.....	70
65. The combined revolving mirror and telescope.....	71

CHAPTER VIII.—*On the Torsional Measurement of Variations of Acceleration of Gravity, by Interferences.*

66. Apparatus.....	74
67. Measurements.....	76
68. Thicker wire.....	77
69. Equations.....	80
70. Absolute viscosity of the wire.....	81
71. Twist in one direction only.....	82
72. Observations on the permanently twisted wire.....	83
73. Further experiments with the preceding apparatus.....	84

CHAPTER IX.—*A Pneumatic Method of Measuring Variations of Acceleration of Gravity.*

74. Introductory.....	87
75. Apparatus.....	87
76. Equations.....	89
77. Observations.....	90
78. Sheathed or inclosed divers.....	93
79. The swimmer under pressure.....	95
80. Stems of small bore.....	97
81. The diffusion of air through water in the lapse of years.....	98

CHAPTER X.—*Gravitational Experiments, chiefly with Reference to the Accompanying Radiant Forces.*

82. Introductory.....	101
83. Apparatus.....	101
84. Long-period observations.....	102
85. Long-period observations in the lapse of time.....	103
86. Short-period observations.....	107
87. Further observations.....	110
88. New apparatus.....	111
89. Trial observations. Radiation effect.....	112
90. Radiation effect observed on exhaustion.....	113
91. Tendency of needle to stick to glass window.....	116
92. Needle excursions under increasing pressure.....	116
93. Experiments with the exhausted case.....	118
94. Tentative estimate.....	119
95. Angular velocity at different pressures.....	120
96. Water-bath.....	120
97. Attraction <i>in vacuo</i>	123
98. Apparatus No. III. Brass and glass.....	124
99. Metallic case cooled by efflux.....	128

CHAPTER XI.—*Gravitational Experiments.*

PAGE

100. Slender needles.....	131
101. Experiments with slender needles.....	132
102. Torque exerted on the stem.....	135
103. Contemporaneous experiments.....	136
104. Filamentary needle.....	137
105. Observations.....	139
106. The residual radiation forces.....	139

CHAPTER XII.—*Miscellaneous Experiments.*

I. Heavy Gravitational Systems.

107. Attractions in case of a heavy needle.....	141
108. Apparatus.....	141
109. Observations.....	142

II. The Torsional Magnetic Energy Absorption of an Iron Conductor.

110. Apparatus.....	144
111. Observations.....	144
112. Data.....	145
113. Longitudinal field.....	145

III. Liquid Refraction Near a Solid Surface.

114. Methods and first experiment.....	146
115. Second experiment.....	147

IV. Comparison of Two Independent Sets of Fringes.

116. Apparatus.....	148
---------------------	-----



CHAPTER I.

THE OPEN MERCURY MANOMETER READ BY DISPLACEMENT INTERFEROMETRY.

1. **Apparatus.**—This is practically a U-tube, AmA' , figure 1, with wide shanks A, A' connected by a channel m below. A and A' are cylindrical hollows, 2 to 3 cm. deep and about 5 cm. in diameter, cut in a rectangular block BB' , preferably of iron. The connection m must also often be large in section, so as to admit of rapid flow from A to A' . The U-tube is charged with mercury, MmM' , M and M' being as shallow as possible to counteract the tendency to vibration. Thin plane parallel glass plates, gg' , round disks of equal thickness and diameter, are floated on the mercury, which act as mirrors for the interferometer beams L' and L'' and also materially check the tendency of the pool of mercury to vibrate. It would be desirable to be able to use the mercury surfaces at M and M' directly without the intervention of the plate, but all attempts to do this, within the city limits, were at first failures. Moreover, the amplitude of vibration in the trough further from the source of light is much in excess. Later I found the fringes, but could not use them with advantage.

The top of the iron block BB' is recessed as shown, to receive the plane parallel glass plates G, G' . These, like g, g' , must be equally thick, otherwise the fringes will be multiplied and faint. The annular space $cccc$ between G and B is filled with resinous cement, poured in the molten state. The air-space AA' , shut off in this way, communicates with the atmosphere by two tubulures, t and t' , in the front side.

The ray parallelogram of the quadratic interferometer, of which L', L'' are the interfering rays, should be vertical. The displacement of the achromatic fringes of white light are read off by a telescope with an ocular micrometer (scale-part 0.01 cm.). The fringes parallel to the divisions of the micrometer are conveniently made a scale part in size. The block BB' should be mounted separately from the interferometer. If it is placed on the base of the latter, all manipulations there shake the mercury in BB' and it is necessary to wait for subsidence. This, however, occurs very soon, so the separate mounting is not absolutely necessary. Without manual interference the fringes are about as quiet as in a solid apparatus.

2. **Experiments.**—To test this apparatus the air-space AA' was left with a plenum of air. With A' communicating with the atmosphere, A was joined through t and a filamentary capillary glass or metal tube to an apparatus by which slight pressure could be applied. In the first trials I attempted to use a water manometer controlled by a micrometer-screw; but the vibrations of the meniscus were at once impressed on MM' , so that the fringes were hard to keep at rest. I then devised the apparatus shown in figure 2, which is merely

an adaptation of the pin-valve of an oxygen tank, with a good micrometer-screw s and stuffing-box n . The head h of the screw is graduated. The barrel b is at right angles to the tube aa' , which at a joins the capillary tube d , leading to t of figure 1. At the end a' there is a cock C which shuts off communication with the atmosphere. Thus, when C is closed, pressure is applied directly at A , figure 1, by rotating the head h in figure 2. This pressure is at once removed by opening C .

The apparatus worked surprisingly well. When C is closed and h rotated, the fringes may be placed anywhere in the field about as conveniently as with the micrometer-screw at the mirror of the interferometer. There is, however, one difficulty which I have not thus far been able to remove. When the pressure increments exceed a certain small value, the plates g, g' no longer rise and fall in parallel. The coincidence of images is destroyed and the fringes vanish. There is here a conflict with the capillary forces present at the edges of the disk. I endeavored to improve this by using small plates g, g' , anchored near the center of MM' by four loose threads, but the advantage was not marked. Fringes a scale-part in size will not usually be available for more than 50 scale-parts, being sharpest in the middle. This is about half the diameter of field of the ordinary telescope.

3. Equations and pressure observations.—If the cock C , figure 2, is closed and the temperature for brief intervals is considered constant, Boyle's law may be written (ignoring signs of increments)

$$(1) \quad \frac{dv}{V} - \frac{dV}{V} = \frac{dp}{p} = \frac{dh}{76}$$

where V is the total volume inclosed, dv the increment at the micrometer-screw hs , and dV the corresponding decrement equivalent to the pressure decrement dp . If a is the area of the piston at g , $dV = a dh/2$, and if $V = aH$, H being the corrected depth of the air-space at A , equation (1) becomes

$$(2) \quad \frac{dv}{V} - \frac{dh}{2H} = \frac{dh}{76}$$

But dh on the interferometer is equivalent to n fringes of wave-length λ , so that $dh = n\lambda/2$. Hence finally

$$(3) \quad dv = V \frac{\lambda}{2} \left(\frac{1}{76} + \frac{1}{2H} \right) \cdot n$$

This equation gives a test of the trustworthiness of the gage.

In the apparatus used the following constants were found by measurement: $V = 66.8 \text{ cm.}^3$, $a = 29.2 \text{ cm.}^2$, $H = 2.29 \text{ cm.}$ The pitch of the screw was 0.073 cm. and its mean diameter 0.51 cm. Hence, per turn, $dv = 0.073 \times 0.204 = 0.0149 \text{ cm.}^3$, and $dv/V = 10^{-4} \times 2.23$ per turn. The mean wave-length being $\lambda = 6 \times 10^{-5} \text{ cm.}$, equation (3) reduces to $\left(\frac{1}{2} \left(\frac{1}{76} + \frac{1}{2H} \right) = 0.0066 + 0.1092 \right)$

$$n = \frac{10^{-4} \times 2.23}{6 \times 10^{-5} \times 0.1158} = 32 \text{ fringes per turn of screw } hs$$

In the experiments fringes of one-half scale-part were installed. In separate experiments, immediately after closing the cock *C*, a half turn of the screw produced a displacement of 8.3, 8.0, 8.0, 8.5, 8.5 scale-parts; as the average, therefore, 16.4 scale-parts per turn or about 33 fringes per turn. This agrees as closely as may be expected with the number computed.

The pressure increment per turn of screw is $dp = n\lambda/2$ cm. of mercury or per turn of screw about 10^{-3} cm.; per fringe, therefore, 3×10^{-6} cm. of mercury as anticipated. A range of about 2 or 3 turns of screw was possible with each fringe, *i. e.*, the range of pressure measurement should be from 3×10^{-5} to 3×10^{-3} cm. of mercury.

Experiments of the same kind were made in great variety. There is no difficulty in using much larger fringes, so that 3×10^{-6} cm. of mercury should be appreciable. By exhausting both sides of the U-tube the apparatus becomes a vacuum gage. I did not, however, attempt such work, as the present apparatus was not well adapted for the purpose.

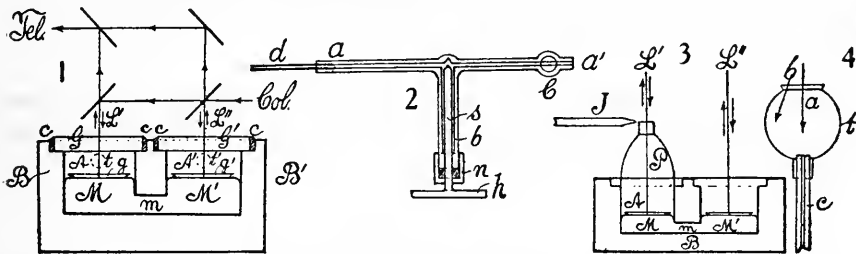

4. Air-thermometer.—If the cock *C* is permanently closed, the air-space *A* becomes the bulb of an air-thermometer of approximately constant volume. In this way the heat produced by the rays of light *L'* may be measured. In a variety of experiments of the kind, the mean result was about 10 scale-parts or 20 fringes in a lapse of 210 seconds. If τ denotes absolute temperature, the intrinsic equation may now be written

$$\frac{dp}{p} + \frac{dV}{V} = \frac{d\tau}{\tau}$$

which reduces as above to

$$\frac{dh}{76} + \frac{dh}{2H} = \frac{d\tau}{\tau}$$

Thus, if $\tau = 300^\circ$,

$$d\tau = \tau n \frac{\lambda}{2} \left(\frac{1}{76} + \frac{1}{2H} \right) = 10^{-3} \times 2.1n^\circ \text{ C.}$$

and for $n = 20$ in 210 seconds,

$$d\tau = 0.042^\circ \text{ C.}$$

or the heating produced was 2×10^{-4} ° C. per second. Whether, supposing AA' to be filled with water, a pyrheliometer may be constructed on this principle I have yet to learn.

Other interesting results of the same kind might be mentioned. Thus, if the screw stop-cock, figure 2, is closed quickly, there is always a decided increment of pressure. In other words, in consequence of the viscosity of air, the fine space at the plug is virtually a closure before the screw is checked by an actual cloture.

5. Acoustic pressure, etc.—If the glass plates G are removed and the air-space A partially closed with a pipe P (fig. 3) tapering to a neck, PAM becomes a closed organ-pipe with a bottom sensitive to pressure. The pipe may be blown with the adjustable embouchure j described in § 45, and sufficient free space remains for the component rays $L' L''$ of the interferometer to reach the mercury MM' . The neck should not much exceed an inch in diameter.

It was hoped that when the pipe was sounded judiciously, acoustic pressure, if any, would be shown at the bottom. A large number of experiments were made, at first with very weak pipe-notes corresponding to a very mild jet j . Displacements of 5 to 10 fringes nevertheless occurred in the direction of pressure, *i. e.*, up to about 4 dynes/cm.². In later experiments, however, suction was quite as often obtained as pressures, so that what is registered here is the pressure effect of the nearly horizontal air-current from j across the top of the pipe. With strong notes the fringe displacement was much greater and the slit-images tended to separate, destroying the fringes. The results obtained, therefore, are merely those of a pipe sounding under slightly reduced or slightly increased pressure, and all attempts to eliminate the discrepancy failed.* Resonance was ineffective.

The same effect is nicely shown with a thistle-tube t (fig. 4), provided with a small-bore (0.1 cm.) stem c , slightly raised as shown. If a jet from a pin-hole is blown in axially, as at a , the effect is pressure; if blown in obliquely or tangentially, as at b , the effect observed is suction. The displacements were 10 or more fringes, to the right or to the left.

* The method which ultimately succeeded is described in Chapter III.

CHAPTER II.

THE INTERFEROMETER U-TUBE USED AS AN ABSOLUTE ELECTROMETER.

6. **Electrical condenser.**—Adjusting the U-tube as in figure 5, with the top plates removed so as to admit a metallic disk C , above the mercury M (earthed at E , electrode at a) and parallel to it, CM becomes an absolute electrometer. The disk C is perforated at c , so the component rays L' , L'' may reach the mercury. Unfortunately this instrument is not very sensitive in any case and is chiefly useful in measuring electrostatic potentials. If p is the electric pressure below the disk C , charged at potential difference V , and h is the head of mercury resulting,

$$(A) \quad V = d\sqrt{8\pi p} = d\sqrt{8\pi h\rho g} = d\sqrt{4\pi\lambda\rho g \cdot n}$$

where d is the distance of C from M , ρ the density of mercury, and λ the wavelength of light when n fringes correspond to V . Hence, if $d = 0.1$ cm., $V = 0.1\sqrt{4\pi \times 6 \times 10^{-5} \times 13.6 \times 981 \times n} = 0.317\sqrt{n}$ els., units; or $V = 95\sqrt{n}$ volts. In the experiments d was made slightly over 0.38 cm.; but of this, 0.23 cm. were in glass and 0.15 cm. in air.

The usual experiments with the electroscope were carried out about as conveniently as with that instrument, with all the data in absolute units. Thus a charged hard-rubber rod near a metallic plate connected with C gave measurably up to 40 fringes.

With larger potentials the images were apt to separate and the fringes vanish. The range may be varied (d), and steady or alternating potentials are both within reach of the instrument.

To avoid the effect of specific inductive capacity, a small thin mirror, say 1 cm. in diameter, may be anchored with loose silk fibers below the hole in the center of the electrode. Otherwise, in the presence of glass plates it would seem that the above equation should be modified to read

$$(B) \quad V = d\sqrt{8\pi p/k}$$

and if K_g is the specific inductive capacity of the glass, d_a and d_g the thickness of the layers of air and glass respectively so that $d = d_a + d_g$

$$1/K = (d_a + d_g/K)/d$$

Thus, if $K_g = 6$, $d_g = 0.23$ cm., $d_a = 0.15$ cm., $1/K = 0.5$

$$V = d\sqrt{8\pi p \times 0.5} = 0.84\sqrt{n}(\text{els}) = 253\sqrt{n} \text{ volts}$$

where n is the number of fringes.

It is not, however, obvious that either equation (A) or equation (B) are at once applicable. An investigation of this will be made in § 10, showing that equation (A) suffices and that d is to be measured from the top face of the glass plate g to the lower face of the parallel electrode C .

To test the electrometer, figure 5, a screw electrophorus was constructed as shown in figure 6, where p and p' are the two plates and r the insulating layer of hard rubber. The screw-post s , rising from the center of the plate p' , passes through the screw-sleeve of brass b , embedded in the hard-rubber handle h , which in turn is firmly screwed into and supports the plate p . By rotating the handle h , the plate p is raised or lowered by an amount shown on the spring rod a , which is also the upper electrode. Fractions of a turn are read off on the graduated top face of p . The lower electrode is at E . As the insulation sbh appeared inadequate, the construction was modified by removing s , raising b , and allowing a supporting screw, similar to s , to enter the handle h from above, retaining the feature of rotation. The new form is shown in figure 7, k being the graduated head referred to the stem C . The plate d is clutched by the same standard which supports p' . This left the space between r and p clear for the insertion of dielectrics of different specific inductive capacity.

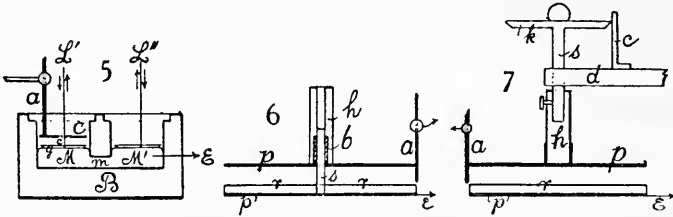

In figures 6 and 7, a and e are to be joined with a and e of figure 5. It would have been desirable, of course, to provide the condenser CM in figure 5 with a guard-ring. If B is an insulator, this would apparently occasion no serious difficulty; for a fixed metallic ring or short cylinder coaxial with M and partially submerged in it would suffice. The upper face of the ring should be flush with M . The apparatus used, however, was not well adapted for this purpose.

7. Fringes from a free mercury surface.—By making the troughs of the U-tube very shallow (a few millimeters), fringes were obtained rather easily. They were entirely too mobile to be used with convenience. The curious feature was observed, however, that even with pools 6 cm. in diameter the rise and fall of the mercury faces on the two sides was not rigorously in parallel. In fact, the slit-images separated and the fringes vanished about as soon as when floating glass plates were used. This discrepancy is to be referred to some type of surface viscosity, which, if the mercury had been quite chemically pure, would possibly have disappeared, rather than to an inequality of the electric field at the surface. The experiments with the guard-ring alluded to were also abandoned because of the mobility of the mercury surface even when using thin glass plates 1 to 2 cm. in diameter.

8. Equations.—If we treat the case of the electrophorus as a closed cylindrical field of cross-section A , and if V_0 is the potential of the charged hard-rubber surface, we may write

$$(1) \quad Q' = \frac{AK'}{4\pi d'} (V' - V_0)$$

where Q' V' is the positive charge and potential in the top plate, at a distance d' from the rubber surface at potential V_0 and K' are the specific inductive capacity of the dielectric medium. Similarly, if $Q''V''$ is the charge and potential of the lower plate at a distance d'' from V_0 , a layer of specific inductive capacity K'' lying between,

$$(2) \quad Q'' = \frac{AK''}{4\pi d''} (V'' - V_0)$$

But

$$(3) \quad Q' + Q'' = Q,$$

the fixed charge on the rubber surface.

If the two plates are put in contact,

$$(4) \quad V' = V''$$

so that on combination

$$(5) \quad Q' = Q \frac{K'd''}{K''d' + K'd''} \quad Q'' = Q \frac{K''d'}{K''d' + K'd''}$$

Furthermore, if the two plates thus charged are kept insulated and the top plate is moved normally towards the lower a distance of y (figure 6),

$$(6) \quad \frac{4\pi}{A} \left(\frac{Q'}{K'}(d' - g) - \frac{Q''}{K''d''} \right) = \Delta V = d\sqrt{4\pi\lambda\rho g n}$$

ΔV being the potential difference thus produced and measured at the U-tube electrometer taken as small in capacity in comparison with the electrophorus. Hence, on inserting equations (5) and reducing,

$$(7) \quad -\Delta V = \frac{4\pi Q d'' y}{A(K''d' + K'd'')}$$

It follows that $y^2 = (\text{constant}) n$; or the locus is a parabola.

Among the experiments made to test this equation, it suffices to give the data in figure 8, in which the displacement of fringes, n , is laid off vertically downward, and the turns of the screw s in the apparatus figure 6 (pitch one-twentieth inch) horizontally, the plates having been put in contact at 4 turns above the hard-rubber face ($d' = 0.51$ cm., $d'' = 0.16$ cm., turn = 0.127 cm.). The zero of n is here arbitrary. When the plate moves down the parabolic form of curve is apparent. When it moves up from 4 turns, however, the character of the curve soon changes. In other words, lines stray in the latter case, whereas the stray field is caught to some degree in the former. Furthermore, the capacity of the U-tube has been disregarded. Finally, the unfortunate leak in the apparatus (fig. 6) is shown by a marked hysteresis-like difference in the outgoing and return series, as indicated by the arrows.

The second modification (fig. 7) of the electrophorus was then used with the plates quite separated and the micrometer-screw above. The insulation was much better, the loss amounting to not more than 2 fringes in 10 minutes at full charge. The pitch of the micrometer-screw being now 0.1 cm., the upper plate was conveniently discharged when $d' = 1$ cm. above the hard-rubber

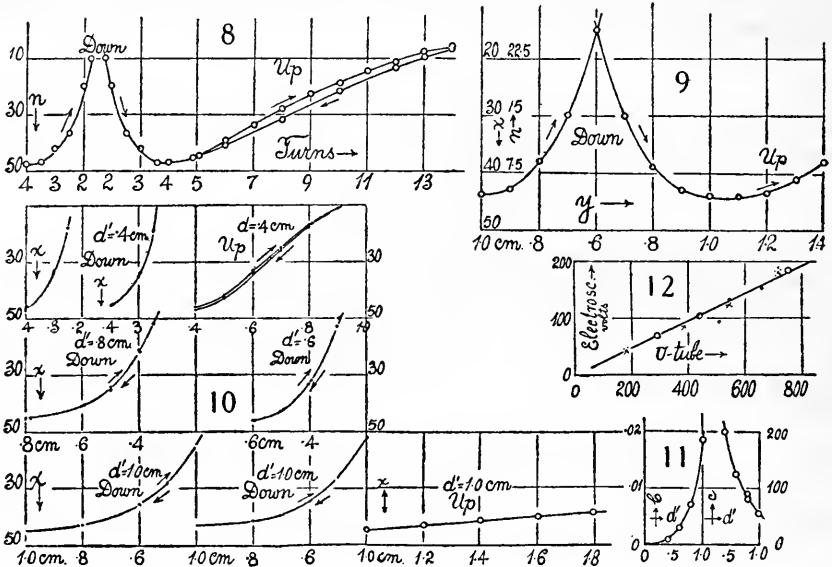

surface. Large fringes (about 1.5 scale-parts) were installed. The results (fringe-readings n in terms of displacement y) obtained in the same way as the preceding are shown in figure 9. The outgoing and incoming series practically coincide.

Figure 10 shows a series of results in which the plates were discharged at different distances $d' = 1.0, 0.8, 0.6, 0.4$ (clear distance between rubber and metal faces) apart. If we write $y^2 = Cx$, $x = 1.5n$ (x in scale-parts, about two-thirds fringe), the relations are

$d' = 1.0$	0.8	0.6	0.4 cm.
$10^3 C = 18.0$	7.1	2.9	0.8
$c = 54$	90	124	200

These parabolas are only approximate; in each case except the last, C decreases appreciably as x increases. The fringe displacement is in excess of the equation $y^2 = Cx$, owing, as I take it, chiefly to the escape of negative charge to the electrometer as d' decreases.

The relation of C and d' (fig. 11) is again apparently parabolic in shape, but remotely so; for if we write $C^2 = cd'$, the values of c (fig. 11) rapidly decrease as d increases, probably for the reason just indicated.

Similar experiments were made with small induction coils. The fringes here were always in motion, with relatively very large pulses recurring at intervals.

9. Specific inductive capacity.—In equation 7, if the space d' is filled with air, $K' = 1$. On the other hand, if a plate of some insulator like glass is inserted of thickness d'_g

$$(8) \quad d' = d'_g + d'_a$$

where d'_a is the thickness of the air-layer. Moreover, if K_g is the specific inductive capacity of the insulator,

$$(9) \quad \frac{d'}{K'} = d'_a + \frac{d'_g}{K_g}$$

If, therefore, in the absence of the insulator, y is the downward displacement of the upper plate which gives the same fringe displacement n , and hence the same ΔV as the insertion of the insulator-plate, the two equations of the form (6) (in the second of which $y = 0$, but K' as in equation (9)) are equal. Hence

$$(10) \quad \frac{-4\pi Q d'' y}{A(K'' d' + d'')} = \frac{4\pi Q d' d''}{A} \left(\frac{1}{K'(K'' d' + d'')} - \frac{1}{K'' d' + d''} \right)$$

or inserting (9)

$$-y = d'(1/K' - 1) = d_a + d'_g/K_g - (d'_a + d'_g) = d'_g/K_g - d'_g$$

or

$$(11) \quad K_g = d'_g / (d'_g - y)$$

To determine the specific inductive capacity of a given insulating plate, the electrophorus is discharged at a convenient distance d' between plate and hard-rubber face. The insulator (K_g) is then inserted (noting the fringe displacement n) and withdrawn. The fringes must then return to zero, showing that no charge has been imparted by the friction of the insulator. The upper plate is now depressed (y) on the micrometer-screw until the same fringe displacement n is obtained. Equation (11) is thus applicable. The operation should be quite rapid.

The following are examples of this method, among many experiments made, most of which proved quite disappointing. Thus, in the case of different plates of glass,

d'	d_g	y	x	K
1.2 cm.	0.81 cm.	0.70 cm.	19 s. p.	7
1.2	.81	.72	22	9
1.0	.52	.48	16	13
.8	.52	.44	39	6.5
.8	.52	.43	37	6
.8	.40	.34	23	7
.8	.40	.35	24	8
.7	.19	.157	18	6
.7	.19	.160	19	6

Results are apt to be even larger than these, much depending on the time during which the glass plate is left within the electrophorus, or on the quickness within which x can be read with the subsidence of motion of fringes. The chief causes of discrepancy, however, are the large values of d' ; since in this case the dielectric plate operates in strong fields and the descending metallic plate of the electrophorus in weaker fields. Thus the results for $d' = 0.7$ cm. and below are the most uniform. In other words, the difference of d and y is so small that any slight charge on the plate has a relatively large effect on $d_g - y$ and vitiates the result. The glass plates virtually conduct. If they happened to touch the upper plate a throw of the fringes resulted.

The same difficulties are present in a less degree even with hard rubber, of which the following data are examples:

d'	d_g	y	x	K
0.8 cm.	0.32 cm.	0.23 cm.	5.5 s. p.	3.4
1.1	0.64	0.45	6.0	3.4
0.7	0.156	0.11	5.5	3.4

results again too large, but quite apt to be larger still.

Baekelite usually leaves a charge on withdrawing the plates and the method quite fails.

Similarly, in case of hard rubber flamed to clean its surface, as the temperature rises in successive trials, K rapidly increases. Thus in the above case the effective K rose from 3 to 4, 6, 10, etc., and finally, when the rubber was purposely well warmed, became practically infinite. This recalls the rapid decrease of viscosity under the same circumstances. Again, if one side of a cold hard rubber is charged and placed contiguously with the charged surface of the electrophorus, the electrometer, initially at zero, shows no appreciable effect; but if the two charged surfaces are both up, the deflection is enormous. In such a case the charge has virtually passed from bottom to top of the rubber plate, as it probably actually does in small part in case of hot rubber and glass. On the other hand, if the rubber is cooled to freezing or below, K decreases to a limit.

10. Allowance for the electrometer.—If the latter has considerable relative capacity, the equations in the same notation as above change to

$$(12) \quad \begin{aligned} q + Q' &= AK'(V' - V_0)/4\pi d' & -q + Q'' &= AK''(V'' - V_0)/4\pi d'' \\ q &= aK(V' - V'')/4\pi d \end{aligned}$$

where q is the charge which has gathered in the electrometer of area a , specific inductive capacity of dielectric (glass) K , and distance between plate and mercury d . Treated in the way given these equations reduce to

$$(13) \quad \Delta V = (V' - V'') = \frac{-4\pi Qqd''}{A(K''d' + d'') \left(1 - \frac{aK}{Ad} (d' - y + \frac{d''}{K''}) \right)}$$

and

$$(14) \quad \Delta V = \frac{4\pi Q d' d'' (1/K' - 1)}{A(K'' d' + d'') \left(1 - \frac{aK}{Ad} (d'/K' + d''/K'') \right)}$$

If the values of ΔV in (13) and (14) are the same, since

$$d' - y = d'/K' = d_a + d_g/K_g$$

by equation (9), it follows that equation (11) again results.

11. Absolute values.—It is next to be determined whether the equations (A) or (B) of § 6 are to be used; in other words, the value of the condenser space in the electrometer is to be found. For this purpose it was convenient to compare the data of the latter with the corresponding results of the Elster and Geitl electroscope. There happened to be three of these in the laboratory, all standardized by the aid of storage-cells compared with the Clarke cell, the range of available voltages being of the right order. To obtain corresponding readings, it was merely necessary to join the U-tube electrometer and the electroscope in parallel with the electrophorus, figure 7, and gradually depress the plate p on the micrometer-screw s .

The results of these comparisons are shown in figure 12, the U-tube reading being reduced to volts by equation (B), § 6, and the electroscope readings by the charts. Not much accuracy is to be expected in the individual readings, but the mean results of different instruments are quite trustworthy. The ratio of data (the U-tube numbers being in excess) is for the case of electroscope No. 1499, 4.3 and 4.2; for No. 1727 it is 4.3, and for No. 1277 (this was the Ebert apparatus for testing atmospheric ionization, not well adapted for the present purposes) about 3.9. The mean of these results is 4.2, so that the data of the U-tube electrometer computed by equation (B) are about 4 times too large. This equation is thus inapplicable and the simpler equation (A) is to be taken. In other words, the thin glass plate floating on and in intimate contact with the mercury acts like a conductor and carries the charge practically at once to its upper face. Thus an equation of the type (A), § 6,

$$V = 60\sqrt{n}$$

should have been used, and this would make the distance between the lower face of the upper electrode and the upper glass face $60/95 = 0.63$ mm.

Examining the apparatus, it was found that in the long usage to which it had been put the levels had slightly shifted. The distance between the electrode surfaces is difficult to determine without special apparatus. I obtained an estimate by rolling iron wires of different diameters between the faces. In this way, with some patience, 0.07 cm. was obtained. It is sufficiently near the datum from electroscope comparisons to prove the case. The equation should, therefore, read

$$V = 0.07\sqrt{4\pi\lambda\rho gn} = 67\sqrt{n} \text{ volts}$$

In the case of an experimental apparatus improvised for the purpose, and without a guard-ring, and in which the rigorous parallelism between electrodes could not be guaranteed, a closer approach was not to be looked for. The equation may be taken as trustworthy within its range.

12. Improvements and miscellaneous experiments.—The electrometer eventually took the form shown in figure 13, which gives the apparatus in connection with the electrophorus and a commutating key similar to Mascart's. To put the mercury M to earth, a steel screw S , which also carries a flat clamp for fastening one end of the earthed wire, has been inserted. This screw S has the further important purpose of *damping* the oscillations of the mercury M or M' , by adjustably closing the channel m . The deflections can thus be made quite dead-beat, which is an advantage. To level the electrodes C, C' (using a small spirit-level placed on them), each has a connecting-rod d , which carries a clamp at one end, allowing the rod aa' to slide up and down, rotate around a, a' and d, d' , and admitting of small displacements along d . At the other end of each rod is a flat vertical plate, which is received in a fissure at the top of the corresponding hard-rubber post k, k' and clamped. This gives a horizontal axis at right angles to the preceding. The lower ends of the posts k, k' are suitably clamped to the tubes t, t' , attached to the body B of the electrometer. Here further motion along the tubes t, t' and rotation around them is possible. In this way it is not difficult to place C, C' symmetrically above the mercury pools (which must be shallow) and parallel to their upper faces, for experimental purposes. It is not sufficient, however, if precision is required, nor well adapted for measuring the distance between glass face and electrode. In such a case micrometers at the inner ends of d, d' would be needed with a more efficient method of leveling. I made the endeavor to change the position of surfaces of the mercury, by putting M, M' in connection with a third vessel on the outside, which could be raised or lowered by a micrometer-screw; but the method was not satisfactory in the long run, as the apparatus shifted its zero-point and sensitiveness. To control the latter in this way proved to be inadvisable and was eventually abandoned.

Figure 13 shows the Mascart key below on the right, which consists of the elastic brass strips l, l' , the earthed cross-bar n above them, and the cross-bar q below. All metal parts are carried on high, insulating hard-rubber posts l and l' at their right ends and they are both in contact with n if not depressed by the insulating knobs at their left ends. The figure shows that l and l' are electrically connected with C and C' by insulated wires, while S is connected with n . Thus the whole U-tube is earthed when not in use.

The bar q is connected by wires with the brush A of the electrophorus shown on the left, so that when l or l' are depressed into contact with q , C or C'

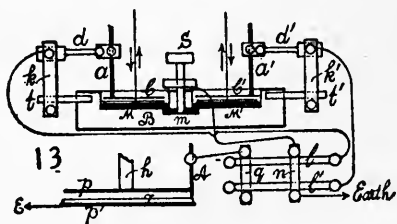

respectively receives a positive charge while the other electrode and the mercury is earthed. This affords a satisfactory means of commutation; for since $\Delta V = C\sqrt{n} = C'\sqrt{n'}$ if the electrodes are so adjusted that C and C' are nearly equal,

$$\Delta V = C\sqrt{(n+n')/2} = A\sqrt{n+n'}$$

Tests were made with this apparatus and a known $\Delta V = 173$ volts. For example, the scale-readings in the ocular on commutation were $x = 34$, $x' = 17$, so that $(x-x') = 0.7(n+n')$, as the fringe breadth was 0.7 scale-parts. Thus $\Delta V = A\sqrt{24}$, or $A = 35.3$ volts per fringe, initially. With large fringes and under quiet surroundings 3 or 4 volts could have been detected.

To endeavor to carry the sensitiveness beyond this, either by the outside mercury receiver or by cautious manual adjustment of C and C' , did not succeed. This would have to be done by special mechanism.

Similarly the experiments made to put in a guard-ring led to no results of consequence, as the sensitiveness decreases rapidly if only the central parts of the mercury surfaces are utilized. Conversely, the central perforation of the electrodes may be enlarged to nearly 2 cm. in case of electrodes nearly fitting the air-space, without appreciable fall of sensitiveness. If wire gauze is placed over these holes the interferences are not destroyed (though they become weaker), but the electrical advantage is negligible.

CHAPTER III.

ON ACOUSTIC PRESSURES AND ACOUSTIC DILATATIONS, CHIEFLY IN RESERVOIRS.

13. Introductory. Apparatus.—On a number of occasions heretofore,* I have endeavored to use the interferometer for the measurement of Mayer and Dvorak's † phenomenon, but though the experiments seemed to be well designed and were made with care they invariably resulted in failures. The present method, however, has been successful and has led to a variety of surprising results, even if the term acoustic pressure is not directly applicable.

The apparatus is shown in figure 14, where B is a mercury manometer described in Chapter I, the displacements being read off by the component rays L, L' of the vertical interferometer. The mercury of the U-tube is shown at mm' , above which are the glass plates g, g' , the former being hermetically sealed, the latter loose, so that the air has free access. The closed air-chamber R , above m , receives the air-waves from the plate of the telephone T , by means of the quill-tubes t , hermetically sealed into the mouth-piece of the telephone, and t' sealed into the manometer. Finally, t'' is a branch tube ending in a small stop-cock C , or similar device at one end, while the other communicates with tt' . Flexible-rubber tube connectors may be used at pleasure, so long as the space bounded by the outer face of the telephone plate, the mercury surface m ,

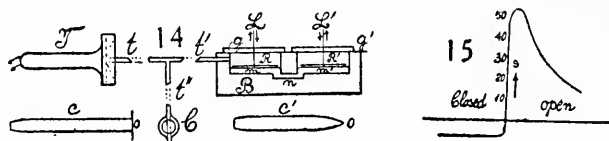

and the stop-cock C are quite free from leaks. The cock C will eventually be replaced by the glass quill-tubes c and c' (enlarged) perforated with minute orifices at O .

The telephone is energized by two storage-cells and a small inductor, with a mercury or other break. Large resistances are to be put in the telephone circuit, so that the inductances are of secondary importance. The bore of the tubes t, t', c, c' need not exceed 5 mm. Thus the R chamber in B , about 6 cm. in diameter and 2 cm. deep, is the resonator (capacity with appurtenances, 57 cm.³) of the apparatus.

* Cf. Carnegie Inst. Wash. Pub., No. 149, Part III, § 122. 1914.

† This and the König resonators are adequately described in most large text-books (cf. Chwolson, *Acoustic* § 5, Vieweg edition). Reference should be made to Bjerknes's famous treatise of hydrodynamic forces in pulsating media (Barth, 1902); to the papers of W. König, *Wied. Ann.* xlii, xliii, 1891, and others.

Recently much work along similar lines has been done by Prof. A. G. Webster and his students. Cf. A. T. Jones, Thesis, Clark Univ., 1913, on the acoustic repulsion of gas-jets; and *Phys. Review*, xvi, p. 247, 1920, on the tone of bells; H. F. Stimson, Clark Univ., 1914, on interferometer methods in acoustics.

The displacements of the achromatic fringes corresponding to the head of mercury in *B* may be read off by a telescope provided with an ocular 0.1 mm. micrometer. It is, however, advantageous to place the micrometer in the wide slit of the collimator, the fringes being parallel to the scale-parts. To obviate the need of adjusting the inclination of the fringes (as this frequently changes), the slit-holder should be revolvable around the axis of the collimator, the scale being parallel to the length of the slit and the fringes moving in the same direction across the white, ribbon-like field. Fringes equal to a scale-part in breadth are most convenient.

14. Observations. Closed and open resonators.—Spring interruptors dipping in mercury were first used, having frequencies of $n=12$ and 100 per second, respectively.

When the cock *C* is closed, there is no appreciable effect until the telephone resounds harshly. In such a case there is marked dilatation in the resonator *R*, increasing with the intensity of vibration. The successive readings (s' fringes) are liable to be fluctuating; for instance,

Current off.....	20	25	22	21	26	21	24	16
Current on.....	30	34	30	30	31	34	26	27

but the sense and mean value are definite. Since the head is $(s' - s_0) \frac{\lambda}{2} =$

$s\lambda/2$ cm. (the displacement being s fringes of wave-length λ), this mean value s of the many experiments for the given intensity of vibration is at once equivalent to the pressure $\Delta p = 2 \times 10^{-4}$ cm. of mercury, or about 3×10^{-6} atmosphere. If but 500 ohms are put into the telephone circuit, however, appreciable deflection here ceases.

One might suppose (particularly in view of the irregular readings) that the equilibrium position of the telephone-plate differs slightly when in vibration from the position when at rest, and refer the above deviation to a cause of this nature; but in view of the results with pin-hole leaks presently to be described and in which an effect of the supposed shift of the plate would be untenable, the dilations are probably real. In the closed space *R* in *B*, temperature and other discrepancies would inevitably be detrimental to a smooth record.

Again, if the stop-cock *C* is completely open, no effect whatever is obtained. The bore of the small stop-cock in this case need not exceed 2 or 3 mm. All the negative results which I obtained by other methods heretofore are thus explained.

15. Resonator all but closed.—If now, from the open position, the plug of the cock *C* is rotated gradually until the opening is reduced to the merest crevice, the fringe deflection s will, on further slow rotation, be found to increase from zero, with great rapidity, to a positive maximum. The deflection then falls off with similar rapidity through zero to the negative value when the cock is again quite closed. I have indicated this result graphically in figure 15, in which the abscissas show the degree to which the cock has been

opened and the ordinates show the fringe deflections s obtained. The maximum or pressure is very much larger than the minimum or dilation. The experiment may be repeated at pleasure in either direction with the same results. A loose plug moving easily with a minimum of oil is essential; but many trials to and fro are necessary, nevertheless, to set the plug at the optimum. The maximum pressure obtained in these initial experiments was the equivalent of about 50 fringes; *i. e.*, $\Delta p = 1.5 \times 10^{-3}$ cm. or about 2×10^{-5} atmosphere, for a frequency of about 12 per second. At higher frequencies this datum is much increased.

These pressures are real; for on suddenly closing the cock at the maximum and breaking the current, they are retained until discharged on opening the cock. There has thus been an actual influx of air into the resonator R in B through the crevice in the cock C , acting like a valve while the telephone is sounding. Screw-cocks are not at once adapted for these experiments, since (on closing) a pressure is introduced owing to the viscosity of air. On opening, the minimum is accentuated.

16. Pressure depending on the frequency and on the intensity of vibration.—The maxima are observable for very considerable reductions of the intensity of vibration. In figure 16 I have given the observed fringe location (here incidentally decreasing when pressure increases) when different resistances r , given by the abscissas in 10^3 ohms, are put in the telephone circuit. The frequency is $n = 12$ per second. In curves 1 and 2 the rift in the cock was either slightly too large or too small; in curve 3 it was nearer the optimum. In case of 1 and 2 the curious result of an initial increase of pressure with the first few hundred ohms inserted shows itself. This disappears in curve 3.

Figure 17 contains similar results s' when the frequency is $n = 100$ per second. The sensitiveness has obviously greatly increased and in a general way this is the case for higher frequencies. Anticipating results obtained in a better adjustment below, the following data may be cited. There were 2,000 ohms in circuit. The zero-point is at s^0 .

$n = 12$	100	250	300 per sec.
$s_0 - s' = 11$	15	23	29 fringes

It will be shown, however, that the magnitude of the phenomenon depends essentially on resonance, so that these data have but a general bearing.

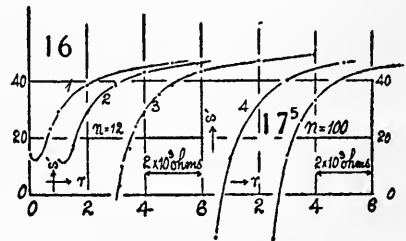

17. Fringe deflection varies as current intensity.—If the readings in figures 16 and 17 be changed to actual deflections $s_0 - s' = s$, the curves (3) and (5) take the form given in figure 18. They are roughly hyperbolic, so that the equation $rs = C$ (r being the high resistance inserted into the telephone circuit) may be taken to apply within the errors of observation for resistances exceeding 1,000 ohms. So computed for convenience, rs is 24×10^3 in series 3

and 36×10^3 in series 5. Hence, at $r = 100$ ohms (taken as a standard), the pressure would have been 7×10^{-3} and 1.1×10^{-2} cm. of mercury. The instrument considered as a dynamometer is thus noteworthy, since its deflections would vary as the first power of the effective current or $i = i_0 s$. It is of interest, therefore, to ascertain how far the sensitiveness, which can not here be estimated as above 10^{-4} amperes per fringe, may be increased.

18. Pin-hole sound-leaks.—Pin-holes less than a millimeter in diameter seem more like a provision for light-waves than for sound-waves often several feet long; but one may recall the phenomenon of sensitive flames.

It is so difficult to make the fine adjustment for maximum conditions with stop-cocks that their replacement by the devices given in c and c' , figure 14, is far preferable. Here c is a quill-tube, to one end of which a small sheet of very thin copper foil has been fastened with cement. The sound-leak at O is then punctured with the finest cambric needle. The other end (somewhat reduced) is thrust into a connector of rubber tubing at t'' . In case of c' the tube has been drawn out to a very fine point. This is then broken or ground off, until the critical diameter (0.04 cm.) is reached. Both methods worked about equally well, but in the case c several holes side by side, or holes of different sizes, may be tried out. Such results are shown in figure 19, which exhibits the deflection of fringes (ordinates s) for different diameters of hole in millimeters (abscissas), when 1,000 ohms were put in the telephone circuit. It will be seen that here the optimum 0.4 mm. in diameter is quite sharp. The finest size of needle is needed.

The results obtained with the sound-leak c (when different resistances r are in circuit) are given in figure 20 for three diameters. As a whole the sensitiveness has been much increased, which is additionally shown by the comparison in figure 18, series 8. The value of rs , viz,

$s = 51$	25	16	12	10	5	fringes
$10^{-3} r = 1$	2	3	4	5	10	ohms
$10^{-3} rs = 51$	50	48	48	50	50	

is also much more constant than hitherto and reaches 50×10^3 . Hence at 100 ohms the pressure increment should be $\Delta p = 1.5 \times 10^{-2}$ cm. of mercury.

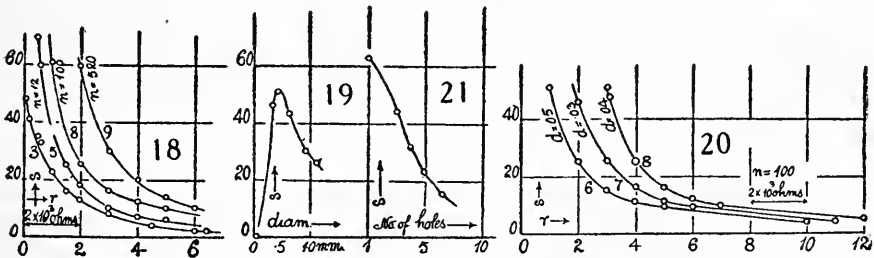

Figure 21, finally, indicates that the multiplication of pin-holes, all of the same diameter (0.04 cm.), is similarly disadvantageous. The deflection for four holes is scarcely half as large as for one.

Capillary tubes were also tested, but with less satisfactory results. Energy seemed to be uselessly frittered away in the channel. Thermometer capillaries act like closed tubes. Capillaries 0.1 cm. in diameter and 0.7 cm. long gave but moderate results, which were not improved by partially closing the tube with thin wires. An ordinary small one-eighth inch gas stop-cock of brass, with a loose plug, is preferable to a glass cock, when adjustable channels are wanted. The sharp edge seems to be advantageous, though I later adapted fine screw stop-cocks with good results. In case of the critically small leak, pressure decrements frequently precede the pressure increments when the telephone circuit is closed.

If, in place of the quill-tubes *c*, the copper foil with an 0.04 cm. perforation is cemented to the mouth of a thistle-tube, the deflections on closing the circuit are liable to be either absent or very small. The conditions for the valve-like action of the pin-hole are thus quite involved; but with a given tube *c* (fig. 14) the data are surprisingly constant.

With the current on, if a drop of water is placed on the hole *O* in *c*, figure 14, the pressure is long retained, whether the current is thereafter broken or not. Pressure is gradually dissipated, however, as the joint at the telephone plate is rarely quite tight; and when the telephone sounds pressure tends toward the negative, as above. If most of the water is removed by blotting paper, a moderate, fairly constant pressure is usually observed for some time, until (doubtless with the breaking of the film across the hole) the maximum is suddenly again attained. Thus from 60 fringes the deflection slowly fell to -10 fringes; thereafter rose to +10 fringes, from which it eventually jumped to 60 fringes again. The result may be interesting, inasmuch as some pressure action through the film of water seems to be in evidence.

19. Effect of resonance.—While a relation of the maximum pressure parallel to the frequency of the telephone note has been shown to exist, it is obvious that the best conditions for high maxima will occur under conditions of resonance between the natural *R* vibrations and the *T* vibrations (fig. 14) or their harmonics. I therefore used the same small induction coil with two storage cells, but with a commutator-like current-breaker, controlled by a small electric motor with a variable resistance in circuit (electric siren). By gradually increasing this resistance all chromatic intervals between about *f'* and *a''* were obtainable. The speed of the motor is, however, liable to fluctuate slightly in any given adjustment, while intervals within a semitone often produce large pressure differences. Thus the determination of the intervals of a somewhat flickering pitch in all chromatics is here quite difficult, even for a musical ear. A series of organ-pipes within the given range seemed to offer the best standards of comparison, as it was necessary to turn rapidly from one series of observations to another.

In this way the graphs given in figures 22, 23, 24 were worked out, the curves showing the fringe displacement *s* to the logarithmic frequency *n* of the telephone. In figure 22, to limit the deflections within the range of the ocular,

about 2,000 ohms were put in circuit. Three maxima and three minima (one positive and two negative) are indicated. The maximum below f' could not be reached. The strong one at c'' was well marked and approachable from both sides. The small one near g'' , though easily observed by continuously changing the pitch, was difficult to record.

The latter, however, is particularly interesting, as it introduces the strong decrement at e'' and a'' . I therefore re-examined it in figure 23 with less resistance (1,000 ohms) in circuit, and the results came out more clearly. The deep minimum at a'' deserves further investigation, as it precedes a probably very high maximum at the near c''' . At least, this may be inferred from the stimulation produced by an organ-pipe used on the outside of the apparatus.

In figure 24 I repeated the work with a finer micrometer scale, placed in the collimator to secure a larger range. The curves are far from smooth, owing to the mental confusion produced by the wealth of chromatic intervals, to which I have adverted. Something better than the electrical siren used will have to be devised; but apart from this the results are very definite.

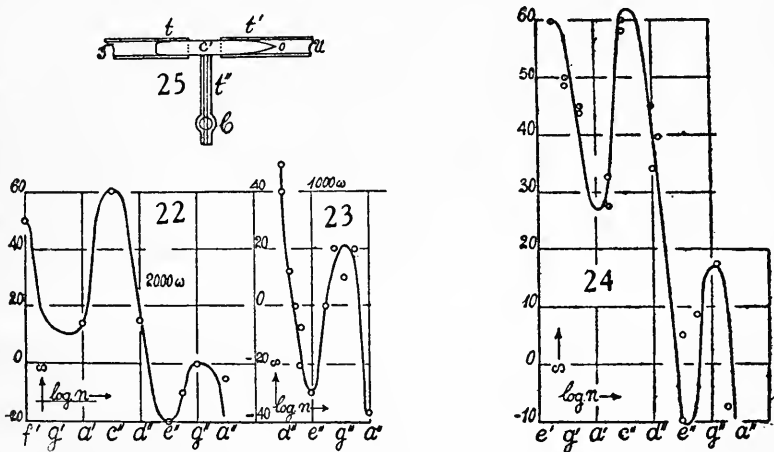

Adjusting the siren for the maximum c'' , the sensitiveness with different resistances in circuit (2,000 to 9,000 ohms) was determined. The curve is shown in series 9, figure 18, and is the highest thus far obtained. The equation $rs = \text{constant}$ does not fit so well here, a result inseparable from the slightly fluctuating note; for this makes much difference in the maximum. The mean value is about $rs = 80 \times 10^3$. Referred to a circuit resistance of 100 ohms, this is equivalent to a deflection of 800 fringes and a pressure of $\Delta p = 0.024$ cm. of mercury. In the course of the work this was at least doubled.

Treated in the same way, the minimum at a'' , if the resistance in circuit were but 100 ohms, would produce negative deflection of 400 fringes, equivalent to a negative pressure increment of $\Delta p = -0.012$ cm. of mercury. This also was later much increased. These are striking results deserving more careful investigation than I have thus far been able to give them. The pressure, decrements also, are real, as may be shown by inserting a stop-cock and

closing it suddenly. There has been an efflux of air corresponding to the influx above; *i. e.*, the acoustic pin-hole valve may be reversed.

An auxiliary telephone placed in circuit with that of T , figure 14, affords no suggestion of these occurrences. Its notes rather increase in strength regularly with the pitch. Yet if the notes should happen to be near e'' , the other telephone would show no fringe displacement.

20. Inside and outside stimulation.—I have as yet given but incidental attention to this development. If, for instance, the branch tube and cock $t''C$, in figure 14, is removed and the pin-hole tube c' is put *within* the rubber connectors t, t' , the apparatus is now completely closed. It functions, however, though in a way totally different from the original adjustment, figure 14, as I shall presently show. In this case, if the telephone connector t is even slightly detached, no reaction is obtained, at least for the size of hole and pitch tested.

When the tube c' is inserted in the absence of vents, there is much undesirable pressure disturbance at the outset, which is but very slowly dissipated. Moreover, the closed space can not be opened again at pleasure without similar commotion. I therefore used the apparatus, figure 25, in preference, in which the pin-hole tube c' is provided with a branch tube t'' and cock C . The rubber tube t leads to the telephone (beyond T) and the tube t' to the mercury U-tube (beyond U). If C is open, c' may be inserted or withdrawn with facility. If C is closed, the resonator R is closed, as in the above case. The pin-hole O may point either toward U or toward T , without modifying the results of this experiment.

Using the mercury interruptor (frequency $c\#$) with 2,000 ohms in circuit, the deflection of the closed region was invariably negative. The deflection was peculiar, moreover, inasmuch as it is a slow growth, within a minute or more, to a maximum. On breaking the current the deflection died off in the same slow, fluctuating manner, with a kind of loitering on the way, as if something were removed in the first case and again supplied in the second. If the cock C is opened, the zero is instantaneously recovered. In other words, the dilatation is due to a loss of gas within the closed region, which loss is but slowly recovered after the telephone ceases to vibrate.

True, the closed region is an air-thermometer, whose fringe displacements also increase in this fluctuating manner; but these are pressures, resulting from the very small increase of temperature in presence of the interferometer ray, L' . They act against the dilatations just described.

If the cock C , figure 25, is opened at the critical point, or if it is replaced by the tube c , the deflection is again positive (about 14 fringes at 2,000 ohms when c above would give about 40). The action of c thus exceeds that of c' , probably because the pin-hole in c happens to be nearer the critical size than in c' .

The question next at issue is the influence of pitch upon the dilatation of the closed resonator R . The electric siren was here used with 2,000 ohms in the

telephone circuit. The results were most striking and appeared about as follows:

g' to b'	c''	d'' to e'' max. estimated	f''	g''	pitch
-5	-25	at -200	-35	0	fringes

There is thus an enormous maximum dilatation somewhere in the range of frequency d'' to e'' which, from the hovering character of the deflection, is not further determinable. This amounts to a pressure decrement of $\Delta p = -6 \times 10^{-8}$ cm. of mercury with 2,000 ohms in the telephone circuit. At 100 ohms it would have been about a millimeter of mercury. Thus the introduction of the pin-hole valve has enormously accentuated the simple phenomenon in §14 and guarantees its trustworthy character.

It remains to place the two shanks of the U-tube, figure 14, in communication, respectively, with the two sides of the pin-hole O in figure 25; *i. e.*, to join t with the space above m' ; but for this purpose the plate g' would have to be sealed, for which operation I was not quite ready. The use of a pin-hole within and without is usually prejudicial to sensitiveness. Thus at 1,000 ohms, the deflection of 47 fringes for this condition was quite doubled when the inside pin-hole was removed.

With the apparatus, figure 14, and the cock C opened at the critical point, a diapason c'' blown in the vicinity of the cock was quite appreciable and the octave c''' three times as effective (15 fringes). In another adjustment, while d'' gave almost 35 fringes of negative displacement (dilatation), g'' gave a positive displacement of 45 fringes and d''' (shrill overtone) nearly 100 fringes, also positive. There is some misgiving in interpreting these data, as the open mouth of the pipe must usually be close to the mouth of the cock; but as d''' was still appreciably effective 6 to 12 inches away, the results are probably trustworthy. The difference in sign of the compression corresponding to c'' and c''' is particularly to be noticed.

21. Apparent removal of pressure decrements.—The slow growth of relatively enormous pressure decrements here recorded is so surprising that further experiments are needed. To begin, one may ask whether the telephone plate, held as usual by strong screw-pressure between annular plates of hard rubber, is adequately air-tight. I therefore removed the telephone and sealed all these parts with cement, rigorously.

On replacing the telephone with the adjustment, as in figure 25, the behavior had in fact changed, the negative deflection being of the small value indicated in §14, without growth in the lapse of time. In other words, the presence of the pin-hole c' within the closed region was now ineffective.

We may summarize the results, so far as at present in hand, in figures 26 and 27. In an air region R , closed on one side by a vibrating telephone plate T and on the other by a quiet plate U , the pressures are distributed as if there were a maximum at T and a minimum at U . If the region R , figure 26, communicates with the atmosphere by a pin-hole O of critical diameter, the pres-

sure within R is raised as a whole by the amount which the pin-hole air-valve will withstand. Again, if the closed region TU , figure 27, contains a pin-hole valve O within only, it does not differ essentially from the corresponding case in figure 26. But if an additional pin-hole leak O' is supplied on the T side, figure 27, the U side gradually develops a large pressure decrement; whereas if the pin-hole is supplied on the U side, this develops the usual pressure increment. In the former case air leaks out of O' diffusively; in the latter it leaks into O'' .

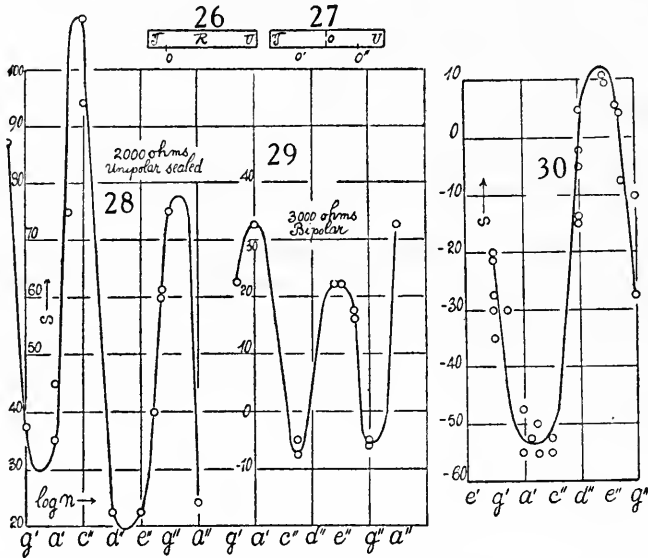

In figures 22, 23, 24, marked pressure decrements occur near the minima at c'' and a'' in case of these prolonged tests. One may therefore suspect that (as above) the decrements result from an insufficiently tight joint at the telephone plate. The telephone with sealed plate was therefore carried through the chromatic series of notes from f' to a'' , as recorded in figure 28. The curve resembles figures 22 to 24 in character, except (as was anticipated) that there are no pressure decrements at the minima. In fact, the maxima (below f' at c'' , g'' , and above a'') came out more sharply than in figures 22 to 24, and the now positive minima (near g' , d'' , a'') equally so. It seems as if the ordinary overtones in the key of C were in question, but further work will be needed to establish these and other relations.

To obtain corroborative evidence, I finally replaced this telephone with a common bipolar, containing the usual clamped plate, and worked out the results of figure 29. These obviously again reproduce figures 22 to 24 with marked dilatations at the minima, except that the maxima at a' , e'' , a'' are now in the key of A , conformably with the changed internal volume. Thus far the argument seemed to be conclusive; but when I re-examined the original unipolar telephone with sealed plate at a lower frequency c' ($n=260$), an

astonishingly large pressure decrement ($\Delta p = 0.04$ cm. of mercury at 100 ohms) now lurked in this region. Clearly, therefore, the pressure decrements depend on something more than the mere instrumental error suspected, and that their occurrence must be as pronounced as the pressure increments which they reciprocally precede or follow, the next paragraph will show.

A final experiment may here be inserted. Using the bipolar telephone above at a frequency of 100 and with 1,000 ohms in circuit, the usual pin-hole leak *c* was replaced by a fine screw stop-cock (at *C*, fig. 14). Here the degree of opening could be specified in degrees of turn of the screw. The results obtained were (after the lapse of about a minute):

Cock open,	0°	45°	90°	180°	quite open
Fringe deflection, $s =$	-34	-20	-12	-2	+2 fringes

The pressure production at a second very small leak thus very soon counterbalances the gradual dissipation of air at the clamped telephone plate.

22. Reversal of poles of telephones changes sign of fringe deflection.—An earlier detection of this result would have saved me much mystification. Not expecting it, I did not look for it, but it seems that a reversal of the telephone current (so to speak) frequently reverses the fringe deflection symmetrically. Thus when a switch (positions *I*, *II*) was added to the telephone the fringe deflections were

<i>r</i>	s_1	s_2	<i>n</i>
2,000 ohms	+27	-26	100 per second
	15	-16	12
1,000	48	-47	100
	49	-47	100

This is as close to an exact reversal as the quivering fringes can guarantee. To test the case further, I used the motor interruptor, making a survey for frequencies between g' and a'' , as shown in figure 30. The motor did not run very smoothly, so that the estimation of pitch was difficult; but the curve, figure 30, corresponds to the curve, figure 28, except that maxima and minima have been reversed by the switch. The maxima now dip into the positive region. Thus the apparatus, regarded as a dynamometer and with precautions as to frequency, would give both quantity and sign of the effective currents in the telephone. Moreover, in any given adjustment, pressure increments changing continuously into decrements, and vice versa, are not unusual.

Since the resonating region *R* is vented by the pin-hole, the positions of equilibrium of the quiet and vibrating plate are ineffective. Hence it is necessary to assume that the vibrations of the plate are not symmetrical; or that, for instance, the impulse corresponding to the break of current at the interruptor is of excessive importance. Thus, if this current re-enforces the permanent magnetization, the effect is a dilatation; if it interferes with the magnetization, the effect is a pressure.

If the plate is energized symmetrically (as, for instance, by a small magneto

inductor) there should be less tendency to marked fringe deflection. Tests made between g'' and c''' seemed to bear out this inference; but the current of the small magneto was too weak to decide the case.

23. Change of volume of reservoir.—The marked effect of resonance met with in the above experiments induced me to provide resonators of different volume. The open shank R' of the U-tube, figure 14, was therefore sealed with a salient cylindrical cap, closed on top by a glass plate. The volume thus added was about 135 cm.³, which is 2.8 times the original volume R' of 48 cm.³. Testing this with the mercury break of frequency 12 per second, the high cylinder (R') was less responsive than the low cylinder, in the ratio of about 20 to 30 fringes; but at the higher frequency, $n = 100$ per second, this disparity was reversed, being in the ratio of 65 to 50 fringes, both data being larger. The two cases were thus unequally near a resonance maximum.

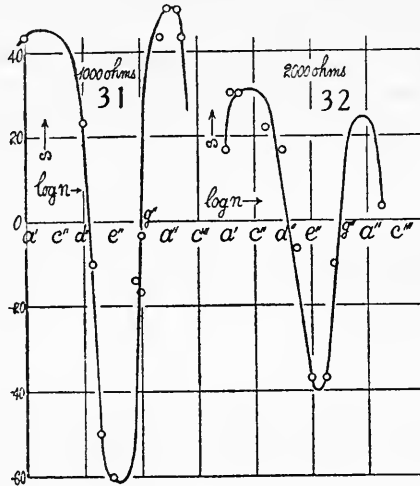

With the motor break I obtained the resonance curves, figures 31 and 32, having 1,000 and 2,000 ohms in the telephone circuit, respectively, and using the sealed telephone. The harmonics found are apparently in the key of A . Strong negative and positive fringe deflections are here successively encountered; *i. e.*, pressure increments and decrements occur together, though in different frequencies. The fringes at the maxima, or the minima, or both, left the field of the telescope; but it does not seem that the response for the three-fold additional volume is less strong than for the original volume. If anything it is larger, which is rather an unexpected result, unless it refers to the greater mass vibrating in the former case.

24. U-tube used differentially.—I now placed the two different reservoirs R and R' of the U-tube in communication by the branch-pipe bb' (fig. 33) leading to the telephone T by way of the quill-tubes t and t' . The pin-hole is in the second branch t'' at O and a cock C (here open) is interposed. I had anticipated a

differential fringe deflection, owing to the different resonance volumes at R and R' . The result, however, was absolutely negative. The fringes showed no motion whatever, either at any frequency (12 to 500) nor when all resistance was removed from the telephone circuit. Each reservoir (R, R') thus acts like an open-air communication with reference to the other, so that the effect of the pin-hole valve O vanishes. On using either side separately ($tb'R'$ closed, b open, or tbR closed, b' open) the normal behavior at once appeared.

The only way of securing a differential effect detected was by elongating either branch (b , for instance) by inserting a long piece of rubber tubing. Thus, for 40 cm. and 80 cm. of interposed length, displacements of 5 and 10 fringes were obtained from the unsymmetrical adjustment. No doubt this is merely equivalent to stopping, partially, the access to either chamber, R or R' .

A variety of correlative experiments were made with the simple (non-differential) apparatus, figure 14. I have already referred to the absence of fringe displacement (nearly) when the copper foil carrying the pin-hole is cemented to the mouth of a funnel-tube. Small flasks with a lateral tubulure to be joined to t'' , figure 14, and the device c secured with a rubber cork in the neck, similarly gave deflection of 7 to 15 fringes only; test-tubes with lateral

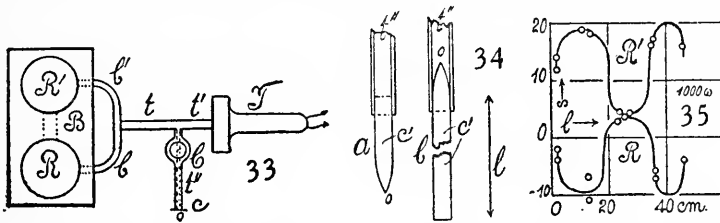

tubulure not above 20 fringes in contrast with a normal deflection of 40. Thus a reservoir, within and immediately preceding the pin-hole, removes its valve effectiveness in promoting pressure and virtually opens the reservoir to the air.

On the other hand, the prolongation of the quill-tube t'' , if the diameter is not increased, is almost indefinitely permissible. Thus, by inserting 40 cm., 80 cm., 120 cm. length of eighth-inch rubber hose between t'' and the pin-hole c , no marked difference in efficiency of the valve-like action could be detected.

In all experiments with closed regions, care must be taken to allow for the temperature or air-thermometer effect resulting from the entrance of light into the resonator. It is small, but gradually increases in the lapse of time. Such results are also obtained when screw-cocks are put in the branches b or b' and very slightly opened.

The experiments made suggest a method of obtaining an effect which is at least apparently differential. For this purpose the cock C , figure 33, is to be closed, so that c is inactive, and the pin-hole c' , figure 14, to be inserted either into the branch b' , figure 33, or b . With a normal fringe displacement of 40, the pin-hole in b' gave a displacement of 38 fringes, in b correspondingly 27

fringes. Hence the large volume R' is more favorable to a large displacement than the smaller volume R . It will be observed at once that here these reservoirs act merely like the outside air in the case of the original experiment, figure 14. The acoustic pressure is produced in the volume which is in uninterrupted communication with the telephone and is larger in proportion as the other volume (shut off nearly by the pin-hole) is larger. If the latter is as high as 200 cm.³, it nearly replaces the atmosphere, seeing that the reduced pressure here (R') acts in concert with the increased pressure on the other side (R). Thus there is no true differential effect resulting from the size of resonators, whether the region be closed, open, or partially open.

25. Conical vents reversible. Periodicity.—The conical vents c' , figure 34, may be inserted into the branch tube v'' in two ways; either in the salient position a , with the convex surface around the pin-hole O outward, or in the re-entrant position b , with the convex surface at O inward. The results obtained are usually reversals of each other, so that a pressure excess is liable to be on the concave side of the conical vent. Thus, for the high region R' alone (R being in communication with the atmosphere), the position a gave a pressure displacement of 28 fringes, while b gave dilatation equivalent to -70 fringes. In other experiments 37 and -14 fringes, 25 and 1 fringes, were found, while the region R alone gave 45 and -1 , 36 and 10 fringes, etc. These results were always consistent in character; but it was soon found that the strength of the telephone current and the length l of the tube c' (fig. 34), in the re-entrant position, greatly modified them. When there is no resistance in circuit, *i. e.*, when the telephone sounds harshly, reversal ceases, so that either the case a or b produces a pressure within; but even here, on closing the circuit, the fringes in case b are seen to move *first* toward a dilatation and then turn in the direction of pressure.

The position a being the normal case investigated above, the case b was studied with 1,000 ohms in circuit, and for different lengths, l , of the quill-tube c' beyond O , from $l=2$ to over 40 cm. These results are given in figure 35, the abscissas showing the length l of tube taken and the ordinates the fringe displacements s , both for the region R' alone (positive displacements here denoting dilatation) and for the region R (positive displacements denoting pressure). The graphs are periodic in marked degree, so that the quill-tube b is a musical instrument with a pin-hole embouchure; and in fact, while the case a is nearly silent, b audibly reproduces the sound of the telephone. The curve for R' shows two resonance maxima and one minimum; but in all cases the dilatation (positive displacement s) within R' is sustained, merely changing in degree. The curve for R , however (dilatations for negative s), indicates the occurrence of both dilatations and pressures within this (smaller) region. Both curves are quite consistent (although R' is nearly four times more capacious than R) and one may infer the length of pipe $l=30$ cm. (fig. 34), or the wave-length $2l=60$ cm., to be an harmonic of the telephone interruptor. This was in fact close to the 4-foot c .

In a majority of cases the action of the conical vent thus recalls the behavior of the cup anemometer, as the pressure excess is on the concave side; but the lower curve of figure 35 (for R , smaller volume) is out of keeping with this, as between lengths of 20 and 35 cm. of pipe the pressure excess is within, or on the salient side.

All attempts to use larger vents, together with wider external pipes (organ-pipe form), failed completely. It is supposed that with more powerfully resonating external vessels, the pin-hole valve might be dispensed with, but no corroboration could be obtained.

One may now argue that if in figure 33 a salient conical vent is attached to the branch b' , opening it to the atmosphere, and similarly a re-entrant vent to the branch b , the pressure difference within would be accentuated. Experiments made both with the mercury interruptor and with the motor through all available pitches distinctly negatived this surmise. The largest fringe displacements were but one or two, determinable with certainty only by multiplication. Thus the pressure within the closed region is uniform in spite of the reversed valves and the impulsive condensations of the telephone.

26. Resonators of very large capacity.—The volume of the region R' , figure 14, was now further increased by adding an additional cylindrical tube, 6.2 cm. in diameter and 10.7 cm. high, closed on top with a glass plate. All parts were (as before) carefully cemented together, thus completing resonator *III*. The volume added was thus 370 cm.³, as compared with the original 48 cm.³, the ratio of volume increment being 6.7 and the ratio of total to original volume 7.7. The conical vent c' , figure 14, here acted much better than the copper-foil pin-holes, in the ratio of about 28 to 19 fringes at the frequency $n = 100$ per second and resistance 100 ohms. At $n = 12$ per second the conical vent gave about 15 fringes.

Using the motor break and conical valve, the fringe displacements were observed for frequencies between the notes g' and c''' and both with 1,000 ohms and 500 ohms in the telephone circuit. The results are comprehended in the two curves in figure 36, the region R being in communication with the atmosphere and R' closed, except as to the salient conical vent specified. The curves are remarkable because of the sharpness of the maxima, which are apparently overtones in the key of B or Bb . The strong maximum near f'' is fully obtained, also a small one near b' , and indications of a large one again below g' . The advantage of the salient conical vent over one or more of the pin-holes in foil is shown in the small inset at a (mercury interruptor, $n = 100$). It is obvious that the fundamentals of the large closed reservoir R' will lie very low as compared with the frequencies of the diagram, and very large fringe displacements may be looked for there (§ 27); but the present motor would not function below g' ; between a'' and c''' the current seems to be uncertain.

It was now thought desirable to test the conical vent in the re-entrant position, and data of this kind are given by the curve, figure 37. All the

maxima are here dilatations, laid off positively for convenience in comparison with figure 36. The valve action (500 ohms in circuit) is much weaker in figure 37 than in figure 36, but in every other respect figure 36 is reproduced. This is a very disconcerting result, for it is not the impulsive displacement of the telephone plate alone which produces the pressure increments within, even if a reversal of the telephonic current (change of poles) changes pressure increments into pressure decrements. The conical pin-hole vent in association with a given adjustment of telephone current (poles not changed) will do the same thing if reversed.

Suggestions to the same effect are contained in the above data for reversible conical vents, but nothing quite so trenchant throughout all the harmonics.

Further work with the resonator *III* consisted in modifying the motor, so that with reduced frequency of current interruption the lower overtones could be surveyed. The results are given in the graph, figure 38, for 1,000 ohms in

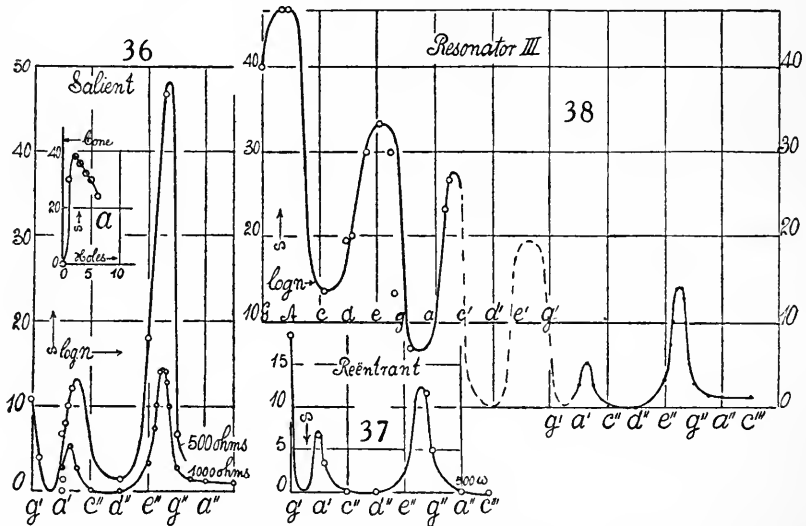

the telephone circuit. Conformably with the large volume, the low tones are very effective and the maxima occur at *B*, *f*, *b*, after which there is an hiatus in which the motor refused to function, continuing with *b'*, *f''*, of figure 36 (lower curve) appended to figure 38. The *B* maximum is represented by a displacement of about 50 fringes, equivalent to a pressure increment of about 0.012 cm. of mercury when 100 ohms are in circuit.

27. Resonator of very small capacity.—Finally the resonator *R* was all but closed (resonator *IV*), or at least reduced to a shell-like space by a cylindrical inset, closed with a glass plate but a few millimeters above the mercury of the *U*-tube. At $n=100$ deflections of 50 fringes were obtained with the copper-foil pin-hole, and at $n=12$ but 25 fringes. The conical vent was less useful, being too large.

A survey of the fringe displacement corresponding to different harmonics is given in figure 39, when 1,000 ohms completed the telephone circuit. Their distribution is less regular than heretofore. If we place them a semitone below d' , a' , a'' , the one between a' and a'' is missing. What particularly astonishes is the occurrence of resonance at these relatively low notes, seeing that the resonator volume is here nearly negligible. The maximum displacement of 100 fringes corresponds to a pressure increment of about 0.03 cm. of mercury, which, though twice as large as obtained with the large resonator *III*, is nevertheless of the same order of values. A variety of other experiments made with different nozzles attached to this cup-shaped cylindrical shell were not quite consistent as to the location and number of overtones.

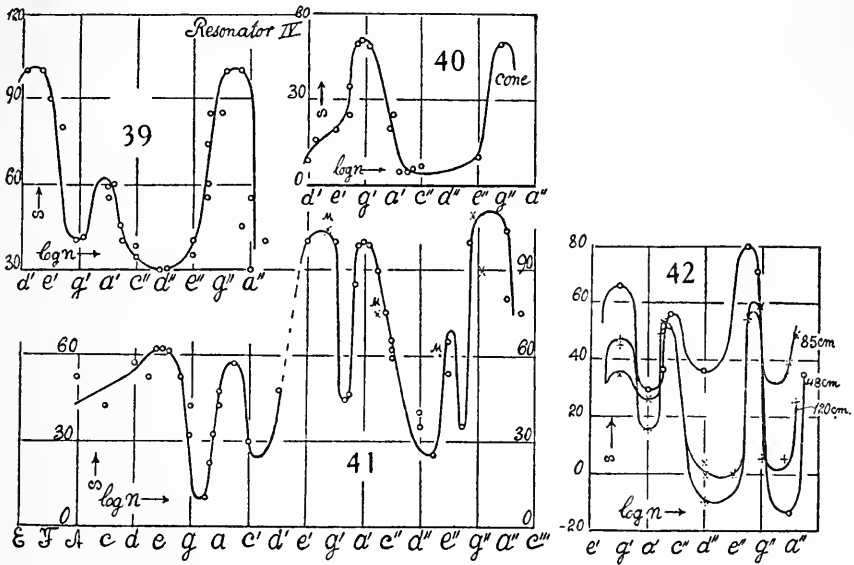

Thus figure 40, obtained with a conical vent (somewhat too large here), shows but two maxima near g' and g'' , the others being obliterated or very low. A fine pin-hole 0.03 cm. in diameter in copper foil was therefore prepared and tested on the modified motor break, between A and a'' , with results given in figure 41. The figure shows much greater detail, there being maxima near a , a' , a'' , e , e' , e'' . Yet this is not the whole list, for the curve is probably much more closely serrated. The smaller indentations are slurred over by the imperfections of the subjective method of observation. A special search made for maxima brought such locations as M , for instance.

In one respect the present curve, figure 41, for the shell resonator *IV* differs conspicuously from the curve, figure 38, for the capacious resonator *III*. In the latter, conformably with the large volume, the lower notes (8-foot octave) are very much more effective than the notes of the 1-foot octave. The curve as a whole falls from left to right. In figure 41 the reverse is observed. In fact, it is rather surprising that for the case of the very small

volume (fig. 41) the 4-foot octave should appear at all. Finally, the highest peaks in figure 41 exceed those of figure 38.

The perplexing question as to what resonates in case of the small resonator was approached by lengthening the tubing between the telephone and U-tube from its usual length of 48 cm. to 85 cm. and 120 cm. successively. The shell-like volume of the resonator *IV* can not much have exceeded 10 or 15 cm.³. The tubes added 10, 17, and 24 cm.³ respectively. To this the disk-like volume in the telephone (about 2 cm.³) is to be added; nevertheless the greater part of the total volume seems to reside in the tubes.

The results obtained in the survey maxima and minima are given by the curves in figure 42. The corresponding maxima and minima are easily recognized in the three cases, though there has been a little shifting, part of which is necessarily mere subjective impression. What has changed actually is the amount of fringe displacement, both at the maxima and the minima. This is particularly true for the order of pitch above *c''*. In other words, the overtones have been differently accentuated. Thus the minimum near *d''* passes from positive to negative values as the tube-length increases, while the reverse is observed at the maximum near *g''*. The case is, then, analogous to the occurrences of the vowel sounds, where different overtones are accentuated by variation of the mouth cavity.

CHAPTER IV.

THE PIN-HOLE PROBE FOR SOUND PRESSURES.

28. The pin-hole sonde, or probe.—It was shown above that when the telephone is detached but slightly at the connection-pipe t , figure 14, no pressure effect is discernible in the U-tube. This, however, may be predicted if the extremity of the pipe t is regarded as the end of an organ-pipe. Thus it seemed worth while to determine the possibilities of sounding for pressure by aid of a pin-hole valve O at the end of a slender tube c (as in fig. 43), communicating with the closed reservoir R' (IV) of the U-tube, the other, R , being open to the atmosphere. The telephone T was therefore provided with a tubular projection t , 12 cm. deep to the plate and about 0.75 cm. in the inner diameter. This received the probe c (O being at the end of an aluminum tube 2 mm. in bore, 3 mm. in outer diameter, and about 20 cm. long) to different depths with a view to exploring the pressures within. The side branch with cock C and extra pin-hole O' is useful below. Here C is to be kept closed.

The probe used in the normal fashion (as in fig. 14) gave the results contained in figure 44 when 500 and 1,000 ohms were successively put in the telephone circuit. On comparing this with the usual pin-hole it was seen to be about

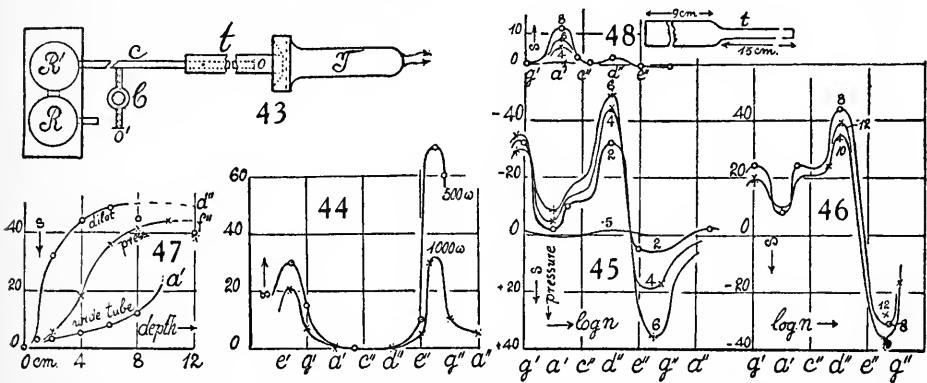

one-third as sensitive. Moreover, the details of the resonance have been obliterated by the slender aluminum tube. A wider quill-tube will therefore be preferable in general, though in the present case greater width would have been permissible because of the small bore of the pipe t . Probably, however, the decreased sensitiveness here observed is of no consequence, as there is to be a minimum of vibration in the tube c when used for exploring or sounding purposes.

The results obtained on inserting the probe to different depths (marked on the graphs) in the telephone pipe are given in figs. 45 and 46, compressions being laid off positively downward in these figures. The curves are unexpected-

edly complicated, but consistent in their character throughout. In place of the simple distribution of pressure in the usual closed organ-pipe, there is a maximum pressure decrement near f' , another at d'' , a maximum negative pressure increment near a' , and a very pronounced positive pressure increment near f'' . A pipe of the same length, if wide and uniform, would have responded to e'' . The low pitch is thus attributable to the plate space in the telephone and possibly to the narrowness and roughness of the tube, which was of hard rubber.

However, the increase or decrease of pressures respectively, from the mouth of t toward the telephone plate 12.5 cm. below, is well shown in figure 47, in which the fringe displacements s for the large minimum d'' and the large maximum f'' are recorded. Pressure rises (or falls) very rapidly from the mouth inward and at 6 or 8 cm. of depth already reaches its maximum value. Beyond this the curves of the figure often show a decrease, which is probably not incidental (owing, for instance, to a heated telephone or to inevitable changes in the motor-break inducing current, during so protracted a series of observations), as it occurs frequently below.

A cylindrical enlargement was now attached to the pipe t , figure 43, consisting of a glass tube (see fig. 48) 9 cm. long and 1.5 cm. in diameter, tapering to a narrow tube fitting t , the total length of which was now 15 cm. Explorations were made with the probe in the wider tube, with results also shown in figure 48, at 1, 4, 6, 8 cm. from the end of the tube. These results (pressures positive upward) are again consistent. There are two definite maxima, one near a' and the other (uncertain) near d'' . The latter may be a residue of the case, figure 45, but the former is surely a repetition of the a' . Naturally, pressure increments in figure 48 are much smaller; for the main pressure changes will begin in the narrow tube t (see fig. 47).

Finally, believing that the complicated distribution of maxima in figures 45 and 46 was due to roughness and narrowness or other similar incidental quality of the pipe t , figure 43, I replaced it by a tube of brass, 1 cm. in diameter and 13 cm. in depth, as far as the telephone plate. Using the pipe-blower (§ 45), this tube was found to respond weakly to the note a'' and strongly to a''' .

The record obtained by aid of the probe, as shown in figure 49, is, in fact, an apparent simplification; there were now but two maxima determinable, both of them quite sharp, a very large one near a' and a small one near d'' . The one at a' coincides with the response to the blower and is accentuated when evoked by the telephone.

The little maximum at d'' , however, is supernumerary, being the reversed d'' of figure 45, so that something else resonates, possibly the plate of the telephone or the telephone space or the U-tube reservoir.

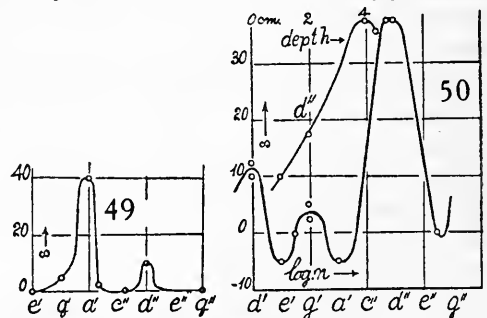

The rubber tube was now about halved in length, the present depth to plate being about 5 cm. and the diameter 0.75 cm. The note obtained with the blower was a faint d' and a strong g'' . The survey in pitch with the pin-hole at a depth of 4 cm. is shown in figure 50, 700 ohms being in circuit. There are maxima at d' and particularly at the octave of the blown pipe d'' , and minima at e' and a' , all well marked. If we compare the present curve for the half pipe with figures 45 and 46 for the full pipe (remembering that the latter curve is inverted), there is thus a complete inversion of results, maxima taking the place of minima. Adding the discarded part of the tube, the results of figure 45 were reproduced; but on adding a part but 1 cm. shorter, the curve corresponded in character to figure 50, though with less displacement throughout. Hence a little difference in length, possibly with some incidental difference in width, may change pressure increments into decrements and greatly modify the sensitiveness.

Figure 50 also shows the effect of the depth of the pin-hole below the mouth of the tube, on the fringe displacements s , for the d'' maximum. The largest displacement occurs at about 5 mm. from the plate.

29. Pressures in smooth straight pipes.—The simple results for these pipes, given in figure 49, seemed to me suspicious, and possibly referable to a deterioration of the pin-hole valve after prolonged use. Thus, even a slight additional sound leak, or looseness, would contribute to such simplification. The pin-hole was therefore carefully overhauled and the survey of the straight tube (13 cm. deep, 1 cm. diameter) between f' and g'' repeated with results recorded (pressures now laid off positively) in figure 51. The suspicion was thus well founded; for the sensitiveness in the present results is enormously greater than in the case figure 49, so that even 100 ohms placed in the telephone circuit do not keep the fringes within the limits of the field. As I did not wish to replace the ocular micrometer by the slide-micrometer because of the danger of complications, most of the curves are open at the dilatation d'' .

The present curves (fig. 51) therefore reproduce faithfully the pressure minima near f' and d'' , and the pressure maxima near a' and possibly c'' of figures 45 and 46, though on a much larger scale, with the exception of the latter (c''), which in both figures is uncertain; but the character of the results is the same for the rough and the smooth tubes, in spite of a difference in bore (0.75 cm. and 1.00 cm.). Finally, the smooth tubes respond to a' when blown. The harmonics d'' and c'' , which are supernumerary here, however, also occur in figure 42, for the resonator R' (IV) alone, with corresponding intensity and sign. These must therefore arise in something which has not changed, *i. e.*, in the telephone itself one might surmise, or even in the resonator, cut off though it is by the pin-hole valve.

In the inset (a' at 100 ohms) I have laid off the fringe displacement s in its variation with the depth of the pin-hole below the mouth of the tube. This could not be done at d'' , since the curves are here incomplete. As these contrasting distributions are, however, of great interest, I made a set of inde-

pendent measurements both at a' (now with 500 ohms in the telephone circuit) and at d'' with 200 ohms in circuit). At a' the pressure increments increase rapidly with the depth until within 1 cm. from the telephone plate, when they drop off a little. At the minimum d'' the pressure decrements are continually

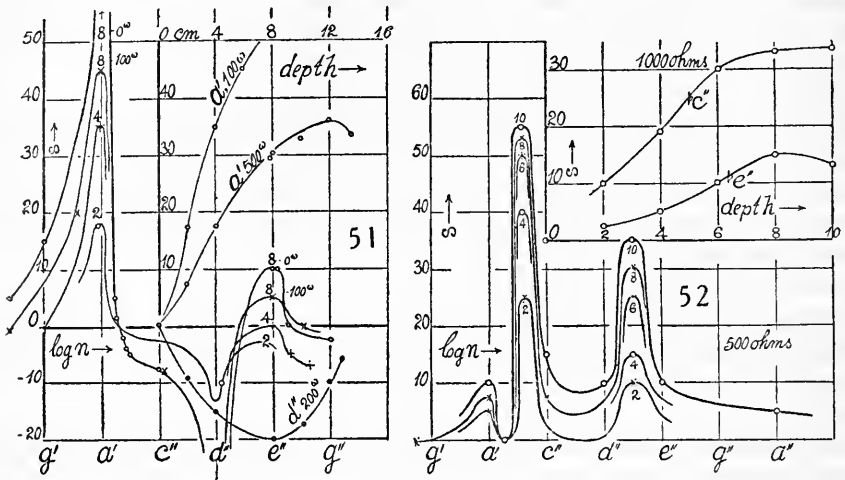

larger until a point a little below the middle of the tube is reached by the pin-hole, after which they continually wane as far as the telephone plate.

This tube (diameter 1 cm.) was now cut down to a length of about 10 cm. When placed in the telephone and blown with the pipe-blower it responded weakly to c' and strongly to d''' . The survey made with the pin-hole valve is given in figure 52, the curves showing the pressure increments at depths 2, 4, 6, 8, 10 cm. below the mouth of the tube. The arrangement was remarkably sensitive, so that 500 ohms had to be put in the telephone circuit to keep the fringes in the field. Moreover, in sharp contrast to figure 51, the curves are throughout of the same kind, there being now no pressure decrements. Whereas the blown tube responded to a clear c'' , the chief maximum evoked by the telephone is a decidedly flattened c'' . There remain the two supernumerary resonances as in the preceding figure, the one at a' considerably dwarfed and soon vanishing and the one near d'' , now not only sharpened in pitch, but reversed, so that it becomes a pressure increment. The accentuation of the notes near c'' and d'' was obvious to the ear.

In the inset I have given an independent survey of the distribution of pressures in depth below the mouth of the tube. To keep the fringes well in the field, 1,000 ohms were put in the telephone circuit. Pressures increase continually, almost as far as the telephone plate, both at the c'' (flat) maximum and at the d'' (sharp) maximum. One may note that at the flat c'' the maximum fringe displacement at 1,000 ohms is 35, so that these pressure increments (about 0.01 cm. of mercury) are of the same order as occur in most of the completely closed regions above.

The brass tube was then further cut down to a length of 7 cm. from the

telephone plate. The note evoked by the blower was now a faint e' and a strong flat e''' . The survey in pitch at a depth of 4 cm. showed a minimum at a' , a small maximum at b' , a minimum near c'' , and a highly developed maximum at a' , a small maximum at b' , a minimum near c'' , and a highly developed maximum again at the flat e'' , all fringe displacements being pressures. In other words, the curve scarcely departed in character from the groups, figure 52, though the displacements were smaller as a whole.

The survey in depth below the mouth of the tube revealed no pressure decrements. The curve (1,000 ohms in circuit) rose rapidly from zero, reaching a maximum at about 1 mm. from the plate of about 30 fringes at 1,000 ohms, very much as represented in figure 50. With the pin-hole but 1 mm. below the plane of the mouth, however, the fringe displacement was already one-fifth of the maximum.

The final experiments were made with a modern bipolar telephone (100 ohms in circuit) and a somewhat wider (1.25 cm. in diameter) and longer (19 cm. as far as the telephone plate) tube. Blown when in place on the telephone with the pipe-blower, it responded weakly to g' and strongly to e''' . An example of the results of the survey, with the pin-hole valve at depths 2, 4, 8, 12, 16, 18 cm. below the mouth of the tube, is given in figures 53 and 54. The chief maximum is here at a' (instead of the blown g') loud to the ear as well as to the probe. The subsidiary maximum is near f'' .

At a' the tube behaves strangely, since at different depths a' may be either a maximum or a minimum. This result is so peculiar that a special examination of the distribution of pressure in depth was made as shown in figure 55, for two different adjustments with 100 ohms in circuit. The occurrence of minima near the depth of 16 cm. is well borne out in each case.

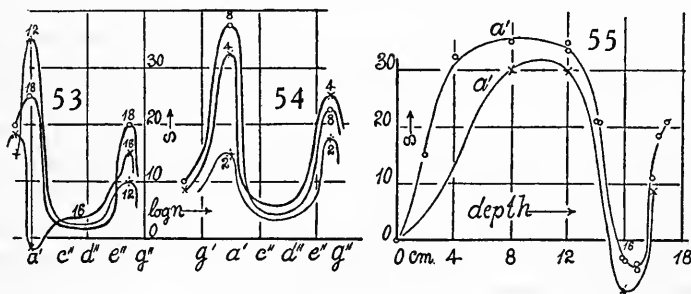

30. Symmetrical induction.—In the preceding paragraph it was inferred that the large fringe displacements obtained were, in a measure, referable to the non-symmetric induction supplied to the telephone by the break interruptor. To test this a small magneto was installed and a survey made between g'' and c''' in case of the rubber pipe to which figure 50 refers. No deflection could be detected except at d'' , which came out very definitely with 7 fringe displacements. This relatively small value, however, was quite in keeping with the corresponding weakness of the magnetic induction. In other

respects the symmetric and non-symmetric inductions are equivalent in effectiveness. But the former (as would be supposed) do not admit of commutation, the maximum remaining a maximum on reversal of the telephone current. Adequate installation for the treatment of symmetric induction is yet to be made.

31. Closed region with pipe.—The final experiments were made with the telephone and brass pipe (13 cm. long, 1 cm. in diameter) when the latter was closed with a perforated rubber cork, through which the probe could be inserted into the pipe, the fit at the cork being very snug. In other words, in figure 43, the pipe t was closed at the outer end; but the probe was also provided with a lateral branch at which a pin-hole o' could be inserted. An interposed stop-cock C allowed the pin-hole to be removed from action when not wanted.

The pipe t was first tried with the outer ends open as usual, but with the pin-hole leak o' respectively in action and closed off. The graphs so obtained were the same as to the distribution of their minima (near f' , $b a'$, b' , e'' , a'') and maxima (near g' , a' , d'' , $b g''$; d'' very pronounced). They differed in the amount of displacement at those pitches. The additional pin-hole does not, therefore, interfere with the action of the probe; but its efficiency is weakened nearly one-half. Moreover, since the pin-hole o' here acts like a valve, it would seem to follow that the reservoir R' vibrates.

The pipe t was now closed at the outer end by inserting the perforated cork and a survey was made between g' and a'' with the auxiliary pin-hole o' in action. The graph naturally differed from the preceding, having maxima near g' , b' , g'' , the latter very pronounced, and minima near b' , c'' , and a'' . The main pitch had thus risen from d'' to g'' .

The pin-hole o' was then shut off, but the cork in t' loosened. This left the maxima (particularly the d'' maximum) nearly intact; but the c'' minimum was shifted to e'' .

Finally the cork at the end of t was closed tight, so that the region was completely closed. The resulting behavior was peculiar, inasmuch as large fringe displacements were attainable, but only after the lapse of considerable time (minutes). The same conditions have been instanced above and are due to the fact that the very small leaks in the region are taken advantage of, for on breaking the current the fringes return to zero with the same slow motion.

Allowing the necessary time to elapse, however, the maxima for the corked pipe t (with pin-hole O') were reproducible; but the former minima respectively at c'' and e'' had now shifted to d'' . There was one other noteworthy difference, as the a'' minimum, immediately following the very high g'' maximum, now appeared as a deep negative fringe displacement or dilatation.

All the pipes showed a maximum, more or less developed, at g' and at g'' , the unstoppered pipes being far weaker. Between these limits of pitch, the unstoppered pipe is in its regular behavior almost an inversion of the stoppered pipe.

32. Closed organ-pipe.—The tubes heretofore studied were all relatively narrow, so that only the overtones strongly responded on blowing. It is therefore desirable to examine a relatively wide pipe p , figure 56, inset (diameter 2.6 cm., length to the telephone plate 13 cm., smooth brass), from which a strong fundamental ($\#c''$) could be easily obtained. The brass pipe was attached with cement, axially to the mouth of the telephone T . An examination both as to frequency (at 12 cm. below the mouth) and depth distributions of pressure, made with the pin-hole probe s , is given in the graphs of figure 56. With the exception of the small supernumerary maximum at the sharp a' , the pressure relations are simple, there being only one strong, abrupt maximum at $\#c''$ coinciding with the blown note, within the range (e' to a'') surveyed; but the suggestion of a second maximum near c''' (which could not be reached) is obvious. There were no dilatations.

This distribution in depth is also a smooth curve which begins with a significant value in the plane of the mouth of the tube, and reaches a maximum a few millimeters from the telephone plate. The high pressure value (0.012 cm. of mercury) in this wide pipe is remarkable, as there were 1,000 ohms in the telephone circuit.

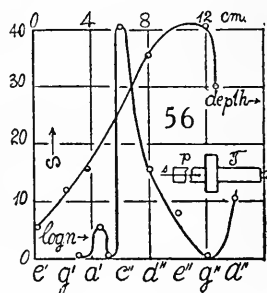

33. Open pipes and adjutages.—The final experiments were made with an adjutaged open pipe pp , 33 cm. long and 3 cm. in diameter, blown by telephone T , as shown by the inset in figure 57. The adjutage or connecting-pipe a (7.5 cm. long and over 1 cm. in diameter) was screwed in at both ends and cemented. The pipe pp had a hole (diameter 0.6 cm.) opposite a , through which the long pin-hole probe s (aluminum or glass quill-tube) could be inserted to any depth; or, again, the probe could be introduced into the pipe pp longitudinally to any depth, as shown at s' , the lateral hole being either left open or closed with a cork. A short flexible tube connected s or s' , with either (closed) reservoir of the U -tube, the other having been opened to the atmosphere. It is interesting to note that if the two halves of the pipe pp are not equally long, measured from a , or if the notes are not harmonics, the telephone evokes violent beating wave-trains from the two ends of pp .

The survey was first made in the adjutage a within a few centimeters of the telephone plate, with results as in the two graphs given in figure 57. Notwithstanding the complication of these examples, both are in agreement and both pressure increments and decrements occur, particularly in the lower curve. As there are 5 maxima and as many minima, often close together, it seems probable that the harmonics of the open pipe are here superimposed on those of the adjutage.

The pipe pp responded to the note a' when the cork opposite the adjutage was in place, and to d'' (flatted) when the cork was out. Both cases were studied. The d'' pipe showed but this single maximum between g' and a'' and

the U-tube (when 1,000 ohms were in circuit) gave a deflection of but 5 fringes. This maximum (curiously enough) is in the middle, figure 58, in spite of the open hole there. The result appears more clearly when the resistance is reduced about one-half (500 ohms). It is the d'' , probably, which is impressed on the graph of the adjutage, figure 57.

The a' pipe (hole opposite adjutage closed) showed two maxima, a large one of 25 fringes at a' and a smaller one of 12 fringes at e'' when 1,000 ohms were in circuit. The latter is possibly impressed on pp by the e'' note in the adjutage. The distribution of compression in depth is also given in figure 58 for this pipe. It increases more gradually toward the center than in the preceding case, a result which suggests a tendency to a re-entrance in the middle for the d'' curve. The a' pipe is also much stronger than the d'' pipe under the same conditions; but both are usually less than half as strong in their compressions as the closed organ-pipe of the preceding section.

The quill-tube glass probe functioned about equally well at d'' and a' , but the somewhat narrower aluminum-tube probe often refused to give results at d'' . As I could not detect any defect in the probe, it is probable that the phenomena of § 25, relating to nodes in the pin-hole tube, are here in question. If so, pressure would be transferred to the U-tube by means of a vibrating column of air.

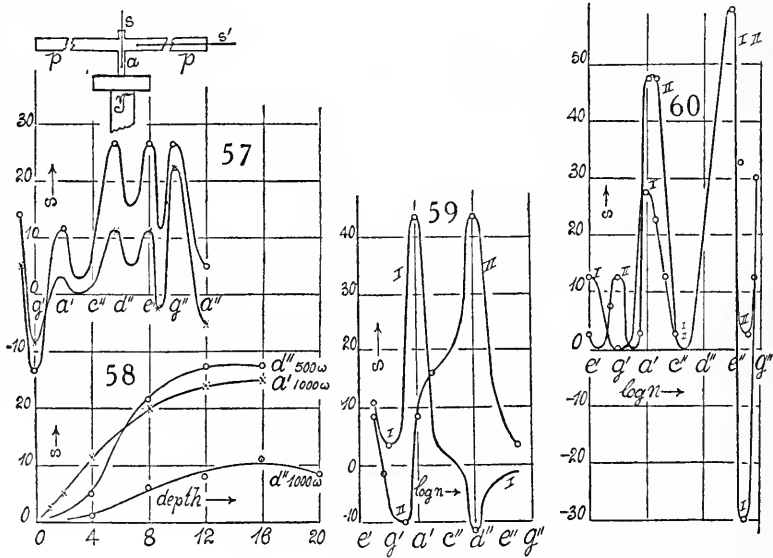

34. Reversal of poles of telephone.—The more or less complete exchange of the maxima and minima of s , of a closed region, when the telephone current (motor break) is reversed, has already been instanced.

Open pipes, however, do not quite conform to this rule. In wide tubes (2.6 cm.) of organ-pipe shape, pressure increments only are found, and these are indifferent to the direction of the telephone current.

In narrow pipes (diameter 0.7 cm., length 5 cm.) certain harmonics may be reversed and the others left unchanged when the telephone poles are changed. Thus, with the short hard-rubber tube of figure 50, the curve above g' was not subject to change on commutation, but below this there were marked differences. The e' of a few negative fringe displacements in figure 50 changed to e' of about 50 positive displacements on reversing the current. Moreover, the curve with 1,000 ohms in circuit as compared with the curve for 2,000 ohms, though preserving the same character as figure 50, differed in the relative value of maxima and minima.

It is, moreover, frequently possible to change negative fringe displacements into increasing positive displacements by increasing the telephone current; *i. e.*, with the removal of extra resistance in circuit. The curves are thus dependent on their general location on the incidental changes of current (as one of their parameters), and this explains why on repeating a series of observations the curve, as a whole, may have risen or been depressed. In a more searching investigation the current, like the frequency n , would have to be definitely measured in its relations to s .

The most interesting inversion of this kind was made with the brass pipe 13 cm. long, 1 cm. in diameter, from which the peculiar graphs of figure 51 were obtained. To get the whole graphs within this field, 2,000 ohms were put in the telephone circuit and there were a few other incidental modifications. Apart from this, the graph, figure 59, obtained with the pin-hole probe for the position *I* of the switch, is the same in character as the group in figure 51, with the strong maximum at a' and strong minimum at d'' . The curve for the position *II* of the switch is very different. While the minimum near g' has probably been retained, the former strong maximum at a' is obliterated. Furthermore, the former negative minimum at d'' has been reversed to a positive maximum and enhanced.

Similarly, the same pipe cut down to 10 cm., as recorded in figure 52, with only positive fringe deflections, lost its d'' maximum on commutation of current.

Finally the pipe, cut down to 7 cm. and examined at 6 cm. of depth, gave the graphs *I* and *II*, figure 60, for two positions of the commutator. The difference at g' and a' is marked; but at the pipe-note e'' the position *I* evokes an enormous maximum, followed at once by an equally pronounced negative minimum, whereas in the position *II* the minimum remained in the positive field.

Other examples will be given among many obtained, in treating the open organ-pipe on the interferometer.

Referring for convenience to figure 59, let s_n be the mean fringe displacement at any frequency n . Then the observed displacements at n will be $s_n + \Delta s_n$ and $s_n - \Delta s_n$, respectively, for the two positions, *I*, *II*, of the switch of the telephone current. Hence the reversible effect impressed by the telephone is $2 \Delta s_n$, a quantity which vanishes between a' and c'' (*i. e.*, at b') and is positive below and negative above b' , so far as observed. It also vanishes at f' . Thus it seems to me probable that on operating with a sufficiently strong magneto, the

Δs_n would be nearly zero throughout in consequence of the symmetrical induction utilized. The magneto employed above, however, was too weak to test the case adequately. Like the reversible Δs_n , even s_n would nevertheless depend on the mode of vibration of the telephone plates.

On completion of the interferometer work of the next chapter, I took up this pipe again for a more detailed survey of the pressure distribution in relation to frequency, at different depths below, on the mouths of the pipe. The graphs (5,000 ohms in circuit) are given in figure 61, where the numbers on the curve show the position of the pin-hole in centimeters from the nearer end, 16 cm. being at the middle, and 8 cm. half-way to it. The a' maximum, so loud to the ear in the 16-cm. curve, is followed at once by a near a' minimum, which is easily overlooked, as it runs at once into the next c'' maximum. The e'' is actually a minimum followed by the maximum near f'' .

At a quarter tube-length from the end (8 cm.) these features have been thoroughly modified. The a' maximum is now isolated, the former e'' minimum has been reversed. The 8-cm. curve is somewhat low throughout, probably because the telephone gets heated in so long a series of experiments.

Figure 62 shows the effect of reversing the poles of the telephone with the pin-hole at the middle of the tube. The position II of the switch corresponds to the preceding figure; I is the alternate position. The effect produced is obvious near c'' , whereas e'' retains its negative character, as do also the other positive parts of the graph.

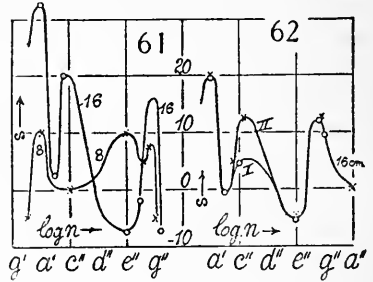

In an adequate discussion of these results the telephone current would have to be measured as one of the parameters.

35. Open pipe on the interferometer.—It seemed to me of sufficient interest to make a direct measurement of the compression in the open pipe, by passing the component ray of the interferometer longitudinally through it, as explained in Chapter V and shown in figure 78, § 47. The reed R of that figure is here to be replaced by the telephone as in figure 57 (inset). Using the motor-break, a survey of compressions was made between a' and a'' . On removing the resistance from the telephone, very sonorous and regular sinusoidal wave-forms were obtained at the harmonics a' and g'' (nearly), each about one fringe in double amplitude. The occurrence of the latter note is peculiar. Referring to the a' , the mean compression would be (notation as in § 42),

$$\Delta\rho/\rho = \frac{C\lambda}{lR\rho}$$

when the height of crest above trough is one fringe. Since

$$C = 1.27 \times 10^7 \quad R = 2.87 \times 10^6 \quad l = 33 \text{ cm.} \quad \rho = 1.3 \times 10^{-3}$$

the mean value in question is thus $\Delta\rho/\rho = 6.2 \times 10^{-3}$ per fringe and the maximum compression would be $\pi/2$ times larger or $10^{-3} \times 9.7$, practically 10^{-2} .

The ratio of compression in case of the interferometer direct and the interferometer and pin-hole conjointly is thus $9.7 \times 10^{-3} / 1.6 \times 10^{-4} = 61$, of the same order of value as estimated for the same pipe.

With 1,000 ohms in the telephone circuit, however, the waves were scarcely perceptible on the interferometer, equivalent, therefore, to a double amplitude of 0.1 fringe, whereas the pin-hole valve showed about 25 fringes (fig. 58).

The $\flat g''$ overtone with smooth, sinuous waves is not easily explained, for in the normal diapason the nodes are respectively rare and dense and thus without effect on the interferometer. It may be plausibly argued, therefore, that in the telephone-blown pipe both nodes are together either dense or rare, an abnormal condition impressed by the telephone. The central node in the a' pipe is thus halved and the two halves symmetrically shifted outward, to be in equilibrium with the impact of air from without. Hence $\flat g''$ is the fundamental of two identically sounding half-pipes and the above relations remain unchanged.

The e'' overtone was also strong, but the waves were no longer sinuous, consisting rather of successive arches, meeting in cusps at their abutments, and with the curves of the arches sharply serrated. The mean double amplitude was again about one fringe. In proportion as the vibration telescope dies down in amplitude, the fringes gradually assume the appearance of parallel strands of beads.

Notes near a' (like g' , b') usually emit strongly beating wave-trains from the two ends of the pipe, even when the halves are of equal length. The same is true of notes near $\flat g''$ (g'' and a''). The interferometer record usually shows waves of nearly the same amplitude as at the regular overtones; but they are highly compound successive serrated inclines, and the like. Waves are running from end to end of the tube, without steadiness of motion. Only at c'' and f'' was the fringe-band approximately straight. With the d'' pipe (unstopped) a' , d'' , $\flat g''$ gave a sinusoidal record, while b' , c'' , e'' were strongly beating trains, but the maximum double amplitude did not here much exceed a half fringe, agreeing with the case of figure 58.

Finally, the open pipe was tested with the small magneto actuating the telephone. Scarcely any effect was discernible, even when all extra resistance was removed from the circuit. This current is thus not strong enough to blow the pipe appreciably. If the telephone, provided with a mirror for observation on the interferometer, is examined the effect is throughout quite marked, as will be instanced (§ 56) below, Chapter VI.

36. Helmholtz spherical resonator.—It is interesting to compare with the complicated results described the graphs for a telephone-blown König resonator (c''). These are given in figure 63 for probe depths of 2, 4, 8 cm. below the mouth. Here the U-tube reservoir contributes no appreciable overtones. It was necessary to withdraw the extra resistance from the telephone circuit to obtain large fringe displacements, owing to the small entrance channel (neck) for the telephone note and the relatively large diameter (7 cm.) and mouth of the resonator. For this reason, also, no appreciable effect was

obtainable from the c' resonator (diameter 14 cm.), the dissipation in 3 dimensions being probably too severe. A repetition of this c'' survey showed that commutation had no appreciable effect; but indications of a small flat maximum near a' were now apparent.

Similarly, a d'' resonator suggested the small maximum at a' , but the d'' was enormously developed, over twice as high and abrupt as the preceding maximum for c'' . The same results were again obtained for an f'' resonator, the maximum being very high and sharp. Beyond this the narrow aluminum probe refused to function, the g'' and a'' resonators being characterized by very small maxima at their respective pitches, less than one-third as high as in the case for c'' .

The occurrence of the obscure maxima near a' induced me to replace the narrow-tubed aluminum probe by a quill-tube glass probe, the same diameter of pin-hole being used. The results so obtained with the c'' resonator (given in fig. 64) are quite different from the preceding graph for c'' , inasmuch as the a' maximum is now highly developed. The apparatus, moreover, is so much more sensitive (auxiliary resistance here removed) that even 1,000 ohms may be put in the telephone circuit with the distinct data seen in the lower curve. The effect of commutation is again absent, the numbers *I* and *II* in the curve referring to the position of the switch.

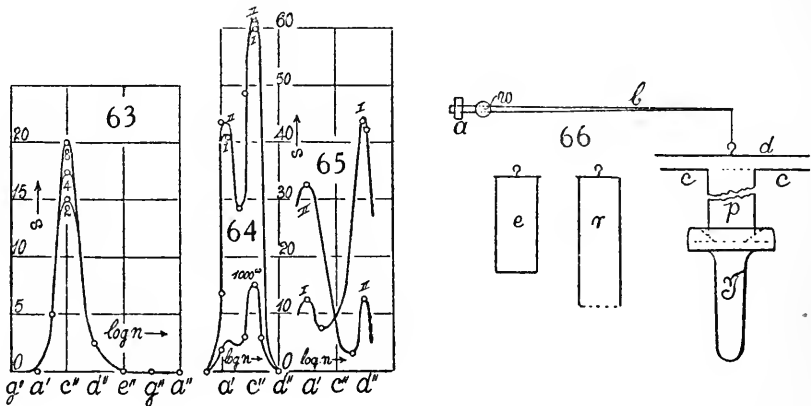

Very different from this is the behavior of the d'' resonator, figure 65. The graphs for the two positions (*I* and *II*) of the telephone switch differ radically. In both the a' maximum is present, but strong only in the position *II*. On the other hand, the important d'' maximum strong in position *I* quite loses its prominence in position *II*. Results for the f'' , g'' , a'' resonators were in a similar manner complicated. All carried the a' maximum, but the strength of the primary maxima f'' , g'' , a'' , still prominent in f'' , soon fell off and could scarcely be detected in the a'' resonator, in spite of the quill-tube probe and the absence of extra resistance in circuit.

The presence of the a' maximum in all the graphs, apart from their pitch, proves conclusively that this note arises in the reservoir of the U-tube. For

this reason it is much more prominent for the wider quill-tube than for the aluminum probe. Vibration is thus communicated through the pin-hole and favored by width of probe-tube.

The work with these resonators has not been completed, but it is already obvious that the smaller resonators must be regarded as adjutages or flares of the necks connecting them with the telephone. By making the connector very short, for instance, the resonator, which quite failed to respond before, gave me a strong $\#c''$ maximum, with no fringe displacement at f'' .

37. Correlative experiments¹ with the torsion balance.—The following pretty experiment is very instructive in its bearing on the Mayer-Dvorak effect, as well as on the experiments of the present paper. In figure 66, *b* is the light wooden beam (30 cm. long, counterpoised at *a*) of a horizontal torsion balance, the torsion wire (of brass 0.02 cm. in diameter and 18 cm. long on either side normal to the diagram) being seen at *w*. A light disk of cardboard *d* is suspended in equilibrium from the end of the balance. Below this is the telephone *T*, to which the brass pipe *p* (13 cm. in length and 2.6 cm. in diameter) has been cemented, to the form of a closed c'' organ-pipe, of which the telephone plate is the bottom. The open top of *p* is surrounded by a fixed annular disk *cc* of metal parallel and close to the movable disk *d*.

When the telephone is strongly energized and emits a rising note (motor-break and rheostat) no effect is produced until its frequency is in resonance with the pipe *p*, whereupon the disk *d* is at once attracted. Since the pipe *p* is closed above by this process, the telephone frequency must be slightly reduced to keep the disks in cohesion. On breaking the current, *d* is at once released.

This is, of course, nothing further than a modified example of the familiar pneumatic paradox. When the pipe howls, the distance from which *d* may be attracted and held is perhaps 2 cm., beyond which the couche of diminished static pressure is ineffective. The thickness vanishes with the intensity of sound.

If now *cc* is removed and the disk *d* is replaced by the closed paper cylinder *e* of a diameter (2.1 cm.) sufficiently small to enter the mouth of *p* easily, the results of the experiment are the same. Here, however, the cylinder *e* may be made to enter the pipe as much as 1 cm. or more by successively decreasing the pitch conformably with the gradually stopped mouth of *p*. Supposing the total displacement to be 2 cm., the force indicated by the torsion balance would be 0.7 dyne and the mean pressure decrement for the area 3.5 cm.², therefore 0.2 dyne/cm.². But as both the disk and cylinder come down with a jerk, the maximum forces are probably larger.

If there were a pin-hole in the bottom of *e*, the density of air contained would tend to increase and the cylinder would fall for this reason also, but the present experiment is relatively too crude to show this. For the content of the cylinder

¹Reference to the allied experiments of Herbert G. Dorsey (Phys. Review, xv, p. 512) is in place here.

e (6 cm. long) may be taken as 33 mg. of air. The forces registered by the pin-hole valve in experiments with resonators did not exceed $dp/p = 3 \times 10^{-4}$. Thus the increment of weight of e is but 10^{-2} dyne, which would lower the index of the torsion balance only 0.3 mm.

Finally, let the closed cylinder e be replaced by the cylinder r , open below and capable of entering the pipe p . Let the length of r be such that the open cylinder is in resonance with p . Then the conditions of the experiment are obviously improved (though not as much so in the experiments I anticipated*), but the results will still be the same in character. The open end of r will tend to enter the sounding-pipe p , which is the equivalent of the Mayer-Dvorak experiment, and is here exhibited without any "neck" effect and without air-currents.

I may add a comparison of the compression observed in the given pipe (2.6 cm. diameter and 13 cm. long) when sounding loudly (*i. e.*, when resistance in the telephone circuit has been reduced as much as possible) and the compression observed in Chapter V in the open organ-pipe of the standard form on the interferometer. The embouchured organ-pipe tested on the interferometer (§35 of Chapter V) showed for the maximum compression $d\rho/\rho = 10^{-3} \times 14$ in case of a moderately loud note. The telephone-closed pipe, tested with the pin-hole valve at the end of a quill-tube thrust well within (as explained above), gave a displacement of 20 fringes with 2,000 ohms in circuit. This is equivalent to a pressure increment of 0.0120 cm. of mercury when but 100 ohms are in circuit, as was approximately the case in the experiments of this paragraph. Thus in case of the probe $dp/p = 1.6 \times 10^{-4}$. Reservoirs R' , figure 14, of different volumes, gave the same quantitative result, which is curious, since the reservoir vibrates. The increment (compression) does not quite vanish, even in the plane of the mouth of p , but a little beyond.

The ratio of the two compressions is thus 87; but while the interferometer direct gives a fringe displacement rarely exceeding 1, the pin-hole valve, under like conditions, will give displacements easily several hundred times larger, depending on the degree of approach to the critical diameter of the pin-hole.

38. Conclusion.—The main facts have been summarized, so far as possible, in the graphs exhibited in the above paragraphs, but an attempt may be made to obtain a working hypothesis as follows: Let the telephone be supplied with a given non-symmetric current, and let an energy increment be thus imparted to the region dominated by the telephone. In this case the mean static pressure at a node would be $p + \Delta p$. It will be recalled that Δp decreases somewhat within a few millimeters from the telephone plate, which must be moving. Within the pin-hole valve Δp again vanishes to establish equilibrium with the atmospheric pressure p without. Now let the telephone non-symmetric current be reversed. In this case an energy quantity is withdrawn from the region and the mean pressure at a node becomes $p - \Delta p$. Within the pin-hole

* On varnishing the paper resonator to stiffen it, forces over 2 dynes per cm.² were directly measured.

valve atmospheric pressure must thus be reduced, to be in equilibrium with the internal pressure $p - \Delta p$. It would follow that the size of the pin-hole bears direct relation to Δp , and this seems to be the case.

It is more difficult to account for the association of pressure increments with pressure decrements (in different orders of frequency, it is true, but for the same direction of current) unless these sequences result in variations of the mode of vibration of the telephone plate. I shall discuss this question in Chapter VI. The observations that on intense telephonic vibration the pressure decrements frequently become pressure increments, that only certain notes are reversed on commutation, etc., all point out the same argument. Moreover, if the magneto symmetric inductor replaces the motor-current break, decrements do not occur and commutation of current is ineffective so far as observed.

CHAPTER V.

THE COMPRESSION OF A SOUND-WAVE IN DIAPASON PIPES.

39. **Introductory.**—Lord Rayleigh and, more recently, Prof. A. G. Webster and his students have given considerable attention to this problem. The following experiment is, I think, capable of exact development.

40. **Apparatus.**—Many years ago * I showed that displacement interferometry lent itself favorably to the study of adiabatic expansion, and this is particularly the case when the achromatic fringes are used. It is therefore suggested † that the endeavor to look with the interferometer through the nodes of an organ-pipe might be successful.

Open pipes P , adapted for the purpose in question, are shown in figures 67 and 68. In figure 67, cylindrical adjutages pp' , of somewhat smaller diameter than the pipe (open within, but closed by glass plates gg on the outside), are introduced at the node N symmetrically and at right angles to the pipe. The effect of this is to lower the pitch to a degree increasing with the length of p . If p is not too long, one may argue that the resilience of air at the node is decreased, and the period lengthened much in the same way in which an increased capacity operates in an electric circuit. In my case the fundamental pitch was depressed about a fourth. The first overtone, however, occurred at about a tenth above this and came out very shrilly, probably because it coincided with the octave of the unchanged pipe. Moreover, this first overtone is probably the fundamental of the small pipes p, p' . Thus, here also, two nodes of the same kind, both compressed and both rarefied, are present and the optic effects (ray L) are correspondingly intense.

The other form of pipe (shown in fig. 68) has the plane of the embouchure at right angles to the axis of the pipe, which is closed at g by a knife-edged glass plate. The other end may be open, or also closed with glass. The path of the interferometer beam is shown at L . Since the distribution of density is simple harmonic, the details are here quite open to computation.

Another available pipe is simply an open tube to be excited by resonance. This case is in a measure the most interesting of the three.

* Carnegie Inst. Wash. Pub. No. 149, 1912.

† After I had published my note on the present subject in *Science* (LII, 1920, pp. 586-588), my attention was called, through the kindness of Professors A. T. Jones and H. F. Stimson, to the admirable paper of Raps in the *Annalen der Physik* (vol. 50, p. 193, 1893), which had unfortunately escaped me. Raps used the Jamin interferometer, which is less flexible and convenient than the method of the text, the latter permitting the examination of two reciprocal modes at once. My work, however, has thus been largely anteceded, and I will therefore give only as much as bears directly on the experiments of the present report. The paper of Töpler and Boltzmann (*Pogg. Annalen*, vol. 141, 321, 1870), using the Fresnel interferometer for the purpose in question, was also pointed out to me by Professor Stimson, but it is less closely connected with the above text. Stimson has used an adaptation of the Chamberlain interferometer.

Finally, the plan of quadratic interferometry is indicated in figure 69, L being a beam of white light from a collimator, with fine slit, M, M', N, N' , the mirrors N and M' half-silvered and identically thick. Small fringes (0.1 mm. in the ocular) suffice. The pipe is in position at $gpPp'g'$ and G is a glass compensator. In order that the fringes may be of any desirable size and at any inclination (horizontal preferable), two plate compensators C, C' , revolvable on vertical and horizontal axes, may be installed. If, however, the mirrors M', N' turn conveniently on horizontal axes, and M, N on vertical axes, the former may be used to give the fringes a horizontal trend and the latter, thereafter, for enlarging them, or vice versa. A plane-dot-slot device with spring usually suffices for horizontal axes; but the vertical axes require a tangent screw of some form, operating against a return spring. Fringes are normal to the line joining the points of light seen with the naked eye on M' . They are largest when these coincide. Compensators may be moved by hand.

When the pipe sounds sharply, the achromatic fringes necessarily vanish. Hence they must be observed at T by a *vibration telescope* (Carnegie Inst. Wash.

Pub. No. 249, Part III, Chap. V, and Part IV, Chap. VI, 1919), in which case magnificent wave-forms appear, measurable in amplitude.

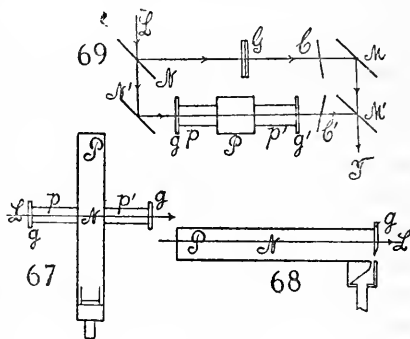

41. Observations with crossed pipes.—When the pipe P , figure 67, sounded its fundamental as softly as possible, the even horizontal band of fringes became definitely sinuous. At the limit of audition there would be no response, even with much larger fringes. A strong fundamental makes the double amplitude about a fringe or more in width. The waves of the overtone are correspondingly shorter and high. The adjutages measured $l = 21$ cm. between plates. Reducing this to $l = 14$ cm., the fundamental came out much stronger, but the loud overtone gave a more confused record. Without adjutages the fundamental ($l = 5$ cm.) still evoked very marked waves, but the response of the shrill octave had naturally quite vanished. Moreover, the form of the waves, obtained here without any mechanism, but with the even harmonics deleted, is of additional interest.

42. Deductions.—In an earlier paper (Carnegie Inst. Wash. Pub. 149, p. 145), and apart from details, it was shown that for a length of tube l containing homogeneous air, the density increment $\Delta\rho$ for the wave-length λ may be written $\Delta\rho = (C/lR)n\lambda$, where $C = 107 \times 1.27$ is the optic constant $p_0/(\mu_0 - 1)\theta_0$.

*The fringes at rest are to look like beads on a string. There are about three colored fringes on either side of the middle one, which is white.

and n is the total fringe displacement. Hence, if $l = 20$ cm., $n = 1/10$, $\lambda = 6 \times 10^{-5}$ cm., $\rho = 0.0013$,

$$\Delta = 1.03 \times 10^{-3}$$

for the soft pipe-note. Rayleigh considers $dp/p = 6 \times 10^{-9}$ just audible, so that my value is of a reasonable relation to it, holding about 2.4×10^5 times more energy per average cm.³ ($pd\rho/\rho = 10^3 \times 1.05$ ergs/cm.³) than Rayleigh's limiting note. For the shorter adjutages the mean energy would be correspondingly larger. An open cylindrical resonator close to an equipitched open organ-pipe can just be seen to respond. Blown at its edges by a lamella of air, however, strong waves antedate the first audible sibillation of pitch.

43. Stroboscopic and other secondary phenomena.—As the amplitude of the objective of the vibration telescope diminishes (electro-magnetic apparatus not being necessary), interrupted fringes, oblique, as shown in figure 70, are frequent. To account for these, it suffices to observe that the wave-length is continually diminishing. When the diminution is such that the distance apart of the ends of two consecutive waves (direct and return) whose beginnings coincide is the horizontal distance apart of two sinuous fringes, it is obvious that in the middle of these waves the light and dark parts of the fringes will overlap. Thus the fringes here vanish. This occurs periodically along the horizontal.

As the fringes die down in wave-length for the reason given, the waves become more and more nearly zigzag in outline. Under these circumstances diagonal patterns, as indicated in figure 71 (though not usually at 45°), are common.

For photographic purposes a simple swing of the spring of the objective would suffice, as there is great abundance of light when the arc lamp is used. A very fine slit conduces to sharpness of fringes and wave-lines.

In addition to the vibration telescope, I also tested the revolving telescope described in § 61. In this case the fringes came out beautifully sharp and luminous, with the central achromatic fringe distinguishably white. It thus stands out from the others. If the rotation is rapid, the horizontal fringe bands are apparently stationary. Taps on the table displace them irregularly, but they at once return to the stationary position. Within the limits of continuous fringe bands, fast or slow rotations display the phenomenon equally well. Fringes may also be displaced by moving the micrometer during the rotation. Any lack of clearness can usually be compensated by focussing the eye-piece, so that adjustment at the interferometer is not necessary. But the waves of the organ-pipe are not well displayed in the case of this apparatus, not even the overtones. The reason of this is the length of the waves; they become mere inclines. Continuous patterns are not liable to occur, as the waves seen are

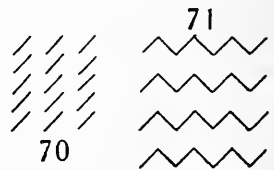

not successive. While the objective revolves 360° , only during a few degrees is there visibility. If the motor is slowed down, the flashes soon become disagreeably intermittent. Possibly in the study of adiabatic expansion, the revolving-telescope method may be useful.

44. Observations with longitudinal pipes.—The experiments with the form of pipe, figure 68, were made somewhat carefully, as this may be considered a standard form. The open pipe used was of wood, with an inner cross-section 2.8×2.8 cm. and length 24 cm. It responded perfectly to the fundamental, the softest producible note showing about 0.1 fringe in double amplitude, the loudest full note not more than a whole fringe. Blown so hard that the note sharpened, the amplitude rather diminished. As in the above case, the mean energy ($10^3 \times 8.7n$) lies between ($l = 24$ cm. here)

$$pd\rho/\rho = 10^3 \times 0.87 \text{ ergs/cm.}^3$$

and ten times this quantity, or $10^3 \times 8.7$ ergs/cm.³. The maximum energy would, therefore, be $\pi/2$ times larger, which makes the energy content $10^4 \times 1.37$ ergs/cm.³ for the full note. The general shape of waves obtained was sinuous only for long excursions of the objective. For short excursions the zigzag forms and diagonal pattern were often striking.

The pipe did not at first admit of the production of the octave quite free from the fundamental. The wave-pattern consisted of fundamental waves, along the contours of which octave waves passed to and fro. The embouchure was therefore reset to give a clear, shrill overtone alone. The waves now vanished, evidencing complete symmetry in the dense and rare nodes present.

The pipe was then closed with a plate of glass and the corresponding experiments carried out. Toward the fundamental, the interferometer was particularly sensitive, suggesting waves even before the sound was in evidence. The full note, though not loud, gave the same displacement of one fringe, at maximum response.

The surprising feature of this closed pipe, however, was the occurrence of strong waves for the first overtone (fifth above octave). The two nodes, therefore, are here not symmetrically rare and compressed. The double amplitude of these waves for the very shrill note was 0.4 fringe, so that the differential energy would be $10^3 \times 5.5$ ergs per cubic centimeter. One would naturally expect a fundamental present with the overtone to account for this, but neither the waves nor the sound of pipe gave the least indication of the fundamental. It seems more probable that the node at the closed end of the pipe is a semi-node, s , figure 72, while that nearer the open end is a full node, ss , and that the difference found is the energy of the former. This would bring the energy of the full node (such as occurs necessarily in the open pipe) up to $10^3 \times 11$ ergs/cm.³.

The duodecimal overtone was also obtained sharply, but could not well be sustained long enough for measurement.

45. **Organ pipe-blower.**—The remaining experiments were made with simple cylindrical tubes, closed at one end with a glass plate or open at both. To evoke a definite note from these tubes, fundamental or overtone, the device shown in figure 73 was designed. This consists of a brass tube P , pinched down at cc' , so as to form a crevice 2 or 3 cm. long and not much more than 0.5 mm. broad. From this issues a lamina of air striking the strip of thin brass ss' , about 5 mm. broad. The strip ss' , which is always to lie in plane of the lamina, is on guides gg' of thick copper wire, bent at right angles, as shown, and soldered to the ears of the crevice cc' . In proportion as a higher or lower note is to be evoked, ss' is placed nearer cc' or removed from it, or again blown harder or more softly; for the nearer ss' is to cc' the higher the mean pitch of siffing. For high overtones the adjustment is rather delicate and should be made (preferably) with a micrometer. In the apparatus figure 73, ss' slides with slight friction and is moved by the fingers. In use, the blower is placed across the end of the pipe with the plane $gcc'g'$ normal to the axis. The particular note wanted is obtained by correctly setting ss' , which sometimes requires patience. The best results are obtained with pipes of the one-foot octave, and of a diameter less than twice the width cc' , pipes of equal width with cc' being most satisfactory. From inch gas-pipe, 2 feet long, a whole series of overtones may be evoked in succession. With a less exacting demand for an immediate response, clear notes may, however, be obtained

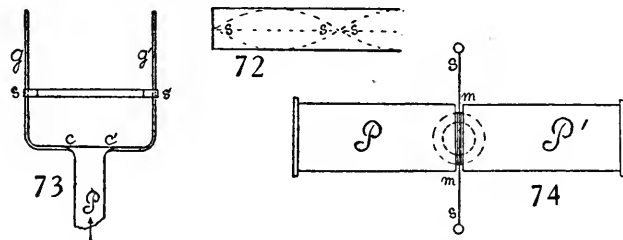

from a great variety of vessels. Thus bottles, deep tumblers and beakers, flat jars (like sardine boxes), truncated cones, thistle-tubes, and even thimbles respond, often very loudly.

Very disconcerting sounds are often obtained. Thus, for a wide-mouthed cylindrical jar, 3 inches in diameter and 6 inches high, tapering down at the top to a mouth 1.5 inches in diameter, the fundamental appears at once (ss' across the middle). If now the distance sc is decreased, the overtone will appear loudly; but it is *not* the fifth above but the *octave* itself. As the kinematics of the stationary waves are given, the overtone belongs to an original wave of 1.5 longer wave-length than the fundamental. With a flexible strip ss' , like moistened paper, the response is often better as to tone quality and the clarinet note is suggested; but the instrument is less convenient.*

*Reference should here be made to a more comprehensive apparatus invented by Professor Webster (Proc. Nat. Ac. Sc., July, 1919; Am. Phys. Soc., 1919; Science, Feb. 25, 1919) and adapted for blowing brass instruments.

The results with the simple tubes in question were much the same as those obtained with organ-pipes and need no further comment. With the open pipes, where the octave vanishes, a wave-length much longer than the fundamental is often seen, probably due to the blower in some way.

46. Interference.—This experiment succeeded beautifully with the strip ss' of the blower placed between two coaxial pipes P and P' (fig. 74), each about 10 cm. long and 2 cm. in diameter, for instance, and closed at the outer end. Either pipe alone sounds vigorously when actuated by the blower. With the two together there is a mere siffing, the wave running from end to end of the (virtually) double closed pipe PP' . Nevertheless, there is abundant room at mm for the escape of sound; indeed, one pipe, P for instance, may even be placed at right angles to the other, leaving a wide open space, and still almost the whole energy of one pipe is alternately captured by the other. The avidity with which one pipe absorbs the vibrations of the other is an excellent illustration of the reversal of spectrum lines. The nodes here are respectively dense and rare, *i. e.*, always opposite in the two pipes; hence the interference. In the cross-pipe above, the nodes were necessarily identical in sign, and, therefore, gave marked response. The same will be true if the pipes PP' are each open at the further end.

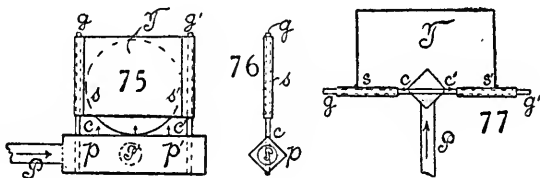

Another form of the blower is given in figures 75 and 76, where pp' is a short end of square-sectioned brass pipe, closed at one end p' and provided with a tubulure P at the other. One of the edges of the brass pipe has been filed down until a fine rift cc' can be cut into it with a thin blade. As before, gg' are the guides of an adjustable strip ss' , against which the lamella from cc' plays.

If tubes T of large diameter (5 cm., 10 cm., and more) are to be excited, the strip ss' should be wide as shown, so that it may completely close the end of the organ-tube, except the mouth at cc' . Brass and pasteboard tubes in this case respond strongly, provided the distance sc has been properly set. For very wide mouths an influx pipe at P' normal to pp' is often advantageous and in this case also the apparatus may be doubled, as shown in figure 77. Here there are two rifts c and c' and strips s and s' opposite each other on the common guides gg' , P being the influx pipe. The apparatus is placed flat upon the pipe or object T to be energized with c or c' regulated. A tumbler of elliptic section is interesting; when gg' passes by rotation from the major to the minor axis, the pitch rises continuously about a tone. Mouths 5 to 10 cm.

and wider than the strips s may have to be closed laterally, wholly or partly, except at cc' , by the hands, for instance. The sounding-boxes of tuning-forks respond very nicely to the apparatus 77. If two small closed pipes (say 10 cm. long and 3 cm. diameter) be placed at c and c' , figure 77, strong beats are almost always obtained, unless the embouchures at c and at c' are quite alike. This attended to, one may get notes out of drain-pipes 5 feet long as well as out of tin cups or funnels. Though this was not the case in my apparatus, it would be an advantage to have the plane $sc'c's'$ quite flat, so as to repose on the tube end of any size. If obtainable, pp' would then preferably be made of triangular tubing.

47. Reed pipes, voice.—In the endeavor to obtain waves of larger amplitude the device of figure 78 was resorted to. Here the pipe PP , 32 cm. long and 3 cm. in diameter, through which the component ray L of the interferometer passes, is provided with a tubulure about 1 cm. in diameter at its middle and connected by flexible tubing t (to be made longer or shorter at pleasure) with the reed-box R . The vibrations of the reed are thus impressed on PP and conversely. The note was coarse, like a bassoon. Without PP the reed merely wheezed.

With t very short, the first experiments gave a display of enormous waves, 20 or 30 fringes high. I suspected that this could be only a direct mechanical effect of the vibrating reed on the interferometer. The reed pipe was therefore mounted on a separate scaffolding, entirely independent of the interferometer, although both were ultimately attached to the large pier of the laboratory. The result was an immediate reduction of double amplitudes to 4 or 5 fringes. On replacing the reed R by a clarinet mouth-piece, the results were similar. The waves are naturally compound wave-trains, and could only be reproduced photographically. When blowing strongly, deeply incised fundamentals appear, decorated throughout by the overtones. On blowing more gently the fundamentals receded, and the compound wave-train defied further analysis.

The pipe was now moved, as a whole, out of the range of the ray L , and again sounded. To my astonishment, strong waves were again produced, though not as much so as when the pipe was in position for interference. In other words, these reed notes act directly on certain parts of the interferometer and excite the parts selected by resonance.

To test this further, I made use of the voice, singing a foot or more away from the interferometer. I was again surprised to find that at certain chest notes ($b'c''$), the interference bands broke into marked waves near a fringe in double amplitude, the effect being absent from the remainder of the scale. A clarinet played about a yard from the interferometer evoked the following response:

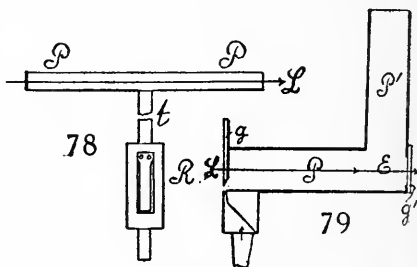

<i>g</i>	<i>a</i>	<i>b</i>	<i>c'</i>	<i>d'</i>	<i>e'</i>	<i>f'</i>	<i>g'</i>	<i>a'</i> <i>f''</i>
o	strong	stronger	max.	strong	weak	o	weak	o o
			1.2 fringes					

Resonating pipes on the interferometer made no discernible difference. The seat of activity is probably in the iron base of the apparatus acting as a sounding-board. Loading it depressed the maximum to *b*. A totally different interferometer in a new location showed the same behavior on the same base (lathe-bed slide), with a maximum at *b*. This discrepancy is an exceedingly difficult one to eliminate, as it calls for a detection of the resonant member of the interferometer, for which reason I abandoned further work with strong reed pipes.

With the diapason organ-pipes used above, there is much less danger of direct influence. This is shown, for instance, in the balance obtained with nodes of opposite sign. Moreover, I made control experiments by blowing equipitched diapason pipes strongly in the neighborhood. There is, even here, liable to be a little response. The tendency to assume wave-form may be recognized; but it is much smaller than the pipe-note proper, and quite absent in the overtones. Finally, the elbowed pipe, figure 79, which blows away from the interferometer, is additional guarantee.

48. General result.—The data obtained in these experiments with a diversity of pipes (cross-pipes, closed and open organ-pipes, tubes) when sounding their full note, however shrill this might be in the overtones, rarely showed a compression in excess of the equivalent of one fringe. In other words, there was a remarkable constancy in the maximum amplitude throughout. Possibly in the steam-whistle pattern (which I have not yet tried) this limit may be exceeded. However, for the usual pipe, since the intensity $i = a^2/\lambda^2$ and *a* is found nearly constant, the shrill notes of overtones are largely to be referred to the decrease of wave-length. Thus in the closed pipe they would be 9, 25, etc., times louder than the primitive, for equal response.

To test this further, I constructed the open pipe, elbowed in the middle, *E*, as shown in figure 79. The pipe is embouchured by the glass plate *g* and there is a corresponding plate *g'* beyond the elbow, to allow the component ray *L* of the interferometer to pass through. For the fundamental, the node is at *E*, so that a little more than a quarter-wave will be seen, and a little more than a semi-node. For the octave (which like the fundamental came out strongly and with the same pitch as for the straight pipe) the nodes are at *P* and *P'*, and a half wave-length is completely visible. Large, handsome achromatic fringes were installed. In the course of several settings of the embouchure, the best position for loud notes did not evoke more than a fringe breadth between trough and crest; usually about 0.8 fringe was recorded, while somewhat more than $\lambda/4$ was observed. In corresponding settings of the embouchure for the shrillest overtone, the largest double amplitude of the zigzag waves was about 0.8 fringe. As a closed

pipe, this elbowed form functioned badly. No waves were obtained for the fundamental and the shrill duodecima. Nor would they be expected. The fifth, which was not loud, gave about 0.4 fringe.

Returning to the loud open pipes, whose semi-length is now 12 cm., the energy content per cubic centimeter will be somewhat larger than above. In the full fundamental there would be $10^3 \times 27$ ergs/cm.³; but more than $\lambda/4$ was seen, and the usual values were 0.8 fringe, so that 2×10^4 ergs/cm.³ (allowing for a slight increment from the interferometer) was probably not usually exceeded. The same value holds for the shrill overtones of 0.8 fringe. Directly compared, the amplitudes of the fundamental were the larger, agreeing with the above inference. I have not been able to carry the experiment to a conclusion, but it seems as if with the amplitude in excess of the equivalent of one fringe the harmonic motion in the given pipe becomes unstable and breaks up into the next overtone in succession. In the endeavor to prove this I constructed diapason pipes of the 2-foot octave (c') about 60 cm. or more long and 5 cm. in diameter, of brass and pasteboard. They were excited by the device, figure 75, suitably secured to the pipe. The note was strong and passed continuously (to use this phrase) into the overtone c'' on increasing the strength of the blast. To my regret, however, the fundamental c' again shook the interferometer, as in the case of the reed pipes above, so that measurements could not be made.

One may finally ask how large a temperature effect Δt should correspond to the maximum compression $\Delta\rho/\rho = 2 \times 10^{-2}$ given above. If c is the specific heat at constant volume and J Joule's equivalent,

$$JC\rho\Delta t = p\Delta\rho/\rho = 2 \times 10^4$$

whence

$$\Delta t = \frac{2 \times 10^4}{42 \times 10^6 \times 0.17 \times 0.00129} = 2.2^\circ$$

The same result may be obtained from the equations of adiabatic expansion:

$$\Delta t = \tau \frac{\Delta\rho}{\rho} \frac{k-c}{c} = 273 \times 2 \times 10^{-2} \times 0.406 = 2.26^\circ$$

τ being the absolute temperature of freezing.

This is an unexpectedly large temperature increment and would seem to be easily measurable by the bolometric-telephone method, described in the last report. It is probable that the reason there given for the negative result is correct; *i. e.*, in the case of these rapid alternations heat fails to penetrate the bolometer wire adequately to become appreciable at the telephone.

CHAPTER VI.

THE VIBRATION OF THE TELEPHONE PLATE.

49. Phenomena.—Intense white light (sun, electric arc) from a collimator, figure 80, passes the half-silvers hh' and the opaque mirrors mm' and is observed in the vibration telescope oe (vibrating objective o). The slit must be very fine and the interference fringes brilliantly beaded. The very small light mirror m is at the center of the plate p of an ordinary telephone pt . This is excited by a little induction coil, with high resistance in circuit. It is also convenient to pass the current from hand to hand through the body and vary the contact at the fingers. A second telephone should be in circuit to test the loudness of response by the ear.

What one observes is a very beautiful phenomenon of apparently beating wave-trains; and this in spite of the fact that the telephone at the ear does not suggest the slightest departure from a uniform rapping; or otherwise a steady, low-pitched note.

I have endeavored to analyze the phenomenon observed, though almost infinitely varied and perplexing, in figures 81 and 82. When the telephone current is sufficiently strong, it consists essentially of detached equidistant groups of fringe-waves w, w' , etc. and vertical equidistant lines of white light s , which are temporary slit-images. There may be many more waves and lines than drawn and differences in amplitude; but this is immaterial here. For simplicity, one fringe only is treated. In one extreme case waves and lines may alternate, figure 81; in the other, figure 82, coincide; and there are all intermediate cases. If the telephone current is weak, the lines s vanish, but the beating-fringe wave-trains are left. In other cases the lines s and the grouped waves w move with the objective; and since the objective vibrates, they also vibrate, as suggested by the arrows in the two parts of each figure. The waves at any part of the field have the appearance of being on an axis alternately stretched longitudinally with loss of amplitude, and compressed

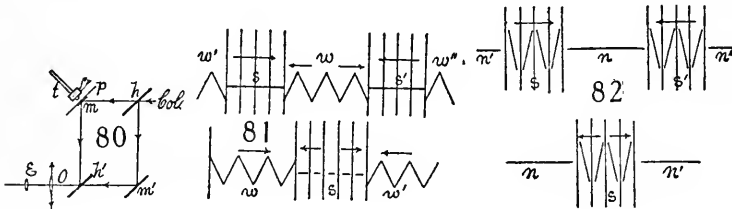

or crumpled by end-thrust with increased amplitude. In such cases the wavelength may decrease continuously almost to zero and the waves become sharp cusps. When the amplitude is a fringe, the displacement at the center of the plate would be but $y = \lambda / (2 \cos \theta) = 4 \times 10^{-5}$ cm. The telephone then shouts

across the room. For the usual conversational intensity, the fringes are not perceptibly crimped. The equivalent displacement of plate is thus below 4×10^{-6} cm.; but there is no compelling evidence that the waves obtained are due to parallel displacements of plate, as I shall show.

50. Interpretation. Lines. Oscillation about a vertical axis.—The key for the interpretation of these phenomena is to be found with the white lines s , which are obviously slit-images arrested stroboscopically, for the ray $hm'h'$, figure 80, is periodically displaced in the field by the objective o only; whereas the ray hmm' is displaced both by the latter and by any slight inclination or rotation of the mirror m about an axis in its own plane. Hence the occurrence of the lines s is proof positive that the plate can not vibrate simply in the type, figure 83, with an even number of internal nodes, but must also vibrate in the type, figure 84, with an odd number of internal nodes. Moreover, if θ is the effective angular amplitude of the telephone mirror m , τ its period, T the period of the objective, a its amplitude, f the length of the telescope eo from objective to image, the displacement per second of the rays $hm'h'$ in the center of the field (equilibrium position) is $a\omega = a2\pi/T$. The mean displacement per second of the ray hmm' , due to m alone, is $2f\omega = 4\pi\theta f/\tau$. If these displacements are equal and opposite,

$$\theta = a\tau/2fT$$

the slit-image from m would be momentarily stationary at the center and visible in the glare of the image from m' . This is the largest amplitude a for which a center line can occur.

Since a , f , T are given and θ is an exceedingly small quantity, τ must also be an exceedingly small quantity. In other words, τ can only refer to the free vibrations of the telephone plate, estimated as above 10^3 per second. It is further obvious that from the smallness of τ there would be an infinite number of repetitions of the static condition, but for the fact that τ is highly damped. Thus the lines s appear in finite number and soon vanish with the occurrence of practically coincident slit-images, leaving room for the exhibition of wave phenomena, figure 81, unless these also have died out, figure 82.

The latter, however, have a two-fold character, consisting of those generated by the parallel displacement of the mirror, figure 83, and those generated by the rotation of mirror, figure 84. In figure 81 these must be regarded as occurring consecutively, whereas in figure 82 they occur together. Since the fringe displacement is an extremely sensitive measure of the angle θ , such waves will much outlast the presence of slit-images s . Hence all the waves observed must be regarded as superpositions* of the cases, figures 83

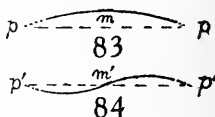

*In relation to my note in Science (May 27, 1921), Prof. Paul F. Gaehr, of Wells College, has been good enough to call my attention to certain experiments with which he was associated and in which a variety of Chladni figures were nicely obtained by spreading carbon dust on a specially designed open and horizontal telephone plate. The figures changed for definite frequencies within the range examined (400 to 3,000). Much of the work was corroborated with the inductometer bridge.

and 84. They may reenforce or annul each other. I fancy that the first displacement is of the form 83, which on subsidence immediately breaks up into harmonics of the form 84.

In table 1 (which was obtained primarily from the waves, but also holds for the lines) group-periods from 1 second to 10 seconds or more were observed. The periods change continuously in the lapse of time, as well as (discontinuously) in different instruments. Exceptionally long group-periods (20 seconds) were found in an old unipolar telephone.

TABLE I.

Period G of recurrence of group waves or lines at any part of the field. Objective, $T=0.32$ sec. Inductor, $\tau=0.08$ sec. and $\tau=0.01$ sec. Resistance $1,000+R$.

Bipolar telephone position I.			Bipolar telephone position II.				
$\tau \times 10^2$	G		$R \times 10^3$	$\tau \times 10^2$	G		$R \times 10^3$
sec.	sec.	Later	ohms.	sec.	sec.	Later	ohms.
8	1.36	3.3	20	1	1.3		20
	1.38	3.6		1	1.3		
	1.40	5.0		1	1.2		2
	1.5	5.0		8	5.2	4.5	20
	1.5				5.0	4.1	
	1.6			1	1.5		20
	2.2				1.5		
	3.3				1.6		
	9.6						
	6.5						
1	2.0		20	Unipolar telephone, same plate.			
8	0.90	1.0	2	1	10.		20
*	1.04	1.0		**	15.		
	1.04	1.0			20.		
1	1.0		20	8	5.		10
	1.0				6.		20
†	1.1				5.		
8	3.		20				
	3.						
1	1.0						
	1.1						
	1.1						
1	1.0		10				
	1.0						

* 3 groups in field. † 6 groups in field. ** Near coincidence.

The group-periods G , here found, are of secondary interest and follow from the fact that the objective (T) and induction (τ) periods are not quite in the ratio n of two small whole numbers. Thus if $T = \tau(N + 1/x)$, the group period would be $G = xT$. But as the mercury interruptor is damped, x will be variable under incidental conditions, so that G varies in the lapse of time.

51. Shadow waves. Oscillation about horizontal axis.—It seems improbable, at the outset, that any vibration figure of the type 84 should be static on the telephone plate. One would preferably infer that the form rotates about an axis normal to the plate. True, in the bipolar telephone there would not be concentric symmetry of the magnetic induction, but the old unipolar behaves essentially like it. The phenomena, as a whole, occur in all telephones which I have examined, and they are not, in general, liable to be accidental. I was, therefore, at first inclined to suppose that the telephone plate vibrates with different periods which interfere, something after the manner of a bell. Later, however, it developed that the plate, firmly clamped in a hard-rubber case, not rigorously circular and very subject to changes of temperature, must be the seat of static strains (buckling), varying in the course of time as the room is hotter or colder.

It is easy to show that the vigorously energized telephone plate oscillates round a horizontal axis in the plate, also, by merely drawing a very fine wire across the slit of the collimator. This produces a dark shadow line in the bright field of the vibration telescope and the line frequently takes the form of the beating wave-trains when the amplitude of the telephone plate is increased. Moreover, the maxima of grouped shadow waves vibrate in a manner similar and with the same period as the lines *s*, and are frequently associated with them in the way suggested in figure 82. In other words, the periods of oscillation round horizontal and vertical axes in the plate is nearly but not necessarily quite the same.

It follows from this that the axis of oscillation in the plate is generally oblique. If not, either the lines or the shadow waves fail to appear, as is often the case. I could not, however, ascertain whether the axis rotates; for the amplitudes, etc., of the shadow waves are not sufficient for this discrimination. Similarly, if the vibration telescope is at rest, the coincident slit-images do not usually separate (which would destroy the fringes so that gaps, such as are mentioned below, occur in the fringe band), but the duplicated slit-image merely broadens. The angular displacement in either case would probably not exceed 10^{-4} radian (within 0.01°). The corresponding angular displacement of the fringes, however, may be several hundred times greater.

52. Beating fringe waves.—The reason for the synchronous behavior of the fringe waves and slit-images is thus at hand. When these are very slightly separated laterally, the fringes move in a marked manner up or down. Again, if the slit-images are slid slightly along each other longitudinally, the fringes also move up or down, supposing, of course, that in both cases the trend of fringes at rest is horizontal. Consequently if the horizontal and vertical periods are not quite the same, since both produce directionally the same displacement of fringes, there must be two beating wave-trains in the field of the vibration telescope, quite apart from other and more immediate reasons.

This is, moreover, in keeping with the long periods of the vibrating groups as given in the table, and with their changes in the lapse of time, or in different

apparatus, for the distance and rate at which waves in the plate travel in two diametral directions at right angles to each other will not probably be quite the same. The hard-rubber casing, for instance, expands and contracts with temperature much in excess of the iron plate. It is not probable that in such a case there would be concentric and rigorously symmetric compensation.

From this point of view, oscillations of the plate about a vertical axis are to be associated with the lines, oscillations about a horizontal axis with the shadow waves or again with gaps, if either are present. Hence, if the telephone is rotated 90° on its axis (normal to the plate) the relations should be exchanged. It is in this way that figure 82 was obtained from figure 81.

Waves which open out or develop from the cuspidal to the sinuous form might possibly be called shock-waves. They result from the successive magnetic shocks which the plate experiences. Their average period can not be estimated even as high as a thousandth of a second. They are to be associated with the free vibrations of the telephone plate, in the interval ($\tau = 0.1$ second, 0.01 second) between the inductions.

53. Effect of temperature. Miscellaneous observations.—A result with a bearing on temperature effects was obtained incidentally. The telephone having been adjusted for the phenomena, figures 81 and 82 were left at rest with the window of the room open on a cold winter day. After adjusting the interferometer for the temperature change, very large fringes appeared, which when the telephone sounded with moderate loudness (20,000 to 10,000 ohms in circuit) remained flawless fringe bands throughout. In other words, there was no suggestion of motion of the plate of any kind. Not until all but a few thousand ohms were withdrawn from the circuit and the telephone spoke harshly, was a wave-form apparent. Sharply circumscribed patches of jagged waves entered the field of the vibrating telescope on the right and left, crossed at the center, and moved out of the field at the opposite sides. Apart from these interruptions, recurring regularly every few seconds, the fringes remained straight and in place, giving no evidence whatever of motion in the plate. The same phenomenon, only more marked, was obtained incidentally on the following day, in a cold room. In place of the patches, there were mere V-shaped fringe-band incisions, moving in pairs, in opposite directions and meeting at the center. These again were wholly obliterated when 10,000 or 20,000 ohms were put in circuit. On warming the room, however, they did not essentially change. In fact, the phenomenon was not controllable and the quiet fringes passed in the lapse of time erratically into very different forms.

Among these, the discontinuous or faulted fringes, figures 85 and 86, as they may be called from the appearance given to the fringe band, are the most interesting. In this case the phenomena of figures 81 and 82, with their waves, etc., occur as before; but the even horizontal band separates into sections w , w' , respectively, high and low or the reverse, and terminating in very sheer lines of fault f, f', f'', f''' . The sections w' may be crossed by vertical lines s , or these may be absent. Finally, the sections w and w' are impulsively in

vertical harmonic motion, as shown by the arrows with periods often as high as 4 seconds, but varying in the lapse of time. The waves observed in the upper sections became strong and clear; in the lower section there was usually much vagueness. Shadow waves were nearly absent. The slit-images at rest showed no lateral separation, but evident vertical vibration.

These faulted wave-forms occur only when the vibration of the telephone is intense (resistance 1,000 ohms) and its note jarring. The sections practically jumped from one quiescent position, high or low, to the other, until the period of induction was reduced from 0.08 second to 0.01 second, whereupon sections vibrated regularly up and down. When the resistance in circuit is increased to 10,000 or 20,000 ohms, the even band of figures 81 and 82 reappears. In the parts w' , however, gaps or blank spaces frequently appear, so that the sharp wave w , figure 85, vanishes laterally outward in both directions, to a gap free from fringes, which gap in turn concentrates laterally inward to a sharp wave w again. At very high resistances, the gaps may show waves of small wave-length like overtones.

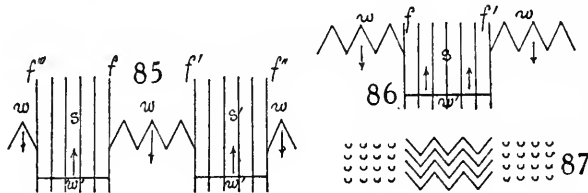

Supposing these occurrences might be due to accidental looseness of mirror, I took out the plates and refastened the mirror carefully. When the fringes were again found there was no appreciable change in the phenomena.

As already suggested, it seems probable that the above observations as a whole are to be referred to a buckled plate of the telephone, resulting from the relatively excessive expansion of the hard-rubber case which holds it. In figures 85 and 86 there are two positions of equilibrium of the plate, and the passage from one to the other is practically instantaneous. Possibly also when the fringes are unbroken straight bands, there are strains in the plate which resist displacement under the given forces, so that straight fringe bands result. Again, two wave-trains may happen to annihilate each other.

To guard against resonance vibrations in the interferometer itself, I disconnected the telephone on the latter, and placed the auxiliary telephone strongly excited in different parts of the interferometer and even on the optical telephone itself. The fringe bands remained even and non-sinuous throughout, so that discrepancies of this kind are absent. Evidence with the same purport is the frequent occurrence of unbroken fringe bands in case of a sounding telephone, throughout the experiments.

The differences between the effects of induction periods $\tau=0.1$ second to $\tau=0.01$ second was chiefly this, that the former allowed each shock-wave more time to subside and there are fewer groups in the field. The occurrence of gaps

in the wave band from oscillations of the plate around a horizontal axis are often striking in the former case. Thus a succession of strong waves subsiding to fringe bands passing through a gap and then in turn to a line and a strong wave, are frequent in intense vibrations. The gaps are often in multiple with pulses between, as in figure 87. Waves seem to tear themselves apart longitudinally, leaving a gap between, which in turn closes by reversed motion.

There is a correlative cause for the possible occurrence of gaps which must not be lost sight of. Since the fringe vibration up and down is very fast in frequency compared with the vibration of the objective, it will be chiefly at the maxima and minima, where the up-and-down motion is instantaneously zero, that they will be most easily seen in the vibration telescope, even when the mirror of the telephone is displaced translationally. Unless the (to-and-fro) amplitude of the objective is very long, the fringes will overlap in their up-and-down motion, leaving gaps in these places in the field. It is these beaded forms and gaps which which may often be transformed into waves, by making the objective travel more swiftly, *i. e.*, to fall, from a larger amplitude. When, however, gaps occur in alternation with waves, as suggested in figure 87, it does not seem probable that they can be produced otherwise than by plate rotation, which slides the slit-images longitudinally along each other till the fringes actually vanish.

54. Synchronism. Iron-screw core.—To obtain further insight into these phenomena, it is necessary to make the period of the vibrating objective and of the interruptor of the telephone current identical and incidentally to devise means for increasing the amplitude of the objective as far as possible. For this purpose the apparatus, figure 88, was designed. Here *M* is the usual electromagnet held in a sleeve *H*, with a stem *a*, fitting the clutch on a vertical standard (not shown), so that *M* may be raised or lowered, placed nearer to or further from the steel spring *s*. The latter is shaped like a hacksaw blade, firmly clamped in a small vise *v* below. This, also, is capable of being raised or lowered on the specified standard. The spring *s* carries the light lens *L*, which is the objective of the telescope. *L* need not be achromatic (in which case it would be too heavy), for the fringes appear almost equally well with a simple lens, if the focal length is suitable to the telescope.

The standard rod to which the vise *v* and the electromagnet *M* are adjustably clamped must be rigidly attached to the tube of the telescope, which has the usual biaxial mounting on a tripod. Hence the telescope may be pointed in any direction while the lens *L* is in uninterrupted vibration. This is a great convenience in viewing different parts of the fringe band, drawn out by the quivering objective.

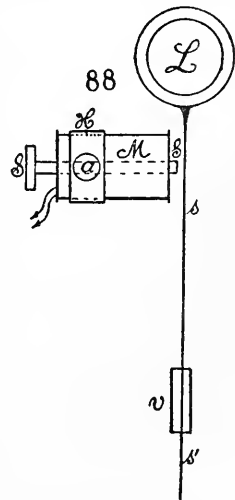

The preliminary adjustment consists in raising or lowering the vise v on s , until the spring s vibrates naturally in step with the interruptor. When this is sufficiently nearly the case, the soft-iron core SS of the electromagnet M is first pushed towards the spring s and then gradually withdrawn from it, until the amplitude of L (using it in connection with the remainder of the telescope) is a maximum. For this purpose, the core SS is a fine-threaded screw, snugly fitting a fixed socket within M . Thus the fine adjustment for a maximum amplitude of L or maximum width of fringe band may be made to a nicety up to the point at which the vibration becomes unstable and s drops back to its position of equilibrium. Amplitudes of 1 cm. at L are easily obtained, unless the spring s is too short. Care must be taken to prevent an excess of spring, s' , from interfering with the vibration of s .

55. Shattered fringes.—When the fringe-waves are observed with the synchronized electromagnetic apparatus just described, their appearance in general may be indicated as in figure 89. There are regions x, x' at the two ends, ss' , of the fringe band, consisting of shattered waves (as I may call them) and the impression produced on the observer is that of fringe rays radiating from a

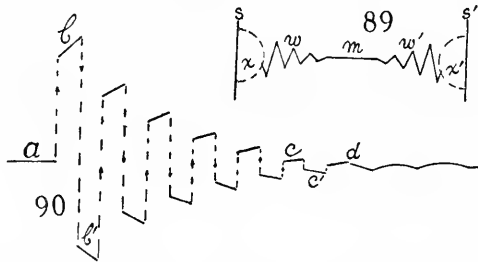

center. Frequently, x' is absent and the phenomenon is confined to one side. Following x are a series of wave-lines w , of decreasing amplitude and increasing length, the form of which, however, is not sinusoidal, but rather like a succession of cycloids (either erect or inverted), or very much like a succession of festoons. They are nearly stationary. When the telephone current is weak (20,000 ohms in circuit), the region x all but vanishes and the waves begin at the edge s of the fringe band and extend toward the middle m . When the current is increased, x rapidly increases and the waves w are driven toward the middle and ultimately (if x' is absent) across the field to the opposite edge s' .

If λ is the observed wave-length at the center of the field T , and a the period and amplitude of the vibration telescope, the period of the shock-waves is easily seen to be $t = \lambda T / 2\pi a$. The ocular micrometer showed $\lambda = 5$ and $a = 100$ scale-parts, while $T = 0.1$ second, so that $t = 10^{-2} \times 8$ seconds. Owing to the quiver, λ is hard to determine; but the waves affecting the interferometer in such marked degree occur with a frequency of the order of 1,000 per second

when the induction period is but 0.1 second. The waves observed are immediately referable to the natural vibration of the plate of the telephone. They follow a magnetic shock, as the Hertzian waves follow a spark.

It is now necessary to endeavor to analyze the region x of shattered waves by aid of the screw-iron core described in the preceding paragraph. For this purpose the interruptor also should run uniformly. If it dips more or less deeply into the mercury, the effect on x is the same as removing or adding resistance to the telephone circuit. By drawing out the fringe band to a limit, one gets a great variety of results; but their appearance on the average is as shown in figure 90.

The phenomenon usually begins with an undisturbed fringe a , meaning the objective begins on its path before the inductive shock arrives at the telephone. After this a series of about 6 discontinuous wave-forms (b to c) of rapidly decreasing amplitude appear. Only the inclined and nearly straight parts (b , b' , etc.) of the fringe band are visible, so that these waves drop off sheer and are akin to the faulted waves described above (figs. 85 and 86). The slope of b is accidentally sometimes upward and at other times downward, throughout; but the slope of b and b' is always symmetrical.

At cc' these linear groups begin to coalesce and coalescence is about complete at d , though the arch is often seen to open. Beyond d the waves are a succession of smooth flat cycloids with the elevation rapidly dying out toward the center of the field. If the slope of b is downward, then waves are festooned.

The endeavor to obtain further information by working through a capacity failed. The whole display is seen through 0.05 microfarad about as well as if there were no interruption. With very small capacities, however, the telephone still sounds when the fringe bands are quite straight.

56. Large frequencies. Musical notes.—In all the above cases the impulses were distinct and the shock-waves had time to subside in the interval between the impulses. This will no longer be the case when the frequency is much increased. There must then be a coalescence into a single wave phenomenon.

The attempts to trace this through with the motor contact breaker used above did not succeed. The period of the objective being $T = 0.34$ second, the note g' in the telephone showed uneven waves and suggestion of cross-hatching when the T amplitude was small. At d'' there were lines and pulses; but very little was to be inferred as a whole from the compound wave-trains obtained.

This interruptor was therefore replaced by a small magneto inductor, which, as a rule, gave compound but otherwise unbroken wave-trains from c'' to about c^{iv} . They were about one fringe in maximum amplitude at low speeds in the absence of marked resistance in the telephone circuit; but above c''' , 10,000 ohms had to be inserted to reduce the waves from broken (gaps, fig. 87) to continuous forms.

At certain very definite frequencies, however, marked disturbances showed themselves. Thus at d''' there was resonance and the field became filled with

stroboscopic vertical lines or slit-images, very definite but faint. At a'' the lines again appeared, this time very bright and present throughout the field. The same occurred at c''' , the note being strident. After this the wave-trains became regular again, and were traced almost as far as c^{iv} .

No doubt these are indications of resonance in the telephone plate, the vibrations being of the type, figure 84, and implying a rotation of mirror. In fact, at a'' there were fine lines *between* the main lines, indicating contemporaneous presence of very high rotational overtones. Moreover, in different adjustments the frequency evoking resonance was not quite the same.

CHAPTER VII.

EXPERIMENTS MADE IN THE ENDEAVOR TO PLACE THE REVOLVING MIRROR ON THE INTERFEROMETER.

57. Apparatus. Revolving mirror normal.—The ease with which the displacement interferometer lends itself for the investigation of vibrating systems induced me to make an attempt to combine the revolving mirror with the interferometer, though this is obviously far more difficult, if at all feasible. Figure 91 shows the first general plan, L being a beam of white light, N, N', M, M' the mirrors of the quadratic interferometer, mm an auxiliary mirror in the normal position. The telescope is at T . With the usual adjustment, it is then easy to find the fringes, and any slight rotation of the mirror mm will be registered by their displacement.

If the mirror mm is at an angle, as at $m'm'$ in the figure, and the rays are reflected normally from a second auxiliary mirror nn , the fringes must again appear if the adjustment is accurate. Moreover, any slight rotation of $m'm'$ will in turn be registered by the displacement of fringes.

If the mirror mm rotates, fringes will, therefore, appear for these two positions of the mirror mm . They will naturally flash through the field of vision, but would be open to detection by the aid of a vibration or revolving telescope, such as I used in case of vibrating systems.

In the endeavor to carry out this difficult experiment, a powerful beam of sunlight is to be introduced at L . To obtain this, I made use of a doublet of two lenses, each about 10 cm. in diameter, respectively convex and concave, and of a focal power of less than 2 diopters. By placing these at different distances apart, focal distances of 10 to 20 meters were obtainable, admitting of an easy guidance of the long beam, when the mirrors mm and nn were 7 to 10 meters apart. There was, consequently, always an overabundance of light available.

The difficulty with the experiment lies in the smallness of the image obtained when the mirror nn is far off, as it must be, when measurements bearing on the velocity of light are contemplated. Unless a special lens train is put in the beam between mm and nn , this difficulty, so far as I see, is insuperable, inasmuch as the mirror mm , at least, can not be very large. An additional difficulty was encountered in the difference of the intensities of the light coming from mm when normal, and from nn . It would, for this reason, hardly be practicable to compare the former fringes with the latter as to relative displacement, the plan I had in view. But the normal reflection from mm may be blotted out by screens m_1, m'_1 , placed as shown in the figure, since this part of the mirror is not used in connection with nn . Moreover, the displacement of fringes due to the time lost in passage of light from mm to nn and return may be compensated by the micrometric rotation of nn around a vertical axis, as

well as by the micrometric shifting of the interferometer mirrors N' or M' . There are thus two independent methods, apart from the ocular reading of displaced fringes.

The fringes from mm and nn may be made parallel by rotating nn on a horizontal axis. If they are visible for the same micrometer position, the glass paths must be rigorously the same in the two cases, so that optic plate is needed. To make the fringes of the same size a vertical axis at nn suffices.

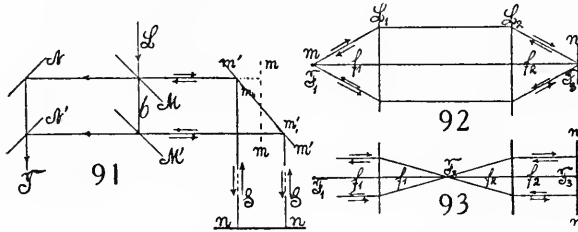

58. Lens train.—This would be peculiarly difficult to apply in the present case. As a large field of view is desirable, a collimator will be needed. If F is its external focus, supposed to be on m (fig. 92 vertical plane, 93 plan), the lenses L can not be of very different focal power from the collimator, if too much light is not to be lost at the edges. If f_1 and f_2 are the focal distances, the total distances apart of the mirror m and n would not much exceed $2f_1 + 2f_2$. It would probably not be advantageous to make this exceed 5 meters and lenses of large diameter would be needed. The main difficulty, however, is the introduction of one of these trains into *each* of the component beams, in particular as it implies the insertion of uncertain glass paths for the rays. In fact, though I obtained very good slit-images from each beam, the result for two beams conjointly was inadequate.

59. Estimate.—It is finally of interest to ascertain the sensitiveness of an arrangement like figure 91. If the distance S of mm from nn is passed in Δt seconds, and v is the velocity of light, $2S = v \Delta t$ and $\Delta t/T = \Delta\theta/2\pi$, if the angular displacement $\Delta\theta$ corresponds to Δt and T is the period of the mirror. Furthermore, on the interferometer $\Delta\theta = \Delta N \cos i/b$, where b is the breadth of the ray parallelogram, i the angle of incidence at the mirrors and ΔN the micrometer displacement (normal to mirror) which corresponds to $\Delta\theta$. Hence

$$v = 2S2\pi b/T\Delta N \cos i$$

If $S = 500$ cm., $b = 10$ cm., $T = 0.1$ second, $\Delta N = 10^{-4}$ cm., $i = 45^\circ$,

$$v = \frac{10^3 \times 6.3 \times 10}{10^{-1} \times 10^{-4} \times 0.7} = 9 \times 10^9 \text{ cm./second}$$

nearly. Since $\Delta N = 10^{-4}$ cm. corresponds to about 2.5 fringes, $v = 2.3 \times 10^{10}$ cm./sec. per fringe. Now both S and b may be increased and T decreased, so that the apparatus could easily be made more sensitive; nevertheless, the present experiment is itself so extremely difficult and unpromising that I did not further persevere with it.

If the velocity is expressed in miles and seconds, or if $v = 1.87 \times 10^8$ and $2 \Delta N \cos i = \lambda$, G may be computed in miles per fringe. This gives $G = 0.0045$ miles or 48 feet per fringe as the sensitiveness for light-waves for the given $b = 10$ cm. The experimental datum below is well within this.

60. The inclined revolving mirror and interferometer.—It is obvious that a method totally different from the preceding will have to be resorted to. Lens systems in the light-paths are treacherous complications, to be avoided. Parallel rays, preferably sunlight, should be used directly, if possible without the intervention of glass condensers of any kind, unless it be in front of the interferometer before rays separate. The solar image in a telescope of moderately high magnifying power (15 to 25) subtends a sufficiently large angle and is intense enough to be used directly. If a large field is needed the image may be enlarged by putting it out of focus, and interferences of almost equal distinctness obtained, provided the pencils of the two washed images are quite coincident. This method of using *images out of focus* is here of considerable importance; for fringe fields may be obtained in this way from images which (because of the long distance traversed) in sharp focus would be mere points. Finally, if the revolving mirror is so inclined as to move virtually

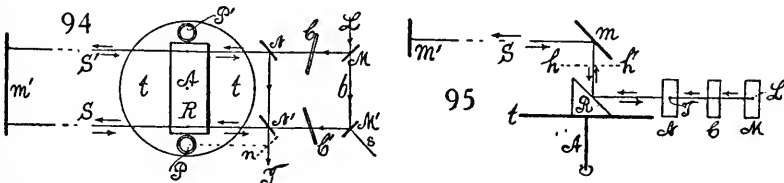

on the surface of a cone instead of a cylinder, its advantages are retained, while rays are returned, only in the position for measurement. Figures 94 (plan) and 95 (elevation) will make these points clearer.

Here L is a bundle of white parallel rays, preferably direct sunlight, from a sufficiently wide heliostat mirror, silvered in front. M, M', N, N' are the mirrors of the quadratic interferometer, all but M' being half-silvered and M and N being equally thick. All mirrors are adjustable on three leveling-screws, as usual, and M' is on a micrometer with the screw in the normal direction s . C and C' are thick glass-plate compensators, capable of rotating on a horizontal and a vertical axis. The rays from L thus fall in two component beams on the revolving mirror R , inclined at 45° to the horizontal. The prism carrying R is mounted on the table t , about a foot in diameter, capable of rotating with great speed around the axis A , which in practice is the shaft of an electromotor. After leaving the mirror R the two beams are reflected by the adjustable stationary mirror m , also at 45° to the horizontal, along the long path (10 meters) $S S'$ to the distant mirror m' normal to the rays. They are thus returned along the paths $SmRN'T$ and $S'mRNT$ and enter the telescope at T . When R is stationary and in the position of the figure, and when T magnifies sufficiently, two coincident images of the sun, quite intense and filling nearly half the field, may be obtained, capable of interference.

61. The revolving telescope objective.—When R , in figures 94 and 95, rotates, mere flashes of light would be seen at T if stationary, and the fringes would be invisible as they move broadsides on. Hence to study these phenomena I first availed myself of what is virtually a rotating telescope, shown in figure 96. H is the cylindrical body of a small electromotor, clamped at the foot F , and B is the horizontal shaft of the armature. To this axle the disk DD , about a foot in diameter, is attached in front and well balanced, capable, therefore, of rapid rotation. DD carries the objective P of the telescope, embedded near its outer edge, P' being a suitable counterpoise at the same distance from the axis B . The eyepiece E and tube of the telescope are carried by the ring GG , capable of rotating about the rear end of the cylindrical body of the motor and to be put in any desirable position by a set-screw, as at c . E is thus stationary and the telescope is complete when E and P are temporarily coaxial.

The fringes, when found in the interferometer, figures 94 and 95, without compensator, may be at any angle to the horizontal, and it is often troublesome to change their inclination. Hence the eyepiece E is to be set so that the

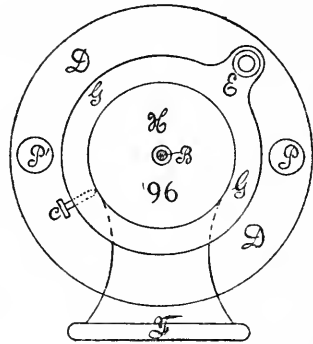
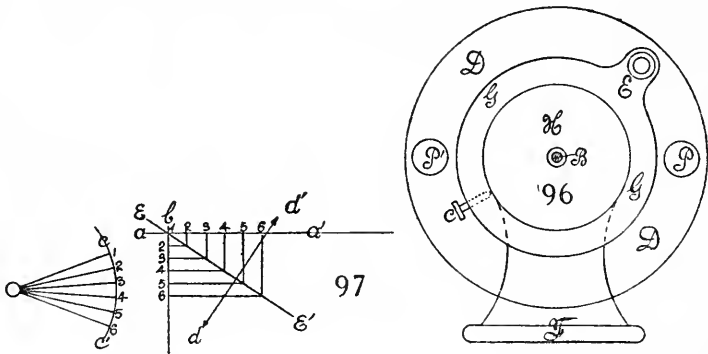

tangential motion of DD at E is parallel to the direction of the fringes. Since the fringes move by virtue of the rotation of the mirror R normally to their directions, they will be seen moving in the direction of the resultant. It is necessary, therefore, that the fringes be reduced to a length not exceeding their breadth, practically to points. This may be done, for instance, by a slot in a distant screen at the heliostat, the slot being at the proper angle to the horizontal. These relations are shown in figure 97. Let $a_1, 2, 3, \dots, a'$ be successive positions of the achromatic fringe, corresponding to the positions $c_1, 2, 3, \dots, c'$, of the normal to the revolving mirror; let $b_1, 2, 3, \dots, b'$ be the corresponding positions of the same fringe resulting from the rotation of the telescope objective. Then the fringe is seen in the line EE' . Hence the retardation due to the passage of light twice over the distances S, S' will produce a displacement of the line EE , observed in the telescope along the direction dd' , normal to it. It is in this direction, therefore, that an ocular micrometer would have to be placed.

It would furthermore be necessary, to insure synchronism, or a definite ratio of frequencies in the two revolving disks tt and DD , by gearing or otherwise. Moreover, the telescope must always be in the position of observation when the revolving mirror flashes. This is a difficult thing to do with two disks. It might seem (erroneously, however) as if a single disk tt , figure 94, could be used for both purposes, P being the telescopic objective and P' a counterpoise. In such a case T is to be replaced by the auxiliary mirror n , figure 94, which reflects light to a similar mirror under the objective P , the reading being made in an eyepiece above P . The eyepiece is so placed that the telescope is completed when the revolving mirror flashes. The possibilities of this plan will be considered presently. Obviously, the fringes must move in a direction differing from that of the objective. Hence they must be easily controllable as to inclination and size. Compensators C and C' may be set symmetrically (vertical and horizontal axes) by hand for this purpose. The same result is secured by putting M and N on vertical axes (with tangent screws) and M , and N' on horizontal axes (plane-dot-slot device).

62. Control fringes.—As the revolving mirror R starts from rest to attain its maximum speed, the line EE' in figure 97 will be more and more deflected from the original position bb to some position as indicated (EE'). Simultaneously, the retardation due to the time consumed by light in passing twice over the distance S will move EE' in the direction dd' . As it is this displacement which must be measured, the accomplishment would be difficult. One may, however, establish a set of control fringes independent of the distance S . To do this the half-silver plate hh' , figure 95, is inserted between the mirrors m and R and adjusted until the two slit-images from the distant m' and the near hh' coincide. Thus the fringes from hh' will not depend for position on the line dd' on the speed of R and may be used to define the zero of displacement.

Obviously hh' must be good optic plate. If this is not the case, not only will the pairs of slit-images fail to coincide at the same time, but the fringes will differ in size and inclination and appear for different positions of the revolving mirror R , or of the micrometer s , at M' .

63. Sensitiveness.—At this stage of progress a large number of experiments were made, using the equipment, figures 94, 95, 96. Providing the revolving mirror R (kept stationary) with a divided arc-and-tangent screw, a number of direct tests bearing on the sensitiveness were carried out, all referring to the velocity of light to fix the ideas. Thus the distance passed in t seconds is $d = ct$, while in the revolving mirror of frequency n , if θ is the corresponding angle, $t = \theta / 2\pi n$, whence $d = c\theta / 2\pi n$. But if s is the corresponding number of ocular scale-parts passed over by the fringes and k is the constant, $\theta = ks$; and finally, if l is the number of fringes (f) to the scale-part (s), $f = ls$.

Hence $\theta = kf/l$, and if $n = 10$, $d = \frac{ckf}{l2\pi n} = \frac{ck^of}{3600l}$.

The following values were obtained:

f	s	l	$10^4 \theta$	s	$10^4 k^\circ$	d/f miles	d/f feet
1	1	1.0	75	25	3.0	.016	82
1	1.4	.75	62	25	2.5	17	90
1	2.0	.5	37	25	1.4	15	77
1	.7	1.5	100	25	4.0	14	74

The data are rough, as the tangent screw micrometer was not adapted for such small angles. Thus at 10 rotations per second the distance d traversed by light per fringe is about 80 feet, or for the larger fringes 40 feet, per ocular scale-part of 0.1 mm. It would be possible to read within this. Since the distance S is passed twice, $d = 2S$; so that $S = 20$ feet per scale-part per 10 rotations per second, may be taken as an experimental estimate. It is of the same order, 30 feet per fringe, as the theoretical value above.

64. Experiments with the rotating telescope. Fringes on washed images.—

Having found the fringes for a short distance S , the revolving mirror was left at rest and the revolving telescope, figure 96, tested for adequacy of light. With the collimator and a long-focus condensing lens to illuminate the slit, the fringes were seen distinctly and manipulated; but they appeared too faint for practical purposes.

Removing the collimator and lens completely and using sunlight directly, the fringes (after adjustment) were displayed strongly on the intense images of the heliostat mirror. In the revolving telescope they came out beautifully, easily recording small micrometer displacements, or slight rotations of the revolving mirror.

At long distance S another difficulty arose, as the heliostat image (except for mirrors exceptionally large) was apt to be point-like. The light, however, was still abundant. Hence the device was adopted of putting the ocular out of focus. A large white field or glare is thus obtained, quite satisfactory for the display of fringes.

A variety of important experiments was now made, relating to fringes obtained on images out of focus; for this glare may easily be enlarged to fill the whole field by drawing out the ocular, or the reverse. It is necessary, of course, that the two component washed images be in coincidence; and this without a guide as to the identification of the points of their areas is a difficult adjustment to make. But if precautions are taken that the two pencils entering the objective of the telescope are quite coincident, the fringes will be large and they will not vanish in any position of the ocular. The reason for this is clear, since parallel pencils, partially coincident on entering the telescope, will coincide at the focus of the objective only. Thus the fringes will soon vanish for other positions of the ocular than the one corresponding to this focus.

One difficulty occurs here which must be guarded against. An ocular drawn in or out from the principal focus implies an object at a finite distance. Such

an object is virtually identified with the mirror M' and is displaced by its micrometer-screw. The rays passing through the optical center of the objective of the telescope thus become inclined to each other in proportion as they are nearer, and the inclination angle vanishes only for objects at infinity. Hence one component image will pass across the other slowly when the micrometer moves, and this is attended with a change of fringes.

Beautiful and intense fringes were obtained by the present method, displayed in the glare of an ocular out of focus and observed with a stationary telescope. They remained equally serviceable when viewed with the revolving telescope, where advantages in sharpness are often obtained by slightly resetting the ocular. Displacements produced by moving the micrometer or the revolving mirror were also examined with success. The effect was strengthened by using a long-focus condenser in front of the interferometer.

If the device of obtaining fringes on images out of focus is rejected, the full solar disk may also be used. This, however, requires large mirrors of strictly optic plate in the interferometer and its accessories. Taking the solar diameter at 0.53° and remembering that the distance S is doubled, mirrors 20 cm. square would be needed for each 10 meters of S , and the interferometer should be placed close to the heliostat.

65. The combined revolving mirror and telescope.—This apparatus, which has already been partially described in connection with figures 94 and 95, is shown in figures 98 and 99, plan and elevation. Sunlight enters through the long-focus doublet L , just in front of M , the focus being at the telescope, 10 or more meters distant. The component beams leaving the mirror N' are received by the mirrors n and n' in succession. The latter, being below the disk u' of the revolving mirror R , reflects them up vertically through the objective P embedded in u' . They are seen when P is in position, through the eye-piece E . P' is a counterpoise, relative to the axis A of the electromotor. The mirror n is at the intersection of a diameter of u' and the rays NN' .

When the telescope is completed, the eye will see a composition of the displacements due to the revolving mirror R and that of the objective P . The latter moves tangentially to u' and always in the same sense. The displacement resulting from a turn of mirror may be taken as parallel to the face of the mirror underneath u' and hence will be normal to the line nPP' (diameter prolonged), or in other cases normal to the tangents ns' and ns'' , supposing the objective embedded at s' or s'' .

It follows, therefore, that at P the displacements are opposite in direction, and if they are equal there will be no displacement. With the objective at P' the displacements are in the same sense, and the resultant equal to their sum. At $r's'$ and $r''s''$, finally, the displacements are more or less at right angles and the resultant a diagonal.

Quantitatively, if f is the focal length of the telescope, a the distance of the objective from the axis A , since the angle of reflection only is in question,

the displacement will be $f\omega\Delta t$ due to rotation of mirror and $\omega a\Delta t$ due to shift of the objective. Hence, if $f=a$, the image at P will be stationary. At P' it would move with the speed $\omega(a+f)$.

These conditions are easily tested by putting a fixed, vertical meshwork of wire gauze (sieve) between the doublet D and the mirror M of figure 98 and focussing the eye-piece E upon it. If $a=f$ the meshwork will remain stationary and clear, however fast the revolving mirror rotates, for any directions of the wires of the meshwork. In the same way a fine slit will remain in position during rotation. Moving the wire gauze between M and D , the position of maximum definition is easily found. With higher magnification, finer diagonal lines often appear, superimposed on the image.

In case of the objective positions $S'r'$ and $S''r''$, the wires of the grating are to be placed at 45° to the horizontal. In such a case one or the other of the parallel sets comes out strongly on rotation, the resultant displacement being along their direction. In these experiments one must distinguish between the mere displacement of the spot of light which depends largely on the effective area of the mirrors, and the displacement of an actual image like that of the grating, the latter being here alone in question.

The position $S'''r'''$ is also interesting, inasmuch as here the speed of the revolving mirror is virtually doubled; but no experiments were made with it. Obviously the mirrors N and N' must be screened off to admit of the passage of

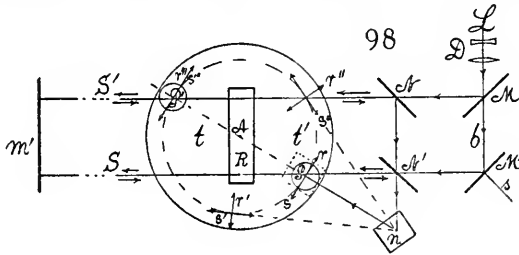

the parallel pencils at the same time only. Otherwise there will be three reflections in succession, one from N , one from N and N' , and one from N' . The first and last are single pencils and are not desirable.

Removing the objective from t' and using the revolving mirror in connection with the apparatus, figure 96, not synchronized, the result was like a display of occasional shooting stars, moving in parallel in all parts of the field, as would be supposed; but the light conditions were not unsatisfactory.

The combined plan just sketched is interesting for experimental purposes; but it does not meet the conditions of the problem, as may be indicated as follows: In the first place, it is desirable that the fringes be vertical and to move with the rotating mirror, therefore, in the horizontal direction. This in figure 98 implies fringes moving in the direction r . Hence the positions sr and $s'''r'''$ in the figure are not available; for the fringes would overlap in their motion and vanish. In the position $s'r'$ and $s''r''$, however, the fringes moving

in the direction r are drawn out in the direction s , nearly normal to r . Thus if the fringes are very short, they will be displayed as fringe bands, as heretofore. So far, therefore, the conditions are met.

If, however, we return to figure 97, it appears that if the fringe a_1 has been carried by the rotation of mirror to the position a_2 , the objective will have simultaneously carried it to b_2 etc. In other words, the fringe 1 will always remain on the line EE' , regardless of the retardation of light; *i. e.*, the line EE' will not move in the directions dd' as in the case of the independent revolving mirror and telescope. The effect of the revolving mirror has simply been compensated.

Nevertheless, this method of approaching the problem is well worth while, since it affords opportunities for correcting the details of the experiment. Strong fringes were produced without much difficulty and viewed through the telescope EP in the $s'r'$ position. But in spite of many trials, it has thus far been impossible to secure a sufficiently rigid and independent mounting of the disk $#'$ and revolving mirror to hold the fringes in the field during rotations of 5 to 10 turns per second.

CHAPTER VIII.

ON THE TORSIONAL MEASUREMENT OF VARIATIONS OF THE ACCELERATION OF GRAVITY, BY INTERFERENCES.

66. Apparatus.—These experiments were undertaken at the suggestion of Dr. R. S. Woodward, in order to find how far interferometer methods might contribute to the measurement of g , under circumstances in which the pendulum is inapplicable. The apparatus, as a whole, is a horizontal torsion balance with the deflection readable in terms of the displacement of the achromatic interference fringes. The method of registry developed would be applicable in case of an ordinary chemical balance.

In figure 100, M, M, N, N' are the mirrors of the interferometer (N' being on a micrometer P , normal to its face), the white light coming from a collimator at L and observed by the telescope at T . $CMM'C'$ is the balance beam, supported by the tense horizontal torsion wire w , normal to the beam, mm' being the auxiliary mirrors of the interferometer. This beam is of steel, U-shaped in section, figure 101, and the wire ww' passing through two notches at the top edges of the beam, normally to its length, is looped through a hole in the bottom. One end of ww' is wound around the threads of a screw, so that ww' may be kept tense at pleasure; the other end is fastened to a torsion-head, the index of which is registered as to position by the graduated circular scale SS , coaxial with the wire.

The ends of the beam mm' are filed flat and bent L-shaped and at their ends carry two vertical needle-points, as shown in figure 100. On these rest the light caps c, c' , from which depend the light disks v, v' , like the pans of an ordinary balance. To give the system the necessary damping, the disks v, v' are loosely inclosed by the cylindrical capsules or dash pots d, d' , free from contact.

The whole balancing system is inclosed by the case CC' , the top face of which, g , is plate glass. Vertical slots s in the long sides of the case serve for the admission of the torsion-wire w . These are afterwards nearly covered by glass plates. The ends of CC are perforated with wide holes, also to be closed by glass plates ee' . It is through these windows that the weight to be measured is introduced, by placing it either on the vane v or v' . To do this smoothly the weight is of wire bent along the edges of a tetrahedron. It may thus always be placed or picked up and removed with the aid of a small rod or hook.

As this weight is constant, its equivalent torsion may be registered (fig. 102) by two micrometer tangent screws t, t' , on the graduated circle S , which serve as stops to the index a of the torsion-head. Smaller changes of weight may, therefore, be registered either by the micrometers t and t' , which modify the torsion, or at N' , which displaces the fringes.

The whole apparatus was erected on a heavy cast-iron base about a foot in diameter. The collimator must be attached to this if a line across the slit is to

be the index in measuring the fringe displacement. If the telescope with cross-hairs is so to be used, this must also be rigidly attached to it. I used the former method in preference.

After the stops t and t' (fig. 102) to the index a have been fixed, the measurement consists in moving the micrometer P at N' , until the fringes coincide with the guide-wire across the slit-image. This wire should be very fine. If the micrometer-screws at t or t' are moved, the images of the cross-wire and fringes both move, preferably in opposite directions; but the fringes move several-hundred times faster, so that the slit-image is relatively stationary, or can just be seen to move.

In the first experiments a phosphor-bronze wire 0.025 cm. in diameter and about 35 cm. long was inserted. This was adapted for small weights of the order of a few centigrams. The double deflections here amounted to about 1.7° per milligram and measured about 5 mm. on the scale S . As a rule, however, thicker wire and larger weights will be preferable, contributing to a more robust apparatus.

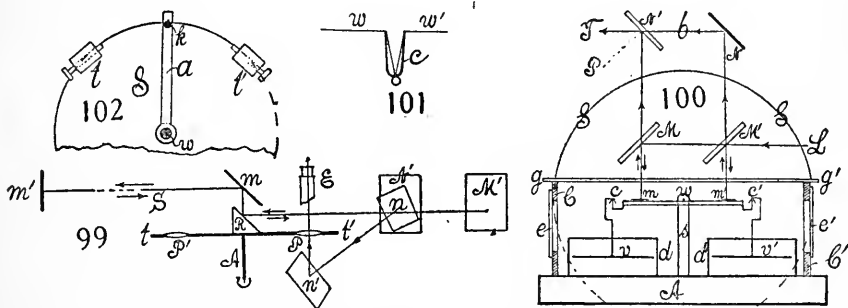

As to dimensions of the apparatus constructed, I may add that the beam $cmm'c'$ was 22 cm. long, the disks v about 5 cm. in diameter, and the distance cv about the same. The breadth b of the ray parallelogram (fig. 100) was 10 cm. The apparatus stood about 50 cm. high and should have been covered with a case to obviate air-currents, in addition to the case CC .

The wire is to be kept free from twist, except when used. The degree to which the twist, and therefore the sensitiveness, may be increased without an error from viscosity must be left to trial.

In the earlier apparatus the balance was rigidly attached to the base A . In the later forms with thicker wires of steel, the balance and appurtenances were mounted on an *independent* framework of iron, which could then be slid underneath the interferometer, as shown in figure 100. This makes it much easier to insert new wires w , and adjust the mirrors mm' to approximate parallelism, by aid of a beam of sunlight or the like.

In the above apparatus caps on pivots were chosen at the scale-pans, merely for convenience of construction. It is obvious that knife-edges and plates would, in general be preferable, by reason of greater stability.

With the air damping above the apparatus is practically aperiodic for thin wires (0.02 cm.) and the beam takes its place at once. It is still sufficiently

so for thicker wires (0.05 cm.). The work may, therefore, be done rapidly. Oil damping, even if not otherwise objectionable, was found to be too slow, as a rule. Thermal discrepancies (air convection) decrease when the wires are thicker; but the disturbances from viscosity increase.

The frame carrying the wire and the torsion-heads must be quite rigid. If the torsion-head works stiffly, the twist of the framework is always perceptible. This must be scrupulously guarded against.

67. Measurements.—With the original phosphor-bronze wire, a trial showed a double deflection at S of 1.7° per milligram. Half of this is available at the mirrors m, m' . The equation of the interferometer may be written $b\Delta\theta = \Delta N \cos i = \lambda/2$, b being the breadth of the ray parallelogram, $\Delta\theta$ the rotation at the mirrors m, m' , corresponding to the displacement of micrometer ΔN when i is the angle of incidence (45°) and λ the wave-length. Thus for the double deflection per milligram

$$\Delta N = b\Delta\theta / \cos i = 10 \times (1.7/2) \times 0.0175 / 0.71 = 0.21 \text{ cm.}$$

As $\Delta N = 10^{-4}/2$ cm. can be registered on the micrometer, $10^{-4} \times 2.4$ mg. may be estimated. Thus, if a weight of 25 mg. is used, the sensitiveness would be within 10^{-5} .

Per fringe the conditions are somewhat better. For here

$$\Delta\theta = \lambda/2b = 10^{-5} \times 6/20 = 3 \times 10^{-6} \text{ radians}$$

and this corresponds to $3 \times 10^{-6} / 0.85 \times 0.0175 = 2 \times 10^{-4}$ mg., while a fraction of a fringe is still determinable.

To make this fringe sensitiveness available, the tangent screw-micrometer must be used, as the achromatic fringes serve merely as an index. Here $\Delta\theta = \lambda/2b$ at the mirrors corresponds to $2\Delta\theta$ at the end of the wire. If ΔS be the displacement of the micrometer at the tangent screw and $R = 18.2$ cm. the radius of the graduated circle S ,

$$\Delta S = R\lambda/b = 18.2 \times 6 \times 10^{-5} / 10 = 1.1 \times 10^{-4} \text{ cm.}$$

per fringe. Fractions of a fringe can therefore here be recorded.

If t is the modulus of torsion and m the mass weighed at the end of the lever-arm, $b' = 11$ cm., mg $b' = t\Delta\theta$, and therefore

$$g = \frac{t \cos i}{mbb'} \Delta N = \frac{tn\lambda}{2mbb'}$$

for a passage of n fringes.

In case of the phosphor-bronze wire of diameter 0.025 cm., the values of t in terms of milligrams would thus be

$$t = 10 \times 981 \times 11 / 8.5^\circ \times 0.0175 = 7.2 \times 10^5$$

Hence if Δg corresponds to one fringe,

$$\Delta g = \frac{7.2 \times 10^5 \times 6 \times 10^{-5}}{2 \times 10 \times 10 \times 11} = 2 \times 10^{-2}$$

or if a mass of 20 mg. is used

$$\Delta g/g = 10^{-5}$$

Much larger weights than this are available without exceptional risk from the viscosity of the wire. Moreover, if the mass weighed increases as the torsion coefficient of the wire, the sensitiveness is not changed, again with a reservation as to viscosity.

The experiments with the phosphor-bronze wire were carried out both in terms of ΔN at the mirror micrometer and of ΔS at the tangential micrometer. There was no difficulty in finding or controlling the fringes, so far as the apparatus was concerned, either at the zero position or at the two elongations. They appear whenever the guide-wire across the slit is sharply in coincidence with the intersections of cross-wires in the telescope, so that telescope and collimator are to be rigidly fastened, although only the collimator cross-wire (fringes coinciding with its image) determines the measurement. To this extent the damping seemed to be sufficient. Fringes large and small were tested; but in a steam-heated room the fringes were always in slow and deliberate motion over half the length of the slit-image, irregularly to and fro. Possibly this might have been avoided by placing a second case over the apparatus as a whole, to obviate air-currents and unequal distributions of temperature. This however, would have been inconvenient, particularly so as a modification apparatus with a more rigid wire and larger weights conduces to further practical advantages.

The next experiments were made with a steel wire (music wire) 0.0224 cm. in diameter and very hard drawn. The modification already referred to, of an independent scaffolding for the wire, its end supports (torsion-head, etc.), the balance beam and dash-pots, was now introduced. Again the operations for measurement proceeded very satisfactorily; but the fringes were still in continual motion, though perhaps not so much so as in the preceding case. The weight used was just short of 0.05 gram, the double deflection about 68.7° . In some 12 alternations made between the stops on S , the fringes, though moving, always reappeared in place in the field. If at the scale S , $\delta\theta = \lambda/b$ and $\Delta\theta = 68.7^\circ \times 0.0175$,

$$\frac{dg}{g} = \frac{\delta\theta}{\Delta\theta} = \frac{6 \times 10^{-5}}{10 \times 68.7 \times 0.0175} = 5 \times 10^{-6}$$

per fringe passing the cross-wire of the slit-image. It seems a pity, therefore, that this sensitiveness could not be utilized.

68. Thicker wire.—As the observations with the above wire were useless, because of convective temperature discrepancies, I inserted a thicker drawn-steel wire 0.05 cm. in diameter. The forces being thus 20 times larger, the apparatus showed much greater freedom from the annoyances specified. The behavior was far steadier, though the damping coefficient had proportionately decreased. It was not, however, even now possible to rely on a single fringe in a heated room; but in the summer time this would be the case. Temperature also modifies the elastic constants seriously.

On the other hand, the effect of viscosity was now much more obvious, there being a proportionately greater twist of the individual fibers of the wire.

A weight of the order of 1 gram was selected and the double twist produced by this was $\Delta\theta = 138.2^\circ - 88.2^\circ = 50.0^\circ$. The weight was passed from pan to pan without difficulty and the fringes set to coincide with the shadow of the cross-wire on the slit. Great care had to be taken to avoid twisting the frame of the carrying wire and torsion heads. If the beam is of steel, fluctuations of the magnetic field are also a menace.

The data of the interferometer being identical with the above, we may write

$$\frac{dg}{g} = \frac{\delta\theta}{\Delta\theta} = \frac{\Delta N \cos i}{b\Delta\theta/2} = \frac{10^{-4} \times 0.71}{10 \times 25 \times 0.0175} = 1.6 \times 10^{-5}$$

and as ΔN may be read within 10^{-4} , the sensitiveness is about 10^{-5} , the gram counterpoise in question presupposed.

The error to be apprehended from viscosity may be obtained from the following observations (table 2, series 0) of the yield of the wire with a gram excess on the scale pan:

TABLE 2.—Viscous deformation of hard-drawn steel wire.

0.05 cm. in diameter. Total length 35 cm., double deflection 50° , counterpoise 1 gram. Series 0.			Same wire tempered blue by electrical current. First twist. Series 1.			Same wire (blue). Second twist. Series 2.		
Time, min.	$\Delta N \times 10^4$ cm.	$(dg/g) \times 10^5$	Time, min.	$\Delta N \times 10^4$ cm.	$(dg/g) \times 10^5$	Time, min.	$\Delta N \times 10^4$ cm.	$(dg/g) \times 10^5$
0	0		0	0		0	0	
3	21	33	1	5	8	4	21	33
10	43	69	7	16	26	11	36	58
17	61	98	21	26	42	66	87	139
30	78	125	74	49	78	113	115	
73	113		111	59		154	133	
163	156		176	79		219	152	
196	173		259	87		284	165	
276	197		1,200	93		340	168	
359	217							
*1,400	314							
*1,915	381							
*2,880	493							

* Room colder.

The observations marked [*] were made in a very cold room and give evidence of increased rigidity. The table shows that if measurement is made within 3 minutes after twisting, the error from viscosity, if ignored, would not exceed $dg/g = 33 \times 10^{-5}$; within 10 minutes it would not exceed 70×10^{-5} . If, however, the coefficient of viscosity is known, from a preliminary examination of the wire, an error of $dg/g = 3 \times 10^{-5}$ is improbable.

Hand-drawn steel, though admirably resilient, is a metal of somewhat low viscosity, particularly when subjected to additional tensile stress between the torsion-heads. To remedy this, the wire must be tempered. Samples were taken and tempered in molten lead. It was found that they had lost but little of their resilience, contrary to expectations; but their viscosity is necessarily increased, owing to the elimination of molecular instabilities.

The frame carrying the wire in the above experiment was therefore removed and an electric current (10 amperes) passed through the wire from end to end, till it showed the blue oxide coat virtually equivalent to tempering in lead. The adjustments of the wire in the frame were not otherwise disturbed. Hence on putting the frame back in the interferometer, the fringes were found at once. Observed in the zero position (no stress), the wire showed no displacement of fringes in the lapse of time, due to viscosity.

The observations (table 2, series 1) were now made for the viscous yielding of the wire with a gram weight on one scale-pan.

The wire is thus about 2.5 times more rigid than in the hard-drawn state. In fact, if $r = \Delta N / \Delta N'$, the ratio of yielding caet. par., in the two cases, the results obtained by graphic interpolation show

Time	10	20	40	70	120 minutes
$r =$	0.42	0.41	0.39	0.41	0.46

Variations at the beginning are attributable to fluctuations of temperature. It must be noticed, however, that the change of stress is here from zero and thus but half the change (reversal) occurring in the preceding experiment. The effective increase of viscosity is thus not so large as was looked for. Twisting the wire in the opposed direction by shifting the grams to the opposed scale-pan, the viscosity, therefore, diminished considerably, as was expected. The second twist, moreover, is always characterized by maximum yield. The readings (beginning about 4 minutes after twisting) are given in table 2, series 2. The rigidity gained by the tempered wire as compared with the original wire is about 30 per cent, not as much as was hoped.

TABLE 3.—Viscous deformation of hard-drawn steel wire, tempered blue. Diam. 0.05 cm., length 35 cm. (one-half effective). Double twist 50°, due to counterpoise of 1 gram.

Series.	Time.	$10^4 \times \Delta N$	Series.	Time.	$10^4 \times \Delta N$	Series.	Time.	$10^4 \times \Delta N$
	<i>min.</i>	<i>cm.</i>		<i>min.</i>	<i>cm.</i>		<i>min.</i>	<i>cm.</i>
3	0	0	6	0	0	9	0	0
	6	28		2	12		3	17
	13	42		8	34		9	30
	33	61		16	47		54	60
	76	83		59	76		83	71
	125	103		111	89			
	1,090	128		1,074	174			
4	0	0	7	0	0	10	0	0
	3	15		6	18		3	22
	6	26		11	28		8	34
	15	44		82	76		32	63
	24	62		157	102		122	98
	72	103						
	123							
	183							
5	0	0	8	0	0	*11	0	0
	3	22		3	22		3	22
	8	37		8	36		7	37
				36	64		12	49
				92	87		68	96
		106		90				

*After twisting back and forth about 100 times.

Successive alternations were now made by twisting the wire between fixed stops, using the gram weight specified as a counterpoise. Table 3 is a summary of these results. The whole of the 10 series for the blue state are further shown in figure 103, which also contains the graph for the hard-drawn state.

As a rule, the curves for tempered wire, so obtained, differ but little. When they do, some irregularity in twisting the wire, or an accidental delay in finding the first fringes or different periods of application of the preceding stress,

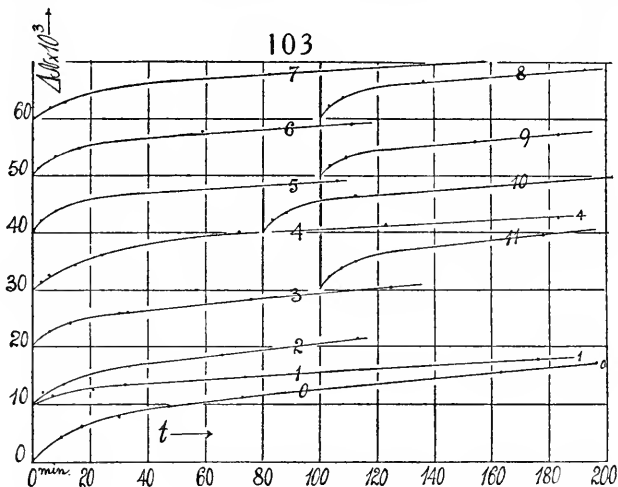

differences of temperature, etc., are in question. In the last series, No. 11, the wire had been previously twisted to and fro upwards of 100 times to test the stops. The effect is some decrease of viscosity. In general, the odd series show less yield than the even series, probably because the stress is not quite symmetric on the two sides.

69. Equations.—Equations for the description of the yield in the lapse of time have been proposed by different authors, in particular by Kohlrausch, the original investigator. They are usually rather complicated higher exponentials. It is interesting to test a tentative form. Let it be supposed that the rate of yield dy/dt is proportional to the number dn/dt of instabilities vanishing per second, so that

$$(1) \quad -dy/dt = Cdn/dt \text{ or } A - y = Cn$$

Furthermore, let the decay of instabilities vary as the square of the effective number n present; *i. e.*,

$$(2) \quad -dn/dt = \alpha' n^2 \text{ or } \frac{1}{n} - \frac{1}{n_0} = \alpha' t$$

If equation (1) is inserted, (2) takes the form

$$(3) \quad \frac{1}{A - y} - \frac{1}{A} = \alpha t$$

since for $t=0$, $y=0$. Equation (3) may be written

$$(4) \quad 1 = (1 + \beta t)(1 - y/A)$$

where β and A are constants.

Such an equation will necessarily fail in the lapse of time, since A is the limit of y in (3); whereas experimentally y probably increases indefinitely. On the other hand, however, thermal instabilities are always present, apart from stress, so that equation (2) can only refer to the stress part of the phenomenon. Furthermore, the exact time of the beginning of viscous deformation can not be adequately specified, since there are a few minutes of irregularity in exchanging the weight and placing the fringes. The initial observation ($t=0$) is thus inevitably a few minutes late. Hence an equation which fits the data of the first 30 minutes nearly enough for practical purposes is all that could be at issue. Yet even this modest expectation is not realized. Thus if we combine the first and third, second and fourth observations, the data are, for example:

Wire:	Drawn.	Blue (1).	Blue (2).	Blue (3).	Blue (4).
$10^4 A$	= 100 125	33 62	109 152	87 103	110 160
$10^8 \beta$	= 90 54	180 50	60 28	75 54	53 25
$10^8 C$	= 79	45	54	60	49
$10^4 \Delta N$ at 100^m	= 125	55	107	93	110

A rapidly increases and β diminishes in the lapse of time (here about an hour or two). If $A\beta=C$, the equation takes the form

$$(5) \quad y = Ct / (1 + \beta t)$$

indicating that at least another power of time must also occur in the denominator if the equation is to reproduce the data. The reduction is thus not simple.

There would not, however, be any real hardship in adapting a function by which the amount of twist at any definite time after twisting could be accurately computed. The real difficulty lies in the time-loss in the shifting of the weight, and the subsequent adjustment, for fringes, etc. Twist is thus not imparted suddenly or all at once. The initial time ($t=0$) is too indefinite. Again, since the balance-beam remains horizontal, but one-half of the wire is twisted, the other remaining without stress and idle, unless two symmetrical torsion-heads, one at each end of the wire, are used. For these reasons I discontinued the present method temporarily in favor of the next, § 71, where t is very large, the yield proportionally small, and where certain advantages of stability would accrue to the method. It indicates the importance to be attached to the thermal coefficient of rigidity.

70. Absolute viscosity of the wire.—The curves given may be used to obtain the absolute viscosity η of the wire, for the given rate of twist and diameter, and at any time after twisting. As but half the wire is used, the full torque FL (where L is the half length of the beam (11 cm.), F the weight of the

counterpoise, 10^6 dynes) acts on the length of 17.5 cm. of wire. Hence, if τ is the twist per linear centimeter, n the rigidity of the steel wire of radius $r=0.025$ cm., and $d\theta/dt$ the angular yield per second,

$$\eta = \frac{2PL}{\pi r^4 d\theta/dt} = \frac{n\tau}{d\theta/dt}$$

This equation (as I showed elsewhere *) is found by an integration of the viscosity equation, from the axis to the circumference of the wire. But $d\theta/dt = \Delta(dN/dt) \cos i/b$ in the above notation for the interferometer, so that

$$\eta = \frac{2PLb}{\pi r^4 \cos i} \frac{1}{\Delta(dN/dt)}$$

$\Delta(dN/dt)$ being the micrometer displacement per second, given in the curves, figure 103. If $r^4 = 10^{-7} \times 3.9$,

$$\eta = \frac{2 \times 10^6 \times 11 \times 10}{3.14 \times 3.9 \times 10^{-7} \times 0.71} \frac{1}{\Delta(dN/dt)} = 10^{14} \times \frac{2.53}{\Delta(dN/dt)}$$

If equation (3) were true, $\Delta(dN/dt) = \beta(A - y)^2/A$, where β must be reduced to seconds.

Taking $\Delta(dN/dt)$ from the graphs, figure 103, in case of series 0 (drawn hard) and 2 (tempered) at successive times t , the following data hold per second respectively

	$t = 5$	10	20	50	100 min.					
$\Delta(dN/dt) \times 10^3 =$	6.7	6.0	4.7	4.0	3.0	2.0	1.2	1.0	0.8	0.8
$\eta \times 10^{-20} =$	0.38	0.42	0.54	0.63	0.84	1.26	2.1	2.5	3.2	3.2

Thus the absolute viscosity for the given twist and diameter in these cases increases in 100 minutes from about 4×10^{19} to 3×10^{20} and thereafter is nearly constant. The single rate of twist is about $(\frac{1}{2})(50/17.5) = 1.4^\circ$ per linear centimeter; but in alternating the twist the effect of this is doubled. It is clear the η must depend on the rate of twist in relation to the thickness of wire, inasmuch as the outer fibers probably yield most. This is among the reasons for the inadequacy of equation (2). If this is used in the form (3), the mean viscosity between 3^m and 17^m comes out $\eta = 5 \times 10^{19}$ and between 10^m and 30^m 8×10^{19} for the drawn wire.

71. Twist in one direction only.—The actual torsional weighing by passing the counterpoise from pan to pan is in itself a delicate operation when interference fringes are used. Moreover, the variation of viscosity is particularly large at the beginning. If the weight remains on one side, the viscous deformation not only grows indefinitely smaller and subject to simpler equational conditions, but the apparatus itself may be made less cumbersome and steadier. Thus in figures 104, 105, if w is the wire stretched between torsion-heads (the wire running normal to the balance-beam) and mm' are the auxiliary mirrors of the interferometer rigidly attached to the beam, the latter

* Phil. Mag., XXIX, p. 337-55, 1890; Clark Univ. Lectures in Physics, 1909, p. 149.

may be prolonged and terminate in the thin metallic plates p, p' . These are to be surrounded by the narrow cases c, c' , to secure air-damping. The device is now much more efficient than in the former apparatus, for there are no loose connections or scale-pans and the cases c, c' may fit rather closely to the parts p, p' of the beam, with but a small opening in front, for vibration. The counterpoise W , by which the torsion of the beam is to be maintained, is adjustable but rigidly attached at some convenient point.

The cases c and c' were each placed on three leveling-screws below, and held in place by a stout vertical spring above, pressing downward. In this way it was easy to free the plates p, p' , particularly as the cases were adapted to slide (with friction) on the leveling-screws.

The new method thus depends on the degree to which the viscosity of the wire vanishing at a retarded rate through infinite time may be adequately treated as a correction. The experiments showed, however, that it also depends to an alarming extent on the thermal coefficient of rigidity, if ordinary metals are used, though it remains to be seen in how far the Guillaume alloys will meet the conditions.

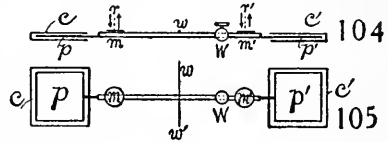

72. Observations on the permanently twisted wire.—The readings were made two or three times daily, as a rule. They were adequately recorded in the graphs, figures 106 and 107, for a period of about a month. The ordinates show the displacement of the micrometer ΔN , the divisions of the graph being in steps of $\Delta N = 0.001$ cm. As the twist produced by the excess weight of about 1 gram was here (as above) about 50° , we have $dg/g = 1.6 \times 10^{-4}$ for each of the divisions (0.001 cm.) of ΔN . The laboratory temperature was very variable from day to day, and the effect of this in the graphs is astonishing, but contributes essentially to the interpretation. In figure 106, the average rate of yield may be estimated as $\Delta N = 0.00091$ cm. per day, as the result of viscosity. This makes dg/g vary 0.00014 per day, a quantity in itself too large to be used as a correction. Even a more serious consideration is the thermal increase of rigidity. It is this feature which makes the graph so exceedingly jagged. If we take the large drop between the eighth and tenth days to estimate this effect, the data would be

Temp. $t = 22.0^\circ$	14.8°	19.8°
$10^3 \Delta N = 8.1$	2.6	8.7

which is equivalent to $\Delta N / \Delta t = 0.00095$ centimeter per degree, or $dg/g = 1.6 \times 10^{-4}$ for each degree of fall of temperature as the equivalent of increased rigidity. *

The graph, figure 107, is actually worse; for here, between the twentieth and

* Excellent observations on the torsional rigidity of iron and steel, due to Pisati, are given in Landolt and Boernstein's tables, 1905, p. 44. The coefficients are 2.1×10^{-4} for iron and 2.3×10^{-4} for steel, therefore even larger than the above estimate. Moreover, the above method could easily be modified to measure this constant accurately.

twenty-fifth days, in which the temperature falls from 23° to 14° , there is no adequate recovery afterwards. It would seem if this were a dislocation within the interferometer, though I noticed nothing differing from the usual behavior. A slight change of parallelism in the mirrors, due to drop of temperature, is always first corrected.

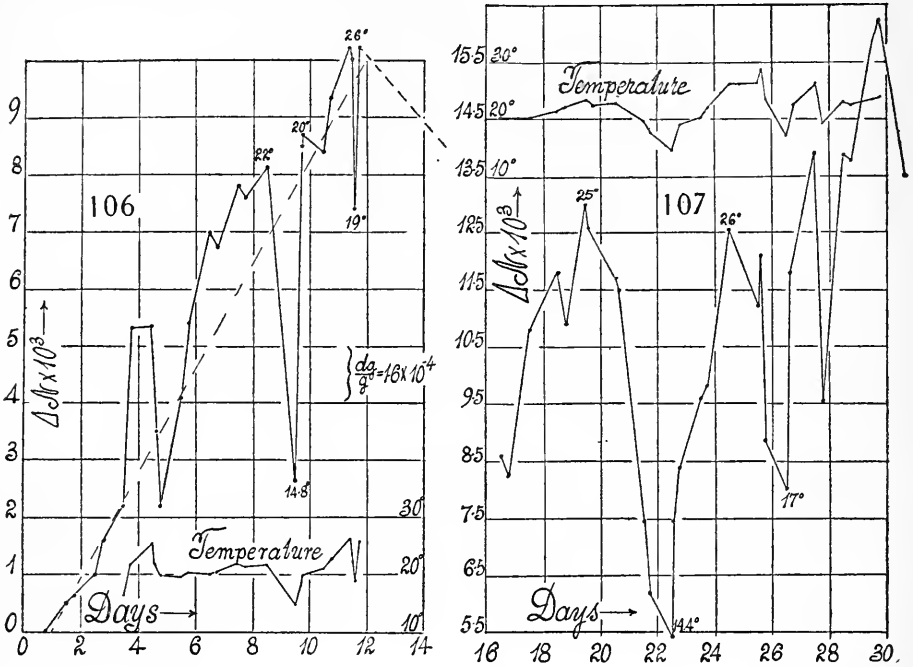

It follows, therefore, that even if the temperature variations have here been purposely exaggerated to exhibit the evidence more strikingly, there is very little hope, in the case of the common metals, of using the permanent torsional deflection produced by a weight for the measurement of variations of gravitational acceleration. For the incidental and spurious variations of dg/g amounting to over 10^{-4} per day for the case of viscous yielding and nearly 2×10^{-4} per degree of temperature for the case of rigidity, are too large to be treated adequately as corrections. The above method of direct weighing, even apart from its inconvenience, would not be more trustworthy, as it must contain the same inherent errors.

73. Further experiments with the preceding apparatus.—The damping in case of the apparatus, figures 104 and 105, when the plates p , p' are about 5×5 cm. square and within 1 or 2 mm. of the top and bottom of the shallow cases c , c' is exceedingly good. The beam mm' , even with the relatively thick steel wire w used, is practically aperiodic. Hence, on putting a wide plate of brass underneath the system $pmm'p'$ and close to it for an additional protection from air-currents, no further casing is needed. If the mirrors m , m' are wide,

notched tubes may be placed around them, standing on the plate in question; but these are hardly needed. The beam mm' is thus easily accessible without any opening of the doors of a case. The fringes occasionally move, but they at once return to their equilibrium position, which is thus easily recognized.

It seemed worth while to test this by removing the counterpoise W and proceeding with the method of weighing at the two ends of the beam mm' , as in the first part of this paper. For this reason stiff hooks, h , figure 108, were fastened rigidly at each end of the beam m . The plates p , p' in the cases c , c' were soldered to the bottom of h , as shown. The weight b was bell-shaped and reposed on the sharp point of the hook h . A small projection on top allowed of its easy removal with forceps. Adjusting the stops of the torsion-head of the wire w , the bell-weight b could be passed (with the requisite torsion)

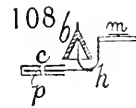
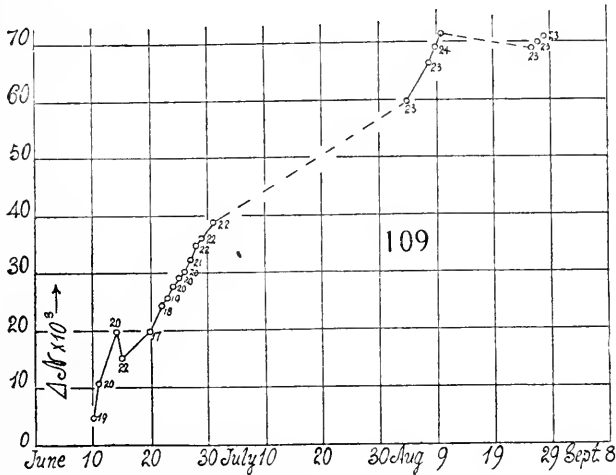

from one end of the beam to the other, without any inconvenience, the fringes in either case of adjustment appearing at once in their proper position relative to the cross-wire at the slit of the collimator. Of course, h must be stout enough to be practically free from flexure relative to b .

With adequate damping a similar arrangement should also suffice for a knife-edge balance, though here the plan of figure 102 would probably be more available.

Many experiments were made with the apparatus, figure 108. Naturally, however smooth the results, they are ultimately all subject to the temperature coefficient of torsional rigidity.

An example of continuous results extending over 3 months is given in figure 109. The ordinates show the displacements of micrometer in centimeters. The kinks in the curve are the results chiefly of change of temperature in its effect on the rigidity of the wire. Not impossibly rapid temperature changes, such as occur in the summer, may produce some yielding within the interferometer itself.

The interesting feature of the curve is this: When observations are made daily, implying, therefore, daily torsional interference with the wire, the viscous yield is relatively great. When the wire is left quiet without interference, as during July and a part of August, the yield is much less pronounced. It is not improbable that the molecular disturbances due to the slight inadvertent twisting (vibration) during observation may account for this result. The motion of the undisturbed wire may even be retrograde, as in August. If this inference is correct, it points seriously to the instability of structure of a permanently twisted wire, even when the twist is not excessive.

CHAPTER IX.

A PNEUMATIC METHOD OF MEASURING VARIATIONS OF ACCELERATION OF GRAVITY.

74. Introductory.—Some years ago I made an extended series of experiments* on the diffusion of gases through water, the gas having been imprisoned in a Cartesian diver; the very sensitive conditions under which the diver floats at a given level were made the criterion of measurement.

Inasmuch as such experiments consist virtually of a comparison of weights with the forces derived from air-pressures, it must therefore be possible to obtain the acceleration of gravity in terms of these pressures, just as in the preceding chapter of this report the endeavor is made to evaluate the changes of g in terms of torsion. It will not, of course, be possible to determine g absolutely in this way, because so little air is used; but the question as to what degree the changes of g should, in a proper environment, be determinable with some precision is worth investigating.

75. Apparatus.—The chief difficulty with the experiment at the outset seems to be the elimination of loss of gas by diffusion. This, in the case of a cylindrical diver, open below, amounted in the experiments cited to 0.41 per cent per day. It would not, therefore, be long before the whole of the gas would be lost. To avoid this, two resources apparently suggest themselves: (1) to place the diver about midway between two layers of air, one below and the other above it; and (2) to provide the diver with a long slender neck below, precisely what was to be avoided in cases of diffusion.

I shall describe two forms of apparatus in which these precautions are taken, the first intended for laboratory experiments or information, merely; the other suggesting a possibly definite form of apparatus. Figure 110 is the experimental type. Here AA is a stand-glass containing water ww , the diver ab , and the lower air-chamber cd . The vessel is closed above by a rigid cork, carrying the thermometer T in a central perforation, and a lateral tube t for exhaustion. The water-level at e is at a distance h above the water-level a in the diver when the latter is floating. The air at c below is contained in a porous cup, wedged in place, and the difference of heights of water-levels at a and cd (the top of the porous cup) is also to be about h . The bottom of the diver ends in a narrow tube, only just wide enough to admit of easy egress or influx of water, subject to changes of pressure. Under these circumstances the loss of air by diffusion from a to e will be practically balanced by the opposed diffusion from c to a . The narrow neck also obviates danger from ingress of any minute air-bubbles. When not floating, the diver should repose with its mouth at some distance above c . The bottom of the thermometer bulb determines the

* Carnegie Inst. Wash. Pub. No. 186, 1913.

floating level, the diver being essentially unstable, and either rising or falling with acceleration.

To operate the apparatus the air is exhausted at t until the rider just strikes the thermometer bulb. The top should, therefore, be flat. A very slight leak is then made at t , and the air-pressure and temperature (at T) read off at the moment when the rider and thermometer separate. With a light diver this is determinable with remarkable exactness, particularly if the influx of air is very slow. To determine the air-pressure, a mercury manometer and barometer are here necessary. The former should be adjusted to 10 or 20 cm. Pressures within 0.1 mm. of mercury and temperatures to a few hundredths degree are required.

As the exhaustion proceeds, the water-level at c rises, owing to the expansion of air both at a and at c . The head h refers, therefore, to the instant of flotation. Such a change of level is naturally undesirable, as is also the double mercury apparatus, manometer and barometer, for air-pressure.

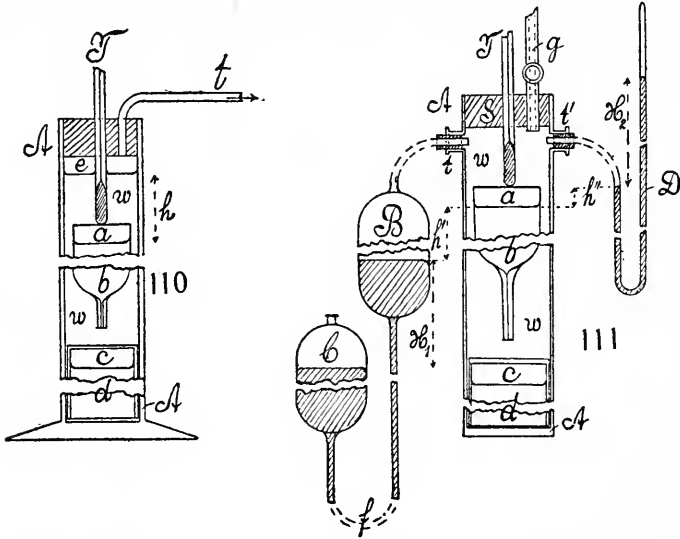

To obviate this, the type of apparatus, figure 111, was designed. The vessel AA , swimmer ab , air-supply cylinder cd , thermometer T , etc., are practically the same as before; but an auxiliary tubulure with a stop-cock g has been added. Two lateral tubulures t and t' , however, are here available; one of these t' communicates with the attached barometer D ; the other, t , with the mercury receivers B and C , connected by a flexible pipe, f . Between the terminal mercury columns at B and D , the whole system, with the exception of the air-spaces at a and c , is filled with water. If the mercury heads H_1 and H_2 and water heads h' and h'' be determined as shown in the diagram, the air-pressure at the level a will be

$$p = (B - H_1) \rho_m g - h' \rho_w g - \pi = H_2 \rho_m g + h'' \rho_w g - \pi$$

when B is the barometric height and π the vapor-pressure of water-vapor.

Hence, if the vessel C is placed on a vertical micrometer-screw, so that C may be raised and lowered with precision, the pressure needed to just float the diver may be applied at C , and its value accurately read off at D . This obviates the need of a special barometer reading. The vessels B and C must be large enough to admit of the expansion of the air at a and at c . The endeavor should also be made to eliminate the water-head h'' . With divers about an inch or more in diameter and two or more inches long the apparatus need not be cumbersome. The height of the stand-glass need not exceed a foot. Pressures of about 60 cm. at D and 16 cm. at C , B are convenient. There is the outstanding objection, however, that the air-bubble is stored under pressure. This will be treated below.

76. Equations.—If M is the mass of the diver, m that of the air contained at the absolute temperature τ and pressure $h + (H - \pi)\rho_m/\rho_w$, in centimeters of water (h being the incidental water-head, figure 110, H the residual mercury-head, and π the vapor-pressure in centimeters of mercury, ρ_m, ρ_w, ρ_g , the densities of mercury, water, and glass, all read off at τ), we may write for the gravitational acceleration, g :

$$(1) \quad g = \frac{Rm\tau}{(h + (H - \pi)\rho_m/\rho_w)(M(1 - \rho_w/\rho_g) + m)}$$

The first term in the denominator is to be multiplied by ρ_w at τ , to get the water-head at 4° C.; the second term to be divided by ρ_w to get the volume of the air-bubble. These reductions, therefore, cancel each other. Mercury, water, and air are necessarily at the same temperature, at least in apparatus, figure 111. The partial exhaustion was produced by a Geryk air-pump with an interposed exhaustion chamber to insure the required slowness of leak.

Thus it follows that variations of g are determinable with the same accuracy as τ and H . The former, being of the order of 290° , 0.03° C., must be guaranteed if g is to be correct to 10^{-4} . Furthermore H , which is about 60 cm. of mercury, must be read to 0.006 cm. for the same accuracy. Both of these requirements are moderate. By tapping the table from below, the light swimmer is slightly separated from the thermometer above, and the degree of flotation may thus be estimated with great precision by the speed with which the swimmer rises again into contact. An accuracy of 0.01 per cent in g may thus be expected, provided m is adequately constant. It is thus the chief purpose of this paper to see to what degree this may be insured; for under the very severe conditions of a heated room, in winter, with very variable temperatures, it would be futile to aim at precision.

The absolute determination of g is dependent on the value of m . To measure this, large swimmers would be needed, such as would make the apparatus too cumbersome. With regard to small quantities, or small changes of the quantities π , ρ_m , ρ_w , equation (1) may be stripped of its less important terms and written in the approximate form

$$(2) \quad g = \frac{Rm\tau}{MH\rho_m(1/\rho_w - 1/\rho_g)}$$

The corrections are then found by logarithmic differentiation (considering π a correction of H), as follows:

$$(3) \quad dg' = gd\pi/H; dg'' = -gd\rho_m/\rho_m; dg''' = g \frac{d\rho_w}{\rho_w(1 - \rho_w/\rho_g)}$$

Unless the temperature is very variable, this would usually suffice; but it is probably just as easy to construct tables for $d\pi$, ρ_m/ρ_w , and ρ_w/ρ_g and use them directly. If the temperature rises, dg' and dg''' are positive, dg'' negative, and a temperature, say 18° C., may be taken from which to reckon all corrections. In the work below π is always deducted from H .

77. Observations.—The work was begun with cylindrical swimmers, wide-mouthed below, and not constricted as in figure 110, the object being to find the maximum variation in a room of variable temperature, in case of the presence of a porous porcelain cup c , below. Two vessels were selected with apterunances of the dimensions following:

<i>B.</i>	<i>F.</i>
$M = 37.425$ grams	10.939 grams
$\rho_g = 2.47$	2.47
$2r = 3.8$ cm.	3.0 cm.
length = 5.8 cm.	6.7 cm.
$h = 5.0$ cm.	6.0 cm.

The vessel B was about 6 cm. in diameter and 26 cm. high, with a clear space of 12 cm. between the levels c and e . F was about 5 cm. in diameter, with the other dimensions similar. Observations were made at midday, daily, with the exception of the gap after February 18 due to illness. The data were carefully tabulated in detail,* together with the values of g/m computed therefrom by equation (1). All apparatus being near together, the temperature t is about the same in each. The barometer minus the manometer reading is the quantity H in the equation.

Both series of data for g/m are constructed in the B and F graph, figure 112, with the ordinates in ten thousands, in addition to the temperatures t , in the lapse of time.

The results in each case are disappointingly irregular, owing to the inevitable marked variations of the temperature of the room. The work with B (heavy swimmer), extended between February 14 and March 2, shows an average rate of m -loss of 0.75 per cent per day. In view of the irregularity of the curve this may be regarded as identical with the corresponding rate of the earlier experiments in the absence of a porous cup, as will presently appear. It follows, therefore, that the porous cup has had no effect whatever; or that air does not here diffuse appreciably through the porcelain walls as was anticipated. In fact, throughout a large part of the experiment the mouth of the swimmer

* It seemed advisable to remove this bulky table, as much of the essential information is given by the graphs.

(open below) was allowed to rest directly on the porous cup (top above c , figure 110); but no resulting difference appeared. Other conditions clearly prevail, for in this case the mouth of the swimmer is all but closed by the top of the porous cup and yet no marked change of diffusion follows.

To account for this anomalous result, the temperature graph may be consulted. It then appears that the kinks in the B graph closely follow the changes of temperature, if the latter are plotted positively downward. The phenomenon thus seems to be associated with the solubility of air in water. In this way a reason for a degree of ineffectiveness of a wide neck may be also surmised; for, as a result of changes of the volume of the charge of air, the water, more or less laden with air by solution at different temperatures, is alternately expelled from or enters the diver. The mechanism is thus dependent on solution and convection, and only secondarily on diffusion.

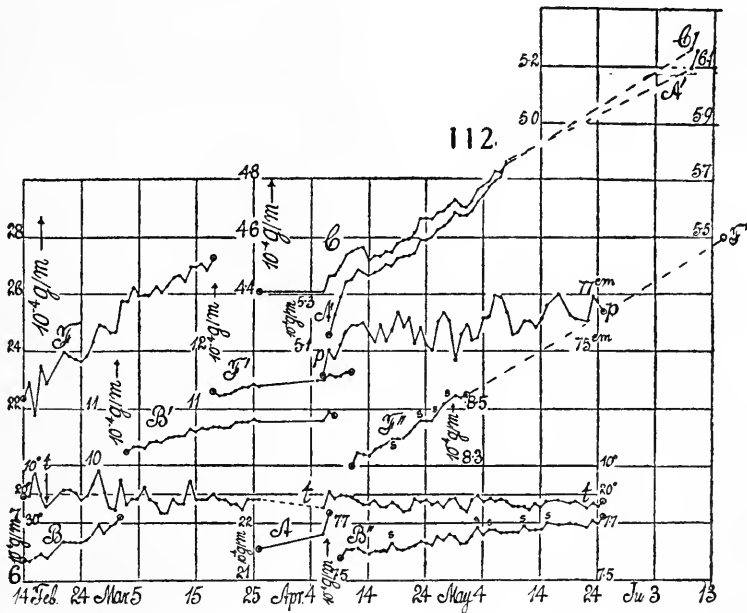

The results for the vessel F , figure 112, in which the diver was much lighter and more mobile, bears out the same surmise even more fully. The relative scale is here somewhat larger and agreement between the temperature fluctuations and the kinks in the F graph more complete. This graph also shows a steady ascent, the mean value of which may be estimated as over 0.80 per cent per day. Here again there is no adequate effect attributable to diffusion of air through the porous cup, which may, therefore, be discarded as useless.

Thus it follows that in the air-air diffusion the solution effect is of predominating importance. Indeed, if the parts of the two graphs between February 25 and February 27 are compared, the g/m increase amounts to 5,600 per day; the corresponding temperature decrease is 4.6 per day. Hence the g/m rise should

be 1,220 per degree per day. The mean g/m rise due to diffusion is but 1,800 per day, but the temperature effect is reversed in heating, so that a steady mean rate appears in the lapse of time. A net solutional g/m discrepancy of 830, per degree, per day, *i. e.*, about 0.3 per cent, must, however, be kept in view.

To carry out the comparison of the present and the earlier results, just referred to, the computation of dm/dt may be made. If the observed datum $g/m = x$, it follows that $dm/dt = (g/x^2)(dx/dt)$, where dx/dt is obtainable graphically. Thus, for vessel *B* the datum is

$$dm/dt = 425 \left(981 / (67000)^2 \right) = 93 \times 10^{-6} \text{ gram/day}$$

In case of vessel *F*, the results during the first 20 days are on the average

$$dm/dt = \left(981 / (241500)^2 \right) 1,850 = 31 \times 10^{-6} \text{ gram/day.}^*$$

The swimmer in case of this vessel was of the same form as that formerly used, when after the lapse of over two months the mean rate $dm/dt = 34.9 \times 10^{-6}$ was computed. In view of the temperature irregularity and relative shortness, of the new graph, the two rates may be considered of the same order. At best the porous cup can not have produced a reduction of rate of more than $4/35$, which is quite inadequate. Again, the ratio of coefficients in *B* and *F* is 3.0. The ratio of areas, about $(3.8)^2 / (3.0)^2 = 1.6$, is thus out of proportion and some other explanation of the excessive rate for *B* will have to be found.

On March 2 the cylindrical swimmer in the *B* apparatus was replaced by a balloon-shaped vessel having the following dimensions:

$$M = 17.869 \text{ grams; diameter of bulb, 4.5 cm.; } h = 4.8 \text{ cm.}$$

The stem was about 4 cm. long and about 2 mm. in internal diameter. It was placed in the same vessel *B*, with the porous cup removed, and the observations begun on March 3 are constructed from the tables in the graph *B'*, figure 112, the ordinates being g/m in ten thousands, as above.

The mean rate of increase of g/m during a period of about 20 days is now smaller, but by no means in proportion with the reduced area and by no means negligible. Taken from the curve graphically, g/m increases about 225 per day or 0.00217 of the initial value per day. Referred to the loss of air, this becomes $dm/dt = 981 \times 225 / (106,000)^2 = 20 \times 10^{-6}$ gram per day. Thus this loss as compared with the preceding case (without tube) is reduced $93 \times 10^{-6} / 20 \times 10^{-6} = 4.7$ times, while the reduction of areas is $(11.5)^2 (0.03)^2$, roughly several hundred times. Hence, even if we leave the length of the neck quite out of consideration, the phenomenon before us can not in its larger aspects be one of diffusion. The gas leaves the diver at a rate which is only secondarily dependent on the length and section of the efflux pipe below and virtually moves more rapidly as this neck is narrower. Furthermore, although the irregularities or temperature effects are now less marked, they can not be

*The rate eventually diminishes and during the month its average value would be about 25×10^{-6} gram per day.

disregarded. Thus, in the curve B' , kinks of the value of $10^3/10^5$, or nearly 1 per cent, due to the solutional effect, are sometimes present, which are temporary errors, even if evanescent.

The apparatus was now left without interference for over 10 days (excepting the changes of room temperature) and then examined on April 6. Curiously enough, the diver B' had lost no air at all, though subsequently losses occur from changes of temperature on succeeding days (see curve B'). Thus it appears clearly that the exhaustion made during observation is one of the chief causes of the loss of air. This unexpected and unfortunate result, so far as the method is concerned, seems to be fatal to any expectation as to its availability for the ultimate purpose in question; but it throws a more definite light on the mechanism of the process than was heretofore obtained. An exhaustion of but 20 cm. of mercury or less increases the effective gradients enormously, so that the air is removed by suction, as it were. Without exhaustion or corresponding interferences (temperature) it is improbable that the rates would conform with the ratio of areas. The same result is obtained in the next experiment.

The diver F , after the close of the above experiments, was also provided with a neck, by closing the wide mouth of the cylinder with a tube 5 cm. long and about 0.5 cm. in diameter. The ratio of mouth-areas available for diffusion is thus $3^2/(0.5)^2 = 36$. This was increased by drawing out the end of the tube. The mass of the new balloon-shaped diver F' was 16.552 grams. The results are given in the graph, figure 112, marked F' . The initial rate of increase of g/m , after a week's observation, may be estimated from the graph as 300 per day; or relatively to the initial charge $300/112000 = 0.0027$ per day, thus of the same order as in the preceding case. The loss of air per day was, therefore, $dm/dt = 981 \times 300 / (113,000)^2 = 23 \times 10^{-6}$, also of the same order as before, though the tube was wider.

Left to itself for 10 days (after March 26) it gives evidence of some air-loss on April 6; but the diminished rate during the interval of quiescence is none the less striking, as the curve F' shows. Here also, therefore, the exhaustion during observation is the chief cause of the observed diminished air charge.

78. Sheathed or inclosed divers.—A number of incidental experiments were made, partly in the endeavor to counteract the convection, partly to test smaller and more mobile divers. It was also thought possible that by removing the free surface of liquid at c , figure 110, the loss of air at this surface would be reduced. The apparatus, AA , thus took the form given in figure 113, where the diver, ab , with open mouth below, is surrounded by the cylindrical vessel EE , closed at the top. Water completely fills AA , except at e and a . The divers were small test-tubes, the dimensions in the two cases being:

No. A' . . $M = 4.426$ grams; diameter 1.5 cm.; length 8 cm.; $h = 6.0$ cm.
 No. C . . $M = 4$ grams; diameter 1.5 cm.; length 8 cm.; $h = 8.0$ cm.

With these light swimmers the adjustment is remarkably precise; but the observed rates are relatively larger because of the small charge.

The first experiments with *A* were made with a larger diver ($M=7.025$ grams, diameter 2.4 cm.); but this proved too sluggish in its motion within the sheath *EE* and it was therefore soon discarded. The results are given graphically in curves *A* (old), *A'* (new), and *C*, figure 112, g/m in ten thousands, as before. *C*, after being installed, was left quiescent for over 10 days. It appears, from the graph *C*, that the loss of air during this interval was almost inappreciable. After resuming the measurements, April 6, a large rate at once establishes itself. Practically the same is true for the diver *A* (fig. 112), though from the viscosity of the sheet of water surrounding the diver the results are rough. Hence it is again shown that the chief cause of the air-losses found is the partial exhaustion made to float the diver during observation.

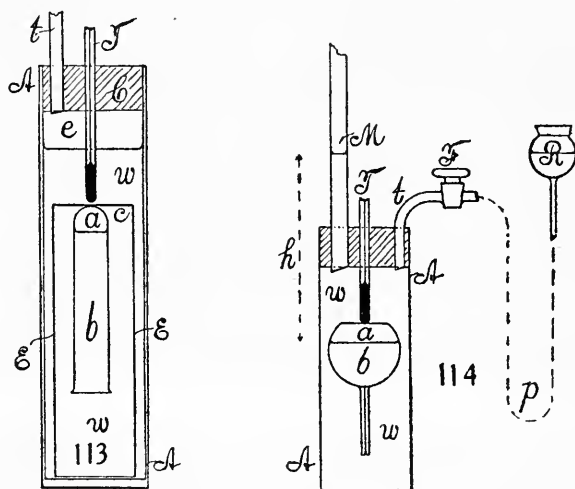

Another interesting result for these sheathed divers is to be noted. In the lapse of time (one or more weeks) it is found that the air escaping from *a* in the diver, figure 113 (which at rest stands on the bottom of the vessel *AA*), at first tends to accumulate at *c* at the top of *EE*. Air-bubbles not originally present show themselves at *c*. In other words, the mechanism is such as to admit of the gradual expenditure of the gravitational energy of low-lying bubbles, so that they eventually reappear, in part at least, at *c*. Later, however, after weeks, these bubbles in turn gradually vanish at *c*. Comments on the reason for this will be found in the earlier report (l. c., § 74).

The initial rates ($r = \frac{d(g/m)/dt}{g/m}$, time in days) of both after April 6 were enormous:

$$A', r = 0.009 \text{ (per day)} \qquad C, r = 0.006$$

After a week the rates of both change through an inflexion in each curve and become

$$A', r = 0.002 \qquad C, r = 0.003$$

The rate of C remains nearly constant, but that of A' increases again to about $r=0.003$.

It is difficult to account for this curious behavior, which is alike in the two similar apparatus. Of these, C had been set up about 10 days before A' . The inference is plausible that some change in the gas (air) inside the diver must have been the cause, but the gas inside, in the two cases, behaves alike. Hence there may have been some change in the air outside. I have therefore inserted the corresponding graph p , fig. 112, showing the barometric pressure in centimeters for the time. It will be noticed that the minima of the A' and C curves coincide with the remarkably low barometer of the same day. The coincidence would be convincing if it recurred at the next exceptionally low barometer about April 28, but this is not the case. Correspondences with the temperature curve are here less evident, though many similarities are apparent. As to availabilities for the g work, the large rates and irregular curves are of course out of the question. Moreover, the rate of change of g/m depends essentially on the area of the mouth of the diver and not on the mass of air contained, so that the meaning of the rates in the present cases is rather involved. The more appropriate datum would be $d(g/m)/dt$.

The divers A' and C were now kept without interference other than temperature for about a month and then reexamined on June 9. Quite contrary to expectations, the loss of air continued without interruption, at about the same mean rate as before, if the loss of air only and not the change of its mass is taken in question. (See fig. 112.) The importance attached in § 77 to the exhaustions in promoting loss is here contraverted by this new evidence, and the above conclusions must therefore be modified, at least for a sheathed diver like the present.

79. The swimmer under pressure.—Inasmuch as the preceding method (in which the air contents of the swimmer were always observed by the aid of exhaustion) have proved to be unavailable, the question arises whether any better results may be obtained if the swimmer is kept permanently under a very slight pressure excess and observed by increased pressures. From the experience gained, the results should be more favorable, since the sponging action of the water is in a measure removed, particularly if very small pressures are used.

The modified apparatus is shown in figure 114, the swimmer being now lighter than water. AA is the stand-glass, wholly filled with water, and ab the (floating) swimmer held down at a definite level by the thermometer T . M is a water manometer for registering the pressure excess at which flotation just occurs at the given level. Pressure is applied by aid of the small water reservoir R , communicating with AA by the tube t with stop-cock F and the flexible pipe p , the whole system $tFpR$ being full of water. To make an observation, R is raised sufficiently and clamped. The cock F is now slightly opened, until the swimmer just begins to sink. The head of water, h , is then read off at M . This adjustment may be made to the fraction of a millimeter of

water. Since the total air-pressure is above 1,000 cm. of water, the accuracy of reading is easily within 5×10^{-5} . But for the secondary disturbances the apparatus would thus be very satisfactory for the purpose, particularly as it admits of observation in an agitated environment.

The two divers selected for these experiments were B' and F' here to be distinguished as B'' and F'' (fig. 112). The same figure contains the temperature changes (t increasing downward) and the graph p of the corresponding barometric pressures in centimeters of mercury.

The case of F'' with a relatively wide tube below (0.5 cm. diameter) as to absolute air-loss per day $d(g/m)/dt$, curiously enough, does not differ much from the cases A' and C (wide-mouthed and sheathed) and is actually much greater than the corresponding rate of F' (examined by exhaustion). The mean value of the relative rate per day, $r = 0.0015$.

The water-head excess here was but 20 or 30 cm., so that at high barometer or low temperature, the diver sank permanently (s in fig. 112). Under these circumstances there is always a peak in the curve, owing to increased effective air-loss. This is the solutional effect of high pressure (gas being absorbed by solution) and the largest rate of F'' compared with F' may also be referred to the same cause; *i. e.*, the greater mean water-head under which the diver is stored. Finally, the diver remained at the bottom persistently, and further systematic observations were temporarily abandoned. On June 15, however, another observation was made, now under a necessarily reduced head, by the exhaustion method. The value of g/m is 91,000, showing that for this diver also the rate of air-loss when the diver is left quite without interference (other than temperature) is as large as during the period of daily observations. The peculiar stationary behavior of the diver as to air-content at the beginning of the above experiments (C, F', A), must therefore be attributed to the composition of the initial charge of air.

The case of B'' with its relatively narrow mouth (tube 0.2 cm. in diameter) shows the smallest rate hitherto obtained. In fact, at the outset the air-losses were negligible; but this is attributable either to the composition of the imprisoned air or to the persistent fall of temperature. The mean relative rate is $r = 0.0003$ per day, only about one-tenth that in most of the preceding cases. The curve is again quite irregular and peaks appear when the diver is sunk (s), particularly when this occurs at low temperature, as is liable to be the case. The present graph contains the most complete series of examinations. I therefore applied the correction for changes of temperature of the water-head (§ 76), this being the only one of significance. The results so obtained, together with the temperature graph, are shown in figure 115 in a doubled scale, g/m being, as before, in ten thousands. It appears that the irregularities of the curve have rather been accentuated. The solutional effect for the sunk diver (s),

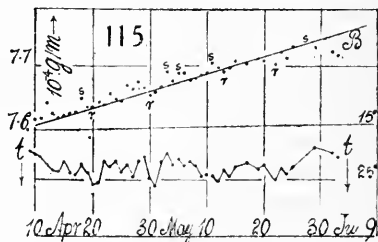

together with its temperature correlative and the valleys r , due to release of air from solution with rising temperature, stand out prominently. Toward the end of May and in June this diver also remained permanently sunk for long intervals. A new departure now presents itself, as the air charge of the diver increases (g/m decreases) relatively fast when sunk. I attribute this to the change of atmospheric air brought about by open windows, together with the low water-head needed to float the diver. In figure 115 the line has been drawn through a succession of points which seem to suggest it. For this $d(g/m)/dt$ would be 30 and $r=0.00039$, somewhat larger than the preceding value. The loss of air here recorded is about 5×10^{-6} gram per day.

80. Stems of small bore.—As a final test on the limitations of the original design, swimmers with stems of finer bore were selected. These were pycnometer flasks of the following dimensions:

	B'''	F'''
Bulb:	Diameter, 4. cm.	Diameter, 4 cm.
Total mass:	$M=15.648$ grams	$M=15.399$ grams
Stem length:	4.8 cm.	4.7 cm.
Internal diameter:	.08 cm.	.08 cm.

They were charged with atmospheric air and adapted for observation under slight pressure excess over the barometric pressure. The stand-glass F''' was rather too narrow, so that this diver did not move with the requisite ease for speedy observation. Moreover, both were too heavy for the highest delicacy, owing to the thickness of the stems. But the bore was very uniform and as the observations were made in a semi-subterranean chamber in the basement of the laboratory, in the summer, *i. e.*, without artificial heat, it was thought that a smoother set of observations might be expected. At least there was an opportunity of separating the effect of temperature from that of atmospheric pressure in its bearing on the solution discrepancy.

The results are given in table 4 and adequately reproduced as to g/m by the graphs in figure 116, in which the upper curve shows the atmospheric pressure the lower curve the temperature. The graphs for g/m (here in thousands) are intermediate, the upper one referring to F''' and the lower to B''' . In the initial observations (before June 30) the micrometric composition of the imprisoned air may come into play, but after the long rest during July and during August, these have been practically eliminated. In general, the observations for F''' and B''' run in parallel and the effects of temperature and pressure, though by no means absent, are more obscure than previously, but of the same nature.

The time loss finally has been decidedly reduced as compared with figure 115 and amounts in the two cases to the following mean values:

$$F''': d(g/m)/dt = 9.5 \text{ per day}; r = d(\log(g/m))/dt = 10^{-6} \times 10.8$$

$$B''': \quad \quad \quad = 6.2 \text{ per day}; \quad \quad \quad = 10^{-6} \times 7.2$$

Apart from the kinks in the curves, the loss coefficient is not, it would seem, altogether too large for the purposes in question, for it can be applied as a time

correction; and it is probably not all that a region of fairly constant temperature (thermostat) is able to warrant. At the individual observations or kinks, the irregularity still exceeds 0.1 per cent and there has not been much advance in precision.

TABLE 4.—Behavior of divers B''' and F''' , inverted pycnometers. $M_B = 15.648$ grams; $M_F = 16.399$ grams; $h_B = 12$ cm; $h_F = -9.1$ cm.

Date.	B'''				F'''			
	Barom.	Water-head <i>w.</i>	Temp.	<i>g/m</i>	Water-head <i>w.</i>	Temp.	<i>g/m</i>	F''
	<i>cm.</i>	<i>cm.</i>			<i>cm.</i>			
June 20	76.63	14.6	16.7°	86140	10.9	16.6	87820	
21	75.66	28.2	16.4	86000	24.0	16.4	87760	
22	.62	34.6	17.5	85960	30.8	17.5	87660	
23	76.22	30.0	18.5	86040	25.2	18.4	87820	
24	.50	30.7	19.4	86050	25.4	19.2	87820	
25	.43	33.2	19.6	86020	28.9	19.5	87720	
26	.65	33.6	20.4	86080	29.2	20.2	87760	
27	.96	33.3	21.1	86040	29.1	21.1	87810	
28	.35	43.4	21.4	86010	39.1	21.3	87740	
29	75.96	50.9	21.5	85890	46.4	21.5	87660	
30	.61	52.8	21.0	85910	48.0	20.9	87650	
July 1	.70	57.1	22.0	85860	52.6	22.0	87630	
Aug. 4	76.86	42.0	22.8	86160	37.1	22.6	87860	
6	.71	40.0	22.0	86340	34.6	21.9	87940	
7	.36	47.0	22.3	86100	41.3	22.2	87920	
8	.40	49.8	23.0	86120	45.1	23.0	87920	
9	.53	50.5	23.4	86100	45.8	23.5	87920	
10	.28	56.7	23.8	86040	51.6	23.7	87820	
26	76.93	35.2	21.8	86200	29.9	21.8	88040	
27	.85	38.4	22.2	86200	33.3	22.3	88080	
28	.55	46.5	23.0	86240	41.4	23.0	88060	
29	.38	48.3	22.8	86180	42.8	22.7	87980	
31	75.54	62.4	23.2	86140	57.0	23.1	87920	
Sept. 1	.40	60.5	22.6	86180	55.2	22.5	87980	
2	76.15	43.3	21.5	86300	38.3	21.6	88150	
6	.40	36.0	20.9	86360	30.1	21.0	88300	
8	.91	47.9	21.9	86350	42.9	21.9	88210	
9	.33	43.7	22.3	86390	40.4	22.5	88170	

However, one possible improvement is yet available, and that consists in diminishing the area of contact (a and b , fig. 114) between the air and water, within the diver. Such alteration would diminish the opportunity for solution and consequent transportation. The probability of a material advantage to be gained in this way is sustained by the data of the next paragraph, in which a diffusion or solutational coefficient is nearly eliminated.

81. The diffusion of air through water in the lapse of years.—In 1912, I put up a U-tube of the form shown in figure 117, containing a charge of water $w w'$ below the air-chambers a, a' , both at nearly atmospheric pressure. The tubes were sealed by fusion cautiously to avoid the presence of flame gases in aa' . They were then put away in a dark vault of nearly constant temperature (for short-time ranges) to be examined from time to time as to the displacement

of the thread of water within; for it will be seen that the meniscus under a' is at a pressure excess of $h\rho g$ as compared with the meniscus under a . If L is the total length of the thread of liquid in the tube, we may define the coefficient (κ) of diffusion (by volume) by the equation

$$v = \kappa at(h\rho g) / L$$

where v is the volume diffusing at nearly constant mean pressure in the time t through an area a , the density of liquid being $\rho = 1$. Hence

$$\kappa = \frac{v L}{at h\rho g} = \frac{1}{2} \frac{dh}{dt} \frac{L}{h\rho g}$$

where dh/dt is the loss of head per second. The factor $\frac{1}{2}$ appears, since the volume lost at a' appears at a , and their sum is equivalent to the loss of head. The amount of diffusion is so small that corrections may be disregarded.

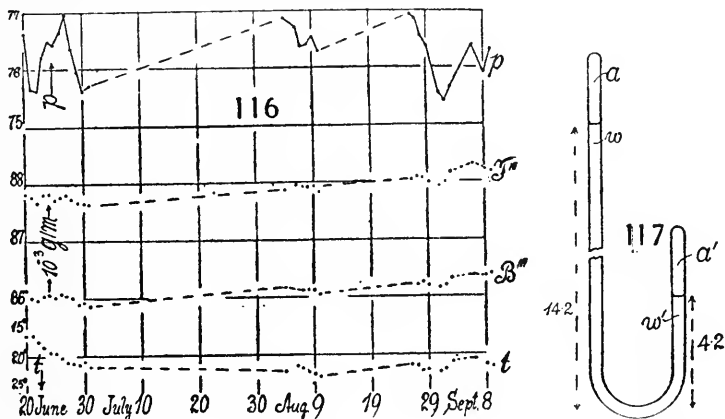

The observations made before the spring of 1914 were not satisfactory because of deficiencies of method. They were, therefore, discarded. Measurement was thereafter made with the cathetometer. The following table gives the essential data for the interval of 6 years 9 months and 6 days, with the increment from leap years:

No.	L.	Diam. inside.	Area.	Date.	$t \times 10^8$	h	$10^9 \frac{dh}{dt}$	$10^{12} \kappa$
I	20.0 cm.	0.55 cm.	0.24 cm. ² .	{ 1914-3-20 1920-12-26 }	2.14	{ 10.12 cm. 9.89 }	1.07	1.10
II	15.7	0.82	0.53	{ 1914-3-20 1920-12-26 }	2.14	{ 7.54 7.22 }	1.73	1.87

The two values of κ found are of the same order, but the one for tube II is definitely larger than the one for tube I. This may be due to infinitesimal difference in the separated gases (a, a') of the tubes. Since the tube II has a shorter (L) and wider column, and a meniscus nearer the bend, it is more probable that thermal correction is the cause of the difference, for the inside sectional area of II is about 2.2 times larger than I. The data obtained for κ with a cylindrical Cartesian diver* about 3 cm. in diameter,

*Carnegie Inst. Wash. Pub. 186, p. 21, 1913.

of 7.05 cm.^2 in area, are enormously larger than the above reading, $\kappa = 90 \times 10^{-12}$. The result is in keeping with the enormously larger area at the surface of separation of air and water in the diver and consequent effectiveness of the solution-temperature mechanism which I have described in the preceding paragraphs. Whether in case of tube *I* a condition of true diffusion has been reached will have to be ascertained in the lapse of further years. Meanwhile, the question whether a long, slender Cartesian diver may not obviate the discrepancies hitherto encountered is worth consideration.

CHAPTER X.

GRAVITATIONAL EXPERIMENTS, CHIEFLY WITH REFERENCE TO THE ACCOMPANYING RADIANT FORCES.

82. Introductory.—In the course of the work of the last report, I came to the conclusion that it would be worth while to study the motion of the gravitating needle subjected to alternating forces, in air, before beginning the more difficult experiments in vacuo, which follow. The following paragraphs and figures contain examples of investigations made with this end in view. These results are very interesting, even if considered as evidence of the pervasive character of thermal radiation. The profound effect produced by thermal variations scarcely exceeding a degree per day is astonishing. One is tempted to ask whether some other type of radiation is not intermixed with the thermal effect.*

83. Apparatus.—The apparatus was not materially changed from that heretofore used. The needle consisted of two lead shots, each weighing 0.59 gram, held at the ends of a shaft of straw 22 cm. long, the latter being retained in favor of the radiations in question. The latter with appurtenances (mirror, etc.) weighed 0.58 gram, about the same as either shot, while the straw shaft alone weighed but 0.28 gram. The whole was supported by a quartz fiber 40 cm. long, attached to a torsion-head above, and inclosed by a glass tube as far as the needle.

The quartz fiber and glass tube and the needle were additionally protected by a flat case made up of two parallel plates of glass, separated on each vertical side by a strip of wood 1.5 cm. thick. These wooden strips projected beyond the glass plates above and were provided with two cylindrical iron holders (gas-pipe nipples) by which they were attached with clamps to the pier, independently. The waste space above the needle was filled with sheets of cotton batting. The bottom of the case was closed with a similar strip of wood covered with cloth and was held in place by friction.

The attracting weight, $M = 949$ grams, moved on a crank supported by separate attachments anchored in the same pier. Stops were placed so that M could be quickly rotated from one side of the shot to the other, the distance between centers being on either side $R = 4.24$ cm.

The deflections of the needle were read off by a mirror and scale method, taking advantage of the half-silver plate device, described in the last report. As the telescope is at half the usual distance, the magnification is doubled. The centimeter scale, illuminated by a horizontal tungsten lamp behind it, was at a distance of 378 cm. from the mirror on the gravitating needle. Hence the angles are

*Mr. Boys has recently given an interesting review of this subject in *Nature*, p. 46, Sept. 8, 1921.

$$\theta = \frac{I}{2 \times 378} = 0.001323y \text{ radian}$$

and the displacement, x , of either end of the needle, therefore, if y is the corresponding scale reading in the telescope,

$$x = 11 \times 0.001323y = 0.01455y \text{ cm.}$$

All the work was done in the semi-subterranean basement of the laboratory and in the dark, except for the light which came through a ground-glass screen from the lamp at the scale. The room was so damp that electric charges are out of the question. The thermostat indicated temperature changes rarely exceeding a degree per day.

84. Long-period observations.—A number of early readings, taken at intervals of about half an hour with the weight M alternately on opposite sides of the needle, are shown in figure 118. There is some drift, and if the observations be distributed in triplets, the successive double amplitudes Δy (marked on the curve) make a decreasing series. The mean is $\Delta y = 5.4$. From these, the actual double amplitude of the shot may be computed for each case, the mean value being $\Delta x = 0.0786$ cm. This is about half the value obtained with the former quartz fiber, but it suffices. The reason for the irregularities and variations of figure 118 is at the outset hard to ascertain, even if the needle is never quite at rest. The shot, in other words, undergo something that is analogous to the Brownian motion of motes or very small bodies, except that the cause here may be surmised to be referable to temperature differences and convection currents (dynamic pressure reductions) in the surrounding air; but one is at first very far from understanding all these vagaries

As the apparatus was arranged, the observer sat in a neutral position (plane of the needle) within about an average meter from the needle-case and controlled the attracting weight M manually. It is possible that control from a remote distance would be preferable, but I did not at first think so. Later I worked from a distance only; but the results were no better.

Some time after, the apparatus was taken apart for the determination of the torsion coefficient t of the filament. For this purpose a little vertical brass cylinder was suspended from the wire. If T is the period and K the moment of inertia of the cylinder oscillating about its axis,

$$(1) \quad T = 2\pi\sqrt{K/t}$$

The cylinder weighing 1.768 grams and being 0.4735 cm. in diameter has for its moment of inertia $K = 0.0495$. The period T of this system was almost exactly $T = 6$ seconds. Hence if the semi-length of the needle is $r = 11$ cm., the two shots at its end each 0.59 gram, and the mass of the straw shaft 0.58 gram, the moment of inertia of the needle is 190. Thus the period of the needle should be (apart from damping) $T = 37$ seconds or 6.2

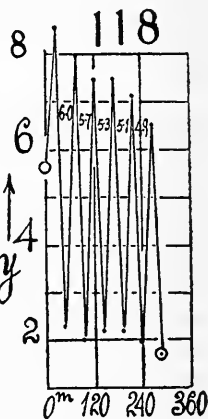

minutes. With the air-damping the period is increased to something like 20 minutes or 30 minutes, so that it practically creeps.

Instead of using the torsion coefficient t of the filament, it is more convenient to introduce the linear modulus a , so that the force is $f=ax$. If the semi-length of the needle is r , it is obvious that

$$(2) \quad t = ar^2$$

We may now employ the equation for the attracting force f , in terms of the masses M and m and their distance apart $R = 4.24$ cm., Δx being the observed double amplitude of static displacement. Thus

$$f = \gamma \frac{Mm}{R^2} = a \frac{\Delta x}{2}$$

whence

$$(3) \quad \gamma = \frac{a}{2} \frac{R^2}{Mm} \Delta x$$

no attention being, for the present purposes, given to the attraction of the mass M for the straw shaft $2r$, weighing 0.28 gram, but remote. If we introduce equation (1), equation (3) becomes finally

$$(4) \quad \gamma = \frac{4\pi^2 K}{2T^2 r^2} \frac{R^2}{Mm} \Delta x = C \Delta x$$

If we insert the data specified,

$$\gamma = \frac{2\pi^2 \times 0.0495}{(6)^2 \times 11^2} \frac{(4.24)^2}{949 \times 0.59} 0.0786 = 5.7 \times 10^{-8}$$

This value is below the standard value and needs further correction. To apply such corrections now would be idle; for it is first obviously necessary to learn to control the enormously variable excursions of the needle Δy . The subject will be resumed presently. Since

$$(5) \quad a = \frac{t}{r^2} = \frac{4\pi^2 K}{r^2 T^2}$$

the above data give $a = 10^{-5} \times 4.49$ and the torsion coefficient $t = ar^2 = 10^{-3} \times 5.43$.

The large early double amplitudes Δy as compared with later values, induced me to make a series of observations throughout a number of successive weeks, in half-hour periods. Before doing this, however, it was thought safer to actually cement the hooks of the quartz fiber to the torsion-head above and to the needle below. This was done at a slight sacrifice of the end of the fiber by accident, so that the coefficient a is a little larger than above. These observations are shown in figures 119, 120, beginning on July 17. They do not differ as a whole from the older data, with a needle hooked into sharp triangles, with which they were compared.

85. Long-period observations in the lapse of time.—These are given in scale readings γ in figures 119, 120, etc. The actual displacement of the shot m is $x = 0.01455\gamma$. The attracting mass M is placed on one side or the other of m ,

for a half hour or more. The observations usually began at about 10 a. m. and were finished after 6 p. m.; it is thus convenient to distinguish a.m. and p.m. excursions, as will be done presently. The date of each group is marked on the graph.

The first feature of the results is the gradual drift into larger figures, but this may be incidental. For the present it is of no interest, as it would have to be interpreted in the future and does not affect the triplets.

The next feature is the enormous variability of the excursions. These are given for a. m. and p. m. times in figure 121, at first including the mean values.

The needle of the apparatus pointed north-south; consequently the weights M took position east-west of the shot. On the west side was the large central pier in the middle of the laboratory to which the case of the apparatus was attached. On the west side, at a distance of 4.5 meters, was the heavy base-ment wall of the laboratory, 2.5 feet thick, and this was illuminated on the outside in the morning only, by the sun if shining. When M is on the east, the

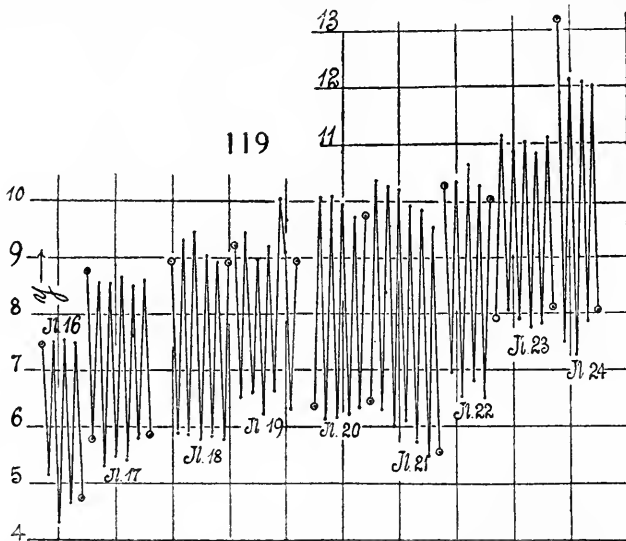

deflections recorded are toward large numbers. One notes the generally greater variability of the top readings as compared with those at the bottom (M west). This is particularly marked during the hot weather near the end of July.

A second apparatus (No. II, below) was afterward placed on the east-west wall of the pier, the needle pointing in that direction, and the variability, though still very marked, was less excessive.

It is thus clear that in figures 119, 120, we are confronting a pervasive temperature or radiation effect. To ascertain the extent of this, figure 121 may be consulted, as it exhibits the mean excursions Δy , a. m., p. m., and their means for the successive dates. On the cooler days there is little difference in the a. m. and p. m. readings, and these were therefore at first

embodied in the mean; but on the hot days the difference is enormous. One may note that the longest excursion exceeds 7 scale-parts; the smallest is below 2 scale-parts.

To compare these with the interior temperatures of the laboratory would be without avail, for the thermostat data do not vary as much as 1° per day, as a rule. Moreover, these air-temperatures are mean data with no direct bearing, whereas the weight M reciprocates directly, in radiation, with the walls of the room. Hence the external or atmospheric mean temperatures are pertinent. They were kindly furnished by Charles S. Wood, meteorologist of the U. S. Weather Bureau Station in Providence, Rhode Island. These mean temperatures for the day are inserted in the top of figure 121, in degrees Fahrenheit. The numbers attached show the rainfall in inches. A scale twice the one taken would have facilitated comparison.

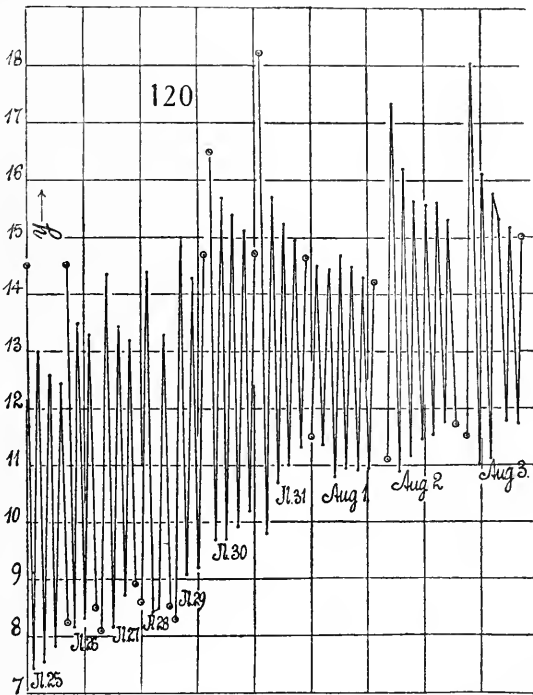

Mere inspection of the two curves for July shows them to be identical in character of variation, except that the lower curve follows the upper with a lag of one to three days. In the region *a* there are two maxima differently developed; also in the region *b*. The cooling effect of high precipitation is marked in both. All this is in some respects what would be expected, as it takes any external isotherm a day or more to penetrate the 30 inches of wall thickness in order to enter into reciprocal radiation exchange with the ball M .

It is a little surprising, however, that the high temperatures are distinguished from the low temperatures in figure 121 by such large a. m. and p. m. dif-

ferences. There are other details to be left for solution to the future, which remain obscure. The ball M acts more effectively than the pier because the former is nearer the mass m . Nevertheless one is at liberty to preserve an open mind in suspecting that, associated with the thermal radiation, some other form of radiation may be entering. These surmises, however vague, will be again suggested by much of the work below, with apparatus *II*.

Curves for daily *changes* of temperature $\Delta\theta$, sunshine, etc., were also tested, but with no agreement superior to the above. This is the particularly puzzling feature; for it seems as if the absolute atmospheric temperatures and not their daily variations were effective; for otherwise there is no more reason why the Δy should not approach a given mean value at low temperatures as well as high temperatures. In the July observations so far as taken, however, Δy is low at low atmospheric temperatures and high at high temperatures.

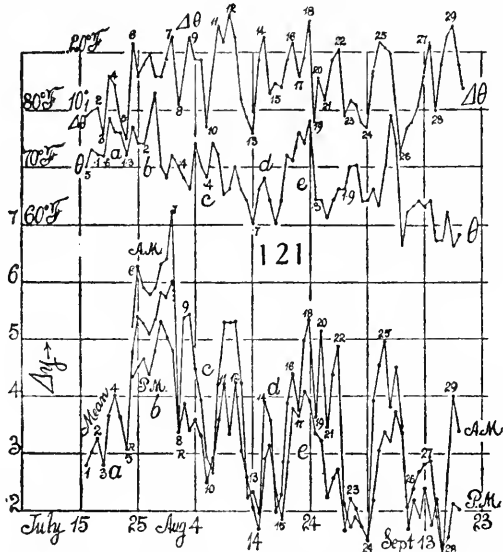

The results for August, in figure 121, follow in their a. m. and p. m. values only, as this makes for greater clearness. The two curves differ as to details, remembering that the a. m. curves are subject to the sunlight which strikes the outside of the east wall. They are larger as a rule and the curves cross but rarely. Each a. m. excursion reappears in subdued form in the p. m. results.

If we again make the comparison with atmospheric temperature, conclusions similar to those already made may be drawn. Thus, the region *c* is characterized by two maxima, the region *d* by two minima, and the indentations of the high region *c* may be followed until they are modified by the copious warm rain. Finally, as the temperature data are means for 24 hours, while the values of Δy are obtained from observations between 10 a. m. and 6 p. m., complete correspondence would be impossible.

In August, however, considerably greater correspondence with the curve of daily temperature changes ($\Delta\theta$) may be detected. Though there is no im-

mediate quantitative agreement, the indentations of the Δy and $\Delta \theta$ curves show a close agreement in sequence and less occurrence of lag. This brings the ultimate interpretation nearer at hand. The evidence is in fact very striking, and to indicate it more forcibly I have numbered the successive temperature cusps on $\Delta \theta$ 1 to 29, in order to coordinate them with the corresponding similarly numbered cusps on the Δy curves.

86. Short-period observations.—It is to this subject that the present paper is to be mainly devoted, with the object of discerning whether the balls on the needle may not be treated as in uniform or ultimately in uniformly varied motion. It will, therefore be convenient to compute the Newtonian constant on simple principles throughout, but *merely* as a criterion of the degree to which the condition specified has been realized.

With these reservations we may, therefore, in first place ignore the friction coefficient of the medium (air) and the elastic coefficient of the fiber; moreover, at the outset, disregard the attraction of the mass M for the straw shaft, a correction which can afterwards be applied. Under these circumstances the double amplitude Δx of either ball may be written $\Delta x = g't^2/2$, where g' is the effective acceleration and t the period of the alternating attraction, the latter regarded constant and consecutively positive and negative. Under the limitations stated, the attracting force is $f = \gamma Mm/R^2$ and the mass actuated $2m$. Hence $g' = \frac{\gamma M}{2R^2}$, whence

$$\gamma = 4R^2 \Delta x / Mt^2$$

But in § 83, $x = 0.01455 y$, where y is the displacement reading on the centimeter scale in the telescope. If for short alternations of the period t , Δy is the double amplitude observed in the telescope,

$$\gamma = \frac{4R^2 \cdot 0.01455 \Delta y}{Mt^2}$$

Hence, if we put $R = 4.24$ cm., $M = 949$ grams, then

$$\gamma = 10^{-4} \times 11.0 \Delta y / t^2$$

or, if we express t in minutes, as observed,

$$\gamma = 10^{-8} 30.6 (\Delta y / t^2)$$

Thus it is merely necessary to divide the double telescopic amplitude by the square of the time in minutes, apart from the constant. This would be very easy if the motion of the needle were not at times cobwebby, so much so that I have frequently passed a wire around it, inside the case, several times to insure myself of its freedom.

In figures 122 and 123 I have given the data (scale readings successive minutes apart) obtained on July 5 for one-minute and two-minute periods in the switch-over of M . The turning-times of M are indicated by little circles. Since the needle is invariably drifting, it is necessary to compute the

double amplitudes from triplets. This has been done, and the value of Δy is inscribed in each of the consecutive zigzags of reasonable shape. The mean values are

Series 1	$t = 1^m$	$\Delta y = 0.162$	$10^3 / \Delta x = 2.36$	$10^8 \gamma = 5.0$
2	2^m	0.600	8.73	4.6

The apparent value of γ in each case is but little more than two-thirds of the standard value and the deficiency must be ascribed to the coefficient of friction neglected. It is interesting, however, to note that relatively equation (1) is roughly corroborated, the displacement Δx being (here) 4 times as large in two minutes as in one minute, though the motion itself is far from uniformly accelerated.

In figure 122 the needle moves, as it were, without inertia and the phase difference ($\Delta\phi$) relative to the forces is therefore 90° , but the period is too short for much discrimination, particularly in view of the drift. In figure 123, however, the same anomalous condition reappears and, what is more striking, is the retarded motion between the turning-points. For this is of the nature of a lag, or indicates an apparently waning gravitational effect, or rather the growth of some repulsive force.

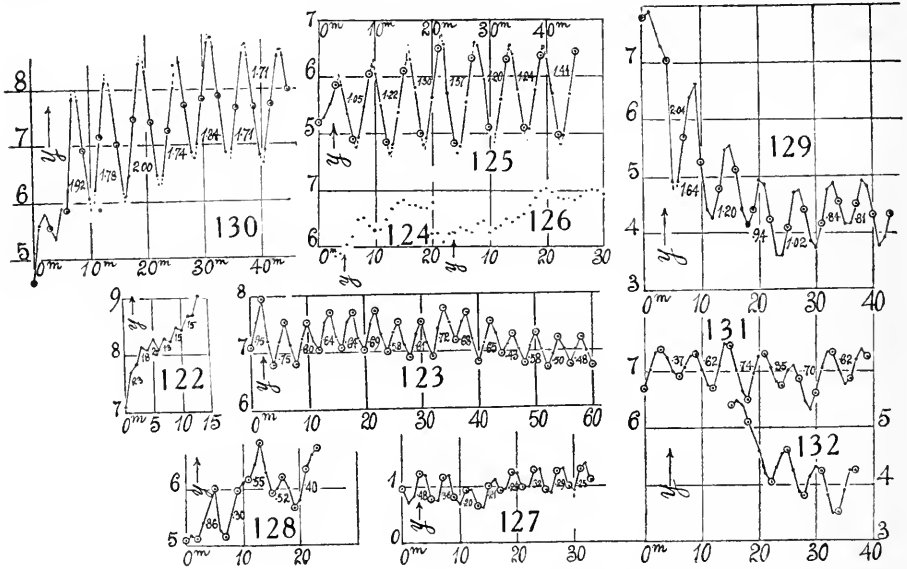

On July 7, I made another series of observations given in figures 124 to 127 for one, two, and three minute periods. Figures 124 and 126 made before and after figure 125 and for one-minute periods show no gravitational effect, but a mere drift with several induplications. At least, if triplets were constructed, they would have a value not exceeding $\Delta x = 0.0007$ centimeter about one-twelfth the value in figure 122. During the first minute gravity shows no appreciable preponderance. During the ensuing one and two minutes, *i. e.*, for

two and three minute periods, the results in figures 125 and 127 become very definite, as shown in the zigzags of the curves. The mean results would be

Series 4	$t=3^m$	$\Delta y=1.29$	$10^3 \Delta x=18.77$	$10^8 \gamma=4.4$
6	2^m	0.30	4.36	2.4

The former series (4) is still consistent with the preceding, showing that Δx increased as t^2 . The graph, moreover, is such as we should expect, the needle being carried by its inertia after the turning-time of the force. In figure 127, however, the inertia retardations are just as large and the effect of this is to depress the double amplitude and therewith the γ value to one-half that in series 2. It is probable, therefore, that the inaction during the first minute, present to the same degree in series 3 to 6, or figures 124 to 127, needs some other explanation, being referable to some peculiar repulsion, the nature of which is to be ascertained. It is interesting to note in passing that if in figure 125 the displacement between maximum elongations had been taken, the mean value would be $\Delta y=2.0$, so that $\gamma=10^{-8} \times 6.8$ would be the result. This, however, is merely accidental.

On July 8 five series of experiments were made. The one-minute periods failed, but the motion during the two-minute periods, one of which is shown in the chart, figure 128, proceeded without apparent inertia. In series 11 (two-minute periods) the drift was excessive. The results were

Series 8	$t=2^m$	$\Delta y=0.58$	$10^3 \Delta x=8.4$	$10^8 \gamma=4.4$
9	2	.53	7.7	4.0
10	2	.55	7.9	4.2
11	2	.53	7.7	4.0

The experiments made on July 9 and 10 finally exhibit a new state of affairs, for here the needle is frequently in the same phase with the alternating force, so that the motion of the needle changes sign midway between the turning-times of the weight. I give two examples of these curious results in figures 129 and 130. In the former the general drift is very large and downward; in the latter about as large, but upward. The value of the triplets is shown in the indentations as before. The results were

Series 15	$t=3^m$	$\Delta y=0.96$	$10^3 \Delta x=14$	$10^8 \gamma=3$
17	3	1.81	26	6
19	3	0.57	8	2
20	3	0.72	11	2

In figures 129 and 130 the oscillating motion of the needle is quite without apparent inertia and the turning-points of the needle are such as to indicate some periodic repelling force counteracting the gravitational attraction. In order to get any data from these curves, the double amplitude of the needle must be taken between the elongations, though their meaning then becomes obscure. As compared with these figures, the phase conditions in figures 131 and 132 are again totally changed; for here the unknown repulsions operate appreciably just before the attracting weight is turned.

It is astonishing that results such as these should be obtainable with a simple, carefully constructed apparatus, in a dark, damp, half subterranean

room, of practically constant temperature. In any given series, for instance, the behavior is consistent. The repulsive force retains its relations relative to the gravitational attraction, changes sign with it in a consistently different phase, in each of the series of results. If there were any approach to resonance between the period of the alternating force and the needle, an explanation of the results might be attempted; but the semi-period of the needle may be estimated at 10 or 20 minutes. It is aperiodic, practically creeping.

87. Further observations.—The needle was now dismantled and the observations of § 84 on the elastic coefficient of the needle were concluded. After it had been put together again with improvements, and readjusted, the observations of figures 133, 134, 135, one and two minute periods, were then taken. The observer throughout kept at a distance from the apparatus except at the time of reading the telescope. It will be seen that the observations for one-minute periods again fail in the usual way. For the three-minute periods the results are normal, as the needle swings with apparent inertia after turning

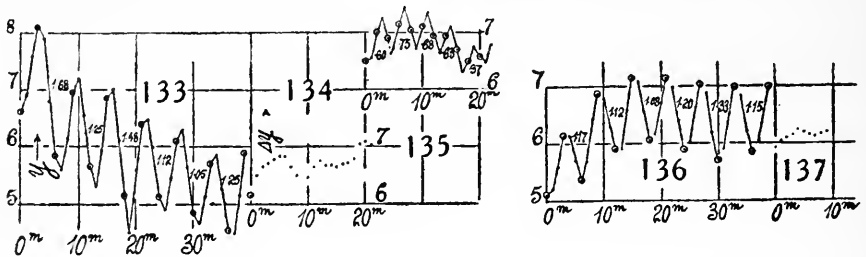

the attracting weight M . The observations (fig. 135) for two-minute periods are also normal in this respect; but it is necessary to reckon from observations midway between the turning-points if triplets are to be available. The data are:

Series 21	$t = 3^m$	$\Delta y = 1.30$	$10^3 \Delta x = 18.9$	$10^8 \gamma = 4.4$
23	2^m	.61	8.9	4.6

about of the same order as above. The displacements Δx are again roughly in the ratio of 9:4. But the new results are no improvement on the old.

As a final condition of safety the hooks of the quartz fiber were additionally secured with sealing-wax to the torsion-head above and the needle below, so that the system throughout was free from any loose parts or movable joints. Results so obtained for three-minute and one-minute periods are given in figures 136 and 137. The latter again completely fail. The former are not essentially different or better than the above. The fiber was a little shortened by accident. The value of the successive triplets is given on the curve. Their mean value is

Series 24	$t = 3^m$	$\Delta y = 1.17 \text{ cm.}$	$10^3 \Delta x = 1.7 \text{ cm.}$
-----------	-----------	-------------------------------	-----------------------------------

What is particularly noticeable in figure 136 is the uniform motion within the branches of the zigzag.

From the data as a whole we may conclude that, in addition to gravitation, some other force is present, attractive or repulsive, and in any given experiment

always in a consistent phase-difference relative to the alternating gravitational force. In other words, the discrepant force develops in an orderly manner after the weight M is turned. Furthermore, there is in most of the graphs a marked tendency toward uniform motion of the needle between the turning-points or their equivalents. We may thus explain the ratio of total excursions 1:4:9, for one, two, and three minute periods, more consistently with the observations as follows: In the first minute after turning there is a mere accommodation of force conditions. Hence the one-minute periods nearly always fail to show interpretable results. In the two-minute and three-minute periods the excursion times have thus been only 2-1 minutes and 3-1 minutes, the latter twice the former. The approximate ratios 4:9 are thus more probably to be taken for 1:2 or the mere total excursions to be expected from uniform motion.

Furthermore, if there is uniform motion, the gravitational attraction is counterbalanced by frictional resistance and the latter may be taken as proportional to the speed of the needle. These rates of motion must therefore be looked upon as of much greater interest than the value of the triplets as computed above. Moreover, if there is marked drift the value of the triplets will be correspondingly changed, for the force in action is large as compared with gravitation.

88. New apparatus.—Another needle, of the same kind as above, was now installed in a smaller case, capable of exhaustion and useful for other experimental work. This consisted (fig. 138 elevation, fig. 139 plan) of a hollow rectangle w of waxed wood, 1.8 cm. thick, to which glass plates g were attached, soft sealing-wax having been melted around their edges, reinforced by steel clips. The needle with the two shots at m, m' , 0.56 gram each, and a light mirror at n , was supported by the quartz fiber q , from a torsion-head above, carried by the glass tube t . The whole was rendered airtight by melting soft wax into all crevices and joints. The hooks of the quartz fiber were also cemented together, so that there was nothing loose. The needle was put in place with one of the glass plates off. This was then fastened as stated. It could again be removed by melting the wax at the edges.

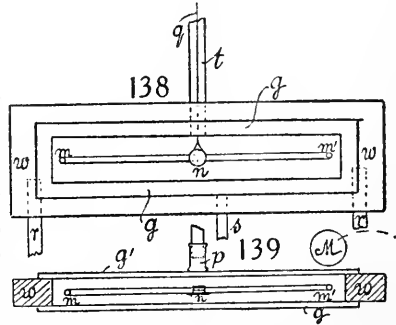

The case was fastened nearly vertically, by aid of the brass rods r, r' , held in clamps anchored in the pier. The final leveling and freeing of the needle was accomplished by a screw-pusher p abutting in the pier. The tube t was also held in a clamp from the pier, to prevent excessive tremor.

The attracting weight M had a separate mounting on the same pier, and by a crank-like mechanism could be smoothly and easily passed between adjustable stops, from M to M' . The observations were made in the same dark,

damp, semi-subterranean room, as in the former case, and the two instruments were not very far apart.

It was necessary to put the scale and telescope somewhat nearer (265 meters) to the mirror *n*, than before. The new instrument is thus apparently, though not really, less sensitive than the other. As the scale-parts are given in centimeters, the displacement of shot will be

$$\Delta x = \left(11.35 / (2 \times 265) \right) \Delta y = 0.02142 \Delta y \text{ cm.}$$

the needle being 22.7 cm. (between centers) long.

89. Trial observations. Radiation effect.—On testing the apparatus roughly with a brass kilo, it was noticed that the first excursions were always abnormally large. In the course of the day these died off to values scarcely one-tenth of the original. An attracting ball of lead *M*, weighing $M = 1,602$ grams and capable of approaching the shot to $R = 5$ cm., was then installed. Here again the first triplet (14) obtained was enormous (19.2, 1.4, 10.6 scale-parts), but it gradually diminished and on the next day the excursions were steadily of normal value (about 3). It seemed probable, therefore, that an extremely subtle radiation effect was here in action. To test this, the lead ball *M* was removed and just exposed to a few passes of the Bunsen burner, so as to be warm to the touch. On being replaced, the alternations (in approximately

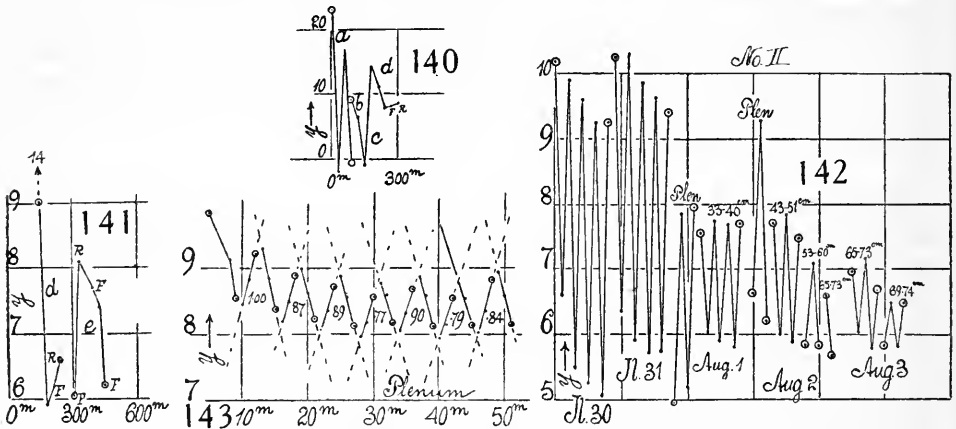

half-hour periods) obtained (fig. 140 a, scale one-tenth of the preceding) were enormous, the first excursion being up to the wall of the case. They gradually decreased, as the figure shows, but the effect was still very great, the initial triplets (within the first hour) being 22 and 18, or 6 or 7 times as large as the normal gravitational effect and of the same sign throughout. The remarkable feature of this is the *long* time needed for the effect to pass off; for, after more than an hour, the ball *M* was again quite cold on the touch, but its radiation activity was nevertheless still pronounced.

The next day the same ball, whose natural excursion was but 2.5 (fig. 140b), was merely warmed by the hand (fig. 140 c). The result is an excursion of

15, or 6 times the normal value. The ball was next cooled slightly by submerging it in tap-water, with the results of figures 140 *d* and 141 *d* (enlarged). There is a drop of $\gamma = 3$ s. p. It was now again submerged, dried, and replaced, with the result of a further drop in deflection of 3.1. On alternating the position of *M* from the front (*F*) to the rear (*R*), the effect of gravity was found to be just exceeded by the repulsive radiant force from the cooled ball; for the *F* deflections are normally the larger.

Finally, the case itself was covered (except at the mirror) with a thin sheet of metal closely fitting it, and the effects of alternating the position of *M* were tested through this metallic sheath, with the results of figure 141 *e*. The excursions of the needle are not only large and irregular, but on the whole a reversal of the gravitational effect. Hence the metallic sheath was again discarded as introducing unnecessary complications and affording no advantages.

But after long repose (days), the new apparatus functioned quite as well as the old. This may be seen both in figure 142 and others below, or in the three-minute alternation in figure 143. There is little drift and the mean value of the triplets as indicated on the curve is $\Delta\gamma = 0.866$, somewhat smaller than in the old apparatus, where *M* is nearer *m*.

It is natural to refer the radiation effect to the reduction of pressure into the energy of motion. The convection between the shot *m* and heated ball *M* may be regarded as in excess of that on the other side of the shot, and hence a larger amount of the former pressure is changed to kinetic energy. This would similarly account for the observed reversal in case of a cold ball. There is thus a peculiar radiometer effect in a plenum of air, tending to vanish on exhaustion, to which further attention is given in the next paragraph.

90. Radiation effect observed on exhaustion.—The effect of exhausting the case in small steps of 10 cm., slowly, is to cool the air contained. Hence the result should be like that produced by a hot body on the outside, provided the needle is not quite symmetrically placed with respect to the glass windows of the case and provided the needle end on the side of the hot body is also the nearer. The needle in the present experiments was, accidentally, so hung. Apart from this, the present experiments have nothing to do with the outside environment, if it does not change. They are then merely concerned with the interaction of the needle and the case when the air within is successively and slowly exhausted. In the experiments summarized by figure 144 *a*, the needle was at rest at 10.7 scale-parts. Exhaustions were then made from 0 to 30 cm. (lost), 30 to 40 cm., 40 to 50 cm., etc., finally 70 to 74 cm.; the curve shows the effect produced. After every exhaustion the needle was allowed to return to its zero-point (10.7, see arrows) nearly. The result is very interesting, for the effect of exhaustion changes sign after about 60 or 70 cm. of pressure have been removed. If the effect was like an attraction before, it is like a repulsion after. The curve *b*, with a somewhat lower zero-point (9.2), shows the same effect for somewhat irregular steps of *slow* exhaustion, 0 to 10 cm., 10 to 20, etc., as

indicated by the little circles. The evidence is of the same nature, remembering that, quantitatively, the effect must depend on the rapidity of exhaustion, etc., which is kept low to avoid influencing the needle by a current of air directly and also to avoid large temperature decrements.

There are thus two radiation effects, respectively positive and negative, which pass continuously into each other. One of these may be ascribed to the change of pressure into kinetic energy on the hotter side or side of convection excess; *i. e.*, there is pressure deficiency on the hotter side. The other, at higher vacua, is the radiometer effect, which is of opposite sign; *i. e.*, there is pressure excess on the hotter side. Hence, between the two, somewhere near 65 cm. here, the two phenomena are in equilibrium and the effect of exhaustion is nil.

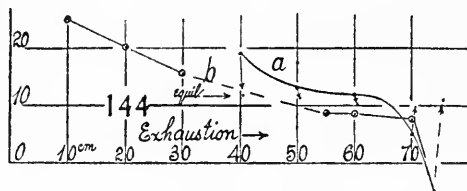

The investigation resulting in figure 144 was merely made for practical purposes and the deflections depend on many subsidiary details. It will be carried out under standard conditions presently.

There is a correlative test for the effect of radiation, from without, on the needle in an exhausted case. To apply this, the case was exhausted to above 70 cm. and a ball heated to 60° or 70° placed outside. No discernible effect was produced, or, in other words, the effect of external radiation is now small. Consequently the drift of the needle must vanish and the triplets become static repetitions of each other. That this is the case the experiments of the next paragraph will show. It follows, also, that the resistance encountered by the needle is now referable to the viscosity of air and therefore possibly open to computation.

At a later opportunity I returned to these interesting phenomena again, with the object of obtaining more definite results. The case of the needle was, as above, exhausted in steps of 10 cm. of mercury, successively and quite slowly, so as not to disturb the motion of the needle by air-currents. For this reason, pressure increments of 10 cm., *i. e.*, the return passage, did not succeed very well, as the needle was apt to be influenced by any accidental puff of air. During exhaustion there is no such danger.

Experiments were first made with the ball *M* removed, and they are given in figure 145 *b*. After each exhaustion the excursion of the needle was allowed to return to the equilibrium position, marked with little circles on the diagram. The period observed in these cases was relatively short and did not exceed six minutes, three minutes for the semi-period. Moreover, the equilibrium position varies somewhat, possibly because more than one swing should have been waited for; but this would have enormously extended the experiments and introduced other drift-like errors.

The needle lay somewhat obliquely across the case, the front end being nearer the front window and the rear end nearer the rear, to the effect that an increased potency (high temperature) of these windows would deflect the needle toward *larger* figures. This is the case in figure 145, where the ordinates are the scale-readings in centimeters and the abscissas change in steps of three minutes, roughly. The amount of the exhaustion 0 to 10 cm., 10 to 20 cm., etc., is inscribed on the curve, as to the larger number, remembering that the steps except the last (70 to 72, 72 to 74) are each 10 cm. At the end are two cases of influx with a reversal of result.

On account of the slow and cautious exhaustions made, the corresponding temperature decrement of the air within the case must have been very small; and yet the excursions of the needle due to the attraction of the nearer and relatively hotter glass window is at first very marked, for the deflection produced by $M = 1.5$ kg., at 5 cm. should be but 3 cm., roughly, in the same scale. The amount diminishes, however, until between 60 and 70 there is no effect, or an equilibrium of radiant forces. Thereafter, 60 to 70, 70 to 72, 72 to 74, the effect changes sign and these repulsions increase at a relatively very large rate. The effect is reversed on compression.

The experiment was now varied, merely by the changing of the environment; *i. e.*, the ball $M = 1,600$ grams was placed within 5 cm. of the needle, in such a way that its gravitation attraction or its radiant force for a plenum and hot ball M would deflect the needle toward smaller numbers; *i. e.*, to act *against* the effect of the window or case. The results are given in figure 146 and are totally different from the preceding, as there is a double inversion for each exhaustion. At first the case (c) acts as in figure 145; thereafter the effect of the more massive ball M (b) supervenes and finally the needle returns to its equilibrium position. The null effect here occurs between 50 and 60 cm. The inversion, 60 to 70, 70 to 74, is as marked as before. The circles in figure 145 are higher than in figure 146, owing to the gravitational attraction of M .

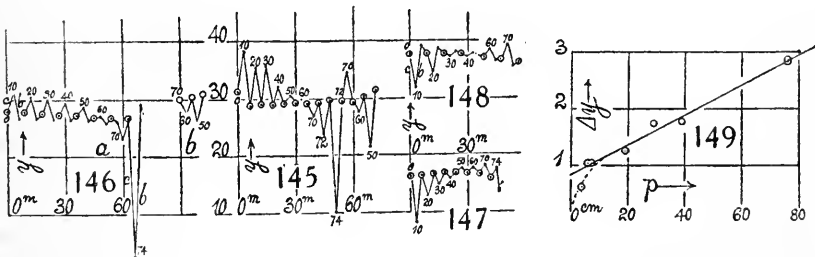

Finally, figures 147 and 148, the torsion-head of the needle was slightly rotated so as to place it in a more symmetrical position to the walls. The results are again noteworthy. In the first place, the phenomenon, figure 147, as a whole, has been reversed through partaking of the same general character. Furthermore the interval of absence of radiant force has been lowered to between 40 and 50 cm. At the same time the radiometer effect at the end has

dwindled in importance. The plenum effect, however, refuses to be so easily dissipated. The circles in figure 148 are higher than in figure 147, owing to the attraction of M .

Figure 148 has the same characteristics as figure 147, except that the ball M was left in front, thus tending, if warmer, to produce deflections toward larger numbers. Consequently figure 148 should be an inversion of the other, as it is. All these results were very definite and the figures might have been drawn to a larger scale with advantage.

91. Tendency of needle to stick to glass window.—This very annoying phenomenon, frequently mentioned in these experiments, now finds a rational explanation. If the glass plates of the case are different in temperature from the needle, there is a radiant force on one side of it (the side depending on the exhaustion), which increases as the needle approaches the glass window, sufficiently to hold the needle there against the torque of the quartz fiber. In the damp laboratory room electrical forces are, I think, out of the question. Radium close at hand does not change the phenomenon. I may cite a marked example here. In order to locate a leak in apparatus *II*, the whole case was submerged in a water-bath. After replacing the apparatus, well-dried, etc., at about 1 p. m., the east end of the needle first stuck to the front window. If shaken off by tapping the case, it vibrated, but finally returned to the same position. Later, from 2 to 5 p. m. it similarly adhered to the rear. Still later it stuck to the front again, after tapping. It was found so the next morning; *i. e.* after more than twelve hours. Now, however, after tapping, it soon took its position in the middle of the case and was free. The Δy was a normal value, but both readings y were still high, showing that the window attraction was not quite spent. In all this work the case was kept exhausted to a pressure less than 5 cm.

It is such results as these that lead one to question, even granting the law of cooling, which associates long times of cooling with small temperature differences, whether something more than mere temperature is not in question. It is probable, also, that the continuous drift of the zero-point, in case of the daily readings of apparatus *I*, is attributable to a slight quasi-temperature excess of the front plate (east) as compared with the rear plate.

92. Needle excursions under increasing pressure.—The excursions of the needle of apparatus *II* in a plenum of air were similar to those in apparatus *I*, but less variable, as has been already stated. Thus in figure 142 the mean data for July 30 to August 2 are

	July 30.	July 31.	Aug. 1.	Aug. 2.
A. M.,	$\Delta y = 4.00$	4.14	2.83	2.86
P. M.,	4.40	3.90	—	—

which is a drop in Δy corresponding to the case of apparatus *I*, notwithstanding the east-west needle in apparatus *II*. The details in figure 142 are also similar.

As this apparatus may be evacuated, it was thought well to observe the

effect of a *slow* influx of air into the apparatus, when exhausted to different pressures. The conditions of influx were throughout about the same, being about 7 cm. of mercury per 30 minutes at the highest vacua. The phenomenon is thus very nearly isothermal, and yet the results of the heating produced are phenomenally marked. The individual readings are given in figure 142, where the numbers show the exhaustion. Figure 149 contains the mean results Δy at the different vacuum-pressures p . The irregularity of results is to be ascribed to the change of Δy , even for the plenum, and to the difficulty of controlling the influx; but apart from this the excursions Δy rapidly diminish, nearly proportionally to p , throughout the large part of the curve, while at very low pressures the effect is possibly even accelerated. It often appears as if for $p=0$ there would be no excursion.

These results are so striking that one may well ask whether temperature is here only in question. The effect of influx (10 to 15 cm. per hour) is to heat the interior relatively to the ball M , without. Hence the region between the shot m and ball M is relatively cool as compared with the other side of the needle, and the result would be a repulsion on the cold side counteracting gravitational attraction. So far the reduced results are consistent with the experiments of figures 144 to 148, though the graph figure 149 is incorrect as to slope. Again, the earlier data demand an inversion of the effect at about (say) 50 cm. of exhaustion; *i. e.*, an attraction. The present data here show no inversion, but rather an accentuated repulsion. True, the inversion in figures 147 and 148 is not marked. It is present, however, while in figure 149 Δy in a vacuum of 50 cm. is but one-half of the value for a plenum.

The work done by this influx, so nearly isothermal, would be $Rm\tau \log p/p'$, where m is the mass of gas, p and p' are the initial and final pressures, and m varies as the mean pressure, nearly. Thus

Pressures	43-36 cm.	33-25	23-16	11-3	7-2
Work done \propto	31	35	31	40	28
Log p'/p	= 0.08	0.12	0.16	0.56	0.54
$\Delta\theta$	= 14°	23°	30°	108°	104°

The work done is therefore not so different in the various cases, but as the mass is inversely as the pressure, the rise $\Delta\theta$ of temperature would vary as $\log p'/p$ and would thus be greatly in excess at the higher vacua. In this respect the results of figure 149 may in a general way be interpreted, if the radiometer effect is ignored. It would have to be nil in a perfectly symmetrical needle, but what is curious is the persistence of the plenum effect. There is a persistent pressure on the colder side of the needle at all exhaustions.

The total amount of heat produced and its temperature effect may be computed. If τ is absolute temperature, m the mass of gas, the work done is in the usual notation for a pressure increment of dp ,

$$dW = Rm\tau(dp/p)$$

If $d\theta$ is the corresponding rise of temperature without loss by radiation,

$$dW = Jkmd\theta$$

Thus, after integration of the equated values of dW ,

$$\Delta\theta = \frac{R\tau}{jk} \log \frac{p'}{p}$$

The constant factor is about 83×2.3 , since Napierian logarithms are needed. In this way the values above given were obtained. They represent the total accumulation of heat in over half an hour; but it is at once radiated by the gas and finds lodgment on the walls of the apparatus. Even if these radiated nothing, their temperature increment would be infinitesimal in the ratio principally of their mass to the mass of the air-content (probably for the plenum 0.3 gram to several kilograms), which is then further diminished by radiation. The available heat does not differ as much at all the pressures as does the temperature. I question whether such small thermal effects, if they are such and so circumstanced, could be detected in any other way.

93. Experiments with the exhausted case.—The case, figure 139, having been carefully sealed, measurements were made in partial vacua, as shown in figure 150, for an exhaustion between 20 and 30 cm. and figure 151, for an

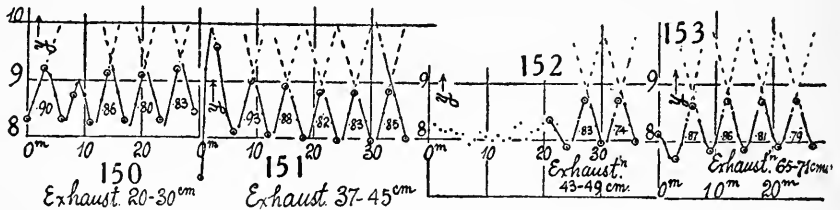

exhaustion between 37 to 45 cm. In the former an error was made in the second triplet, which is therefore discarded. It is seen at once that, as the exhaustion increases, the drift grows less and the triplets are nearly repetitions of each other. The double amplitude changes but little; thus, for

Plenum, $p = 76$ cm.	$\Delta y = 0.87$
Vacuum, 51 cm.	0.85
Vacuum, 35 cm.	0.86

a result to be anticipated, if the viscosity of air is independent of pressure, and in view of the very slow motion of the needle, the resistance is not due to turbulent motion of the air. The case leaked slightly, but this does not seem to be of moment here.

An important consequence follows: Since the frictional resistance is independent of pressure, it may be computed as a case of viscosity, the problem being that of a cylindrical shaft rotating on a normal axis, at its middle point, in a viscous medium. This is further borne out by the fact that in the above three-minute triplet curves, the branches, after being released from the turning-points, are very nearly straight lines. Moreover, midway between the turning-points the elastic force of the fiber is necessarily zero. In the preceding report, many instances were given in which, even for larger periods, the curve soon consisted practically of zigzagged straight lines.

Notwithstanding the steadiness of the new results, one-minute periods, as shown in figure 152, are again impossible, while the three-minute periods following succeed at once. In figure 153, the highest mean exhaustion available during thirty minutes was applied. The value of the triplets has not practically changed size:

$$\begin{array}{ll} \text{Vacuum, } p = 30 \text{ cm.} & \Delta y = 0.79 \\ \quad \quad \quad p = 8 & \quad \quad \quad 0.83 \end{array}$$

the smaller values being referable to slightly greater temperatures within the case. Figure 153, moreover, is appreciably sinusoidal, all the branches being first accelerated and finally retarded. There is no apparent inertia effect. The double inflection might be associated with the elastic resilience of the fiber. It is much more probably, however, the result of a repulsive radiant force which requires a minute or so for development. Thus, when the weight is turned the counter radiant force acts for a time with the new pull of the weight. Hence the acceleration. The radiant force gradually vanishes in turn, passing through zero, then to become negative and constituting an increasing resistance to the new pull. Thus the retardation ensues. In other words, the radiant force needing time to develop, is in phase behind the gravitational pull, which acts instantaneously. The two observations between the turning-points should therefore be without appreciable radiant force and the data of §95 for the rates of uniform motion bear this out very fully.

94. Tentative estimate.—The resistance experienced by a sphere of radius r , moving in a viscous fluid (η) with a velocity $v = l\omega$, is well known to be $6\pi\eta rv$. I have not found the corresponding expression for a cylinder (figure 139, $m m'$) of radius r , semi-length l , and with hemispherical ends, moving with constant speed, broad-sides on. To get at an order of values, however, we may postulate that for equal frontal areas, $\pi r^2 = 2r\Delta l$, the resistances are alike. Thus the element of resistance is

$$dF = 6\pi\eta rv = 6\sqrt{\pi}\eta l\omega\sqrt{\pi r^2} = 6\sqrt{\pi}\eta\omega l\sqrt{2r\Delta l} = \omega\eta\sqrt{24\pi r\Delta l^3}$$

and we may meet the further conditions by integrating for the length $2l$ of the needle. To carry out the integration* put $l = n \times 2r$, where n is a serial number. The equation becomes

$$dF = 8\omega\eta r^2\sqrt{3\pi\Delta(n^3)}$$

and the problem reduces itself to the summation of a series of cubes,

$$2\sqrt{\Sigma n^3} = n(n+1), \text{ the length being } 2l.$$

Hence, finally, for two masses, M , m , at a distance R apart, disregarding corrections,

$$\gamma = 8(R^2/Mm)\eta\omega r^2\sqrt{3\pi} n(n+1)$$

The constants of the second apparatus were: $M = 1602\text{g}$, $m = 0.563\text{g}$

$$R = 5.1 \text{ cm.}, \quad 2r = 0.4 \text{ cm.}, \quad 2l = 22.8 \text{ cm.}, \quad \eta = 0.00019, \quad n = 28.5$$

* A more acceptable upper limit would be $\gamma = (R^2/Mm)3\pi^2\eta r^2\omega n(n+1)$.

In figure 151 the last three scale-rates of the lines prolonged have the mean value 2.17 cm. per five minutes, for the scale-distance of 265 cm. Hence $\omega = 2.17/300 \times 530 = 0.0001364$ radian per second. Inserting these data, $\gamma = 10^{-8} \times 6.2$, which is much closer to the standard value than from the inadequate theory and improvised apparatus (straw shaft) I had expected to get. It sufficiently substantiates, I think, the assumed viscous character of the resistance, and moreover shows that the Newtonian constant may be found with precision, in terms of the resistance to the uniform motion, broad-side on, of a cylinder with hemispherical ends, in air.

TABLE 5.—Apparatus II. Values of ω .

p cm.	$\omega \times 10^7$	p cm.	$\omega \times 10^7$	p cm.	$\omega \times 10^7$	p cm.	$\omega \times 10^7$			
76	131	51	150	35	126	30	112			
	108		131		131		112			
	150		143		131		121			
	105		143		105		100			
	121		157		108	Mean 30 cm.	111.5			
	126		150		137					
	101		137		98					
	98		Mean 51 cm.		144.3	137	Mean 35 cm.	123.3	8	121
	108					116			157	
	92					143			126	
	126			143		143				
	121					131				
	101					137				
	137					116				
Mean 76 cm.	116.2					Mean 8 cm.	131.0			

Mean total: $\omega = 0.000,012,53 \dots 8$ cm. to 76 cm.

95. Angular velocity at different pressures.—The favorable result obtained in the preceding tentative computation of γ induced me to make a summary of the values of ω occurring in the different experiments of figures 143, 150, 151, 152, 153, for the needle of apparatus II. They were obtained graphically, by prolonging the lines of the triplets as shown in the figures and dividing the scale-rate (y) per minute by $60 \times 2 \times 265$, the scale being at 265 cm. from the mirror. These results with their mean values are given in table 5.

Except in case of the last series ($p = 8$ cm), the rate-lines pass through three consecutive points after turning. In the case of $p = 8$ cm., figure 153, they pass through but two, the curve being sinuous. The variation of ω can not be ascribed to insufficiently rapid turning of M , though this was done by hand. The individual values of ω are rather more variable than I hoped to find them, and this is also true to the mean values. The data do not, however, show any systematic relation to pressure, the differences being clearly referable to other incidental causes.

96. Water-bath.—The next step in the pursuance of this subject consisted in putting the apparatus II in a capacious water-bath of copper, sufficiently large to contain the movable weight M . An additional object to be gained was

the location of the small leak in the apparatus, which after several complete overhauls of the apparatus had escaped detection. The chief purpose, however, was that of surrounding the needle with a medium of large heat-content and slow variation of temperature.

The arrangement is shown in figures 154 (plan) and 155 (elevation), where *mm* is the needle with its mirror *n*, quartz fiber *q* suspended from a sealed torsion-head at the top of the tube *t*. The needle is surrounded by the case *ww* of waxed (impregnated) wood, closed on both vertical sides by plate-glass windows. The case is supported by the posts *rr* held in clutches anchored in the pier. The tube for exhaustion is at *s*. The water-bath *BB* surrounds the case completely, and the parts *rrs* pass through gasketed devices to prevent leakage. The rod *v*, also gasketed and clutched by an arm fastened in the pier, carries the sleeve *u* within the water-bath. It is to this that the crank-like arm carrying the weight *M* is attached and free to revolve from *M* to *M'*, the arc being limited by appropriate stops.

The circular trough of the water-bath was about 30 cm. in diameter and 20 cm. high; the rectangular part 25 cm. long and 14 cm. broad. It contained over 30 pounds of water. The lead weight *M*, whose effective density is now 11.3-1, was approachable to 1 or 2 mm. of the glass walls of the case, the distance between centers *M*, *m* being left unchanged. The case was leveled and the tube *t* supported by separate clutches, as above. Moreover, to keep the glass window *z* parallel to the case, it also was secured by a special clamp from the pier.

The results obtained with this complicated apparatus were not at first as orderly as expected from so large a mass of water, nor was the leak of about 5 cm. per hour on complete exhaustion removed. The conformity to the temperature of the water-bath was extremely slow. At first, at the high vacua, $p=4$ to 8 cm., the results seemed to give promise; the readings were $\gamma=6.95$, 7.50, 7.00, 7.60, 6.95, 7.60, etc., in five-minute periods. Later, however, at a slight exhaustion, $p=68$ cm., the mean excursions in successive hours were $\Delta\gamma=0.69$, 0.93, 1.02, etc., the normal excursion in the absence of the water-bath being over twice as large. It therefore seemed preferable to begin the work with long-period observation (per hour) for some time, in a manner similar to the case of figures 119, 120 of apparatus *I*.

Next day, at $p=67$ cm., the results as shown in figure 156 *a* conformed to $\Delta\gamma=1.16$; but they are otherwise no improvement on the prior results. Thereafter the apparatus developed a leak and had to be taken down to be thoroughly overhauled. It was then replaced and observations were made under full air-pressure. The apparatus having had a day for cooling, the excursion in the absence of water in the bath was again normal in behavior,

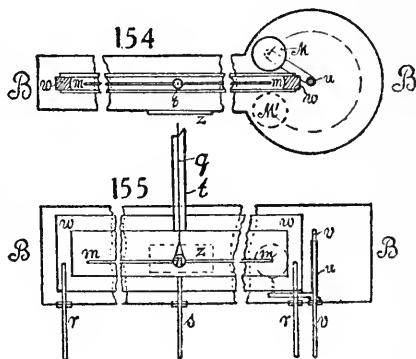

$\Delta y = 2.7$. Water which had stood in the same room for days, alongside of the apparatus, was now poured in and observations of y made in half-hour periods throughout the afternoon, August 18. The readings as given in figure 156 *b* indicate a drifting needle, modified according as the drift to larger numbers was with the gravitational pull (*S*) or against it (*N*). This force is wholly secondary and almost masked. Its mean effectiveness is but $\Delta y = 0.73$ cm.

The same experiment (half-hour periods) was continued throughout the whole of the ensuing day, August 19, the greatest attention being paid to carefully sitrting the water. The results are given in figure 156 *c* and show only slight improvement. There is still an excess of drift, but alternations of gravitational pull are now usually apparent. The mean excursion is but $\Delta y = 0.65$ in the morning and $\Delta y = 0.42$ in the afternoon. The change of

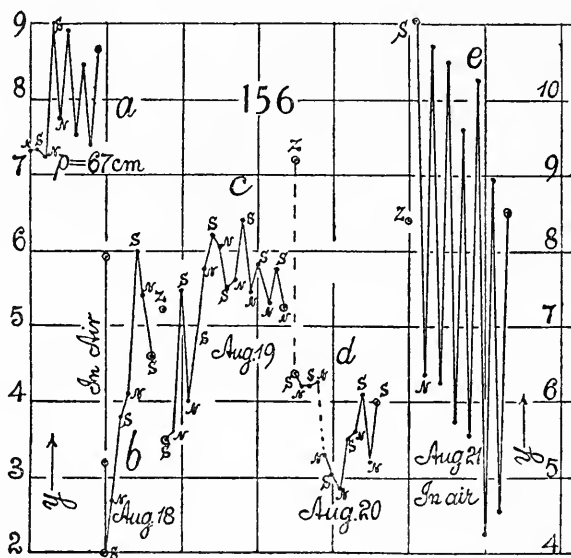

temperature of the water-bath could not have exceeded a few tenths degree; but to give greater definiteness to this statement, the experiments were continued in the same way during a third day, August 20, and parallel observations made on the temperature of the water-bath by a tenth-degree thermometer. The results also given in figure 156 *d* are quite as erratic as the preceding. In the morning the gravitational and radiant (repulsive) forces are all but equal. In the afternoon, with a different adjustment, the effect of gravitation gradually emerges, frequently only as an acceleration or an impediment on the drift. In fact, the needle is in continual motion and the results would have been more rational if the periods instead of being 30 minutes, had been shorter. As it is, the mean (p. m.) gravitational excess is but $\Delta y = 0.42$ cm. The gradual increase of the temperature of the water-bath scarcely amounted to one-fifth of a degree for the day. Now the actual temperature

differences of m and M must be less than this, since there is some accommodation, all of which shows the minute temperature discrepancies which are quite adequate to annul the effect of gravitation.

Next day, August 21, with the water-bath removed and a *free* case in air, the alternations throughout the day given in figure 156 *e* were obtained, showing that the full deflection should have been (deducting of course the $7/11.3$ part due to the presence of water): $\Delta y = 4.45$ a. m., and 4.30 p. m. The behavior of apparatus *I*, however, announced this to have been a day of large excursions; but at least one-half of the Δy should have been exceeded.

The drift observed must be ascribed to the very slightly rising temperature of the water-bath, of which the case partakes. It is an increasing pull toward the front of the case or, better, a decreasing push toward the rear, and agrees in sense with the pull of the weight M when in front. There is also marked drift in the air values in figure 156 *e*.

I made these experiments with scrupulous care, as they furnish the only quantitative estimate of the thermal relations involved. It is astonishing that this standard and effective method of obtaining temperature constancy here utterly breaks down, notwithstanding the 30 pounds of water used. While the mere exposure in a medium of air (fig. 156 *e*) gives results which are fluctuating indeed, but not abnormal. In speculating as to a cause, it seems probable that the surface temperatures, on radiation through air, tend to become equal to a greater extent than happens in the other cases.

97. Attraction in vacuo.—The remarkable result embodied in figure 149, in which the gravitational attraction decreases in a high vacuum to about one-third of its value in a plenum, induced me to give the subject further attention and ultimately to construct a metal apparatus for the further study of this strange behavior. Unfortunately it was not possible to get apparatus *II* (case of wood, impregnated when hot with melted soft sealing-wax) quite tight. The leak was originally about 7 cm. per hour at the highest exhaustions. After many improvements and much labor I reduced this to 2 cm. per hour. I then found, however, that a supply of air was absorbed in the wood. This came out very gradually on reducing the internal pressure, but was reabsorbed on increasing it. Thus one meets the curious result of a gradually increasing or a decreasing vacuum, according to the direction of the change of the internal air-pressure. An increase by as much as 10 cm. or more was recorded at mean pressures. These annoyances, as they must be accompanied by slight temperature variations in the wood complicate the results. They can not possibly be smooth. I hoped, however, to get a mean result by operating both with increasing and with decreasing internal pressure.

There is the additional difficulty of the change of atmospheric temperature during these essentially long-period observations, which operates with a lag. This induces a change of Δy , as explained above (figs. 119, 120, and 121). My first endeavor to eliminate it consisted in comparing the Δy_2 of apparatus *II* with Δy_1 of apparatus *I*, placed on the adjoining face of the pier; but although

there is here a general similarity observable, it is not sufficient for such a reduction, as tabulation showed. The plan finally adopted for want of a better was somewhat cumbersome and as follows: Those observations in which complete series of results were available between, say, $p=2$ cm. and 76 cm. were first constructed and the mean result taken; *i. e.*, the mean graph drawn through them, assuming $\Delta y_2=3$ for a plenum. By aid of this, the data taken at all other pressures (incomplete series) were then reduced, assuming $\Delta y_2=3$ for the plenum, throughout. The table of corrected data is too bulky for insertion here and the summary in figure 157 must suffice. The rates are sometimes too low, probably from escape of air from the wood, sometimes too high for the reversed reason of absorption; but as to their testimony as a whole and for this particular apparatus *II* there can be no question, I think. The effective gravitational attraction when one of the bodies is in a partial vacuum decreases at a mean rate of about $\Delta y_2=0.03$ or about 1 per cent per centimeter of mercury-pressure. This makes a drop of over $\Delta y=2$ for the complete range from plenum to vacuum, about as originally obtained.

It has been stated that this result is inconsistent with the efflux results of figures 145 to 148, the interpretation of which is straightforward. Moreover, these effects are relatively transient, whereas in the case of figure 157 the results persist. If the graphs, figure 149 or 157, are considered due to the influx resulting from the leak with consequent rise of temperature, then these graphs should slope downward from left to right and not upward. Under any circumstances, moreover, the thermal effect should vanish in a partial vacuum of 50 to 60 cm.; *i. e.*, the initial or plenum Δy_2 should be regained. There is no suggestion of such an inversion in figures 149 or 157. The effect continues in the same manner indefinitely, so far as observed.

One can not but conclude, therefore, that so far as this evidence goes, there is here a different phenomenon superimposed on gravitation; in other words, that the effective gravitational attraction on a body in vacuum decreases 1 per cent per centimeter of pressure, for reasons not understood.

98. Apparatus No. III, brass and glass.—It was necessary, therefore, to endeavor to construct a new apparatus, which could both be freed from leakage and would be without the porous annoyances of wood. The new apparatus *III* was constructed much like No. *II*, except that a rectangular frame of square brass tubing, the frame being 23 cm. long and 5 cm. high in the clear, replaced the wood. Thick glass plates were cemented on in front and rear, the distance apart of their outer faces being 3 cm. and 1.3 cm. between their inner faces. The joints at the torsion-head, etc., were inclosed in cups, into which melted soft sealing-wax was poured, obviating leakage. The quartz fiber was somewhat finer than the above and, the center of the weight $M=1.6$ kg. being able to approach the center of m to $R=4.5$ cm., the deflections, other things being equal, were larger. The needle moved more slowly. The greater deflection here, however, is a doubtful advantage in view of the longer period, for the readings are always very sharp. The needle when complete

with mirror weighed 1.813 grams; of this, the two shots contributed 0.595 gram each, the straw shaft 20.9 cm. long (between centers), the remainder, 0.303 gram, being in the mirror and hangers. The shaft thus weighed but about half as much as either shot.

The space within which the needle was to vibrate was only a little over a centimeter; but it usually sufficed here, after the apparatus had been thoroughly and uniformly cooled.

Tested in a plenum of air, the apparatus showed itself extraordinarily sensitive to temperature, as instanced in the half-hour periods in figure 158 a, where the gravitational attraction is at first ineffective but eventually develops. A part of this is due to the day, as apparatus I also shows it, though not to the same degree. Δy_3 as high as 6 was finally obtained.

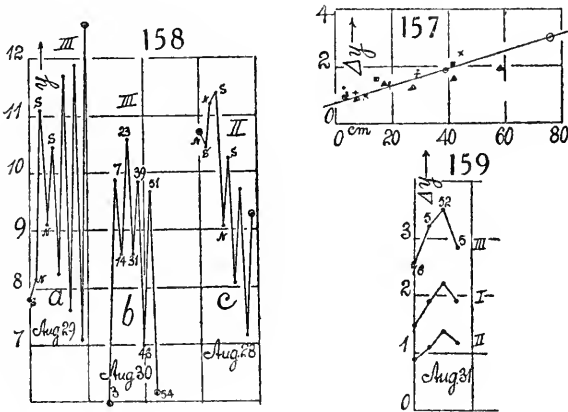

The effect of exhaustion is shown at figure 158 b and there is here an apparent increase of Δy_3 with the pressure p marked on the curves. But while Δy_3 increased from 1.6 to 3.1, the corresponding reading of apparatus I also increased (for a plenum) from $\Delta y_1 = 1.2$ to 2.1. Thus in these complications there seems to be no margin left for the above effect of exhaustion. The marked irregularities which a variable atmospheric temperature may produce is instanced in figure 158 c, observations obtained with apparatus II on the preceding day (N north and S south position of the attracting mass M). It is not improbable, therefore, that the metallic frame III will in a different way respond to the anomalies which the wood frame showed at reduced pressures.

Apparatus III, as stated, was installed on the east-west wall of the pier, in front or facing south, replacing apparatus II. The latter was now placed in a niche in the rear of the pier, facing a brick wall about 1 meter to the south. In this position it was completely screened from any direct radiation from the walls of the room having outside exposure. Apparatus I on the north-south face of the pier was left in its old position fronting (east) the 30-inch wall exposed to the morning sunlight outside, when present. The wall east-west faced by apparatus III was always in shadow. It was there-

fore thought interesting to pursue the records of these three instruments for a reasonable time, to determine their differences, and in particular to compare *I* and *II* at atmospheric pressure with the contemporaneous behavior of *III* under exhaustion.

Figure 159 shows the mean results of experiments of this kind, made in half-hour periods at intervals of over 2 hours apart. Apparatus *I* and *II* were at full atmospheric pressure and in the location stated. The day (August 31) was overcast, with rain. Apparatus *III* was kept exhausted to different degrees at the pressures marked on the curve. Although the three instruments differ in sensitiveness, they at first tell the same story, even as to No. *II* in its dark niche. Moreover, the high or moderate exhaustions in No. *III* have seemingly produced no marked difference, such as appears for instance in figures 149 and 157. One would thus be obliged to conclude, in the latter cases, that the air absorbed by the wood, in its issue or reentrance, was responsible for the effect in Δy obtained.

During the course of the experiments (fig. 159) the apparatus developed a slight leak. Though this did not apparently influence the results, as the figure shows, it was thought well to remove it. In the long search which was necessary to find it, the fiber of the needle was unfortunately broken and in the troublesome repairs one-half of it had to be sacrificed. This reduces the sensitiveness of *III*, from its high value above, to an intermediate grade between apparatus *I* and *II*, the latter being least sensitive. Though *III* was at first quite tight, it again after usage developed a leak of about 3.5 cm. per hour at complete exhaustion. As this on trial made no difference with the behavior of the metallic case *III*, it was disregarded. In the work with the wooden case, however, even the smaller leak of 2 cm. per hour at the highest exhaustion was held accountable for the startling effect of figures 149 and 157. Such an inference is therefore no longer tenable. One is left to surmise that the non-conducting wood retains the heat almost indefinitely, while the thin metal frame (half-inch tube of square section) loses it relatively soon.

A comparison of the records of apparatus *I*, *II*, and *III* in their several locations will now be given (fig. 160), in order to discriminate between a possible absolute temperature effect, if it exists, and the relative effect which would naturally follow from changes of atmospheric temperature.

The comparisons in figures 160 and 161 begin with the cloudy days on September 2 (observations taken at the same time are in the same vertical), when the three instruments still show some similarity of behavior, though it is very meager. With the appearance of sunshine in the atmosphere without, the three instruments part company. Initially No. *III* was observed at different pressure (numbers, cm. of mercury on the curve). At first the excursions under $p=76$ and $p=3$ cm. were about the same, so that the final high values at $p=76$ cm. or at lower pressures must obviously be referred to other causes in addition to pressure. For this reason I temporarily abandoned the pressure work and made some of the subsequent observations for No. *III* in a plenum. They soon became extremely erratic. On September 4 the needle adhered to

the window and the torsion of the fiber had to be changed. Subsequently, repulsion in the morning and attraction in the afternoon were the rule, as shown in figures 162 *a*, *b*, and *c*, *N* and *S* denoting a north and south position of *M*. The mean excursions, Δy_3 , were, for instance, as follows:

	Sept. 5.	Sept. 6.	Sept. 7.
11 ^h	$\Delta y_3 = -2.00$	11 ^h $\Delta y_3 = -1.67$	11 ^h $\Delta y_3 = -2.92$
1 ^h	-1.77	1 ^h -0.48	1 ^h -0.45
5 ^h	+2.73	4 ^h +1.14	5 ^h +2.14 etc.

This apparatus, with a narrow (1.3 cm., inside) metallic case, and an east-west position of needle, is thus singularly and immediately responsive to temperature in a way opposite to No. *I*. No. *III* was therefore again abandoned as useless for plenum work.

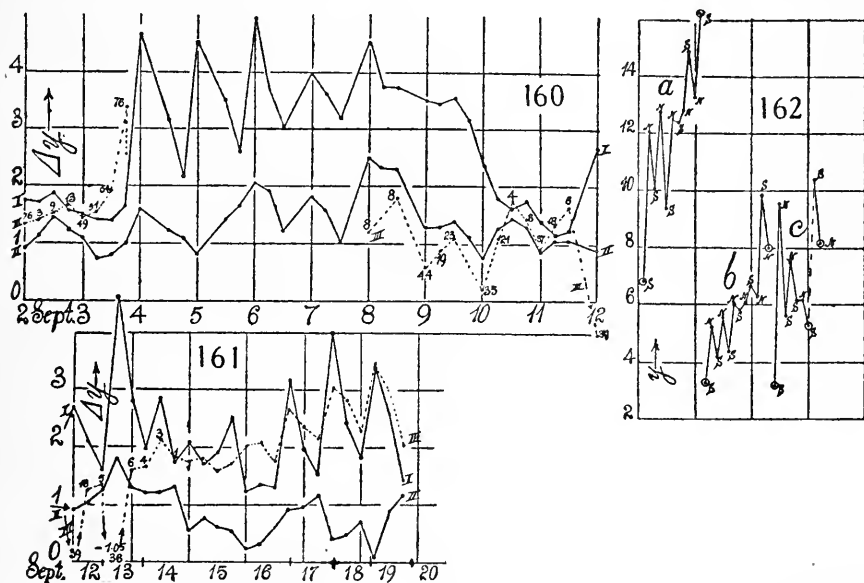

Apparatus *II* in a brick niche, narrowly and completely surrounded by brick-work, without outside exposure, and kept in the dark, nevertheless soon began to show a remarkable drift; yet it rarely behaved abnormally. On September 5, when this drift was exceptionally great, apparatus *II* and *I* are out of accord; but on a number of the following days the march of results is similar to apparatus *I*, in spite of the difference of environment. The zigzags in *II* are much subdued, as one would anticipate from the secondary reflections received. In fact, No. *I* confronts an exteriorly illuminated wall in the morning and *III* in the afternoon. Thus the former is high in the morning and *III* in the afternoon, indicating the rotation of the sun. It is none the less difficult to understand why *III* registers repulsions in the morning (fig. 162). Heat seems to pass more rapidly through the thin metal case than, so far as temperature effect is concerned, it can enter the massive ball *M*.

Finally, after observing that the needle, if stuck to the sides, could always be freed by exhausting the case, experiments with *III* were resumed at low pres-

tures throughout. These are marked on the curves, figures 160 and 161. It was inferred that as the air is removed, the effectiveness of convection currents ceases more and more, and therefore the earlier or low-pressure radiant forces should disappear.

The resumption of the work with No. *III* under partial vacua (marked on the curve) after September 8 soon showed that pressures even as low as 35 centimeters were quite inadequate to remove the radiant repulsion specified. With these No. *III* behaved in a way which was exactly the opposite of No. *I*. Consequently, after September 14, No. *III* was observed at high vacua only, the pressures ranging from $p=1$ to 2 cm. of mercury. Under these circumstances the records of No. *I* (observed in plenum) and No. *III* (observed in vacuum) are substantially alike, a result, at first, quite perplexing.

It follows, therefore, that whereas in case of No. *II* (wood) the vacuum removes a radiant attraction, in case of No. *III* (metal) the vacuum removes a radiant repulsion, the radiant forces being throughout large as compared with gravitation. In fact, even at $p < 1.5$, the effect of exhaustion has not subsided, for direct tests showed that $dy/dp=0.5$; *i. e.*, an addition of 5 mm. to y for each mercury centimeter of pressure reduction was still outstanding; twice as much, therefore, for the double amplitude Δy .

This is a relatively enormous discrepancy. Thus, there must be an inversion of radiant forces with decreasing pressure p , from the repulsions at high pressure through zero to the attractions at low pressures or vacua. This complete opposition in the behavior of two apparatus (*II*, *III*) in the same position and alike, except as to the wood case of one and the metal case of the other, is difficult to explain. The active needle-end is relatively hot in the metal case and cold in the wood case, or vice versa, under like circumstances, if the simple theories adhered to above are applicable.

With regard to the metal case *III*, it is easy to show, by using a hot body in place of the mass M , that the radiant forces are increasingly repulsive for $p < 4$ cm. and increasingly attractive as pressures are larger. The exact pressure corresponding to radiant equilibrium is a little more difficult to determine. In relation to apparatus *I* and *III*, therefore, this implies that in the former case M is warm in the morning (eastern exposure, radiant force attractive) and for apparatus *III*, M is relatively warm in the afternoon (southern exposure). Consequently the afternoon repulsive force, operative in apparatus *III* under high exhaustion and warm M , balances the afternoon repulsive force in the plenum apparatus *I*, with a relatively cold M . Hence the curves for the two apparatus are the same in kind. In other words, one can thus, in a dark room, demonstrate the rotation of the sun.

99. Metallic case cooled by efflux.—The marked difference in behavior of apparatus *III* (glass and brass) as compared with apparatus *I* and *II* (glass and wood) makes it seem probable that the results of §90 will also be modified in the present experiments; and this is markedly the fact. Unfortunately, in No. *III* the needle hung very near the metallic bottom of the case, so that

great care in exhaustion (slow change of pressure) was necessary; but I do not think this had any influence on the following experiments. These are given in figure 163 and made (as above) by exhausting the case slowly in steps (v) of the pressure-gage, $v=0$ to 15, 15 to 25, etc., cm., as marked on the curves, so that the pressures fall as $p=76$ to 61, 61 to 51 cm., etc.

In the series 2, 3, 4, the weight M was removed and the case and needle reciprocate in the absence of M . In series 1, the weight M was in front, attracting toward larger numbers γ , of the scale. Series 1 and 2 were made after sun-down, at night; series 3 and 4 in the day-time. The first exhaustion in series 1 (0.15 cm.) was obviously too fast; but all these series consistently show a new result, different from §90; there is no inversion of the immediate effects of exhaustion, according as they are made at high vacua or at low vacua. The first effect of exhaustion is always an increase of pressure on the hotter side; *i. e.*, the radiometer effect prevails throughout. It seems, however, to pass through a minimum somewhere between 40 and 50 cm., though, as the rate of efflux can not be controlled, this is difficult to assert. In high vacua (about 70 cm.) the effect rapidly increases as it did above. Here there is no difference.

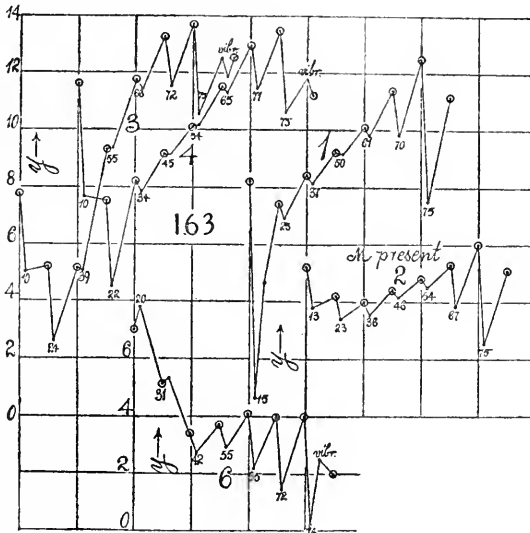

If we compare series 1 and 2 another inference may be drawn. The equilibrium positions from which exhaustions were made are marked by little circles. In series 1 these rise rapidly, which means that the weight M was at a lower temperature than the needle (and case) and that the radiant forces are largely removed by the exhaustion. Above 70 cm., however, they are again partially restored, and this is also the case in series 3 and 4, where the circles descend after $v=70$ cm. Series 2 in the absence of the weight M shows that needle and case were about at the same temperature and that the exhaustion, therefore, has less influence, there being only relatively small radiant forces. In series 3 and 4, made in the afternoon, the case was colder than the needle and the

strong radiant forces resulting, rapidly dwindle as the exhaustion proceeds. They are never, however, quite removed, as was possible in the case of inversion of radiant forces, above.

The effect of the successive exhaustions on the motion of the needle was here also very different from observations in the above work. The needle reaches its low positions within two minutes after the exhaustion. It then merely *creeps* to larger numbers γ . I usually waited four or five minutes. By waiting longer, larger numbers would have been reached and no doubt the minima immediately after exhaustion would have been larger. Creeping responds to a developing change of radiant force.

The effect of exhaustion in removing radiant forces may be used in freeing the needle when it adheres to the windows of the case. As this in No. *III* was very narrow (1.3 cm. inside), the annoyance of needle pushing with its ends the two opposite windows was quite frequent on sunny days, as stated above. It is merely necessary to exhaust the case, without changing the torsion-heads to free the needle, and the apparatus then behaves normally; but if p is variable the attractions of M are not constant, nevertheless showing that a small part of the radiant force persists residually to modify the results. To use *III* with advantage, it must therefore be kept exhausted to above at least $v = 50$ cm. or $p = 25$ cm., as is ultimately done in figure 161.

In the experiments with the wood case, I was under the impression that the radiant forces for low and for high vacua would always be opposite in sign. The experiments of figure 163 show that this is not generally true. It is difficult to ascertain the reasons which govern the sign of the former, and it is probably associated with distributions of temperature in the very narrow metallic case, in a complicated way. Thus by changing the position of the needle, results (of which series 6, fig. 163, is an example) were obtained in which the radiant forces for low vacua are at first positive but become negative at about 30 cm. of exhaustion. Inversion is thus met with even with the metallic case, though the pressure at which radiant equilibrium occurs is not a definite quantity. The fact that so much of the earlier radiant force may be removed by exhaustion may be regarded as a proof of its dependence on convection. The other proof is its gradual development; for it is not present immediately after turning the weight M .

CHAPTER XI.

GRAVITATIONAL EXPERIMENTS.

100. Slender needles.—The object in making the above experiments was at the outset a mere endeavor to read the deflections of the gravitational needle by interferometry. For this reason a straw shaft was used, as it facilitated the adjustments. The plan succeeded without serious hardships. It was soon found, however, that what was being measured was not the gravitational deflection, but a much larger value, resulting from the radiation forces simultaneously present. Unfortunately, the fiber broke in the vibration experiments made to find its torsion coefficient. Using the microscope to measure the diameter of the fiber and using the known rigidity, the Newtonian constant came out $10^3\gamma=21$, or about three times too large, nor were the individual deflections even approximately constant.

Thereafter, I retained the needle, as I became specially interested in this interaction of radiation and gravitational forces, and a series of experiments showing a very striking response to solar radiation (even when screened off from the apparatus by the semi-submerged dark basement room) was carried out. The results given in the preceding paragraphs point out, incidentally, that if measurements of γ are aimed at, the straw shaft is inadmissible and that needles having the thinnest possible framework should be used, as offering the least surface for the application of radiation pressures.

One is tempted to interpret the discrepancies in question (at least with the needle *in vacuo*), directly in terms of light pressure or heat-wave pressures. Now, if the full solar constant be taken as 0.05 dyne per cm.² per second, this pressure would be $f=70\times 10^{-6}$ dyne per cm.² and in the case of the straw shaft considerably more than a square centimeter would be screened off by the large lead ball outside. The corresponding gravitational forces in the above experiments were about $F=2.4\times 10^{-6}$ dyne. Hence the ratio f/F is over 30; so that if considerably less than one-thirtieth of the solar radiation penetrates the walls of the room its effect is in conflict with the gravitational forces.

Figure 164 will make this tentative explanation clearer. Let mm' be the gravitation needle with the shot at its ends, B the large external lead ball. The radiation RR , acting symmetrically at both ends of the needle, remains ineffective. The radiation $R'R'$ on the other side is screened at B , supposing B to radiate less, which is almost always the apparent case in the following work, though the reason for this effective screening is not quite clear to me. Hence B acts radiationally as if it were an attracting body. It is not necessary that R and R' be of equal intensity, but the drift of the needle (which is sometimes excessive) would depend on this difference. Curiously enough, these forces are present in marked degree, even when the needle is a framework of

filamentary wire; *i. e.*, the balls at the end of the needle offer an appreciable surface in any case.

What militates seriously against such a straightforward explanation, however, is the enormous effect of the presence of air. In a partial vacuum 1 to 10 cm. the error will not exceed 20 per cent in the summer (constant temperature), or 30 per cent in the winter (steam-heated room). In a plenum of air, the results obtained may be 5 or 10 times too large, depending on the lateral area of the needle. It is difficult to escape the inference, therefore, that the presence of the ball *B* produces air-currents within the apparatus between ball and needle, and that it does this by modifying the radiation on its own side as compared with the radiation on the other side of the needle. The effect of a ball *B*, colder or hotter than the effective temperature on the other three sides, might thus be the same and its presence would be accompanied by a spurious attraction in relation to gravitation. If the ball *B* were to tranquilize the medium between *m* and *B*, there would be repulsion, and this practically never supervenes, so far as the present experiments go.

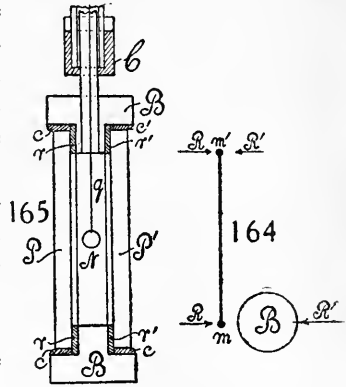

101. Experiments with slender needles.—To carry out the suggestions of the preceding paragraph, three types of apparatus were used. In the first of these (*IV*), the quartz fiber of the above apparatus (No. *I*) which had shown deflections from $\Delta y = 2.6$ to 7.2 cm. in its old location, was inserted. The case, the needle, and the position, however, were new. The case, specially made for experiments *in vacuo*, was of the form shown in cross-section (normal to the needle) in figure 165. The rectangular body *BB* was of cast brass with an internal clear space 1.2 cm. wide, 8 cm. high, and 25 cm. long. Long, thick, rectangular rubber gaskets *r, r'* were placed on the inner rim, on which the glass plates *P, P'* reposed. The channel between the plate and the body was filled with resinous cement *cc*, poured in when molten and the brass body warm. The joint so made proved to be perfectly tight, though it was a little difficult to remove the plates for the change of needles, etc.

The needle *N* was supported by the quartz fiber *g*, surrounded by a glass tube, and the joint made by an annular cup *C*, into which melted cement was poured for sealing, as indicated in the figure. A similar cup-like contrivance sealed the torsion-head at the top of the tube. To turn the head, the wax was temporarily melted.

To mount the two shot (0.581 gram each and about 0.45 mm. in diameter) a phosphor-bronze wire, 22 cm. long, 0.64 mm. in diameter, and weighing 0.649 gram, was found to be adequate. The finished needle, with mirror and hanger, weighed 1.931 grams. The stem weighing but 0.0296 gram per centimeter, an allowance could be made for the gravitational attractions actuating it.

As the external weight, $M = 949$ grams, was the same as before, and the distances between centers 4.2 cm., as well as length of needle also, the double deflections Δy to be anticipated in comparison with the former apparatus would depend merely on the scale-distances from the mirror. This ratio was, with all allowances, about 0.7, so that the new deflections should not have been much smaller than the old. They were, however, 5 to 10 times smaller, showing that with the new needle and new location, radiation forces of enormous amount (relatively) had been eliminated.

The first experiments were made in a plenum of air. They are given in figure 166, the scale-readings of the chart (y) being taken at regular intervals about half an hour apart, both in the morning and afternoon. Even if we discard the readings on October 17, when the sun accidentally entered the room, the deflections are far from regular and there is considerable drift. Table 6 shows the mean double deflections (scale-readings) Δy in centimeters (scale-distance 261 cm.) for the mornings and afternoons of successive days. The

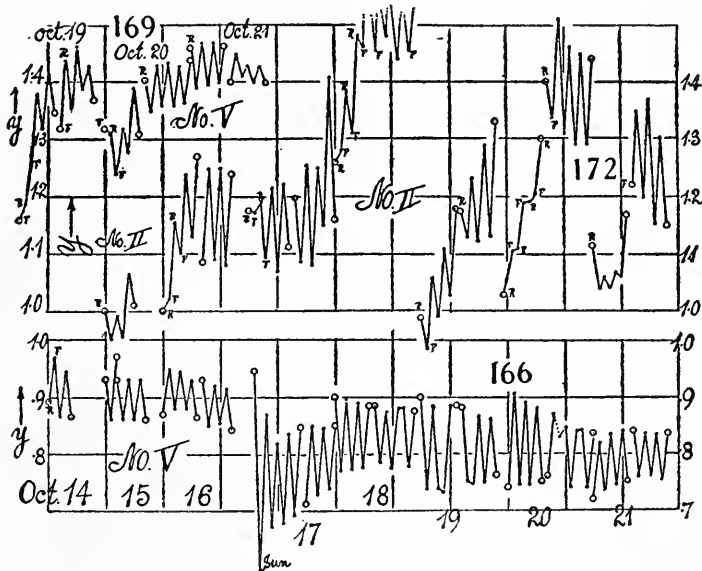

values are least on dark days and large on clear, sunny days, as in the work above. In spite of the filamentary shaft of the needle, therefore, the data are still quite unsatisfactory, ranging from 0.70 cm. to 1.5 cm., and in the morning they are usually larger.

The apparatus was now exhausted to about 1 cm. of mercury, and the experiment repeated in the same way. The new data (scale-readings y) are given in fig. 167, p. 138. The results are not only smaller in amplitude, but much more regular, showing that much of the radiation effect has been eliminated. Nevertheless, there is some drift in the lapse of time, to be attributed to radiation-pressure. The double amplitudes Δy in table 6, constructed graphically in fig. 168 (p. 137, on a tenfold larger scale), bear out the same inference. Δy varies

TABLE 6.—Values of double amplitudes Δy , mean per day.

<i>Apparatus IV.</i> $M=949$ grams; $m=0.581$ grams; $R=4.2$ cm.; $L=261$ cm.; $2l=21.9$ cm.; Bronze needle. Plenum.				<i>Apparatus IV.</i> Needle in vacuo.			
Date.	A. M. Δy	P. M. Δy	Remarks.	Date.	A. M. Δy	P. M. Δy	Remarks.
Sept. 14	-----	0.84	Dark day.	Sept. 24	-----	0.46	Sun.
15	0.90	.70	Do.	25	0.43	.41	Do.
16	.68	.72	Do.	26	.44	.45	Do.
17	1.90	1.28	Sun.	27	.44	.45	
18	1.18	.99	Do.	28	.45	.44	Dark.
19	1.48	1.17	Do.	29	.48	.46	Sun.
20	1.47	1.04	Do.	30	.41	.42	Rain.
21	.94	.78		Oct. 1	.39	.40	
				2	.45	.40	Steam heat off.
				3	.45	.44	
				4	.44	---	Do.
				5	.48	.43	
<i>Apparatus II.</i> $M=1,590$ grams; $m=0.600$ gram; $R=4.8$ cm.; $L=310$ cm.; $2l=22$ cm.; old needle.				<i>Apparatus II.</i> Needle with glass stem.			
Date.	A. M. Δy	P. M. Δy	Remarks.	Date.	A. M. Δy	P. M. Δy	Remarks.
Sept. 15	----	0.50	Dark.	Sept. 28	1.46	1.97	
16	1.07	1.61	Do.	29	1.48	2.38	
17	1.18	1.71	Sun.	30	1.69	3.40	Rain.
18	1.14	2.03	Do.	Oct. 1	2.40	1.48	
19	1.01	1.30	Do.	2	-4.06	1.06	Steam heat.
20	----	1.57	Do.	3	-2.57	1.05	
21	.24	1.58		4	-1.65	--	
<i>Apparatus V.</i> $M=1,490$ grams; old needle.				<i>Apparatus V.</i> (continued)			
Date.	A. M. Δy	P. M. Δy	Remarks.	Date.	A. M. Δy	P. M. Δy	Remarks.
Sept. 17	----	0.80		Oct. 1	0.44	0.55	
18	0.51	.55		2	.53	.39	
19	.90	.87		3	.40	.35	
20	.63	.69		4	.27	--	
21	.70	.33					
<i>Apparatus V.</i> Needle with glass stem.							
Date.	A. M. Δy	P. M. Δy	Remarks.				
Sept. 25	0.79	0.80					
26	1.19	1.01					
27	.92	.81					
28	.45	.54					
29	.64	.56					
30	.42	.40	Rain.				

between 0.39 and 0.45 (if the exceptional results are excluded), depending on changes of temperature outside of the laboratory. The two graphs, morning and afternoon results, as a whole are similar.

After removing the needle, the torsion coefficient of the quartz fiber was found by the vibration method, two small brass cylinders of moments of inertia $N=0.0498$ and 0.0486 being used in succession, the periods being $T=5.51$ and $T=5.39$ seconds. Unfortunately, both these data are rough, for it was found difficult to make the small cylinders rotate axially quite at will. Accepting the mean temporarily, the value of the constant γ may be then computed as

$$\gamma = \frac{\pi NR^2}{LT^2Im} \Delta y$$

from the double deflection Δy , if $R=4.2$ cm. is the distance between the center of the masses $M=949$ grams and $m=0.581$ gram, $L=261$ cm. the scale-distance, and $l=11$ cm. the semi-length of the needle. The mean value thus obtained was

$$\gamma = 10^{-8} \times 18.2 \Delta y$$

so that for $\gamma = 10^{-8} \times 6.66$ the deflection should have been 0.37 cm. Even the vacuum values are thus excessive, except on the dark days, September 30 and October 1; but it is probable that with allowance for the stem attraction, the data for Δy found will not be far from the correct values. At all events, it is clear that observations made with the needle *in vacuo* show deflections which are an enormously closer approximation to the truth than the plenum values, and that further pursuit along these lines will probably lead to trustworthy data. The mean a. m. and p. m. displacements were $\Delta y=0.44$ cm. and $\Delta y=0.43$ cm. This is an excess of less than 16 per cent, most of which is referable to the attraction of the stem of the needle, as appears in the next paragraph.

102. Torque exerted on the stem.—If the center of the mass M is at right angles to the needle of semi-length l , and at a distance R from it; if x be measured from the end of the needle to its center ($x=l$), and if dx be at a distance r from the center of M , it is easily seen that the torque will be

$$t = \gamma \int_0^l \frac{M \rho dx R}{r^2} \frac{r}{r} (l-x)$$

where ρ is the mass of stem per unit of length. The integral of this expression is

$$t = \gamma M \rho \left\{ \frac{lx}{R\sqrt{R^2+x^2}} + \frac{R}{\sqrt{R^2+x^2}} \right\}$$

or

$$t = (\gamma M \rho / R) (\sqrt{R^2+l^2} - R)$$

where the coefficient $\gamma M \rho / R$ is the total attraction in the direction R for a long needle.

If $T = (\gamma M m / R^2) l$, then,

$$\frac{t}{T} = \frac{\rho R}{lm} (\sqrt{R^2+l^2} - R)$$



For the given needle $\rho = 0.65/22 = 0.03$ gram per linear cm., $l = 11$ cm., $R = 4.2$ cm., $m = 0.58$ gram. Thus

$$t/T = \frac{0.03 \times 4.2}{11 \times 0.58} \left(\sqrt{17.6 + 121} - 4.2 \right) = 0.1452$$

Hence the discrepancy due to the attraction of stem of needle actually amounts to nearly 15 per cent of excess in γ .

If now we write $T = \gamma T'$, $t = \gamma t'$, and if τ is the modulus of torsion and γ' the above approximate constant,

$$\tau \frac{\Delta y}{2L} = \gamma' T' = \gamma (T' + t')$$

whence

$$\gamma = \gamma' \frac{1}{1 + t/T} = \frac{\kappa}{1 + t/T} \Delta y$$

where $\gamma' = \kappa \Delta y$. For κ the more accurate mean value of §104 should be inserted, viz, $\kappa = 10^{-7} \times 1.73$; while $t/T = 0.145$ and $\Delta y = 0.437$ (means in preceding paragraph). Hence

$$\gamma = \frac{10^{-7} \times 1.73 \times 0.437}{1 + 0.145} = 10^{-8} \times 6.60$$

This is within 1 per cent of a normal result, and in comparison with the original errors supplies the strongest evidence in favor of the exhaustion method pursued. But to rate the last result as to its trustworthiness, it is nevertheless necessary to consult figure 168 or the corresponding table on the individual values of Δy , which are quite variable. It seems, however, that in a series of results extending over a long time interval the radiation error is eliminated in the vacuum experiments.

103. Contemporaneous experiments.—To accentuate the importance of the vacuum method, a series of parallel observations were made at the same time with apparatus *V* and the old apparatus *II* (closed chamber of waxed wood). In the work with No. *V*, the glass case of No. *I* was again utilized in its old position, but a new quartz fiber was inserted. This was, unfortunately, thicker than was desirable. Tested with a small brass cylinder (mass 1.774 grams, diameter 0.474 cm.) of moment of inertia $N = 0.0498$, the period was found to be $T = 2.51$ seconds. Using the preceding equation, where now $L = 378$ cm., is the scale-distance from needle and $l = 11$ cm. the semi-length of the latter, $M = 1,490$ grams, $R = 4.24$ cm.,

$$\gamma = \frac{9.87 \times 0.0498}{378 \times 11 \times (2.51)^2} \frac{(4.24)^2}{1490 \times 0.59} \Delta y = 10^{-7} \times 3.84 \Delta y$$

Hence a deflection of only 2 mm. was to be expected.

The results in figure 169 are very much larger, the old straw-shafted needle of apparatus No. *I* being used. In fact, in the experiments of the first three days there was so much drift that they were thrown out. There is even an

abundance of drift in the last three days. Figure 170 gives the successive mean double deflections Δy , for a. m. and p. m. These deflections are three to four times too large on the average.

The straw shaft in apparatus No. V was now withdrawn and a needle with a slender glass shaft substituted. Its dimensions were: stem-length 22 cm.; diameter 0.1 cm.; weight 0.326; each shot 0.620 gram; total weight with mirror and hanger 1.573 grams. The readings made in a plenum of air are given in figure 171, p. 138. They are much more regular and there is less drift than in the straw-shaft experiments, so that some advantage has been gained, but not nearly enough. The double deflections given in table 6 and figure 170 show a curiously gradual approach to the correct value of Δy , but this is probably accidental. Even the final deflections are about twice too large on the average.

The experiments with the old apparatus II, also in its former location behind the pier, shut in on all sides but one by heavy brick walls within less than a meter, are shown for the straw-shaft needle in figure 172. They are very irregular and the drift is excessive. On September 21 (*R* and *F* refer to rear and front positions of *M*) there is an inversion. The data for Δy in figure 173 are equally erratic.

This needle was then replaced by one with a glass shaft, 22 cm. long, 0.1 cm. in diameter, and stem-weight 0.380 gram; the weight of each shot was 0.600 gram and the total weight of the needle 1.585 grams. The new readings given in figure 174 are even worse than the preceding. The values of Δy in table 6 are equally lawless with enormous inversions (*F* and *R* exchanged), meaning that repulsions are in excess.

It is extremely difficult to surmise why this apparatus, in what would be regarded an ideal location, in the dark and virtually constant temperature, should behave in this way; moreover, with the filamentary stem even at a disadvantage as compared with the straw shaft. Electrical charges in a damp basement room are hardly possible. It is more probable that the heavy walls are interchanging heat reservoirs and that the apparatus is in the midst of the radiation.

Tested with the brass cylinder, $N=0.0498$, the period of the fiber was $T=6.13$ seconds. The other quantities in the equation were $M=1590$ grams, $m=0.600$ grams, $R=4.8$ cm., $L=310$ cm., $l=11$ cm., so that

$$\gamma = 10^{-8} 9.26 \Delta y$$

Thus Δy should have been about 7 mm. Apart from drift, these low values were never reached, even with the straw shaft. Δy , moreover, was always markedly larger in the afternoon. In No. IV they were usually larger in the morning.

104. Filamentary needle.—I thought it desirable to carry the slenderness of needle one step further by making the stem out of the lightest wire possible.

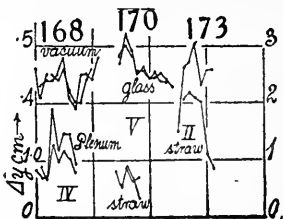

A resilient, straight bronze wire, $2l = 22$ cm. long, was selected for the purpose, 0.24 mm. in diameter and weighing 0.0044 gram per centimeter. This was trussed (fig. 175), at about one-fifth of the length from the end of the needle by a thinner brass wire, stretched from the top of the hanger and mirror support. As the truss was not sufficiently stiff, laterally, to support the two shots, ($m = 0.6295$ gram each), it had to be strengthened by a thin glass stem 0.47 mm. in diameter and 14 cm. long. This was tied on at its ends with fine silk thread

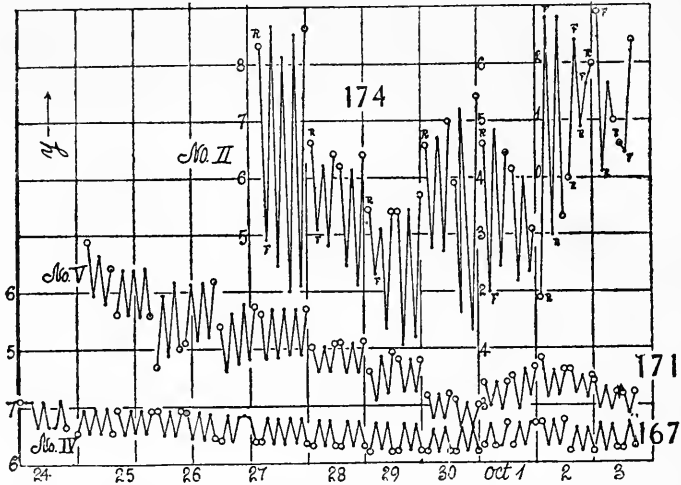

and a little wax. Hence the stem would offer no appreciable purchase to the radiant forces except (unavoidably) at the shot, which were about 4.5 mm. in diameter. The results showed that the limit had already been reached in the preceding needle, so far as the stem is concerned.

The constants* of the apparatus were thus

$M = 949$ grams. $m = 0.6295$ gram. $R = 4.3$ cm. $l = 11.0$ cm. $L = 261$ cm.

Tested by a small sphere (ball-bearing, diameter 0.633 cm., mass 1.0415 grams) of moment of inertia $N = 0.04173$, the slightly modified quartz torsion-fiber showed a period of $T = 5.06$ seconds. This, in the equation, § 101, makes

$$\gamma = 10^{-7} \times 1.735 \Delta y \quad \Delta y_0 = 0.384 \text{ cm.}$$

The same result was obtained with the needle itself vibrating *in vacuo*. The moment of inertia was here $N = 152.4$, to which 5.2 per cent were to be added to allow for the accessories (wire truss, hanger, and mirror). The period found was $T = 3.13$ seconds. This in the equation gives

$$\gamma = 10^{-7} \times 1.726 \Delta y, \text{ or } \Delta y_0 = 0.385 \text{ cm.}$$

In fact, it seems to me that with care as to the increments of N contributed by the parts of needle, this method is preferable, in spite of the tediousness of finding the long period.

* R and l were found by measurement with a distant telescope and a scale near Mm .

105. Observations.—The beginning and end of a series are indicated by circles. These were made on the same plan as above, readings, y , being taken at intervals about 30 minutes apart, and they are given in figure 176. The double amplitudes, Δy , are shown in figure 177. The circles distinguish a. m. and p. m. means. The observations in a steam-heated room with its variable temperature (20° to 30°) would be inadmissible; but here, where a test is aimed at, this change of temperature is even desirable. At the outset a few observations were taken for a plenum of air. These have the usual excessive value, being on the average $\Delta y = 2.1$ cm. for the morning and $\Delta y = 1.6$ for the afternoon periods. It should be $\Delta y = 0.38$ cm. The smaller values of Δy occur when the steam heat is shut off.

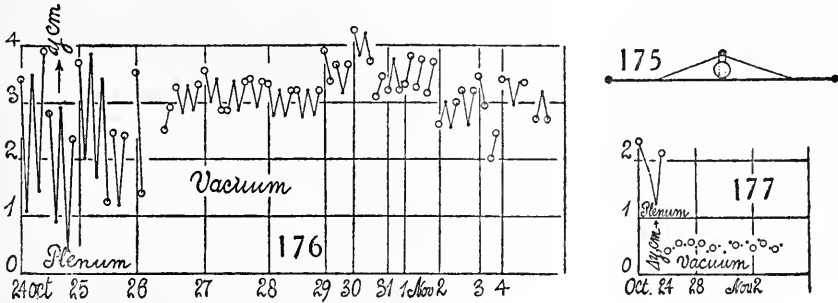

The observations for the needle *in vacuo* (fig. 176) lie in different regions, for the reason that a number of adjustments had to be made at the distant telescope and scale. These moved from day to day as the temperature of the room varied, without, however, affecting the differences or double amplitudes Δy . The latter (fig. 177) have a definitely larger value as a whole than in the preceding paragraph, ranging here from $\Delta y = 0.37$ cm. (rare) to $\Delta y = 0.55$, if we discard the exceptional value (0.66) obtained with a open window. The mean values in the morning were $\Delta y = 0.49$ cm. and in the afternoon $\Delta y = 0.47$ cm. Both are much too large (nearly 30 per cent) and the curve of successive values of Δy is inadmissibly meandering. The mean summer data of the preceding paragraph for the same apparatus (IV) and location were $\Delta y = 0.44$ cm. in the morning and $\Delta y = 0.43$ cm. in the afternoon. The effect of a heated room is thus an increment from $\Delta y = 0.43$ to $\Delta y = 0.48$. Moreover, in the latter case there is no equally appreciable correction for stem attraction as in the former. Vacua from 0.6 cm. to 6 cm. were employed, but no difference was detected attributable to this cause. Obviously, the radiant forces now impinge on the shot, the thin stem of the needle having no advantage over the preceding cases.

106. The residual radiant forces. It is interesting to inquire as to the amount of pressure variation and velocity of air-currents implied in the estimate for radiant forces. The energy equation may be written, if $(\rho - \Delta\rho) = \rho$ nearly,

$$\Delta p = \rho(\Delta v)^2 / 2$$

where Δp is the decrement of pressure and Δv the corresponding increment of the velocity of air (from rest) at constant energy. If a is the sectional area of the shot and f the radiant force, K its value in terms of the contemporaneous gravitation force, it follows further that $\Delta p = f/a$, and, therefore,

$$(\Delta v)^2 = K\gamma \frac{2Mm}{a\rho R^2}$$

For a plenum of air ($\rho = 0.0013$ and $a = 0.16$ cm².) this comes out as $(\Delta v)^2 = K \times 0.021$. Thus, if $K = 5$, Δv is about 3 mm. per second and $\Delta p = 6 \times 10^{-5}$ dyne per cm.²

In the experiments *in vacuo*, however, K has decreased to 0.3 and ρ to about $0.001293/76 = 0.000017$. Thus $(\Delta v)^2 = K \times 0.021 \times 76$ or $\Delta v = 0.7$ cm./sec., while Δp is but $10^{-6} \times 4.1$ dynes/cm². That currents of 7 mm. per second should be possible is difficult to conceive; but the momentum ($v\rho$) carried for the present case and the plenum is in the ratio of $\frac{7 \times 1}{3 \times 76} = 0.03$, which accounts for the advantage of the vacuum.

CHAPTER XII.

MISCELLANEOUS EXPERIMENTS.

I. HEAVY GRAVITATIONAL SYSTEMS.

107. Attractions in case of a heavy needle.—The above gravitational experiment had to be discontinued when the steam heat was turned into the building. It seemed worth while, however, to make a few tests with a needle so heavy, that the radiant forces might be small in comparison with the gravitational attractions. Here, moreover, the air resistances to the motion of the needle could possibly be disregarded, and the excursions, therefore, treated as a case of nearly uniformly varied motion, resulting from gravitational attraction.

108. Apparatus.—The apparatus for this purpose had the usual form (fig. 178), MM' being two heavy balls of lead, each weighing about 1,500 grams originally. They were counterpoised in suspension from the three-eighths-inch aluminum tube RB' , effectively $R = 29.3$ cm. long. This was supported by the thin brass tube t and brass sleeve s , with an appropriate brace of bronze wire b . The torsion-wire w , of thinnest hand-drawn steel (music wire), was adjustably attached above to a torsion-head, anchored in the pier and below to the tube t . By passing w around the threads of a fine screw above on the torsion-head, the needle could be raised and lowered at pleasure. The length of the wire was 154 cm. and its diameter about 0.022 cm. Tested with a variety of brass cylinders of known moments of inertia, the torsion coefficient was about $\tau = 154$ in the original installment.

The apparatus was surrounded (except as to the wire w) by a closely fitting glass case. Care was taken to avoid steel or iron in moving parts. The attracting mass corresponding to M was on the outside of the case and moved easily on a circular track, as in the earlier work.

To read off the deflections, a small mirror m , with telescope and scale at a distance of $R' = 290$ cm. was first adopted. To use the interferometer it was merely necessary to replace m by a silvered strip of thin glass plate; for small additions of weight are here of little consequence.

Hence the force by which M is drawn from without will be

$$F = \frac{\tau}{R} \frac{s}{2R'} = \frac{154}{29.3 \times 2 \times 290} s = 0.00905s$$

where s is the deflection in centimeters.

If we estimate the moment of inertia of the needle as $2 \times 1,500 \times 30^2 = 2.7 \times 10^6$, the period should be about 14 minutes. We may therefore assume that the period will not exceed 15 minutes in interpreting the excursions.

The gravitational force for an attracting weight of the same value ($M = 1,500$ grams and 6 cm. between centers) would be roughly

$$F = 6.8 \times 10^{-8} \quad 1,500^2 / (6)^2 = 4.2 \times 10^{-3} \text{ dyne}$$

Thus the deflection would be

$$s = \frac{4.2 \times 10^{-8}}{9 \times 10^{-7}} = 0.47 \text{ cm.}$$

which, on being doubled by commutation, is a little short of a centimeter. A tenth millimeter of the scale is thus 1 per cent. The wire, however, would be capable of sustaining much larger weights and the external mass could be increased at pleasure.

On the quadratic interferometer with achromatic fringes, if b is the breadth of the ray parallelogram, i the inclination of mirrors to rays, ΔN the play of the micrometer, the angle $s/2R'$ of the needle corresponds to

$$b(s/2R') = \Delta N \cos i$$

If $b = 10$ cm. and $i = 45^\circ$, therefore $(2(s/2R') = 0.94)$

$$\Delta N = \frac{10 \times 0.94}{0.707 \times 580} = 0.023 \text{ cm.}$$

which may be read to 10^{-1} cm. directly or to 4×10^{-5} per fringe. With good fringes the accuracy, so far as mere reading is concerned, should be within 0.1 per cent.

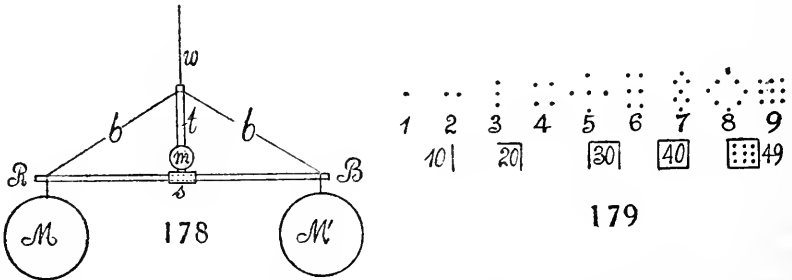

When the telescope and scale are used, the divisions at a long distance are still sharp, but it is often difficult to clearly distinguish the small numbers. For this reason I used the notation shown in figure 179. These dots may easily be put on a glass or other scale in any size, with a sharp pen and india ink. They are very clear at all distances. They have the further advantage that they are equally serviceable, whether the scale be upside down or reversed right to left.

109. Observations.—The chief purpose of the observations in the cold season was to determine the effect of the steam-heated room on the degree or quiescence of so heavy a needle, weighing over 3 kilograms. In the earlier work the absence of iron in the framework was not considered, and the data, though of the same character, were discarded; but the lead-aluminum needle behaved not much better. The hand-drawn steel wire, however, disclosed a second discrepancy of considerable interest, incidentally, as it showed marked

viscous deformation, due to residual torsional strain. Figure 180 is an example, observations being taken several times a day, for as many days as the essential narrowness of the case permitted.

Apart from the daily kinks, the curve shows steady progress at a rate of about 0.08° of torsion per day. The wire, in other words, develops torque at the rate of about 0.21 dyne-cm. per day, wholly as the result of the breakdown of unstable molecular groups which promote viscous deformation. How the wire acquired this concealed torsional strain is hard to understand. It could not have developed out of the intense tractional strain which it carries, for there would be no reason to account for the particular direction of rotation. The wire had been reeled on a drum with a diameter of about 8 inches; it is probable, therefore, that it was reeled helically, or in a way to impart a permanent twist, allowing the intense tensile strain to develop a torsional strain in the lapse of time. The free wire resting on a plane assumed a screw shape

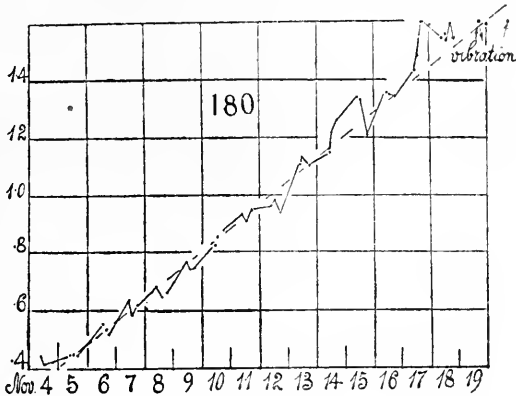

with a pitch of about 2 feet. Under the heavy weight M , the steel wire is at relatively low viscosity; for this implies accentuated continuous breakdown of molecular groups, and therefore greater facility for the exit of the set torsional strain.

The reason to be given for the kinks in the curve is more uncertain. The telescope and scale were attached to one of the ground walls in the basement of the building; but this does not imply complete freedom from thermal and other discrepancies. Again, interferences at the suspension, induced by tremors in the building, might put the needle in slow vibration. Finally, the possibility of radiant forces, from the closely fitting case surrounding the needle and from the lead weight, can not at once be dismissed, without measurement. Probably all these factors enter, and the average discrepancy is about as large as the gravitational attraction (on the side) to be measured. Unless immense masses of lead are used on the outside, the experiment has little to recommend it, even though it is here performed under the unfavorable conditions of a steam-heated room. With regard to the graph, figure 180, it appears that the increase of irregularities (which become more marked as the room is more vigorously heated) is accompanied by correspondingly increased

slow vibration of the needle. It follows, therefore, that in spite of the large masses used, the radiant forces are by no means negligible, even in the present cumbersome experiment.*

Finally, it is interesting to note, since the torque is $T=0.26s$, the angle $\theta=0.0017s$, and the daily detorsion $s=0.8$ cm., that energy is being dissipated at the rate of $T\theta/2$, or 0.00014 erg per day, by this slight torsional strain alone. Much more is doubtless released by the decay of the intense traction (wire-drawn) which the wire carries. If the metal were not exceedingly opaque it would probably be phosphorescent.

II. THE TORSIONAL MAGNETIC ENERGY ABSORPTION OF AN IRON CONDUCTOR.

110. Apparatus.—The relations of torsion and magnetization have been studied by Wiedemann, Auerbach, and many others since, chiefly in longitudinal fields. The torsion effect produced by a circular field is very small and difficult to ascertain; therefore, I thought it of interest to make some measurements of this kind, using the displacement interferometer and achromatic fringes. The results were very definite and would easily have admitted of precision. The apparatus is shown in figure 181, where AB is a thin low-carbon steel tube, effectively 55 cm. long, having an average diameter of 0.875 cm. and walls 0.076 cm. thick.

The tube is firmly clutched below by a clamp, but free above. It carries the mirror mm' , which is a strip of thin plate glass, silvered, and slightly adjustable about vertical and horizontal axes. The ends receive the component rays of the interferometer, so that any slight rotation of mm' about the vertical axis is at once registered by the displacement of fringes. Finally, a strong electric current may be passed through the length of the tube, entering at A and leaving by the mercury cups C . The current must be reversible at pleasure.

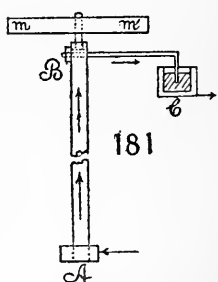

111. Observations.—The fringes are displaced (*i. e.*, the tube receives magnetic set) immediately after closing the circuit. Closing it any number of times thereafter is ineffective, to the fraction of a fringe. There is practically no temporary effect. On reversing the current, the fringes are markedly displaced in the opposite direction, again, to hold the new position, however often, the current is made and broken thereafter. The effect of reversal is static and may be repeated indefinitely.

To obtain a temporary effect, I surrounded AB with a massive iron tube, about 6 inches long and 2 inches in diameter, clamped at the top B , but otherwise free from it. Even now, with currents up to 20 amperes, I observed no temporary effect in excess of the quiver of the fringes.

*The relatively large temperature coefficient of torsional viscosity is also effective. Similarly, the thermal changes of rigidity reciprocate with the concealed torsional stress.

The following data were obtained for the fringe displacement ΔN , showing the permanent effect of reversing current.

3 amperes, $\Delta N = ?$ 10 amperes, $\Delta N = 0.00031$ 20 amperes $\Delta N = 0.00065$

Below 3 amperes I was unable to observe a displacement. For larger currents the twist increases proportionally to the current passing the tube. It is probable that here, as in similar cases in magnetization, fields below a certain small value are ineffective, as though there were static friction.

A further observation is to be made. If a certain magnetic set is produced by a stronger current (say 20 amperes), then a weaker current (say 10 amperes) is unable to modify it, provided both currents are in the same direction. If this weaker current is reversed, the change of twist corresponding to the current will appear. The absolute value of the set thus depends upon the past history of the iron, however varied this may have been, with the understanding that the set produced by the maximum current in either direction is characteristic of the strength of that current. Differential values, in other words, remain the same.

112. Data.—Finally, the numerical equivalents of the observations made may be stated. The elastic torsional coefficient for a tube of the dimensions given may be computed with the usual equation, using the differential form $dT/dr = 2\pi r^3\theta/l$ with the mean radius r and length l and taking the rigidity n as 8.2×10^{11} . If T is the torque corresponding to the twist of θ radians, the relation was found to be $T = 10^9 \times 4.7\theta$.

On the interferometer, if the breadth of ray parallelogram is $b = 10$ cm. and $\Delta\theta$ is the rotation of the mirror mm' around a vertical axis corresponding to the displacement of mirror ΔN (the mirror being at $i = 45^\circ$ to the rays) the relation will be $\Delta\theta = 0.071 \Delta N$, since $\Delta\theta = \Delta N \cos i/b$. Hence, if we assume that the resistance to magnetic set is the same as the elastic resistance for the same twist $\Delta\theta$, the above values of ΔN will correspond to the following data:

Current.	$\Delta N \times 10^5$	Torque $\times 10^{-5}$	Energy.	$E/\text{vol.}$
10 amperes	31 cm	1.03	1.13 ergs	0.10
20 amperes	65	2.16	4.97	0.43

The energy E potentialized by the magnetic set is computed as $T\Delta\theta/2$. From the volume of iron in the tube, 11.5 cm^3 , the data of the last column follow.

My conception of this phenomenon is that of two concentric circular fields in opposite directions, one within, the other on the outside of the tube, introducing a rather intense vortex sheet in the thin walls of the tube, in which the circular fields terminate.

113. Longitudinal field.—The longitudinal strain produced by a longitudinal field is well known. The question may be asked whether, in this case, in a free iron bar there is any corresponding torsion. This was easily answered by slipping a helix over the steel tube. Feeding it with I amperes, the micrometer displacement ΔN was successively

$I =$	1.5	4.5	9.4	1.5 am.
$10^5 \Delta N =$	15	10	10	5 cm.

This means, no doubt, that the residual torsion left by the last experiments is being gradually eliminated by the longitudinal field. For the relation to I is merely that of a decay. The field of the helix was $H = 27i$ within, but it covered less than one-half the tube. At 10 amperes the mean field was probably less than 100 gauss. Nevertheless, I can not assert, in the lapse of time and many applications, to have quite eliminated the torsion strain. A persistent displacement of one or two fringes (set) may have remained to the end, with each reversal of current; for violent commotion due to the longitudinal strain here interferes with the measurement.

III. LIQUID REFRACTION NEAR A SOLID SURFACE.

114. Methods and first experiment.—An interesting discovery has recently been announced by Mr. F. Twyman (*Nature*, Nov. 20, 1919, p. 315, vol. 104), indicating a marked increase of the index of refraction of certain liquids at the surface of contact with a polished glass surface. As the method of experiment is not given, I was induced to make a few trials with the same end in view, with the aid of the self-adjusting interferometer which happened to be available. The advantage here is this, that separate installments are immediately possible and require no long searching for fringes and that the latter may be had in any size. At the same time, there is sufficient ray separation possible for all purposes of the present kind.

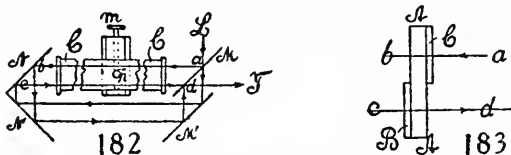

The interferometer is shown in figure 182, receiving light at L , reflected by the four mirrors M, M', N, N' , and observed in a telescope at T . CC is a long (15 cm.) metallic cell about 1.5×1.5 cm.² in square section, with plate-glass faces at the ends. Through it pass the two component rays ab, cd , of the interferometer. The liquid is introduced through a small hole h in the top of the cell, closed by a glass plate.

The cell CC is on a horizontal micrometer m , so that it may be moved transversely to the rays ab, cd . By this means either one or the other of these rays is brought as near the metallic edge of the cell as desirable, until the fringes disappear with the extinction of the ray, the other being alone in the field.

I examined benzol and ether but in neither case was there the slightest slipping of fringes with the motion of the micrometer-screw m , up to the point at which they vanished. The experiments were varied in many ways which need not be detailed here. I did not, however, expect any positive result from

this experiment, seeing that the range within which any such capillary effect would be active would probably be too narrow to admit of visible fringes, even for a thin blade of light at L .

115. Second experiment.—The next experiment was more promising. The cell CC in figure 182 was removed and replaced by a plate of glass AA , figure 183, normal to the rays ab, cd . This is without effect on the fringes. Two strips of glass B and C of identical thickness were then mounted on opposite sides of AA and held in place by wooden clips. Through them the rays ab and cd , respectively, passed. The strips BC are without effect on the fringes if AA is firmly clamped in a vertical plane.

If, however, a drop of water or other liquid is placed at the plane of contact of one strip only (at CA , for instance), the fringes are immediately displaced in view of the entrance of a capillary film of liquid between A and C . Even without any spacing inserted between C and A , the displacement is quite large, four fringes for instance.

These experiments are necessarily made with the achromatic fringes, since the displacement is practically instantaneous. They may be obtained in any size by rotating the mirrors N, N' , or both, around a horizontal axis. A vertical axis is necessary to secure coincidence of slit-images. The rays ab, cd may be separated at pleasure by sliding the mirrors M, M' (together) in the direction of the rays. The fringes are necessarily horizontal and the index obtained holds for mean wave-length. True, with the use of the spectro-telescope the corresponding spectrum fringes are immediately at hand; but it would not be easy to determine their displacement, even with the clue given by the achromatics.

For guidance as to the quantitative relations, the equations of the last report* may be used. If one of the films is air, the index $\mu = 1 - 2B/\lambda^2$ of the liquid, at the wave-length λ , for a thickness of liquid film e , is

$$(1) \quad \mu = 1 - 2B/\lambda^2 + C \Delta x/e^2$$

where C is the constant of micrometer when its displacement reading is Δx ; so that for n fringes

$$(2) \quad n\lambda = C\Delta x$$

Δx may be in arbitrary units, like those of the Billet wedge micrometer, for instance. The usual value of the factor C is of the order of $C = 3 \times 10^{-4}$. Hence in equation (1), $\mu - 1 + 2B/\lambda^2$ being constant for a given liquid and λ , Δx is proportional to e . If the parenthesis is taken as 0.6, for instance, Δx is 500 times larger than e . Again, on differentiating (1) apart from details

$$\delta\mu = C\delta x/e$$

and if δx is one scale-part, $e\delta\mu = 3 \times 10^{-4}$; or

$e =$	0.3	0.03	0.003 cm.
$\delta\mu =$	10^{-3}	10^{-2}	10^{-1}

*Carnegie Inst. Wash. Pub. No. 249, Part IV, p. 81. 1919.

Thus as 0.1 scale-part is given by the vernier, a film 0.03 mm. thick should still insure an accuracy of one unit in the second place of μ . Moreover, if $\delta x = 1$, the number of fringes is

$$N = C/\lambda = (3 \times 10^{-4}) / (6 \times 10^{-5}) = 5$$

A fringe thus corresponds to 0.2 scale-part and is again capable of being subdivided.

Tests would, therefore, be narrowed down to finding in what degree

$$\delta x/x - \delta e/e$$

is persistently zero, or $\delta x/\delta e$ constant, as e decreases indefinitely. It is again improbable that the interferometer will register a sufficiently small e .

An experiment made on the difference of an air-and-water film, figure 183, devoid of spacing, showed $\Delta x = 0.6$ to 0.7 scale-part. On standardizing the fringes, it was found that 5.8 fringes came to the scale-part. Hence the increase $\delta\mu$ of refraction due to the film is equivalent to $0.65 \times 5.8 = 3.8$ fringes. If for water $\delta\mu = 0.33$, equations (2) and (3) give us

$$e = \frac{n\lambda}{\delta\mu} = \frac{3.8 \times 6 \times 10^6}{0.33} = 7 \times 10^{-4} \text{ cm.}$$

BA and CA , figure 183, not being optic plate, do not approach closer than this. The strips were now left in place and a film of air and ether and water were compared in succession. In this case it was possible to see the ether evaporate while the fringes changed from the air to the ether position. The water does not so easily evaporate between the plates of glass, hours being necessary before it is gone. The mean results of four experiments, each corresponding to fixed plates, were

$$\text{Ether, } \Delta x = 1.10 \qquad \text{Water, } \Delta x = 0.99$$

We may with the above equations (approximately) put

$$\frac{\Delta x}{\Delta x^1} = \frac{\mu - 1}{\mu' - 1} = \frac{0.333}{\mu' - 1}$$

So that for ether $\mu = 1.37$. This is quite as near the actual index of ether ($M = 1.36$) as the work with such thin films will admit. And yet the films are not thin enough, probably, to suggest an increase of μ , as a result of the Twyman surface effect. The interferometer, so far as I see, is thus not adapted for work of this kind.

IV. COMPARISON OF TWO INDEPENDENT SETS OF FRINGES.

116. Apparatus.—This experiment was also made with the self-adjusting interferometer, for the purpose of obtaining two juxtaposed sets of fringes, of nearly the same size, one pair being used as a sort of vernier on the other. If converted into overlapping spectrum fringes, these should appear and vanish periodically. Another method is given in §62.

The apparatus is shown in figure 184, where MM , NN' are vertical mirrors (N' half-silvered), L , L' two sources of white light, C a Billet wedge compensa-

tor, T the telescope. The rays from L follow the paths $a'bab'$ and $b'aba'$ and again emerge toward L , but are caught in part and reflected by the plate of glass m and sent to T . The same is true of the rays from L' . Hence four rays pass the side of the ray rectangle and interfere in pairs at T . By moving the set of mirrors NN' bodily right or left, these rays may be separated into two pairs of two rays each, passing the corresponding plates of the compensator C . The observer at the telescope T sees two vertical slit-images, which may be adjusted to lie exactly side by side with their near edges just touching. Each carries its horizontal achromatic interferences, nearly but not quite of the same size, since the glass-paths of the two rays will not, in general, be rigorously the same. Hence, in moving the screw of the compensator C , introducing a difference of glass-paths, the two sets of fringes move in the same direction, but are only periodically horizontal prolongations of each other. With the achromatics 1 to 3 complete phase reversals were thus producible within the vertical limits of the slit-image. The experiment succeeded best with sunlight and short collimators close at hand, giving high slit-images.

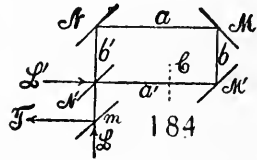

To make the experiment more useful, the four rays should be separated, so that if path-difference is introduced into one pair and not into the other, the result may be accentuated. To do this requires a broader Billet compensator than I possessed or a special device, and I did not therefore carry it out.

The horizontal spectrum fringes, even if from a wide slit, require much light, particularly in view of the plate-glass m . Sunlight with a condenser lens of long focus is necessary for clearness. The two sets of fringes are then merged in the same banded spectrum and alternately strengthen or destroy each other.



DISPLACEMENT INTERFEROMETRY APPLIED TO ACOUSTICS AND TO GRAVITATION

By CARL BARUS

*Hazard Professor of Physics and Dean of the Graduate Department
in Brown University*



PUBLISHED BY THE CARNEGIE INSTITUTION OF WASHINGTON
WASHINGTON, 1921

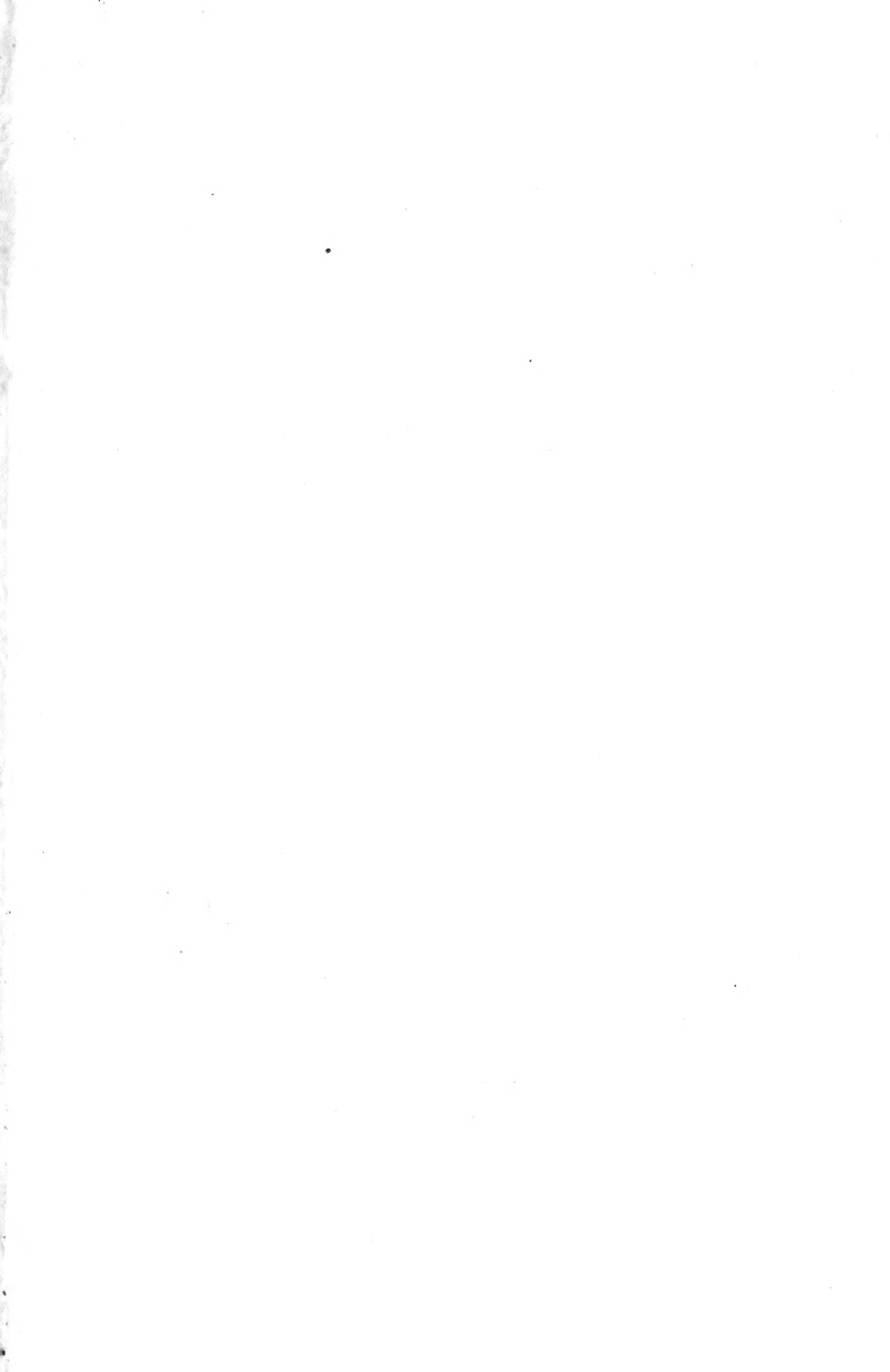



MBL WHOI LIBRARY



WH IBL Y R

