

# HYDRATES IN AQUEOUS SOLUTION.

EVIDENCE FOR THE EXISTENCE OF HYDRATES IN SOLUTION,  
THEIR APPROXIMATE COMPOSITION, AND CERTAIN  
SPECTROSCOPIC INVESTIGATIONS BEARING  
UPON THE HYDRATE PROBLEM.

BY

HARRY C. JONES,  
PROFESSOR OF PHYSICAL CHEMISTRY IN THE  
JOHNS HOPKINS UNIVERSITY.

WITH THE ASSISTANCE OF

F. H. GETMAN, H. P. BASSETT, L. McMASTER, AND H. S. UHLER.



WASHINGTON, D. C.  
PUBLISHED BY THE CARNEGIE INSTITUTION OF WASHINGTON.  
FEBRUARY, 1907.

CARNEGIE INSTITUTION OF WASHINGTON.

PUBLICATION No. 60.

3418

PRESS OF GIBSON BROS.  
WASHINGTON, D. C.

## PREFACE.

This investigation is the outcome of an observation made in this laboratory in connection with an entirely different line of work. A Japanese, Ota, was working on the condition of certain double salts in the presence of water, to ascertain whether they existed as such, to any appreciable extent, or were broken down by the solvent into the constituent molecules. As soon as he began to work with concentrated solutions, he found that these solutions froze abnormally low; the molecular lowering passing through a well-defined minimum with change in concentration. Similar results were obtained a little later by Dr. Knight, also working in this laboratory.

There was nothing in the theory of solutions then in vogue to account for such results—the molecular lowering should decrease continually from the most dilute to the most concentrated solution. This was obviously a remarkable phenomenon, especially if it should be shown to manifest itself in the case of any large number of substances.

With the aid of three Grants generously awarded by the Carnegie Institution of Washington, this investigation has been extended step by step to about one hundred substances; including typical acids, bases, salts, and neutral organic compounds. The result has been to show that this is a *general property of solutions*, manifesting itself to a greater or less extent for nearly all of the substances studied.

Having established the general fact, it remained to ascertain its meaning. A possible explanation that occurred to me early in the investigation was that in solution a *part of the solvent is combined with the dissolved substance*, and no longer plays the rôle of solvent, at least as far as the freezing-point method is concerned. As the concentration of the solution increased, more and more of the solvent would be held in combination by the dissolved substance. This suggestion would account for the experimentally established facts. It, however, remained to show that it was true.

No less than *four distinct lines of evidence* have been furnished experimentally, all of which point to the correctness of this theory. Perhaps the most important of these, and the most general, is the relation between lowering of freezing-point and water of crystallization. This relation is so unmistakable, and bears so directly on the problem, as we shall see, that it is difficult to lay too much stress upon it.

The relation between amount of water of crystallization and temperature is also very significant in the present connection, as well as the evidence from the study of the absorption spectra.

The conclusion from all of this work is that, as far at least as aqueous solutions are concerned, a part of the water is combined with the dissolved substance, the amount being a function primarily of the nature of the substance, but for any given compound is a function of the concentration and temperature.

If a portion of the solvent is combined with the dissolved substance, it is a matter of interest and importance to know what portion. This is not a simple problem, but an approximate solution of it is possible. By determining the *freezing-point*, the *conductivity*, and the *specific gravity* of the solution, we are enabled to calculate approximately the total amount of water held in combination by the dissolved substance, and, therefore, the approximate amount combined with one molecule of the compound or the ions resulting from it. These results are necessarily only approximate, since in this calculation certain assumptions have to be made that are not rigidly true; notably, the validity of Raoult's law for concentrated solutions.

Notwithstanding these assumptions it seems probable that the composition of the hydrates as calculated is of the right order of magnitude, and this is all that can be claimed at present. These results are of some importance as showing at least the relative hydrating power of the different types of compounds.

The fact that while the total amount of water held in combination increases with the concentration, the amount combined with one molecule, or the resulting ions, increases with the dilution, would argue that the ions have the greater hydrating power. In the most dilute solutions there are very few molecules present, nearly all of them having been broken down into ions. In such solutions we have the greatest hydration, consequently, the ions have greater hydrating power than the molecules. That molecules, however, can combine with water is shown by the fact that some non-electrolytes, such as glycerol and cane-sugar, show marked hydration.

The present theory of hydrates differs fundamentally from the older theory proposed by Mendeléeff, in that according to the latter certain compounds, such as calcium chloride, sulphuric acid, and the like, form a few definite compounds with the water in which they are dissolved. According to the present theory, combination between the dissolved substance and water is a general phenomenon; and a given compound, say calcium chloride, forms a complete series of hydrates ranging in composition from a few molecules of water to at least thirty—every intermediate stage being represented. It is thus obvious that the two theories are vitally different.

The question still remains as to whether the property of combination between the dissolved substance and solvent is perfectly general, or is limited



to water as a solvent. Some little work has already been done on this portion of the problem, as will be seen, in which methyl and ethyl alcohols have been used. The results thus far obtained would indicate that certain substances at least, such as lithium chloride, lithium bromide, and lithium nitrate, when dissolved in the alcohols, combine with more or less of the solvent.

It will require a larger amount of work, which is now in progress, to settle the question of *solvation* in general.

HARRY C. JONES.



## CONTENTS.

	PAGE.
INTRODUCTION.....	1
Work of Chambers.....	1
Work of Chambers and Frazer.....	3
Earlier Work of Getman.....	3
Freezing-point Apparatus.....	4
Conductivity Apparatus.....	5
Solutions.....	7
Freezing-point Method.....	7
Conductivity Method.....	8
Boiling-point Method.....	8
Refractivity Method.....	8
Substances Employed in Earlier Work.....	9
Results Obtained in Earlier Work.....	9
Conclusions from the Earlier Work.....	14
WORK OF GETMAN AND BASSETT.....	16
EVIDENCE FOR THE EXISTENCE OF HYDRATES.....	17
Effect of Temperature on Water of Crystallization as Bearing on the Theory of Hydrates in Solution.....	17
Relation between Water of Crystallization and Lowering of Freezing- point.....	20
Experimental Work.....	26
CALCULATION OF THE APPROXIMATE COMPOSITION OF THE HYDRATES.....	28
The Results.....	28
COMPOUNDS THAT HAVE BEEN STUDIED.....	30
Lithium Chloride.....	30
Lithium Bromide.....	31
Lithium Iodide.....	32
Lithium Nitrate.....	32
Sodium Chloride.....	33
Sodium Bromide.....	34
Sodium Iodide.....	35
Sodium Nitrate.....	36
Sodium Sulphate.....	36
Sodium Carbonate.....	37
Sodium Chromate.....	37
Sodium Dichromate.....	38
Sodium Phosphate.....	39
Sodium Ammonium Acid Phosphate.....	40
Sodium Acetate.....	41
Sodium Hydroxide.....	41
Potassium Chloride.....	42
Potassium Bromide.....	43
Potassium Iodide.....	43
Potassium Nitrate.....	44
Potassium Sulphate.....	44
Potassium Dihydrogen Phosphate.....	45

## WORK OF GETMAN AND BASSETT—Continued.

## COMPOUNDS THAT HAVE BEEN STUDIED—Continued.

Potassium Carbonate.....	45
Potassium Ferrieyanide.....	46
Dissociation of Potassium Ferrieyanide.....	46
Potassium Ferroeyanide.....	46
Dissociation of Potassium Ferroeyanide.....	47
Potassium Hydroxide.....	48
Potassium Cuprie Chloride.....	49
Ammonium Chloride.....	50
Ammonium Nitrate.....	51
Ammonium Sulphate.....	51
Ammonium Cuprie Chloride.....	52
Ammonium Hydroxide.....	53
Calcium Chloride.....	54
Calcium Bromide.....	55
Calcium Iodide.....	57
Calcium Nitrate.....	58
Strontium Chloride.....	58
Strontium Bromide.....	59
Strontium Iodide.....	60
Strontium Nitrate.....	61
Barium Chloride.....	62
Barium Bromide.....	63
Barium Iodide.....	64
Magnesium Chloride.....	65
Magnesium Bromide.....	67
Magnesium Nitrate.....	68
Magnesium Sulphate.....	69
Zinc Chloride.....	70
Zinc Nitrate.....	70
Zinc Sulphate.....	71
Cadmium Chloride.....	72
Cadmium Bromide.....	72
Cadmium Iodide.....	72
Cadmium Nitrate.....	72
Cadmium Sulphate.....	73
Manganese Chloride.....	73
Manganese Nitrate.....	75
Manganese Sulphate.....	76
Nickel Chloride.....	76
Nickel Nitrate.....	78
Nickel Sulphate.....	79
Cobalt Chloride.....	80
Cobalt Nitrate.....	82
Cobalt Sulphate.....	83
Copper Chloride.....	84
Copper Nitrate.....	85
Copper Sulphate.....	86

## WORK OF GETMAN AND BASSETT—Continued.

PAGE.

## COMPOUNDS THAT HAVE BEEN STUDIED—Continued.

Aluminium Chloride . . . . .	87
Aluminium Nitrate . . . . .	88
Aluminium Sulphate . . . . .	88
Chromium Chloride . . . . .	89
Chromium Nitrate . . . . .	90
Ferric Chloride . . . . .	91
Ferric Nitrate . . . . .	92
Hydrochloric Acid . . . . .	93
Hydrobromic Acid . . . . .	94
Nitric Acid . . . . .	96
Sulphuric Acid . . . . .	97
Chromic Acid . . . . .	98
Phosphoric Acid . . . . .	100
Methyl Alcohol . . . . .	101
Ethyl Alcohol . . . . .	102
N-Propyl Alcohol . . . . .	103
Acetone . . . . .	104
Acetamide . . . . .	104
Urea . . . . .	105
Chloral Hydrate . . . . .	105
Glycerol . . . . .	106
Glucose . . . . .	107
Fructose . . . . .	107
Mannite . . . . .	108
Lactose . . . . .	109
Cane-Sugar . . . . .	109
Organic Acids . . . . .	110
Acetic Acid . . . . .	110
Oxalic Acid . . . . .	112
Succinic Acid . . . . .	113
Tartaric Acid . . . . .	114
Citric Acid . . . . .	115
Freezing-point Curves . . . . .	116, 117, 119, 120, 121, 122, 124, 125, 127, 128, 133, 134
Conductivity Curves . . . . .	117, 118, 119, 120, 121, 123, 124, 125, 127, 129
Refractivity Curves . . . . .	118, 122, 123, 125, 126, 128, 129
Hydrate Curves . . . . .	130, 131, 132, 134
DISCUSSION OF THE RESULTS . . . . .	135
General Relations . . . . .	142
Nature of the Compounds formed . . . . .	143
Do Ions or Molecules Form Hydrates? . . . . .	143
The Old and the New Hydrate Theory . . . . .	143
SUMMARY AND CONCLUSIONS . . . . .	144
THE FORMATION OF ALCOHOLATES BY CERTAIN SALTS IN SOLUTION IN METHYL AND ETHYL ALCOHOLS—WORK OF McMASTER . . . . .	147
Results with Methyl Alcohol . . . . .	149
Results with Ethyl Alcohol . . . . .	150

	PAGE.
THE FORMATION OF ALCOHOLATES BY CERTAIN SALTS IN SOLUTION IN METHYL AND ETHYL ALCOHOLS—WORK OF McMASTER—Continued.	
THE BEARING OF HYDRATES ON THE TEMPERATURE COEFFICIENTS OF CONDUCTIVITY OF AQUEOUS SOLUTIONS.....	153
SPECTROSCOPIC INVESTIGATIONS—WORK OF UHLER.....	160
AQUEOUS SOLUTIONS.....	161
The Spectrograph.....	169
The Spectroscope.....	170
The Cells.....	171
Freezing-point Apparatus.....	177
Conductivity Apparatus.....	177
Photographic Material.....	178
Sources of Light.....	179
Exposures and Spectrograms.....	180
Plates.....	182
Wave-lengths of Reference Lines.....	185
Experimental Facts and Data.....	186
Solutions.....	186
Cobalt Chloride.....	187
Cupric Chloride.....	190
Cupric Bromide.....	192
Cobalt Chloride and Calcium Chloride.....	194
Cobalt Chloride and Calcium Bromide.....	200
Cobalt Chloride and Aluminium Chloride.....	205
Copper Chloride and Calcium Chloride.....	213
Copper Chloride and Calcium Bromide.....	215
Copper Chloride and Aluminium Chloride.....	221
Copper Bromide and Calcium Chloride.....	224
Copper Bromide and Calcium Bromide.....	226
Copper Bromide and Aluminium Chloride.....	230
General Summary of Results.....	232
Discussion of the Several Theories.....	232
NON-AQUEOUS SOLUTIONS.....	241
Apparatus.....	241
Solutions.....	244
Cobalt Chloride in Methyl Alcohol.....	244
Cobalt Chloride in Ethyl Alcohol.....	245
Cobalt Chloride in Acetone.....	247
Copper Chloride in Methyl Alcohol.....	251
Copper Chloride in Ethyl Alcohol.....	252
Copper Chloride in Acetone.....	253
Copper Bromide in Methyl Alcohol.....	255
Copper Bromide in Ethyl Alcohol.....	256
CONCLUSIONS.....	259
REFERENCES TO PAPERS ALREADY PUBLISHED ON THIS SAME SUBJECT.....	260
INDEX.....	261

# INTRODUCTION.





## INTRODUCTION.

This investigation is the direct outcome of an observation that was made in the chemical laboratory of Johns Hopkins University five or six years ago. It was found by Jones and Ota,\* and by Jones and Knight† in connection with their work on the condition of double sulphates, chlorides, nitrates cyanides, etc., in aqueous solution, that concentrated solutions of these substances frequently show abnormally great depression of the freezing-point of water. It was further observed that the molecular depression of the freezing-point often *increases with the concentration* from a certain definite concentration.

*Work of Chambers.*—The first systematic study of this problem was made by Jones and Chambers.‡ They worked with calcium chloride, strontium chloride, barium chloride, magnesium chloride, and cadmium chloride; and with calcium bromide, strontium bromide, barium bromide, magnesium bromide, and cadmium bromide. They measured the freezing-point lowerings produced by these substances over a considerable range of concentration. The general character of the results that they obtained is shown by the data for a few substances given in table 1, on the following page.

Column I gives the concentration of the solutions in terms of gram-molecular normal; column II, the corrected lowering of the freezing-point of water; and column III, the molecular lowering of the freezing-point of water produced by the dissolved substance at the concentration in question.

An examination of column III for all of the above substances shows that the molecular lowering of the freezing-point passes through a minimum. This was true for all the compounds investigated by Jones and Chambers, except cadmium chloride and bromide. As the concentration increased from the point at which the minimum in the molecular lowering occurred, which was usually about 0.2 normal, the molecular lowering increased. For the most concentrated solutions studied by Jones and Chambers, the molecular lowering of the freezing-point of water became larger than the theoretical lowering produced by a ternary electrolyte when it was completely dissociated; and it is well known that at these concentrations the compounds under investigation were very far from being completely dissociated. This was obviously a remarkable and important phenomenon, meriting careful consideration.

\* Amer. Chem. Journ., 22, 5 (1890).

† *Ibid.*, 22, 110 (1899).

‡ *Ibid.*, 23, 89 (1900).

TABLE I.

Calcium chloride.			Magnesium chloride.		
I.	II.	III.	I.	II.	III.
0.102	0.508°	4.98	0.0508	0.280°	5.51
0.153	0.752	4.91	0.1016	0.537	5.28
0.204	1.012	4.96	0.1525	0.771	5.06
0.255	1.267	4.97	0.2033	1.058	5.20
0.306	1.537	5.02	0.2541	1.335	5.25
0.408	2.104	5.16	0.3801	2.015	5.30
0.510	2.681	5.26	0.5082	2.762	5.43
0.612	3.348	5.47	0.6099	3.472	5.69
Calcium bromide.			Magnesium bromide.		
I.	II.	III.	I.	II.	III.
0.04355	0.228°	5.24	0.0517	0.277°	5.36
0.08710	0.445	5.11	0.103	0.531	5.14
0.13065	0.664	5.07	0.155	0.801	5.17
0.17422	0.904	5.18	0.207	1.088	5.26
0.2613	1.368	5.23	0.310	1.699	5.45
0.3484	1.847	5.30	0.414	2.347	5.67
0.4355	2.397	5.50	0.517	3.022	5.84
0.5226	2.949	5.64			

Jones and Chambers\* then determined the conductivities of the same solutions of the same substances whose freezing-points they had measured, to see whether any minimum manifested itself in the conductivity results; or whether these results showed any irregularity whatsoever. This was studied with especial care, over the region of concentration in which the freezing-point minimum had occurred. The conductivity results were perfectly normal at all concentrations, the molecular conductivity increasing regularly with the concentration, just as would be expected.

To account for these results the following theory was proposed by Jones:†

“In concentrated solutions these chlorides and bromides must take up a part of the water, forming complex compounds with it, and thus removing it from the field of action as far as freezing-point lowering is concerned. The compound, which is probably very unstable, formed by the union of a molecule of the chloride or bromide with a large number

\* Amer. Chem. Journ., 23, 99 (1900).

† *Ibid.*, 23, 103 (1900).

of molecules of water, acts as a unit, or as one molecule in lowering the freezing-point of the remaining water. But the total amount of water present, which is now acting as solvent, is diminished by the amount taken up by the chloride or bromide molecules. The lowering of the freezing-point is thus abnormally great, because a part of the water is no longer present as solvent, but is in combination with the chloride or bromide molecules. By assuming that a molecule of the halide is in combination with a large number of molecules of water, it is possible to explain all of the freezing-point results obtained.

"But the conductivity results must also be taken into account. These show unmistakably a marked degree of dissociation even in the most concentrated solutions employed. There must, therefore, be a certain number of the molecules broken down into ions, either by the water acting as solvent, or by the water in combination with the molecules, just as salts are probably dissociated in their water of crystallization.

"It should be observed in connection with the explanation we have offered of these abnormal results, that the chlorides and bromides of the alkaline earths are generally very hygroscopic substances, resembling sulphuric acid in their power of attracting water. Some of them are, it is true, far more hygroscopic than others, yet, when dehydrated, they all combine readily with water. It may be due to this property that they combine with water to such an extent in concentrated solutions.

"We do not put forward the above suggestion to account for our results as a final statement of a theory, but only as tentative and subject to modification as new facts are brought to light. It does, however, seem to account qualitatively for the experimental facts which have been brought to light."

Thus was proposed the *present hydrate theory*, which has been the guiding thought in all of our subsequent investigations dealing with the *hydrate problem*.

*Work of Chambers and Frazer.*—The work that was begun by Jones and Chambers was continued, at the suggestion of Jones and under his guidance, by Chambers and Frazer.\* In the selection of compounds, those were chosen, in general, which are characterized by being very hygroscopic. Chambers and Frazer worked with copper sulphate, phosphoric acid, hydrochloric acid, sodium acetate, cadmium iodide, strontium iodide, and zinc chloride. They obtained results of the same general character as those found earlier by Jones and Chambers. The molecular lowering of the freezing-point passed through a minimum, and then increased with the concentration, acquiring in some cases for the most concentrated solutions studied, a value that was larger than the theoretical value for complete dissociation.

The hydrate theory proposed by Jones accounted just as satisfactorily for the results obtained by Chambers and Frazer, as for those previously obtained by Jones and Chambers.

*Earlier work of Getman.*†—The work that had already been done, showed that the abnormally great freezing-point lowerings in concentrated solutions

\*Amer. Chem. Journ., 23, 512 (1900).

†Ztschr. phys. Chem., 46, 244 (1903). Phys. Rev., 18, 146 (1904).

were not limited to a few hygroscopic substances, but were shown by quite a number. This but raised the question, How general is this phenomenon? Is it limited to certain classes of compounds, or is it shown by electrolytes in general? The systematic investigation of typical compounds, representing the whole field of the electrolytes, was then begun. We undertook to study not only a large number of acids, bases, and salts, but also to determine the freezing-points and conductivities of very concentrated solutions of these substances. In this way it seemed reasonable to hope that some light might be thrown on the nature of concentrated solutions.

It was clearly recognized that the theory of dilute solutions, which has proved so valuable in coördinating existing facts, and so fruitful in suggesting new lines of investigation, did not apply at all to concentrated solutions. Indeed, the theory was strictly applicable only to very dilute solutions, not holding even for those concentrations with which we ordinarily have to deal in the laboratory. This fact has been advanced as an objection to the present theory as to the condition of things in solution. It has been justly said that we do not have a theory of solutions in the broad sense, but only a theory that applies to ideal conditions; the actual solutions with which we work and with which directly we are most concerned, not coming within its scope. In a word, we had no theory of concentrated solutions.

It was with the ultimate object of ascertaining, as far as possible, the nature and condition of the dissolved substance in the more concentrated solutions, that the present systematic and somewhat extended investigation was begun.

A brief account of the apparatus used and the mode of procedure in this earlier stage of the work are given.

#### APPARATUS.

##### FREEZING-POINT APPARATUS.

Fig. 1 shows the apparatus used in determining the freezing-points of the solutions. It will be seen to be essentially that devised by Beckmann. The thermometers used were made expressly for this work. They were of the Beckmann type, one having a range of  $12^{\circ}$ , each degree being divided into fiftieths; the other having a range of  $25^{\circ}$ , each degree being divided into twentieths. The thermometer with the greater range was used when working with very concentrated solutions, which gave a large depression, while the more finely graduated instrument was used with the more dilute solutions.

The stirrer in the freezing-tube consisted of a ring of stout platinum wire, around which was wrapped a spiral of fine platinum wire. The size of

the ring was such that when wrapped with the smaller wire, it would just touch the walls of the freezing-tube, and thus hinder the formation of an ice-sheath. This device was found to give perfect satisfaction, and to be in every sense superior to the ordinary glass stirrer. The platinum stirrer was attached to a glass rod, which passed closely through a glass tube in the cork of the freezing-tube. In this way the movement of the stirrer was guided, and cramping prevented.

The freezing-tube consisted of a large test-tube of 80 cc. capacity, surrounded by a second glass tube, giving an air space between the two of about a centimeter. This outer tube was surrounded by the freezing mixture, which was contained in a large battery-jar wrapped with felt to diminish radiation. The freezing mixture was varied to suit the conditions, the solutions of lower concentrations freezing with a mixture of salt and ice, while those of greater concentrations often required the use of crystallized calcium chloride and ice.

By means of a small electric hammer, uniform and gentle blows were delivered on the top of the thermometer during the time of an observation, thus overcoming the friction of the mercury in the capillary.

To facilitate the reading of the thermometer, a small lens magnifying several diameters was employed, and more intense illumination of the thermometer scale was obtained by means of a small incandescent lamp. A thermometer graduated to tenths served to indicate the temperature of the freezing mixture, the effort being made to keep this only a few degrees lower than the freezing temperature of the solution under observation.

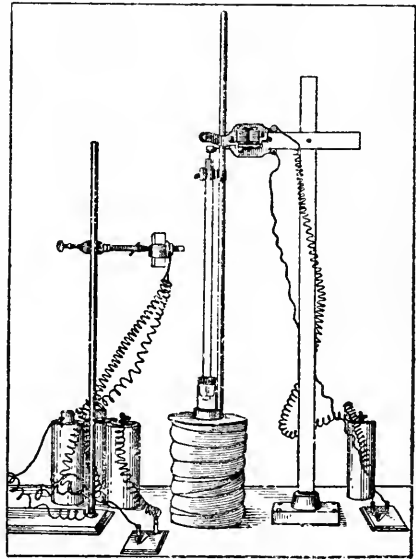

FIG. 1.

#### CONDUCTIVITY APPARATUS.

The conductivity measurements were made by the well-known Kohlrausch method, using the Wheatstone bridge, inductorium, and telephone. Two types of cells were used. For the more dilute solutions the ordinary

Arrhenius cell was employed, but for the very concentrated solutions a special cell was designed. The accompanying sketch (fig. 2) shows this cell in section.

The U-tube *AA* is 8 cm. in length and 2.8 cm. in diameter. The ground stoppers *BB* are filled with paraffin, which serves to hold the tubes *cc* rigidly in place, thus insuring a constant distance between the electrodes. Each stopper is numbered corresponding to a number placed on the ends of the U-tube, so that the electrodes would not be interchanged. Furthermore, by means of fine vertical lines cut on each stopper and the necks of the U-tube, the electrodes could be returned to exactly the same positions each time. That there was no alteration in the distance between the electrodes was carefully established by a series of determinations of the cell constant on successive days, with the result that the differences were well within the limit of experimental error. The electrodes are of thick sheet platinum, and are 2.5 cm. in diameter.

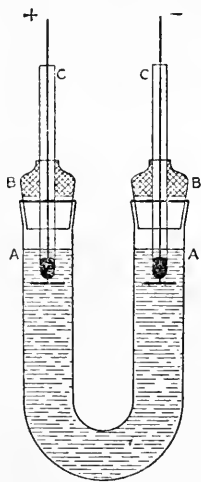

FIG. 2.

All of the conductivity measurements were made at 0°. The bath by which the solutions were maintained at this temperature was prepared in the following manner:

A glass battery-jar was filled with finely crushed, pure ice, to which was added a small volume of water. This jar was placed in a large water-bath, and the space between was packed with well-crushed ice. By this means it was found easy to maintain the solution in the conductivity cell to within five-hundredths of a degree of the true zero. The ice in the battery-jar was stirred occasionally, and the temperature of the bath was noted frequently, to insure the measurements being taken at 0°.

At a later stage of the work it seemed very desirable to supplement the freezing-point and conductivity measurements with determinations of the boiling-point elevations and the refractive indices of some of the solutions. For the former determinations the boiling-point apparatus devised by Jones\* was employed, while for the refractivity measurements use was made of the well-known Pulfrich refractometer.

With the exception of the pipettes, the volumetric apparatus used was specially made and carefully calibrated for this investigation. The volumetric apparatus consisted of a series of measuring flasks, a burette, and a series of pipettes. The pipettes were never used in making the dilutions.

\* Amer. Chem. Journ., 19, 581 (1897).

## SOLUTIONS.

The method of preparing the solutions varied somewhat according to the substance employed, but, in general, it may be said that a solution of two or three gram-molecular weights to the liter was first made, and from this, by successive dilutions, the less concentrated solutions were obtained. Wherever possible the mother-solution was made up by direct weighing. When this was not the case the solution was standardized either by gravimetric or volumetric methods. Great care was taken to insure the accurate standardization of the mother-solution, and the dilutions were made with volumes large enough to minimize errors in burette readings and flask adjustments.

The water that was used as solvent was of a high degree of purity. The ordinary tap-water was first distilled in the laboratory still, and then redistilled from a dilute solution of chromic acid. This second distillate was then distilled a third time according to the method of Jones and Mackay.\* The water thus obtained was preserved in a large bottle which had previously been subjected to careful cleaning. The water showed an average conductivity of  $1.0 \times 10^{-6}$ .

## METHODS.

## FREEZING-POINT METHOD.

The practical details of the freezing-point method may be set forth most clearly by a description of the determination of the freezing-point of water, by which the zero-point of the thermometer was established, prior to making any measurements with solutions.

The freezing-tube was filled to a depth of 5 cm. with pure distilled water, and the thermometer and stirrer inserted. The tube was then placed in a vessel containing ice and salt, and the stirrer agitated frequently until ice separated. The tube was then removed and warmed until the ice just melted. It was then placed in the freezing-jacket, which was surrounded with finely crushed, dry ice, to which had been added just enough salt to bring the temperature of the mixture a few degrees below the freezing-point of the solvent.

The stirrer was agitated from time to time until freezing began, when the stirring was continued vigorously, and at the same time the electrical hammer was set in action. The thermometer scale was illuminated by the incandescent lamp, and the reading taken after the mercury column had remained stationary for about thirty seconds. It was almost always found that the solvent undercooled several degrees, and it was frequently necessary to add a small fragment of ice to induce freezing.

\*Amer. Chem. Journ., 19, 83 (1897).

In the case of solutions the tendency to undercool was not so marked. Owing to the change in concentration due to the separation of ice, a correction was introduced. The determination of the freezing-point of the solvent, as well as of any solution, was repeated several times, and the mean of the results taken as the true freezing-point.

#### CONDUCTIVITY METHOD.

The solution was introduced into the conductivity cell, care being taken to avoid the collection of air-bubbles on the electrodes, and the cell was then placed in the zero-bath where it was allowed to remain for half an hour, this having been found to be sufficient time for the solution to acquire the uniform zero temperature. The conductivity was then determined by the well-known Kohlrausch method. In the more concentrated solutions it was not found necessary to introduce a correction for the slight conductivity of the water.

#### BOILING-POINT METHOD.

Care was taken to use this method only on days when the barometer remained quite constant. The general method of carrying out a boiling-point measurement was employed, care being taken that the solutions boiled evenly, and that the thermometer was gently tapped before reading. The boiling-point as recorded is the mean of a series of readings taken at intervals of thirty seconds.

#### REFRACTIVITY METHOD.

The determination of refractive indices was made with the refractometer of Pulfrich. Sodium light was employed, and care was taken to have the solutions at uniform temperature. The readings were made to minutes of arc, and by means of the well-known formula  $n = \sqrt{N^2 - \sin^2 e}$ , the indices of refraction were calculated.

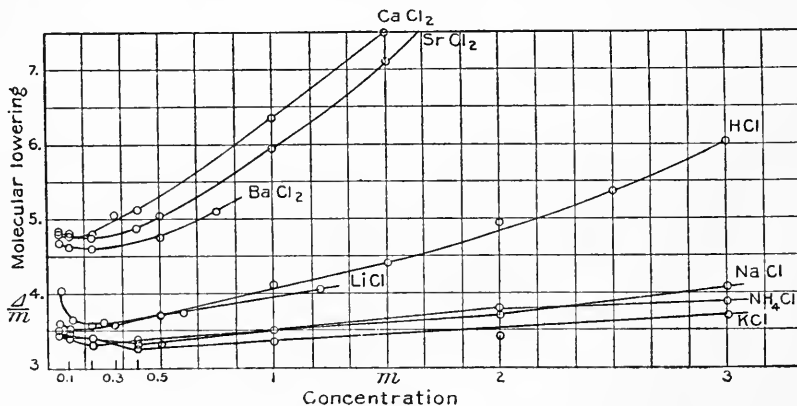

FIG. 3.



SUBSTANCES EMPLOYED.

The substances that were brought within the scope of this earlier work, together with the range of concentration studied, are given below:

	Normal.			Normal.	
Hydrochloric acid.....	0.05	to 3.0	Potassium nitrate .....	0.05	to 1.0
Lithium chloride.....	0.06	1.18	Sulphuric acid .....	0.05	2.5
Ammonium chloride.....	0.04	3.0	Ammonium sulphate.....	0.05	1.4
Sodium chloride .....	0.05	3.0	Sodium sulphate .....	0.05	0.5
Potassium chloride .....	0.05	3.0	Potassium sulphate.....	0.05	0.3
Calcium chloride .....	0.05	2.0	Sodium carbonate .....	0.05	0.5
Strontium chloride .....	0.05	2.0	Potassium carbonate.....	0.05	2.0
Barium chloride .....	0.05	0.75	Phosphoric acid.....	0.05	3.12
Nitric acid .....	0.05	3.0	Potassium dihydrogen phos-		
Lithium nitrate.....	0.05	0.9	phate.....	0.01	1.0
Ammonium nitrate.....	0.025	3.0	Sodium hydroxide.....	0.02	2.48
Sodium nitrate .....	0.05	3.0	Potassium hydroxide.....	0.05	2.5

RESULTS OBTAINED.

The results that were obtained are plotted in curves, figs. 3 to 13. The *freezing-point lowerings* are plotted in figs. 3 to 6. The ordinates are molecular lowerings of the freezing-point, and the abscissæ are concentrations expressed in terms of gram-molecular normal.

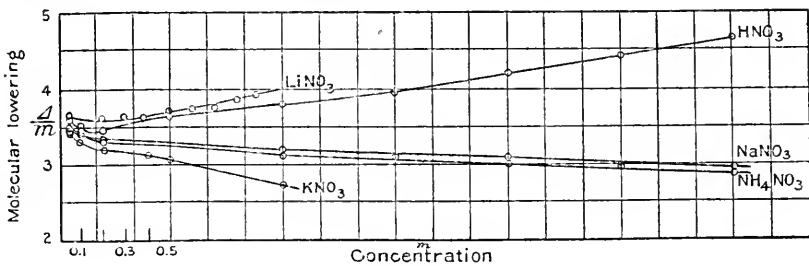

FIG. 4.

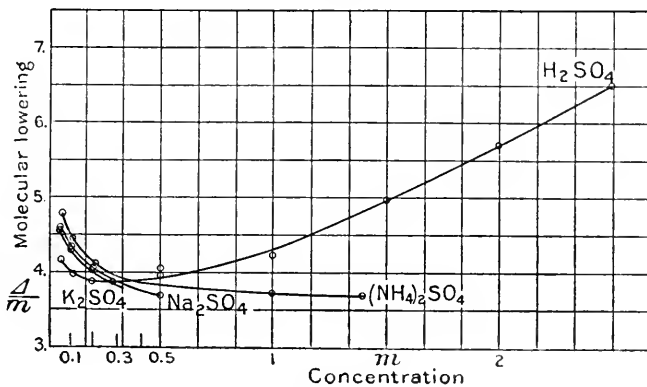

FIG. 5.

From the work that was done previous to this investigation, and from the data here obtained, it is shown that, with but few exceptions, electrolytes in general give abnormal molecular depressions of the freezing-point in concentrated solutions. Among these exceptions are sodium, potassium, and ammonium nitrates, and potassium dihydrogen phosphate.

Among the chlorides those of the second group in the periodic system give greater molecular depressions than those of the first group. We also observe that the curve for hydrochloric acid lies considerably above the corresponding curves for lithium, ammonium, sodium, and potassium chlorides.

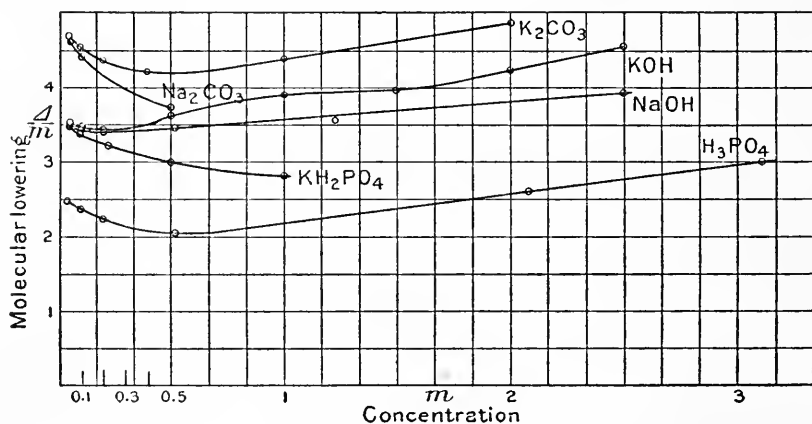

FIG. 6.

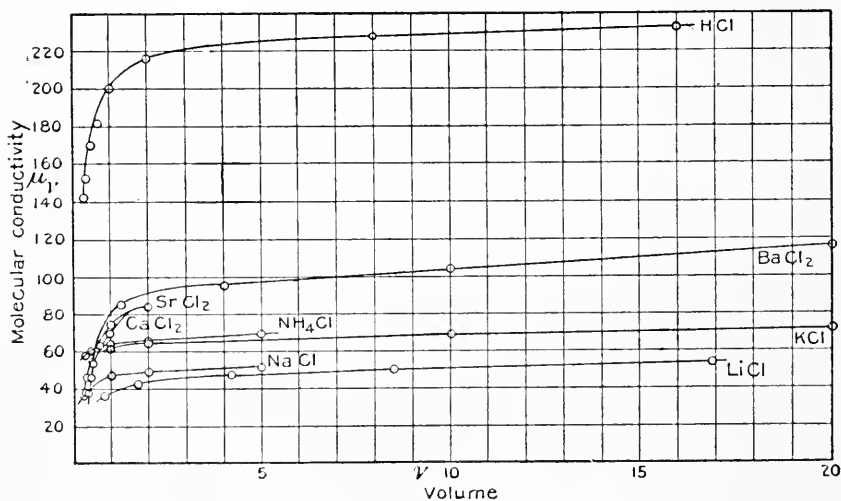

FIG. 7.

is clearly shown by the curves for lithium chloride and lithium nitrate, which resemble the curves for the corresponding salts in the second group more closely than the analogues of the first group. The relation is very marked in the case of lithium nitrate.

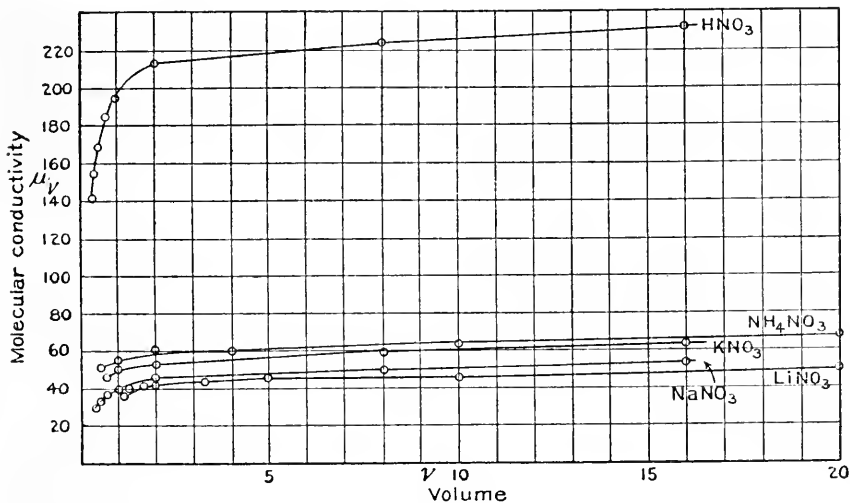

FIG. 8.

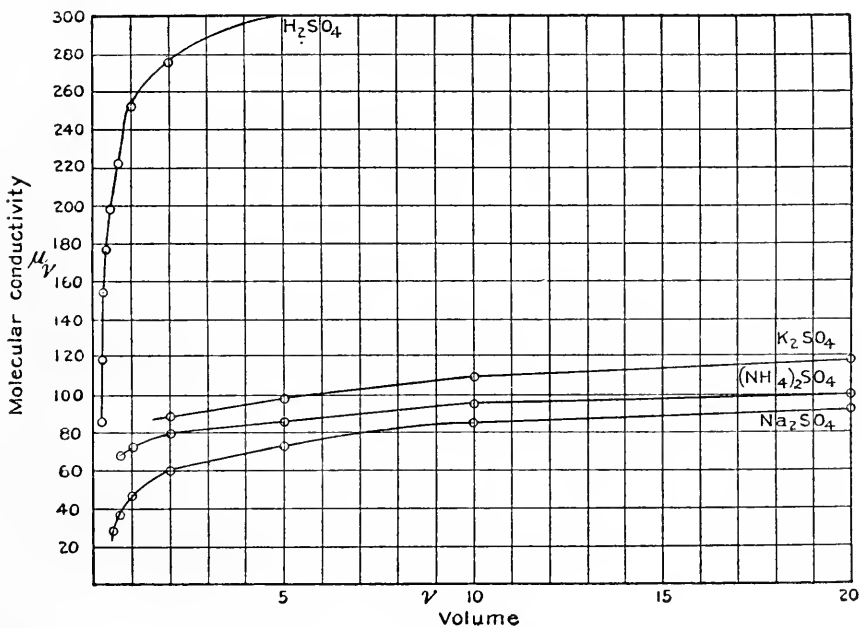

FIG. 9.

Owing to limited solubility the study of the sulphates at great concentration was not possible, so that it can not be stated whether or not these salts exhibit the phenomenon.

In general, we may say that the freezing-point curve for any acid lies above those of the salts which it forms with the metals of the first group, while it lies below the curves for its second group salts. The molecular conductivities are plotted in curves, figs. 7 to 10. The ordinates are molecular conductivities, and the abscissæ volume of the solution, or the number of liters that contain a gram-molecular weight of the electrolyte.

The conductivity curves for all of the substances studied are perfectly normal throughout, showing absolutely no peculiarities in the region of dilution where the minimum of molecular depression manifests itself.

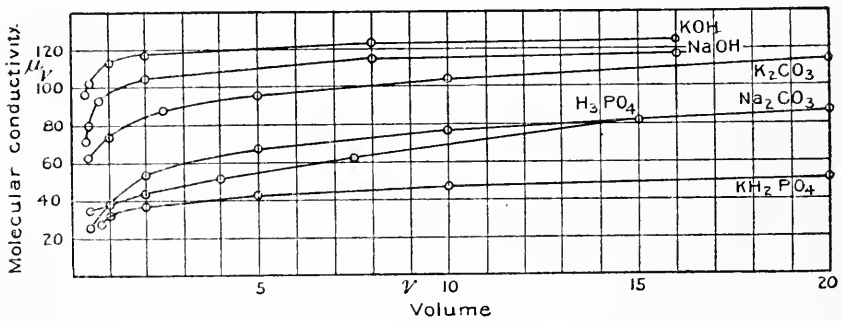

FIG. 10.

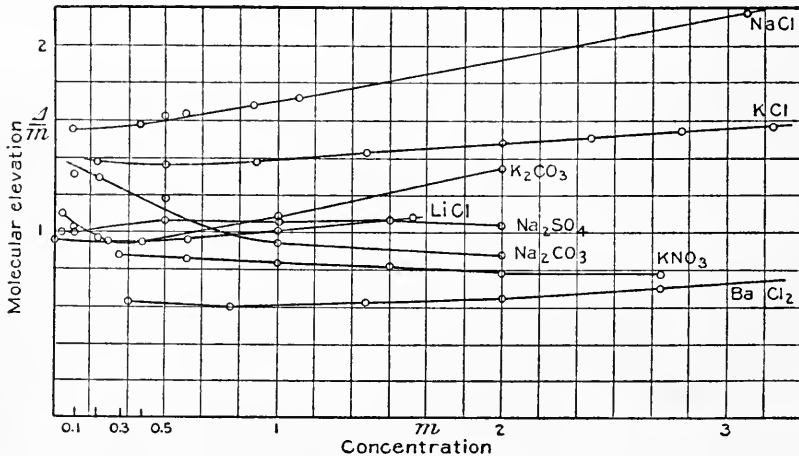

FIG. 11.

The boiling-point data are plotted in curves, fig. 11. The ordinates are molecular elevations of the boiling-point, and the abscissæ are concentrations of the solutions in terms of a gram-molecular weight of the dissolved substance in 1,000 grams of the solvent. In the few boiling-point curves that are given, there is a more or less marked minimum, but, as has already been pointed out, no great reliance can be placed upon the results obtained by the boiling-point method.

The results of refractivity measurements are given in figs. 12 and 13. The indices of refraction are ordinates, and the concentrations in terms of normal are abscissæ. The curves are nearly all straight lines, showing no irregularity at any of the concentrations studied.

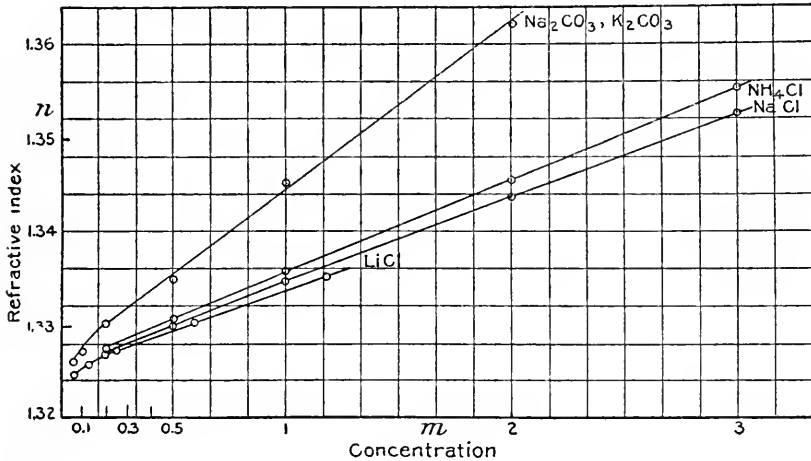

FIG. 12.

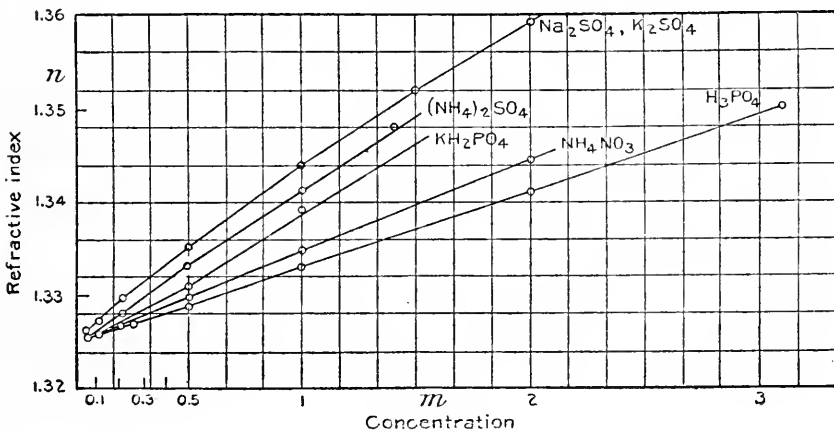

FIG. 13.

## CONCLUSIONS FROM THE EARLIER WORK.

The results obtained in this investigation can all be explained satisfactorily by the suggestion put forward by Jones and Chambers. It should be added that the boiling-point determinations, as far as they have any value, point to the correctness of the suggestion that there are *hydrates formed in concentrated solutions*. The boiling-point curves show a minimum corresponding to the freezing-point curves. *The minimum in the boiling-point curves, however, is at greater concentration than in the freezing-point curves.* This is just what we should expect if the suggestion of the existence of hydrates in such solutions was correct. At the higher temperature the hydrates would be less stable, and would require greater concentration for their formation than at the lower temperature.

All things considered, then, the view that explains very satisfactorily the results is that originally suggested by Jones, viz., that in the concentrated solutions there is combination between the molecules of the dissolved substance and the molecules of the solvent, thus removing a part of the solvent, as far as freezing-point lowering is concerned.

To explain the conductivity result it is also necessary to assume that there is a certain amount of electrolytic dissociation, together with hydration, existing in these solutions.

# PART I.

---

EVIDENCE FOR THE EXISTENCE OF HYDRATES IN  
AQUEOUS SOLUTION, AND THE APPROXIMATE  
COMPOSITION OF THE HYDRATES FORMED  
BY A LARGE NUMBER OF ELECTROLYTES.

---

WORK OF

GETMAN AND BASSETT.





## EVIDENCE FOR THE EXISTENCE OF HYDRATES IN AQUEOUS SOLUTION, AND THE APPROXIMATE COMPOSITION OF THE HYDRATES FORMED BY A LARGE NUMBER OF ELECTROLYTES.

The work of Dr. Getman and that of Dr. Bassett, having to deal with the same general problems, are so closely correlated that it is best to treat the two investigations as a unit. We shall depart at this point from the historical sequence in which the various facts were brought to light, in order to treat the subject of hydrates in aqueous solutions in a more logical manner.

### EVIDENCE FOR THE EXISTENCE OF HYDRATES.

One line of evidence for the existence of hydrates in aqueous solution has already been furnished. The *minima in the boiling-point curves occur at greater concentration than in the freezing-point curves*. The hydrates in solution would be less stable at the higher temperature, and, therefore, a greater concentration would be required for a sufficient production of these substances to change the direction of the curve, thus giving the minimum point.

### EFFECT OF TEMPERATURE ON WATER OF CRYSTALLIZATION, AS BEARING ON THE THEORY OF HYDRATES IN SOLUTION.

Another line of evidence, which seems to have some bearing, at least indirectly, on the question as to whether there is combination between the solvent and dissolved substances, is the following: If dissolved substances combine with the solvent, we know that the resulting compounds are unstable, especially at elevated temperatures. That this is the case is shown by the fact that most of the water can readily be driven off from solutions of salts at the boiling-points of these solutions. Indeed, in most cases practically all the water can thus be removed, except that which is held in combination by the salt at the temperature in question as water of crystallization. We shall show that salts which crystallize with water of crystallization can combine, when in solution, at ordinary temperatures, with a much larger amount of water than they can bring with them out of solution, when they crystallize. These hydrates are, then, more stable the lower the temperature; and, in terms of our hydrate theory, we should expect that *a salt would be able to bring with it out of solution more water, as water of crystallization, the lower the temperature at which the crystals were formed*.

It created surprise, on examining the literature, to find how large an amount of evidence was available bearing on this point. A good many

cases are well known, but there was found on record an unexpectedly large number of salts that have already been shown to crystallize with varying amounts of water, depending upon the temperature at which the crystals were formed. A few examples are given to bring out the general relation, that *the number of molecules of water of crystallization is greater the lower the temperature at which the salt is crystallized.*

Salt.	Water of crystallization.	Temperature of crystallization.
LiCl	2H <sub>2</sub> O	12.5°
"	3H <sub>2</sub> O	—15°
LiBr	H <sub>2</sub> O	Not stable above 4°
"	2H <sub>2</sub> O	—40°
"	3H <sub>2</sub> O	—40°
LiNO <sub>3</sub>	Anhydrous	15°
"	5H <sub>2</sub> O	Below 10°
NaBr	Anhydrous	Hot, concentrated solution
"	2H <sub>2</sub> O	Ordinary temperatures
NaI	Anhydrous	Hot, concentrated solution
"	2H <sub>2</sub> O	Ordinary temperatures
Na <sub>2</sub> CO <sub>3</sub>	7H <sub>2</sub> O	Warm saturated solution
"	10H <sub>2</sub> O	Ordinary temperatures
CaCl <sub>2</sub>	H <sub>2</sub> O	} As the temperature of crystallization is lower and lower
"	2H <sub>2</sub> O	
"	4H <sub>2</sub> O	
"	6H <sub>2</sub> O	
Sr(NO <sub>3</sub> ) <sub>2</sub>	Anhydrous	Above 16.8°
"	4H <sub>2</sub> O	Below 16.8°
MgCl <sub>2</sub>	6H <sub>2</sub> O	Elevated temperatures
"	8H <sub>2</sub> O	Above 20°
"	10H <sub>2</sub> O	20°
"	12H <sub>2</sub> O	—10° to —12°
MgBr <sub>2</sub>	4H <sub>2</sub> O	} 11.5° to 12.5°
"	6H <sub>2</sub> O	
"	10H <sub>2</sub> O	
Mg(NO <sub>3</sub> ) <sub>2</sub>	2H <sub>2</sub> O	Elevated temperatures
"	6H <sub>2</sub> O	18°
"	9H <sub>2</sub> O	—17°
ZnCl <sub>2</sub>	H <sub>2</sub> O	Elevated temperatures
"	2H <sub>2</sub> O	
"	3H <sub>2</sub> O	—21°
ZnBr <sub>2</sub>	Anhydrous	35°
"	2H <sub>2</sub> O	—8°
"	3H <sub>2</sub> O	—15°
Zn(NO <sub>3</sub> ) <sub>2</sub>	3H <sub>2</sub> O	36°
"	6H <sub>2</sub> O	From concentrated solution
"	9H <sub>2</sub> O	—18°
Cd(NO <sub>3</sub> ) <sub>2</sub>	4H <sub>2</sub> O	Ordinary temperatures
"	9H <sub>2</sub> O	10° to —16°
CdSO <sub>4</sub>	H <sub>2</sub> O	103° to 104°
"	7H <sub>2</sub> O	—20°
"	9H <sub>2</sub> O	Very low temperatures

Salt.	Water of crystallization.	Temperature of crystallization.
MnCl <sub>2</sub>	2H <sub>2</sub> O	20°
"	4H <sub>2</sub> O	15°
"	6H <sub>2</sub> O	-21°
"	11H <sub>2</sub> O	-21° to -37°
"	12H <sub>2</sub> O	-48°
MnI <sub>2</sub>	4H <sub>2</sub> O	0° to -2.7°
"	6H <sub>2</sub> O	-5°
"	9H <sub>2</sub> O	-20°
MnSO <sub>4</sub>	3H <sub>2</sub> O	25° to 31°, as a crust
"	4H <sub>2</sub> O	25° to 31°
"	5H <sub>2</sub> O	15° to 20°
"	7H <sub>2</sub> O	0° or below 6°
Ni(NO <sub>3</sub> ) <sub>2</sub>	3H <sub>2</sub> O	58° and above
"	6H <sub>2</sub> O	-16°
"	9H <sub>2</sub> O	-27°
Co(NO <sub>3</sub> ) <sub>2</sub>	3H <sub>2</sub> O	56° to 91°
"	6H <sub>2</sub> O	-22° to 56°
"	9H <sub>2</sub> O	-29° to -22°
Cu(NO <sub>3</sub> ) <sub>2</sub>	3H <sub>2</sub> O	At ordinary temperatures
"	6H <sub>2</sub> O	About 0° to -10°
"	9H <sub>2</sub> O	-20° to -24°
AlCl <sub>3</sub>	6H <sub>2</sub> O	2° to 20°
"	9H <sub>2</sub> O	-8° to 2°
AlBr <sub>3</sub>	9H <sub>2</sub> O	Ordinary temperatures
"	15H <sub>2</sub> O	-10° to -18°
AlI <sub>3</sub>	6H <sub>2</sub> O	Ordinary temperatures
"	15H <sub>2</sub> O	-18°
Fe(NO <sub>3</sub> ) <sub>2</sub>	6H <sub>2</sub> O	-9°
"	9H <sub>2</sub> O	-27°
FeCl <sub>3</sub>	Anhydrous	80° and above
"	2H <sub>2</sub> O	60° to 80°
"	2½H <sub>2</sub> O	40° to 60°
"	3½H <sub>2</sub> O	20°
"	6H <sub>2</sub> O	20° to -16°

While there is a much larger number of cases on record where water of crystallization varies with the temperature, in many of them the temperatures at which the different amounts of water of crystallization were found are either not given at all, or are given only approximately. Such cases, in their present state, are of comparatively little value as bearing on the problem under discussion.

The examples given above suffice to show the general nature of the relation between water of crystallization and the temperature at which the salt was crystallized. Work is now in progress on this point, and we hope to find a much larger number of instances where temperature affects water of crystallization; and, if possible, to establish even more marked effects of temperature on the amount of water with which the salt crystallizes.

## RELATION BETWEEN WATER OF CRYSTALLIZATION AND LOWERING OF FREEZING-POINT.

Jones and Getman\* pointed out a relation between the lowering of the freezing-point produced by electrolytes and their water of crystallization. This relation was shown to hold for a large number of chlorides, bromides, iodides, and nitrates—indeed, for about 40 electrolytes with larger and smaller quantities of water of crystallization. The discovery of this relation confirmed the conclusion reached much earlier by one of them,† that the abnormal freezing-point results produced by the electrolytes, especially in concentrated solutions, were due to a combination between the solvent and the substance dissolved in it.

Indeed, this conclusion seems to be almost a necessary consequence of the above relation. *If hydrates are present in such solutions, those substances that form the most complex hydrates in solution would be the substances that would crystallize from solution with the largest amounts of water.* This is the same as to say that those substances which, in solution, have the greatest power to combine with water, would be the ones that would bring with them the largest amounts of water out of solution.

We should, however, not expect the two phenomena to be exactly proportional to one another, because the *actual shape* of the molecules which build up the crystal would also be a conditioning factor in determining the exact number of molecules of water with which any given substance would crystallize. The best we could hope to discover would be a general qualitative relation between the lowering of the freezing-point and water of crystallization. That such a relation actually exists can be seen by examining figs. 14 to 17.

The data incorporated in these curves have already been published.‡

In fig. 14 the results that have been obtained for the various chlorides are plotted on one sheet, as far as could be done, without undue crowding. The abscissæ are concentrations expressed as gram-molecular normal; the ordinates are molecular lowerings of the freezing-point. The chlorides of sodium, potassium, and ammonium, which crystallize without water, give the smallest lowering of the freezing-point.

The chloride of lithium, with 2 molecules of water of crystallization, gives considerably greater lowering of the freezing-point of water than the chlorides which have no water of crystallization.

When we pass to barium chloride, which contains 2 molecules of water of crystallization, it gives a greater lowering of the freezing-point than lithium chloride, with the same amount of water of crystallization. It

\*Ztschr. phys. Chem., 49, 385 (1904).

†Jones: Amer. Chem. Journ., 23, 89 (1900).

‡Ztschr. phys. Chem., 31, 303 (1904); 46, 244 (1903); 49, 385 (1904).

must, however, be remembered in this connection that lithium chloride is a binary electrolyte, yielding only two ions, while barium chloride is a ternary electrolyte—each molecule dissociating into three ions.

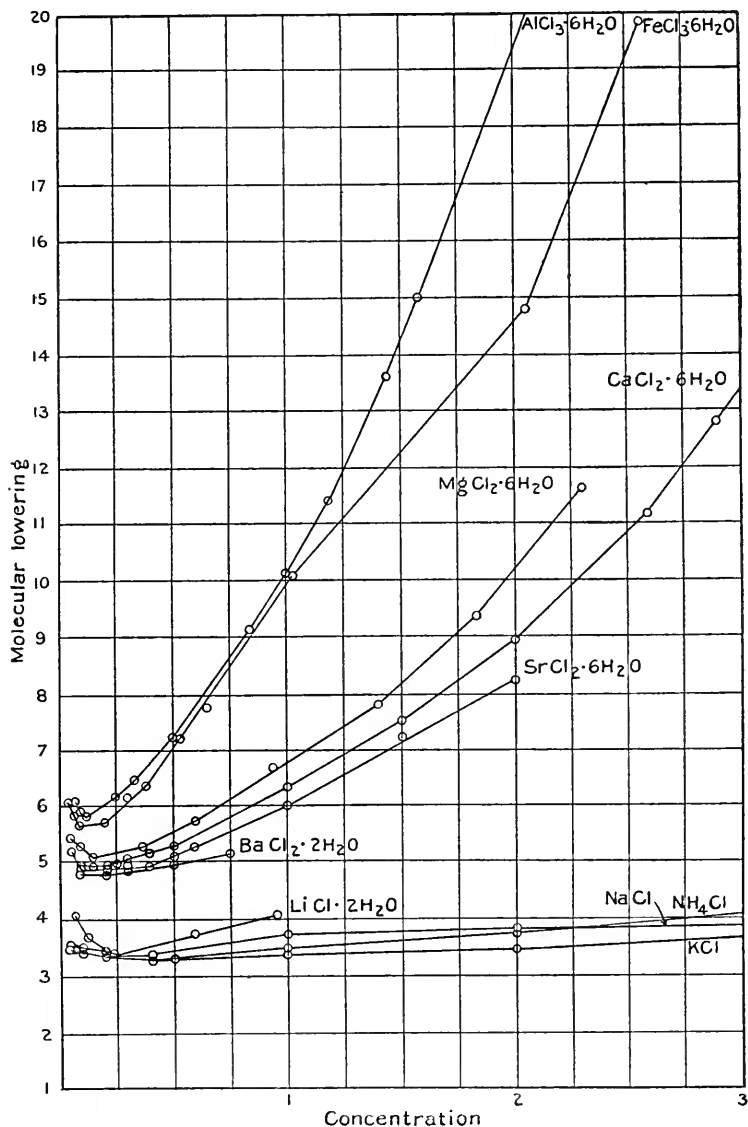

FIG. 14.

Strontium, calcium, and magnesium chlorides all crystallize with 6 molecules of water, and all give freezing-point lowerings of the same order of magnitude.

Aluminium and ferric chlorides contain 6 molecules of crystal water, yet they show much greater lowering than the ternary chlorides with 6 molecules of water of crystallization. This is to be accounted for by the fact that the chlorides of iron and aluminium are quaternary electrolytes—each molecule dissociating into four ions.

Turning to fig. 15, relations similar to those pointed out above are seen to exist for the bromides. Sodium bromide, unlike sodium chloride,

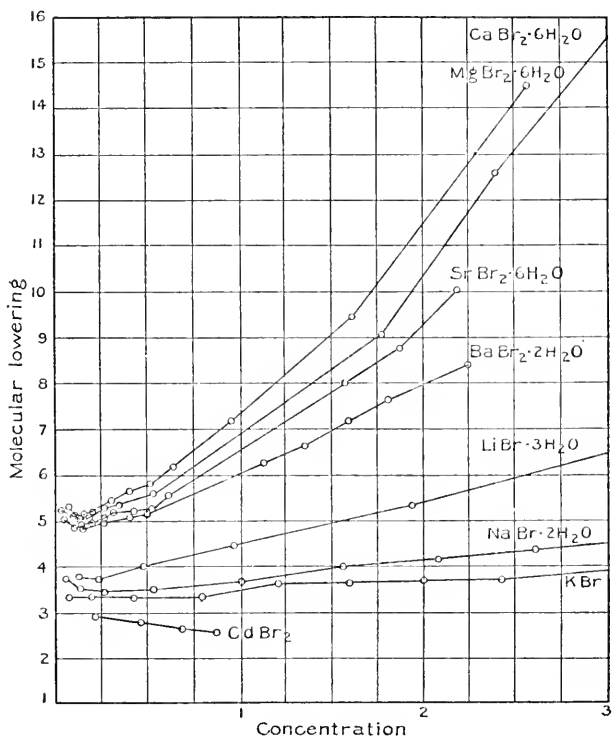

FIG. 15.

crystallizes with 2 molecules of water. It falls considerably above potassium bromide, just as we should expect it to do. Lithium bromide, with 3 molecules of crystal water, occupies a still higher position in the figure. Passing to the ternary bromides, barium bromide, with 2 molecules of water of crystallization, shows greater lowering than the binary electrolyte, lithium bromide, as we should expect; it also gives considerably smaller lowering of the freezing-point than strontium, calcium, and magnesium bromides, each with 6 molecules of water of crystallization.

Relations of an exactly similar character are shown by fig. 16, for the iodides.

The results plotted in fig. 17 for the nitrates present certain features of special interest. The nitrates without water of crystallization, sodium, ammonium, and potassium, give the smallest lowerings of the freezing-point. Lithium nitrate, with 2 molecules of crystal water, gives considerably greater lowering than the alkali nitrates.

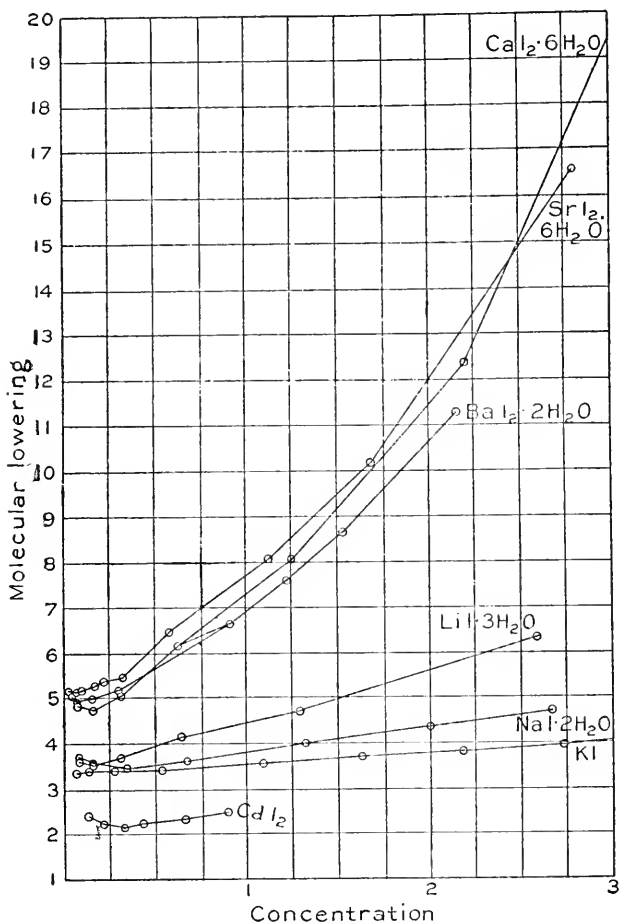

FIG. 16.

Calcium nitrate crystallizes with 4 molecules of water, and occupies a position in the figure about midway between the alkali nitrates without crystal water, and a number of nitrates each with 6 molecules of water of crystallization. Manganese nitrate, of all the nitrates studied, gives smaller lowerings than we should expect. We have repeated the experiments

with this substance, to see if some error had not found its way into this part of the work, and the results are given later.

The nitrates of a number of metals, each containing 6 molecules of water of crystallization, give lowerings of the freezing-point of the same order of magnitude, and the curves for these substances fall very closely together on the figure.

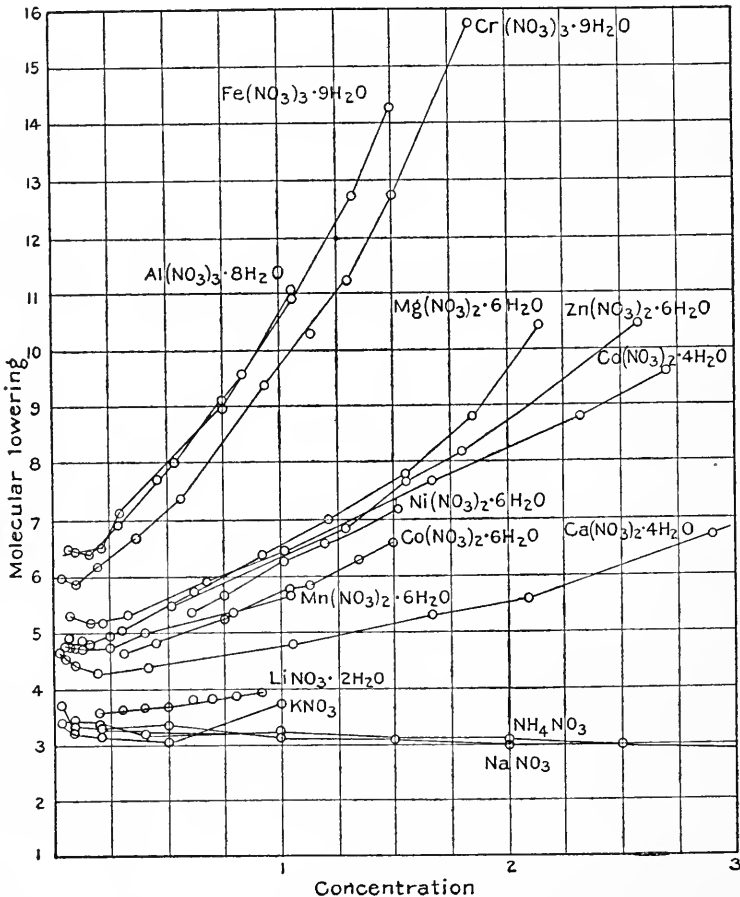

FIG. 17.

The nitrates of aluminium, iron, and chromium are of special interest, in that these substances contain more water of crystallization than any others thus far studied in this work. They not only show much greater lowering of the freezing-point than the nitrates with 6 molecules of crystal water, but show a greater lowering of the freezing-point of water than any other salts that we have thus far investigated. A careful study of this



nitrate diagram, alone, will show an unmistakable relation between the lowering of the freezing-point and the water of crystallization possessed by the salts in question.

Relations such as those pointed out above, between *different salts of the same acid*, are all that could reasonably be expected to exist. Certain relations, however, of interest and importance in this connection are found *between the salts of different acids*.

If we compare the results plotted in curves in figs. 14 to 17 for the chlorides, bromides, iodides, and nitrates, we shall find abundant evidence bearing on the relation between freezing-point lowering and water of crystallization. Chlorides, bromides, iodides, and nitrates that crystallize without water all show a molecular lowering of between 3 and 4, and this increases very slightly, if at all, with the concentration.

As far as the comparison can be carried, lithium chloride, with 2 molecules of water, gives less lowering than lithium bromide or lithium iodide with 3 molecules of water, and just about the same lowering as lithium nitrate with 2 molecules of water of crystallization.

Lithium bromide, with 3 molecules of water, gives about the same lowering as lithium iodide, which has the same amount of water of crystallization.

Sodium bromide, with 2 molecules of water, gives very nearly the same lowering as sodium iodide, which has the same number of molecules of water of crystallization.

Barium chloride has the same number of molecules of water of crystallization as the bromide and iodide. Since barium chloride has only a slight solubility in water, comparison of freezing-point lowerings must be limited to dilute solutions. The freezing-point lowerings of the three salts are just about the same in the dilute solutions, although in the more concentrated solutions the iodide shows greater lowering than the bromide.

If we compare the chlorides, bromides, and iodides of the alkaline earths, which contain each 6 molecules of water of crystallization, we shall find that the lowerings of the freezing-point produced by them are all of the same order of magnitude. We shall, however, see that the bromides give somewhat greater lowering than the chlorides, and the iodides even greater lowering than the bromides.

As far as comparisons can be made, it seems that the nitrates produce about the same lowerings as the corresponding chlorides with an equal number of molecules of water of crystallization, and, therefore, somewhat less than the corresponding bromides and iodides.

The quaternary chlorides of aluminium and iron can not be compared, at present, with respect to their freezing-point lowering, with the corresponding bromides and iodides, because the latter have not yet been investigated.

A comparison of the lowerings produced by the chlorides of iron and aluminium, containing 6 molecules of crystal water, with the nitrates of the same metals which have a larger amount of water of crystallization, will show a somewhat greater lowering, at the same concentrations, produced by the nitrates.

Thus, *the relation between the lowering of the freezing-point of water produced by salts and their water of crystallization comes out on every hand, whether we compare the salts of a given acid with different metals, or the salts of the same metal with different acids.*

This line of evidence, together with several others already pointed out in earlier papers, confirms us in the belief of the correctness of the theory advanced by Jones,\* to account for the abnormally great depressions of the freezing-point of water, produced by electrolytes, *viz., that in solution the dissolved substance is in combination with a part of the solvent, the amount of the solvent held in combination by the dissolved substance being a function of the concentration of the solution; in general, increasing with increase in concentration.*

It might be concluded that the facts presented on pages 18 and 19 are at variance with the relations just pointed out between water of crystallization and lowering of freezing-point. That this is not the case will be seen, when we consider that the water of crystallization given above is the amount of water with which the salt crystallizes under ordinary conditions, *i. e.*, under as nearly comparable conditions as possible.

#### EXPERIMENTAL WORK.

The experimental work consisted in measuring the *freezing-point* of the solution; in determining its *conductivity* at 0°, and in taking its *specific gravity*. In many cases the *refractivity* of the solution was also measured. The first three quantities are necessary in order to calculate even the approximate composition of the hydrate formed.

The *freezing-point lowerings* produced by the various substances, over as wide range of dilution as was practicable, were measured. The more concentrated solutions were frozen by means of a mixture of solid carbon dioxide and alcohol, the freezing temperatures being determined by means of alcohol thermometers. These temperatures could not be measured more closely than 0.5°, and we are not certain of our measurements for the very low temperatures to within 1°. Solutions of intermediate concentration were frozen by means of a mixture of ice and calcium chloride. For the more dilute solutions, Beckmann thermometers, covering a range of 5°, 12°, and 25°, respectively, were used. When the more concentrated solutions were frozen, they were removed from the bath of solid carbon dioxide

\*Amer. Chem. Journ., 23, 89 (1900).

and alcohol as soon as ice began to separate, in order that they might not be surrounded by the very cold freezing mixture while temperature equilibrium was being established. The proper correction for the increase in concentration due to the separation of the ice was introduced, except in the more concentrated solutions. It was always a perfectly simple matter to ascertain when pure ice separated from the solution, or when some of the dissolved substance was deposited. This could usually be determined by the gritty or sand-like character of the solid that separated, which was easily detected by rubbing the stirrer up and down in the freezing-tube. In all cases it could be detected by the behavior of the thermometer as more and more of the solid was allowed to separate. When the cryohydric point was once reached, the thermometer remained stationary as more and more of the solid separated. Otherwise, the thermometer would fall as more and more pure ice separated and increased the concentration of the solution. That solid solutions were formed seems highly improbable.

The *conductivities* of the solution were measured at  $0^{\circ}$ , in order to be able to ascertain, as nearly as possible, the dissociation at that temperature. The most concentrated solutions were placed in the form of cell seen in fig. 18. The value of  $\mu_{\infty}$  was determined directly, whenever it was practicable to do so, simply by increasing the dilution of the solution until the molecular conductivity reached a maximum constant value. In other cases the value of  $\mu_{\infty}$  was obtained from the velocities of the ions in question and Kohlrausch's law,  $\mu_{\infty} = a + c$ .

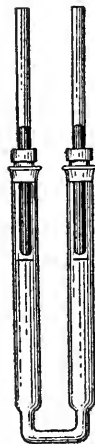

FIG. 18.

It is well known that the conductivity method is not an accurate measure of dissociation in concentrated solutions. It is, however, an approximate method of measuring such dissociations, and is the best we can do at present. All that can be said is, that it probably gives values of the right order of magnitude.

Since concentrated solutions contain, in a liter of solution, less than 1,000 grams of water, it is necessary to determine the *specific gravities* of all such solutions, in order to correct the freezing-point lowering actually observed for the difference between the amount of water really present in the solution and 1,000 grams of water. The observed freezing-point lowering, thus corrected, can then be compared directly with the freezing-point constant of water, increased in terms of the percentage dissociation of the solution in question.

## CALCULATION OF THE APPROXIMATE COMPOSITION OF THE HYDRATES.

Given the above data, the calculation of the approximate amount of water in combination with the dissolved substance is simple. The observed molecular lowering is corrected for the difference between 1,000 grams and the amount of water actually present in 1 liter of the solution. This gives the true molecular lowering, produced by the substance at the dilution in question, if there were 1,000 grams of water present.

The calculated molecular lowering can now be compared directly with the corrected, observed molecular lowering. If there was no hydration these two values would be equal. The magnitude of the hydration is obtained as follows:

The calculated molecular lowering is divided by the corrected molecular lowering found. This ratio, multiplied by 1,000, gives the amount of water present playing the rôle of solvent, if the quantity of the substance present was dissolved in 1,000 grams of water.

The difference between this amount of water and 1,000 grams, is the quantity that is in combination with the dissolved substance, under the conditions that obtain in the solution in question.

For a number of reasons everything is referred to 1,000 grams of the solvent. The theoretical freezing-point constant is calculated for 1,000 grams of the solvent and, by calculating the depression found for the same amount of the solvent, the two sets of results are comparable. Further, by referring everything to a constant amount of the solvent, the various results can be compared directly with one another.

If we know the number of grams of water that have combined with the dissolved substance, the number of gram-molecules of water that have entered into combination is obtained by dividing the above value by 18. If we divide this value by the concentration in terms of normal, we obtain the number of molecules of water in combination with one molecule of the dissolved substance, when the amount of substance present in a liter of the solution is dissolved in 1,000 grams of water.

## THE RESULTS.

In order to calculate the composition of the hydrates formed by any given substance, at different dilutions, it is necessary to have the following values:

The lowering of the freezing-point produced by the dissolved substance.

The conductivity of the solution as an approximate measure of its dissociation.

The specific gravities of the solutions, in order to calculate the difference between 1,000 grams of water and the amount contained in a liter of the solution.

In the various tables of data the symbols have the following significance:

In the tables of freezing-point measurements  $m$  is the concentration in terms of gram-molecules per liter;  $d$  the observed freezing-point lowering corrected for the separation of ice, and  $\frac{d}{m}$  the molecular lowering of the freezing-point.

In the conductivity tables the symbols have the usual significance;  $v$  is the volume of the solution, or the number of liters that contain a gram-molecular weight of the electrolyte;  $\mu_v$  is the molecular conductivity;  $a$  is the approximate dissociation.

In the refractivity tables  $m$  is the concentration,  $\lambda$  is the angle as read, and  $n$  is the index of refraction.

In the specific gravity tables  $m$  is the concentration;  $W_{\text{Sol}}$  the weight of 25 cc. of the solution;  $W_{\text{Salt}}$  the weight of the salt contained in 25 cc. of the solution; and  $W_{\text{H}_2\text{O}}$  the weight of water contained in 25 cc. of the solution. The percentage correction is the correction that must be applied to the freezing-point lowering, in order to refer it to 1,000 grams of solvent, instead of the amount of water that is present in a liter of the solution in question.

The symbols in the hydrate tables have the following significance:  $m$  is the concentration in terms of gram-molecules per liter;  $a$  the approximate dissociation of the solution;  $L$  the theoretical molecular lowering of the freezing-point referred to 1,000 grams of the solvent;  $\frac{d}{m}$  the molecular lowering found experimentally;  $L'$  the corrected molecular lowering;  $m'$  the number of gram-molecules of water in combination, both being referred to 1,000 grams of water;  $H$  the number of molecules of water in combination with one molecule of the salt at the concentration in question, if a liter of the solution, at that concentration, contained 1,000 grams of water.

In order to ascertain the number of molecules of water actually in combination with one molecule of the dissolved substance, at the concentration given, it is only necessary to divide the value of  $m'$  for that concentration by the concentration expressed in terms of a gram-molecular weight in 1,000 grams of the solvent. The difference between the values of  $H$  found by these two methods is generally quite negligible, being smaller than experimental errors. It becomes appreciable only when the "correction" per cent is large, *i. e.*, in very concentrated solutions.

## COMPOUNDS THAT HAVE BEEN STUDIED.

LiCl. 2H <sub>2</sub> O.	CaBr <sub>2</sub> . 6H <sub>2</sub> O.	CuCl <sub>2</sub> . 2H <sub>2</sub> O.
LiBr. 3H <sub>2</sub> O.	CaI <sub>2</sub> . ?	Cu(NO <sub>3</sub> ) <sub>2</sub> . 6H <sub>2</sub> O.
LiI. 3H <sub>2</sub> O.	Ca(NO <sub>3</sub> ) <sub>2</sub> . 4H <sub>2</sub> O.	CuSO <sub>4</sub> . 5H <sub>2</sub> O.
LiNO <sub>3</sub> . 2½H <sub>2</sub> O.		
	SrCl <sub>2</sub> . 6H <sub>2</sub> O.	AlCl <sub>3</sub> . 6H <sub>2</sub> O.
NaCl.	SrBr <sub>2</sub> . 6H <sub>2</sub> O.	Al(NO <sub>3</sub> ) <sub>3</sub> . 8H <sub>2</sub> O.
NaBr. 2H <sub>2</sub> O.	SrI <sub>2</sub> . 6H <sub>2</sub> O.	Al <sub>2</sub> (SO <sub>4</sub> ) <sub>3</sub> . 9H <sub>2</sub> O.
NaI. 2H <sub>2</sub> O.	Sr(NO <sub>3</sub> ) <sub>2</sub> . 4H <sub>2</sub> O.	
NaNO <sub>3</sub> .		CrCl <sub>2</sub> . 6H <sub>2</sub> O.
	BaCl <sub>2</sub> . 2H <sub>2</sub> O.	Cr(NO <sub>3</sub> ) <sub>3</sub> . 9H <sub>2</sub> O.
Na <sub>2</sub> SO <sub>4</sub> . { 7H <sub>2</sub> O.	BaBr <sub>2</sub> . 2H <sub>2</sub> O.	
{ 10H <sub>2</sub> O.	BaI <sub>2</sub> . 2H <sub>2</sub> O.	FeCl <sub>3</sub> . 6H <sub>2</sub> O.
		Fe(NO <sub>3</sub> ) <sub>3</sub> . 9H <sub>2</sub> O.
Na <sub>2</sub> CO <sub>3</sub> . { 7H <sub>2</sub> O.		
{ 10H <sub>2</sub> O.		
Na <sub>2</sub> CrO <sub>4</sub> . 10H <sub>2</sub> O.	MgCl <sub>2</sub> . 6H <sub>2</sub> O.	HCl.
Na <sub>2</sub> Cr <sub>2</sub> O <sub>7</sub> . 2H <sub>2</sub> O.	MgBr <sub>2</sub> . 6H <sub>2</sub> O.	HBr.
Na <sub>2</sub> HPO <sub>4</sub> . 12H <sub>2</sub> O.	Mg(NO <sub>3</sub> ) <sub>2</sub> . 6H <sub>2</sub> O.	HNO <sub>3</sub> .
NaNH <sub>4</sub> HPO <sub>4</sub> . 4H <sub>2</sub> O.	MgSO <sub>4</sub> . 7H <sub>2</sub> O.	
		H <sub>2</sub> SO <sub>4</sub> .
CH <sub>3</sub> COONa. H <sub>2</sub> O.	ZnCl <sub>2</sub> { H <sub>2</sub> O.	H <sub>2</sub> Cr <sub>2</sub> O <sub>7</sub> .
NaOH.	{ 3H <sub>2</sub> O.	H <sub>3</sub> PO <sub>4</sub> .
	Zn(NO <sub>3</sub> ) <sub>2</sub> . 6H <sub>2</sub> O.	
	ZnSO <sub>4</sub> . 7H <sub>2</sub> O.	Methyl alcohol.
KCl.		Ethyl alcohol.
KBr.		N-Propyl alcohol.
KI.	CdCl <sub>2</sub> . 2H <sub>2</sub> O.	Acetone.
KNO <sub>3</sub> .	CdBr <sub>2</sub> .	Acetamide.
K <sub>2</sub> SO <sub>4</sub> .	CdI <sub>2</sub> .	Urea.
K <sub>2</sub> CO <sub>3</sub> .	Cd(NO <sub>3</sub> ) <sub>2</sub> . 4H <sub>2</sub> O.	Chloral hydrate.
KH <sub>2</sub> PO <sub>4</sub> .	CdSO <sub>4</sub> . 7H <sub>2</sub> O.	Glycerol.
K <sub>3</sub> Fe(CN) <sub>6</sub> .		Glucose.
K <sub>4</sub> Fe(CN) <sub>6</sub> . 3H <sub>2</sub> O.	MnCl <sub>2</sub> . 4H <sub>2</sub> O.	Fructose.
KOH.	Mn(NO <sub>3</sub> ) <sub>2</sub> . 6H <sub>2</sub> O.	Mannite.
2KCl.CuCl <sub>2</sub> .2H <sub>2</sub> O.	MnSO <sub>4</sub> . 7H <sub>2</sub> O.	Lactose.
		Cane sugar.
NH <sub>4</sub> Cl.	NiCl <sub>2</sub> . 6H <sub>2</sub> O.	
NH <sub>4</sub> NO <sub>3</sub> .	Ni(NO <sub>3</sub> ) <sub>2</sub> . 6H <sub>2</sub> O.	Acetic acid.
(NH <sub>4</sub> ) <sub>2</sub> SO <sub>4</sub> .	NiSO <sub>4</sub> . 7H <sub>2</sub> O.	Oxalic acid.
2NH <sub>4</sub> Cl.CuCl <sub>2</sub> .2H <sub>2</sub> O.		Succinic acid.
NH <sub>4</sub> OH.	CoCl <sub>2</sub> . 6H <sub>2</sub> O.	Tartaric acid.
	Co(NO <sub>3</sub> ) <sub>2</sub> . 6H <sub>2</sub> O.	Citric acid.
CaCl <sub>2</sub> . 6H <sub>2</sub> O.	CoSO <sub>4</sub> . 7H <sub>2</sub> O.	

## LITHIUM CHLORIDE.

The concentration of the mother-solution of lithium chloride was determined volumetrically by means of a standard solution of silver nitrate. The dilutions were made in the usual manner. Owing to the limited supply of this salt it was impossible to carry the determinations beyond normal concentration.

TABLE 2.—LITHIUM CHLORIDE.

Freezing-point measurements.			Conductivity measurements.		Refractivities.		
<i>m</i>	<i>J</i>	$\frac{J}{m}$	<i>v</i>	$\mu_v 0^\circ$	<i>m</i>	$\lambda$	<i>n</i>
0.06	0.240°	4.067°	16.95	53.75	0.06	67° 22'	1.32438
0.12	0.440	3.667	8.47	50.42	0.12	67 16	1.32585
0.24	0.862	3.592	4.22	46.76	0.24	67 00	1.32711
0.59	2.242	3.800	1.67	42.28	0.59	66 21	1.33021
1.18	4.799	4.066	0.88	35.58	1.18	65 19	1.33526

## LITHIUM BROMIDE.

TABLE 3.—LITHIUM BROMIDE.

Freezing-point measurements.			Conductivity measurements ( $\mu_\infty 0^\circ = 61$ ).		
<i>m</i>	<i>J</i>	$\frac{J}{m}$	<i>v</i>	$\mu_v 0^\circ$	<i>a</i>
0.121	0.460°	3.80°	0.21	26.00	42.0
0.242	0.905	3.74	0.26	29.35	48.0
0.484	1.940	4.07	0.51	37.30	61.0
0.969	4.275	4.41	1.03	44.15	72.0
1.940	10.300	5.31	2.06	46.40	76.0
3.880	30.500	7.86	4.13	52.07	85.0
4.850	44.000	9.09	8.26	52.84	87.0

Refractivities.			Specific gravities.				
<i>m</i>	$\lambda$	<i>n</i>	<i>m</i>	W <sub>sol</sub>	W <sub>salt</sub>	W <sub>H<sub>2</sub>O</sub>	Correction, per cent.
0.121	67° 00'	1.32711	0.121	25.1337	0.2631	24.8706	0.52
0.242	66 40	1.32869	0.242	25.3706	0.5263	24.8443	0.62
0.484	66 00	1.33191	0.484	25.6894	1.0527	24.6367	1.45
0.969	64 45	1.33810	0.969	26.4362	2.1105	24.3257	2.70
1.94	62 20	1.35062	1.940	27.9251	4.2195	23.7056	5.18
3.88	58 00	1.37455	3.880	30.8842	8.4390	22.4452	6.22
			4.850	32.1521	10.5487	21.6034	13.59

Hydrates.						
<i>m</i>	<i>a</i>	L	$\frac{J}{m}$	L'	<i>m'</i>	H
0.121	0.87	3.49	3.80	3.78 †	....	....
0.242	0.85	3.43	3.74	3.72	4.3	17.8
0.484	0.76	3.27	4.01	3.95	9.6	19.8
0.969	0.72	3.20	4.41	4.30	12.9	13.3
1.940	0.61	2.99	5.31	5.04	22.8	11.8
3.880	0.48	2.75	7.89	7.40	34.9	9.0
4.850	0.42	2.64	9.07	7.84	36.8	7.6

## LITHIUM IODIDE.

The total amount of water in combination with the salt increases with the concentration of the solution in a fairly regular manner. The number of molecules of water in combination with one molecule of the salt increases from the most concentrated to the most dilute solution.

TABLE 4.—LITHIUM IODIDE.

Freezing-point measurements.			Conductivity measurements ( $\mu\infty 0^\circ = 62.0$ ).			
$m$	$d$	$\frac{d}{m}$	$v$	$\mu_v 0^\circ$	$a$	
0.080	0.296°	3.70°	0.18	23.63	39.1	
0.161	0.588	3.65	0.31	34.27	55.4	
0.322	1.218	3.79	0.38	42.00	67.7	
0.645	2.700	4.19	0.77	42.50	68.5	
1.290	6.140	4.75	1.55	46.44	74.9	
2.580	16.200	6.28	3.10	49.50	79.8	
3.22	25.000	7.76	6.21	49.65	80.1	
5.16	59.000	11.43	12.50	51.40	82.9	
Specific gravities.						
$m$	W <sub>Sol</sub>	W <sub>Salt</sub>	W <sub>H<sub>2</sub>O</sub>	Correction, per cent.		
0.080	25.1427	0.2678	24.8749	0.50		
0.161	25.3482	0.5389	24.8093	0.76		
0.322	25.7813	1.0779	24.7034	1.19		
0.645	26.6130	2.1341	24.4789	2.08		
1.29	28.1726	4.3183	23.8533	4.59		
2.58	31.2754	8.6365	22.5389	9.84		
3.22	32.9292	10.7789	22.1503	11.40		
5.16	37.5566	17.2731	20.2835	18.87		
Hydrates.						
$m$	$a$	L	$\frac{d}{m}$	L'	$m'$	H
0.080	0.829	3.40	3.70	3.68	4.23	52.8
0.161	0.801	3.35	3.65	3.63	4.29	26.6
0.322	0.798	3.34	3.79	3.75	6.07	18.5
0.645	0.749	3.25	4.19	4.10	11.52	17.8
1.29	0.685	3.13	4.75	4.54	17.25	13.4
2.58	0.677	3.12	6.28	5.67	24.99	9.7
3.22	0.554	2.89	7.76	6.88	32.22	10.0
5.60	0.391	2.59	11.43	9.27	40.03	7.15

## LITHIUM NITRATE.

The sample of lithium nitrate used was obtained in well-crystallized form. It was heated to 120° C. for several days in an air-bath, and was then allowed to cool in a desiccator over calcium chloride. When cool,



the mother-solution was prepared by direct weighing of the salt, care being taken to make the weighing as quickly as possible after the removal of the salt from the desiccator. Owing to the limited supply of this salt the mother-solution contained only one gram-molecule of dissolved substance in a liter.

TABLE 5.—LITHIUM NITRATE.

Freezing-point measurements.			Conductivity measurements.	
$m$	$\Delta$	$\frac{\Delta}{m}$	$v$	$\mu_v 0^\circ$
0.05	0.183°	3.660°	20.00	50.00
0.10	0.353	3.530	10.00	47.56
0.20	0.722	3.610	5.00	45.91
0.30	1.094	3.647	3.33	44.05
0.40	1.462	3.655	2.50	43.90
0.50	1.855	3.710	2.00	42.50
0.60	2.267	3.778	1.67	40.81
0.70	2.663	3.804	1.43	39.91
0.80	3.135	3.919	1.25	39.89
0.90	3.557	3.952	1.11	37.74

## SODIUM CHLORIDE.

The sodium chloride used was prepared from ordinary salt by precipitation from concentrated solution by means of hydrochloric acid gas. The salt thus obtained was washed with a little cold water, and was then dried at 120° C. in an air-bath. The 3 N, 2 N, and N solutions were made up by direct weighing, the latter serving as the mother-solution for the lesser concentrations.

TABLE 6.—SODIUM CHLORIDE.

Freezing-point measurements.				
$m$	$\frac{\Delta}{m}$ Loomis.*	$\frac{\Delta}{m}$ Jones †	Jones and Getman.	
			$\Delta$	$\frac{\Delta}{m}$
0.05	3.531°	3.52°	.....	.....
0.06	3.529	.....	.....	.....
0.07	3.510	.....	.....	.....
0.08	3.501	.....	.....	.....
0.09	3.494	.....	.....	.....
0.10	3.484	3.47	.....	.....
0.20	3.439	3.42	.....	.....
0.5	.....	.....	1.759°	3.518°
1.0	.....	.....	3.546	3.546
2.0	.....	.....	7.467	3.734
3.0	.....	.....	12.223	4.074

\*Phys. Rev., 1, 279 (1893).

†Ztschr. phys. Chem., 11, 110 (1893).

TABLE 6.—SODIUM CHLORIDE—Continued.

Conductivity measurements.		Refractivities.		
$v$	$\mu_v 0^\circ$	$m$	$\lambda$	$n$
5.000	51.84	0.2	67° 01'	1.32703
2.000	48.62	0.5	66 24	1.32997
1.000	47.16	1.0	65 26	1.33469
0.500	43.14	2.0	63 37	1.34389
0.333	36.59	3.0	61 59	1.35249

## SODIUM BROMIDE.

TABLE 7.—SODIUM BROMIDE.

Freezing-point measurements.			Conductivity measurements ( $\mu_\infty 0^\circ = 64.48$ ).		
$m$	$L$	$\frac{L}{m}$	$v$	$\mu_v 0^\circ$	$a$
0.07	0.245°	3.77°	0.27	34.52	53.5
0.13	0.462	3.55	0.32	37.78	58.6
0.26	0.907	3.49	0.38	40.26	62.4
0.52	1.842	3.54	0.48	43.39	67.3
1.03	3.815	3.70	0.64	46.07	71.4
1.55	6.200	4.00	0.97	48.31	74.9
2.07	8.610	4.16	1.92	51.12	79.3
2.59	11.350	4.36	3.85	54.00	83.7
3.10	14.000	4.52	7.69	55.38	85.8
3.62	18.000	4.98	15.38	59.02	91.5

## Specific gravities.

$m$	$W_{\text{Sol}}$	$W_{\text{Salt}}$	$W_{\text{H}_2\text{O}}$	Correction, per cent.
0.07	25.1144	0.1802	24.9342	0.26
0.13	25.2390	0.3348	24.9042	0.38
0.26	25.4923	0.6695	24.8228	0.71
0.52	25.9538	1.3390	24.6128	1.54
1.03	27.0571	2.6780	24.3791	2.48
1.55	28.0156	3.9912	24.0244	3.90
2.07	29.0257	5.3302	23.6955	5.22
2.59	29.9884	6.6942	23.2942	6.82
3.10	30.9610	7.9825	22.9788	8.09
3.62	31.9614	9.3215	22.6399	9.44

## Hydrates.

$m$	$a$	$L$	$\frac{L}{m}$	$L'$	$m'$	$H$
0.07	0.915	3.56	3.77	3.76	2.96	42.20
0.13	0.858	3.46	3.55	3.54	1.26	9.66
0.26	0.837	3.42	3.49	3.47	0.43	1.65
0.52	0.793	3.32	3.54	3.49	2.70	5.20
1.03	0.749	3.25	3.70	3.61	5.54	5.38
1.55	0.714	3.19	4.00	3.84	9.40	6.07
2.07	0.673	3.11	4.16	3.94	11.70	5.65
2.59	0.624	3.02	4.36	4.06	14.23	5.49
3.10	0.586	2.95	4.52	4.15	16.06	5.18
3.62	0.535	2.86	4.98	4.51	20.33	5.62

## SODIUM IODIDE.

TABLE 8.—SODIUM IODIDE.

Freezing-point measurements.			Conductivity measurements.		
<i>m</i>	<i>l</i>	$\frac{l}{m}$	<i>v</i>	$\mu_v 0^\circ$	<i>a</i>
0.083	0.314°	3.76°	0.15	19.69	31.0
0.167	0.595	3.56	0.18	26.43	42.0
0.334	1.186	3.55	0.21	30.83	49.0
0.669	2.437	3.64	0.25	34.97	56.0
1.338	5.370	4.01	0.29	37.41	59.0
2.007	8.700	4.34	0.37	41.77	67.0
2.676	12.720	4.75	0.50	45.50	73.0
3.345	18.000	5.38	0.75	46.50	74.0
4.014	23.000	5.65	1.49	50.28	80.0
4.683	29.500	6.30	2.98	53.21	85.0
			6.00	56.75	91.0
			12.05	58.66	94.0

Refractivities.			Specific gravities.				
<i>m</i>	$\lambda$	<i>n</i>	<i>m</i>	W <sub>Sol</sub>	W <sub>Salt</sub>	W <sub>H<sub>2</sub>O</sub>	Correction per cent.
0.083	66° 57'	1.32735	0.083	25.1829	0.3112	24.8717	0.51
0.167	66 33	1.32925	0.167	25.4127	0.6262	24.7865	0.85
0.334	65 49	1.33280	0.334	25.9057	1.2525	24.6532	1.39
0.669	64 22	1.34004	0.669	26.8641	2.5088	24.3553	2.58
1.338	61 33	1.35481	1.338	28.7856	5.0175	23.7681	4.93
2.007	59 20	1.36868	2.007	30.6241	7.5262	23.0979	7.61
2.676	56 30	1.38319	2.676	32.5596	10.0350	22.5240	9.90
3.345	54 15	1.39639	3.345	34.3926	12.5437	21.8489	12.60
4.014	51 53	1.41053	4.014	36.2184	15.0525	21.1659	15.34
4.683	49 31	1.42481	4.683	38.1687	17.5612	20.6075	17.57
5.352	47 10	1.43903					
6.693	42 39	1.46613					

Hydrates.						
<i>m</i>	<i>a</i>	<i>L</i>	$\frac{l}{m}$	<i>L'</i>	<i>m'</i>	<i>H</i>
0.083	0.94	3.61	3.78	3.76	....	0
0.167	0.91	3.55	3.56	3.53	....	0
0.334	0.85	3.44	3.55	3.50	....	0
0.669	0.80	3.35	3.64	3.55	3.1	4.6
1.336	0.74	3.24	4.01	3.81	8.3	6.2
2.007	0.73	3.22	4.34	4.01	10.9	5.4
2.676	0.67	3.11	4.75	4.28	15.2	5.7
3.345	0.59	2.96	5.38	4.70	20.5	6.1
4.014	0.56	2.90	5.65	4.79	21.9	5.4
4.683	0.49	2.77	6.30	5.19	25.9	5.3

## SODIUM NITRATE.

The sample of sodium nitrate used was purified by repeated crystallizations. The purified salt was dried at 110° C. in an air-bath, and preserved over calcium chloride in a desiccator until required. The mother-solution was made up by direct weighing, and the other solutions obtained from this by dilution.

TABLE 9.—SODIUM NITRATE.

Freezing-point measurements.				Conductivity measurements.	
<i>m</i>	$\frac{\Delta}{m}$ Loomis.	Jones and Getman.		<i>v</i>	$\mu_v 0^\circ$
		$\Delta$	$\frac{\Delta}{m}$		
0.05	3.440°	.....	.....	2.000	44.90
0.10	3.428	.....	.....	1.000	40.41
0.20	3.345	.....	.....	0.667	36.90
1.00	.....	3.198°	3.198°	0.500	34.16
1.50	.....	4.669	3.113	0.400	30.96
2.00	.....	6.147	3.074		
2.50	.....	7.468	2.987		
3.00	.....	8.909	2.969		

## SODIUM SULPHATE.

The salt used was heated to 120° C. for several days, and was then removed from the air-bath and finely pulverized.

TABLE 10.—SODIUM SULPHATE.

Freezing-point measurements.				Conductivity measurements.		Refractivities.		
<i>m</i>	$\frac{\Delta}{m}$ Loomis.*	Jones and Getman.		<i>v</i>	$\mu_v 0$	<i>m</i>	$\lambda$	<i>n</i>
		$\Delta$	$\frac{\Delta}{m}$					
0.05	4.590°	.....	.....	20.00	93.06	0.05	67° 13'	1.32609
0.10	4.340	.....	.....	10.00	84.92	0.10	66 58	1.32727
0.20	4.071	.....	.....	5.00	73.09	0.20	66 30	1.32949
0.30	3.875	.....	.....	2.00	60.54	0.50	65 20	1.33518
0.50	.....	1.839°	3.678°	1.00	47.13	1.00	63 37	1.34389
				0.67	36.82	1.50	62 05	1.35195
				0.50	28.54	2.00	60 43	1.35934

\* Phys. Rev., 3, 277 (1896).

## SODIUM CARBONATE.

TABLE 11.—SODIUM CARBONATE.

Freezing-point measurements.					Conductivity measurements.		Refractivities.		
<i>m</i>	$\frac{d}{m}$ Loomis.	$\frac{d}{m}$ Jones.	Jones and Getman.		<i>v</i>	$\mu_v 0^\circ$	<i>m</i>	$\lambda$	<i>n</i>
			<i>d</i>	$\frac{d}{m}$					
0.05	4.640°	4.67°	.....	.....	20	85.80	0.05	67° 14'	1.32601
0.10	4.416	4.45	.....	.....	10	76.80	0.10	66 57	1.32735
0.20	4.170	4.45	.....	.....	5	66.90	0.20	66 29	1.32957
0.50	.....	.....	1.882°	3.764°	2	53.10	0.50	65 12	1.33584
					1	39.14	1.00	63 20	1.34536
					0.5	24.53	2.00	60 13	1.36209

## SODIUM CHROMATE.

Sodium chromate, being fairly soluble, was brought within the scope of this work. It was not expected that the chromates would give normal results, but, like the sulphates, would behave abnormally. It is quite possible that the chromate is somewhat polymerized and that this is offset by the hydration. The results would indicate the power to combine with a small amount of water in the more concentrated solutions. Solutions of greater concentrations could not be used, on account of the salt separating out at the low temperatures.

TABLE 12.—SODIUM CHROMATE.

Freezing-point measurements.			Conductivity measurements.		
<i>m</i>	<i>d</i>	$\frac{d}{m}$	<i>v</i>	$\mu_v 0^\circ$	<i>a</i>
0.1	0.450°	4.50°	1.00	53.95	45.0
0.2	0.850	4.25	1.25	57.59	48.0
0.3	1.230	4.10	2.00	69.00	57.5
0.4	1.604	4.01	2.50	72.50	60.4
0.5	1.960	3.92	3.33	76.00	63.5
0.6	2.345	3.90	5.00	80.00	66.7
0.8	3.063	3.83	10.00	89.40	74.5
1.0	3.800	3.80	20.00	97.00	80.8

TABLE 12.—SODIUM CHROMATE—Continued.

Specific gravities.				
<i>m</i>	W <sub>Sol</sub>	W <sub>Salt</sub>	W <sub>H<sub>2</sub>O</sub>	Correction, per cent.
0.05	25.1875	0.2028	24.9847	0.06
0.10	25.3800	0.4055	24.9745	0.10
0.20	25.7175	0.8110	24.9065	0.37
0.30	26.0600	1.2165	24.8435	0.62
0.40	26.4025	1.6220	24.7805	0.88
0.50	26.7325	2.0275	24.7050	1.18
0.60	27.0850	2.4330	24.6520	1.39
0.80	27.7500	3.2440	24.5060	1.98
1.00	28.4150	4.0550	24.3600	2.56

Hydrates.						
<i>m</i>	<i>a</i>	L	$\frac{L}{m}$	L'	<i>m'</i>	H
0.05	0.808	4.86	4.86	4.86	....	....
0.10	0.745	4.63	4.50	4.50	....	....
0.20	0.667	4.34	4.25	4.23	....	....
0.30	0.635	4.22	4.10	4.07	....	....
0.40	0.604	4.11	4.01	3.97	....	....
0.50	0.575	4.00	3.92	3.87	....	....
0.60	0.543	3.88	3.91	3.86	....	....
0.80	0.480	3.64	3.83	3.75	1.67	2.10
1.00	0.450	3.53	3.80	3.70	2.55	2.55

## SODIUM DICHROMATE.

Sodium dichromate was quite readily soluble in water at ordinary temperatures, but at the freezing-points the solubility was greatly diminished. We could, therefore, work only with fairly dilute solutions. The results show very considerable hydrating power on the part of sodium dichromate, which increases with fair regularity from the most concentrated to the most dilute solution. The results for the dichromate can not, of course, be compared with those for the chromate, as the two compounds are salts of such different acids. The dichromate behaves about as would be expected.

TABLE 13.—SODIUM DICHROMATE.

Freezing-point measurements.			Conductivity measurements ( $\mu_{\infty} 0^{\circ} = 125.5$ ).		
<i>m</i>	<i>L</i>	$\frac{L}{m}$	<i>v</i>	$\mu_v 0^{\circ}$	<i>a</i>
0.1	0.490°	4.90°	2.50	81.5	65.0
0.2	0.946	4.73	3.33	85.7	68.2
0.3	1.400	4.66	5.00	89.0	71.0
0.4	1.872	4.68	10.00	95.0	75.7
			20.00	100.8	80.5

TABLE 13.—SODIUM DICHROMATE—Continued.

Specific gravities.				
<i>m</i>	W <sub>Sol</sub>	W <sub>Salt</sub>	W <sub>H<sub>2</sub>O</sub>	Correction, per cent.
0.05	25.2375	0.3304	24.9071	0.37
0.10	25.4750	0.6607	24.8143	0.74
0.20	25.9425	1.3215	24.6210	1.52
0.30	26.4200	1.9822	24.4378	2.25
0.40	26.8900	2.6430	24.2470	3.01
0.60	27.8050	3.9644	23.8406	4.64
0.80	28.7275	5.2860	23.4415	6.23
1.00	29.6225	6.6075	23.0150	7.94
1.25	30.7125	8.2594	22.4531	10.19

Hydrates.						
<i>m</i>	<i>a</i>	L	$\frac{d}{m}$	L'	<i>m'</i>	H
0.10	0.757	4.68	4.90	4.86	2.05	20.5
0.20	0.710	4.50	4.73	4.66	1.94	9.7
0.30	0.682	4.40	4.66	4.56	1.94	6.5
0.40	0.650	4.28	4.68	4.54	3.16	7.9

## DISODIUM PHOSPHATE.

Disodium phosphate was an especially interesting salt to study in the present connection, on account of the large amount of water with which it crystallizes. It crystallizes with more water (12 molecules) than any other salt thus far employed in this investigation. It is unfortunate that the salt has such slight solubility in water at the freezing-point of the solutions. We were not able to study solutions more concentrated than 0.1 N. The results, however, show conclusively that disodium phosphate has greater power to combine with water than any other substance that we have investigated, which is of importance in connection with the relation between water of crystallization and lowering of freezing-point.

TABLE 14.—DISODIUM PHOSPHATE.

Freezing-point measurements.			Conductivity measurements.		
<i>m</i>	<i>d</i>	$\frac{d}{m}$	<i>v</i>	$\mu_v 0^\circ$	<i>a</i>
0.10	0.427°	4.27°	10	62.8	34.9
0.05	0.237	4.74	20	70.6	39.2

Specific gravities.				
<i>m</i>	W <sub>Sol</sub>	W <sub>Salt</sub>	W <sub>H<sub>2</sub>O</sub>	Correction, per cent.
0.1	25.4325	0.3553	25.0772	-0.31
0.5	25.2580	0.1776	25.0806	0.32

TABLE 14.—DISODIUM PHOSPHATE—Continued.

Hydrates.						
<i>m</i>	<i>a</i>	L	$\frac{d}{m}$	L'	<i>m'</i>	H
0.05	0.392	3.32	4.74	4.75	16.72	334.4
0.10	0.349	3.22	4.27	4.28	13.76	137.6

## SODIUM AMMONIUM ACID PHOSPHATE.

The sodium ammonium acid phosphate crystallizes with 4 molecules of water and was, therefore, of interest from our standpoint. It combines with considerable water, especially in the dilute solutions; indeed, with just about the amount that we should expect from its water of crystallization. The phosphates, then, fall in line with the general relation between water of crystallization and lowering of freezing-point.

TABLE 15.—SODIUM AMMONIUM ACID PHOSPHATE.

Freezing-point measurements.			Conductivity measurements ( $\mu_{\infty} 0^{\circ} = 120$ ).		
<i>m</i>	<i>d</i>	$\frac{d}{m}$	<i>v</i>	$\mu_{\infty} 0^{\circ}$	<i>a</i>
0.05	0.224°	4.45°	2.50	49.1	0.409
0.10	0.420	4.20	3.33	53.1	0.443
0.20	0.773	3.87	5.00	59.5	0.500
0.30	1.088	3.63	10.00	69.0	0.575
0.40	1.408	3.52	20.00	76.7	0.639

Specific gravities.				
<i>m</i>	W <sub>Sol</sub>	W <sub>Salt</sub>	W <sub>H<sub>2</sub>O</sub>	Correction, per cent.
0.05	25.1425	0.1714	24.9711	0.12
0.10	25.2775	0.3428	24.9347	0.26
0.20	25.5500	0.6857	24.8643	0.54
0.30	25.7925	1.0285	24.7640	0.94
0.40	26.0575	1.3714	24.6861	1.26

Hydrates.						
<i>m</i>	<i>a</i>	L	$\frac{d}{m}$	L'	<i>m'</i>	H
0.05	0.639	4.24	4.45	4.45	2.61	52.2
0.10	0.575	4.00	4.20	4.19	2.50	25.0
0.20	0.500	3.72	3.87	3.85	1.88	9.4
0.30	0.443	3.51	3.63	3.60	1.39	4.6
0.40	0.409	3.38	3.52	3.48	1.55	3.0



## SODIUM ACETATE.

TABLE 16.—SODIUM ACETATE.

Freezing-point measurements.		
$m$	$\Delta$	$\frac{\Delta}{m}$
0.058	0.211°	3.64°
0.116	0.413	3.55
0.174	0.628	3.61
0.232	0.845	3.64
0.348	1.279	3.67
0.464	1.736	3.74

## SODIUM HYDROXIDE.

Sodium hydroxide was studied over as wide range of concentration as the solubility would permit. From solutions more concentrated than 6 N the solid separated. The material used was free from carbonate, and the solutions were kept in closed vessels during all of the work. The amount of water combined passes through a minimum at a concentration of about 0.3 N. From this point it increases with the concentration up to the most concentrated solution. The number of molecules of water in combination with one of the dissolved substances also passes through a minimum.

TABLE 17.—SODIUM HYDROXIDE.

Freezing-point measurements.			Conductivity measurements ( $\mu_{\infty} 0^{\circ} = 138.6$ ).		
$m$	$\Delta$	$\frac{\Delta}{m}$	$v$	$\mu_v 0^{\circ}$	$a$
0.05	0.188°	3.76°	0.125	16.07	11.6
0.10	0.358	3.58	0.143	21.67	15.6
0.20	0.693	3.47	0.166	29.28	21.1
0.30	0.992	3.31	0.200	38.27	27.6
0.40	1.334	3.34	0.250	49.67	35.8
0.60	2.030	3.38	0.333	62.30	44.9
0.80	2.727	3.41	0.500	78.50	57.0
1.00	3.465	3.465	1.000	95.50	63.7
2.00	7.400	3.70	1.250	101.00	71.9
3.00	11.750	3.92	1.660	105.00	75.0
4.00	17.000	4.25	2.500	110.00	79.1
5.00	23.000	4.60	3.330	113.00	81.3
6.00	33.000	5.50	5.000	117.00	83.2
			10.000	119.00	85.5
			20.000	121.00	87.0

TABLE 17.—SODIUM HYDROXIDE—Continued.

Specific gravities.				
<i>m</i>	W <sub>Sol</sub>	W <sub>Base</sub>	W <sub>H<sub>2</sub>O</sub>	Correction, per cent.
0.05	25.0550	0.0501	25.0049	-0.02
0.10	25.1000	0.1002	24.9998	0.00
0.20	25.2125	0.2003	25.0122	-0.05
0.30	25.3125	0.3005	25.0120	-0.05
0.40	25.4125	0.4006	25.0119	-0.05
0.60	25.6175	0.6009	25.0166	-0.07
0.80	25.8200	0.8012	25.0188	-0.07
1.00	26.0175	1.0015	25.0160	-0.06
2.00	26.9875	2.0030	24.9845	0.06
3.00	27.8925	3.0045	24.8880	0.45
4.00	28.8300	4.0060	24.8240	0.70
5.00	29.5650	5.0075	24.5575	1.77
6.00	30.3225	6.0090	24.3135	2.35
7.00	31.0900	7.0105	24.0795	3.68
8.00	31.8025	8.0120	23.7905	4.84

Hydrates.						
<i>m</i>	<i>a</i>	L	$\frac{L}{m}$	L'	<i>m'</i>	H
0.05	0.870	3.48	3.76	3.76	4.16	83.2
0.10	0.855	3.45	3.58	3.58	2.06	20.6
0.20	0.832	3.42	3.47	3.47	0.87	4.3
0.30	0.813	3.37	3.31	3.31	....	....
0.40	0.791	3.33	3.33	3.33	....	....
0.60	0.750	3.25	3.38	3.38	2.11	3.5
0.80	0.719	3.20	3.41	3.41	3.44	4.3
1.00	0.637	3.04	3.465	3.465	6.83	6.8
2.00	0.570	2.92	3.70	3.70	11.72	5.86
3.00	0.449	2.70	3.92	3.90	17.05	5.68
4.00	0.358	2.53	4.25	4.23	22.33	5.58
5.00	0.276	2.37	4.60	4.52	26.44	5.28
6.00	0.211	2.25	5.50	5.37	32.26	5.37

## POTASSIUM CHLORIDE.

The salt used was prepared by repeated crystallization from fairly pure specimens. It was then dried for several days in an air-bath at 110° C. and afterwards preserved in a desiccator over calcium chloride until it was used. From the mother-solution prepared by direct weighing, the lesser concentrations were obtained by dilution.

TABLE 18.—POTASSIUM CHLORIDE.

Freezing-point measurements.					Conductivity measurements.	
m	$\frac{J}{m}$ Loomis.	$\frac{J}{m}$ Jones.	Jones and Getman.		v	$\mu_v 0^\circ$
			J	$\frac{J}{m}$		
0.05	3.500°	3.50°	.....	.....	20.0	72.37
0.10	3.445	3.47	.....	.....	10.0	69.53
0.20	3.404	.....	.....	.....	5.0	68.71
0.30	.....	.....	.....	.....	2.0	65.21
0.40	3.353	.....	.....	.....	1.0	61.07
0.20	.....	.....	0.685°	3.425°	0.5	60.98
0.50	.....	.....	0.692	3.384		
1.00	.....	.....	3.400	3.400		
2.00	.....	.....	6.944	3.472		
3.00	.....	.....	11.062	3.687		

POTASSIUM BROMIDE.

TABLE 19.—POTASSIUM BROMIDE.

Freezing-point measurements.			Conductivity measurements.		Refractivities.		
m	J	$\frac{J}{m}$	v	$\mu_v 0^\circ$	m	$\lambda$	n
0.099	0.335°	3.35°	0.31	57.64	0.099	67° 08'	1.32648
0.199	0.670	3.35	0.42	60.10	0.199	66 49	1.32798
0.399	1.345	3.36	0.50	64.20	0.399	66 15	1.33069
0.799	2.730	3.41	0.62	64.60	0.799	65 60	1.33634
1.199	4.270	3.56	0.83	65.00	1.199	64 20	1.34174
1.598	5.850	3.65	1.25	66.95	1.598	63 00	1.34710
1.998	7.440	3.72	2.50	67.14	1.998	61 53	1.35302
2.397	9.000	3.76	5.02	69.00	2.397	60 55	1.35824
3.196	12.820	4.01	10.10	69.50	3.196	59 10	1.36794

POTASSIUM IODIDE.

TABLE 20.—POTASSIUM IODIDE.

Freezing-point measurements.			Conductivity measurements ( $\mu_\infty 0^\circ = 76.2$ ).			Refractivities.		
m	J	$\frac{J}{m}$	v	$\mu_v 0^\circ$	a	m	$\lambda$	n
0.068	0.223°	3.43°	0.22	61.2	80.0	0.068	67° 00'	1.32711
0.137	0.473	3.46	0.26	63.6	83.0	0.137	66 45	1.32829
0.273	0.945	3.46	0.30	63.8	83.8	0.273	66 50	1.33150
0.547	1.873	3.43	0.36	64.0	84.0	0.547	64 55	1.33762
1.094	3.880	3.54	0.46	64.7	85.0	1.094	62 30	1.34974
1.641	6.120	3.73	0.61	66.0	86.0	1.641	60 30	1.33053
2.188	8.500	3.88	0.91	67.0	87.0	2.188	58 30	1.37170
2.735	10.900	3.99	1.82	67.4	88.0	2.735	56 30	1.38319
3.282	13.600	4.14	3.67	69.5	91.0	3.282	54 37	1.39422
3.829	16.550	4.32	7.30	70.0	92.0	3.829	52 50	1.40482
			14.70	70.63	93.0			

## POTASSIUM NITRATE.

The specimen of potassium nitrate was obtained in a fair state of purity. This was recrystallized until it no longer gave a flame-test for sodium. It was then dried for several days at 100° C. in an air-bath, after which it was preserved in a desiccator over calcium chloride until required for use. The mother-solution was made up by direct weighing, and the remaining solutions made by dilution.

TABLE 21.—POTASSIUM NITRATE.

Freezing-point measurements.				Conductivity measurements.	
<i>m</i>	$\frac{J}{m}$ Loomis.	Jones and Getman.		<i>v</i>	$\mu_v 0^\circ$
		<i>J</i>	$\frac{J}{m}$		
0.05	3.410°	.....	.....	2.000	53.20
0.10	3.314	.....	.....	1.000	49.97
0.20	3.194	.....	.....	0.667	46.30
0.40	.....	1.258°	3.145°		
0.50	.....	1.537	3.074		
1.00	.....	2.729	2.729		

## POTASSIUM SULPHATE.

The specimen of salt used was dried for several days in the air-bath at a temperature of 120° C., and was then preserved in a desiccator over sulphuric acid until needed.

TABLE 22.—POTASSIUM SULPHATE.

Freezing-point measurements.			Conductivity measurements.		Refractivities.		
<i>m</i>	$\frac{A}{m}$ Loomis.*	$\frac{A}{m}$ Jones.†	<i>v</i>	$\mu_v 0^\circ$	<i>m</i>	$\lambda$	<i>n</i>
0.05	4.540°	4.61°	20	118.89	0.05	67° 12'	1.32616
0.10	4.317	4.28	10	109.79	0.10	66 57	1.32735
0.20	4.067	.....	5	98.88	0.20	66 30	1.32949
0.30	3.891	.....	2	88.93	0.50	65 20	1.33518

\* Phys. Rev., 3, 277 (1896).

† Ztschr. phys. Chem., 11, 527 (1893).

POTASSIUM DIHYDROGEN PHOSPHATE.

The specimen used was dried in an air-bath for three days at 100° C. and was then preserved in vacuo over sulphuric acid. The mother-solution was made up by direct weighing and the lesser concentrations obtained by dilution. Owing to the slight solubility of the salt it was found to be impossible to extend the freezing-point measurements beyond normal concentration.

TABLE 23.—POTASSIUM DIHYDROGEN PHOSPHATE.

Freezing-point measurements.				Conductivity measurements.		Refractivities.		
<i>m</i>	$\frac{d}{m}$ Loomis.*	Jones and Getman.		<i>v</i>	$\mu_v 0^\circ$	<i>m</i>	$\lambda$	<i>n</i>
		$\Delta$	$\frac{\Delta}{m}$					
0.01	3.58°	.....	.....	20.0	51.00	0.05	67° 15'	1.32593
0.02	3.60	.....	.....	10.0	46.71	0.10	67 00	1.32711
0.05	3.48	.....	.....	5.0	42.45	0.20	66 45	1.32829
0.10	3.37	.....	.....	2.0	38.24	0.50	65 50	1.33272
0.20	3.22	.....	.....	1.0	32.21	1.00	64 25	1.33978
0.50	.....	1.525°	3.050°	0.667	28.98	1.50	63 10	1.34623
1.00	.....	2.780	2.780					

\* Phys. Rev., 4, 284 (1897).

POTASSIUM CARBONATE.

TABLE 24.—POTASSIUM CARBONATE.

Freezing-point measurements.					Conductivity measurements.		Refractivities.		
<i>m</i>	$\frac{d}{m}$ Loomis.	$\frac{d}{m}$ Jones.	Jones and Getman.		<i>v</i>	$\mu_v 0^\circ$	<i>m</i>	$\lambda$	<i>n</i>
			$\Delta$	$\frac{\Delta}{m}$					
0.05	4.710°	4.75°	.....	.....	20	114.04	0.05	67° 10'	1.32632
0.06	.....	4.75	.....	.....	10	104.34	0.10	66 54	1.32758
0.10	4.540	4.62	.....	.....	5	95.54	0.20	66 26	1.32980
0.20	4.385	.....	.....	.....	2.5	87.05	0.40	65 35	1.33395
0.40	.....	.....	1.683°	4.208°	1	74.25	1.00	63 18	1.34553
1.00	.....	.....	4.375	4.375	0.5	61.57	2.00	60 12	1.36219
2.00	.....	.....	9.710	4.855					

## POTASSIUM FERRICYANIDE.

The freezing-point lowerings were small, and therefore the salt showed no hydration.

## DISSOCIATION OF POTASSIUM FERRICYANIDE.

Light could be thrown on the way in which potassium ferricyanide dissociated, by comparing the conductivity of this salt with that of potassium ferrocyanide at the same dilutions. The differences were just about what would be expected, as will be seen below, if the solutions of the ferrocyanide contained one more molecule of potassium cyanide than those of the ferricyanide. From this and the result obtained with the ferrocyanide, we conclude that potassium ferricyanide dissociates thus:



This is also in accord with the value found for  $\mu_\infty$  for this substance.

TABLE 25.—POTASSIUM FERRICYANIDE.

Freezing-point measurements.			Conductivity measurements.		Specific gravities.				
<i>m</i>	<i>d</i>	$\frac{d}{m}$	<i>v</i>	$\mu$ 0°	<i>m</i>	W <sub>Sol</sub>	W <sub>Salt</sub>	W <sub>H<sub>2</sub>O</sub>	Correc- tion, per cent.
0.05	0.30°	6.00°	2.50	146.1	0.05	25.2408	0.4121	24.8287	0.69
0.1	0.56	5.60	3.33	149.2	0.1	25.5037	0.8242	24.6795	1.28
0.2	1.086	5.43	5.00	154.3	0.2	25.9084	1.6483	24.2601	2.96
0.3	1.57	5.23	10.00	162.8	0.3	26.3277	2.4725	23.8552	4.58
0.4	2.05	5.12	20.00	172.4	0.4	26.8154	3.2966	23.5188	5.93

## POTASSIUM FERROCYANIDE.

This salt was chosen on account of the statement in the literature that it dissociates thus,  $\overset{+}{\text{K}}, \overset{+}{\text{K}}, \overset{+}{\text{K}}, \overset{+}{\text{K}}, \overline{\text{Fe}(\text{CN})_6}$ , yielding 5 ions. We shall see that this is probably wrong. The molecular lowerings of the freezing-point that were produced were small; indeed, so small that there was no evidence of any appreciable hydration in the solutions. We then took up the problem as to whether there is any appreciable time factor in the conductivity of solutions of potassium ferrocyanide. Solutions of the salt were prepared and their conductivities determined at 25°, as is shown in the accompanying table. After making these measurements the solutions were allowed to remain in the thermostat-bath for thirty minutes, and their conductivities redetermined.

<i>v</i>	$\mu_v 25^\circ$
40	369.4
80	405.5
160	447.8
320	496.2
400	507.4

No appreciable change was detected. The conductivities were measured again after the solutions had stood for four hours, and still no change of any moment manifested itself. The same result was obtained after the solutions had stood for more than twenty-four hours.

A change in the conductivity might have occurred before the first conductivity measurements were made. To test this, some of the salt was weighed in the dry conductivity cup, and a known quantity of water, which had already been brought to the temperature of the bath, added. In a very few minutes the first conductivity reading was made. The conductivity did not change an appreciable amount on allowing the solutions to stand.

$v$	$\mu_v 25^\circ$
640	530
1280	557
2560	580
5120	575

It was then decided to determine whether there is any change in the freezing-point lowering with time. Fresh solutions were prepared and their

freezing-points determined immediately. These solutions were then allowed to stand and their freezing-points determined from time to time. No change could be detected.

The value of  $\mu_\infty$  was then determined for potassium ferrocyanide, at  $25^\circ$ , with the result shown in the above table.

The value of  $\mu_\infty$  seems to have been reached at a dilution of from 3,000 to 5,000 liters.

DISSOCIATION OF POTASSIUM FERROCYANIDE.

The magnitude of this value throws some light on the question as to how potassium ferrocyanide dissociates. It is almost exactly the value that would have been obtained if potassium ferrocyanide dissociated thus:

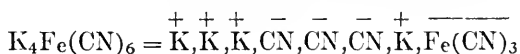

TABLE 26.—POTASSIUM FERROCYANIDE.

Freezing-point measurements.			Conductivity measurements.		Specific gravities.				
$m$	$d$	$\frac{d}{m}$	$v$	$\mu_v 0^\circ$	$m$	$W_{Sol}$	$W_{Salt}$	$W_{H_2O}$	Correction, per cent.
0.1	0.580°	5.80°	2.00	154.1	0.1	25.6794	0.9221	24.7573	0.97
0.2	1.05	5.25	2.50	156.0	0.2	26.2775	1.8442	24.4333	2.27
0.3	1.45	4.83	3.33	158.4	0.3	26.8744	2.7663	24.1081	3.57
0.4	1.78	4.45	5.00	163.4	0.4	27.5021	3.6884	23.8137	4.75
			10.00	171.8	0.5	28.0540	4.6105	23.4435	6.23

## POTASSIUM HYDROXIDE.

Potassium hydroxide, free from carbonate, was carefully preserved during the investigation in closed vessels. It could be used up to a concentration that was about 8 N. The total amount of combined water passes through a minimum at a concentration of about 0.3 N. Similarly, the number of molecules of water in combination with one molecule of the base. In general behavior, respecting its power to combine with water, potassium hydroxide is, then, strictly analogous to sodium hydroxide.

TABLE 27.—POTASSIUM HYDROXIDE.

Freezing-point measurements.			Conductivity measurements ( $\mu_{\infty} 0^{\circ} = 154.3$ ).		
<i>m</i>	$\Delta$	$\frac{\Delta}{m}$	<i>v</i>	$\mu_v 0^{\circ}$	<i>a</i>
0.05	0.183°	3.66°	0.111	32.25	20.9
0.10	0.357	3.57	0.125	38.77	25.1
0.20	0.710	3.55	0.143	48.65	31.5
0.30	1.050	3.50	0.166	56.19	36.4
0.40	1.390	3.475	0.200	65.74	42.6
0.60	2.143	3.571	0.250	77.60	50.6
0.80	2.885	3.606	0.333	88.85	58.2
1.00	3.773	3.773	0.500	102.31	66.3
2.00	8.42	4.21	1.000	116.94	75.9
3.00	14.0	4.66	1.250	118.0	76.5
4.00	22.5	5.62	1.660	123.0	79.7
5.00	32.5	6.50	2.500	126.0	82.3
6.00	43.5	7.25	3.333	128.0	83.6
7.00	57.5	8.21	5.000	131.0	85.5
8.00	76.0	9.50	10.00	132.5	86.5
			20.00	136.0	89.0
Specific gravities.					
<i>m</i>	W <sub>Sol</sub>	W <sub>Base</sub>	W <sub>H<sub>2</sub>O</sub>	Correction, per cent.	
0.05	25.0750	0.0702	25.0048	-0.02	
0.10	25.1250	0.1404	24.9846	0.06	
0.20	25.2500	0.2808	24.9692	0.12	
0.30	25.3750	0.4212	24.9538	0.18	
0.40	25.4925	0.5616	24.9309	0.28	
0.60	25.7373	0.8424	24.8949	0.42	
0.80	25.9700	1.1232	24.8458	0.62	
1.00	26.2050	1.4040	24.8010	0.80	
2.00	27.3150	2.8080	24.5070	1.97	
3.00	28.3500	4.2120	24.1380	3.45	
4.00	29.4025	5.6160	23.7865	4.85	
5.00	30.3600	7.0200	23.3400	6.64	
6.00	31.2675	8.4240	22.8435	8.63	
7.00	32.1825	9.8280	22.3545	10.58	
8.00	33.3075	11.2320	22.0755	11.71	



TABLE 27.—POTASSIUM HYDROXIDE—Continued.

Hydrates.						
<i>m</i>	<i>a</i>	L	$\frac{L}{m}$	L'	<i>m'</i>	H
0.05	0.890	3.52	3.66	3.66	2.11	42.2
0.10	0.865	3.47	3.57	3.57	1.56	15.6
0.20	0.855	3.45	3.55	3.55	1.56	7.8
0.30	0.836	3.41	3.50	3.49	1.28	4.3
0.40	0.823	3.39	3.475	3.47	1.28	3.2
0.60	0.797	3.34	3.57	3.56	3.42	5.7
0.80	0.765	3.28	3.61	3.58	4.67	5.8
1.0	0.759	3.27	3.77	3.74	6.94	6.9
2.0	0.663	3.09	4.21	4.13	14.05	7.0
3.0	0.582	2.94	4.66	4.50	19.28	6.4
4.0	0.506	2.80	5.63	5.36	26.55	6.6
5.0	0.426	2.65	6.50	6.07	31.15	6.2
6.0	0.364	2.54	7.25	6.63	34.30	5.7
7.0	0.315	2.45	8.21	7.34	37.00	5.3
8.0	0.251	2.33	9.50	8.39	40.10	5.0

POTASSIUM CUPRIC CHLORIDE.

Another salt of a complex acid which could readily be obtained in pure condition was potassium cupric chloride. This, like the corresponding ammonium salt, breaks down in solution into the two single chlorides. The total amount of water in combination increases very regularly from the most dilute to the most concentrated solution, and the number of molecules of water in combination with one of the salt, or the resulting ions, increases from the most concentrated to the most dilute solution.

TABLE 28.—POTASSIUM CUPRIC CHLORIDE.

Freezing-point measurements.			Conductivity measurements.		
<i>m</i>	<i>Δ</i>	$\frac{Δ}{m}$	<i>v</i>	$\mu_v 0^\circ$	<i>a</i>
0.05	0.623°	12.46°	1.00	127.0	44.3
0.1	1.200	12.00	1.25	143.3	50.0
0.2	2.425	12.12	1.66	159.0	55.5
0.3	3.668	12.23	2.50	183.6	64.1
0.4	5.00	12.50	3.33	186.0	65.0
0.6	7.50	12.50	5.00	196.5	68.5
0.8	10.00	12.50	10.00	212.0	74.0
1.0	13.00	13.00	20.00	228.1	79.6

TABLE 28.—POTASSIUM CUPRIC CHLORIDE—Continued.

Specific gravities.						
<i>m</i>	W <sub>Sol</sub>	W <sub>Salt</sub>	W <sub>H<sub>2</sub>O</sub>	Correction, per cent.		
0.05	25.2625	0.3546	24.9079	0.37		
0.1	25.5225	0.7092	24.8133	0.75		
0.2	26.0600	1.4184	24.6416	1.43		
0.3	26.5825	2.1276	24.4549	2.18		
0.4	27.1075	2.8368	24.2707	2.92		
0.6	28.1175	4.2552	23.8613	4.55		
0.8	29.1100	5.6736	23.4364	6.25		
1.0	30.0875	7.0920	22.9955	8.02		
Hydrates.						
<i>m</i>	<i>a</i>	L	$\frac{J}{m}$	L'	<i>m</i> '	H
0.05	0.796	10.74	12.46	12.41	7.48	149.6
0.1	0.740	10.11	12.00	11.91	8.40	84.0
0.2	0.685	9.50	12.12	11.95	11.39	56.9
0.3	0.650	9.11	12.23	11.97	13.28	44.3
0.4	0.641	9.62	12.50	12.14	14.28	35.7
0.6	0.555	8.05	12.50	11.93	18.07	30.1
0.8	0.560	7.44	12.50	11.72	20.29	25.4
1.0	0.443	6.86	13.00	11.96	23.97	24.0

## AMMONIUM CHLORIDE.

The salt used was dried for several days in a desiccator over phosphorus pentoxide. The 3 N, 2 N, and N solutions were made up by direct weighing. The less concentrated solutions were made by diluting the normal solution. This method was adopted to avoid weighing such large masses of salt.

TABLE 29.—AMMONIUM CHLORIDE.

Freezing-point measurements.				Conductivity measurements.		Refractivities.		
<i>m</i>	$\frac{J}{m}$ Loomis.	Jones and Getman.		<i>v</i>	$\mu_{20}^{\circ}$	<i>m</i>	$\lambda$	<i>n</i>
		<i>J</i>	$\frac{J}{m}$					
0.04	3.500°	.....	.....	5.0	68.94	0.2	66° 55'	1.32750
0.05	3.480	.....	.....	2.0	66.15	0.5	66 18	1.33045
0.10	3.434	.....	.....	1.0	64.35	1.0	65 15	1.33559
0.20	3.396	.....	.....	0.5	59.27	2.0	63 20	1.34536
0.40	3.393	.....	.....	0.333	58.61	3.0	61 30	1.35508
1.0	.....	3.703°	3.730°					
2.0	.....	7.550	3.775					
.0	.....	11.700	3.960					

## AMMONIUM NITRATE.

The salt was obtained in a comparatively pure condition, and was recrystallized several times. It was then dried at 100° C. and preserved until needed in a desiccator over calcium chloride. The mother-solution was prepared by direct weighing, and from it the successive dilutions were made.

TABLE 30.—AMMONIUM NITRATE.

Freezing-point measurements.				Conductivity measurements.		Refractivities.		
<i>m</i>	$\frac{d}{m}$ Loomis.	Jenes and Getman.		<i>v</i>	$\mu_v 0^\circ$	<i>m</i>	$\lambda$	<i>n</i>
		<i>d</i>	$\frac{d}{m}$					
0.025	3.490°	.....	.....	20.0	67.49	0.05	67° 22'	1.32538
0.050	3.470	.....	.....	10.0	65.05	0.10	67 21	1.32585
0.100	3.424	.....	.....	5.0	68.44	0.20	67 03	1.32687
0.200	3.321	.....	.....	2.0	60.26	0.50	66 25	1.32989
0.5	.....	1.686°	3.372°	1.0	54.97	1.00	65 24	1.33485
1.0	.....	3.145	3.148	0.5	52.81	2.00	63 30	1.34449
2.0	.....	5.996	2.998					
3.0	.....	8.720	2.906					

## AMMONIUM SULPHATE.

The salt used was purified by several crystallizations. It was dried at 100° C. in an air-bath, and was then preserved in vacuo over sulphuric acid until required. The mother-solution was made up by direct weighing, and the lesser concentrations obtained by dilution.

TABLE 31.—AMMONIUM CHLORIDE.

Freezing-point measurements.			Conductivity measurements.		Refractivities.		
<i>m</i>	<i>d</i>	$\frac{d}{m}$	<i>v</i>	$\mu_v 0^\circ$	<i>m</i>	$\lambda$	<i>n</i>
0.05	0.024°	4.80°	20	100.60	0.05	67° 15'	1.32593
0.10	0.469	4.69	10	95.84	0.10	67 00	1.32711
0.20	0.818	4.09	5	86.15	0.20	66 45	1.32829
0.50	1.969	3.94	2	80.08	0.50	65 42	1.33333
1.00	3.683	3.69	1	72.55	1.00	64 07	1.34131
1.40	5.133	3.67	0.71	69.30	1.40	62 49	1.34807

## AMMONIUM CUPRIC CHLORIDE.

Having studied a large number of the salts of simple acids, we extended our work so as to include a few salts of complex acids. We selected the double chloride of ammonium and copper, since it could readily be obtained in pure condition. When the double chlorides dissolve in water they break down, for the most part, into the single salts, as had been shown by Jones and Knight.\* The power to combine with water would then be essentially the power of the single salts to combine with it in the presence of one another.

TABLE 32.—AMMONIUM CUPRIC CHLORIDE.

Freezing-point measurements.			Conductivity measurements.		
<i>m</i>	<i>J</i>	$\frac{J}{m}$	<i>v</i>	$\mu_v 0^\circ$	<i>a</i>
0.05	0.600°	12.00°	1.00	130.4	43.6
0.1	1.214	12.14	1.25	146.1	48.9
0.2	2.515	12.57	1.66	162.9	54.5
0.3	3.964	13.21	2.50	187.4	62.7
0.4	5.500	13.75	3.33	197.6	66.1
0.6	8.700	14.50	5.00	205.6	68.7
0.8	12.000	15.00	10.00	235.1	78.5
1.0	.....	.....	20.00	248.6	83.2

Specific gravities.				
<i>m</i>	W <sub>Sol</sub>	W <sub>Salt</sub>	W <sub>H<sub>2</sub>O</sub>	Correction, per cent.
0.05	25.1975	0.2919	24.9056	0.38
0.1	25.3875	0.5837	24.8038	0.78
0.2	25.7925	1.1674	24.6251	1.50
0.3	26.2075	1.7511	24.4564	2.17
0.4	26.5875	2.3348	24.2527	2.99
0.6	27.3200	3.5022	23.8178	4.73
0.8	28.0675	4.6696	23.3979	6.41

Hydrates.						
<i>m</i>	<i>a</i>	L	$\frac{J}{m}$	L'	<i>m</i>	H
0.05	0.832	11.14	12.00	11.96	3.83	76.60
0.10	0.785	10.62	12.14	12.05	6.61	66.10
0.20	0.687	9.54	12.57	12.39	12.77	63.85
0.30	0.661	9.23	13.31	13.02	16.18	53.90
0.40	0.627	8.86	13.75	13.34	18.66	46.65
0.60	0.545	7.94	14.50	13.82	23.64	39.40
0.80	0.489	7.32	15.00?	14.04	26.59	33.23
1.00	0.436	.....	.....	.....	.....	.....

\* Amer. Chem. Journ., 22, 110 (1899).

## AMMONIUM HYDROXIDE.

Ammonium hydroxide was studied in a manner similar to that employed with the other bases. The freezing-point lowerings are small, but since the dissociation is so very slight, it nevertheless demonstrates that this compound has some power to combine with water.

TABLE 33.—AMMONIUM HYDROXIDE.

Freezing-point measurements.			Conductivity measurements ( $\mu \infty 0^\circ = 154.69$ ).		
$m$	$J$	$\frac{J}{m}$	$v$	$\mu_v 0^\circ$	$a$
0.05	0.0931 <sup>o</sup>	1.92 <sup>o</sup>	1.00	0.41	0.26
0.10	0.192	1.92	1.25	0.59	0.38
0.20	0.384	1.92	1.66	0.76	0.49
0.30	0.591	1.97	2.50	0.93	0.60
0.40	0.791	1.98	3.33	1.08	0.70
0.60	1.191	1.98	5.00	1.34	0.86
0.80	1.585	1.98	10.00	1.84	1.19
1.00	1.995	1.995	20.00	2.56	1.66
1.4036	2.855	2.04			

Specific gravities.				
$m$	$W_{Sol}$	$W_{Base}$	$W_{H_2O}$	Correction, per cent.
0.05	24.9775	0.0426	24.9349	-0.26
0.10	24.9625	0.0852	24.8773	-0.49
0.20	24.9425	0.1704	24.7721	-0.91
0.30	24.9250	0.2556	24.6694	-1.32
0.40	24.9050	0.3408	24.5642	-1.74
0.60	24.8625	0.5112	24.3513	-2.59
0.80	24.8250	0.6816	24.1434	-3.43
1.00	24.7925	0.8520	23.9405	-4.21
1.4036	24.7150	1.1928	23.5222	-5.91

Hydrates.						
$m$	$a$	$L$	$\frac{J}{m}$	$L'$	$m'$	$H$
0.05	0.0166	1.89	1.92	1.92	0.87	17.4
0.10	0.0119	1.88	1.92	1.93	1.73	17.3
0.20	0.0085	1.88	1.92	1.94	1.72	8.6
0.30	0.0070	1.87	1.97	2.00	3.61	12.0
0.40	0.0060	1.87	1.98	2.01	3.82	9.5
0.60	0.0049	1.87	1.98	2.03	4.38	7.3
0.80	0.0038	1.87	1.98	2.05	4.88	6.1
1.00	0.0026	1.86	1.995	2.08	5.88	5.9
1.4036	.....	1.86	2.04	2.16	7.72	5.5

## CALCIUM CHLORIDE.

The data for calcium chloride are given in table 34.

The freezing-point lowerings had already been determined, and a part of the conductivity measurements made. The data necessary for calculating the hydration in dilute solutions were partly lacking and these were obtained. The value of  $\mu_{\infty}$  for calcium chloride, and for a number of the other salts used in this work, was determined by Dr. West, to whom we wish to express our thanks.

From column  $m'$  it will be seen that the amount of water that has entered into combination increases with the concentration of the solution. This is just what we should expect from the law of mass action. The larger the amount of the salt present, the greater the amount of water that would be held in combination. The slight increase in the amount of water combined as we pass from 0.153 normal to 0.102 normal is to be noted, because a similar phenomenon occurs in other cases.

If we turn our attention to the number of molecules of water combined with one molecule of the dissolved substance, we shall see that this increases from the most concentrated solution to about half-normal, and then, with considerable fluctuation, does not change in any decided manner. The number of molecules of water in combination with one molecule of the dissolved substance is really of less interest and importance than the *total amount* of water held in combination by the dissolved substance; the latter has therefore been plotted in the curve against the concentrations as abscissæ. The curve shows, at a glance, that the amount of water held in combination increases, and fairly regularly, with the concentration.

TABLE 34.—CALCIUM CHLORIDE.

Freezing-point measurements.			Conductivity measurements ( $\mu_{\infty} 0^{\circ} = 138$ ).		
$m$	$\Delta$	$\frac{\Delta}{m}$	$v$	$\mu_{\infty} 0^{\circ}$	$a$
0.102	0.505°	4.98°	9.80	105.70	76.6
0.153	0.752	4.91	6.54	102.90	74.6
0.204	1.012	4.96	4.90	98.40	71.3
0.255	1.267	4.97	3.92	96.92	70.2
0.306	1.537	5.02	3.27	89.61	64.9
0.408	2.104	5.16	2.45	89.10	64.6
0.510	2.681	5.26	1.96	88.24	63.9
0.612	3.348	5.47	1.63	84.25	61.1
1.000	6.345	6.345	1.00	71.15	51.6
1.500	11.296	7.531	0.67	62.06	45.0
2.000	17.867	8.934	0.50	54.05	39.1
1.949	17.710	9.03	0.43	48.83	35.4
2.274	23.000	10.11	0.38	44.44	30.8
2.598	29.000	11.16	0.34	39.55	28.7
2.923	37.400	12.79	0.31	35.88	26.0
3.248	46.500	14.32			

TABLE 34.—CALCIUM CHLORIDE—Continued.

Specific gravities.				
<i>m</i>	<i>W</i> <sub>Sol</sub>	<i>W</i> <sub>Salt</sub>	<i>W</i> <sub>H<sub>2</sub>O</sub>	Correction, per cent.
0.102	25.2408	0.2831	24.9577	0.17
0.153	25.3166	0.4246	24.8920	0.43
0.204	25.4635	0.5661	24.8974	0.41
0.255	25.6176	0.7076	24.9100	0.36
0.306	25.7050	0.8492	24.8558	0.58
0.408	26.0032	1.1322	24.8710	0.52
0.510	26.2300	1.4152	24.8148	0.74
0.612	26.5403	1.6983	24.8420	0.63
1.000	27.3656	2.7750	24.5906	1.64
1.500	28.4996	4.1625	24.3371	2.65
2.000	29.5984	5.5500	24.0484	3.81
2.274	29.8363	6.2992	23.5371	5.85
2.598	30.4502	7.2150	23.2352	7.05
2.923	31.1440	8.0780	23.0660	7.74
3.248	31.7437	9.0188	22.7249	9.10

Hydrates.						
<i>m</i>	<i>a</i>	<i>L</i>	$\frac{A}{m}$	<i>L'</i>	<i>m'</i>	<i>H</i>
0.102	0.766	4.71	4.98	4.97	3.02	29.6
0.153	0.746	4.64	4.91	4.89	2.84	18.6
0.204	0.713	4.51	4.96	4.94	4.84	23.7
0.255	0.702	4.47	4.97	4.95	5.39	21.2
0.306	0.649	4.27	5.02	4.99	8.02	26.2
0.408	0.646	4.26	5.16	5.13	9.42	23.1
0.510	0.639	4.24	5.26	5.22	10.41	20.4
0.612	0.611	4.13	5.47	5.44	14.40	23.5
1.000	0.516	3.78	6.345	6.24	22.80	22.8
1.500	0.450	3.55	7.530	7.33	28.65	19.1
2.000	0.391	3.31	8.934	8.59	34.15	17.1
2.274	0.354	3.08	10.11	9.52	37.58	16.5
2.598	0.308	3.01	11.16	10.37	39.43	15.2
2.923	0.287	2.93	12.79	11.80	41.76	14.2
3.248	0.260	2.83	14.32	13.02	42.81	13.2

## CALCIUM BROMIDE.

What has been said in reference to calcium chloride holds largely for the bromide. Such data as were lacking were obtained, especially for dilute solutions, in order that the approximate magnitude of the hydration in such solutions could be calculated. The value of  $\mu_{\infty}$  at 0° for calcium bromide was also obtained directly by the conductivity method.

The total amount of water held in combination increases with the concentration. The bromide combines with a little more water than the chloride at the same concentrations.

TABLE 35.—CALCIUM BROMIDE.

Freezing-point measurements.			Conductivity measurements ( $\mu_{\infty} 0^{\circ} = 123.7$ )		
$m$	$d$	$\frac{d}{m}$	$v$	$\mu_{20} 0^{\circ}$	$a$
0.0435	0.228°	5.24°	22.98	107.42	86.8
0.0871	0.445	5.11	11.48	100.53	81.3
0.1306	0.664	5.07	7.66	98.29	79.5
0.1742	0.904	5.18	5.74	94.53	76.4
0.2613	1.368	5.23	3.83	93.19	75.3
0.3484	1.847	5.30	2.87	89.44	72.3
0.4355	2.397	5.50	2.30	87.59	70.8
0.5226	2.949	5.60	1.91	85.86	69.4
0.452	2.340	5.18	1.11	80.90	65.4
0.903	6.200	5.86	0.66	68.30	55.2
1.506	13.100	8.69	0.55	61.70	49.9
1.807	17.500	9.07	0.415	50.14	40.5
2.409	30.500	12.66	0.332	39.68	32.1
3.011	47.000	15.61			

Specific gravities.				
$m$	W <sub>Sol</sub>	W <sub>Salt</sub>	W <sub>H<sub>2</sub>O</sub>	Correction, per cent.
0.0435	25.1605	0.2177	24.9428	0.23
0.0871	25.3421	0.4355	24.9066	0.37
0.1306	25.5154	0.6530	24.8624	0.55
0.1742	25.7263	0.8710	24.8553	0.58
0.2613	26.0433	1.3065	24.7368	1.05
0.3484	26.3743	1.7420	24.6323	1.47
0.4355	26.7319	2.1772	24.5547	1.78
0.5226	27.0749	2.6130	24.4619	2.15
0.9030	28.7128	4.5150	24.1978	3.21
1.5060	31.1185	7.5300	23.5885	5.65
1.8070	32.3080	9.0350	23.2730	6.91
2.4090	34.6443	12.0450	22.5993	9.60
3.0110	37.0233	15.0550	21.9683	12.13

Hydrates.						
$m$	$a$	L	$\frac{L}{m}$	L'	$m'$	H
0.0435	0.868	5.13	5.24	5.23	1.06	24.4
0.0871	0.813	4.88	5.11	5.09	2.29	26.3
0.1306	0.795	4.82	5.07	5.04	2.43	18.5
0.1742	0.764	4.70	5.18	4.88	2.05	11.7
0.2613	0.753	4.66	5.23	5.18	5.58	21.3
0.3484	0.723	4.55	5.30	5.22	7.13	20.5
0.4355	0.708	4.49	5.50	5.40	9.36	21.3
0.5226	0.694	4.44	5.60	5.48	10.54	20.2
0.903	0.654	4.29	5.86	5.67	13.52	15.0
1.506	0.552	3.91	8.69	8.20	29.06	12.7
1.807	0.499	3.72	9.07	8.64	31.61	17.5
2.409	0.405	3.37	12.66	11.44	39.19	16.2
3.011	0.321	3.05	15.61	13.72	43.21	14.3



## CALCIUM IODIDE.

TABLE 36.—CALCIUM IODIDE.

Freezing-point measurements.			Conductivity measurements ( $\mu_{\infty} 0^{\circ} = 135.7$ ).			Refractivities.		
$m$	$J$	$\frac{J}{m}$	$v$	$\mu_v 0^{\circ}$	$\alpha$	$m$	$\lambda$	$n$
0.078	0.374°	4.85°	0.32	36.67	26.0	0.078	66° 36'	1.32901
0.156	0.743	4.77	0.46	56.96	32.0	0.156	65 50	1.33272
0.312	1.576	5.05	0.80	74.16	54.0	0.312	64 30	1.34021
0.624	3.820	6.12	1.60	87.50	64.0	0.624	61 25	1.35553
1.248	10.030	8.04	3.20	96.80	71.0	1.248	56 16	1.38455
2.184	27.000	12.37	6.41	103.52	76.0	2.184	49 50	1.42743
3.120	60.000	19.23	12.82	108.62	80.0	3.120	42 00	1.46998

Specific gravities.				
$m$	$W_{\text{Sol}}$	$W_{\text{Salt}}$	$W_{\text{H}_2\text{O}}$	Correction, per cent.
0.078	25.3669	0.5142	24.8527	0.59
0.156	25.8153	1.1752	24.6401	1.44
0.312	26.7369	2.2769	24.4600	2.16
0.624	28.5082	4.5539	23.9543	4.18
1.248	32.0175	9.1813	22.8362	8.66
2.184	37.1125	16.0121	21.1004	15.60
3.120	42.3317	22.9664	20.3653	18.54

Hydrates.						
$m$	$\alpha$	$L$	$\frac{J}{m}$	$L'$	$m'$	$H$
0.078	0.80	4.84	4.85	4.83	....	..
0.156	0.76	4.69	4.77	4.70	....	..
0.312	0.71	4.50	5.05	4.95	5.0	16
0.624	0.64	4.24	6.12	5.86	15.3	25
1.248	0.54	3.87	8.04	7.34	25.5	20
2.184	0.32	3.05	12.37	10.44	39.3	18
3.120	0.26	2.83	19.23	15.67	45.8	15

## CALCIUM NITRATE.

TABLE 37.—CALCIUM NITRATE.

Freezing-point measurements.			Conductivity measurements ( $\mu_{\infty} 0^{\circ} = 129.2$ ).			Refractivities.		
$m$	$J$	$\frac{J}{m}$	$v$	$\mu_v 0^{\circ}$	$a$	$m$	$\lambda$	$n$
0.042	0.200°	4.76°	0.24	7.79	6.0	0.042	67° 05'	1.32672
0.104	0.470	4.52	0.30	14.15	10.9	0.104	66 45	1.32830
0.208	0.910	4.37	0.35	18.76	14.5	0.208	66 15	1.33070
0.415	1.820	4.39	0.48	29.66	23.0	0.415	65 17	1.33576
1.038	5.070	4.89	0.60	36.38	28.2	1.038	62 25	1.35018
1.660	8.680	5.23	0.96	49.75	38.5	1.660	60 00	1.36329
2.075	11.600	5.59	2.40	68.60	53.1	2.075	58 30	1.37170
2.905	19.320	6.65	4.81	78.80	61.0	2.905	55 50	1.38707
3.320	24.320	7.33	9.61	87.46	67.7	3.320	54 32	1.39412
			23.81	98.90	76.5	4.150	52 00	1.40983
Specific gravities.								
$m$	$W_{\text{Sol}}$	$W_{\text{Salt}}$	$W_{\text{H}_2\text{O}}$	Correction, per cent.				
0.042	25.1663	0.1224	25.0439	....				
0.104	25.3200	0.4268	24.8932	0.43				
0.208	25.6555	0.8536	24.8019	0.79				
0.415	26.2587	1.7072	24.5515	1.79				
1.038	28.0253	4.2593	23.7657	4.94				
1.660	29.8093	6.8122	22.9979	8.01				
2.075	30.9030	8.5356	22.3674	9.93				
2.905	33.0470	11.9009	21.1461	15.43				
3.320	34.0689	13.6245	20.4444	18.22				
Hydrates.								
$m$	$a$	L	$\frac{J}{m}$	L'	$m'$	H		
4.150	0.060	2.10	....	....	....	..		
3.320	0.109	2.29	7.33	6.01	34.4	10		
2.905	0.145	2.43	6.65	5.62	31.6	11		
2.075	0.230	2.74	5.59	5.06	25.5	12		
1.660	0.282	2.94	5.23	4.81	21.6	13		
1.038	0.385	3.33	4.89	4.65	15.7	15		
0.415	0.531	3.88	4.39	4.32	10.2	25		
0.208	0.610	4.17	4.37	4.34	3.9	19		
0.104	0.677	4.44	4.52	4.50	....	..		
0.042	0.765	4.76	4.76	....	....	..		

## STRONTIUM CHLORIDE.

The salt was purified by repeated crystallizations, finally dried at 110° C., and preserved in a desiccator over calcium chloride until used. The mother-solution was made up by direct weighing, and then analyzed for both strontium and chlorine as a check. The dilutions were made in the usual manner.

TABLE 38.—STRONTIUM CHLORIDE.

Freezing-point measurements.					Conductivity measurements.	
<i>m</i>	$\frac{J}{m}$ Loomis.	$\frac{J}{m}$ Jones and Chambers.	Jones and Getman.		<i>v</i>	$\mu_{\infty} 0^{\circ}$
			<i>J</i>	$\frac{J}{m}$		
0.05	4.90°	5.16°	.....	.....	2.000	84.26
0.10	4.85	4.88	.....	.....	1.000	74.57
0.20	4.82	4.87	.....	.....	0.667	63.01
0.30	.....	4.90	.....	.....	0.500	55.26
0.40	.....	4.95	.....	.....		
0.50	5.08	5.09	.....	.....		
1.00	.....	.....	6.000°	6.000°		
1.50	.....	.....	10.725	7.150		
2.00	.....	.....	16.422	8.211		

## STRONTIUM BROMIDE.

Although the freezing-point lowering had been determined\* over the entire range of concentration that could be brought within this investigation, conductivity and specific gravity data had to be obtained. The value of  $\mu_{\infty}$  at  $0^{\circ}$  for strontium bromide was determined by Dr. West, and is given below.

The results are of the same general character as those obtained with calcium chloride and bromide. The amount of water held in combination increases with the concentration, from the most dilute to the most concentrated solution, and about the same quantity of water is combined as with the calcium salts at the same concentration.

TABLE 39.—STRONTIUM BROMIDE.

Freezing-point measurements.			Conductivity measurements ( $\mu_{\infty} 0^{\circ} = 129.6$ ).		
<i>m</i>	<i>J</i>	$\frac{J}{m}$	<i>v</i>	$\mu_{\infty} 0^{\circ}$	<i>a</i>
0.053	0.262°	5.04°	19.23	107.40	82.9
0.103	0.503	4.88	9.71	102.10	78.8
0.155	0.773	4.98	6.45	97.65	75.3
0.207	1.035	5.00	4.83	95.07	73.4
0.259	1.308	5.05	3.86	94.55	73.0
0.310	1.592	5.13	3.22	92.84	71.6
0.414	2.147	5.19	2.42	89.43	68.9
0.517	2.741	5.30	1.92	87.61	67.5
0.621	3.447	5.55	1.61	84.52	65.1
0.626	3.502	5.59	0.63	67.83	52.3
1.565	12.520	8.00	0.53	61.10	47.1
1.878	16.500	8.78	0.45	55.70	43.0
2.191	22.000	10.04			

\*Jones and Getman: Ztschr. phys. Chem., 49, 405 (1904).

TABLE 39.—STRONTIUM BROMIDE—Continued.

Specific gravities.				
<i>m</i>	W <sub>Sol</sub>	W <sub>Salt</sub>	W <sub>H<sub>2</sub>O</sub>	Correction, per cent.
0.052	25.2438	0.3219	24.9219	0.31
0.103	25.5540	0.6376	24.9164	0.33
0.155	25.7882	0.9657	24.8225	0.71
0.207	26.0497	1.2872	24.7625	0.91
0.259	26.3649	1.6090	24.7559	0.98
0.310	26.6038	1.9201	24.6837	1.26
0.414	27.1646	2.5602	24.6044	1.58
0.517	27.6870	3.2002	24.4868	2.05
0.621	28.2420	3.8440	24.3980	2.40
0.626	28.1763	4.0734	24.1029	3.59
1.565	32.8955	9.7144	23.1811	7.28
1.878	34.4696	11.6325	22.8371	8.65
2.191	36.0403	13.5493	22.4910	10.04

Hydrates.						
<i>m</i>	<i>a</i>	L	$\frac{L}{m}$	L'	<i>m</i> '	H
0.052	0.829	4.94	5.04	5.02	0.886	17.0
0.103	0.788	4.73	4.88	4.86	1.488	14.4
0.155	0.753	4.66	4.98	4.94	3.15	20.3
0.207	0.734	4.59	5.00	4.95	4.04	19.5
0.259	0.730	4.57	5.05	5.00	4.78	18.4
0.310	0.716	4.52	5.13	5.07	6.04	19.5
0.414	0.689	4.42	5.19	5.11	7.50	18.1
0.517	0.675	4.37	5.30	5.19	8.78	17.0
0.621	0.651	4.28	5.55	5.42	11.69	18.8
1.565	0.523	3.81	8.00	6.70	23.96	15.3
1.8778	0.471	3.61	8.78	8.02	30.55	16.2
2.191	0.430	3.46	10.04	9.03	34.16	15.6

## STRONTIUM IODIDE.

TABLE 40.—STRONTIUM IODIDE.

Freezing-point measurements.			Conductivity measurements ( $\mu_{\infty} 0^{\circ} = 133.8$ ).			Refractivities.		
<i>m</i>	<i>L</i>	$\frac{L}{m}$	<i>v</i>	$\mu_v 0^{\circ}$	<i>a</i>	<i>m</i>	$\lambda$	<i>n</i>
0.027	0.140°	5.18°	0.36	44.57	33.0	0.070	66° 36'	1.32901
0.054	0.275	5.09	0.59	71.7	53.0	0.141	65 50	1.33272
0.081	0.415	5.12	0.88	84.6	63.0	0.281	64 22	1.34004
0.108*	0.558	5.17	1.78	96.4	72.0	0.562	61 35	1.35463
0.162*	0.844	5.21	3.56	99.9	75.0	1.125	56 30	1.38319
0.216*	1.156	5.35	7.09	108.0	80.0	1.607	51 36	1.41223
0.327*	1.804	5.51	14.28	117.8	88.0	2.812	42 20	1.46761
0.070	0.359	5.13						
0.141	0.719	5.10						
0.281	1.505	5.36						
0.562	3.656	6.51						
1.125	9.040	8.04						
1.687	17.000	10.08						
2.812	49.500	17.60						

\*Chambers and Frazer; Amer. Chem. Journ., 23, 316 (1900).

TABLE 40.—STRONTIUM IODIDE—Continued.

Specific gravities.				
<i>m</i>	W <sub>Sol</sub>	W <sub>Salt</sub>	W <sub>H<sub>2</sub>O</sub>	Correction, per cent.
0.070	25.5126	0.5967	24.9159	0.33
0.141	25.9923	1.2020	24.7903	0.84
0.281	26.9774	2.3965	24.5819	1.67
0.562	28.9949	4.7910	24.2639	3.18
1.125	32.9382	9.5906	23.3776	6.49
1.687	36.9407	14.4072	22.5335	9.87

Hydrates.						
<i>m</i>	<i>a</i>	L	$\frac{J}{m}$	L'	<i>m'</i>	H
0.070	0.88	5.13	5.13	5.11	...	..
0.141	0.80	4.83	5.10	5.06	2.5	18
0.281	0.75	4.73	5.36	5.27	5.7	20
0.562	0.72	4.53	6.51	6.36	16.0	29
1.125	0.63	4.20	8.04	7.52	24.5	22
1.687	0.53	3.83	10.08	9.98	34.2	20

## STRONTIUM NITRATE.

A solution of strontium nitrate was standardized and a new set of freezing-point measurements made. The total amount of water in combination increases regularly with the concentration, and the number of molecules of water in combination with one molecule of the salt, increases from the most concentrated to the most dilute solution.

TABLE 41.—STRONTIUM NITRATE.

Freezing-point measurements.			Conductivity measurements ( $\mu_{\infty} 0^{\circ} = 152.7$ ).		
<i>m</i>	<i>t</i>	$\frac{t}{m}$	<i>v</i>	$\mu_v 0^{\circ}$	<i>a</i>
0.145	0.68°	4.70°	0.57	30.00	19.6
0.290	1.35	4.65	0.68	34.00	22.3
0.580	2.44	4.20	0.86	40.60	26.6
1.161	4.70	4.05	1.72	56.70	37.1
1.451	5.85	4.03	3.45	76.60	50.2
1.741	7.13	4.09	6.89	80.90	53.0
1.8137	7.50	4.13	13.88	90.86	59.5

TABLE 41.—STRONTIUM NITRATE—Continued.

Specific gravities.				
<i>m</i>	W <sub>SoI</sub>	W <sub>Salt</sub>	W <sub>H<sub>2</sub>O</sub>	Correction, per cent.
0.145	25.6525	0.7676	24.8849	-0.46
0.290	26.2575	1.5353	24.7222	-1.11
0.580	27.5152	3.0705	24.4447	-2.22
1.161	30.7750	6.1463	24.6287	-1.48
1.451	32.5280	7.6816	24.8464	-0.61
1.741	34.4900	9.2168	25.2732	-1.09
1.8137	35.0225	9.6017	25.4208	-1.68

Hydrates.						
<i>m</i>	<i>a</i>	L	$\frac{d}{m}$	L'	<i>m'</i>	H
0.145	0.530	3.93	4.70	4.68	8.91	61.4
0.290	0.502	3.73	4.65	4.60	10.51	36.2
0.580	0.371	3.24	4.20	4.11	11.73	20.2
1.161	0.266	2.95	4.05	3.99	14.48	12.5
1.451	0.223	2.69	4.03	4.01	18.29	12.6
1.741	0.196	2.59	4.09	4.13	20.72	11.3

## BARIUM CHLORIDE.

The salt was obtained in relatively pure condition. It was recrystallized several times, and then dried for some hours at 110° C. in an air-bath. The mother-solution was made up by direct weighing, and the lesser concentrations obtained by dilution. The slight solubility of the salt prevented the study of concentrations beyond 0.75 N.

TABLE 42.—BARIUM CHLORIDE.

Freezing-point measurements.					Conductivity measurements.	
<i>m</i>	$\frac{d}{m}$ Loomis.*	$\frac{d}{m}$ Jones and Chambers.†	Jones and Getman.		<i>v</i>	$\mu_{20}^{\circ}$
			<i>d</i>	$\frac{d}{m}$		
0.05	4.770°	.....	.....	.....	20.00	116.05
0.10	4.690	4.85°	.....	.....	10.00	103.79
0.20	4.655	4.77	.....	.....	4.00	95.94
0.30	.....	4.82	.....	.....	2.00	89.24
0.50	4.830	4.95	.....	.....	1.333	85.27
0.50	.....	4.986	2.493°	4.986°		
0.75	.....	5.143	3.857	5.143		

\* Phys. Rev., 3, 277 (1896).

† Amer. Chem. Journ., 23, 94 (1900).

## BARIUM BROMIDE.

The freezing-point measurements in the case of barium bromide had also been made,\* but much of the other data had to be secured. We determined the value of  $\mu_{\infty}$  at  $0^{\circ}$ , by the direct application of the conductivity method at high dilutions. The results obtained do not call for special discussion, since they are of the same general character as those already considered. The amount of the solvent held in combination by barium bromide is about the same, at comparable concentrations, as for the other halides of the calcium group; after the first dilution it increases with the concentration. The results are plotted in a curve, fig. 47.

TABLE 43.—BARIUM BROMIDE.

Freezing-point measurements.			Conductivity measurements ( $\mu_{\infty} 0^{\circ} = 136.9$ ).		
$m$	$J$	$\frac{J}{m}$	$v$	$\mu_v 0^{\circ}$	$a$
0.10	0.506°	5.06°	10.00	108.50	79.3
0.15	0.737	4.91	6.67	106.30	77.7
0.20	1.001	5.00	4.00	101.00	73.8
0.40	2.039	5.09	2.50	97.60	71.3
0.50	2.591	5.18	2.00	94.23	68.8
0.4516	2.310	5.11	1.47	89.40	65.3
0.6774	3.890	5.74	1.11	88.76	64.8
0.9032	7.300	5.87	0.88	83.60	61.1
1.1290	7.050	6.24	0.74	79.94	58.4
1.3548	9.020	6.66	0.63	76.10	55.6
1.5806	11.260	7.12	0.55	69.70	50.9
1.8064	13.860	7.67	0.44	56.20	41.1
2.2580	19.030	8.43			

Specific gravities.				
$m$	$W_{\text{Sol}}$	$W_{\text{Salt}}$	$W_{\text{H}_2\text{O}}$	Correction, per cent.
0.10	25.6280	0.7433	24.8847	0.46
0.15	25.9603	1.1149	24.8454	0.62
0.25	26.6335	1.8581	24.7754	0.90
0.40	27.5884	2.9730	24.6154	1.14
0.50	28.2854	3.7163	24.5691	1.72
0.6774	29.3522	5.0058	24.3464	2.51
0.9032	30.7874	6.6915	24.0959	3.62
1.1290	32.1553	8.4016	23.7537	4.99
1.3548	33.6259	10.0373	23.5886	5.65
1.5806	35.0292	11.7473	23.2819	6.87
1.8064	36.4501	13.4574	22.9927	8.03
2.2580	39.2792	16.8031	22.4761	10.09

\* Jones and Getman: Ztschr. phys. Chem., 49, 407 (1904).

TABLE 43.—BARIUM BROMIDE—Continued.

Hydrates.						
$m$	$a$	L	$\frac{J}{m}$	L'	$m'$	H
0.10	0.793	4.81	5.06	5.04	2.54	25.4
0.15	0.777	4.75	4.91	4.88	1.48	9.9
0.25	0.738	4.60	5.00	4.96	4.03	16.1
0.40	0.713	4.52	5.09	5.03	5.63	14.1
0.50	0.688	4.42	5.18	5.09	6.22	12.5
0.6774	0.653	4.29	5.74	5.59	12.92	19.1
0.9032	0.648	4.27	5.87	5.66	13.64	15.1
1.1290	0.611	4.13	6.24	5.93	16.88	14.9
1.3548	0.584	4.03	6.66	6.28	19.90	14.7
1.5806	0.556	3.93	7.12	6.63	22.62	14.3
1.8064	0.509	3.75	7.67	7.06	26.05	14.4
2.2580	0.411	3.39	8.43	7.58	30.71	13.6

## BARIUM IODIDE.

The freezing-points, conductivities, and specific gravities are taken from the work of Jones and Getman.\* The value 143 seems a little nearer to the true value of  $\mu_{\infty}$  at  $0^{\circ}$  than the value previously used. This changes slightly the values for the dissociation. While the total amount of combined water increases with the concentration (see curve, fig. 53), the number of molecules of water combined with one molecule of the dissolved substance is nearly constant for all the dilutions studied.

TABLE 44.—BARIUM IODIDE.

Freezing-point measurements.			Conductivity measurements ( $\mu_{\infty} 0^{\circ} = 143$ ).		
$m$	$J$	$\frac{J}{m}$	$v$	$\mu_v 0^{\circ}$	$a$
0.076	0.374°	4.92°	0.32	39.60	27.7
0.153	0.764	5.00	0.37	50.10	35.0
0.306	1.584	5.17	0.47	64.40	45.0
0.612	3.720	6.08	0.54	73.10	51.1
0.917	6.130	6.69	0.65	79.34	55.5
1.222	9.220	7.54	0.82	87.36	61.1
1.528	13.250	8.67	1.09	92.66	64.8
1.834	17.500	9.54	1.61	101.52	71.0
2.139	24.000	11.22	3.26	105.72	74.9
			6.53	108.50	75.9
			13.16	112.45	78.6

\*Ztschr. phys. Chem., 49, 408 (1904).



TABLE 44.—BARIUM IODIDE—Continued.

Specific gravities.				
<i>m</i>	<i>W</i> <sub>Sol</sub>	<i>W</i> <sub>Salt</sub>	<i>W</i> <sub>H<sub>2</sub>O</sub>	Correction, per cent.
0.076	25.6084	0.6843	24.9241	0.30
0.153	26.2575	1.4662	24.7913	0.83
0.306	27.4888	2.9325	24.5563	1.77
0.612	30.0284	5.9628	24.0656	3.74
0.917	32.5060	8.9930	23.5130	5.95
1.222	35.0114	11.9255	23.0859	7.46
1.528	37.5227	14.9557	22.5670	9.73
1.834	40.0067	17.8882	22.1185	11.53
2.139	42.4761	20.9185	21.5576	13.77

Hydrates.						
<i>m</i>	<i>a</i>	<i>L</i>	$\frac{d}{m}$	<i>L'</i>	<i>m'</i>	<i>H</i>
0.076	0.786	4.78	4.92	4.91	1.47	19.3
0.153	0.759	4.68	5.00	4.96	3.14	20.5
0.306	0.749	4.65	5.17	5.08	4.70	15.4
0.612	0.710	4.54	6.08	5.86	12.51	20.4
0.917	0.648	4.27	6.69	6.29	17.84	19.5
1.222	0.611	4.13	7.54	6.98	22.70	18.1
1.528	0.555	3.92	8.67	7.83	27.74	18.2
1.834	0.511	3.76	9.54	8.44	31.92	17.4
2.139	0.450	3.53	11.22	9.67	35.28	16.5

## MAGNESIUM CHLORIDE.

The freezing-point lowerings produced by magnesium chloride were measured by Jones and Getman.\* The remaining data, especially for the dilute solutions, were secured by Jones and Bassett. Magnesium chloride has greater power to combine with water than any of the halides of the calcium group. The difference is especially marked in the dilute solutions. Notwithstanding this fact, we see that the amount of water held in combination by the magnesium salt increases regularly with increase in concentration (see fig. 46). There is here also a slight exception presented by the first two solutions. It is worth noting that the amount of water combined with one molecule of the dissolved substance increases from the most dilute to the most concentrated solution.

\*Ztschr. phys. Chem., 49, 411 (1904).

TABLE 45.—MAGNESIUM CHLORIDE.

Freezing-point measurements.			Conductivity measurements ( $\mu_{\infty} 0^{\circ} = 120.0$ ).		
$m$	$d$	$\frac{d}{m}$	$v$	$\mu_{\infty} 0^{\circ}$	$\alpha$
0.0508	0.280°	5.51°	19.69	88.64	73.9
0.1016	0.537	5.28	9.84	83.30	69.4
0.1525	0.771	5.06	6.56	79.11	65.9
0.2033	1.058	5.20	4.87	76.28	63.6
0.2541	1.335	5.25	3.94	74.84	62.4
0.3801	2.015	5.30	2.63	70.51	58.8
0.5082	2.762	5.43	1.97	66.59	55.5
0.6099	3.472	5.69	1.64	64.39	53.8
0.464	2.482	5.35	1.08	63.43	52.9
0.927	6.140	6.62	0.70	52.65	43.9
1.391	10.820	7.78	0.54	45.70	38.1
1.854	17.380	9.38	0.43	36.67	30.6
2.318	27.000	11.60			

Specific gravities.				
$m$	$W_{\text{Sol}}$	$W_{\text{Salt}}$	$W_{\text{H}_2\text{O}}$	Correction, per cent.
0.0508	25.0818	0.1210	24.9608	0.16
0.1016	25.1641	0.2420	24.9221	0.31
0.1525	25.2596	0.3629	24.8967	0.41
0.2033	25.3275	0.4839	24.8436	0.62
0.2541	25.4230	0.6050	24.8180	0.73
0.3801	25.6426	0.9074	24.7352	1.06
0.5082	25.8768	1.2098	24.6670	1.33
0.6099	26.0392	1.4520	24.5872	1.65
0.927	26.7206	2.2134	24.5072	1.97
1.391	27.5109	3.3082	24.2027	3.19
1.854	28.3128	4.4030	23.9098	4.36
2.318	29.0447	5.5216	23.5231	5.91
2.782	29.8178	6.6164	23.2014	7.19

Hydrates.						
$m$	$\alpha$	L	$\frac{d}{m}$	L'	$m'$	H
0.1016	0.694	4.44	5.28	5.26	8.41	82.7
0.1525	0.659	4.31	5.06	5.04	8.05	52.1
0.2033	0.636	4.23	5.20	5.17	10.10	49.7
0.2541	0.624	4.18	5.25	5.21	10.99	43.3
0.3801	0.588	4.05	5.30	5.24	12.62	33.2
0.5082	0.555	3.92	5.43	5.36	14.93	29.4
0.6099	0.538	3.86	5.69	5.60	17.26	28.3
0.927	0.529	3.83	6.62	6.50	23.93	25.8
1.391	0.439	3.49	7.78	7.53	29.81	21.4
1.854	0.381	3.28	9.38	8.97	35.29	19.0
2.318	0.306	3.00	11.60	10.91	40.28	17.4

## MAGNESIUM BROMIDE.

The bromide of magnesium, like the chloride, had already been studied by Jones and Getman.\* They were interested especially in the magnitude of the hydration in concentrated solutions. Much of the data necessary to calculate the approximate composition of the hydrates, in dilute solution, had to be secured by Jones and Bassett. The results for magnesium bromide are very similar to those for magnesium chloride. The amount of water held in combination is larger than in the case of any bromide of the calcium group. We notice here, also, a regular increase with the concentration in the value of  $m'$  (see fig. 48). Here, again, the number of molecules of water combined with one molecule of the salt increases from the most dilute to the most concentrated solution.

TABLE 46.—MAGNESIUM BROMIDE.

Freezing-point measurements.			Conductivity measurements ( $\mu \infty 0^\circ = 122.8$ ).		
$m$	$d$	$\frac{d}{m}$	$v$	$\mu_v 0^\circ$	$a$
0.0517	0.277°	5.36°	19.23	100.30	81.7
0.103	0.531	5.14	9.71	94.55	77.0
0.155	0.801	5.17	6.45	90.62	73.8
0.207	1.088	5.26	4.83	88.49	72.6
0.310	1.690	5.45	3.22	82.66	67.3
0.414	2.347	5.67	3.11	81.86	66.7
0.517	3.022	5.84	2.42	79.90	65.1
0.321	1.691	5.27	1.92	77.04	62.7
0.642	3.921	6.17	1.56	75.56	61.5
0.964	6.850	7.11	1.03	68.31	55.6
1.610	15.200	9.44	0.62	54.63	44.5
2.571	37.500	14.60	0.39	37.28	30.4

Specific gravities.				
$m$	W <sub>sol</sub>	W <sub>salt</sub>	W <sub>H<sub>2</sub>O</sub>	Correction, per cent.
0.0517	25.1526	0.2379	24.9147	0.34
0.103	25.3540	0.4758	24.8782	0.49
0.155	25.5990	0.7138	24.8852	0.46
0.207	25.7553	0.9518	24.8035	0.79
0.310	26.1085	1.4275	24.6810	1.27
0.321	26.1549	1.4736	24.6813	1.27
0.414	26.5794	1.9070	24.6724	1.74
0.517	26.9461	2.3792	24.5669	1.73
0.642	27.3491	2.9472	24.4019	2.39
0.964	28.4985	4.4208	24.0777	3.69
1.610	30.7930	7.3630	23.4250	6.30
2.571	34.1739	11.9730	22.2009	11.19
3.214	36.1581	14.7360	21.4221	14.31

\*Ztschr. phys. Chem., 49, 412 (1904).

TABLE 46.—MAGNESIUM BROMIDE—Continued.

Hydrates.						
<i>m</i>	<i>a</i>	L	$\frac{J}{m}$	L'	<i>m'</i>	H
0.103	0.770	4.75	5.14	5.11	3.81	38.0
0.155	0.738	4.60	5.17	5.15	5.93	38.3
0.207	0.726	4.56	5.26	5.22	7.02	33.9
0.310	0.673	4.36	5.45	5.38	10.53	33.97
0.414	0.651	4.28	5.67	5.57	12.87	31.1
0.517	0.627	4.19	5.84	5.74	15.00	29.0
0.642	0.615	4.15	6.17	6.02	17.26	26.9
0.964	0.556	3.93	7.11	6.85	23.68	25.6
1.610	0.445	3.52	9.44	8.85	33.46	20.8
2.571	0.304	2.99	14.60	12.97	42.80	16.6

## MAGNESIUM NITRATE.

TABLE 47.—MAGNESIUM NITRATE.

Freezing-point measurements.			Conductivity measurements ( $\mu_{\infty} 0^{\circ} = 125.3$ ).			Refractivities.		
<i>m</i>	<i>d</i>	$\frac{J}{m}$	<i>v</i>	$\mu_v 0^{\circ}$	<i>a</i>	<i>m</i>	$\lambda$	<i>n</i>
0.077	0.370°	4.80°	0.40	31.56	25.0	0.770	67° 00'	1.32711
0.155	0.753	4.86	0.46	37.08	29.0	0.155	66 39	1.32878
0.309	1.552	5.02	0.54	42.90	34.0	0.309	65 55	1.33231
0.618	3.559	5.75	0.65	49.40	39.0	0.618	64 34	1.33902
0.927	5.930	6.39	0.81	59.40	47.0	0.927	63 15	1.37579
1.236	8.650	7.00	1.08	66.09	52.0	1.236	62 20	1.35222
1.545	12.000	7.77	1.66	75.18	60.0	1.545	60 50	1.35870
1.854	16.270	8.84	3.23	85.70	68.0	1.854	59 45	1.36468
2.163	22.500	10.40	6.45	94.10	75.0	2.163	58 40	1.37075
			13.00	99.00	79.0	2.472	57 36	1.37683
Specific gravities.								
<i>m</i>	W <sub>Sol</sub>	W <sub>Salt</sub>	W <sub>H<sub>2</sub>O</sub>	Correction, per cent.				
0.077	25.1879	0.2856	24.9023	0.39				
0.155	25.3801	0.5750	24.8051	0.78				
0.309	25.8130	1.1464	24.6666	1.33				
0.618	26.6478	2.3002	24.3476	2.61				
0.927	27.4746	3.4503	24.0243	3.90				
1.236	28.2109	4.5633	23.6476	5.41				
1.545	29.0296	5.7134	23.3162	6.74				
1.854	29.7992	6.8635	22.9357	8.23				
2.163	30.5617	8.0161	22.5456	9.82				
2.472	31.3310	9.1637	22.1673	11.33				

TABLE 47.—MAGNESIUM NITRATE—Continued.

Hydrates.						
<i>m</i>	<i>a</i>	L	$\frac{J}{m}$	L'	<i>m'</i>	H
0.077	0.79	4.79	4.80	4.78	....	..
0.155	0.75	4.65	4.86	4.82	1.9	12
0.309	0.68	4.39	5.02	4.95	6.3	20
0.618	0.60	4.09	5.75	5.60	15.0	24
0.927	0.52	3.79	6.39	6.14	21.2	23
1.236	0.47	3.61	7.00	6.62	25.2	20
1.545	0.39	3.31	7.77	7.25	30.2	19
1.854	0.34	3.12	8.84	8.47	35.1	19
2.163	0.29	2.94	10.40	9.40	38.2	18

## MAGNESIUM SULPHATE.

TABLE 48.—MAGNESIUM SULPHATE.

Freezing-point measurements.			Conductivity measurements ( $\mu_{\infty} 0^{\circ} = 60.0$ ).			Refractivities.		
<i>m</i>	<i>J</i>	$\frac{J}{m}$	<i>v</i>	$\mu_{\infty} 0^{\circ}$	<i>a</i>	<i>m</i>	$\lambda$	<i>n</i>
0.060	0.138°	2.30°	0.51	14.13	24.0	0.060	67° 00'	1.32711
0.121	0.263	2.17	0.69	19.65	33.0	0.121	66 45	1.32829
0.242	0.484	2.00	1.4	28.06	46.0	0.242	66 10	1.33110
0.483	0.920	1.90	2.0	33.59	55.0	0.483	65 00	1.33684
0.724	1.390	1.93	4.1	42.36	70.0	0.724	64 00	1.34191
1.449	3.240	2.24	8.3	52.35	87.0	1.449	61 15	1.35643
1.932	5.070	2.62	16.7	56.78	95.0	1.932	59 38	1.36579

Specific gravities.					Hydrates.				
<i>m</i>	W <sub>Sol</sub>	W <sub>Salt</sub>	W <sub>H<sub>2</sub>O</sub>	Correction, per cent.	<i>m</i>	<i>a</i>	L	$\frac{J}{m}$	L'
0.060	25.1760	0.1806	24.9954	0.02	0.060	0.95	3.63	2.30	2.30
0.121	25.3684	0.3642	25.0042	....	0.121	0.87	3.48	2.17	2.17
0.242	25.6750	0.7224	24.9526	0.19	0.242	0.70	3.16	2.00	2.00
0.483	26.3619	1.4448	24.9171	0.33	0.483	0.55	2.88	1.90	1.90
0.724	26.9464	2.1672	24.7792	0.88	0.724	0.46	2.70	1.93	1.91
1.449	28.8584	4.3645	24.4939	2.02	1.449	0.33	2.47	2.24	2.20
1.932	30.1431	5.8093	24.3338	2.66	1.932	0.24	2.31	2.62	2.55

## ZINC CHLORIDE.

TABLE 49.—ZINC CHLORIDE.

Freezing-point measurements.			Freezing-point measurements.		
<i>m</i>	<i>Δ</i>	$\frac{\Delta}{m}$	<i>m</i>	<i>Δ</i>	$\frac{\Delta}{m}$
0.0493*	0.263°	5.33°	0.0986	0.509°	5.16°
0.0986*	0.509	5.16	0.197	1.020	5.17
0.197*	1.020	5.17	0.296	1.543	5.21
0.296*	1.543	5.21	0.394	2.098	5.32
0.394*	2.098	5.32	0.592	3.221	5.44
0.592*	3.221	5.44	1.787	10.850	6.07
0.0493	0.263	5.33	3.574	25.500	7.42

## ZINC NITRATE.

TABLE 50.—ZINC NITRATE.

Freezing-point measurements.			Conductivity measurements ( $\mu_{\infty} 0^{\circ} = 114.0$ ).			Refractivities.		
<i>m</i>	<i>Δ</i>	$\frac{\Delta}{m}$	<i>v</i>	$\mu_v 0^{\circ}$	<i>a</i>	<i>m</i>	$\lambda$	<i>n</i>
0.065	0.322°	4.95°	0.38	27.69	24.3	0.065	66° 57'	1.32766
0.129	0.633	4.90	0.48	36.03	31.6	0.129	60 30	1.32949
0.258	1.281	4.96	0.55	42.24	37.0	0.258	65 50	1.33272
0.516	2.812	5.45	0.64	46.53	40.8	0.516	64 20	1.34021
1.290	8.930	6.92	0.77	52.43	46.0	1.132	61 45	1.35374
1.548	11.800	7.69	0.88	53.89	47.3	1.290	60 33	1.35988
1.806	14.720	8.15	1.93	73.00	64.0	1.548	59 18	1.36775
2.064	18.240	8.83	3.87	82.50	72.4	1.806	58 10	1.37360
2.580	27.000	10.46	7.75	90.56	79.4	2.064	57 05	1.37981
			15.38	93.40	82.0	2.580	55 10	1.39098
Specific gravities.								
<i>m</i>	<i>W</i> <sub>Sol</sub>	<i>W</i> <sub>Salt</sub>	<i>W</i> <sub>H<sub>2</sub>O</sub>	Correction, per cent.				
0.065	25.2226	0.3079	24.9147	0.34				
0.129	25.4949	0.6111	24.8838	0.46				
0.258	25.9845	1.2223	24.7622	0.95				
0.516	27.0477	2.6945	24.3532	2.59				
1.290	29.9201	6.1114	23.8087	4.82				
1.548	30.8447	7.3337	23.5110	5.96				
1.806	31.7873	8.5557	23.2316	7.07				
2.064	32.7542	9.7782	22.9760	8.09				
2.580	34.5175	12.2228	22.2947	10.82				

\*Chambers and Frazer: Amer. Chem. Journ., 23, 512 (1900).

TABLE 50.—ZINC NITRATE—Continued.

Hydrates.						
<i>m</i>	<i>a</i>	L	$\frac{d}{m}$	L'	<i>m'</i>	H
0.065	0.820	4.96	4.95	4.93	.....	....
0.129	0.794	4.85	4.90	4.88	0.33	2.5
0.258	0.724	4.60	4.96	4.91	3.50	14
0.516	0.640	4.29	5.45	5.31	10.70	21
1.290	0.460	3.61	6.92	6.59	24.3	19
1.548	0.408	3.41	7.69	7.23	29.3	19
1.806	0.370	3.27	8.15	7.57	31.5	18
2.064	0.316	3.07	8.83	8.12	34.4	17
2.580	0.243	2.79	10.46	9.33	38.9	15

ZINC SULPHATE.

TABLE 51.—ZINC SULPHATE.

Freezing-point measurements.			Conductivity measurements ( $\mu_{\infty} 0^{\circ} = 109$ ).			Refractivities.		
<i>m</i>	<i>d</i>	$\frac{d}{m}$	<i>v</i>	$\mu_v 0^{\circ}$	<i>a</i>	<i>m</i>	$\lambda$	<i>n</i>
0.051	0.094°	1.84°	0.49	12.81	5.0	0.051	67° 00'	1.32711
0.102	0.194	1.90	0.54	14.46	13.0	0.102	66 43	1.32814
0.203	0.372	1.83	0.61	16.24	15.0	0.203	66 10	1.33110
0.406	0.697	1.71	0.70	18.54	17.0	0.406	65 20	1.33618
0.609	1.027	1.69	0.98	25.95	24.0	0.609	64 50	1.34149
1.015	1.753	1.72	1.64	27.90	26.0	1.015	62 10	1.35151
1.421	2.715	1.91	2.64	32.31	30.0	1.421	60 23	1.36681
1.624	3.327	2.05	4.92	39.10	36.0	1.624	59 33	1.36543
1.827	3.976	2.18	9.80	45.84	42.0	1.827	58 50	1.36981
2.032	4.990	2.46	19.61	52.28	48.0	2.032	58 00	1.37455

Specific gravities.					Hydrates.				
<i>m</i>	W <sub>Sol</sub>	W <sub>Salt</sub>	W <sub>H<sub>2</sub>O</sub>	Correction, per cent.	<i>m</i>	<i>a</i>	L	$\frac{d}{m}$	L'
0.051	25.2065	0.2059	24.9979	....	0.051	0.48	2.78	....	....
0.102	25.4097	0.8196	24.9744	0.10	0.102	0.42	2.67	1.90	1.90
0.203	25.7940	1.6392	24.9537	0.18	0.203	0.36	2.56	1.83	1.83
0.406	26.5929	2.4588	24.9026	0.39	0.406	0.30	2.44	1.71	1.71
0.609	27.3614	4.0980	24.7974	0.81	0.609	0.26	2.37	1.69	1.69
1.015	28.8954	5.5898	24.7881	0.85	1.015	0.24	2.33	1.72	1.71
1.421	30.3779	6.5569	24.5340	1.86	1.421	0.17	2.20	1.91	1.89
1.624	31.0909	7.3765	24.4085	2.37	1.624	0.15	2.16	2.05	2.01
1.827	31.7850	8.2642	24.2960	2.82	1.827	0.13	2.12	2.18	2.13
2.032	32.5002	.....	.....	....	2.032	0.05	1.97	2.46	2.39

TABLE 52.

CADMIUM CHLORIDE.			CADMIUM BROMIDE.			CADMIUM IODIDE.		
Freezing-point measurements.			Freezing-point measurements.			Freezing-point measurements.		
<i>m</i>	<i>Δ</i>	$\frac{\Delta}{m}$	<i>m</i>	<i>Δ</i>	$\frac{\Delta}{m}$	<i>m</i>	<i>Δ</i>	$\frac{\Delta}{m}$
0.214	0.727°	3.39°	0.22	0.652°	2.959°	0.133	0.314°	2.36°
0.322	1.022	3.18	0.44	1.213	2.757	0.222	0.479	2.16
0.429	1.298	3.03	0.66	1.738	2.633	0.333	0.710	2.13
0.643	1.832	2.85	0.88	2.277	2.587	0.444	0.997	2.24
0.858	2.329	2.72				0.666	1.564	2.35
1.072	2.947	2.65				0.888	2.227	2.51

## CADMIUM NITRATE.\*

TABLE 53.—CADMIUM NITRATE.

Freezing-point measurements.			Conductivity measurements ( $\mu_{\infty}0^{\circ} = 116.5$ ).			Refractivities.		
<i>m</i>	<i>Δ</i>	$\frac{\Delta}{m}$	<i>v</i>	$\mu_v 0^{\circ}$	<i>a</i>	<i>m</i>	$\lambda$	<i>n</i>
0.0845	0.443°	5.24°	0.29	10.60	5.3	0.0845	66° 47'	1.32355
0.1691	0.865	5.12	0.32	13.46	6.7	0.1691	66 15	1.33070
0.3382	1.802	5.33	0.37	19.60	9.8	0.3382	65 15	1.33560
0.6764	2.028	5.96	0.42	27.30	13.6	0.6764	63 16	1.34588
1.0146	6.540	6.45	0.59	38.43	19.2	1.0146	61 28	1.35580
1.6910	12.930	7.65	0.98	57.10	28.6	1.6910	59 10	1.36794
2.3674	.....	....	1.48	64.60	32.3	2.3674	58 80	1.37379
2.7056	26.000	9.61	2.95	81.00	40.5	2.7056	53 40	1.39985
			5.91	92.60	46.3	3.0438	52 19	1.40792
			11.83	99.70	49.9	3.3820	50 55	1.41534
Specific gravities.								
<i>m</i>	W <sub>Sol</sub>	W <sub>Salt</sub>	W <sub>H<sub>2</sub>O</sub>	Correction, per cent.				
0.0845	25.4292	0.5776	24.8416	0.62				
0.1691	25.8508	0.9992	24.8516	0.60				
0.3382	26.6982	2.0184	24.6798	1.28				
0.6764	28.4477	3.9968	24.4509	2.20				
1.0146	30.1584	5.9987	24.1597	3.36				
1.6910	33.5444	9.9980	23.5464	5.81				
2.7056	38.4807	15.9992	22.4815	10.07				
Hydrates.								
<i>m</i>	<i>a</i>	L	$\frac{\Delta}{m}$	L'	<i>m'</i>	H		
0.1691	0.463	3.58	5.12	5.09	16.8	100		
0.3382	0.405	3.37	5.33	5.26	19.9	59		
0.6764	0.323	3.06	5.96	5.83	26.4	39		
1.0146	0.286	2.92	6.45	6.23	29.5	29		
1.6910	0.192	2.57	7.65	7.21	35.7	21		
2.3674	0.136	2.37	.....	.....	.....	..		
2.7056	0.098	2.21	9.61	8.65	41.3	..		

\* Amer. Chem. Journ.; 34, 308 (1905).



## CADMIUM SULPHATE.

TABLE 54.—CADMIUM SULPHATE.

Freezing-point measurements.			Conductivity measurements.			Refractivities.		
<i>m</i>	<i>d</i>	$\frac{d}{m}$	<i>v</i>	$\mu_v 0^\circ$	<i>a</i>	<i>m</i>	$\lambda$	<i>n</i>
0.063	0.201°	3.19°	0.80	20.40	14.8	0.063	66° 50'	1.32790
0.125	0.356	2.85	1.00	27.09	19.6	0.125	66 19	1.33037
0.250	0.658	2.63	1.14	31.51	22.8	0.250	65 18	1.33535
0.500	1.259	2.52	1.60	34.20	23.9	0.500	63 28	1.34466
0.625	1.588	2.54	2.00	38.46	27.9	0.625	62 37	1.34912
0.875	2.388	2.73	4.00	46.97	34.0	0.875	61 00	1.35799
1.000	2.870	2.87	8.00	56.30	40.8	1.000	60 15	1.36101
1.250	4.160	3.333	16.00	67.10	48.6	1.250	58 45	1.37028

Specific gravities.				Hydrates.			
<i>m</i>	W <sub>sol</sub>	W <sub>salt</sub>	W <sub>H<sub>2</sub>O</sub>	<i>m</i>	<i>a</i>	L	$\frac{d}{m}$
0.063	25.3901	0.3284	25.0617	0.063	0.486	2.76	3.19
0.125	25.8190	0.6516	25.1674	0.125	0.408	2.62	2.85
0.250	26.7706	1.3031	25.4675	0.250	0.340	2.49	2.63
0.500	28.4801	2.6062	25.7739	0.500	0.279	2.38	2.52
0.625	29.3056	3.2578	26.0478	0.625	0.239	2.30	2.54
0.875	30.9872	4.5409	26.4463	0.875	0.228	2.28	2.73
1.000	31.8010	5.2125	26.5885	1.000	0.196	2.22	2.87
1.250	33.4323	6.5156	26.9167	1.250	0.148	2.14	3.33

## MANGANESE CHLORIDE.

The substances dealt with in the few following pages were studied by Jones and Getman\* in their earlier work. At that time the evidence for the existence of hydrates in solution was not recognized as clearly as it is to-day, and no effort was then made to calculate the composition of the hydrates formed by these compounds. Jones and Bassett have taken the earlier data as far as they bear on the problem in hand, and have supplemented them wherever necessary, in order to calculate the approximate composition of the hydrates formed by these various substances, at different concentrations. This necessitated many new freezing-point determinations; in all cases new conductivity measurements at 0°; and the specific gravities of all of the solutions had to be ascertained.

An examination of table 55 will show that manganese chloride resembles the chlorides already studied, in that the power to combine with water is great, and increases regularly from the most dilute to the most concentrated solution. This is also shown by the curve for this substance in fig. 49. The number of molecules of water combined with one molecule of the salt, increases from the most concentrated to the most dilute solution. We have already met with other substances where this is the case, notably magnesium chloride and bromide.

\*Amer. Chem. Journ., 31, 303 (1904).

TABLE 55.—MANGANESE CHLORIDE.

Freezing-point measurements.			Conductivity measurements ( $\mu\infty 0^\circ = 123$ ).		
$m$	$\Delta$	$\frac{\Delta}{m}$	$v$	$\mu v 0^\circ$	$a$
0.053	0.255°	4.81°	18.87	88.67	72.0
0.106	0.508	4.79	9.43	81.81	67.0
0.133	0.639	4.80	7.51	79.85	65.0
0.266	1.259	4.73	3.76	73.49	60.0
0.400	2.004	5.01	1.88	65.16	53.0
0.532	2.790	5.24	1.26	57.32	47.0
0.796	4.247	5.34	0.94	51.44	42.0
0.902	4.825	5.36	0.66	43.35	34.0
1.061	5.965	5.62	0.50	34.82	28.0
1.500	11.100	6.66	0.40	26.38	21.0
2.000	16.500	8.25	0.33	19.67	16.0
2.500	24.000	9.60	0.29	14.04	11.0
3.000	31.000	10.33	0.25	9.82	8.0
3.500	40.000	11.43			
4.000	48.500	12.13			

Specific gravities.				
$m$	W <sub>Sol</sub>	W <sub>Salt</sub>	W <sub>H<sub>2</sub>O</sub>	Correction, per cent.
0.133	25.2679	0.4186	24.8593	0.56
0.266	25.6125	0.8372	24.7753	0.90
0.400	25.9469	1.2590	24.6879	1.25
0.532	26.2766	1.6745	24.6021	1.59
0.796	26.9452	2.5154	24.4298	2.28
0.902	27.1870	2.8390	24.3480	2.61
1.061	27.6633	3.3394	24.3239	2.70
1.500	28.7249	4.7213	24.0036	3.98
2.000	29.8916	6.2950	23.5966	5.62
2.500	31.0396	7.8688	23.1708	7.32
3.000	32.0541	9.4425	22.6116	9.55
3.500	33.2645	11.0138	22.2507	11.00
4.000	34.5927	12.5900	22.0027	11.99

Hydrates.						
$m$	$a$	L	$\frac{\Delta}{m}$	L'	$m'$	H
0.133	0.65	4.28	4.80	4.77	5.7	42.8
0.266	0.60	4.09	4.73	4.69	7.1	26.7
0.532	0.53	3.83	5.24	5.16	15.4	28.9
0.796	0.47	3.61	5.34	5.22	17.1	21.5
1.061	0.42	3.42	5.62	5.47	20.8	19.6
1.500	0.34	3.12	6.66	6.40	28.9	19.3
2.000	0.28	2.90	8.25	7.79	34.9	17.5
2.500	0.21	2.64	9.60	8.90	39.1	15.6
3.000	0.16	2.46	10.33	9.34	40.9	13.6
3.500	0.11	2.27	11.43	10.18	43.2	12.3
4.000	0.08	2.16	12.13	10.68	44.3	11.1

## MANGANESE NITRATE.

The results formerly obtained by Jones and Getman\* for manganese nitrate, were somewhat out of keeping for a salt with 6 molecules of water of crystallization. The freezing-point lowerings produced by this substance were too small. Suspecting that there must have been some error as far as this substance is concerned, the work was repeated. The following results were obtained:

From table 56 it will be seen that manganese nitrate gives just about the same lowering of the freezing-point as other salts with 6 molecules of water of crystallization, and really falls right in line with the relation that has been shown to hold in such a large number of cases. In order to avoid any possibility of error, a second, entirely new solution of manganese nitrate was prepared, and a fresh standardization of this solution was made. The freezing-point lowerings produced by solutions made from this newly standardized solution, were then determined, the results being recorded under B in table 56. It will be seen that these agree satisfactorily with the results under A. The error in the original work with this substance was probably due to a mistake in standardization.

TABLE 56.—MANGANESE NITRATE.

Freezing-point measurements—A.			Freezing-point measurements—B.			Conductivity measurements ( $\mu_{\infty} 0^{\circ} = 112$ ).		
<i>m</i>	<i>d</i>	$\frac{d}{m}$	<i>m</i>	<i>d</i>	$\frac{d}{m}$	<i>v</i>	$\mu_v 0^{\circ}$	<i>a</i>
0.27	1.39°	5.15°	0.09	0.46°	5.11°	3.70	80.62	72.0
0.54	2.98	5.52	0.18	0.88	4.90	1.85	71.37	63.7
1.05	6.75	6.43	0.27	1.43	5.30	0.95	58.48	52.2
1.59	12.00	7.55	0.54	3.07	5.69	0.63	48.61	43.4
2.61	27.50	10.54	1.05	6.80	6.47	0.38	27.37	24.4
3.15	38.50	12.22	1.59	11.80	7.42	0.32	20.02	17.9
			2.61	27.00	10.35			
			3.105	38.00	12.24			
Specific gravities.								
<i>m</i>	W <sub>sol</sub>	W <sub>salt</sub>	W <sub>H<sub>2</sub>O</sub>	Correction, per cent.				
0.27	25.8667	1.2087	24.6580	1.37				
0.54	26.7980	2.4175	24.3805	2.48				
1.05	28.4612	4.8350	23.6262	5.50				
1.59	30.2003	7.1184	23.0819	7.67				
2.61	33.4161	11.6850	21.7311	13.08				
3.15	35.0516	14.1026	20.9490	16.20				

\* Amer. Chem. Journ., 31, 313 (1904).

TABLE 56.—MANGANESE NITRATE—Continued.

Hydrates.						
<i>m</i>	<i>a</i>	L	$\frac{d}{m}$	L'	<i>m'</i>	H
0.09	0.824	4.93	5.11	5.09	1.75	19.40
0.18	0.766	4.71	4.90	4.86	1.72	9.53
0.27	0.720	4.54	5.15	5.08	5.91	21.87
0.54	0.637	4.23	5.52	5.38	11.87	21.99
1.05	0.522	3.80	6.43	6.08	20.83	19.84
1.59	0.434	3.47	7.55	6.97	27.90	17.55
2.61	0.244	2.77	10.54	10.04	40.23	15.41
3.15	0.179	2.53	12.22	10.24	41.82	13.28

## MANGANESE SULPHATE.

TABLE 57.—MANGANESE SULPHATE.

Freezing-point measurements.			Conductivity measurements.		Refractivities.		
<i>m</i>	<i>d</i>	$\frac{d}{m}$	<i>v</i>	$\mu_v 0^\circ$	<i>m</i>	$\lambda$	<i>n</i>
0.08	0.194°	2.43°	12.50	52.78	0.08	66° 55'	1.32750
0.16	0.354	2.21	6.25	44.48	0.16	66 28	1.32965
0.25	0.510	2.04	4.00	38.35	0.25	66 50	1.33150
0.33	0.676	2.04	3.03	35.65	0.33	65 39	1.33362
0.41	0.792	1.94	2.50	34.25	0.41	65 16	1.33575
0.82	1.556	1.90	1.22	26 29	0.82	63 19	1.34545
0.98	1.898	1.93	1.62	23 70	0.98	62 35	1.34930
1.31	2.701	2.06	0.76	19 50	1.31	61 13	1.35661
1.64	3.668	2.23	0.61	16.20	1.64	59 57	1.36357

## NICKEL CHLORIDE.

The earlier work of Jones and Getman\* had to do only with the more dilute solutions of nickel chloride. The earlier work was extended from a concentration of only 0.743 N to 3.483 N. The results with nickel nitrate are similar to those with cobalt chloride. The amount of water combined with the salt in solution increased regularly from the most dilute to the most concentrated solution (see fig. 50). The number of molecules of water combined with one molecule of the salt increases, fairly regularly, from the most concentrated to the most dilute solution.

\*Amer. Chem. Journ., 31, 317 (1904).

TABLE 58.—NICKEL CHLORIDE.

Freezing-point measurements.			Conductivity measurements ( $\mu_{\infty} 0^{\circ} = 120.7$ ).		
$m$	$\Delta$	$\frac{\Delta}{m}$	$v$	$\mu_{\infty} 0^{\circ}$	$a$
0.037	0.205°	5.54°	27.00	103.20	85.5
0.074	0.380	5.11	13.50	97.00	80.4
0.149	0.768	5.15	6.70	88.64	73.4
0.223	1.170	5.25	4.48	85.50	70.8
0.297	1.585	5.34	3.38	82.52	68.4
0.372	2.032	5.46	2.68	77.90	64.5
0.446	2.458	5.51	2.24	77.20	64.0
0.521	2.945	5.65	1.92	75.20	62.3
0.743	4.547	6.12	1.35	70.23	58.2
0.800	4.880	6.10	1.25	61.87	51.2
0.900	5.740	6.38	1.11	59.19	49.0
1.000	6.580	6.58	1.00	58.23	48.2
1.500	11.920	7.95	0.667	46.85	38.8
2.000	20.000	10.00	0.50	38.59	32.0
2.500	31.500	12.60	0.40	29.88	24.8
3.000	41.500	16.60	0.33	22.85	18.9
3.483	53.000	21.20	0.287	16.92	14.0

Specific gravities.				
$m$	W <sub>Sol</sub>	W <sub>Salt</sub>	W <sub>H<sub>2</sub>O</sub>	Correction, per cent.
0.037	25.0835	0.1199	24.9656	0.15
0.074	25.1860	0.2398	24.9462	0.21
0.149	25.4198	0.4828	24.9370	0.25
0.223	25.6430	0.7225	24.9205	0.31
0.297	25.8450	0.9623	24.8827	0.47
0.372	26.0920	1.2028	24.8892	0.44
0.446	26.2954	1.4451	24.8503	0.60
0.521	26.4786	1.6881	24.7905	0.84
0.743	27.1588	2.4073	24.7515	0.95
0.800	27.3576	2.5920	24.7656	0.94
0.900	27.5953	2.9160	24.6793	1.28
1.000	27.9336	3.2400	24.6936	1.17
1.500	29.3731	4.8600	24.5131	1.55
2.000	30.7936	6.4800	24.3136	2.75
2.500	32.0714	8.1000	23.9714	4.11
3.000	33.5388	9.7200	23.8188	4.72
3.483	34.7943	11.2849	23.5094	5.96

TABLE 58.—NICKEL CHLORIDE—Continued.

Hydrates.						
<i>m</i>	<i>a</i>	L	$\frac{d}{m}$	L'	<i>m'</i>	H
0.074	0.804	4.85	5.11	5.10	2.73	36.9
0.149	0.734	4.60	5.15	5.14	5.83	39.2
0.223	0.708	4.49	5.25	5.23	7.86	35.2
0.297	0.684	4.40	5.34	5.31	9.41	31.7
0.372	0.645	4.26	5.46	5.43	11.97	32.2
0.446	0.640	4.24	5.51	5.48	12.57	28.2
0.521	0.623	4.16	5.65	5.60	14.28	27.4
0.743	0.582	4.04	6.12	6.06	18.52	24.9
0.800	0.512	3.76	6.10	6.04	20.97	26.2
0.900	0.490	3.68	6.38	6.31	23.15	25.7
1.000	0.482	3.65	6.58	6.50	24.36	24.4
1.500	0.388	3.30	7.95	7.83	32.14	21.4
2.000	0.320	3.05	10.00	9.73	38.08	19.0
2.500	0.248	2.78	12.60	12.18	42.88	17.2
3.000	0.189	2.56	16.60	15.82	46.57	15.6
3.483	0.140	2.38	21.20	19.85	48.90	13.8

## NICKEL NITRATE.

The freezing-point lowerings produced by solutions of nickel nitrate were studied pretty thoroughly by Jones and Getman.\* Their investigations, even on freezing-point lowerings, have, however, been extended to somewhat greater concentrations. The hydrating power of nickel nitrate is of the same order as that of cobalt nitrate (see fig. 51), just as we should expect, since it has the same number of molecules of water of crystallization. Here, also, we notice that the number of molecules of water combined with one molecule of the salt increases from the most concentrated to the most dilute solution.

TABLE 59.—NICKEL NITRATE.

Freezing-point measurements.			Conductivity measurements ( $\mu_{\infty} 0^{\circ} = 117.2$ )		
<i>m</i>	<i>d</i>	$\frac{d}{m}$	<i>v</i>	$\mu_v 0^{\circ}$	<i>a</i>
0.0761	0.377°	4.95°	13.13	90.90	77.5
0.1522	0.750	4.93	6.57	85.14	72.6
0.3044	1.527	5.01	3.25	76.00	64.8
0.6088	3.273	5.37	1.64	68.60	58.5
0.7610	4.306	5.66	1.31	61.90	52.8
1.0654	6.691	6.28	0.90	55.30	47.2
1.2176	8.006	6.58	0.82	52.28	44.6
1.5220	11.883	7.15	0.65	45.29	38.6
2.0000	17.000	8.50	0.50	34.25	29.2
2.5000	25.000	10.00	0.40	26.11	22.3

\*Amer. Chem. Journ., 31, 318 (1904).

TABLE 59.—NICKEL NITRATE—Continued.

Specific gravities.				
<i>m</i>	W <sub>SoI</sub>	W <sub>Salt</sub>	W <sub>H<sub>2</sub>O</sub>	Correction, per cent.
0.0761	25.2314	0.3477	24.8837	0.46
0.1522	25.5990	0.6955	24.9035	0.39
0.3044	26.1132	1.3910	24.7222	1.11
0.6088	27.2990	2.7819	24.5171	1.93
0.7610	27.7974	3.4774	24.3200	2.72
1.0657	28.9284	4.8697	24.0587	3.76
1.2176	29.4458	5.5638	23.8820	4.47
1.522	30.6071	6.9548	23.6523	4.99
2.000	32.3305	9.1390	23.1915	7.23
2.500	34.0932	11.4237	22.6695	9.32
3.000	35.7096	13.7085	22.0011	12.00
3.394	36.9512	15.5093	21.4419	14.23

Hydrates.						
<i>m</i>	<i>a</i>	L	$\frac{d}{m}$	L'	<i>m'</i>	H
0.0761	0.775	4.74	4.95	4.93	2.14	28.1
0.1522	0.726	4.56	4.93	4.91	3.96	26.0
0.3044	0.648	4.27	5.01	4.96	7.73	25.4
0.6088	0.585	4.04	5.37	5.27	12.97	21.3
0.7610	0.528	3.82	5.66	5.51	16.03	21.1
1.0654	0.472	3.61	6.28	6.04	22.35	22.0
1.2176	0.446	3.52	6.58	6.29	24.46	20.1
1.5220	0.386	3.30	7.15	6.79	28.55	18.8
2.0000	0.292	2.95	8.50	7.89	34.71	17.4
2.5000	0.223	2.69	10.00	9.07	39.08	15.6

NICKEL SULPHATE.

TABLE 60.—NICKEL SULPHATE.

Freezing-point measurements.			Conductivity measurements.		Refractivities.		
<i>m</i>	<i>d</i>	$\frac{d}{m}$	<i>v</i>	$\mu_v 0^\circ$	<i>m</i>	$\lambda$	<i>n</i>
0.048	0.130°	2.70°	20.83	54.60	0.048	67° 00'	1.32711
0.097	0.227	2.34	10.31	47.10	0.097	66 40	1.32869
0.145	0.320	2.21	6.89	44.80	0.145	66 25	1.32989
0.290	0.550	1.90	3.45	37.67	0.290	65 30	1.33436
0.386	0.720	1.87	2.59	35.92	0.386	64 55	1.33726
0.483	0.874	1.81	2.07	31.16	0.483	64 25	1.33978
0.579	1.023	1.77	1.73	29.56	0.579	63 45	1.34320
0.869	1.532	1.76	1.15	25.08	0.869	62 25	1.35018
0.965	1.724	1.79	1.03	23.40	0.965	61 55	1.35285

Nickel chloride shows a minimum in the molecular lowering of the freezing-point in the neighborhood of 0.5 normal. The nitrate of nickel shows the freezing-point minimum at about the same concentration. The sulphate of nickel, like the sulphate of manganese, does not show the freezing-point minimum until a much greater concentration is reached than that at which it appeared with the chloride and nitrate. The positions of the minima in the case of the three salts of nickel can be seen at once by referring to fig. 34. This also shows the actual values of the molecular lowerings produced by the three salts. The chloride gives a molecular lowering of 6.12 at 0.743 normal; the nitrate at this concentration giving a molecular lowering of only about 5.6. The most concentrated solution of the nitrate investigated—1.522 normal—gave, however, a molecular lowering as great as 7.15.

The molecular lowering of nickel sulphate, in addition to showing a minimum, presents another point of special interest. The molecular lowering produced by nickel sulphate is very small, and in the most concentrated solutions studied is less than the constant for water. This means that in such solutions the nickel sulphate is polymerized, and to an extent that more than overcomes any electrolytic dissociation that may have taken place. Consequently, the molecular lowering is less than would be produced by a completely undissociated, non-polymerized substance. The molecular conductivities of all three of the nickel compounds increase regularly with the dilution, from the most concentrated to the most dilute solution that was employed. This is seen from the results, and is represented graphically in fig. 35.

The refractivity data for the three salts of nickel are given. The index of refraction in each case increases regularly with the dilution, and when the index of refraction is plotted as one ordinate and the concentration as the other, the resulting curve is practically a straight line for all three compounds (see fig. 36).

#### SALTS OF COBALT.

The data for the three compounds of cobalt that were studied are given, and the results are plotted as curves, figs. 37 to 39.

#### COBALT CHLORIDE.

Only a very small number of the results for cobalt chloride had been obtained by Jones and Getman.\* This applies also to the freezing-point lowerings, since only those produced by dilute solutions had been measured. The same holds for the conductivity measurements, and all of the specific

\*Amer. Chem. Journ., 31, 322 (1904).



gravity determinations have been made by Jones and Bassett. The results are just what we should expect. Cobalt chloride crystallizes with 6 molecules of water and, like the other chlorides with this amount of crystal water, has large hydrating power. The amount of water combined with the salt increases regularly with the concentration of the solution, as is shown by the curve for this substance in fig. 50.

TABLE 61.—COBALT CHLORIDE.

Freezing-point measurements.			Conductivity measurements ( $\mu\infty 0^\circ=117$ ).		
<i>m</i>	<i>J</i>	$\frac{J}{m}$	<i>v</i>	$\mu_v 0^\circ$	<i>a</i>
0.0639	0.325°	5.09°	15.65	95.93	82.0
0.1279	0.631	4.94	7.82	88.42	75.6
0.1918	0.946	4.93	5.21	86.36	73.9
0.3197	1.640	5.13	3.12	79.50	67.9
0.4475	2.427	5.43	2.23	74.45	63.6
0.5114	2.817	5.51	1.95	71.53	61.1
0.6393	3.658	5.72	1.57	67.94	58.1
0.700	4.000	5.71	1.43	64.38	55.0
0.800	4.700	5.88	1.25	61.48	52.6
0.900	5.420	6.00	1.11	58.93	50.3
1.000	6.240	6.24	1.00	57.25	48.9
1.500	11.520	7.68	0.667	47.34	40.5
2.000	19.000	8.50	0.500	37.93	32.4
2.500	27.500	11.00	0.400	29.79	25.5
2.760	33.500	12.14	0.362	26.13	22.3

Specific gravities.				
<i>m</i>	$W_{\text{Sol}}$	$W_{\text{Salt}}$	$W_{\text{H}_2\text{O}}$	Correction, per cent.
0.0693	25.1826	0.2077	24.9749	0.10
0.1279	25.3374	0.4154	24.9220	0.31
0.1918	25.5253	0.6229	24.9024	0.43
0.3197	25.8939	1.0382	24.8557	0.58
0.4475	26.2241	1.4533	24.7708	0.92
0.5114	26.4026	1.8583	24.5443	1.82
0.6393	26.7464	2.0761	24.6703	1.32
0.70	26.9935	2.2732	24.7203	1.12
0.80	27.2334	2.5980	24.6354	1.46
0.90	27.4400	2.9227	24.5173	1.93
1.00	27.7211	3.2475	24.4736	2.11
1.50	29.1942	4.8712	24.3230	2.71
2.00	30.4874	6.4950	23.9924	4.03
2.50	31.8077	8.1187	23.6890	5.24
2.76	32.5739	9.1931	23.3808	6.48

TABLE 61.—COBALT CHLORIDE—Continued.

Hydrates.						
<i>m</i>	<i>a</i>	L	$\frac{L}{m}$	L'	<i>m'</i>	H
0.0639	0.820	4.91	5.09	5.08	1.86	29.1
0.1279	0.756	4.67	4.94	4.92	2.71	21.2
0.1918	0.739	4.61	4.93	4.91	3.42	17.9
0.3197	0.679	4.39	5.13	5.10	7.73	21.1
0.4475	0.636	4.23	5.43	5.38	11.42	25.5
0.5114	0.611	4.13	5.51	5.41	13.14	25.7
0.6393	0.581	4.02	5.72	5.64	15.96	25.1
0.700	0.550	3.91	5.71	5.64	17.04	24.3
0.800	0.526	3.82	5.88	5.80	18.96	23.8
0.900	0.503	3.73	6.00	5.88	20.31	22.6
1.000	0.489	3.68	6.24	6.11	22.09	22.1
1.500	0.405	3.37	7.68	7.47	30.48	20.3
2.000	0.324	3.07	9.50	9.46	37.53	18.8
2.500	0.255	2.81	11.00	10.42	40.57	16.2
2.760	0.223	2.69	12.14	11.35	42.38	15.3

## COBALT NITRATE.

The nitrate of cobalt, like the chloride, crystallizes with 6 molecules of water of crystallization, and we should expect hydrating power of the same order of magnitude. Such is the fact. Jones and Bassett worked with more concentrated solutions than had been previously used, and supplemented the data obtained by Jones and Getman\* for all of the solutions, so as to be able to calculate the composition of the hydrates at the various dilutions. The regular increase in the amount of water held in combination, with increase in the concentration of the solutions, is shown by the curve in fig. 51.

TABLE 62.—COBALT NITRATE.

Freezing-point measurements.			Conductivity measurements ( $\mu_{\infty} 0^{\circ} = 117.6$ )		
<i>m</i>	$\Delta$	$\frac{\Delta}{m}$	<i>v</i>	$\mu_v 0^{\circ}$	<i>a</i>
0.0747	0.352°	4.72°	13.39	87.68	74.6
0.1495	0.685	4.58	6.69	81.80	69.5
0.2989	1.388	4.65	3.35	75.00	63.8
0.4484	2.198	4.87	2.23	69.46	57.1
0.7473	3.935	5.28	1.35	62.43	53.1
1.0462	6.025	5.76	0.95	54.60	46.4
1.3451	8.418	6.26	0.74	48.17	41.0
1.4945	9.811	6.55	0.67	45.47	38.7
2.0000	17.500	8.75	0.50	36.09	30.7
2.5700	26.500	10.60	0.389	26.59	22.6

\* Amer. Chem. Journ., 31, 323 (1904).

TABLE 62.—COBALT NITRATE—Continued.

Specific gravities.				
<i>m</i>	<i>W</i> <sub>SoI</sub>	<i>W</i> <sub>Salt</sub>	<i>W</i> <sub>H<sub>2</sub>O</sub>	Correction, per cent.
0.0748	25.2794	0.3422	24.9372	0.25
0.1495	25.5716	0.6843	24.8873	0.45
0.2989	26.0667	1.3931	24.6736	1.31
0.4484	26.6273	2.0523	24.5750	1.70
0.7473	27.6680	3.4204	24.2476	3.01
1.0451	28.7815	4.7834	23.9981	4.01
1.3451	29.7903	6.1565	23.6338	5.47
1.4945	30.2888	6.8403	23.4485	6.21
2.0000	32.1172	9.1540	22.9632	8.15
2.5700	33.9705	11.7629	22.2076	11.17

Hydrates.						
<i>m</i>	<i>a</i>	<i>L</i>	$\frac{J}{m}$	<i>L'</i>	<i>m'</i>	<i>H</i>
0.0747	0.746	4.64	4.72	4.71	0.83	11.0
0.1495	0.695	4.45	4.58	4.56	1.34	9.0
0.2989	0.638	4.23	4.65	4.59	4.36	14.6
0.4484	0.571	3.98	4.87	4.79	9.39	20.95
0.7473	0.531	3.84	5.28	5.12	13.89	18.6
1.0462	0.464	3.59	5.76	5.53	19.49	18.6
1.3451	0.410	3.29	6.26	5.92	24.58	18.3
1.4945	0.387	3.10	6.55	6.14	27.51	18.4
2.0000	0.307	3.00	8.75	8.04	37.31	18.6
2.5700	0.226	2.70	10.60	9.42	39.63	15.4

COBALT SULPHATE.

TABLE 63.—COBALT SULPHATE.

Freezing-point measurements.			Conductivity measurements.		Refractivities.		
<i>m</i>	<i>J</i>	$\frac{J}{m}$	<i>v</i>	$\mu_{v0^\circ}$	<i>m</i>	$\lambda$	<i>n</i>
0.0567	0.143°	2.52°	17.64	57.49	0.0567	66° 55'	1.32751
0.1133	0.245	2.16	8.82	48.56	0.1133	66 35	1.32909
0.2267	0.435	1.92	4.41	42.06	0.2267	65 57	1.33248
0.3399	0.625	1.84	2.94	38.07	0.3399	63 20	1.33518
0.6799	1.187	1.75	1.47	30.67	0.6799	63 37	1.34123
0.9066	1.614	1.77	1.10	27.16	0.9066	62 30	1.34974
1.1333	2.073	1.82	0.89	23.15	1.1199	62 00	1.35240
					1.1333	61 30	1.35508

## COPPER CHLORIDE.

In the paper\* to which reference has already been made, Jones and Getman attempted to calculate the approximate composition of the hydrates formed by copper chloride. In this calculation they had to make use of a part of the data obtained from other sources. Jones and Bassett have supplied this data for the various solutions, especially the specific gravities. They encountered difficulty in determining  $\mu_{\infty}$  for the copper salt. The value given was obtained by the conductivity method, taking into account the hydrolysis of copper chloride in dilute solutions.

The hydrating power of copper chloride is larger than would be expected from its water of crystallization.

TABLE 64.—COPPER CHLORIDE.

Freezing-point measurements.			Conductivity measurements ( $\mu_{\infty} 0^{\circ}=120$ ).		
$m$	$J$	$\frac{J}{m}$	$v$	$\mu_v 0^{\circ}$	$a$
0.0650	0.331°	5.09°	15.30	94.42	78.7
0.1301	0.639	4.91	7.64	88.06	73.4
0.2602	1.273	4.89	3.84	78.38	65.3
0.5204	2.711	5.29	1.92	67.68	56.4
0.7806	4.413	5.65	1.28	59.30	49.4
1.3010	8.395	6.45	0.76	48.22	40.2
1.5612	10.383	6.65	0.64	39.32	32.8
1.8210	12.960	7.12	0.55	35.02	29.2
2.0816	15.480	7.43	0.48	30.81	25.7
2.6020	20.820	8.00	0.38	22.58	18.8
3.0000	25.500	8.50	0.33	17.48	14.6
3.5000	31.500	9.00	0.29	13.05	10.9
4.3710	44.500	10.19	0.23	7.61	6.11

Specific gravities.				
$m$	$W_{\text{Sol}}$	$W_{\text{Salt}}$	$W_{\text{H}_2\text{O}}$	Correction, per cent.
0.0651	25.1985	0.2189	24.9796	0.08
0.1301	25.3934	0.4378	24.9556	0.18
0.2602	25.7941	0.8756	24.9185	0.33
0.5204	26.5913	1.7512	24.8401	0.64
0.7806	27.3458	2.6268	24.7190	1.12
1.3010	28.8280	4.3780	24.4500	2.20
1.5612	29.5841	5.2536	24.3305	2.68
1.8210	30.2350	6.1231	24.1119	3.55
2.0816	30.9999	7.0048	23.9951	4.02
2.6020	32.4090	8.7492	23.6598	5.36
3.0000	33.3949	10.0875	23.3074	6.77
3.5000	34.7877	11.8187	22.9690	8.01
4.3710	36.9809	14.6975	22.2834	10.87

\* Amer. Chem. Journ., 31, 353 (1904).

TABLE 64.—COPPER CHLORIDE—Continued.

Hydrates.						
<i>m</i>	<i>a</i>	L	$\frac{J}{m}$	L'	<i>m'</i>	H
0.1301	0.734	4.59	4.91	4.90	3.53	27.1
0.2601	0.653	4.29	4.89	4.87	6.62	25.4
0.5204	0.564	3.96	5.29	5.26	13.73	26.4
0.7806	0.494	3.69	5.65	5.59	18.88	24.2
1.3010	0.402	3.36	6.45	6.31	25.97	20.0
1.5612	0.328	3.08	6.65	6.47	28.94	18.6
1.8210	0.292	2.95	7.12	6.87	30.03	16.5
2.0816	0.257	2.82	7.43	7.13	33.58	16.1
2.6020	0.188	2.66	8.00	7.57	36.03	13.9
3.0000	0.146	2.40	8.50	7.92	38.72	12.9
3.5000	0.109	2.27	9.00	8.28	40.33	11.5
4.3710	0.064	2.10	10.17	9.77	49.77	11.4

## COPPER NITRATE.

What was said about the earlier work on copper chloride holds also, to some extent, for copper nitrate. Jones and Getman\* calculated the approximate composition of the hydrates for a few solutions of copper nitrate. The data used were, however, partly taken from the work of others, and interpolation was often necessary. Jones and Bassett obtained, with the same solutions, all the data necessary for calculating the composition of the hydrates. They encountered the same difficulty in determining  $\mu_{\infty}$  for copper nitrate as for copper chloride, and solved the problem, approximately, in the same way. The hydrating power of copper nitrate is just about what should be expected from its water of crystallization (see table 65 and curve, fig. 52).

TABLE 65.—COPPER NITRATE.

Freezing-point measurements.			Conductivity measurements ( $\mu_{\infty} 0^{\circ} = 118$ ).		
<i>m</i>	<i>J</i>	$\frac{J}{m}$	<i>v</i>	$\mu_{\infty} 0^{\circ}$	<i>a</i>
0.0591	0.326°	5.52 <sup>3</sup>	16.90	99.36	84.2
0.1182	0.595	5.03	8.46	93.05	78.9
0.2362	1.210	5.12	4.23	82.97	70.3
0.4726	2.544	5.39	2.12	73.16	62.0
0.9452	5.903	6.26	1.05	58.45	49.5
1.1815	7.799	6.60	0.84	52.34	44.4
1.6541	12.650	7.07	0.60	40.70	34.5
1.8904	15.490	8.20	0.52	35.84	30.4
2.3630	21.890	9.26	0.42	26.70	22.6

\* Amer. Chem. Journ., 31, 353 (1904).

TABLE 65.—COPPER NITRATE—Continued.

Specific gravities.				
<i>m</i>	W <sub>Sol</sub>	W <sub>Salt</sub>	W <sub>H<sub>2</sub>O</sub>	Correction, per cent.
0.0591	25.1456	0.2772	24.8684	0.53
0.1182	25.3851	0.5543	24.8308	0.68
0.2363	25.8364	1.1086	24.7278	1.09
0.4726	26.7265	2.2172	24.5093	1.56
0.9452	28.5284	4.4344	24.0940	3.62
1.1815	29.3289	5.5436	23.7853	4.86
1.6541	31.0048	7.7613	23.2435	7.03
1.8904	31.9184	8.8698	23.0486	7.80
2.3630	33.6390	11.0872	22.5518	9.79

Hydrates.						
<i>m</i>	<i>a</i>	L	$\frac{J}{m}$	L'	<i>m'</i>	H
0.1182	0.789	4.80	5.03	5.00	2.22	18.8
0.2363	0.703	4.48	5.12	5.07	6.47	27.4
0.4726	0.620	4.17	5.39	5.31	11.92	25.0
0.9452	0.495	3.70	6.26	6.03	21.47	22.7
1.1815	0.444	3.51	6.60	6.28	24.50	20.7
1.6541	0.345	3.14	7.07	6.55	28.92	17.5
1.8904	0.304	2.99	8.20	7.56	33.58	17.7
2.3640	0.226	2.70	9.26	8.35	37.59	15.9

## COPPER SULPHATE.

TABLE 66.—COPPER SULPHATE.

Freezing-point measurements.		
<i>m</i>	<i>J</i>	$\frac{J}{m}$
0.072	0.172°	2.33°
0.144	0.312	2.16
0.476	0.714	1.50
0.595	0.866	1.45
0.890	1.275	1.43
1.190	1.740	1.46

## ALUMINIUM CHLORIDE.

TABLE 67.—ALUMINIUM CHLORIDE.

Freezing-point measurements.			Conductivity measurements ( $\mu_{\infty} 0^{\circ} = 170.0$ ).			Refractivities.		
$m$	$L$	$\frac{d}{m}$	$v$	$\mu_{v} 0^{\circ}$	$a$	$m$	$\lambda$	$n$
0.046	0.276°	6.04°	18.80	124.6	73.3	0.2124	65° 43'	1.33297
0.076	0.446	5.85	4.70	104.6	59.8	0.4248	64 15	1.34064
0.102	0.578	5.68	2.35	88.64	52.1	0.6372	62 53	1.34736
0.200	1.148	5.74	1.45	71.7	42.2	1.0620	60 20	1.36145
0.299	1.840	6.15	0.94	59.3	34.9	1.0487	57 54	1.37493
0.398	2.596	6.52	0.67	43.1	25.3	2.1240	54 35	1.39441
0.531	3.830	7.21						
0.657	5.120	7.79						
0.876	7.970	9.09						
1.195	13.610	11.40						
1.434	19.518	13.60						
1.593	23.870	14.98						
2.124	45.000	21.18						
Specific gravities.								
$m$	$W_{\text{Sol}}$	$W_{\text{Salt}}$	$W_{\text{H}_2\text{O}}$	Correction, per cent.				
0.2124	25.5593	0.7087	24.8506	0.60				
0.4248	26.1216	1.4173	24.7043	1.18				
0.6372	26.6408	2.1260	24.5142	1.94				
1.0620	27.6952	3.5430	24.1522	3.39				
1.4868	25.6581	4.9600	23.6981	5.21				
2.1240	30.0789	7.0870	22.9190	8.32				
Hydrates.								
$m$	$a$	$L$	$\frac{d}{m}$	$L'$	$m'$	$H$		
2.124	0.177	2.88	21.18	19.32	48.1	23		
1.593	0.237	3.22	14.98	14.15	43.7	28		
1.434	0.253	3.31	13.60	13.10	42.0	29		
1.195	0.312	3.64	11.40	11.00	37.2	31		
0.876	0.388	4.07	9.09	8.84	30.0	35		
0.657	0.435	4.33	7.79	7.63	24.0	37		
0.531	0.476	4.56	7.21	7.10	19.8	37		
0.398	0.529	4.86	6.52	6.45	13.7	34		
0.299	0.570	4.91	6.15	5.63	7.1	23		
0.200	0.620	5.38	5.74	5.71	3.3	16		

## ALUMINIUM NITRATE.

TABLE 68.—ALUMINIUM NITRATE.

Freezing-point measurements.			Conductivity measurements ( $\mu_{\infty} 0^{\circ}=180$ ).			Refractivities.		
$m$	$d$	$\frac{d}{m}$	$v$	$\mu_{\infty} 0^{\circ}$	$a$	$m$	$\lambda$	$n$
0.0533	0.333°	6.25°	18.76	137.85	76.6	0.0533	66° 52'	1.32727
0.1066	0.652	6.12	9.38	122.00	67.8	0.1066	66 30	1.32949
0.2132	1.410	6.57	4.69	111.89	62.1	0.2132	65 40	1.33354
0.3198	2.290	7.15	3.13	101.60	56.4	0.3198	64 54	1.33726
0.5330	4.260	8.00	1.88	86.10	47.8	0.5330	63 25	1.34493
0.7462	6.760	9.06	1.34	73.27	40.7	0.7462	62 00	1.35240
0.8528	8.190	9.60	1.17	65.98	36.6	0.8525	61 10	1.35688
1.0660	11.790	11.06	0.94	55.21	30.6	1.066	60 50	1.36283
Specific gravities.								
$m$	$W_{\text{Sol}}$	$W_{\text{Salt}}$	$W_{\text{H}_2\text{O}}$	Correction, per cent.				
0.0533	25.1615	0.2840	24.8775	0.49				
0.1066	25.3858	0.5682	24.8176	0.73				
0.2132	25.8260	1.1362	24.6898	1.24				
0.3198	26.2487	1.7045	24.5442	1.82				
0.5330	27.1053	2.8400	24.2653	2.94				
0.7462	27.9300	3.9760	23.9540	4.18				
0.8528	28.3283	4.5460	23.7823	4.87				
1.0660	29.1080	5.6820	23.4260	6.30				
Hydrates.								
$m$	$d$	$L$	$\frac{d}{m}$	$L'$	$m'$	$H$		
1.066	0.306	3.61	11.06	10.36	36.2	34		
0.853	0.366	3.94	9.60	9.12	31.2	37		
0.746	0.407	4.17	9.06	8.68	29.0	39		
0.533	0.478	4.58	8.00	7.77	23.5	48		
0.320	0.564	5.06	7.15	7.02	15.5	49		
0.213	0.621	5.38	6.57	5.78	3.8	13		

## ALUMINIUM SULPHATE.

TABLE 69.—ALUMINIUM SULPHATE.

Freezing-point measurements.			Conductivity measurements.		Refractivities.		
$m$	$d$	$\frac{d}{m}$	$v$	$\mu_{\infty} 0^{\circ}$	$m$	$\lambda$	$n$
0.0736	0.260°	3.46°	13.58	80.62	0.0736	66° 13'	1.33086
0.1841	0.683	3.71	5.43	62.41	0.1841	64 40	1.33852
0.2946	1.138	3.86	3.39	50.84	0.2946	63 16	1.34588
0.3682	1.521	4.13	2.71	44.89	0.3682	62 25	1.35018



TABLE 69.—ALUMINIUM SULPHATE—Continued.

Specific gravities.				
<i>m</i>	W <sub>Sol</sub>	W <sub>Salt</sub>	W <sub>H<sub>2</sub>O</sub>	Correction, per cent.
0.0736	25.5612	0.6300	24.9312	0.28
0.1841	26.4130	1.5757	24.8373	0.65
0.2946	27.3215	2.5200	24.8015	0.79
0.3682	27.9238	3.1500	24.7738	0.90

## CHROMIUM CHLORIDE.

The chloride of chromium is an interesting substance to study in the present connection, on account of it being a quaternary electrolyte, having 6 molecules of water of crystallization, and being very soluble in water. The results are just what should have been expected from the earlier work with similar compounds. The total amount of water combined with the salt is large, and increases from the most dilute to the most concentrated solution (see fig. 54). The number of molecules of water combined with one molecule of the dissolved substance is, as would be expected, large, and increases from the most concentrated to the most dilute solution.

TABLE 70.—CHROMIUM CHLORIDE.

Freezing-point measurements.			Conductivity measurements ( $\mu\infty 0^\circ = 190$ ).		
<i>m</i>	<i>J</i>	$\frac{J}{m}$	<i>v</i>	$\mu v 0^\circ$	<i>a</i>
0.05	0.268°	5.36°	0.40	14.46	7.61
0.1	0.510	5.10	0.44	18.31	9.64
0.2	1.030	5.15	0.50	22.60	11.63
0.3	1.570	5.23	0.67	32.19	16.94
0.4	2.160	5.45	1.00	45.40	23.90
0.5	2.910	5.82	1.11	48.62	25.60
0.6	3.610	6.016	1.43	55.47	29.20
0.7	4.55	6.50	1.67	59.27	31.20
0.9	6.30	7.00	2.00	63.12	33.22
1.0	7.46	7.46	2.50	68.11	35.85
1.5	15.00	10.00	3.33	72.37	38.10
2.0	27.00	13.50	5.00	79.70	41.95
2.25	33.00	14.67	10.00	89.14	46.92
			20.00	100.20	52.73

TABLE 70.—CHROMIUM CHLORIDE—Continued.

Specific gravities.				
<i>m</i>	<i>W</i> <sub>Sol</sub>	<i>W</i> <sub>Salt</sub>	<i>W</i> <sub>H<sub>2</sub>O</sub>	Correction, per cent.
0.05	25.2479	0.1981	25.0498	0.20
0.1	25.3552	0.3961	24.9591	0.16
0.2	25.6458	0.7923	24.8535	0.59
0.3	25.9221	1.1884	24.7337	1.06
0.4	26.2676	1.5845	24.6831	1.27
0.5	26.5693	1.9806	24.5887	1.64
0.6	26.9335	2.3768	24.5567	1.77
0.7	27.2232	2.7729	24.4503	2.20
0.9	27.7939	3.5651	24.2288	3.09
1.0	28.0684	3.9613	24.1071	3.57
1.5	29.5153	5.9419	23.5734	5.71
2.0	30.9932	7.9225	23.0207	7.92
2.25	31.5784	8.9128	22.6656	9.34

Hydrates.						
<i>m</i>	<i>a</i>	<i>L</i>	$\frac{d}{m}$	<i>L'</i>	<i>m'</i>	<i>H</i>
0.05	0.527	4.80	5.36	5.37	5.90	117.9
0.1	0.469	4.48	5.10	5.09	6.66	66.6
0.2	0.420	4.20	5.15	5.12	9.98	49.9
0.3	0.381	3.99	5.23	5.18	12.76	42.5
0.4	0.359	3.86	5.45	5.38	15.70	39.2
0.5	0.332	3.71	5.82	5.73	19.58	39.2
0.6	0.312	3.60	6.01	5.91	21.16	35.3
0.7	0.292	3.49	6.50	6.36	25.07	35.8
0.9	0.256	3.29	7.00	6.78	28.60	31.8
1.0	0.239	3.19	7.46	7.19	30.91	30.9
1.5	0.169	2.80	10.00	9.42	39.05	26.0
2.0	0.116	2.52	13.50	12.42	44.28	22.1
2.25	0.096	2.40	14.67	13.30	45.53	20.2

## CHROMIUM NITRATE.

TABLE 71.—CHROMIUM NITRATE.

Freezing-point measurements.			Conductivity measurements ( $\mu_{\infty} 0^{\circ} = 173.1$ ).		
<i>m</i>	<i>d</i>	$\frac{d}{m}$	<i>v</i>	$\mu_v 0^{\circ}$	<i>a</i>
0.0467	0.280°	6.00°	0.53	29.65	17.1
0.0934	0.553	5.90	0.67	42.74	24.1
0.1868	1.143	6.12	0.76	50.85	29.3
0.3736	2.493	6.68	0.89	61.14	35.3
0.5604	4.153	7.41	1.07	73.0	42.1
0.9340	8.800	9.42	1.78	96.4	55.6
1.1208	11.570	10.32	2.68	108.9	62.9
1.3076	14.670	11.22	5.34	130.6	75.4
1.4944	19.140	12.81	10.75	143.1	77.4
1.8680	29.500	15.78			

TABLE 71.—CHROMIUM NITRATE—Continued.

Specific gravities.				
<i>m</i>	W <sub>SoI</sub>	W <sub>Salt</sub>	W <sub>H<sub>2</sub>O</sub>	Correction, per cent.
0.0934	25.4300	0.5361	24.8939	0.42
0.1868	25.8828	1.1319	24.7509	1.00
0.3736	26.7302	2.2043	24.5259	1.90
0.5604	27.5524	3.3362	24.2162	3.14
0.9340	29.3072	5.5405	23.7667	4.93
1.1208	30.0668	6.6724	23.3944	6.42
1.3076	30.8464	7.8044	23.0420	7.83
1.4944	31.6327	8.8767	22.7560	8.98
1.8680	33.3379	11.2597	22.0782	11.69

Hydrates.						
<i>m</i>	<i>a</i>	L	$\frac{J}{m}$	L'	<i>m'</i>	H
0.0934	0.774	6.18	5.90	5.88	....	..
0.1868	0.754	6.07	6.12	6.06	....	..
0.3736	0.629	5.37	6.68	6.55	10.0	27
0.5604	0.555	4.96	7.41	7.18	17.5	31
0.9340	0.421	4.21	9.42	8.96	29.5	31
1.1208	0.353	3.83	10.32	9.66	33.5	30
1.3076	0.293	3.49	11.22	10.34	36.8	28
1.4944	0.241	3.20	12.81	11.66	40.3	27
1.8680	0.171	2.81	15.78	13.94	44.3	24

## FERRIC CHLORIDE.

TABLE 72.—FERRIC CHLORIDE.

Freezing-point measurements.			Refractivities.		
<i>m</i>	<i>J</i>	$\frac{J}{m}$	<i>m</i>	$\lambda$	<i>n</i>
0.064	0.387 <sup>2</sup>	6.05°	0.064	66° 45'	1.32830
0.103	0.607	5.89	0.103	66 26	1.32997
0.129	0.758	5.87	0.129	66 80	1.33256
0.257	1.578	6.14	0.257	65 00	1.33684
0.515	3.688	7.16	0.515	63 00	1.34710
1.287	12.940	10.06	1.287	57 20	1.37837
1.544	17.650	11.40	1.544	55 30	1.38902
2.058	30.500	14.82	2.058	52 80	1.40963
2.573	51.000	19.82	2.573	49 47	1.42360

TABLE 72.—FERRIC CHLORIDE—Continued.

Specific gravities.				
<i>m</i>	W <sub>Sol</sub>	W <sub>Salt</sub>	W <sub>H<sub>2</sub>O</sub>	Correction, per cent.
0.064	25.2776	0.2435	25.0341	....
0.103	25.4153	0.4181	24.9972	0.01
0.129	25.5055	0.5727	24.9328	0.27
0.257	25.9140	1.0544	24.8593	0.56
0.515	26.7631	2.1108	24.6523	1.39
1.287	29.1924	5.2364	23.9660	4.14
1.544	29.9209	6.2519	23.6690	5.32
2.058	31.4530	8.3620	23.0910	7.64
2.573	32.9541	10.4322	22.5219	9.91

## FERRIC NITRATE.

TABLE 73.—FERRIC NITRATE.

Freezing-point measurements.			Conductivity measurements ( $\mu_{\infty}0^{\circ} = 190.6$ ).			Refractivities.		
<i>m</i>	<i>J</i>	$\frac{J}{m}$	<i>v</i>	$\mu_{\nu}0^{\circ}$	<i>a</i>	<i>m</i>	$\lambda$	<i>n</i>
0.0748	0.478°	6.39°	0.67	43.2	22.6	0.0748	66° 40'	1.32869
0.1050	0.667	6.36	0.74	48.2	25.3	0.1496	66 00	1.33191
0.1496	0.952	6.37	0.95	63.4	33.3	0.2992	64 35	1.33395
0.2992	2.076	6.93	1.34	82.0	43.0	0.4488	63 20	1.34536
0.4488	3.426	7.63	2.23	102.0	53.5	0.7480	60 58	1.35797
0.7480	6.735	9.00	3.34	117.2	61.5	1.0472	58 40	1.37075
1.0472	11.433	10.92	6.68	136.4	71.6	1.3464	57 35	1.37693
1.3464	17.260	12.82	13.37	152.5	80.0	1.4960	55 37	1.38873
1.4960	21.400	14.30						

Specific gravities.				
<i>m</i>	W <sub>Sol</sub>	W <sub>Salt</sub>	W <sub>H<sub>2</sub>O</sub>	Correction, per cent.
0.0748	25.4176	0.4540	24.9636	0.15
0.1496	25.7871	0.9080	24.8791	0.48
0.2992	26.4839	1.8161	24.6678	1.33
0.4488	27.0558	2.7240	24.3318	2.67
0.7480	28.0547	4.5400	23.5147	5.94
1.0472	29.8432	6.3560	23.4872	6.05
1.3464	31.1931	8.1720	23.0211	7.92
1.4960	31.8451	9.0800	22.7651	8.94

TABLE 73.—FERRIC NITRATE—Continued.

Hydrates.						
<i>m</i>	<i>a</i>	L	$\frac{J}{m}$	L'	<i>m'</i>	H
1.4930	0.226	3.15	14.30	13.03	42.1	28
1.3464	0.253	3.30	12.82	11.81	40.0	29
1.0472	0.333	3.87	10.92	10.26	34.0	33
0.7480	0.430	4.30	9.00	8.47	27.4	37
0.4488	0.535	4.90	7.63	7.42	19.4	43
0.2992	0.615	5.35	6.93	6.84	11.3	37
0.1496	0.716	5.92	6.37	6.34	6.6	..
0.0748	0.800	6.39	6.39	....	....	..

## HYDROCHLORIC ACID.

Having investigated a fairly large number of salts, some of the more common acids were then studied, and the freezing-point lowerings produced by solutions as concentrated as could be used, measured with the thermometers at our disposal. Dilutions ranging from 6 N to 0.05 N were employed. In very dilute solutions hydrochloric acid does not seem to have the power of combining with water. The amount of combined water increases with the concentration from about 0.3 N to the most concentrated solution that was studied (see curve, fig. 56). A possible explanation of the fact that, in dilute solutions, hydrochloric acid does not combine with water at all is given under the general discussion.

TABLE 74.—HYDROCHLORIC ACID.

Freezing-point measurements.			Conductivity measurements ( $\mu \propto 0^\circ = 240.5$ ).		
<i>m</i>	<i>J</i>	$\frac{J}{m}$	<i>v</i>	$\mu_{v0^\circ}$	<i>a</i>
0.05	0.174°	3.59°	0.166	83.05	34.5
0.1	0.355	3.55	0.20	100.2	41.7
0.2	0.712	3.56	0.25	120.2	50.0
0.3	1.080	3.60	0.33	141.1	58.7
0.4	1.442	3.60	0.50	166.6	69.3
0.5	1.832	3.66	1.00	191.0	79.4
0.6	2.250	3.75	1.11	196.0	81.5
0.7	2.634	3.76	1.25	200.5	83.4
0.8	3.070	3.84	1.43	204.0	84.8
0.9	3.540	3.93	1.66	208.0	86.5
1.0	4.100	4.10	2.00	209.5	87.1
2.0	9.937	4.97	2.50	214.0	89.0
3.0	18.100	6.03	3.33	217.0	90.2
4.0	30.5	7.62	5.00	218.0	90.6
5.0	44.0	8.80	10.00	228.5	95.0
6.0	61.0	10.16	20.00	234.0	97.3

TABLE 74.—HYDROCHLORIC ACID—Continued.

Specific gravities.				
<i>m</i>	W <sub>Sol</sub>	W <sub>Acid</sub>	W <sub>H<sub>2</sub>O</sub>	Correction, per cent.
0.05	25.0017	0.0456	24.9551	0.18
0.1	25.0250	0.0911	24.9339	0.26
0.2	25.0716	0.1823	24.8893	0.44
0.3	25.1148	0.2734	24.8414	0.63
0.4	25.1289	0.3646	24.7643	0.94
0.5	25.1712	0.4557	24.7155	1.14
0.6	25.1949	0.5469	24.6480	1.41
0.7	25.2428	0.6380	24.6048	1.58
0.8	25.3075	0.7292	24.5783	1.69
0.9	25.3659	0.8203	24.5456	1.82
1.0	25.4510	0.9115	24.5395	1.84
2.0	25.7906	1.8230	23.9676	4.13
3.0	26.1606	2.7345	23.4261	6.30
4.0	26.5373	3.6460	22.8913	8.43
5.0	26.8555	4.5575	22.2980	10.81
6.0	27.2191	5.4690	21.7501	13.00

Hydrates.						
<i>m</i>	<i>a</i>	L	$\frac{L}{m}$	L'	<i>m'</i>	H
0.05	0.972	3.67	3.59	3.58	.....	.....
0.1	0.950	3.63	3.55	3.54	.....	.....
0.2	0.906	3.55	3.56	3.54	.....	.....
0.3	0.902	3.54	3.60	3.58	0.62	2.07
0.4	0.890	3.51	3.60	3.57	0.89	2.24
0.5	0.871	3.48	3.66	3.62	2.13	4.26
0.6	0.865	3.47	3.75	3.70	3.44	5.74
0.7	0.848	3.44	3.76	3.70	3.90	5.58
0.8	0.834	3.41	3.84	3.78	5.44	6.80
0.9	0.815	3.37	3.93	3.86	7.05	7.83
1.0	0.794	3.34	4.10	4.02	9.40	9.40
2.0	0.693	3.15	4.98	4.77	18.86	9.43
3.0	0.586	2.95	6.03	5.65	26.55	8.85
4.0	0.500	2.79	7.62	6.98	33.35	8.34
5.0	0.417	2.64	8.80	7.85	36.87	7.37
6.0	0.345	2.49	10.16	8.84	39.91	6.65

## HYDROBROMIC ACID.

The hydrobromic acid was kindly prepared for us by Professor Renouf. A fairly wide range of concentrations was investigated. The results were very similar in character to those obtained with hydrochloric acid. The solutions up to about 0.3 N show no hydration. The hydration from this point to the most concentrated solution investigated, is of the same order as for hydrochloric acid (see fig. 56). The number of molecules of water in combination with one molecule of the acid is of the same magnitude with hydrobromic as with hydrochloric acid. It increases from about 0.3 N to 2 N, and then decreases up to the most concentrated solution used. The meaning of this rather surprising fact will be pointed out in the general discussion of the results.

TABLE 75.—HYDROBROMIC ACID.

Freezing-point measurements.			Conductivity measurements ( $\mu\infty 0^\circ = 246$ ).		
$m$	$f$	$\frac{f}{m}$	$v$	$\mu_v 0^\circ$	$a$
0.1229	0.451°	3.67°	0.23	115.8	47.1
0.1843	0.657	3.56	0.27	129.3	52.6
0.2467	0.880	3.57	0.33	145.8	59.3
0.3686	1.350	3.69	0.41	171.0	69.5
0.4914	1.845	3.75	0.54	174.7	71.0
0.614	2.316	3.77	0.82	194.2	78.9
1.229	5.440	4.42	1.63	211.7	86.1
1.843	9.200	4.99	2.03	220.3	89.6
2.457	15.0	6.10	2.71	224.0	91.1
3.072	21.5	7.00	4.07	227.5	92.5
3.686	29.0	7.87	5.43	230.5	93.7
4.300	41.0	9.54	8.14	238.2	96.8
			16.28	244.0	99.2

Specific gravities.				
$m$	$W_{\text{Sol}}$	$W_{\text{Acid}}$	$W_{\text{H}_2\text{O}}$	Correction, per cent.
0.0614	25.0575	0.1243	24.9332	0.27
0.1229	25.1350	0.2487	24.8863	0.46
0.1843	25.2025	0.3730	24.8295	0.68
0.2457	25.2800	0.4973	24.7827	0.87
0.3686	25.4050	0.7460	24.6590	1.36
0.4914	25.5450	0.9946	24.5504	1.80
0.6143	25.7025	1.2433	24.4592	2.16
1.229	26.3925	2.4875	23.9050	4.38
1.843	27.0825	3.7302	23.3523	6.59
2.457	27.7850	4.9730	22.8120	8.75
3.072	28.4500	6.2177	22.2323	11.07
3.686	29.1525	7.4605	21.6920	13.23
4.300	29.8275	8.7032	21.1243	15.50
5.7297	31.4600	11.5075	19.9525	20.19

Hydrates.						
$m$	$a$	$L$	$\frac{f}{m}$	$L'$	$m'$	$H$
0.0614	0.992	3.71	....	....	.....	....
0.1229	0.968	3.66	3.67	3.65	.....	....
0.1843	0.937	3.60	3.56	3.54	.....	....
0.2457	0.925	3.58	3.57	3.54	.....	....
0.3686	0.911	3.55	3.69	3.64	1.67	4.53
0.4914	0.896	3.53	3.75	3.68	2.22	4.52
0.6143	0.861	3.46	3.77	3.69	3.50	5.70
1.229	0.789	3.33	4.42	4.23	11.82	9.62
1.843	0.710	3.18	4.99	4.66	17.65	9.58
2.457	0.695	3.15	6.10	5.57	24.10	9.80
3.072	0.593	2.96	7.00	6.23	29.17	9.48
3.686	0.526	2.84	7.87	6.83	32.40	8.79
4.300	0.471	2.74	9.54	8.06	36.65	8.52

## NITRIC ACID.

The results with nitric acid are of the same general character as those with hydrochloric and hydrobromic acids. The freezing-point lowerings are, however, less in the case of nitric acid, and, since the dissociation is about the same, the hydrating power is smaller. Like hydrochloric and hydrobromic acids, dilute solutions of nitric acid seem to form no hydrates. Not until about 0.7 N is reached is there manifested any appreciable power to combine with water. The total amount of water combined with the acid increases with the concentration up to the most concentrated solution. The number of molecules of water in combination with one molecule of the acid increases from about 0.7 N, with the concentration, to about 4 N, and then begins to decrease with further increase in the concentration.

TABLE 76.—NITRIC ACID.

Freezing-point measurements.			Conductivity measurements ( $\mu_{\infty 0^{\circ}}=235.6$ ).		
$m$	$J$	$\frac{J}{m}$	$v$	$\mu_v 0^{\circ}$	$a$
0.05	0.175°	3.51°	0.166	89.4	37.9
0.10	0.350	3.50	0.20	108.0	45.8
0.20	0.696	3.48	0.25	127.1	53.9
0.30	1.050	3.50	0.33	148.9	63.2
0.40	1.415	3.54	0.50	174.0	73.9
0.50	1.79	3.58	1.00	199.5	84.8
0.60	2.20	3.66	1.11	204.0	86.7
0.70	2.59	3.70	1.25	205.5	87.3
0.80	3.00	3.75	1.43	207.0	88.0
0.90	3.39	3.77	1.66	209.2	88.9
1.00	3.806	3.806	2.00	215.0	91.2
2.00	8.410	4.205	2.50	218.6	92.8
3.00	13.908	4.636	3.33	222.1	94.3
4.00	23.00	5.75	5.00	226.1	96.0
5.00	32.50	6.50	10.00	228.5	97.0
6.00	42.00	7.00	20.00	232.5	98.7

Specific gravities.				
$m$	$W_{\text{Sol}}$	$W_{\text{Acid}}$	$W_{\text{H}_2\text{O}}$	Correction, per cent.
0.05	25.0150	0.0788	24.9362	0.26
0.1	25.0575	0.1576	24.8999	0.40
0.2	25.1425	0.3153	24.8272	0.69
0.3	25.2250	0.4729	24.7521	0.99
0.4	25.3050	0.6305	24.6745	1.30
0.5	25.3900	0.7881	24.6019	1.55
0.6	25.4750	0.9458	24.5292	1.88
0.7	25.5825	1.1034	24.4791	2.08
0.8	25.6400	1.2610	24.3790	2.48
0.9	25.6953	1.4186	24.2767	2.89
1.0	25.7700	1.5763	24.1937	3.23
2.0	25.6193	3.1525	23.4668	6.13
3.0	27.4660	4.7287	22.7373	9.05
4.0	28.2364	6.3050	21.9314	12.25
5.0	29.0029	7.8813	21.1216	15.51
6.0	29.7758	9.4575	20.3183	18.73



TABLE 76.—NITRIC ACID—Continued.

Hydrates.						
<i>m</i>	<i>a</i>	L	$\frac{d}{m}$	L'	<i>m'</i>	H
0.05	0.987	3.70	3.51	3.50	.....	.....
0.1	0.970	3.66	3.50	3.49	.....	.....
0.2	0.960	3.65	3.48	3.46	.....	.....
0.3	0.943	3.61	3.50	3.47	.....	.....
0.4	0.928	3.59	3.54	3.49	.....	.....
0.5	0.912	3.56	3.58	3.52	.....	.....
0.6	0.889	3.51	3.66	3.59	1.24	2.07
0.7	0.880	3.50	3.70	3.62	1.84	2.63
0.8	0.873	3.48	3.75	3.66	2.73	3.41
0.9	0.867	3.47	3.77	3.66	2.88	3.20
1.0	0.848	3.44	3.81	3.69	3.76	3.76
2.0	0.739	3.23	4.21	3.95	10.13	5.06
3.0	0.632	3.04	4.64	4.22	15.53	5.18
4.0	0.539	2.86	5.75	5.05	24.09	6.02
5.0	0.458	2.61	6.50	5.49	29.14	5.83
6.0	0.379	2.56	7.00	5.69	30.56	5.09

## SULPHURIC ACID.

The approximate composition of the hydrates formed by sulphuric acid between the concentrations, normal and 4.37 normal, was calculated by Jones and Getman.\* It was desirable to learn what order of hydration existed in both very concentrated and very dilute solutions of sulphuric acid. The freezing-points of its solutions were measured up to a concentration of 5 N by means of an alcohol thermometer, using solid carbon dioxide and alcohol or ether as the refrigerating agents. The results are given in table 77 and in fig. 52. In dilute solutions no water is held in combination. From about 0.5 to 5 N the amount of combined water increases with the concentration.

TABLE 77.—SULPHURIC ACID.

Freezing-point measurements.			Conductivity measurements ( $\mu_{\infty} 0^{\circ} = 500$ ).		
<i>m</i>	<i>d</i>	$\frac{d}{m}$	<i>v</i>	$\mu_v 0^{\circ}$	<i>a</i>
0.10	0.397°	3.968°	10.00	305.0	61.0
0.20	0.670	3.850	5.00	282.0	56.4
0.30	1.156	3.853	3.33	280.0	56.0
0.40	1.570	3.920	2.50	273.6	54.7
0.60	2.440	4.066	1.67	264.8	52.9
0.80	3.300	4.125	1.25	257.0	51.4
1.00	4.189	4.189	1.00	253.4	50.7
1.50	7.443	4.962	0.67	221.25	44.25
2.00	11.296	5.648	0.50	199.42	39.9
2.50	16.275	6.510	0.40	178.79	35.8
2.73	21.000	7.69	0.37	175.54	35.1
3.28	29.000	8.84	0.30	147.50	29.5
3.825	41.000	10.72	0.26	127.70	25.5
4.37	53.000	12.13	0.23	105.50	21.1
4.50	58.000	12.89	0.22	100.21	20.0
5.00	76.000	15.20	0.20	86.97	17.4

\*Ztschr. phys. Chem., 49, 446 (1904).

TABLE 77.—SULPHURIC ACID—Continued.

Specific gravities.				
<i>m</i>	<i>W</i> <sub>Sol</sub>	<i>W</i> <sub>Acid</sub>	<i>W</i> <sub>H<sub>2</sub>O</sub>	Correction, per cent.
0.1	25.1307	0.2452	24.8855	0.46
0.2	25.2355	0.4904	24.7451	1.02
0.3	25.4205	0.7356	24.6849	1.26
0.4	25.5761	0.9808	24.5953	1.62
0.6	25.8572	1.4712	24.3860	2.46
0.8	26.1187	1.9616	24.1571	3.37
1.00	26.5028	2.4520	24.0508	3.80
1.50	27.2753	3.6780	23.5973	5.61
2.00	27.9968	4.9040	23.0928	7.63
2.50	28.7102	6.1300	22.5802	9.68
2.73	28.9777	6.6885	22.2892	10.84
3.28	29.8027	8.0360	21.7667	12.53
3.825	30.4816	9.3836	21.0980	15.61
4.37	31.1640	10.7065	20.4575	18.17
4.50	31.5062	11.0340	20.4722	18.11
5.00	31.9335	12.2600	19.6735	21.26

Hydrates.						
<i>m</i>	<i>a</i>	<i>L</i>	$\frac{d}{m}$	<i>L'</i>	<i>m'</i>	<i>H</i>
0.10	0.610	4.13	3.968	3.95	.....	.....
0.20	0.564	3.96	3.850	3.81	.....	.....
0.30	0.560	3.94	3.853	3.80	.....	.....
0.40	0.547	3.89	3.920	3.86	.....	.....
0.60	0.529	3.83	4.066	3.97	1.96	3.3
0.80	0.514	3.77	4.125	3.99	3.12	3.9
1.00	0.507	3.75	4.189	4.03	3.86	3.9
1.50	0.443	3.52	4.962	4.68	13.17	9.2
2.00	0.399	3.27	5.648	5.22	20.75	10.4
2.50	0.358	3.19	6.510	5.81	25.42	10.2
2.73	0.351	3.17	7.690	6.86	29.88	10.6
3.28	0.295	2.96	8.840	7.73	34.28	10.4
3.825	0.255	2.81	10.720	9.05	38.31	10.0
4.37	0.211	2.64	12.130	9.93	40.79	9.4
4.50	0.200	2.60	12.890	10.56	41.88	9.3
5.00	0.174	2.51	15.200	11.97	43.95	8.6

## CHROMIC ACID.

Chromic acid gives large freezing-point lowerings at all of the dilutions studied and, not being very highly dissociated, it therefore has great power to form hydrates. As Ostwald pointed out, chromic acid exists in solution in the form of dichromic acid, the hydrogen ions effecting the transformation. The amount of combined water increases regularly with the concentration (see fig. 56), and the amount of water in combination with one molecule of the acid increases, in general, with the dilution of the solution.

TABLE 79.—CHROMIC ACID.

Freezing-point measurements.			Conductivity measurements ( $\mu\infty 0^\circ=523$ ).		
<i>m</i>	<i>J</i>	$\frac{J}{m}$	<i>v</i>	$\mu_v 0^\circ$	<i>a</i>
0.10	0.526°	5.26°	0.286	108.4	20.7
0.15	0.775	5.16	0.333	128.2	24.5
0.20	1.050	5.24	0.400	157.3	30.0
0.30	1.610	5.36	0.500	206.8	39.3
0.40	2.22	5.54	0.666	256.2	49.0
0.50	2.89	5.78	1.000	312.4	59.7
1.00	6.78	6.78	2.000	374.3	71.6
1.50	11.47	7.64	2.500	388.9	74.3
2.00	16.00	8.00	3.33	410.0	78.4
2.50	22.5	9.00	5.00	420.0	80.3
3.00	31.0	10.40	6.66	428.0	81.8
3.50	42.0	12.00	10.00	436.0	83.4
4.00	57.5	14.40	20.00	440.0	84.1
			40.00	452.0	86.4

Specific gravities.				
<i>m</i>	W <sub>Sol</sub>	W <sub>Acid</sub>	W <sub>H<sup>2</sup>O</sub>	Correction, per cent.
0.10	25.3425	0.5456	24.7969	0.81
0.15	25.5125	0.8184	24.6941	1.22
0.20	25.6900	1.0912	24.5988	1.60
0.30	26.0375	1.6368	24.4007	2.00
0.40	26.3875	2.1824	24.2051	3.18
0.50	26.7300	2.7277	24.0023	3.99
1.00	28.4350	5.4555	22.9795	8.08
1.50	30.0950	8.1833	21.9117	12.35
2.00	31.7625	10.9110	20.8515	16.59
2.50	33.3800	13.6388	19.7412	21.03
3.00	34.9825	16.3665	18.6160	25.54
3.50	36.6100	19.0943	17.5157	29.94
4.00	38.2475	21.8220	16.4255	34.30

Hydrates.						
<i>m</i>	<i>a</i>	L	$\frac{J}{m}$	L'	<i>m'</i>	H
0.10	0.834	4.96	5.26	5.22	2.78	27.8
0.15	0.818	4.90	5.16	5.10	2.18	14.5
0.20	0.803	4.85	5.24	5.16	3.33	16.7
0.30	0.784	4.78	5.36	5.25	4.92	16.4
0.40	0.743	4.62	5.54	5.36	7.67	19.2
0.50	0.716	4.52	5.78	5.55	10.31	20.6
1.00	0.597	4.08	6.78	6.23	19.17	19.17
1.50	0.490	3.68	7.64	6.70	25.05	16.70
2.00	0.393	3.32	8.00	6.67	27.90	13.95
2.50	0.300	2.98	9.00	7.11	32.38	12.95
3.00	0.245	2.87	10.40	7.74	34.95	11.65
3.50	0.207	2.63	12.00	8.41	38.18	10.90
4.00	0.134	2.36	14.40	9.46	41.75	10.40

## PHOSPHORIC ACID.

The freezing-point lowerings produced by phosphoric acid are so small that, although the dissociation is not large, the amount of hydration is small, manifesting itself only in the more concentrated solutions.

TABLE 80.—PHOSPHORIC ACID.

Freezing-point measurements.			Conductivity measurements ( $\mu_{\infty} 0^{\circ}=240$ ).		
$m$	$\Delta$	$\frac{\Delta}{m}$	$v$	$\mu_v 0^{\circ}$	$a$
0.1	0.235°	2.35°	0.14	20.0	8.3
0.2	0.458	2.29	0.16	23.4	9.8
0.3	0.667	2.22	0.20	26.8	11.2
0.4	0.868	2.17	0.25	31.6	14.3
0.6	1.292	2.15	0.33	35.2	14.7
0.8	1.775	2.22	0.50	38.0	16.1
1.0	2.370	2.37	1.00	42.0	17.5
2.0	5.550	2.77	1.11	42.6	17.8
3.0	9.75	3.25	1.25	43.0	17.9
4.0	16.50	4.12	1.43	44.4	18.3
5.0	25.00	5.00	1.66	45.1	18.8
6.0	38.00	6.33	2.00	45.8	19.1
6.919	52.00	7.52	2.50	47.5	19.8
			3.33	50.0	20.8
			5.00	61.5	25.6
			10.00	68.6	28.6
			20.00	85.5	35.6
Specific gravities.					
$m$	W <sub>Sol</sub>	W <sub>Acid</sub>	W <sub>H<sub>2</sub>O</sub>	Correction, per cent.	
0.05	25.0550	0.1225	24.9325	0.27	
0.10	25.1025	0.2450	24.8575	0.57	
0.20	25.2425	0.4900	24.7525	0.99	
0.30	25.3750	0.7350	24.6400	1.44	
0.40	25.5075	0.9800	24.5275	1.89	
0.50	25.6375	1.2250	24.4125	2.35	
0.60	25.7650	1.4700	24.2950	2.82	
0.6916	25.9100	1.6952	24.2148	3.14	
0.80	26.0200	1.9600	24.0600	3.76	
0.90	26.1575	2.2050	23.9525	4.29	
1.00	26.2900	2.4500	23.8400	4.64	
2.00	27.6175	4.9000	22.7175	9.13	
3.00	28.8875	7.3500	21.5375	13.85	
4.00	31.1775	9.8000	21.2775	18.89	
5.00	31.4975	12.2500	19.2475	23.01	
6.00	32.7050	14.7000	18.0050	27.98	
6.919	33.5725	16.9516	16.6209	33.52	

TABLE 80.—PHOSPHORIC ACID—Continued.

Hydrates.						
$m$	$a$	L	$\frac{d}{m}$	L'	$m'$	H
0.1	0.286	3.46	2.35	2.34	.....	....
0.2	0.256	3.29	2.29	2.27	.....	....
0.3	0.208	3.02	2.22	2.19	.....	....
0.4	0.198	2.96	2.17	2.13	.....	....
0.6	0.188	2.91	2.15	2.09	.....	....
0.8	0.179	2.86	2.22	2.14	.....	....
1.0	0.175	2.84	2.37	2.26	.....	....
2.0	0.161	2.76	2.77	2.52	.....	....
3.0	0.147	2.68	3.25	2.80	2.38	0.79
4.0	0.143	2.66	4.12	3.33	11.18	2.79
5.0	0.112	2.48	5.00	3.85	19.77	3.95
6.0	0.098	2.41	6.33	4.56	26.19	4.37
6.919	0.083	2.32	7.52	5.00	29.78	4.34

## METHYL ALCOHOL.

The results are given in table 81. A glance at the freezing-point measurements will show a marked increase in the molecular lowering  $m$ , with increase in concentration. This would suggest at first sight that there is considerable hydration in the more concentrated solutions. Such, however, is not the case. When the observed molecular lowering is corrected for specific gravity, *i. e.*, referred to 1,000 grams of the solvent, the observed lowering does not differ greatly from the calculated. This is seen by comparing column L' with column L, under "Hydrates," table 81. At no concentration do we find as much as one molecule of water combined with one molecule of the alcohol. The freezing-point data for methyl alcohol are plotted as a curve (fig. 58). The abscissæ represent concentrations and the ordinates molecular lowering of the freezing-point.

TABLE 81.—METHYL ALCOHOL.

Freezing-point measurements.			Specific gravities.				
$m$	$d$	$\frac{d}{m}$	$m$	W <sub>sol</sub>	W <sub>CH<sub>3</sub>O</sub>	W <sub>H<sub>2</sub>O</sub>	Correction, per cent.
0.5	0.935°	1.87°	0.5	24.8825	0.4000	24.4825	2.07
1.0	1.898	1.90	1.0	24.8071	0.8000	24.0071	3.97
2.0	.....	....	2.0	24.7032	1.6000	23.1032	7.89
3.0	6.440	2.15	3.0	24.5111	2.4000	22.1111	11.86
4.0	9.130	2.28	4.0	24.3773	3.2000	21.1773	15.29
5.0	11.500	2.30	5.0	24.2655	4.0000	20.2655	18.94
6.0	15.000	2.50	6.0	24.1013	4.8000	19.3013	22.79
7.0	19.000	2.71	7.0	24.0195	5.6000	18.4195	26.32
8.0	23.500	2.94	8.0	23.8966	6.4000	17.4966	30.01
9.0	28.500	3.17	9.0	23.7476	7.2000	16.5476	33.81
10.0	33.500	3.35	10.0	23.6050	8.0000	15.6050	37.58

TABLE 81.—METHYL ALCOHOL—Continued.

Hydrates.					
<i>m</i>	L	$\frac{d}{m}$	L'	<i>m'</i>	H
0.5	1.86	1.87	1.83	...	...
1.0	1.86	1.90	1.86	...	...
...	...	...	...	...	...
3.0	1.86	2.15	1.90	1.1	0.4
4.0	1.86	2.28	1.93	2.0	0.5
5.0	1.86	2.30	1.87	...	...
6.0	1.86	2.50	1.93	2.0	0.3
7.0	1.86	2.71	2.00	3.9	0.5
8.0	1.86	2.94	2.06	5.4	0.7
9.0	1.86	3.17	2.10	6.4	0.7
10.0	1.86	3.35	2.10	6.4	0.6

## ETHYL ALCOHOL.

Results were obtained with ethyl alcohol that are of the same general character as those given by methyl alcohol. The freezing-points of the solutions of ethyl alcohol are, however, lower than those of methyl alcohol of the same concentrations. The corrections for specific gravities are larger for the ethyl alcohol, so that the amount of hydration shown by this substance is not very much greater than that shown by methyl alcohol.

The data for ethyl alcohol are recorded in table 82, and the freezing-point measurements are plotted in fig. 58. The magnitude of the hydration shown by ethyl alcohol is seen under "Hydrates," in table 82. There is, of course, the possibility that ethyl alcohol undergoes some polymerization in solution, and that the true hydration is greater than would be indicated by these figures.

TABLE 82.—ETHYL ALCOHOL.

Freezing-point measurements.			Specific gravities.				
<i>m</i>	<i>d</i>	$\frac{d}{m}$	<i>m</i>	W <sub>Sol</sub>	W <sub>C<sub>2</sub>H<sub>5</sub>O</sub>	W <sub>H<sub>2</sub>O</sub>	Correction, per cent.
0.5	0.895°	1.790°	0.5	24.8275	0.5750	24.2525	2.99
1.0	1.872	1.872	1.0	24.7147	1.1500	23.5647	5.74
2.0	4.010	2.005	2.0	24.5514	2.3100	22.2414	9.03
3.0	6.720	2.240	3.0	24.3845	3.4500	20.9345	16.26
4.0	9.960	2.490	4.0	24.2400	4.6200	19.6200	21.52
5.0	14.200	2.840	5.0	24.0891	5.7500	18.3391	26.65
6.0	19.000	3.160	6.0	23.8720	6.9000	16.9720	32.11
7.0	24.250	3.460	7.0	23.6930	8.0500	15.6430	37.43
8.0	30.000	3.740	8.0	23.4333	9.2400	14.1933	43.23

TABLE 82.—ETHYL ALCOHOL—Continued.

Hydrates.					
<i>m</i>	L	$\frac{\Delta}{m}$	L'	<i>m</i> '	H
0.5	1.86	1.790	1.740	...	...
1.0	1.86	1.872	1.765	...	...
2.0	1.86	2.005	1.825	...	...
3.0	1.86	2.240	1.873	...	...
4.0	1.86	2.490	1.955	2.7	0.7
5.0	1.86	2.840	2.082	6.0	1.2
6.0	1.86	3.160	2.150	6.9	1.1
7.0	1.86	3.460	2.166	7.8	1.1
8.0	1.86	3.740	2.120	6.8	0.8

## N-PROPYL ALCOHOL.

Propyl alcohol gives lowerings of the freezing-point that differ markedly from those produced by methyl and ethyl alcohols. The molecular lowering increases with the concentration up to a certain point, passes through a maximum, and then decreases (table 83). The corrected molecular lowering is smaller than the theoretical value, 1.86, at nearly all concentrations, and becomes very much smaller in the more concentrated solutions. Indeed, in a six-normal solution the corrected molecular lowering becomes less than half of the theoretical value. This is shown under "Hydrates," in table 83. The explanation of these results is to be found, undoubtedly, in the polymerization of the molecules of normal propyl alcohol, especially in concentrated solution. It is therefore impossible to say in such cases whether or not there is any hydration.

TABLE 83.—N-PROPYL ALCOHOL.

Freezing-point measurements.			Specific gravities.				Hydrates.				
<i>m</i>	$\Delta$	$\frac{\Delta}{m}$	<i>m</i>	W <sub>Sol</sub>	W <sub>C<sub>3</sub>H<sub>7</sub>OH</sub>	W <sub>H<sub>2</sub>O</sub>	Correction, per cent.	<i>m</i>	L	$\frac{\Delta}{m}$	L'
0.5	0.890°	1.78°	0.5	24.8348	0.7500	24.0848	3.66	0.5	1.86	1.78	1.71
1.0	1.900	1.90	1.0	24.6690	1.5000	23.1690	7.32	1.0	1.86	1.90	1.76
2.0	4.160	2.08	2.0	24.4770	3.0000	21.4770	14.09	2.0	1.86	2.08	1.79
3.0	7.100	2.37	3.0	24.2478	4.5000	19.7478	21.00	3.0	1.86	2.37	2.04
4.0	8.820	2.20	4.0	23.9394	6.0000	14.9394	28.24	4.0	1.86	2.20	1.58
5.0	9.450	1.89	5.0	23.5960	7.5000	16.0960	33.62	5.0	1.86	1.89	1.25
			6.0	23.2411	9.0000	14.2411	43.04	6.0	1.86	1.50	0.85
			7.0	22.8372	10.5000	12.3372	50.65				

## ACETONE.

The freezing-point lowerings produced by acetone increase considerably with increase in the concentration of the solution, but the correction for specific gravity is unusually large (table 84). When the proper corrections are applied, the "true molecular lowerings" decrease with increase in the concentration of the solutions. The experimental values at all concentrations studied are below the calculated value for a non-dissociated, non-polymerized substance, and at great concentrations the values found fall very much below the theoretical value (column  $L'$ , table 84).

This shows that the acetone undergoes polymerization in such solutions, the amount of the polymerization being a function of the concentration—increasing from the most dilute to the most concentrated solutions studied. The freezing-point curve is plotted in fig. 59.

TABLE 84.—ACETONE.

Freezing-point measurements.			Specific gravities.				Hydrates.				
$m$	$d$	$\frac{d}{m}$	$m$	$W_{\text{Sol}}$	$W_{\text{C}_2\text{H}_6\text{O}}$	$W_{\text{H}_2\text{O}}$	Correction, per cent.	$m$	$L$	$\frac{d}{m}$	$L'$
0.5	0.930°	1.860°	0.5	24.8177	0.7250	24.0927	3.63	0.5	1.86	1.860	1.790
1.0	1.919	1.919	1.0	24.7292	1.4500	23.2792	6.88	1.0	1.86	1.919	1.787
2.0	4.110	2.055	2.0	24.5396	2.9000	21.6396	13.44	2.0	1.86	2.055	1.780
3.0	6.800	2.270	3.0	24.3129	4.3500	19.9629	20.15	3.0	1.86	2.270	1.816
4.0	9.700	2.420	4.0	24.1056	5.8000	18.3056	26.78	4.0	1.86	2.420	1.774
5.0	13.000	2.600	5.0	23.8278	7.2500	16.5778	33.69	5.0	1.86	2.600	1.724
6.0	16.000	2.670	6.0	23.5748	8.7000	14.8748	40.00	6.0	1.86	2.670	1.586
7.0	20.000	2.86	7.0	23.2513	10.1500	13.1013	47.59	7.0	1.86	2.860	1.499
8.0	24.000	3.00	8.0	22.9160	11.6000	11.3160	54.74	8.0	1.86	3.000	1.358
9.0	29.560	3.28	9.0	22.5212	13.0500	9.4712	62.12	9.0	1.86	3.280	1.246
10.0	33.750	3.37	10.0	22.0880	14.5000	7.4880	70.04	10.0	1.86	3.370	1.011

## ACETAMIDE.

While the value of  $\frac{d}{m}$  for acetamide increases rapidly with the concentration, the corrected molecular lowering in table 85 does not change appreciably in magnitude. Indeed, the values found at the various dilutions do not vary greatly from the theoretical value 1.86. This indicates that acetamide neither forms hydrates nor undergoes polymerization at any dilution.

There is, of course, the possibility that these influences are simultaneously operative, but, in order that this should be true, we would have to assume that the magnitude of each of these influences was exactly equal at all concentrations, which is a highly improbable assumption. The freezing-point data for acetamide are plotted in fig. 59.



TABLE 85.—ACETAMIDE.

Freezing-point measurements.			Specific gravities.				Hydrates.				
<i>m</i>	$\Delta$	$\frac{\Delta}{m}$	<i>m</i>	W <sub>SoI</sub>	W <sub>CH<sub>3</sub>CONH<sub>2</sub></sub>	W <sub>H<sub>2</sub>O</sub>	Correction, per cent.	<i>m</i>	L	$\frac{\Delta}{m}$	L'
0.4	0.782°	1.93°	0.4	24.9502	0.5900	24.3602	2.56	0.4	1.86	1.93	1.88
1.0	1.930	1.93	1.0	25.0486	1.4750	23.5736	5.70	1.0	1.86	1.93	1.82
2.0	4.050	2.03	2.0	25.1446	2.9500	22.1946	11.22	2.0	1.86	2.03	1.81
3.0	6.440	2.15	3.0	25.2355	4.4250	20.8105	16.76	3.0	1.86	2.15	1.79
4.0	9.150	2.29	4.0	25.3858	5.9000	19.4858	22.06	4.0	1.86	2.29	1.79
5.0	11.800	2.36	5.0	25.4530	7.3750	18.0780	27.69	5.0	1.86	2.36	1.71
6.0	15.800	2.63	6.0	25.5606	8.8500	16.7106	33.16	6.0	1.86	2.63	1.76
7.0	20.750	2.96	7.0	25.6660	9.3250	16.3410	34.64	7.0	1.86	2.96	1.94
8.0	26.000	3.25	8.0	25.7861	11.8000	13.9861	44.06	8.0	1.86	3.25	1.82
9.0	32.500	3.61	9.0	25.8257	13.2750	12.5500	49.80	9.0	1.86	3.61	1.79

## UREA.

The observed molecular depression produced by urea does not change appreciably with the concentration, as is seen in table 86. When these values are corrected for specific gravities, the true molecular lowerings decrease quite markedly with increase in the concentration of the solutions. This is seen in column L' under "Hydrates," table 86. Here, again, we have considerable polymerization, and the amount of the polymerization increases with the concentration of the solutions. The curve for urea is given in fig. 59.

TABLE 86.—UREA.

Freezing-point measurements.			Specific gravities.				Hydrates.				
<i>m</i>	$\Delta$	$\frac{\Delta}{m}$	<i>m</i>	W <sub>SoI</sub>	W <sub>Urea</sub>	W <sub>H<sub>2</sub>O</sub>	Correction, per cent.	<i>m</i>	L	$\frac{\Delta}{m}$	L'
0.5	0.975°	1.95°	0.5	25.1409	0.7500	24.3909	2.44	0.5	1.86	1.95	1.90
1.0	1.878	1.88	1.0	25.3258	1.5000	23.8258	4.70	1.0	1.86	1.88	1.80
1.5	2.900	1.93	1.5	25.4996	2.2500	23.2496	7.00	1.5	1.86	1.93	1.75
2.0	3.800	1.90	2.0	25.7206	3.0000	22.7206	9.12	2.0	1.86	1.90	1.73
2.5	4.724	1.89	2.5	25.8933	3.7500	22.1433	11.43	2.5	1.86	1.89	1.67
3.0	5.767	1.92	3.0	26.1085	4.5000	21.6085	13.57	3.0	1.86	1.92	1.66
3.5	6.555	1.87	3.5	26.2992	5.2500	21.0492	15.80	3.5	1.86	1.87	1.57
4.0	7.625	1.91	4.0	26.4785	6.0000	20.4785	18.09	4.0	1.86	1.91	1.57
4.5	8.975	1.99	4.5	26.6456	6.7500	19.8956	20.42	4.5	1.86	1.99	1.58

## CHLORAL HYDRATE.

The freezing-point curve for chloral hydrate (fig. 59) is somewhat remarkable. It shows one or two well-defined breaks, the meaning of which is not apparent. While the observed molecular lowering increases quite markedly with the concentration ("Freezing-point measurements," table 87), the corrected molecular lowering, L' (hydrates table 87), shows only slight increase as the concentration of the solution increases. The true molecular

lowering produced by chloral hydrate is never much larger than the theoretical value, and, therefore, this substance does not show any marked hydration at any of the dilutions with which we worked.

TABLE 87.—CHLORAL HYDRATE.

Freezing-point measurements.			Specific gravities.					Hydrates.			
<i>m</i>	$\Delta$	$\frac{\Delta}{m}$	<i>m</i>	$W_{Sol}$	$W_{CCl_3COH.H_2O}$	$W_{H_2O}$	Correction, per cent.	<i>m</i>	L	$\frac{\Delta}{m}$	L'
0.15	0.260°	1.73°	0.15	25.2450	0.6202	24.6248	1.50	0.15	1.86	1.73	1.70
0.30	0.556	1.85	0.3	25.5002	1.2405	24.2597	2.96	0.3	1.86	1.85	1.80
0.60	1.241	2.07	0.6	26.0785	2.4810	23.5975	5.61	0.6	1.86	2.07	1.95
0.90	1.825	2.03	0.9	26.5458	3.7215	22.8243	8.70	0.9	1.86	2.03	1.85
1.2	2.505	2.09	1.2	27.1197	4.9620	22.1577	11.37	1.2	1.86	2.09	1.86
1.5	3.274	2.18	1.5	27.6235	6.1025	21.5210	13.92	1.5	1.86	2.18	1.88
1.8	4.176	2.29	1.8	28.1998	7.4430	20.7568	16.97	1.8	1.86	2.29	1.90
2.1	5.200	2.52	2.1	28.7492	8.6835	20.0657	19.74	2.1	1.86	2.52	2.02
2.4	6.170	2.58	2.4	29.1582	9.9240	19.2342	23.06	2.4	1.86	2.58	2.00
2.7	7.200	2.67	2.7	29.3230	11.1645	18.1585	27.37	2.7	1.86	2.67	1.95
3.0	8.280	2.76	3.0	30.2896	12.4050	17.8846	28.46	3.0	1.86	2.76	1.97

## GLYCEROL.

The case of glycerol among the non-electrolytes is particularly interesting, in that it shows very marked hydration. This would be indicated by the large molecular lowerings recorded in table 88, and is obvious from the large values of the corrected molecular lowerings, L', under "Hydrates," in that table. The degree of the hydration is shown in column H, under "Hydrates," table 88. We are impressed, first, by the large number of molecules of water combined with one molecule of the glycerol, and, second, by the fact that the complexity of the hydrate increases regularly from the most dilute to the most concentrated solution investigated. The hydrate curve for glycerol is given in fig. 61, where the abscissæ represent concentrations, and the ordinates the number of molecules of water combined with one molecule of glycerol.

TABLE 88.—GLYCEROL.

Freezing-point measurements			Specific gravities.				
<i>m</i>	$\Delta$	$\frac{\Delta}{m}$	<i>m</i>	$W_{Sol}$	$W_{C_3H_5(OH)_3}$	$W_{H_2O}$	Correction, per cent.
0.2	0.76°	3.80°	0.2	25.2010	0.4600	24.7410	1.04
0.4	1.65	4.12	0.4	25.3351	0.9200	24.4151	2.34
0.8	3.75	4.70	0.8	25.8055	1.8400	23.9655	4.14
1.2	6.00	5.00	1.2	26.2256	2.7600	23.4656	6.14
1.6	8.70	5.44	1.6	26.6655	3.6800	22.9855	8.05
2.0	12.00	6.00	2.0	27.0463	4.6000	22.4463	10.21
2.4	16.50	6.87	2.4	27.4440	5.5200	21.9240	12.30
2.8	21.00	7.50	2.8	27.8344	6.4400	21.3944	14.42
3.2	26.50	8.28	3.2	28.1801	7.3600	20.8201	16.72
3.6	36.00	10.00	2.6	28.5580	8.2800	20.2780	18.89

TABLE 88.—GLYCEROL—Continued.

Hydrates.					
$m$	L	$\frac{J}{m}$	$L'$	$m'$	H
0.2	1.86	3.80	3.76	28.0	140.0
0.4	1.86	4.12	4.03	30.1	75.2
0.8	1.86	4.70	4.51	32.6	40.8
1.2	1.86	5.00	4.70	33.5	28.0
1.6	1.86	5.44	5.00	34.9	21.8
2.0	1.86	6.00	5.40	36.4	18.2
2.4	1.86	6.87	6.03	38.6	16.1
2.8	1.86	7.50	6.42	39.4	10.5
3.2	1.86	8.28	7.30	41.4	12.9
3.6	1.86	10.00	8.11	42.8	11.9

## GLUCOSE.

Turning to the carbohydrates, we find very little hydration shown by glucose. The freezing-point lowerings produced by glucose are plotted in fig. 60. A comparison of the corrected molecular lowerings,  $L'$ , table 89, with the theoretical molecular lowering,  $L$ , of the same table, will show that in the more concentrated solutions the experimental value is slightly greater than the theoretical. The difference is so small that the amount of hydration shown by this substance is very slight indeed.

TABLE 89.—GLUCOSE.

Freezing-point measurements.			Specific gravities.				Hydrates.				
$m$	$J$	$\frac{J}{m}$	$m$	$W_{\text{Sol}}$	$W_{\text{C}_6\text{H}_{12}\text{O}_6}$	$W_{\text{H}_2\text{O}}$	Correction, per cent.	$m$	L	$\frac{J}{m}$	$L'$
0.2	0.385°	1.91°	0.2	25.2810	0.9000	24.3810	2.48	0.2	1.86	1.91	1.86
0.3	0.574	1.91	0.3	25.4412	1.3500	24.0912	3.64	0.3	1.86	1.91	1.85
0.4	0.780	1.95	0.4	25.6245	1.8000	23.8245	4.70	0.4	1.86	1.95	1.86
0.5	1.023	2.04	0.5	25.8192	2.2500	23.5689	5.72	0.5	1.86	2.04	1.92
0.6	1.220	2.03	0.6	25.9539	2.7000	23.2539	6.98	0.6	1.86	2.03	1.89
0.7	1.430	2.04	0.7	26.1361	3.1500	22.9861	8.06	0.7	1.86	2.04	1.88
0.8	1.690	2.11	0.8	26.2819	3.6600	22.6819	9.27	0.8	1.86	2.11	1.91
0.9	1.930	2.14	0.9	26.4712	4.0500	22.4212	10.32	0.9	1.86	2.14	1.93
			1.0	26.5827	4.5000	22.0827	11.67				

## FRUCTOSE.

Fructose, unlike glucose, shows considerable hydration, especially in the more dilute solutions. The complexity of the hydrates is seen in column H, table 90. Fructose, like glycerol, forms hydrates that are more and more complex the more dilute the solution. The non-electrolytes that form hydrates in solution thus resemble the electrolytes. The complexity of the latter, however, sometimes reaches a maximum at a definite concentration,

and then becomes less and less, both with increase in the dilution and with increase in the concentration of the solutions. This is probably connected in some way with the fact that with the non-electrolytes we have only molecules present, while in solutions of electrolytes we have both molecules and ions present. The curve of hydrates for fructose is given in fig. 61.

TABLE 90.—FRUCTOSE.

Freezing-point measurements.			Specific gravities.				
$m$	$\Delta$	$\frac{\Delta}{m}$	$m$	W <sub>SoI</sub>	W <sub>C<sub>2</sub>H<sub>12</sub>O<sub>6</sub></sub>	W <sub>H<sub>2</sub>O</sub>	Correction, per cent.
0.2	0.384°	1.92°	0.2	25.3519	0.9000	24.4519	2.19
0.3	0.610	2.03	0.3	25.5315	1.3500	24.1815	3.27
0.4	0.830	2.07	0.4	25.7306	1.8000	23.9306	4.28
0.5	1.054	2.11	0.5	25.8911	2.2500	23.6411	5.44
0.6	1.265	2.11	0.6	26.0845	2.7000	23.3845	6.46
0.7	1.535	2.19	0.7	26.1856	3.1500	23.0356	7.86
0.8	1.765	2.21	0.8	26.4080	3.6000	22.8080	8.77
0.9	2.033	2.26	0.9	26.5790	4.0500	22.5290	8.88
1.0	2.300	2.30	1.0	26.7699	4.5000	22.2699	10.92

Hydrates.					
$m$	L	$\frac{\Delta}{m}$	L'	$m'$	H
0.2	1.86	1.92	1.88	...	....
0.3	1.86	2.03	1.96	2.8	14.0
0.4	1.86	2.07	1.98	3.7	9.2
0.5	1.86	2.11	2.00	3.9	7.8
0.6	1.86	2.11	1.99	3.6	6.0
0.7	1.86	2.19	2.02	4.4	6.3
0.8	1.86	2.21	2.02	4.4	5.5
0.9	1.86	2.26	2.04	5.0	5.5
1.0	1.86	2.30	2.05	5.3	5.3

## MANNITE.

Mannite, on the other hand, has very little power to combine with water at any of the dilutions at which work could be done. On account of its comparatively slight solubility, however, we could not work at any considerable concentration. A comparison of column L' with column L, table 91, shows that this substance gives molecular lowerings of the freezing-point of water that are only slightly greater than the theoretical lowering. Further, there is no apparent regularity in the difference between the value found and the calculated value. The amount of hydration is so slight that it was not even calculated. The values of  $\frac{\Delta}{m}$ , table 91, for this substance are plotted in fig. 60.

TABLE 91.—MANNITE.

Freezing-point measurements.			Specific gravities.					Hydrates.			
<i>m</i>	<i>d</i>	$\frac{d}{m}$	<i>m</i>	W <sub>So1</sub>	W <sub>C<sub>6</sub>H<sub>14</sub>O<sub>5</sub></sub>	W <sub>H<sub>2</sub>O</sub>	Correction, per cent.	<i>m</i>	L	$\frac{d}{m}$	L'
0.2	0.400°	2.00°	0.2	25.2628	0.9100	24.3528	2.59	0.2	1.86	2.00	1.95
0.3	0.600	2.00	0.3	25.4320	1.3650	24.0670	3.73	0.3	1.86	2.00	1.93
0.4	0.800	2.00	0.4	25.5747	1.8200	23.7547	4.98	0.4	1.86	2.00	1.90
0.5	1.033	2.07	0.5	25.7431	2.2750	23.4681	6.13	0.5	1.86	2.07	1.95
0.6	1.234	2.06	0.6	25.9235	2.7300	23.1935	7.23	0.6	1.86	2.06	1.91
0.7	1.440	2.06	0.7	26.0495	3.2350	22.8145	8.74	0.7	1.86	2.06	1.88
0.8	1.700	2.13	0.8	26.1478	3.6400	22.5078	9.97	0.8	1.86	2.13	1.92

## LACTOSE.

Lactose not only shows no hydration, but the corrected molecular lowerings, L', table 92, are less than the theoretical value 1.86. This would indicate a certain amount of polymerization in the solutions. On account of the limited solubility of lactose we could not study concentrations greater than half-normal. The molecular lowerings  $\frac{d}{m}$ , table 92, found for lactose are plotted in a curve, fig. 60.

TABLE 92.—LACTOSE.

Freezing-point measurements.			Specific gravities.					Hydrates.			
<i>m</i>	<i>d</i>	$\frac{d}{m}$	<i>m</i>	W <sub>So1</sub>	W <sub>C<sub>12</sub>H<sub>22</sub>O<sub>11</sub></sub>	W <sub>H<sub>2</sub>O</sub>	Correction, per cent.	<i>m</i>	L	$\frac{d}{m}$	L'
0.2	0.364°	1.82°	0.2	25.5793	1.7100	23.8693	4.52	0.2	1.86	1.82	1.74
0.3	0.574	1.91	0.3	25.8796	2.5650	23.3146	6.74	0.3	1.86	1.91	1.78
0.4	0.792	1.98	0.4	26.1958	3.4200	22.7758	8.89	0.4	1.86	1.98	1.80
0.5	1.030	2.06	0.5	26.5176	4.2750	22.2426	11.03	0.5	1.86	2.06	1.83

## CANE-SUGAR.

It has been known for some time that cane-sugar, in concentrated solutions, gives molecular lowerings that are considerably greater than the theoretical value. Arrhenius\* established this fact in connection with his early work on the theory of electrolytic dissociation. Jones and Getman decided to make a comparatively thorough study of cane-sugar, using solutions much more concentrated than those employed by Arrhenius. They found that they could work to a concentration of twice normal. The freezing-point lowerings given in table 93 are plotted in fig. 60. Cane-sugar shows very considerable hydration. The curve showing the complexity of the hydrates of cane-sugar is given in fig. 61.

\* Ztschr. phys. Chem., 2, 495 (1888).

TABLE 93.—CANE-SUGAR.

Freezing-point measurements.			Specific gravities.				
$m$	$J$	$\frac{J}{m}$	$m$	$W_{Sol}$	$W_{C_{12}H_{22}O_{11}}$	$W_{H_2O}$	Correction, per cent.
0.2	0.404°	2.02°	0.2	25.5904	1.7100	23.8804	4.48
0.4	0.848	2.12	0.4	26.2388	3.4200	22.8188	8.72
0.6	1.345	2.24	0.6	26.8635	5.1300	21.7335	13.06
0.8	1.950	2.44	0.8	27.5678	6.8400	20.6678	17.33
1.0	2.662	2.66	1.0	28.0680	8.5500	19.5180	21.93
1.2	3.550	2.96	1.2	28.6920	10.2600	18.4320	26.27
1.4	4.612	3.29	1.4	29.3441	11.9700	17.3741	30.50
1.6	5.800	3.62	1.6	29.8762	13.6800	16.1962	35.22
1.8	7.230	4.02	1.8	30.4824	15.3900	15.0924	39.63
2.0	9.130	4.57	2.0	31.1005	17.1000	14.0005	44.00

Hydrates.					
$m$	$L$	$\frac{J}{m}$	$L'$	$m'$	$H$
0.2	1.86	2.02	1.93	2.0	10.0
0.4	1.86	2.12	1.94	2.3	5.8
0.6	1.86	2.24	1.95	2.5	4.2
0.8	1.86	2.44	2.02	4.4	5.5
1.0	1.86	2.66	2.07	5.5	5.5
1.2	1.86	2.96	2.18	8.1	6.7
1.4	1.86	3.29	2.29	10.4	7.4
1.6	1.86	3.62	2.35	11.6	7.2
1.8	1.86	4.02	2.43	13.0	7.2
2.0	1.86	4.57	2.56	15.2	7.6

## ORGANIC ACIDS.

The organic acids really belong in the class of the electrolytes. But since they are, generally speaking, weakly dissociated compounds, they have been studied as a class by themselves. Some of these substances contain a small amount of water of crystallization, but, generally, they crystallize either without water or with only a small amount.

Five organic acids have thus far been studied, and the results are given below. The symbols in the tables which follow have precisely the same significance as in the preceding. Organic acids being electrolytes, their conductivities were measured. These are recorded in the tables headed "Conductivity measurements."  $v$  is the volume of the solutions,  $\mu_v$  their molecular conductivities, and  $\alpha$  their dissociation.

## ACETIC ACID.

Acetic acid being soluble in water in all proportions, work was extended to a ten-normal concentration. Although the observed freezing-point lowering increased with the concentration, the corrected lowering decreased regularly from the most dilute to the most concentrated solution studied.

The corrected lowering found experimentally, was less than the theoretical lowering at all concentrations except the most dilute. This shows that acetic acid in water is polymerized, and that the amount of the polymerization is greater the more concentrated the solution. This is exactly in accord with what was pointed out earlier by Jones and Murray,\* in their investigation on the effect of one associated liquid on the association of another associated liquid. They showed that water—an associated liquid—diminishes the association of acetic acid, which is also a strongly associated liquid, and that the magnitude of this effect is a function of the amount of water relative to the amount of acetic acid present. The more concentrated the solution of acetic acid, the greater will be the complexity of its molecules. A few of the freezing-point data for acetic acid are plotted in fig. 62. The conductivities of acetic acid are perfectly normal and are plotted in fig. 63.

Acetic acid shows no evidence of the formation of hydrates except, possibly, in the most dilute solution studied.

TABLE 94.—ACETIC ACID.

Freezing-point measurements.			Conductivity measurements.		
<i>m</i>	<i>J</i>	$\frac{J}{m}$	<i>v</i>	$\mu_{v}0^{\circ}$	<i>a</i>
0.1	0.210°	2.10°	0.100	0.04	...
0.5	0.945	1.89	0.125	0.07	...
1.0	1.908	1.91	0.14	0.10	...
2.0	4.000	2.00	0.16	0.14	...
3.0	6.190	2.06	0.20	0.19	...
4.0	8.260	2.06	0.25	0.25	...
5.0	10.500	2.10	0.33	0.35	0.1
6.0	13.000	2.17	0.5	0.52	0.2
7.0	15.200	2.17	1.0	0.85	0.3
8.0	18.000	2.25	2.0	1.33	0.5
10.0	24.000	2.40	10.0	3.07	1.1

Specific gravities.				
<i>m</i>	W <sub>Sol</sub>	W <sub>Acid</sub>	W <sub>H<sub>2</sub>O</sub>	Correction, per cent.
0.1	24.9635	0.1500	24.8135	0.75
0.5	25.0450	0.7500	24.2950	2.82
1.0	25.1337	1.5000	23.6337	5.47
2.0	25.3257	3.0000	22.3257	10.70
3.0	25.5228	4.5000	21.0228	15.91
4.0	25.7159	6.0000	19.7159	21.14
5.0	25.8570	7.5000	18.3570	26.57
6.0	26.0329	9.0000	17.0329	31.87
7.0	26.1834	10.5000	15.6834	37.27
8.0	26.2843	12.0000	14.2843	42.86
10.0	26.5551	15.0000	11.5551	53.78

\*Amer. Chem. Journ., 30, 193 (1903)

TABLE 94.—ACETIC ACID—Continued.

Hydrates.				
$m$	$a$	L	$\frac{L}{m}$	L'
0.1	0.010	1.89	2.10	2.08
0.5	0.005	1.87	1.89	1.84
1.0	0.003	1.86	1.91	1.80
2.0	.....	1.86	2.00	1.78
3.0	.....	1.86	2.06	1.73
4.0	.....	1.86	2.06	1.63
5.0	.....	1.86	2.10	1.53
6.0	.....	1.86	2.17	1.48
7.0	.....	1.86	2.17	1.38
8.0	.....	1.86	2.25	1.18
10.0	.....	1.86	2.40	1.10

## OXALIC ACID.

The freezing-point lowerings produced by oxalic acid decrease with increase in concentration, falling below the theoretical value if oxalic acid was not dissociated (table 95). Oxalic acid is, however, very appreciably dissociated, as is shown under "Conductivity measurements," table 95.

When the corrected molecular lowering  $L'$ , table 95, is compared with the molecular lowering L, calculated on the basis of the dissociation of the acid as given under "Conductivity measurements," it will be seen that the value found experimentally is much less than the calculated value, at all the dilutions studied. This shows that oxalic acid, like acetic acid, undergoes polymerization in solution, and there is no evidence for or against the existence of hydrates in such solutions. The freezing-point and conductivity data for oxalic acid are given in figs. 62 and 63.

TABLE 95.—OXALIC ACID.

Freezing-point measurements.			Conductivity measurements.		
$m$	$\Delta$	$\frac{\Delta}{m}$	$v$	$\mu_{\infty}0^{\circ}$	$a$
0.05	0.101°	2.01°	1.25	55.40	18.0
0.1	0.207	2.07	1.67	61.66	22.0
0.2	0.382	1.91	2.5	73.75	25.0
0.4	0.725	1.81	5.0	91.44	31.0
			10.0	106.50	36.0
			20.0	117.80	39.0



TABLE 95.—OXALIC ACID—Continued.

Specific gravities.				
<i>m</i>	W <sub>Sol</sub>	W <sub>Acid</sub>	W <sub>H<sub>2</sub>O</sub>	Correction, per cent.
0.05	24.9785	0.1125	24.8660	0.54
0.1	25.0174	0.2250	24.7924	0.83
0.2	25.1012	0.4500	24.6512	1.40
0.4	25.2235	0.9000	24.3235	2.71
Hydrates.				
<i>m</i>	<i>a</i>	L	$\frac{J}{m}$	L'
0.05	0.39	3.31	2.01	2.00
0.1	0.36	3.18	2.07	2.05
0.2	0.31	3.01	1.91	1.88
0.4	0.25	2.79	1.81	1.75

## SUCCINIC ACID.

The freezing-point lowerings of succinic acid pass through a minimum (table 96). The corrected lowerings of succinic acid also pass through a minimum (L', "Hydrates," table 96). If the corrected lowerings found experimentally be compared with the lowerings calculated from dissociation, the former will be seen to be always less than the latter. This would show that succinic acid, like oxalic acid, is somewhat polymerized in solution, but the polymerization is less than in the case of oxalic acid.

The freezing-point and conductivity data for succinic acid are plotted in curves, figs. 62 and 63.

TABLE 96.—SUCCINIC ACID.

Freezing-point measurements.			Conductivity measurements.		
<i>m</i>	J	$\frac{J}{m}$	<i>v</i>	$\mu_v 0^\circ$	<i>a</i>
0.05	0.100°	2.00°	2.5	2.54	1.2
0.10	0.180	1.80	4.0	3.46	1.6
0.15	0.260	1.73	5.0	3.94	1.9
0.20	0.360	1.80	6.7	4.54	2.1
0.25	0.475	1.90	10.0	5.33	2.5
			20.0	7.30	3.5

TABLE 96.—SUCCINIC ACID—Continued.

Specific gravities.				
<i>m</i>	W <sub>Sol</sub>	W <sub>Acid</sub>	W <sub>H<sub>2</sub>O</sub>	Correction, per cent.
0.05	24.9731	0.1475	24.8256	0.70
0.10	25.0379	0.2950	24.7429	1.03
0.15	25.0625	0.4425	24.6200	1.44
0.20	25.0839	0.5900	24.4939	2.02
0.25	25.1448	0.7375	24.4073	2.37
0.40	25.2518	1.1800	24.0718	3.71
Hydrates.				
<i>m</i>	<i>a</i>	L	$\frac{J}{m}$	L'
0.05	0.035	1.99	2.00	1.99
0.10	0.025	1.95	1.80	1.78
0.15	0.021	1.94	1.73	1.71
0.20	0.019	1.93	1.80	1.74
0.25	0.016	1.92	1.90	1.83

## TARTARIC ACID.

There is a well-defined minimum in the molecular lowerings,  $\frac{J}{m}$ , of tartaric acid. This is seen in table 97 and in fig. 61. The minimum also appears in the column under "Hydrates," table 97, which is the molecular lowerings corrected for specific gravities. The corrected molecular lowerings for tartaric acid are very nearly identical with the molecular lowerings calculated from the dissociation, L, table 97. This is true for all of the dilutions studied. Tartaric acid is, then, an example of a compound that undergoes neither polymerization nor hydration in solution. The conductivities of tartaric acid are perfectly normal, as shown by the curve in fig. 63.

TABLE 97.—TARTARIC ACID.

Freezing-point measurements.			Conductivity measurements ( $\mu\infty 0^\circ=300$ ).		
<i>m</i>	<i>J</i>	$\frac{J}{m}$	<i>v</i>	$\mu_0 0^\circ$	<i>a</i>
0.05	0.111°	2.22°	1.00	5.76	1.9
0.1	0.217	2.17	1.25	6.69	2.2
0.2	0.425	2.13	1.67	8.02	2.7
0.4	0.826	2.06	2.5	10.13	3.4
0.6	1.230	2.05	5.0	14.34	4.8
0.8	1.680	2.10	10.0	20.54	6.8
1.0	2.150	2.15	20.0	28.05	9.3

TABLE 97.—TARTARIC ACID—Continued.

Specific gravities.				
<i>m</i>	W <sub>Sol</sub>	W <sub>Acid</sub>	W <sub>H<sub>2</sub>O</sub>	Correction, per cent.
0.05	25.0124	0.1875	24.8249	0.70
0.1	25.0973	0.3750	24.7223	1.11
0.2	25.2584	0.7500	24.5084	1.97
0.4	25.5930	1.5000	24.0930	3.63
0.6	25.9172	2.2500	23.6672	5.33
0.8	26.3938	3.0000	23.3938	6.42
1.0	26.5651	3.7500	22.8151	8.74
Hydrates.				
<i>m</i>	<i>a</i>	L	$\frac{J}{m}$	L'
0.05	0.094	2.22	2.22	2.20
0.1	0.065	2.10	2.17	2.15
0.2	0.048	2.04	2.13	2.09
0.4	0.034	1.99	2.06	1.99
0.6	0.027	1.96	2.05	1.94
0.8	0.022	1.94	2.10	1.97
1.0	0.019	1.93	2.15	1.96

## CITRIC ACID.

Column  $\frac{J}{m}$ , table 98, shows a well-defined minimum in the molecular freezing-point lowerings of citric acid. This is seen in the citric acid curve, fig. 5, and in the corrected molecular lowerings for citric acid, L', table 98. Citric acid is another example of a compound that shows neither polymerization nor hydration in solution. The corrected experimental values in column L' agree closely with the values calculated from the dissociation of the acid as given in column L, table 98. The conductivity curve of citric acid is of the same nature and magnitude as that of the other organic acids which were studied, with the exception of oxalic acid, which has a much larger conductivity.

TABLE 98.—CITRIC ACID.

Freezing-point measurements.			Conductivity measurements ( $\mu_{\infty} 0^{\circ}=630$ ).		
<i>m</i>	<i>J</i>	$\frac{J}{m}$	<i>v</i>	$\mu_v 0^{\circ}$	<i>a</i>
0.05	0.107°	2.14°	1.00	4.23	0.7
0.1	0.207	2.07	1.25	5.33	0.8
0.2	0.418	2.09	1.67	6.99	1.1
0.4	0.830	2.07	2.5	7.49	1.3
0.6	1.253	2.09	5.0	13.04	2.0
0.8	1.707	2.13	10.0	17.60	2.8
1.0	2.230	2.30	20.0	24.20	3.8

TABLE 98.—CITRIC ACID—Continued.

Specific gravities.				
<i>m</i>	W <sub>Sol</sub>	W <sub>Acid</sub>	W <sub>H<sub>2</sub>O</sub>	Correction, per cent.
0.05	24.8406	0.2625	24.5781	1.69
0.1	25.1212	0.5250	24.5962	1.61
0.2	25.2869	1.0500	24.2369	3.05
0.4	25.8255	2.1000	23.7255	5.10
0.6	26.0707	3.1500	22.9207	8.32
0.8	26.4768	4.2000	22.2768	9.89
1.0	26.8365	5.2500	21.5865	13.65

Hydrates.				
<i>m</i>	<i>a</i>	L	$\frac{L}{m}$	L'
0.05	0.038	2.07	2.14	2.10
0.1	0.020	2.02	2.07	2.04
0.2	0.020	1.97	2.09	2.03
0.4	0.013	1.93	2.07	1.97
0.6	0.011	1.92	2.09	1.92
0.8	0.008	1.90	2.13	1.92
1.0	0.007	1.89	2.30	1.99

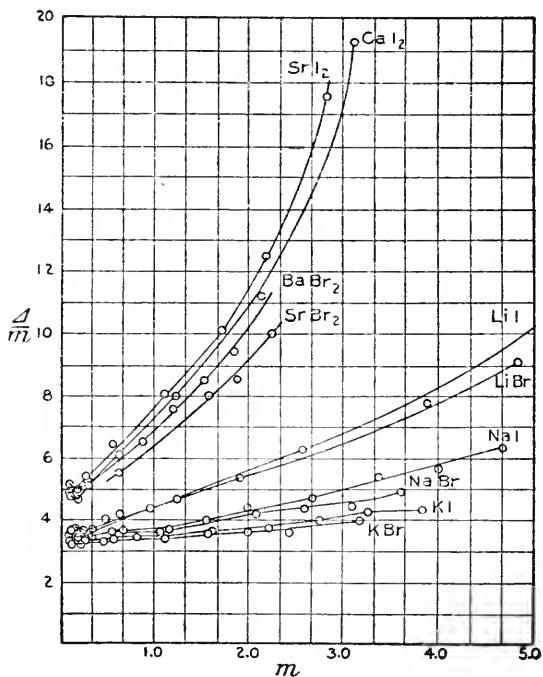

FIG. 19.

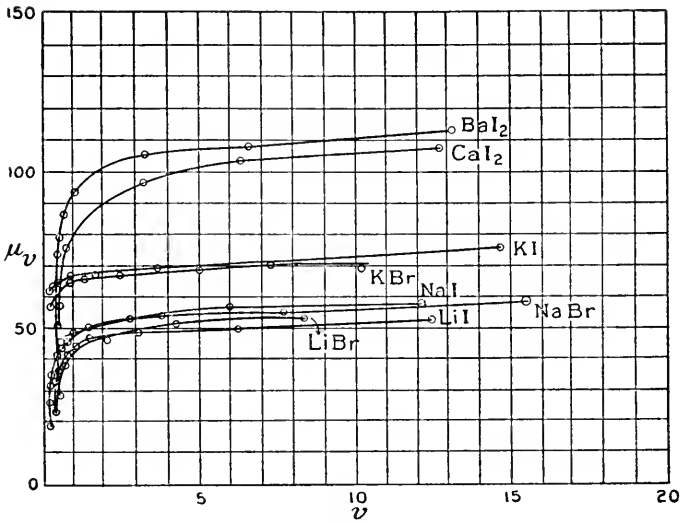

FIG. 20.

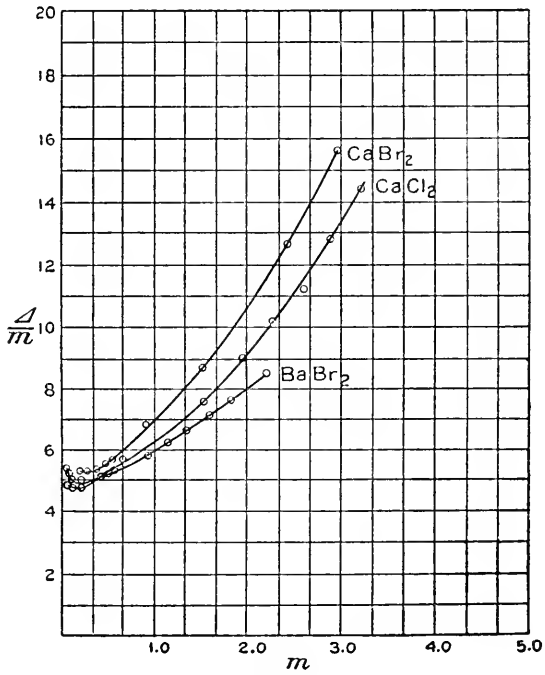

FIG. 21.

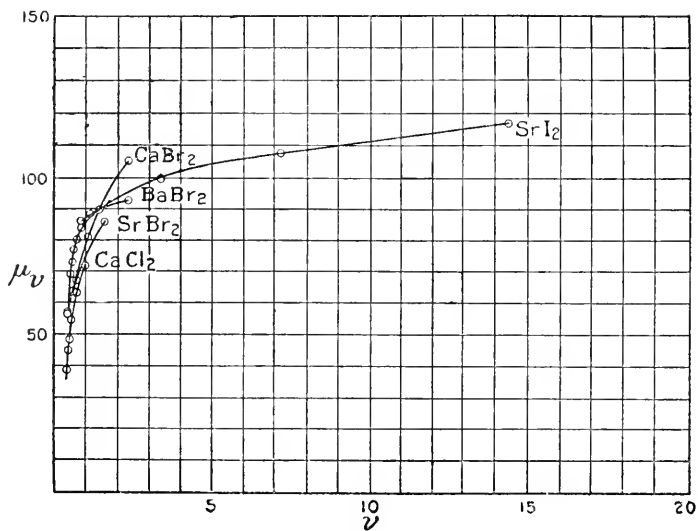

FIG. 22.

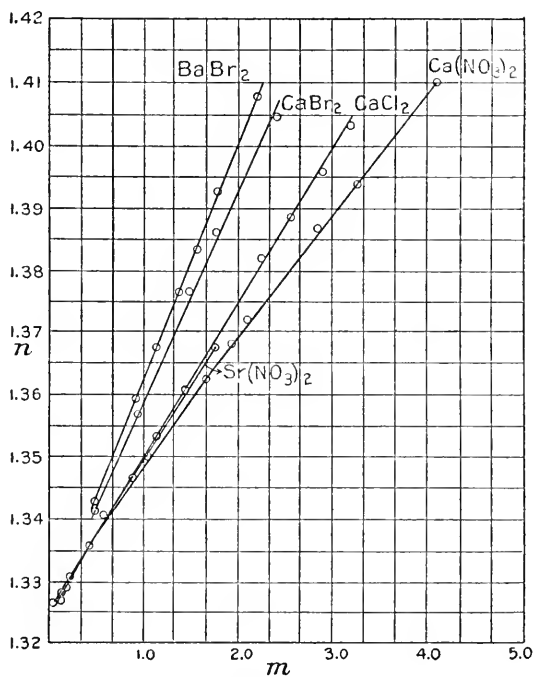

FIG. 23.

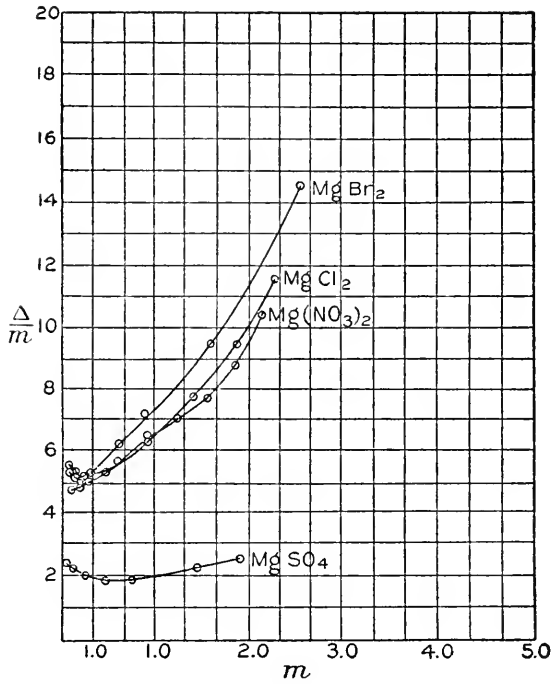

FIG. 24.

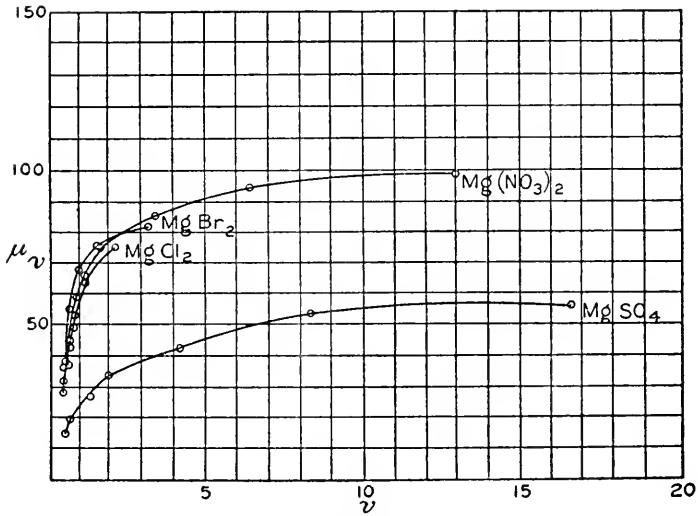

FIG. 25.

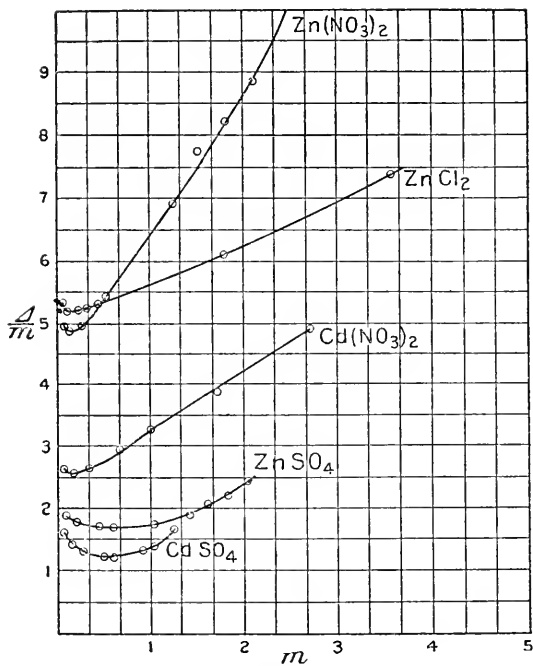

FIG. 26.

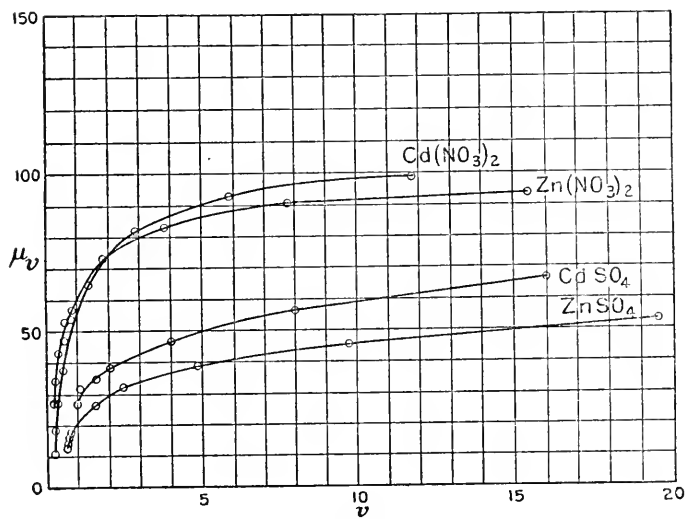

FIG. 27.



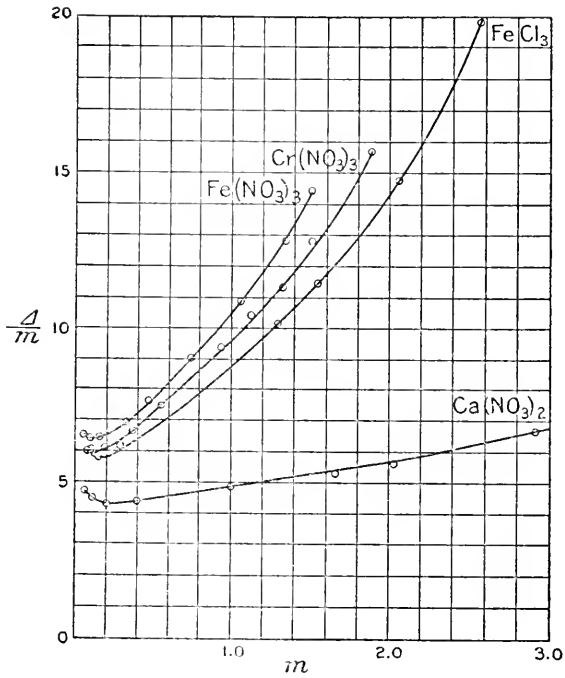

FIG. 28.

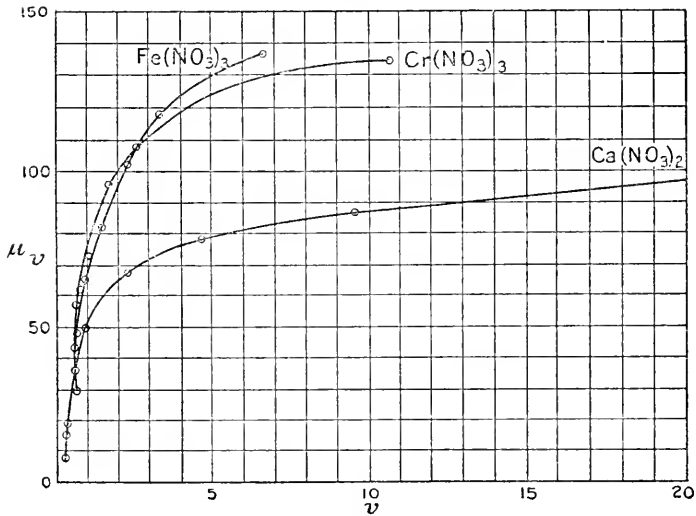

FIG. 29.

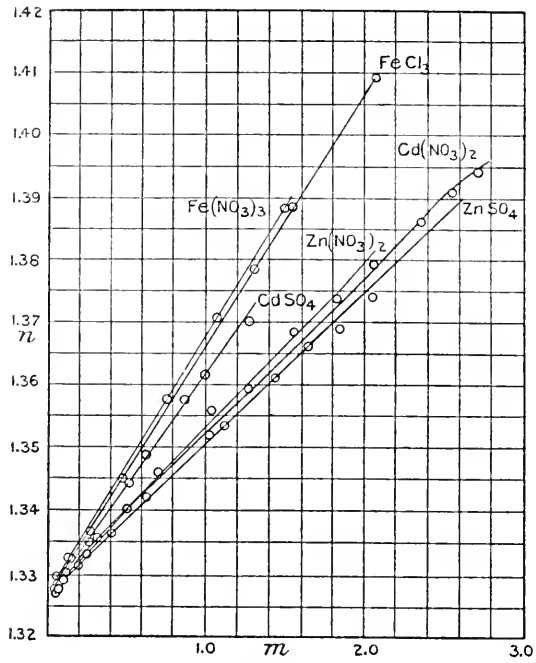

FIG. 30.

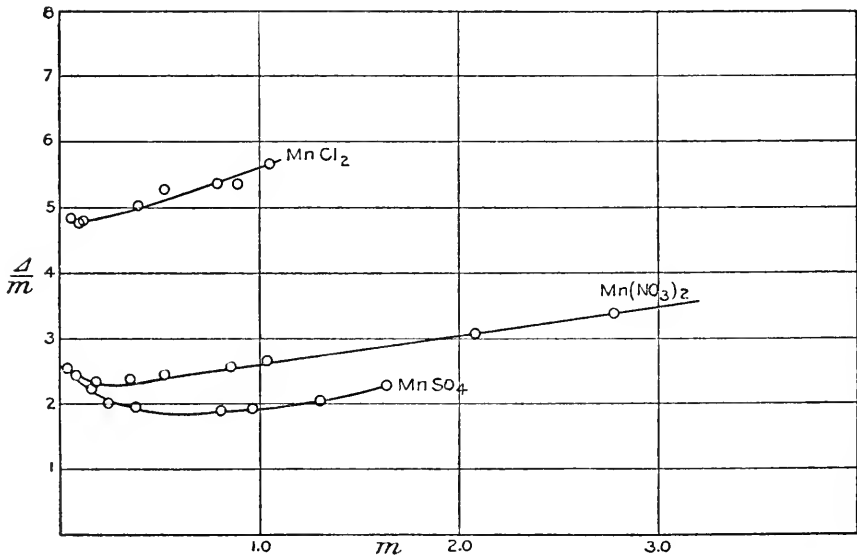

FIG. 31.

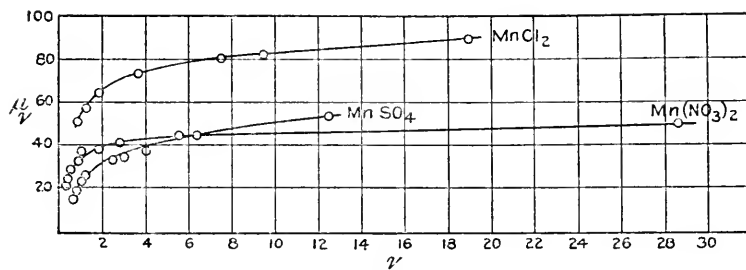

FIG. 32.

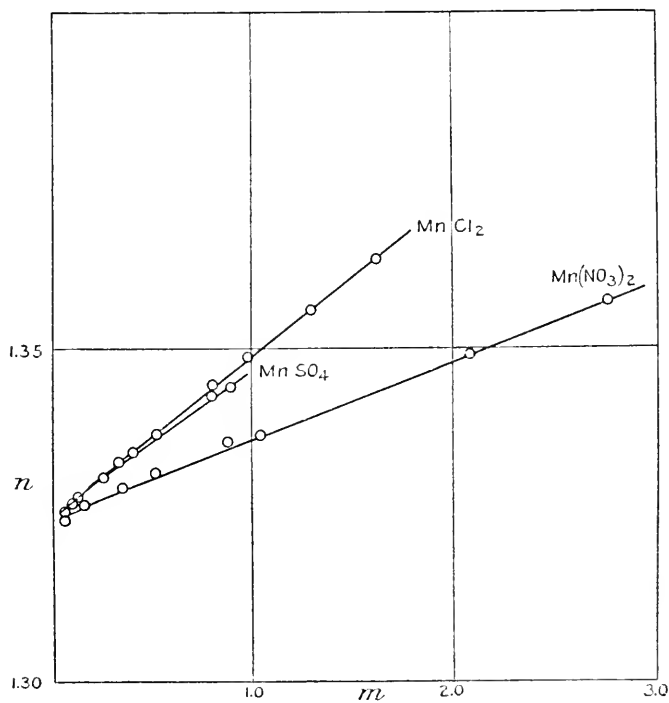

FIG. 33.

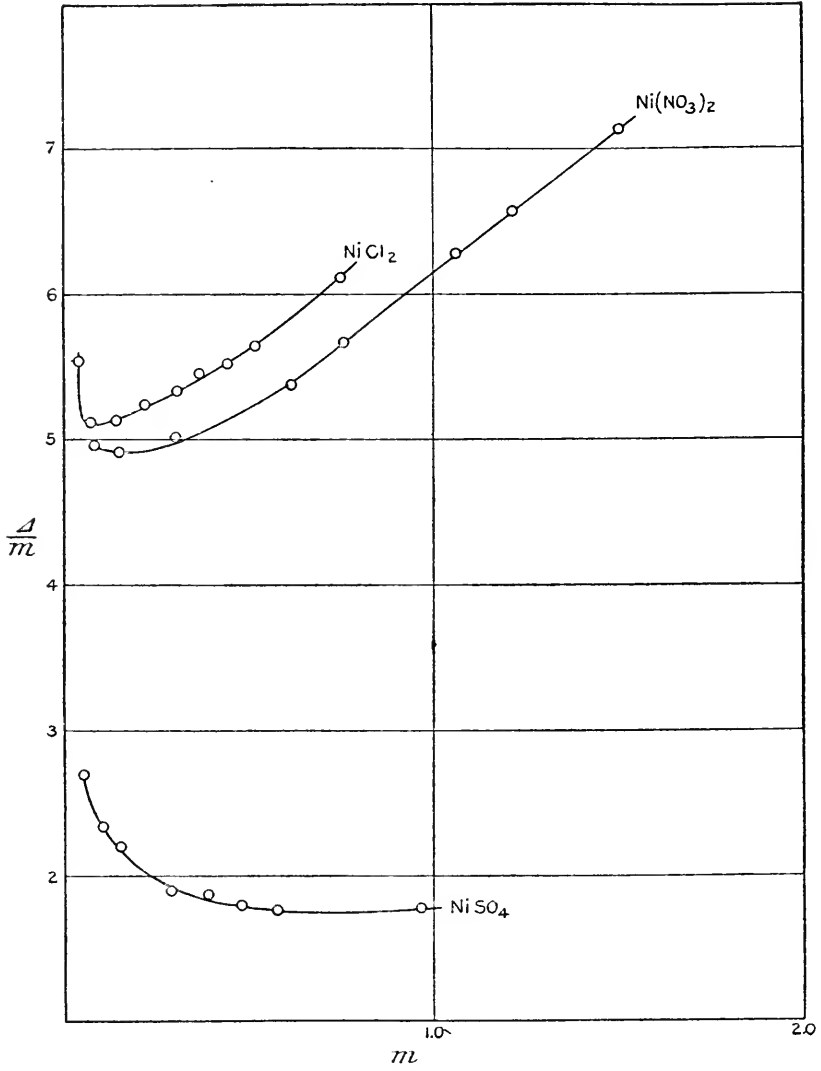

FIG. 34.

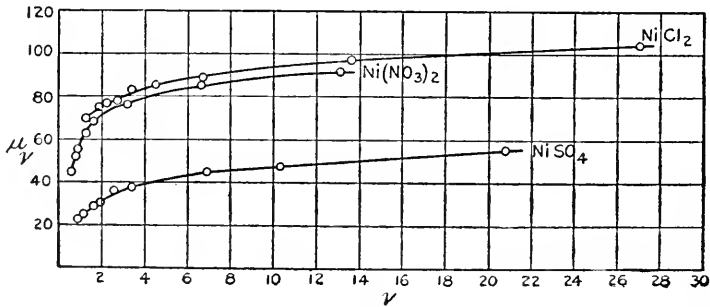

FIG. 35.

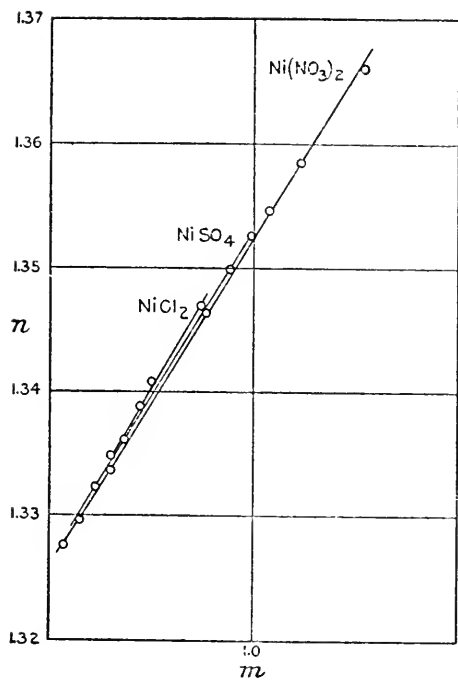

FIG. 36.

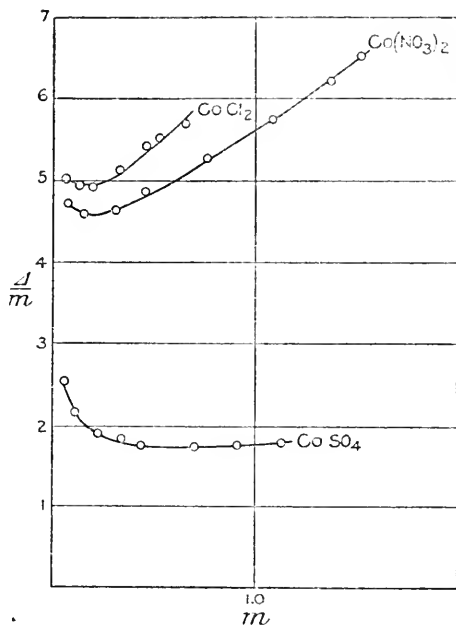

FIG. 37.

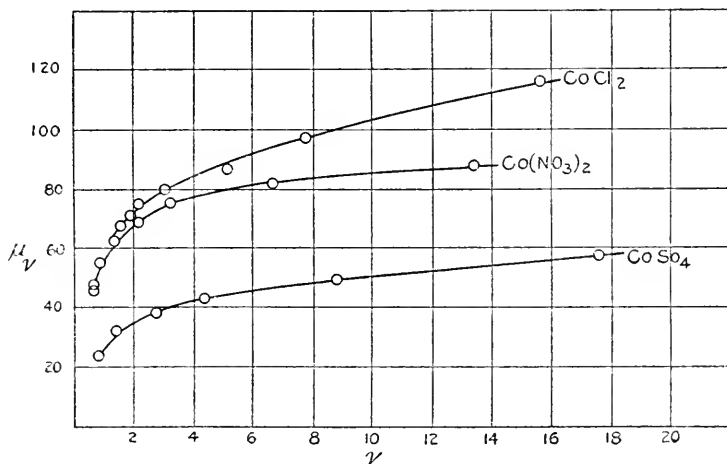

FIG. 38.

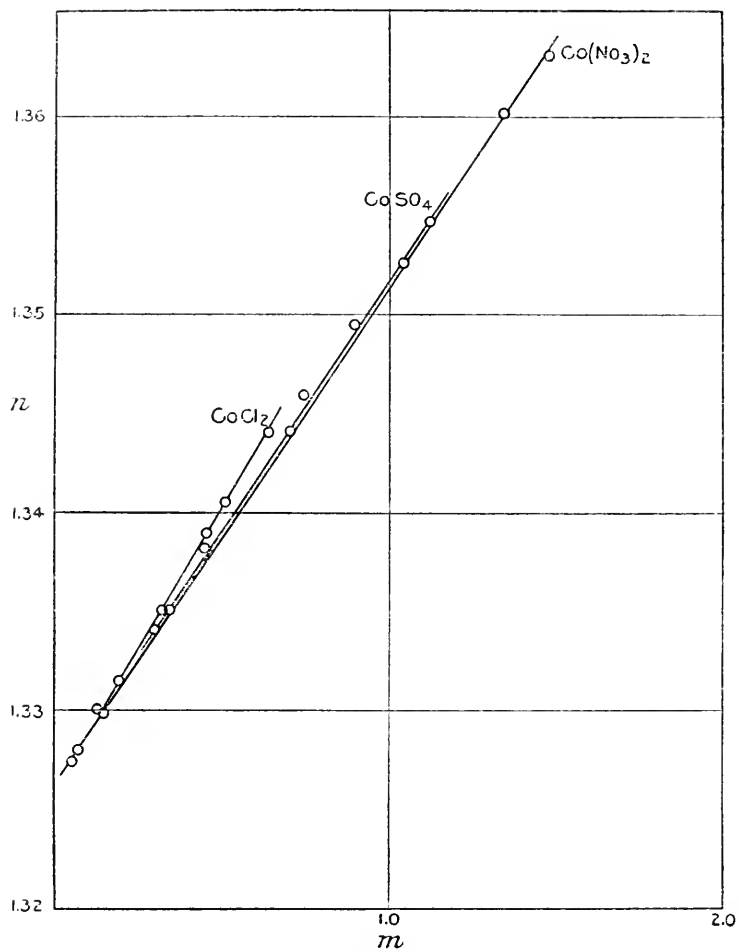

FIG. 39.

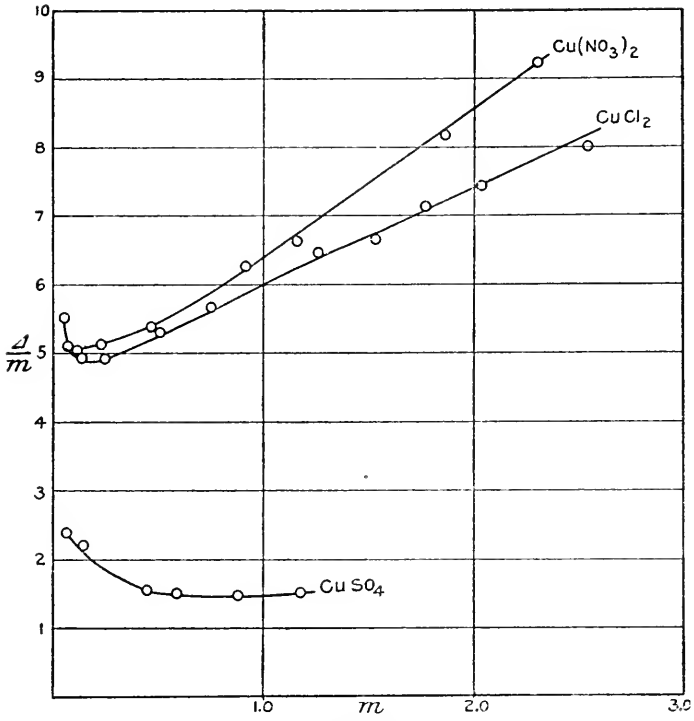

FIG. 40.

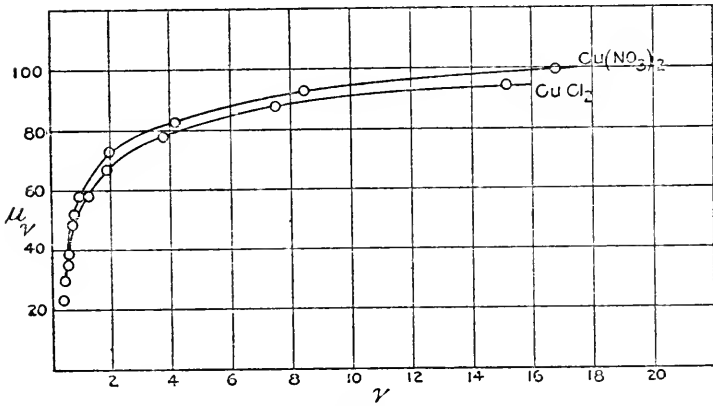

FIG. 41.

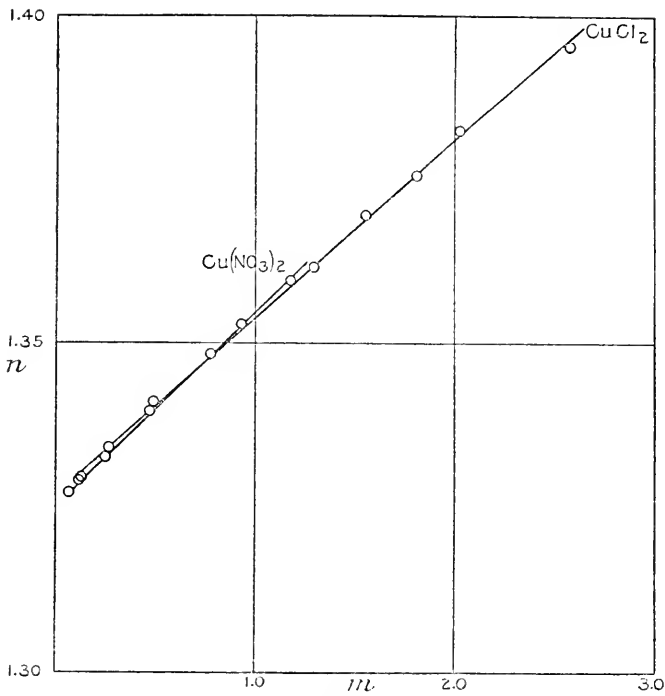

FIG. 42.

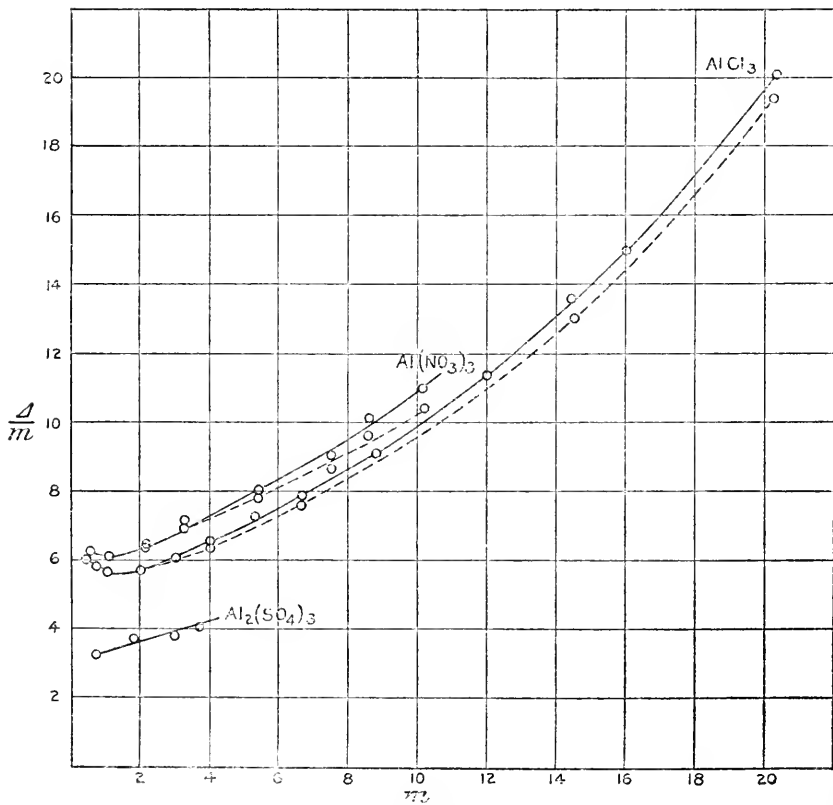

FIG. 43.



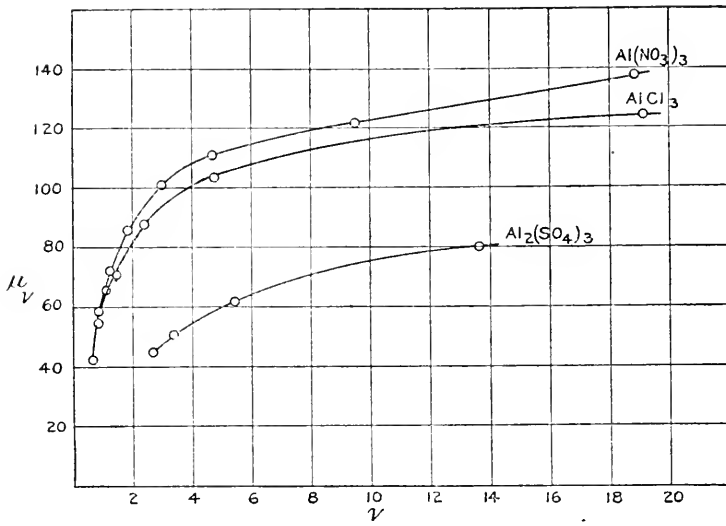

FIG. 44.

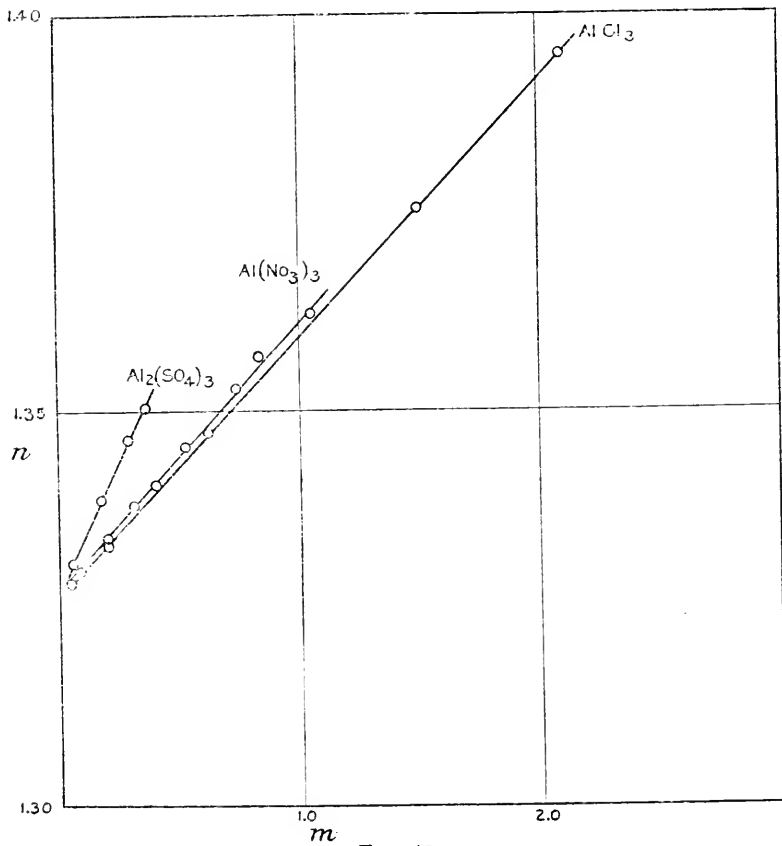

FIG. 45.

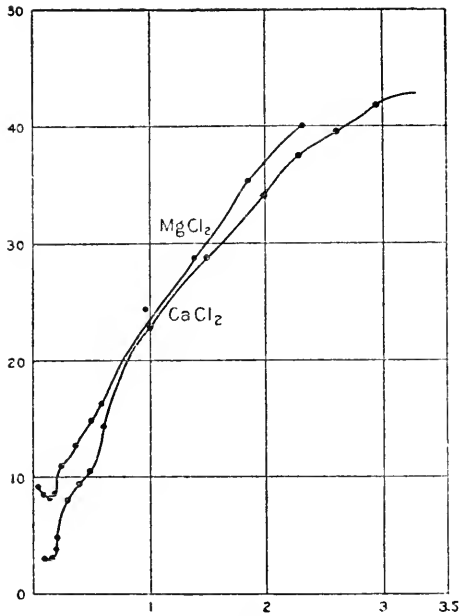

FIG. 46.

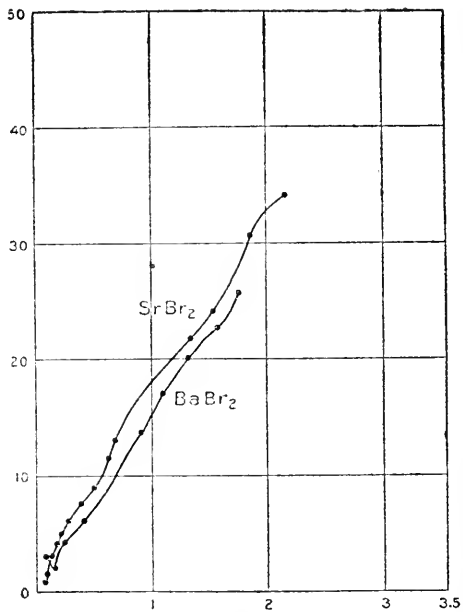

FIG. 47.

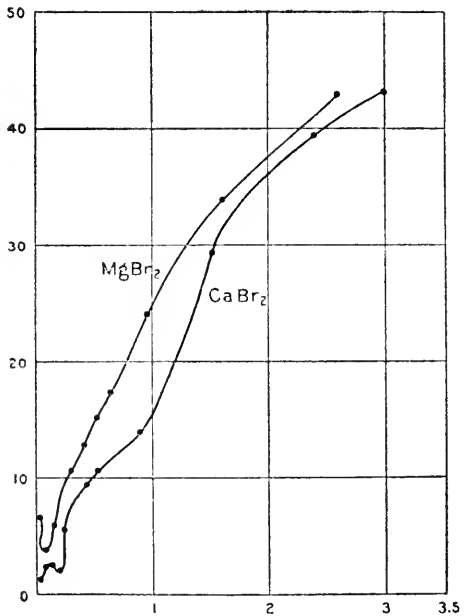

FIG. 48.

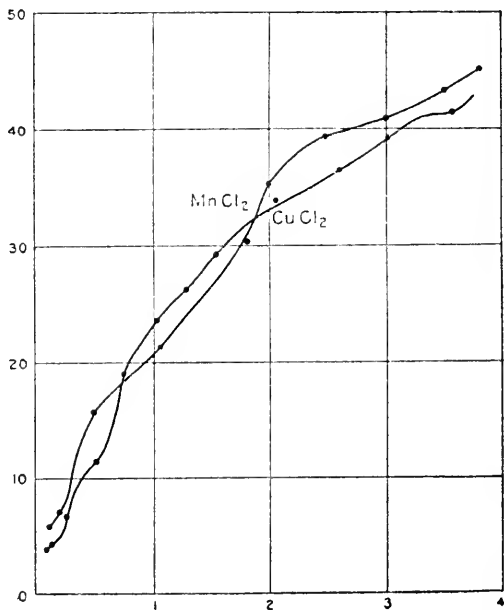

FIG. 49.

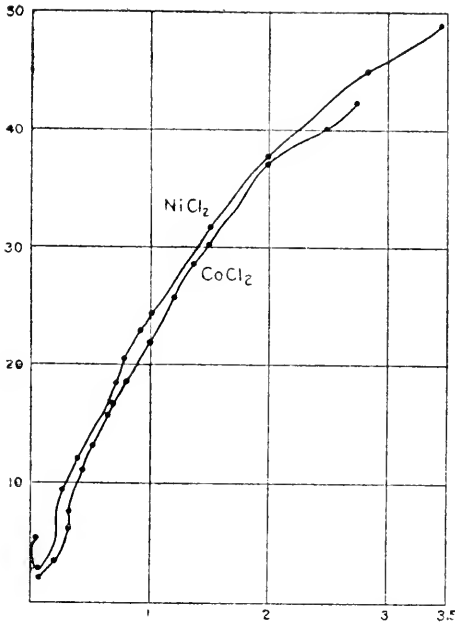

FIG. 50.

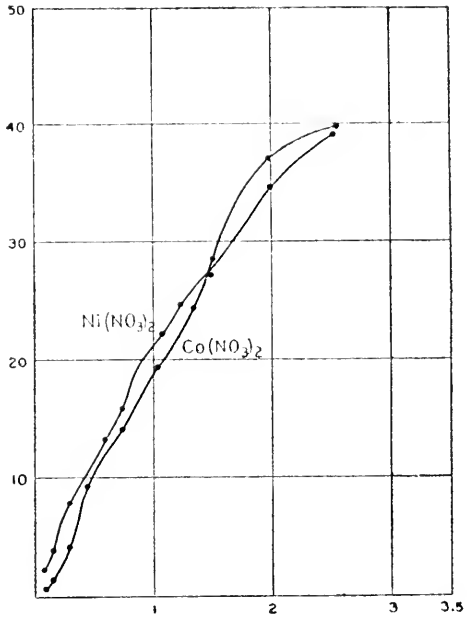

FIG. 51.

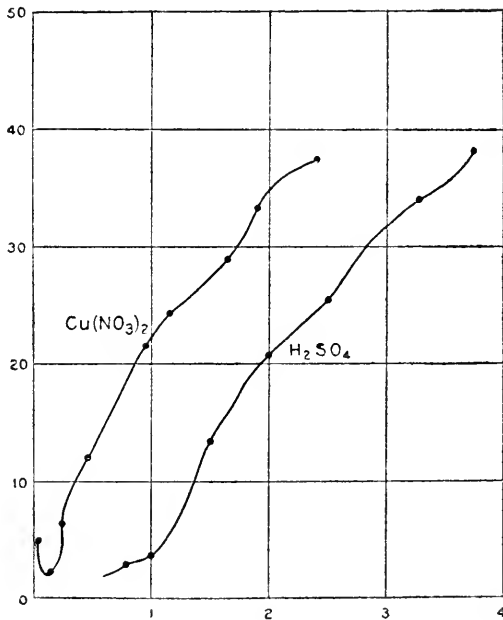

FIG. 52.

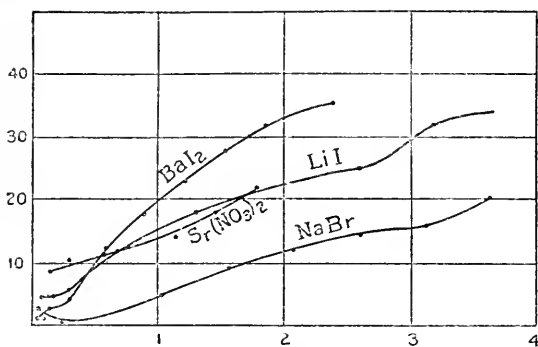

FIG. 53.

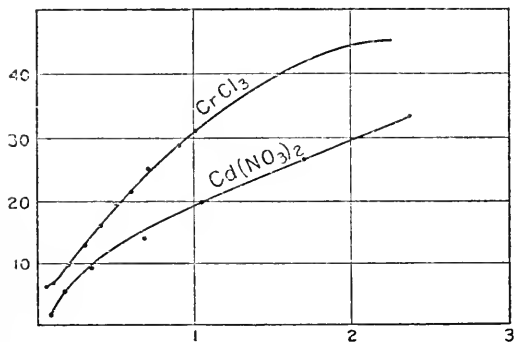

FIG. 54.

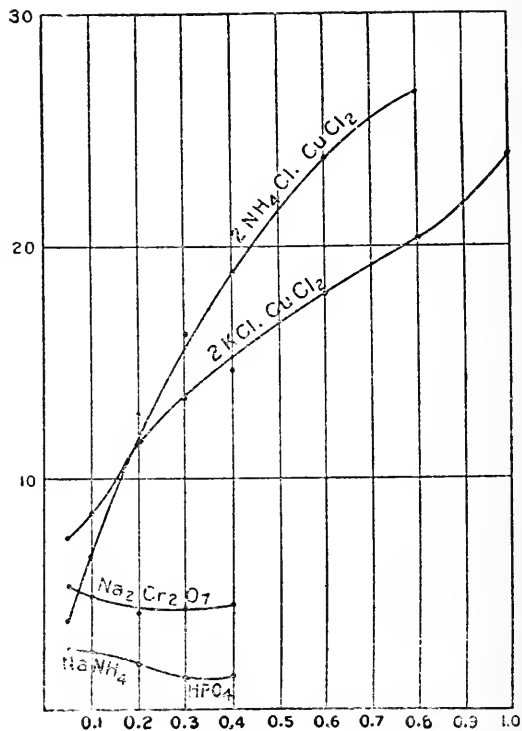

FIG. 55.

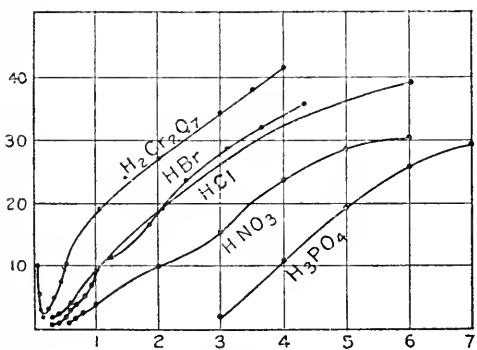

FIG. 56.

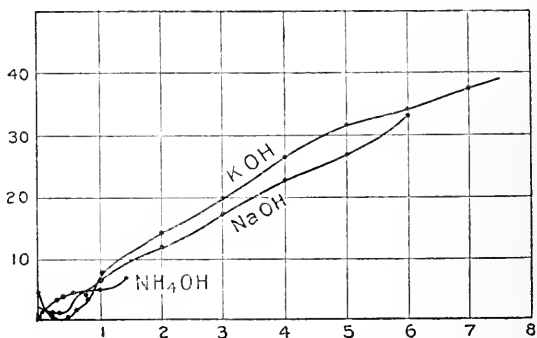

FIG. 57.

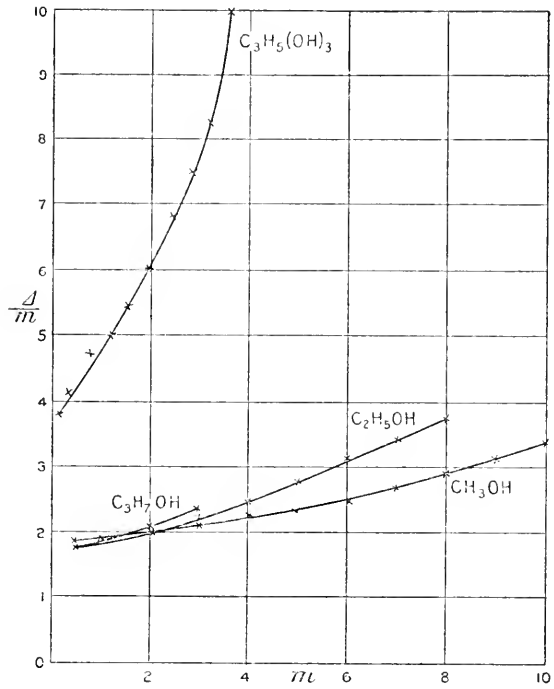

FIG. 58.

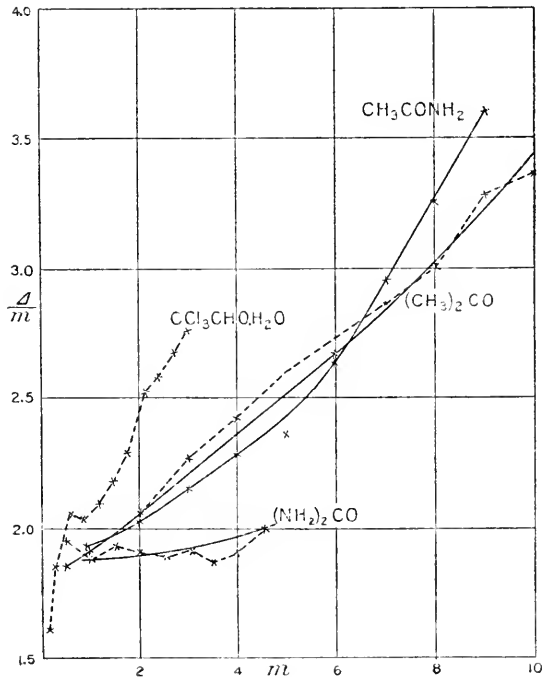

FIG. 59.

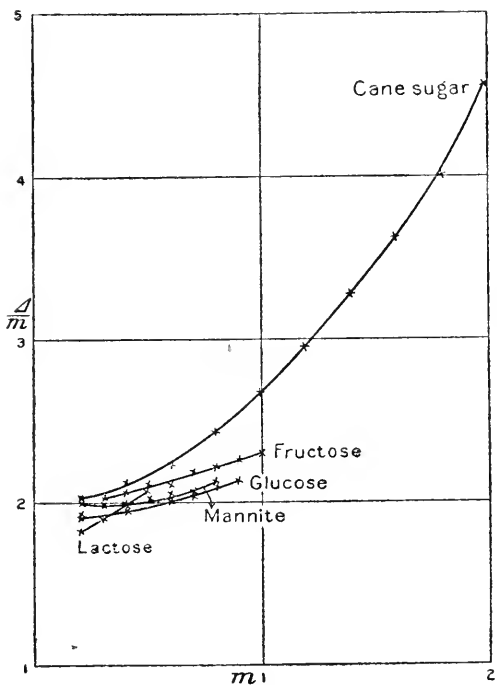

FIG. 60.

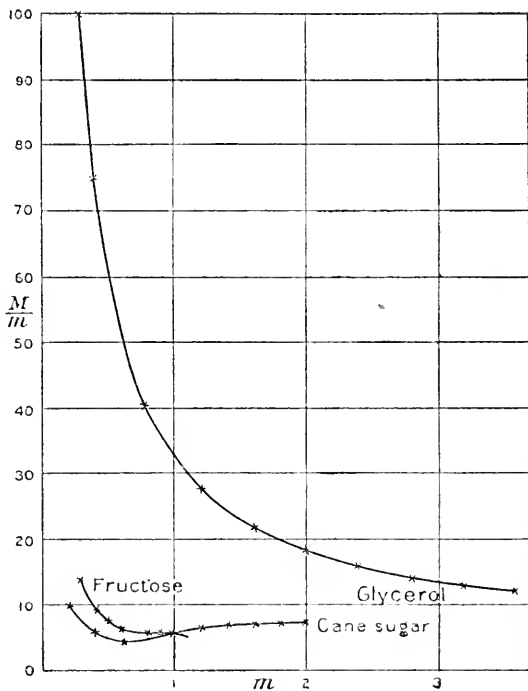

FIG. 61.

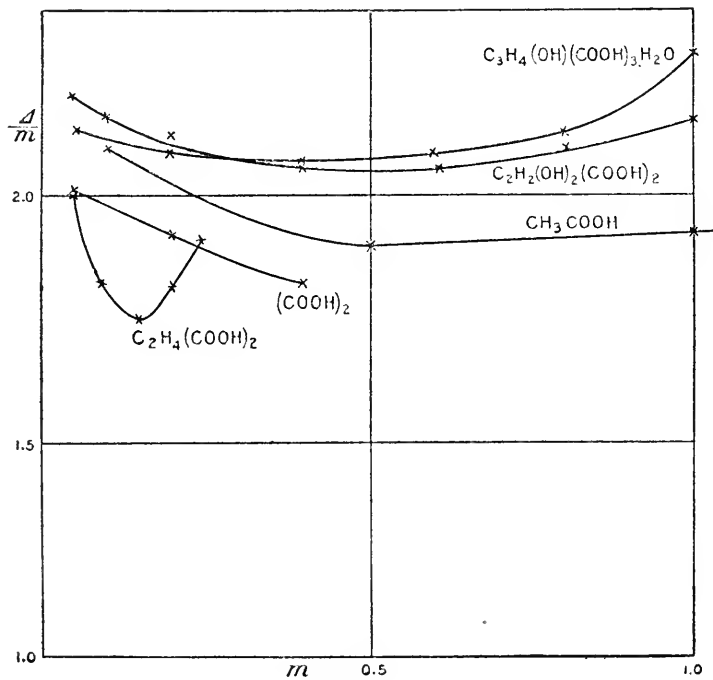

FIG. 62.

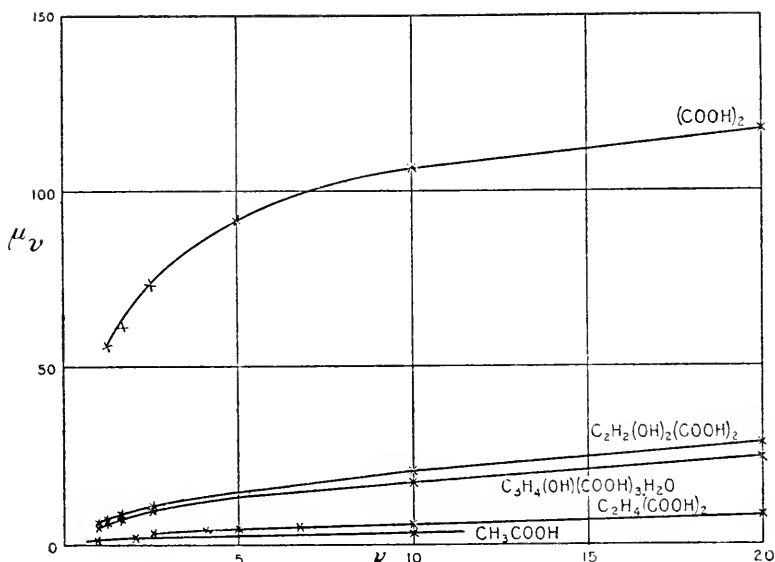

FIG. 63.

## DISCUSSION OF THE RESULTS.

Ninety-eight compounds have been studied in this investigation, and about 1,500 solutions. Most of the results obtained are given in the above tables, and some of these have been plotted in curves. We shall now take up certain of these results and examine them in some detail.

The *salts of lithium* (tables 2 to 5) give comparatively large lowering of the freezing-point of water for binary electrolytes, and, therefore, show considerable hydration. This is in keeping with the relation between water of crystallization and lowering of the freezing-point. Lithium salts crystallize with water, while the salts of sodium and potassium, in general, do not.

The freezing-point lowerings produced by salts of lithium are plotted as curves in figs. 3, 4, 11, 14, 15, 16, 17, and 19. Conductivity results are plotted in figs. 7, 8, and 20, refractivities in fig. 12, and hydrates in fig. 53.

The *total amount of water held in combination by the dissolved substance increases with the concentration of the solution, from the most dilute to the most concentrated solution studied.* This relation, as we shall see, holds for all of the substances that are capable of combining with water. It is, indeed, a necessary consequence of the law of mass action.

The *composition of the hydrates, i. e., the amount of water combined with one molecule of the dissolved substance or the ions formed from it, increases with the dilution of the solution.* This relation also is a fairly general one for salts. Certain irregularities appear, but these are probably to be attributed to the accumulation of experimental errors.

The *salts of sodium* in general do not crystallize with water, and, therefore, show comparatively little hydrating power in aqueous solution. The results are recorded in tables 6 to 17.

The freezing-point lowerings produced by sodium salts are plotted in figs. 3, 4, 5, 6, 11, 14, 15, 16, 17, and 19; the conductivity results in figs. 7, 8, 9, 10, and 20, while the refractivities are given in figs. 12 and 13. The hydrates formed by sodium bromide are plotted in fig. 53; those formed by sodium dichromate and sodium ammonium acid phosphate in fig. 55, while the hydrates formed by sodium hydroxide are plotted in fig. 57.

Sodium chloride crystallizes at ordinary temperatures without water, and has very little power to combine with it in aqueous solution. Sodium bromide and iodide crystallize with water of crystallization, and have considerable power to form hydrates in solution. Sodium sulphate crystallizes with water, but, like the sulphates in general, shows abnormal results, due to the fact that they undergo polymerization in solution.

Sodium chromate shows very slight hydrating power in the most concentrated solutions, while sodium dichromate shows very appreciable hydrating power at all of the dilutions investigated. The chromates, like the sulphates, give abnormal results, and probably for the same reason—they undergo polymerization in aqueous solution. Disodium phosphate is especially interesting, in that it is the only salt thus far studied which crystallizes with 12 molecules of water. It is unfortunate that the salt is so slightly soluble in water, since this limited the work to only a very few dilutions, and prevented us from studying any solution of appreciable concentration. For the solutions with which we could work, this salt showed the greatest hydrating power of any substance brought within the scope of this investigation. This is in perfect accord with the relation between water of crystallization and lowering of the freezing-point.

Sodium hydroxide also has considerable power to combine with water. This, however, passes through a minimum.

The results with *salts of potassium* are given in tables 18 to 28.

They resemble the results obtained with the corresponding salts of sodium. Salts of potassium, in general, crystallize without water, and have very little power to combine with it in solution.

Some of the freezing-point data for potassium salts are plotted as curves in figs. 3, 4, 5, 6, 14, 15, 16, 17, and 19. The conductivity data are given in figs. 7, 8, 9, 10, and 20; some of the refractivities are plotted as curves in figs. 12 and 13, while the hydrates formed by potassium hydroxide are plotted in fig. 57.

The results with potassium ferricyanide and potassium ferrocyanide are especially interesting, in that they throw an entirely new light on the way in which these substances dissociate in the presence of water. The older views



as to the way in which these substances break down into ions are not in accord with the facts. As these matters have already been discussed at sufficient length they need only be referred to in the present connection.

Potassium hydroxide, like sodium hydroxide, shows considerable power to form hydrates. As with sodium hydroxide, the composition of the hydrates passes through a minimum. These hydroxides have considerable power to crystallize with water at low temperatures.

The double chloride of potassium and copper has great power to combine with water in aqueous solutions. This salt, like the other double halides, as was shown by Jones and Knight,\* breaks down in the presence of water, for the most part, into the constituent chlorides. The hydrating power of the above double chloride is essentially the hydrating power of copper chloride, which will be discussed a little later.

The *salts of ammonium* resemble the salts of sodium and potassium, in that they crystallize without water, and have very small power to combine with it in aqueous solution. (See tables 29 to 33.)

The freezing-point data are plotted in curves, figs. 3, 4, 5, 14, and 17, the conductivity data in figs. 7, 8, and 9, the refractivities in figs. 12 and 13, and the hydrates of ammonium copper chloride in fig. 55, and of ammonium hydroxide in fig. 57.

The same remarks apply to the double chloride of ammonium and copper, that were made concerning the double chloride of potassium and copper. The large hydrating power of both of these salts is due primarily to the copper chloride, which is formed as the result of the action of water on these double halides.

Ammonium hydroxide, like the hydroxide of sodium and potassium, shows very considerable power to combine with water in aqueous solution.

The *salts of calcium*, that were brought within the scope of this work, all crystallize with comparatively large amounts of water, and all of them have large hydrating powers. The results are given in tables 34 to 37, and the freezing-point data plotted as curves in figs. 3, 14, 15, 17, 19, 21, and 28. The conductivity data are plotted in figs. 7, 22, and 29, the refractivities in fig. 23, and the hydrates in figs. 46 and 48. The hydrates formed by calcium chloride, bromide, and iodide increase in complexity with the dilution of the solution. This is shown, with very few irregularities, especially by calcium chloride. The hydrating power of these three substances is of the same order of magnitude, as would be expected from their power to combine with water as water of crystallization.

Calcium nitrate crystallizes with only four molecules of water, and has less hydrating power than the halides of calcium, just as would be expected.

The *salts of strontium* resemble in their water of crystallization, and in their hydrating power, the corresponding salts of calcium.

\* Amer. Chem. Journ., 22, 110 (1899).

The results are given in tables 38 to 41. The freezing-point lowerings are plotted in figs. 3, 14, 15, 16, and 19, the conductivities in figs. 7 and 22, the refractivities in fig. 23, and the hydrates in figs. 47 and 53.

The same remarks that were made in connection with the salts of calcium hold almost exactly in the case of the strontium salts.

The *salts of barium* differ from the salts of calcium and strontium, in that they crystallize with a smaller number of molecules of water of crystallization. They give a smaller lowering of the freezing-point of water (see tables 42 to 44), as is seen from the curves, figs. 14, 15, and 16.

The *salts of magnesium* have been studied pretty thoroughly, and gave very satisfactory results. These results are given in tables 45 to 48. The freezing-point lowerings are plotted in figs. 14, 15, and 24, the conductivities in fig. 25, and the hydrates in figs. 46 and 48.

The halides of magnesium and the nitrate crystallize, each with six molecules of water, and all have large hydrating powers. The complexity of the hydrates increases, with a fair degree of regularity, from the most concentrated to the most dilute solution. The hydrating power of all of these salts is of the same order of magnitude, as would be expected, since they have the same power to hold water when out of solution as water of crystallization. This is seen especially in the more concentrated solutions, where the experimental errors are relatively small.

Magnesium sulphate, like all the other sulphates studied, gives abnormal results. It appears to form no hydrates in aqueous solution, notwithstanding the fact that it crystallizes with seven molecules of water of crystallization. It is almost certain that this substance has considerable hydrating power, but this is masked in our results by the large amount of polymerization which the sulphates undergo.

The hydrating power of only one *salt of zinc* was worked out. The halogen compounds of zinc were too unstable in the presence of water to enable us to work satisfactorily with them. The chloride of zinc showed freezing-point lowerings that were in keeping with its water of crystallization. The nitrate has the hydrating power that would be expected from its water of crystallization. The same remarks can be made in reference to the sulphate of zinc, that have been made in connection with the other sulphates studied.

The *salts of cadmium* present a number of features of special interest. In the first place the halogen salts of cadmium either crystallize with a small amount of water, like the chloride, or with none at all, like the bromide and iodide. We should, therefore, expect that these substances would give comparatively small lowering of the freezing-point of water, and show little or no hydrating power when in aqueous solution. The results given in tables 52 to 54 confirm these expectations. The freezing-point lowerings are plotted

in figs. 15, 16, 17, and 26, the conductivities in fig. 27, the refractivities in fig. 30, and the hydrates formed by cadmium nitrate in fig. 54.

None of the halogen salts of cadmium has any appreciable hydrating power. It will be recalled in this connection that the halogen salts of cadmium give, in general, abnormal results in aqueous solution. They have abnormally small conducting power for the electric current; not as small as the corresponding salts of mercury, but much smaller than those of zinc, which in turn have much less conductivity than the halides of metals of the calcium magnesium group.

In the light of this abnormal behavior of the halogen compounds of cadmium, it is not surprising that the chloride has such small hydrating power, notwithstanding the fact that it can crystallize with two molecules of water.

The nitrate of cadmium shows very considerable hydrating power, as would be expected from its water of crystallization.

The sulphate of cadmium conducts itself in a manner analogous to the other sulphates already studied.

The *chloride, nitrate, and sulphate of manganese* were studied. The results are recorded in tables 55 to 57. The freezing-point data are plotted in curves, fig. 31, the conductivities in fig. 32, the refractivities in fig. 33, and the hydrates in fig. 49.

The results are perfectly normal in terms of the conceptions that we have earlier developed. The hydrating power of the chloride and nitrate is what would be expected from their water of crystallization, and the behavior of the sulphate is strictly analogous to the other sulphates already studied.

The *chloride, nitrate, and sulphate of nickel* were brought within the scope of this investigation. The results that were obtained are given in tables 58 to 60. The freezing-point lowerings are plotted as curves in fig. 34, the conductivities in fig. 35, the refractivities in fig. 36, and hydrates in figs. 50 and 51.

The hydrates formed by nickel chloride and nitrate are complex, as would be anticipated from their water of crystallization. The complexity increases with fair regularity from the most concentrated to the most dilute solutions.

The results for the *cobalt salts* are strictly analogous to those for the salts of nickel. They are given in tables 61 to 63. The freezing-point lowerings are plotted as curves in fig. 37, the conductivities in fig. 38, the refractivities in fig. 39, and the hydrates in figs. 50 and 51.

Since the results with the salts of cobalt are so closely analogous to those with the salts of nickel, it is not necessary to discuss them in any detail.

The *chloride, nitrate, and sulphate of copper* were used. The results are given in tables 64 to 66. The freezing-point lowerings are plotted in fig. 40, the conductivities in fig. 41, and the refractivities in fig. 42. The hydrates formed by copper chloride and copper nitrate are plotted as curves in figs. 49 and 52, respectively.

The hydrates formed by copper chloride and copper nitrate become more and more complex the more dilute the solution. The change is very regular, except for the most dilute solution of copper nitrate, where the experimental errors are necessarily large.

Copper sulphate gives very small lowering of the freezing-point of water, as would be expected.

The *chloride, nitrate, and sulphate of aluminium* have been studied, and the results recorded in tables 67 to 69. The freezing-point data are given in figs. 14, 17, and 43, the conductivity data in fig. 44, and the refractivities in fig. 45.

Aluminium chloride and nitrate are especially interesting in the present connection, in that they are the first quaternary electrolytes that were studied. The molecules of these substances dissociate, yielding four ions each. Further, they each crystallize with a large amount of water, and we should, therefore, expect a large hydrating power. An examination of the results will show that this is the case.

Aluminium sulphate, like the sulphates in general, gives comparatively small lowering of the freezing-point of water.

The *chloride and nitrate of chromium* have also been studied as other examples of quaternary electrolytes. The results are given in tables 70 to 71. The data are plotted in figs. 17, 28, 29, and 54.

Chromium chloride forms a series of hydrates containing large amounts of water, and increasing in complexity regularly from the most concentrated to the most dilute solution. The curve expressing the relation between concentration of the solution and the amount of water held in combination, is one of the most regular that was obtained for any substance.

The results for the more dilute solutions of chromium nitrate are unexpected. We propose to study further these solutions. Hydrolysis doubtless plays here a prominent rôle.

The *chloride and nitrate of iron* were studied as other examples of quaternary electrolytes. The results are given in tables 72 and 73 and plotted in curves, figs. 14, 17, 28, 29, and 30.

On account of the great hydrolysis which ferric chloride undergoes, and the large time factor in its conductivity, the conductivity measurements were not made with this substance. It was, therefore, impossible to calculate even the approximate composition of the hydrates formed by ferric chloride. The large magnitude of the freezing-point lowerings, however, shows that ferric chloride has great hydrating power.

The conductivities of ferric nitrate were measured, and the approximate composition of the hydrates formed by it calculated.

A number of *strong mineral acids* were brought within the scope of this investigation. They are *hydrochloric, hydrobromic, nitric, sulphuric, chromic, and phosphoric acids*.

The results are given in tables 74 to 80. The freezing-point lowerings are plotted in figs. 3, 4, 5, and 6, the conductivities in figs. 7, 8, 9, and 10, the refractivities in fig. 13, and the hydrates in figs. 52 and 56.

The strong mineral acids all show some hydrating power, but, with the exception of chromic acid, this is limited to the more concentrated solutions. Hydrochloric, hydrobromic, nitric, sulphuric, and phosphoric acids show no hydrates in the more dilute solutions that were studied. Further, the complexity of the hydrate passes through a maximum for a number of the acids, at a concentration ranging from normal to about three times normal.

These results are so fundamentally different from those that were obtained with salts, and even with bases, that it raises the question as to what they mean. Why this difference between acids and other electrolytes?

A possible explanation of this phenomenon, which is in keeping with the law of mass action, is the following: If the attraction of the dissolved molecule for water is slight, then, when a certain dilution is reached, the effect of the presence of more water might actually diminish the amount of water combined with a molecule of the dissolved substance. When the number of molecules of water had become sufficiently great, their attractions for one another would summate, and might overcome, in part, the attraction of the dissolved substance for the water. *In this case the complexity of the hydrate would pass through a maximum and then decrease with further dilution.*

A number of *neutral organic compounds* have also been investigated, to see whether these substances have any power to combine with water. The compounds studied are: *Methyl alcohol, ethyl alcohol, n-propyl alcohol, acetone, acetamide, urea, chloral hydrate, glycerol, glucose, fructose, mannite, lactose, and cane-sugar.*

The results are given in tables 81 to 93. The freezing-point data are plotted in curves, figs. 58, 59, and 60, and the hydrates formed by fructose, cane-sugar, and glycerol in fig. 61.

Of the thirteen non-electrolytes studied in this investigation only glycerol showed any marked hydration or power to combine with the solvent. Glycerol combines with water to about the same extent as the ternary, or even some of the quaternary electrolytes.

Cane-sugar and fructose also show considerable power to combine with water, but this is not even of the same order of magnitude as that shown by glycerol.

Methyl and ethyl alcohols also show some slight power to combine with water in solution.

A number of the non-electrolytes studied show a marked tendency to undergo polymerization in the presence of water.

Glycerol has much the greatest hydrating power of any non-electrolyte investigated, and cane-sugar also shows this power to an appreciable extent.

The total amount of water combined with the dissolved substance, in both cases, increases with the concentration, as we should expect. The number of molecules of water combined with one molecule of the dissolved substance, in the case of glycerol, increases with a fair degree of regularity, with the dilution of the solution.

A number of *organic acids* were also studied. These include *acetic*, *oxalic*, *succinic*, *tartaric*, and *citric* acids. The results are recorded in tables 94 to 98 and the conductivity data plotted in curves, fig. 63. None of the organic acids studied in this investigation show any appreciable tendency to combine with water in solution. Some exhibit a marked tendency to undergo polymerization in aqueous solution.

#### GENERAL RELATIONS.

It must be remembered that the problem of calculating even the approximate composition of the hydrates existing in solution is difficult. Some of these difficulties have already been mentioned. Certain assumptions must be made that are only approximately true. This is the case especially with the law of Raoult, which probably does not hold rigidly for concentrated solutions. Further, it has already been pointed out that the conductivity method is only a rough measure of dissociation in concentrated solutions. Taking all of the difficulties into account, we are still of the opinion that we can get a fairly good idea as to the composition of the hydrates formed by the various electrolytes, in aqueous solutions of different concentrations.

An examination of the results recorded in this monograph will show that the amount of water held in combination by the dissolved substance increases as the concentration of the solution increases. This is, of course, what would be expected in terms of mass action.

The number of molecules of water in combination with one molecule of the dissolved substance, frequently increases from the most concentrated to the most dilute solution, as with magnesium chloride and bromide, manganese chloride, nickel chloride, and copper chloride.

With some substances the number of molecules of water held in combination by one molecule of the dissolved substance may pass through a well-defined maximum as the dilution is increased. In other cases, the number of molecules of water held in combination by one molecule of the dissolved substance may reach a maximum value as the dilution is increased; this maximum value may then remain practically constant with further increase in the dilution. Examples of all of these conditions are to be found in the substances discussed in this monograph.

An examination of the curves, figs. 46 to 52, will show that they are all of the same general type. These express the relation between the total amount of water in combination, and the concentration of the solution. This resemblance in type is what we should expect, because the total amount

of water held in combination by the dissolved substance is undoubtedly subject to the law of mass action.

#### NATURE OF THE COMPOUNDS FORMED.

The question arises whether these hydrates are true chemical compounds, as that term is ordinarily used, or whether they represent some less stable form of combination. That they are unstable is shown by the ease with which they are broken down by heat. Most of the water can be driven off, from the above solutions, at a temperature only a little above 100°. The more complex hydrates are, then, decomposed in solution at a comparatively low temperature and the water given off in the form of vapor. In the light of these facts the hydrates can scarcely be regarded as true chemical compounds. If, however, we insist on calling them chemical compounds, we must admit that they represent a very low order of stability.

#### DO IONS OR MOLECULES FORM HYDRATES?

We are of the opinion that both the molecules and ions combine with water, forming hydrates. It seems that the molecules are certainly capable of forming hydrates, because, in very concentrated solutions where the molecules are present in large quantities, we often have considerable hydration; and, further, Jones and Getman\* have shown that certain non-electrolytes, such as glycerol, cane-sugar, fructose, etc., which are undissociated, still have the power of combining with water in solution, forming hydrates of even a high order of complexity.

That *ions are capable of combining with water in solution* is shown by the magnitude of the hydration in many of the dilute solutions, where chiefly ions and only a few molecules are present.

Attention should be called to the fact, that in the preceding tables the number of molecules of water in combination with one molecule of the dissolved substance is calculated for a molecule of the dissolved substance. If this molecule is dissociated into 2, 3, or 4 ions, the number given in column H in the tables would have to be divided by 2, 3, or 4, in order to ascertain how many molecules of water are in combination with an ion resulting from the dissociation of the molecule in question.

#### THE OLD AND THE NEW HYDRATE THEORY.

The theory of hydrates in aqueous solution, which we believe is established by this work, is to be sharply distinguished from the old hydrate theory of Mendeléeff, which, having long since been shown to be untenable, has been abandoned. According to the older theory, when a substance like calcium chloride is dissolved in water, there are formed certain definite chemical compounds, having perfectly definite compositions and containing

\* Amer. Chem. Journ., 32, 308 (1904).

very different amounts of water, *e. g.*,  $\text{H}_2\text{SO}_4 \cdot \text{H}_2\text{O}$ ;  $\text{H}_2\text{SO}_4 \cdot 2\text{H}_2\text{O}$ ;  $\text{H}_2\text{SO}_4 \cdot 6\text{H}_2\text{O}$ ;  $\text{H}_2\text{SO}_4 \cdot 150\text{H}_2\text{O}$ . These hydrates and no intermediate ones exist.

According to the present theory, a compound such as calcium chloride *can form all the possible hydrates with water, from one or a few molecules of water up to at least 30 molecules*. The composition of the hydrate is conditioned by the concentration of the solution, temperature being constant.

It is possible, indeed quite probable, that several hydrates having different compositions exist simultaneously in every solution. We can not, of course, distinguish between this possibility and the simpler one—that at any given concentration only one hydrate, with a perfectly definite composition, exists.

#### SUMMARY AND CONCLUSIONS.

A brief summary of the relations established, and the conclusions reached as the result of this part of the work, is given below.

1. This investigation has already been extended to 98 compounds, including salts, acids, and bases, and between 1,400 and 1,500 solutions have been studied.

2. The freezing-points, the conductivities at  $0^\circ$ , and the specific gravities of all the solutions have been measured, and the refractivities of a large number of them.

3. Three lines of evidence bearing upon the hydrate theory have already been deduced, and all of these point to its general correctness. These are: The relative positions of the minima in the freezing-point and in the boiling-point curves; the relation between water of crystallization and lowering of the freezing-point; and the effect of temperature of crystallization on the amount of water of crystallization.

4. The approximate composition of the hydrates formed by a fairly large number of electrolytes and some non-electrolytes has been calculated. Those substances that crystallize without water have little or no hydrating power. In general, the larger the number of molecules of water of crystallization the greater the hydrating power of the salt.

5. The total amount of water in combination with the dissolved substance increases with the concentration of the solution. The number of molecules of water in combination with one molecule of the dissolved substance usually increases with the dilution of the solution.

6. In some cases, as with the more common acids, the amount of water in combination with one molecule of the dissolved substance passes through a maximum as the dilution is increased. A possible explanation of this fact has been suggested.

7. A number of organic compounds have been studied, but only a few of these have been found to have any marked hydrating power.



8. It has been pointed out that the hydrates formed in aqueous solutions are unstable, especially at higher temperatures. They are, in general, broken down at the boiling-points of the solutions, all of the water escaping except that which is held in combination by the salt as water of crystallization.

9. As the result of this work as a whole, we must conclude that both molecules and ions have the power to combine with water in aqueous solutions and form hydrates.

10. The new hydrate theory differs fundamentally from the old, in that, according to the former, we have a series of hydrates formed by the dissolved substance, having all possible compositions up to a given maximum--the composition depending on the concentration, as we should expect from the law of mass action.

11. The bearing of this work on the general theory of solutions is obvious. The fact that a part of the water is combined with the dissolved substance and is not acting as solvent, must be taken into account in dealing with all solutions and especially with concentrated ones. This accounts, in large part, for the abnormal behavior of concentrated solutions, and is, doubtless, an important factor in the apparent failure of the gas laws to apply to such solutions. When this is taken into account, together with such other factors as appear in Van der Waals's equation for gases, it will probably be shown that the gas laws apply to the osmotic pressures of concentrated solutions, measured under comparable conditions with gases, as well as to concentrated gases.



# THE FORMATION OF ALCOHOLATES BY CERTAIN SALTS IN SOLUTION IN METHYL AND ETHYL ALCOHOLS.

WORK OF McMASTER.

It has been shown by the work recorded in the earlier part of this monograph, that a large number of salts have the power to combine with water when dissolved in that solvent. Indeed, we have seen that this property is possessed by salts in general, although in very different degrees. Those salts that have the greatest power to combine with water as water of crystallization, have, as a rule, the greatest power to combine with water in aqueous solution.

Having established this fact in aqueous solutions, the question naturally arose, Do salts have the power to combine with any solvent other than water when dissolved in the solvent in question?

To throw light on this question some work was carried out by Jones and Getman,\* using ethyl alcohol as the solvent, and lithium chloride and nitrate and calcium nitrate as the dissolved substances. In still earlier work, Jones and Getman† used ethyl alcohol as the solvent, and potassium iodide, sodium iodide, ammonium iodide, cadmium iodide, and sodium bromide as the dissolved substances. The molecular rise of the boiling-point is not only greater than the theoretical rise at nearly all of the concentrations employed, taking into account, of course, the dissociation; but the molecular rise increases rapidly with the concentration of the solution. Thus, from 0.07 N to 2.07 N, the molecular rise of the boiling-point produced by lithium chloride increases, with a fair degree of regularity, from 1.28 to 2.43. As the concentration of the solution increases, the dissociation, of course, decreases, and this would tend to cause the molecular rise to decrease with increasing concentration. Notwithstanding this influence, we have just seen that the molecular rise increases rapidly with increase in the concentration of the solution. The results show, in general, that the molecular rise of the boiling-point of the solvent produced by the dissolved substance is greater than the theoretical molecular rise for ethyl alcohol, either as found by direct experiment in dilute solutions of non-electrolytes in the solvent in question, or as calculated from the equation

$$c = \frac{2T^2}{100L}.$$

In a number of the above cases very marked differences manifest themselves—differences that are far too large to be accounted for on the basis of the dissociation of the dissolved substance. Take the case of lithium

\*Amer. Chem. Journ., 32, 338 (1904). †*Ibid.*, 31, 338 (1904).

chloride in ethyl alcohol, as worked out by Jones and Getman.\* Since in the preparation of the solutions both solvent and dissolved substance were taken in weighed quantities, the question of the change in the specific gravity of the solutions does not come into play.

Jones and Getman† interpreted these results by the boiling-point method, in ethyl alcohol as the solvent, in the same manner that they had previously interpreted their results obtained by the freezing-point method in aqueous solutions. The abnormally great rise in the boiling-point of ethyl alcohol produced by certain salts, is due to combination between the dissolved substance and part of the solvent—to the formation of alcoholates in solution. The part of the alcohol that was in combination with the dissolved substance would thus be removed from the field of action as far as solvent is concerned. There being less alcohol present acting as solvent, the rise in the boiling-point produced by the dissolved substance would be, of course, greater than if all the alcohol was playing the rôle of solvent.

This suggestion accounts for the facts in the case of solutions in alcohol, just as the hydrate theory had explained the abnormally great lowering of the freezing-point of water produced by a large number of salts, especially when the concentrations were great.

The object of this part of the investigation is to extend the earlier work of Jones and Getman to a larger number of salts, and to more than one non-aqueous solvent. Jones and McMaster repeated the work with a few of the same substances in ethyl alcohol that were employed by Jones and Getman, and have added a number of substances to the list of those that were earlier studied. They worked with lithium chloride, lithium bromide, and lithium nitrate in methyl alcohol; and with lithium chloride, lithium bromide, lithium nitrate, and calcium nitrate in ethyl alcohol.

In making the boiling-point measurements, the boiling-point apparatus of Jones‡ was employed. In order to be independent of correction for changes in the barometer, two pieces of boiling-point apparatus were used. In one of these the pure solvent was boiled, and in the other the solution.

The alcohols used in this work were dehydrated by the usual methods, and precaution taken to keep them free from moisture when transferred to the boiling-point apparatus. The conductivity of the methyl alcohol, at 25°, was  $2 \times 10^{-6}$ , and that of the ethyl alcohol, from 1 to  $2 \times 10^{-6}$ . The salts were all completely freed from water. The usual precautions were taken in making the boiling-point measurements, and the proper correction applied for the solvent that existed in the apparatus in the form of vapor. The top of the condenser was closed by means of a tube filled with calcium

---

\* Amer. Chem. Journ., 32, 339 (1904). † *Ibid.*, 32, 342 (1904). ‡ *Ibid.*, 19, 581 (1897).

chloride, to prevent the moisture in the air from coming in contact with the alcohol in the boiling-point apparatus.

In the following tables  $m$  is the concentration in terms of gram-molecular normal. This was obtained by dividing the number of grams of salt in 1,000 grams of the solvent, by the molecular weight of the salt.  $\rho$  is the corrected rise in the boiling-point of the solvent produced by the dissolved substance, at the concentration in question, and  $\frac{\rho}{m}$  is the molecular rise in the boiling-point of the solvent at the given concentration.

The results for lithium chloride, bromide, and nitrate are given in table 99. Calcium nitrate in methyl alcohol could not be satisfactorily studied, on account of its limited solubility in this substance.

TABLE 99.—RESULTS WITH METHYL ALCOHOL.

Lithium chloride in methyl alcohol.			Lithium bromide in methyl alcohol.			Lithium nitrate in methyl alcohol.		
$m$	$\rho$	$\frac{\rho}{m}$	$m$	$\rho$	$\frac{\rho}{m}$	$m$	$\rho$	$\frac{\rho}{m}$
0.0453	0.061	1.34	0.0919	0.129	1.40	0.0961	0.120	1.24
0.1050	0.140	1.33	0.1409	0.192	1.36	0.1369	0.163	1.19
0.1377	0.181	1.31	0.1780	0.241	1.35	0.1437	0.171	1.19
0.2404	0.313	1.30	0.1970	0.270	1.36	0.1711	0.202	1.18
0.2598	0.340	1.31	0.2514	0.344	1.37	0.2089	0.248	1.18
0.2891	0.380	1.31	0.2557	0.351	1.37	0.2367	0.286	1.21
0.3188	0.424	1.33	0.2727	0.377	1.38	0.2830	0.354	1.25
0.3965	0.529	1.33	0.3101	0.412	1.33	0.3744	0.475	1.26
0.4557	0.610	1.34	0.3689	0.499	1.35	0.4454	0.568	1.27
0.4921	0.660	1.34	0.5554	0.756	1.36	0.4504	0.575	1.27
0.4964	0.670	1.35	0.6108	0.846	1.38	0.4709	0.607	1.28
0.5762	0.779	1.35	0.6182	0.858	1.38	0.5300	0.684	1.29
0.6919	0.973	1.40	0.6654	0.927	1.39	0.6122	0.792	1.29
0.7522	1.068	1.42	0.5882	0.808	1.37	0.7338	0.976	1.33
0.7717	1.100	1.42	0.6745	0.965	1.43	0.7538	1.004	1.33
0.7961	1.139	1.43	0.8571	1.287	1.50	0.8342	1.132	1.35
0.8635	1.250	1.44	1.2128	1.970	1.62	0.9212	1.265	1.37
0.9258	1.347	1.45				1.1320	1.563	1.38
1.0074	1.512	1.50						
1.1847	1.838	1.55						

The constant for methyl alcohol is 0.84. By comparing with this value the molecular rise found, we can see at once the magnitude of the discrepancy between the value obtained experimentally and the theoretical value for an undissociated substance. All three of the above salts are, of course, dissociated to a greater or less extent by methyl alcohol. This, however, would scarcely account for the magnitude of the molecular rise, even in the most dilute solutions, since the dissociating power of methyl alcohol is only from one-third to one-half that of water. Dissociation is entirely incapable of accounting for the *increase in the molecular rise with increase in the concen-*

*tration of the solution*, which we see from the results takes place in the case of all three of the above salts. The dissociation would decrease with increase in the concentration, which would tend to diminish the magnitude of the molecular rise of the boiling-point as the solutions became more and more concentrated.

Attention should also be called to the *magnitude of the molecular rise* in the most concentrated solutions employed. In such solutions it is almost *twice* the boiling-point constant, or normal molecular rise for this solvent. The dissociation in such solutions is certainly not greater than between 30 and 40 per cent.

We should interpret these results in terms of the same theory that was advanced by Jones\* in connection with aqueous solutions. There is combination between the solvent and the dissolved substance, forming in the case of water, *hydrates*; in the case of alcohol, *alcoholates* in solution. As the concentration of the solution becomes greater, more and more alcohol is held in combination by the dissolved substance; consequently, there is less and less alcohol acting as solvent, and the molecular rise in the boiling-point therefore increases.

#### RESULTS WITH ETHYL ALCOHOL.

The results in ethyl alcohol, obtained with lithium chloride, lithium bromide, lithium nitrate, and calcium nitrate, are given in table 100 (page 151).

Jones and McMaster obtained results of the same general character as those found by Jones and Getman for the substances with which they worked in ethyl alcohol. The constant for ethyl alcohol is 1.15. If we examine the results for lithium chloride, bromide, and nitrate, we shall find the molecular rise in the boiling-point, especially in the more concentrated solutions, to be much greater than this value. Further, the molecular rise increases with the concentration of the solutions. The results in the more dilute solutions in ethyl alcohol might be partially explained on the basis of dissociation, since ethyl alcohol has about one-fourth the dissociation power of water. Dissociation, however, is incapable of explaining the magnitude of the molecular rise in the more concentrated solutions, and is entirely incapable of explaining the fact that the molecular rise of the boiling-point increases with the concentration of the solution up to the most concentrated solutions that were employed.

Calcium nitrate is an exception to the above relations, as was found earlier by Jones and Getman.† As this was rather surprising, Jones and McMaster repeated the work, and obtained essentially their results. The molecular rise in the boiling-point of ethyl alcohol produced by calcium nitrate decreases from the most concentrated solution studied, with a fair degree of regularity. In the most concentrated solutions, the molecular rise becomes less than the

\* Amer. Chem. Journ., **23**, 103 (1900). † *Ibid.*, **32**, 338 (1904).

TABLE 100.—RESULTS WITH ETHYL ALCOHOL.

Lithium ehloride in ethyl alcohol.			Lithium bromide in ethyl alcohol.			Lithium bromide in ethyl alcohol (second series).		
$m$	$\rho$	$\frac{\rho}{m}$	$m$	$\rho$	$\frac{\rho}{m}$	$m$	$\rho$	$\frac{\rho}{m}$
0.1356	0.191	1.408	0.0752	0.096	1.276	0.1126	0.140	1.24
0.3692	0.555	1.503	0.1942	0.300	1.544	0.1890	0.270	1.45
0.3958	0.595	1.503	0.3390	0.514	1.516	0.3815	0.550	1.44
0.5084	0.765	1.504	0.3544	0.530	1.495	0.4161	0.617	1.48
0.5350	0.803	1.500	0.4387	0.675	1.538	0.4476	0.665	1.48
0.5407	0.812	1.502	0.5731	0.914	1.594	0.5788	0.880	1.52
0.6478	1.025	1.582	0.5892	0.945	1.604	0.6513	1.031	1.58
0.6771	1.080	1.595	0.6072	0.978	1.610	0.7031	1.151	1.63
0.7577	1.218	1.6075	0.6280	1.000	1.629	0.8312	1.441	1.73
0.8083	1.320	1.633	0.7640	1.263	1.653	0.9950	1.798	1.81
0.8235	1.347	1.635	1.0336	1.935	1.872	1.3142	2.655	2.02
0.8529	1.401	1.642	1.0510	1.923	1.875			
0.9035	1.495	1.650	1.0530	1.981	1.881			
			1.1030	2.134	1.940			
			1.1730	2.325	1.982			
Lithium nitrate in ethyl alcohol.			Calcium nitrate in ethyl alcohol.					
$m$	$\rho$	$\frac{\rho}{m}$	$m$	$\rho$	$\frac{\rho}{m}$			
0.0815	0.103	1.280	0.0428	0.057	1.33			
0.1423	0.187	1.314	0.0594	0.078	1.31			
0.2990	0.421	1.407	0.1137	0.135	1.18			
0.3088	0.435	1.408	0.1153	0.138	1.19			
0.3234	0.459	1.420	0.1981	0.239	1.20			
0.3370	0.479	1.420	0.2161	0.253	1.17			
0.5377	0.776	1.440	0.2590	0.300	1.16			
0.6297	0.920	1.460	0.2920	0.333	1.14			
0.7330	1.072	1.460	0.2964	0.340	1.14			
0.7962	1.165	1.460	0.3081	0.351	1.14			
0.8444	1.241	1.470	0.3380	0.383	1.13			
1.1770	1.800	1.530	0.3485	0.395	1.13			
1.2530	1.951	1.557	0.3815	0.425	1.11			
			0.3978	0.444	1.11			
			0.5361	0.582	1.08			
			0.5680	0.620	1.09			
			0.6862	0.740	1.08			
			0.7029	0.750	1.07			
			0.8274	0.885	1.07			
			0.9118	0.972	1.06			

theoretical value 1.15, notwithstanding the fact that in such solutions we have quite appreciable dissociation. The conclusion to which we seem to be forced by the results, is that calcium nitrate in ethyl alcohol is somewhat polymerized. We probably have also combination between the solvent and the salt, but this is more than overcome, as far as the effect on boiling-point is concerned, by the polymerization of molecules of the salt itself, forming

more complex aggregates than would be expressed by the simple formula,  $\text{Ca}(\text{NO}_3)_2$ .

The conclusion to which we are led by the results in general in ethyl alcohol, is the same as that to which we have already referred in the case of solutions in methyl alcohol. The large value of the molecular rise in the more concentrated solutions would indicate that a part of the alcohol was not playing the rôle of solvent, but was combined with the dissolved substance. This would also account for the increase in the molecular rise of the boiling-point with increase in the concentration of the solution, notwithstanding the fact that the dissociation is decreasing as the solutions become more concentrated. As the amount of dissolved substance present increases, the total amount of the solvent combined with it increases, and less and less alcohol is acting as solvent as the concentration becomes greater and greater. This is in keeping with the law of mass action. The amount of the solvent combined with one molecule of the dissolved substance is probably greater, the more dilute the solution, at least up to a certain point. We have not yet worked out even the approximate composition of the alcoholates formed, as Jones and Getman\* and Jones and Bassett† have done in the case of aqueous solutions. This is due, in part, to the fact that we have not yet had time to determine accurately the dissociation of the various salts at the different dilutions in the alcohols.

When such data shall have been secured, there ought to be no serious difficulty in calculating the approximate composition of the alcoholates formed by the various salts in solution in these solvents. Work is now in progress on this and similar problems.

\* Amer. Chem. Journ., 31, 303 (1904); 32, 308 (1904). Ztschr. phys. Chem., 49, 385 (1904).

† Amer. Chem. Journ., 33, 334 (1905).



## THE BEARING OF HYDRATES ON THE TEMPERATURE COEFFICIENTS OF CONDUCTIVITY OF AQUEOUS SOLUTIONS.

That the electrical conductivity of aqueous solutions of electrolytes, in general, increases greatly with rise in temperature is a well-known fact. This might be due either to an increase in the dissociation of the electrolyte with rise in temperature, or to an increase in the velocity with which the ions move, or to both. It is not a difficult matter to test the effect of change in temperature on the dissociation of electrolytes. It is only necessary to measure the dissociation directly at different temperatures by the conductivity method. This has been done recently by Jones and West,\* for temperatures ranging from zero to thirty-five degrees. The result is, that electrolytes in general are slightly less dissociated at the higher than at the lower temperatures. Noyes and Coolidge† have shown that dissociation decreases rapidly at more elevated temperatures.

As has been pointed out, this is in accord with the theory of Dutoit and Aston, which makes the dissociating power of a solvent a function of its own association—the more associated a solvent the greater its dissociating power. Take a solvent like water; the higher the temperature the less it is associated, and, consequently, the smaller its power to break molecules of electrolytes down into ions.

Having eliminated the factor of dissociation as increasing the conductivity of electrolytes at the higher temperature, we are forced to conclude that the increase in conductivity with rise in temperature, shown by solutions of electrolytes in general, is due to an increase in the velocities with which the ions move.

There are a number of factors that determine the velocity with which an ion moves through a solution of an electrolyte. Assuming that the force which drives the ions is constant, the velocity would be conditioned chiefly by the viscosity of the medium through which the ion passed, and the size and mass of the ion; at the more elevated temperature the force which drives the ion would be greater, and the viscosity of the medium through which the ion moves would be less. Both of these factors would increase the velocity with which the ions move, and, consequently, increase the conductivity as the temperature was raised.

The object of this section is to call attention to another factor that causes the ions to move faster at the more elevated temperature. *The mass of*

---

\*Amer. Chem. Journ., 34, 357 (1905).

†Ztschr. phys. Chem., 46, 323 (1903).

*the ion decreases with rise in temperature.* This does not refer to the charged atom or group of atoms which we usually term the ion, but to this charged nucleus plus a larger or smaller number of molecules of water that are attached to it, and which it must drag along with it in its motion through the remainder of the solvent.

That ions are hydrated has been shown beyond question by Jones and his co-workers. That these hydrates are relatively unstable compounds has also been demonstrated; the higher the temperature, the less complex the hydrates existing in the solution. This can be seen from one example. In a solution of a certain definite concentration every molecule of calcium chloride, or the ions resulting from it, holds about 30 molecules of water. From such a solution practically all of the water can be removed by simply boiling it, except six molecules of water to one of calcium chloride; this number being brought out of the solution by the salt as water of crystallization. The higher the temperature, then, the less complex the hydrate formed by the ion. The less the number of molecules of water combined with the ion, the smaller the mass of the ion and the less its resistance when moving through the solvent; consequently, the ion will move faster at the higher temperature. This conclusion can be tested by the results of experiment. If this factor of diminishing complexity of the hydrate formed by the ion with rise in temperature, plays any prominent rôle in determining the large temperature coefficient of conductivity, then we should expect to find *those ions with the largest hydrating power having the largest temperature coefficients of conductivity.* This will readily be seen to be the case. The more complex the hydrate, *i. e.*, the greater the number of molecules of water combined with an ion, the greater the *change* in the complexity of the hydrate with rise in temperature. We can readily test this conclusion by the results of the experimental work of Jones and West.\* Let us compare the temperature coefficients of conductivity, per degree rise in temperature, for some of those substances that have slight hydrating power, with the corresponding coefficients for a few of the substances that have much greater power to combine with water. (See table 101, page 154.)

The volumes for which the comparisons are made are 2 and 1024, and the temperatures from 25° to 35°. A comparison of the two sections of the table will show that the above conclusion is confirmed by the experimental results. The substances included in the first section of the table have very slight hydrating power. Those in the second section have very much greater hydrating power. It will be remembered that hydrating power is a function of water of crystallization—the larger the number of molecules of water of crystallization the greater, in general, is the hydrating power of the substance. It will be seen that the substances in the first section of

\*Amer. Chem. Journ., 34, 357 (1905).

table 101 have little or no water of crystallization, while those in the second section of the table crystallize with large amounts of water. The water of crystallization may be taken as roughly proportional to the hydrating power of the substance.

The substances in the first section of table 101 have much smaller coefficients of conductivity than those in the second section, even taking into account the fact that those in the first part of the table are ternary electrolytes, while those in the second part are binary electrolytes.

Another fact of equal importance is brought out by comparing the results in the first part of the table with one another, and, similarly, those in the second part of the table with one another. If the temperature coefficient of conductivity is a function of the decrease in the complexity of the hydrate formed by the ion, with rise in temperature, then we should expect that *those substances which have equal hydrating power would have approximately the same temperature coefficients of conductivity.*

TABLE 101.

Substances with slight hydrating power.			Substances with large hydrating power.		
	Temperature coefficients in conductivity units.			Temperature coefficients in conductivity units.	
	$v=2$	$v=1024$		$v=2$	$v=1024$
Ammonium chloride	2.07	2.94	Calcium chloride ..	3.11	5.61
Ammonium bromide	2.16	2.86	Calcium bromide ..	3.01	5.20
Potassium chloride .	2.13	2.84	Strontium bromide	2.93	5.27
Potassium bromide .	2.18	2.91	Barium chloride ..	2.86	5.30
Potassium iodide....	2.09	2.91	Magnesium chloride	2.55	4.59
Potassium nitrate..	1.86	2.71	Manganese chloride	2.37	4.86
			Manganese nitrate..	2.24	4.16
			Cobalt chloride ...	2.54	4.95
			Cobalt nitrate ....	2.48	4.67
			Nickel chloride ...	2.63	5.04
			Nickel nitrate ....	2.51	4.58
			Copper chloride....	2.15	5.04
			Copper nitrate.....	2.38	4.88

If we examine the above table we shall see that this is true. The substances in the first part of the table all have only very slight hydrating power, as would be expected from the fact that they all crystallize without water. Their temperature coefficients of conductivity are all of the same order of magnitude and, indeed, are very nearly equal.

The substances in the second part of the table all have very great hydrating power, and all have a hydrating power of the same order of magnitude. This would be expected, since nearly all of these substances crystallize with 6 molecules of water. There are a few compounds in this table calling for

special comment. Barium chloride crystallizes with only 2 molecules of water, yet it forms hydrates comparable with those substances with larger amounts of water of crystallization. It is, therefore, perfectly in keeping with the above relation that its temperature coefficients of conductivity should be of the order of magnitude that they are in the above table.

Manganese chloride crystallizes with only 4 molecules of water, but the work of Jones and Bassett shows that it forms hydrates nearly as complex as the other salts in the second part of table 101. Its temperature coefficients of conductivity are of the same order of magnitude as the other substances in this table.

Of the substances recorded in the second part of table 101, the one that apparently presents the most pronounced exception to the relation that we are now considering is copper chloride. This salt crystallizes with only 2 molecules of water, and yet has a temperature coefficient of conductivity that is nearly as large as the salts with 6 molecules of water of crystallization. It might be inferred that this salt has much less hydrating power than the others in the second section of table 101. The work of Jones and Bassett shows that this is not the case. Copper chloride has a comparatively large hydrating power; indeed, larger than would be expected from the amount of water with which it crystallizes. Its temperature coefficient of conductivity is, therefore, not surprisingly great.

A third point that is brought out by the results in the above tables is the following: *At the higher dilution, the temperature coefficient of conductivity for any given substance is greater than at the lower dilution.*

That this is a general relation will be seen by reference to the work of Jones and West.\* This is explained very satisfactorily on the basis of the suggestion made above. The complexity of the hydrate at the higher dilution is greater than at the lower dilution, as is shown by the work recorded in the earlier part of this monograph, on the composition of the hydrates formed by different substances at different dilutions.

The hydrate being more complex at the higher dilution, the change in the composition of the hydrate with change in temperature would be greater at the higher dilution, and, consequently, the temperature coefficient of conductivity is greater the more dilute the solution.

The three points that are established in this connection are:

1. The temperature coefficients of conductivity of aqueous solutions of electrolytes are greater the greater the hydrating power of the electrolyte.
2. The temperature coefficients of conductivity of aqueous solutions of electrolytes are of the same order of magnitude for those substances having approximately the same hydrating power.

\*Amer. Chem. Journ., 34, 357 (1905).

3. The temperature coefficients of conductivity for any given substance increase with the dilution of the solution, and this increase is greatest for those substances with large hydrating power.

All three of these conclusions are necessary consequences of the assumption that the *large increase in conductivity with rise in temperature is due, in part, to the decreasing complexity of the hydrates formed around the ions.*

Since these conclusions are all verified by the results of experiment, we must accept the assumption that led to them as containing a large element of truth.

It is more than probable that the decreasing complexity of the hydrates with rise in temperature, is a very important factor in conditioning the large temperature coefficients of conductivity, shown especially by those substances that have large hydrating power.



# PART II.



SPECTROSCOPIC INVESTIGATIONS.



WORK OF UHLER.





## AQUEOUS SOLUTIONS.

### INTRODUCTORY.

The importance of the absorption spectra of salts as affected by the presence of certain other salts, in their bearing on the hydrate theory as proposed by Jones, has already been pointed out.\* It has been mentioned that our attention was directed to certain of these color changes by Dr. G. N. Lewis.

The chief reactions that we have studied are those between cobalt chloride, copper chloride, and copper bromide, when treated with calcium chloride, calcium bromide, or aluminium chloride. It is well known that aqueous solutions of cobalt chloride are purplish-red in color. When a strong, aqueous solution of cobalt chloride is treated with a fairly concentrated, aqueous solution of calcium chloride, the color of the cobalt solution is changed from purplish-red to blue. This same result is obtained if calcium bromide is used instead of calcium chloride. Similar color changes occur when solutions of aluminium chloride are added to solutions of cobalt chloride. Indeed, smaller amounts of aluminium chloride are required to effect the same color changes than are necessary when either of the salts of calcium is used.

If any one of the above-named dehydrating agents is added to a fairly dilute solution of cupric chloride or bromide, marked color changes result. A fairly concentrated solution of cupric chloride or bromide is greenish-brown, while dilute solutions are blue. As more and more water is added to the more concentrated solutions, we have all gradations between the above colors. The addition of calcium chloride, calcium bromide, or aluminium chloride, to a blue solution of the copper salt changes the color to green, and if sufficient of the dehydrating agent is added the color becomes greenish-brown.

In the present investigation these color changes have been studied quantitatively. The absorption spectra of the substances separately, and when mixed in known quantities, have been observed by means of a direct-reading spectroscope, and the wave-lengths of the absorption bands read off and recorded. What is of far greater importance, however, is the photographic record of such absorption bands, and the changes in the position of these bands as varying amounts of one or another dehydrating agent is added to the salt in question. These photographs have been taken by means of the spectrograph, to be described later.

Before taking up in detail the work that is here recorded, a brief discussion of some of the more important investigations in this same field seems desirable.

---

\* Amer. Chem. Journ., 34, 291 (1905). Journ. de Chim. phys., 3, 494 (1905).

The fact that dehydrating agents produce the change in color from purplish-red to blue, and, further, that the same color change is effected by raising the temperature of the solution, early suggested the view that the change in color from reddish to blue was due to a loss of water on the part of the salt in solution.

Babo\* observed that cobalt chloride in concentrated solution was colored blue by absolute alcohol at ordinary temperatures. At more elevated temperatures a few drops of alcohol are sufficient to produce the blue color. A solution of calcium chloride or magnesium chloride changes the color of cobalt chloride to blue very readily, especially at the boiling-points of the solutions. A saturated solution of sodium chloride will also produce the blue color at elevated temperatures.

A concentrated solution of zinc chloride, on the other hand, gives only a red color with cobalt chloride, even when the mixture is warm. Babo thinks that this is due to the formation of a double salt. He concludes that whenever there is a transformation from the reddish to the blue color, there is a dehydration of the cobalt salt.

Gladstone† in his well-known paper, "On the Use of the Prism in Qualitative Analysis," takes up the question here under discussion. In connection with salts of cobalt he says:

"We are accustomed to speak of blue and red salts of cobalt, but this difference depends on the state of hydration, and the prism reveals an analogy otherwise unsuspected between the two colors."

He points out that the salts of cobalt, in general, when anhydrous are blue, and that the hydrated salts or aqueous solutions are red. The only exception seems to be the sulphocyanate, whose saturated aqueous solution is blue. The dilute aqueous solution of even this salt is, however, red. In his subsequent investigations with the *Ioscope*, he comes essentially to the same conclusions as those pointed out above.‡ He brought within the scope of this investigation a large number of colored compounds. Among the substances where the character of the color changes with the dilution, are the three salts upon which special stress has been laid in this investigation—cobalt chloride, copper chloride, and copper bromide.

In 1859 Schiff§ published a paper on the "Effect of Rise in Temperature on the Intensity of the Color of Solutions," in which such questions as those now under consideration were discussed. He added a number of cases of color changes with change of temperature, to those already observed

\* Ber. Über d. Verhandl. d. Gesell. f. Beford. d. Naturw. zu Freiburg, i. B. 1857, No. 17, 283. Jahresber, 1857, 72.

† Journ. Chem. Soc. (Lond.), 10, 79 (1859).

‡ *Ibid.*, 11, 36 (1859).

§ Lieb. Ann., 110, 203 (1859).

by Babo and Gladstone, and seems to be of the same general opinion as to their cause—that there is a change in the magnitude of the hydration.

Bersch\* in 1867 proposed a new view to account for the color changes in the case of cobalt salts. He recognized that when  $\text{CoCl}_2 \cdot 6\text{H}_2\text{O}$  is heated, it yields two well-defined compounds,  $\text{CoCl}_2 \cdot 4\text{H}_2\text{O}$  and  $\text{CoCl}_2 \cdot 2\text{H}_2\text{O}$ , the former being bluish-red and the latter violet in color. But he thought that he established the fact that the compound  $\text{CoCl}_2 \cdot 6\text{H}_2\text{O}$  may become blue without loss of water, and concluded, therefore, that there are two modifications of the compound  $\text{CoCl}_2 \cdot 6\text{H}_2\text{O}$ —the one red and the other blue, and that the first change in color on heating is due to the transformation of the red into the blue modification.

Tichborne† called attention to an interesting and important fact which is stated in his own words:

“It is easy to portend that although impossible at ordinary atmospheric pressure, and in an ordinary aqueous solution, to dissociate the water, it is only necessary to boil such a solution under sufficient amount of pressure to obtain the thermoanalytic point. This was demonstrated by the following experiment: A weak solution of chloride of cobalt was sealed up in a glass tube, two-thirds of the capacity of which was empty. On boiling the liquid in this tube the solution gradually passes with the increment of heat through all the shades of purple, until the contents ultimately become pure blue. Thus, in this aqueous solution we have attained by extraordinary pressure, the temperature necessary for the separation of the water. The change of color may be easily observed as it occurs in the capillary tube, by holding any white material at the back of the tube and opposite the experimenter.”

It is obvious that this observation is of importance in connection with the theory as to the cause of these color changes.

Attention was again called to this same fact by Clowes‡ about two years later.

The spectrum of cobalt chloride was early studied, especially by Vogel.§ He pointed out that the red aqueous solution of cobalt chloride shows only one broad band in the green, and this lies between F and D. In stronger solutions there is absorption of the violet, blue, and green, the less refrangible boundary of this region alone being transparent. When the solution of cobalt chloride is evaporated nearly to dryness it becomes blue. The absorption of the blue and green completely disappears, and two sharp bands appear in the red and orange. Vogel also studied the spectrum of the blue alcoholic solution, and pointed out certain relations between it and the spectrum of the blue aqueous solution. He observed, however, that the absorption bands are closer to the red in the aqueous than in the alcoholic solution.

\*Sitzungsber, Wien-Akad., II, 56, 726 (1867).

†Chem. News, 25, 133 (1872).

‡*Ibid.*, 29, 161 (1874).

§Ber. d. deutsch. chem. Gesell., 11, 913 (1878).

Russell\* made a fairly extended spectroscopic study of solutions of cobalt chloride. He worked with a fused salt, with its solution in concentrated hydrochloric acid, and with its solution in various alcohols. He showed that the spectrum in the concentrated acid was very similar to that of the fused salt, the two bands being shifted a little towards the blue. The spectrum of cobalt chloride when dissolved in the various alcohols and in glycerol, was practically the same, independent of the nature of the solvent.

Russell also worked with aqueous solutions at different concentrations, and studied their absorption spectra. He also studied the effect of change of temperature on the various aqueous solutions. He concluded that the color of the aqueous solutions was due to the presence of hydrates in them.

Potilitzin† took up the study of cobalt chloride especially to test the conclusions reached by Bersch—that there are two modifications of the compound  $\text{CoCl}_2 \cdot 6\text{H}_2\text{O}$ , the one red and the other blue. He showed that when the hexahydrate is warmed to about  $52^\circ$  for four hours, it passes over into the dihydrate,  $\text{CoCl}_2 \cdot 2\text{H}_2\text{O}$ , which is reddish, with a slightly violet tint. The same compound is obtained when the hexahydrate is placed in a desiccator for a few days. At  $100^\circ$  the dihydrate passes over into the monohydrate,  $\text{CoCl}_2 \cdot \text{H}_2\text{O}$ , which is dark violet in color. When the monohydrate is warmed from  $110^\circ$  to  $120^\circ$ , it loses its last molecule of water and yields the anhydrous salt, which is blue. Potilitzin concludes that the transition temperatures from one hydrate to another of cobalt chloride, as given by Bersch, are in error; that there is only one modification of the compound  $\text{CoCl}_2 \cdot 2\text{H}_2\text{O}$ , and that the only other hydrate of cobalt chloride has the composition  $\text{CoCl}_2 \cdot \text{H}_2\text{O}$ .

The formation of blue cobalt chloride from red, by whatever means effected, is a dehydration process.

Sabatier‡ showed that hydrates of cobalt chloride containing less water than the hexahydrate, were formed when hydrochloric acid was added to a strong aqueous solution of the cobalt salt. There seems to be some evidence for the formation of chlorhydrates. He§ performed similar experiments with copper chloride, and obtained analogous results.

In 1890 Lescœur|| took up a study of the hydrates formed by cobalt chloride. He found also that at  $120^\circ$  the compound  $\text{CoCl}_2 \cdot 2\text{H}_2\text{O}$  is produced. When any of the hydrates are heated up to  $140^\circ$ , they yield the anhydrous chloride. The compound  $\text{CoCl}_2 \cdot 2\text{H}_2\text{O}$  of lilac color, is easily obtained by drying the hexahydrate over sulphuric acid at ordinary temperature. There is no intermediate hydrate such as  $\text{CoCl}_2 \cdot 4\text{H}_2\text{O}$  formed.

\* *Proceed. Roy. Soc.*, **32**, 258 (1881).

† *Ber. d. deutsch. chem. Gesell.*, **17**, 276 (1884).

‡ *Compt. rend.*, **107**, 42 (1888).

§ *Ibid.*, **106**, 1724 (1888).

|| *Ann. Chim. Phys.*, [6] **19**, 547 (1890).

In 1891 a number of papers appeared bearing upon the problem under discussion. Etard\* pointed out the importance of studying simultaneously the color changes and solubility curve. He worked with cobalt chloride and cobalt iodide, and showed that at those temperatures corresponding to the formation of a new hydrate the solubility curve changed direction, being no longer a straight line. The new hydrate would have different solubility from the old, and this was clearly shown by the solubility curves. He thus proved the existence of the following hydrates:  $\text{CoI}_2 \cdot 6\text{H}_2\text{O}$ ,  $\text{CoI}_2 \cdot 4\text{H}_2\text{O}$  and  $\text{CoI}_2 \cdot 2\text{H}_2\text{O}$ ;  $\text{CoCl}_2 \cdot 6\text{H}_2\text{O}$  and  $\text{CoCl}_2 \cdot 2\text{H}_2\text{O}$ .

Potilitzin† came back to the problem of the change in the color of cobalt chloride, having published a paper seven years earlier on this same subject. He points out that when crystals of  $\text{CoCl}_2 \cdot 6\text{H}_2\text{O}$  melt, they form a deep violet-colored liquid, which becomes more and more deeply blue. He also points out that hydrating substances, in general, produce the blue color. He concludes that these changes in color are due entirely to changes in the hydration of the cobalt chloride.

Charpy‡ studied the vapor-tension of solutions of cobalt chloride, and plotted the results as curves. He found that the curve was made up of two well-defined, rectilinear portions. The two portions of the curve met at  $75^\circ$ . Above this temperature the solutions were blue in color. This agrees in a way with the results found by Etard.

As Charpy points out, his results can be interpreted in either of two ways. There is either a change in the hydration of the salt with change in temperature, or there is a change in the state of molecular aggregation. From these results it is impossible to decide between the above two possibilities.

Wyrouboff§ calls attention to the fact that the change in the color of solutions of cobalt chloride with rise in temperature, can not be due to the presence of the anhydrous salt, since this combines with water with the greatest avidity, a large amount of heat being at the same time liberated. He showed that the change in color was due to the formation of the monohydrate  $\text{CoCl}_2 \cdot \text{H}_2\text{O}$ , which is formed in larger and larger quantities the more elevated the temperature. This violet-colored hydrate is stable, not losing its molecule of water until a temperature of  $140^\circ$  is reached, when it passes over into the pale blue, anhydrous salt.

Engel|| does not accept any of the theories that have been advanced to account for the color changes that take place in cobalt chloride. He reviews briefly our knowledge of the hydrates of cobalt chloride, and then takes up the theories that have been proposed to account for the color changes.

\*Compt. rend., **113**, 699 (1891).

†Bull. Soc. Chim., [3] **6**, 264 (1891).

‡Compt. rend., **113**, 794 (1901).

§Bull. Soc. Chim., [3] **5**, 460 (1901).

||*Ibid.*, [3] **6**, 239 (1891).

He objects to the dehydration theory, that the blue color is due to the presence of the anhydrous salt, since this salt is light blue, while the solutions are much deeper blue, and, indeed, often indigo blue. He objects to the theory of Wyruboff, since the monohydrate is violet and never blue, and the solutions are often blue.

Engel does not believe that any general theory can be advanced to account for the changes in color which cobalt chloride undergoes. He thinks that each special case must be dealt with separately. He is of the opinion that the blue color is due to the presence of compounds which cobalt chloride is capable of forming with various substances. Some of these compounds are not blue—notably the one formed with zinc chloride. Mercuric chloride, stannous chloride, and the chloride of antimony behave like the chloride of zinc.

Engel supports his theory that the blue color is due to the presence of double chlorides, by stating that he has obtained a double chloride of calcium and cobalt, and calls attention to the fact that Chassevent\* has prepared a blue double chloride of cobalt and lithium, having the composition  $\text{CoCl}_2 \cdot \text{LiCl} \cdot 3\text{H}_2\text{O}$ , which is probably analogous to  $\text{CoCl}_2 \cdot \text{HCl} \cdot 3\text{H}_2\text{O}$ , the compound formed with hydrochloric acid. The double copper salt is, however, red. Engel thinks that the blue color produced in a saturated solution by rise in temperature, is not due solely to the presence of the monohydrate, which is violet, but to the formation of a compound with hydrochloric acid, the hydrochloric acid being liberated as the result of the action of water on cobalt chloride.

Wyruboff\* answers a number of the objections advanced by Engel against the dehydration theory, especially concerning the color of the monohydrate. It is largely a question of physical state, whether we are dealing with transmitted or reflected light. Le Chatelier\* does not doubt the existence of blue double salts—chlorhydrates, alcoholates, etc.—but thinks the color changes can easily be explained on the dehydration theory. He points out that the formation of the acid chloride would involve also the formation of the oxychloride, which would be precipitated, and this is not the case.

Le Chatelier† shows that both red and blue cobalt chloride act on calcium carbonate, and that this and other lines of evidence adduced by Engel against the hydration theory are not valid.

Etard‡ studied the changes in the absorption spectra of cobalt chloride with change in temperature, and found with rise in temperature the disappearance of certain bands and the appearance of others. This work is

\* Bull. Soc. Chim., [3] 6, 3 (1891).

† *Ibid.*, [3] 6, 84 (1891).

‡ Compt. rend., 120, 1057 (1895).

analogous to that of Becquerel,\* which deals especially with the absorption spectra of salts of didymium and uranium.

As Etard points out, the appearance of the new bands with rise in temperature shows that there is some new internal arrangement of the molecules, as we should expect if there was a change in the hydration as the temperature changes. As the nature of the molecules in the solution changes new absorption bands will make their appearance.

The most elaborate work, by far, that has been done on the absorption spectra of cobalt salts is that of Hartley.† This is but part of an extensive investigation on the absorption spectra of a number of colored salts. This work includes also the chloride and bromide of copper.

The spectra of an aqueous solution of cobalt chloride, at temperatures ranging from 23° to 93°, were photographed, and the bands also measured. Hartley concludes that his photographs of these spectra of the solution at different temperatures show that molecules of water are split off from the cobalt chloride with rise in temperature. The absorption bands widen in the red with rise in temperature, showing that the molecule is becoming simpler, and vibrates in resonance with a larger number of waves.

Hartley worked also with solutions of cobalt chloride in absolute alcohol at different temperatures, and concluded that rise in temperature did not affect the alcoholic solutions. He also worked with solutions of cobalt chloride in glycerol; with cobalt chloride mixed with hydrochloric acid, and with cobalt chloride to which a solution of calcium chloride had been added. Work similar to the above was done with cobalt bromide and iodide.

The effect of rise in temperature on the absorption spectra of a number of salts of chromium was also studied.

Hartley concludes that the effect of rise in temperature, in general, on the absorption spectra of solutions of salts is as follows: If the salts are anhydrous or not dehydrated at 100°, or if they do not change color when dehydrated, they do not change their absorption spectra when heated. Hydrated salts change their spectra with change in temperature, and this change is usually very nearly the same as that effected by dehydrating agents.

Ostwald‡ concludes that the red color of solutions of cobalt salts, in general, is due to the cobalt ion. He points out that the hexahydrate easily loses water and forms lower hydrates which are blue in color. If the concentrated aqueous solutions are heated, they turn blue. This same color change is very easily produced by adding to the solution of cobalt chloride chlorine ions. Thus, the presence of hydrochloric acid or sodium chloride

\*Ann. Chim. Phys., [6] 14, 170 and 257 (1888).

†Trans. Roy. Soc. Dublin, II, 7, 253 (1900).

‡Grundlinien d. anorgan. Chem., 620.

easily produces the blue color. Ostwald concludes that the blue color is due to the driving back of the dissociation of the cobalt chloride, the anhydrous salt being blue.

In a recent paper, Donnan and Bassett\* take the view that none of the theories thus far proposed is satisfactory. They make the suggestion that the blue color may be due to the presence of complex cobalt anions. They point out that the blue alcoholic solutions when cooled down to  $-79^{\circ}$  become red, and conclude that this can not be due to hydration. The question arises as to whether it may not be due to alcoholation.

The action of salts of zinc, mercury, cadmium, antimony, and tin, in turning blue solutions of cobalt chloride red, is explained as being due to the fact that these metals have a greater tendency to form complex negative ions than cobalt, and that they therefore break up the complex ions formed by the cobalt. This explanation seems decidedly forced. Evidence of a very direct kind should certainly be furnished, that the above metals do have a very great tendency to form complex anions. In some of the above cases this is certainly not obvious.

Hartley† calls attention to certain inaccuracies in the above paper. It is not at all certain that when hydrochloric acid is added to a solution of cobalt chloride, the blue color is due to the same cause as when an aqueous solution is heated. Indeed, the absorption spectra in the two cases are quite different. Hartley points out further that the color of hot aqueous solutions was not supposed to be due to the anhydrous cobalt chloride, but to a dihydrate. Again, the spectra of a solution of cobalt chloride saturated at  $20^{\circ}$ , and taken at the temperatures  $23^{\circ}$ ,  $33^{\circ}$ ,  $43^{\circ}$ ,  $53^{\circ}$ ,  $73^{\circ}$ , and  $93^{\circ}$ , are all different from the spectrum obtained from the anhydrous salt in absolute alcohol, and are also different from the cobalt chloride to which hydrochloric acid had been added.

Hartley also criticizes certain other points in the paper by Donnan and Bassett, but it would lead us too far to discuss these in detail.

Quite recently, Lewis‡ has called attention to the importance of these color changes for the theory of hydrates in solution.

Jones and Bassett§ have discussed the reactions described by Lewis, and Jones|| has supplemented them by a number of other cases which bear directly upon the hydrate question.

We shall now take up the work that we have carried out on the problem in hand.

\*Journ. Chem. Soc. (Lond.), 81, 942 (1902).

†*Ibid.*, 83, 401 (1903).

‡Ztschr. phys. Chem., 52, 224 (1905).

§Amer. Chem. Journ., 34, 291 (1905).

||Journ. de Chim. phys., 3, 455 (1905).



## APPARATUS.

## THE SPECTROGRAPH.

The apparatus was designed by one\* of us in his previous study of the absorption spectra of the aniline dyes. Since reference to other descriptions of the spectrograph may not be convenient, a brief account of its chief characteristics will be given below. The essential parts of a vertical section of the spectrograph are outlined in their exact relative proportions in fig. 64, which is one-fifteenth of the natural size. This may be described as follows. In the first place, each element of the system was adjustable in every respect. Light from a Nernst filament *N* was focused by the concave speculum mirror *R*, on the slit *S*, whence it continued to the grating *G*, from which a portion of it was dispersed in the direction of the sensitized film *F*. The adjustable support of the mirror was rigidly attached to the main body of the spectrograph. The distances from the middle of the slit to the centers of the mirror and grating were, respectively, about 89.5 and 97.1 cm. The electrodes *E* were so located above the slit as not to interfere with the passage of light from the reflector to the slit. No lenses or other reflectors were used. The micrometer head at *M* indicated the separation of the slit-jaws. *Q* and *Q'* denote a screen system, such that when *Q* was vertical the passage of light from the grating to the camera was not interfered with; whereas when *Q* was horizontal only ultra-violet light of shorter wave-lengths than  $0.4\mu$  could reach the photographic film. *PP* is a horizontal platform with a scale along its front edge. By sliding horizontal opaque screens of various widths along this

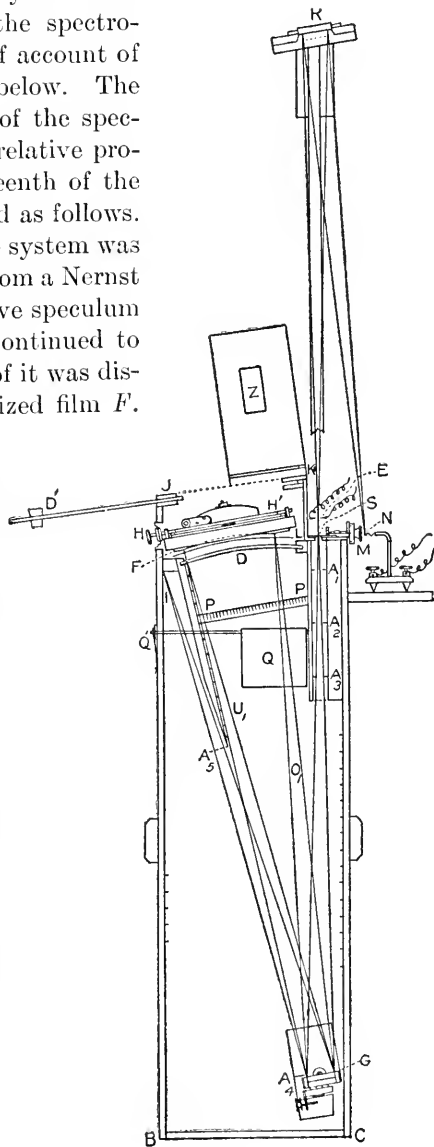

FIG. 64.

\* Uhler and Wood: Atlas of Absorption Spectra, Publication No. 69, Carnegie Institution of Washington. (In press.)

platform, it was possible to cut out completely any region or regions of wave-lengths desired. In making certain tests, the platform and sliding screens were very convenient.  $L$  is the section of a thin, black, metal shutter capable of motion in a horizontal direction, and hence at right angles to the length of the photographic films or plates; in other words, parallel to the slit and to the rulings of the grating. A number of long, rectangular slots or openings, suitably spaced and proportioned, were present in this screen, so that strips of different widths of the films or plates could be exposed to the light from the grating, without causing any displacement of the sensitized surfaces with reference to the grating and slit. This was necessary for impressing comparison spectra, etc.  $H$  and  $H'$  suggest the rack and pinion system, by the aid of which the films could have unexposed portions brought successively opposite to some selected opening in the slide screen  $L$ .  $D$  and  $D'$  denote two of the four doors that gave access to the interior of the spectrograph, and which made it possible to close up the camera light-tight, while making various adjustments with the rest of the system. The camera was so made that when neither a film nor plate was in position, it was possible for the experimenter to look directly at the grating and to make qualitatively, observations with the assistance of any eyepiece. Certain black-on-white scales and ruby-glass windows ( $Z$ , for example) enabled the experimenter to know the precise relative positions of the various accessories in the interior of the spectrograph when the entire system was shut up and exposures were being made. Numerous dull black diaphragms and screens ( $A_1, A_2, A_3, A_4, A_5$ , etc.) protected the photographic film from the unusable light which came from the central image  $I$ , and from all the spectra except the one desired.  $U_1$  and  $O_1$  gave the extreme rays of as much of the first-order spectrum as was studied photographically; that is,  $U_1$  and  $O_1$  correspond, respectively, to about  $0.20\mu$  and  $0.63\mu$ . The spectrograph was of course dull black both inside and out, and contained plaited black velvet wherever needed. A general idea of the size of this apparatus may be derived from the following dimensions: From  $R$  to the plane of  $BC = 198.5$  cm.;  $BC = 34.5$  cm.; the bottom edge perpendicular to  $BC = 27.5$  cm.;  $BJ = 116$  cm., and  $JK = 29$  cm.

#### THE SPECTROSCOPE.

This instrument was of the direct-reading type, and was obtained from Hilger, of London. An orthogonal projection of it on a horizontal plane is shown at  $H$  in fig. 65. Two details deserve special mention. In the first place the instrument was so designed that when the prism was properly adjusted on its turn-table, and the cross-hairs were correctly placed in the telescope, the wave-length of any visible spectral line which appeared to be bisected by the point of intersection of the cross-hairs could be read off directly from

the graduated drum *D*. In other words, all inconveniences attendant either upon the calibration of the spectroscope, or upon subsequent references to a calibration curve, were avoided by the construction of the apparatus itself.

Secondly, all horizontal plane sections of the single glass prism were equal trapeziums; consequently, the beam of light after entering the prism at the face nearest to the collimator experienced one total interior reflection before it suffered final refraction out into the air opposite the telescope objective. This reflection diminished greatly the curvature in the field of view of all

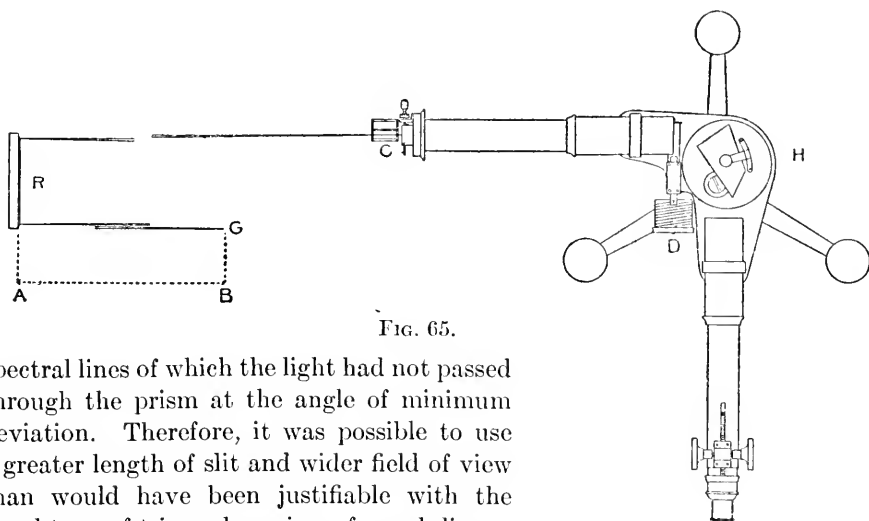

FIG. 65.

spectral lines of which the light had not passed through the prism at the angle of minimum deviation. Therefore, it was possible to use a greater length of slit and wider field of view than would have been justifiable with the usual type of triangular prism of equal dispersion. The chief practical advantage of the wide field of view was that two different spectra could be seen in this field, the one above the other, and readings could be taken directly from the graduated drum *D*, without appreciable danger arising from curvature of spectral images.

#### THE CELLS.

For photographic purposes two cells were used in the study of aqueous solutions. One of these is shown in vertical section in fig. 66. The diagram is of natural size. The cell was designed to fulfil five conditions: (a) To transmit without sensible selective absorption all radiations between wave-lengths  $0.20\mu$  and  $0.80\mu$ ; (b) not to be acted upon chemically by the solutions placed in the cell; (c) to cause the incident and emergent surfaces of the absorbing liquid to be plane and practically parallel; (d) to be capable of adjustment with respect to the length of column of liquid traversed by the light; (e) to keep itself as clean as possible when in the immediate vicinity of the spark. The parts of the cell may be briefly described as follows: *D* and *F* were short sections of glass tubing, the ends of which were ground

at right angles to their respective axes of revolution. A plane parallel plate of quartz *M*, was cemented in the lower end of tube *D*, and a similar quartz plate *O* was cemented to the inside of tube *F*, near the lower end of this tube. The position of the latter quartz plate relative to the end of the larger glass tube made it possible to slide the cell around on its lower end as much as desired, without scratching the under polished surface of the quartz, and without causing dust particles to adhere to the same. It was necessary, of course, to use quartz in order to transmit the shorter, ultra-violet waves. *V* shows a hard-rubber cylinder, carefully turned in a lathe to fit neatly the outside of the tube *D*. The collar or flange of this cylinder, when the cell was in adjustment, rested on the top of a larger glass tube in such a position as to establish parallelism between the quartz plates *M* and *O*. The smaller glass tube and the vulcanized ring were prevented from

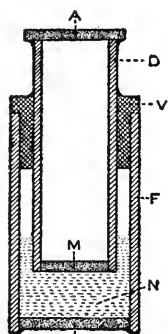

FIG. 66.

sliding along each other by a small amount of cement. It was very easy to scrape off this cement and to replace it subsequently, whenever it became necessary or desirable to alter the depth of the column of liquid between the lower quartz plates. The quartz plate *A* was an essential part of the cell. When it was not present, the passing of the spark between the electrodes above the cell produced a violent disturbance in the column of air in the tube *D*, which resulted in the deposition on the quartz plate *M* of the decomposition deposits of the electrode, *i. e.*, the oxides of cadmium, zinc, etc. Such a coating of foreign matter on the quartz of course could not be permitted. Care had to be taken to imprison dry air in the tube *D*, when

the plate *A* was cemented to the glass, because when this precaution was omitted a thin layer of moisture was deposited on the inner or opposing surfaces of the two quartz plates *A* and *M*, and produced spurious absorption effects on the spectrogram. After three or four photographic exposures with the spark had been made, the plate *A* invariably showed a thin whitish coating of the material, having boundaries which suggested a projection of the electrode on the quartz surface. This film was insoluble in water, and it adhered very tenaciously to the polished quartz. It was easily removed, however, by rubbing with a piece of soft muslin saturated with dilute hydrochloric acid. The coating was probably a mixture of the oxides of cadmium and zinc, driven hard against the quartz by the explosive violence of the spark. *N* shows the absorbing liquid in the cell. The light passed first through the quartz plate *A*, then through the dry air between *A* and *M*, then through the quartz plate *M*, next through the solution *N*, and finally through the quartz plate *O*. When the cell was filled with dis-

tiled water and extended as far as possible, no absorption, whether selective or general, could be detected photographically. Therefore, the selective absorption exhibited by the spectrograms was produced by the substance or substances in solution.

The cell just described was very well adapted to the study of plane parallel layers of liquid, having depths equal to and greater than one-half a millimeter. On the contrary, its form did not lend itself as readily to the photographic study of extremely thin layers of very opaque solutions, as did that of another cell which had been designed by one of us for an earlier investigation.\* A description of the cell last named may not be superfluous in this place. This piece of apparatus was used in the present work, in such a manner as to impart to the absorbing liquid the form of a wedge or prism of zero thickness at the refracting edge. Consequently, the spec-

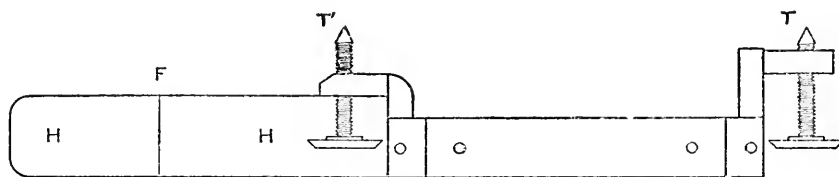

FIG. 67.

trograms obtained by this cell in the path of the beam of light, exhibit graphically the variation which the limits of the regions of selective absorption experience, when the depth of absorbing liquid varies linearly and continuously from zero to a few tenths of a millimeter at the greatest thickness.

The cell was made of five separable parts, as follows: (1) A brass framework upon which the other parts rested; (2) a transparent tray without a lid, which confined the liquid in proper bounds; (3) a transparent box-like system which gave the upper surface of the liquid the desired position; (4) a vulcanized framework to hold the last-mentioned box in place, and (5) four mahogany pins or pegs to fasten the box to its framework.

(1) A side view of this framework is presented in fig. 67. This projection on a vertical plane is of natural size. There were three micrometer screws all of the same pitch, viz, 1 turn =  $1/48$  inch = 0.053 cm. The heads of the screws were graduated on their upper surfaces in ten equal parts. The screw *T* was in the immediate plane of the cell, while the remaining screws (*T'* only is shown) were at the other end of the system, were equidistant from this plane, and were as far apart as possible. The handle was denoted by *HH*. A black fiducial mark *F*, on white ground, enabled the experimenter to tell what position the cell occupied with reference to the length

\*Uhler and Wood: Atlas of Absorption Spectra.

of the slit of the spectrograph. The lower end of  $F$  moved over a scale parallel to the slit, and in the plane of the jaws of the latter.

The flange at the bottom of the framework was made of brass, only 0.014 cm. thick, so that the absorbing liquid might be as near the slit as possible.

(2) An accurately ground, plane parallel plate of quartz, 40 mm. long, 18.5 mm. wide, and 2 mm. thick, had cemented to the periphery four rectangular sheets of glass 8 mm. high. Hence the greatest depth of liquid which could be studied by the aid of this cell was 6 mm.

(3) In fig. 68,  $a, b, c,$  and  $d$  designate the vertices of a section of the quartz plate, made by a plane perpendicular to the plane whose trace is the line

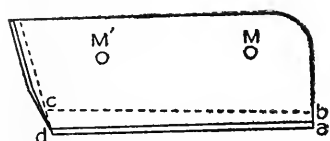

FIG. 68.

$ad$ ;  $ab$  was 2 mm.,  $ad$  was 34.8 mm., and the angle between the planes of  $ad$  and  $bc$  was  $55''$  of arc. The horizontal width of the wedge was 10 mm. Glass walls surrounded three sides of the wedge, as the outline indicates.

The reason for using the wedge was to counteract the deviation and dispersion produced

by the solution in the cell. The angle of the liquid wedge could be varied until the deviation effected by the quartz wedge nullified the average action of the absorbing solution. At first it was supposed that with liquid wedges of 15 or so minutes of arc, a plane parallel to

the quartz plate could be used successfully instead of a quartz wedge. Actual tests, however, showed that a plane parallel plate could not be relied upon, in general, to give correct results. Finally, the quartz wedge was made with

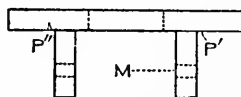

FIG. 69.

the utmost care by an expert optician, special pains being taken to have the edge through  $D$  perpendicular to the plane  $a, b, c, d$  as sharply defined as possible, and the surfaces whose traces are noted by  $ad$  and  $bc$  were accurately plane.

(4) Figure 69 represents a side view and an end view of the vulcanite frame, into which the box just described fitted. This frame was shaped out of a single block of vulcanite, since experience showed that a cemented system of several pieces was not desirable; also a dielectric was needed to keep the sparks from jumping to the screws.  $P$  indicates a little depression which fitted over the point of the screw  $T$ .  $P'$  designates the end of a straight line along which the rounded extremity of the screw  $T'$  slid.  $P''$  is the cross-section of a shallow V-shaped groove along which the pointed end

of the third screw  $T$  likewise slid. The perforations  $MM'$ , etc., correspond to each other and to the associated wooden pegs mentioned above as 5.

Figure 70 is an unconventional sketch of the cell when completely assembled.

A cell of the construction just described is very well suited to the study of thin layers of solutions, in solvents of relatively high boiling-points, such as water and amyl alcohol, but unless inclosed in some suitable vessel it is not applicable to solvents of lower boiling-points, such as methyl alcohol, ether, chloroform, acetone, etc.

The cell used for making eye observations with the spectroscope had to be constructed in such a way as to enable the observer to see simultaneously in the field of view of the telescope, the absorption spectra of two solutions. This was necessitated by the very indefinite limits of absorption possessed by most of the regions and bands of absorption of the substances studied, *i. e.*, salts of cobalt and copper. In other words, it would have meant little or nothing to have attempted to observe one solution at a time, by setting the vertical cross-hair at some definite wave-length, and to have

given the numerical value of this wave-length as the limit of absorption or of transmission, since the gradation from complete transmission to total extinction

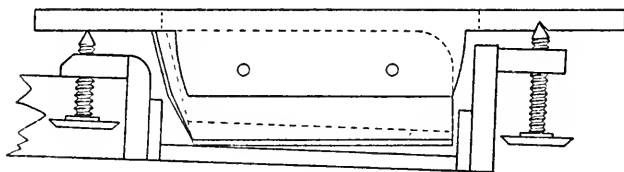

FIG. 70.

was, in general, so very gradual as to make the setting just proposed practically impossible. Even if the cross-hairs had been set on a wave-length for which it was estimated that the absorption was some definite fraction of complete extinction, this very act of estimation would have varied so greatly from one solution to the next as to cause the results to be incomparable, and hence nearly worthless.

When, on the contrary, two absorption spectra are symmetrically placed in the field of view, it is easy to see at a glance all the qualitative differences between the two spectra; and in addition, in many cases, to assign a number of the right order of magnitude to the relative displacements of the regions of absorption and of transmission in the superincumbent spectral bands.

Obviously, the light incident upon one of the solutions had to be of equal intensity to the light of the same wave-length incident upon the other solution. Two modes of procedure at least could lead to this result. One scheme would be to use two equal, but entirely independent cells; to place them symmetrically with respect to the source of light and the slit of the collimator, and to send two beams of light, one through each cell, over equal

optical paths (except the absorbing liquids) by means of two trains of reflectors or lenses suitably placed and adjusted. This plan was given a very thorough test, and was finally abandoned for the one explained below, for the reason that by the above-mentioned scheme it was necessarily troublesome to maintain two independent trains of reflectors or lenses, or totally reflecting prisms, which would produce in the field of view, when the cells were removed, two emission spectra of exactly equal intensity and also close together.

A much simpler arrangement, and one which left nothing of a practical nature to be desired, was the following (see fig. 65): Light emitted by the Nernst glower *G* fell upon the concave speculum reflector *R*. This reflector was the unruled plate for a concave grating. The reflected beam came to a focus at the slit of the collimator, *i. e.*, the axis of the image of the glower coincided with that of the slit. Since the distance between *A* and *B* was 286.5 cm. and the distance between the reflector and the slit was 305 cm. (10 feet) the beam of light did not greatly exceed the width of the glower's image for a distance of 3 or 4 cm. on both sides of the precise image. Consequently, when a cell of length less than 3 cm., and so constructed as to contain two solutions separated by a very thin diaphragm, was placed in contact with the slit-jaws, any differences in the spectra of the light transmitted by the two liquids were correctly ascribed either to differences in absorptions, or to inequalities in the transparency of the ends of the compartments of the compound cell. It was possible, of course, to make the halves of the cell so nearly alike as to produce no differential influence on the transmitted beams which could be detected visually. Even if this effective equality in the compartments of the cell could not have been realized, it would have been a comparatively simple matter to have interchanged the solutions in these compartments, and to have observed the phenomena which remained constant, and which were, therefore, due to the absorption of the liquids and not to the containing-walls.

The more exact details and dimensions of the cell will now be given. The lower compartment was a box made of five rectangular strips of glass, cemented together. Its interior dimensions were: Length 2.5 cm., width 2 cm., and depth 1 cm. The upper compartment was made of four vertical glass walls cemented together at the edges, and to a sheet of platinum foil as a bottom. The interior dimensions of this little box were: Length 2.5 cm., width 0.94 cm., and depth 1 cm. The platinum foil was 0.06 mm. thick. Care was taken to make the four end pieces of glass of the same thickness and from the same sheet. These ends were parallel to each other and at right angles both to the bottoms and to the side walls of the respective compartments. Platinum was used as the partition between the boxes, since it is opaque to visible radiations, and since it is not acted upon chemically by



the solutions which come in contact with it. The foil was selected as thin as was consistent with rigidity, so as to produce as narrow a band of separation between the two transmitted portions of the main incident-beam as possible. With this same object in view, the least bit of cement was used to make the lower surfaces of the glass ends of the upper compartment adhere to the platinum. The two boxes were made separate and distinct, so as to facilitate washing, drying, etc. The lower compartment was made wider than the upper, so that when the latter was resting in position on top of the former it was a simple matter to pour a given solution into the lower compartment until it came into contact with, and wet the entire under surface of the platinum. Consequently, the liquids were as close together as the thickness of the platinum (0.061 mm.), and their spectra appeared sufficiently close together in the field of view of the telescope to admit of accurate and easy comparisons.

A suitable stand for this apparatus was fitted with leveling screws, which enabled the experimenter to adjust the cell so that the plane of the platinum partition contained the axis of the incident-beam, at the same time that the ends of the cell were perpendicular to this line.

#### FREEZING-POINT APPARATUS.

This system was of the improved Beckmann type, which can be found described in so many places that mere reference to it here is quite sufficient. The thermometer used with this apparatus was also of the Beckmann type. The smallest spaces on the stem of the thermometer signified  $0.02^{\circ}$  C., and the total range of scale was  $12^{\circ}$ .

For temperatures lower than  $10^{\circ}$  or  $11^{\circ}$  below zero, two alcohol thermometers were employed. These instruments are graduated in one-half degrees, and the lowest temperatures which they could register were, respectively,  $55^{\circ}$  and  $82.5^{\circ}$  below the standard freezing-point of water.

With the Beckmann apparatus a mixture of ice, water, and sodium chloride was used as the refrigerating agent. With the alcohol thermometers a suitable mixture of solid carbon dioxide and ethyl alcohol was employed.

#### CONDUCTIVITY APPARATUS.

The usual combination of a Wheatstone slide-bridge, with a small induction coil and telephone receiver, was used. The conductivity cell was of the U-tube pattern,\* since most of the solutions were too concentrated to give sharp tone minima in cells of less ohmic resistance. All of the measurements for this system were made at zero degrees. All necessary precautions were taken to obtain reliable data.

\*Jones and Getman: *Ztschr. phys. Chem.*, 49, 389 (1904).

## THE MAKING OF THE PHOTOGRAPHS.

## PHOTOGRAPHIC MATERIAL.\*

Because of the short radius of curvature of the focal surface (about 49 cm.), celluloid films were employed in the majority of cases. The films used throughout were M. A. Seed's "L-ortho, cut, negative films," size 5 by 7 inches. The emulsion is by no means equally sensitive over the field of wave-lengths studied photographically, *i. e.*, from  $0.20\mu$  to  $0.63\mu$ . The chief maximum of sensitiveness is in the yellow at about  $0.56\mu$ . A weaker maximum is near  $0.49\mu$ . The middle of the less sensitive intervening region was very roughly  $0.52\mu$ . For the short exposures given throughout, these films are not appreciably influenced by wave-lengths longer than about  $0.61\mu$ . Consequently, the dark regions extending from about  $0.61\mu$  to the longer wave-length end of such spectrograms as were gotten by the use of the Seed films, do not denote absence of light due to the absorption of some given solution, but they make manifest the lack of sensitiveness of the emulsion to the portion of the spectrum under consideration. The resultant effect of the Nernst glower and the Seed emulsion is best understood by referring to plate 1 (*b*), for which the times of exposure were, in order, 2 seconds, 5 seconds, 15 seconds, 30 seconds, 1 minute, 2 minutes, and 3 minutes.

Various schemes to make the resultant action from the light of the Nernst glower and the Seed emulsion more uniform were tried, and other makes of films were tested, but no improvement on the simple combination of the source of light and emulsion just named was found. In fact, other photographic films did not act as well, on the whole, as those furnished by the Seed Company. The films used were good in the ultra-violet, as is shown by the fact that with an exposure of five minutes the aluminium line at about  $0.185\mu$  was clearly recorded, in spite of the fact that the grating of the spectrograph was employed to disperse the light. When inspecting the photographs of absorption spectra, care must be taken to distinguish between possible spurious effects, arising from the maxima and minima of sensitiveness of the Seed films on the one hand, and the phenomena of true absorption on the other. Observe the apparent band in the green as shown by plate 1 (*b*).

As a check on the results obtained with the films, as well as to fill in the gap between about  $0.59\mu$  and the nearer end of the field of view of the spectrograph, Cramer trichromatic plates were used, since they were found to be the more satisfactory. The plates, being plane and too rigid to be curved around into the focal surface of the grating, had to occupy a mean position with respect to this surface. Since only a comparatively small region of

\* Uhler and Wood: Atlas of Absorption Spectra.

wave-lengths was recorded on the plates, no measurable errors were introduced. In fact, in the region considered, the second order ultra-violet of a discontinuous spectrum taken on a film and on a plate could be superposed line for line.

## SOURCES OF LIGHT.

The sources of light and the selection of photographic material best suited for spectrographic work had previously been investigated by one\* of us in an earlier research.

Nevertheless, a few words relative to these sources may not be superfluous in this place.

For wave-lengths from "above"  $0.65\mu$  to "below"  $0.326\mu$ , and for exposures of two minutes or less, the Nernst glower was found to be the most satisfactory. Prevailing circumstances made desirable the use of 106 volt glowers, on a circuit carrying about 133 cycles. The emissivity of the Nernst lamp varies so very greatly with the E. M. F. impressed upon its terminals, that it was obligatory to keep in series with the glower a Thomson A. C. ammeter, having a range from zero to two amperes, and graduated directly to 0.02 ampere. Fluctuations of more than 0.02 ampere invariably resulted in a spoiled photograph. Therefore, boxes containing variable metallic resistance were maintained in series with the ammeter, and thus, in spite of large changes of the load on the dynamo, due to other circuits, it was possible to prevent the effective current in the filament from changing by more than 0.01 ampere. The current was always 0.8 of an ampere. The ammeter was appreciably more sensitive to small changes in the terminal voltage than a comparably graduated Thomson A. C. voltmeter, because the current shunted through the voltmeter was not negligible in comparison with the current that fed the glower. Among other sources of light the electric arc was given a fair trial and discarded, for two reasons. First, because of the intensity of the carbon and cyanogen bands; and second, because of the inconveniences resulting from its unsteadiness and great emission of heat.

For wave-lengths between the strong ultra-violet of the Nernst glower and  $0.20\mu$ , a spark discharge in air of about 1 cm. in length was used. One electrode was composed of an alloy of equal parts by weight of cadmium and zinc, and the other was made of sheet brass. The alloy wore away so rapidly that the brass electrode was employed to diminish the mechanical labor attendant upon sparking the terminals. In order to produce a source of ultra-violet light that would have the same intensity from one end of the slit of the spectrograph to the other, for any one wave-length, the electrodes were made in the shape of wedges or chisels, with the sharp edges parallel to the slit. The well-known distribution of a rapidly alter-

\* Uhler and Wood: Atlas of Absorption Spectra.

nating current necessitated curving the edges of the electrodes, so that they were somewhat closer together at the middle than at the ends. Due to the tearing away of the metal and to various other causes, the innumerable thread-like sparks change the position of their ends so rapidly that the integrating action of the photographic film recorded a perfectly uniform negative for exposure of fifteen seconds or more. The electrodes had to be kept sharp and smooth, since when this was neglected the elementary sparks persisted much longer in one position than in another, and, consequently, caused streaks of varying intensity to run along the negatives parallel to their length.

The current for the spark was obtained in the following manner: An alternating E. M. F. of about 106 volts (133 cycles) was impressed on the terminals of an induction coil of unknown ratio of turns. Eight or nine amperes commonly flowed in the primary. The interrupter of the coil was thrown out of circuit, and the coil therefore performed the functions of a transformer. In parallel with the secondary was placed a Leyden jar about 18 inches high, and of unmeasured capacity. No auxiliary spark was introduced.

#### EXPOSURES AND SPECTROGRAMS.

When the complete spectrograms of a series of solutions were to be obtained the succession of operations was in general as follows:

First. The depth of the cell for plane parallel layers of solution was made such that judging from experience, and being guided by the depth of the color of the extreme solutions in their bottles, it would be neither too shallow to give appreciable absorption when the cell contained the most dilute solution, nor too deep to transmit enough light to affect the photographic plate when the liquid of deepest color was placed in the cell.

Second. A portion of each of the extreme solutions was successively poured into the cell which was, of course, clean and dry, and the corresponding spectrum observed by the aid of the spectrograph and a suitable eyepiece. In all cases, except those for which the solutions of deepest color were practically opaque to light, for all depths greater than one-half a millimeter, a depth of cell was soon found which enabled the absorption spectra of all the solutions of the series to be photographed on the same film, and with exposures of equal duration.

When fifteen or sixteen solutions belonged to one series, and this was often the case, the first eight solutions were photographed on one-half of a complete 5" × 7" negative film, and then the remaining solutions\* had their absorption spectra photographically recorded on the other half of the same film. This break in the continuity of the work was due to the fact that

\*No series comprised more than sixteen solutions,

the capacity of the camera was limited to eight spectral bands, each 6 mm. wide and spaced 0.05 mm. apart.

Except when there were some very good reasons for doing otherwise, care was taken to develop the halves of a film simultaneously, so as to subject all of the exposures to exactly the same chemical conditions. When the series of solutions comprised less than fifteen members, but more than eight, the change from one half the film to the other was generally made as soon as the number of solutions which had already been photographed, either equaled the number of those that remained, or exceeded the latter number by unity. The reason for so doing is doubtless obvious. For any one solution the exposure with the Nernst glower was made first, the screen *Q* of the spectrograph being, of course, vertical. Then this screen was set horizontal, and the spark run for a definite length of time. Usually the light from the glower was caused to pass through the absorbing liquid for one and one-half minutes, and that from the spark for one and one-third minutes. These two intervals of time were so related that when no medium exhibiting appreciable absorption was in the path of the beams of light, the photographic impressions successively produced by the radiations from the Nernst glower and by the spark, blended into each other so well that no discontinuity in the continuous background could be detected. The lengths of the exposures will be given only when they differ from 90 seconds and 80 seconds, respectively, for the glower and spark. The screen *Q* performed the function of protecting the negative film from contamination from the spectrum of the second order, which otherwise would have been superposed upon the spectrum of the first order.

As soon as the light transmitted by one solution had been recorded photographically, another solution was substituted for the preceding one, and also the film-holder was moved along by the rack and pinion system through about 6.15 mm.; that is, until a strip of unexposed film came into the field of view of the grating. This strip was at a distance of a half-millimeter or so from the region previously exposed. After all of the eight or less complete photographic strips on one half-film had been exposed, the proper opening in the slide screen or shutter *L* (see fig. 1) was brought into position and the comparison spectrum impressed.

When spectrograms were made with trichromatic plates and the cell under consideration, the sequence of events was essentially the same as that just explained, except in so far as the exposure of solutions to the light from the spark were omitted. Further, since plates of this kind are not as sensitive to orange and red light as the Seed films are to most of the more refrangible colors, the time of exposure to the glower's radiations was usually two minutes.

Since the complete description of the manner of experimenting with the wedge-shaped cell has already been given elsewhere, and especially since

a relatively small number of spectrograms were made with this cell in the present investigation, it seems desirable to discuss this matter only briefly in the present connection.

Since the length of the liquid wedge at right angles to its reflecting edge was about 3.5 cm. and as the length of the slit of the spectrograph was a little over 1 cm., the chief operation in the manipulation of the wedge-cell consisted in translating it over the slit-jaws, and parallel to the slit by proper amounts between successive exposures. Experience showed that the correct distance to move the cell was exactly 10.5 mm. The film-holder had, of course, to be moved through corresponding distances between the respective exposures just mentioned. Consequently, the resulting spectrograms consist of three photographic impressions placed side by side and close together.

The edge of a spectrogram nearest to the comparison spectrum was produced by light that had passed through the thinnest layer of absorbing liquid (usually of zero depth), while the most remote edge resulted from the radiations transmitted by the deepest layer of solution. The slit width of the spectrograph was generally 0.08 mm.

#### PLATES.

Before entering upon the presentation and discussion of the experimental results, a few words must be devoted to certain details that are common to most or all of the plates showing the absorption spectra of the solutions studied.

In the first place, when more than eight strips belong to a plate, the corresponding photographic positives had to be made by placing the two half-negatives in the printing frame, with their edges as close together as possible, and with the line of the same wave-length exactly opposite to one another, *i. e.*, in proper register. In general, the line of contact of the two half-films shows in the figures as a streak, of intensity different from that of the adjacent portions of the print, and extending from one end of the figure to the other. It is more than likely that slight errors in wave-length have been introduced in some cases by this process of reproduction, which, however, was necessitated by the limited capacity of the film-holder. In most cases these errors can be fully allowed for by observing the relative displacement of the two segments of some chosen sharp emission line, which appears on the two photographic strips lying on both sides of, and closest to the above-mentioned streak. Whenever this line of demarkation does not show distinctly on the figure, a definite statement will be made in the text as to where the change from one half-film to the other is. However, in cases where no emission lines are present on the two strips bordering on the streak, the reader has no very good means of telling whether the half-films were in exact register or not, and, therefore, he will have to assume

that no appreciable error has been introduced in this manner. Moreover, shifts in wave-lengths due to the motion of the film-holder and its guides or ways are present in most of the figures. These displacements can be measured and allowed for in the manner suggested above. It must be borne in mind that the solutions studied present such washed-out limits to most of their regions of absorption, that it is not possible to assign numbers to the wave-lengths of these boundaries, which would be nearly as accurate as the determination of the relative shifts of the parallel photographic strips. Moreover, with bands of absorption of the type just referred to, their apparent ends would be displaced in wave-length by various experimental causes, such as variations in the intensity of incident light, changes in the time of exposure to the radiations, changes in the duration of development, variations in the temperature and composition of the developer, etc. The best that could be hoped for was to obtain parallel spectrographic strips of the solutions of a given series, which exhibit the spectral changes caused by the solutions themselves, and only by the solutions; extreme care being taken to keep all other conditions as nearly constant as possible. The figures therefore show the relative changes in the absorption spectra of the solutions of one set with accuracy. Whenever there was the slightest possibility of spurious results arising from the chief maxima and minima of sensibility of the seed emulsion, the results were checked by taking additional plates with the Cramer trichromatic emulsion, which has not the same sensibility curve as the Seed film. In all cases the series of eye observations with the spectroscope not only supplement the photographic data in the red, but they also serve as an additional qualitative check on the entire visible region.

For comparatively accurate estimations of wave-lengths, one comparison spectrum of the emission lines of the spark has been reproduced in each photographic figure. The most intense and sharpest lines have been numbered in plate 1 (*a*). This plate serves as a key to the table of wave-lengths given a little later.\*

Since the spark lines of cadmium, zinc, oxygen, and nitrogen are not equally spaced, the comparison spectrum mentioned above, together with its key and table, is very inconvenient for most purposes of reference. Consequently, a numbered linear scale of wave-lengths has been printed along by the side of each complete spectrogram. Although it is not professed that these scales are as accurate as they are suggestive and convenient, nevertheless, it is only fair to call attention briefly to the chief errors possessed by them. As is well known, a concave grating gives spectra which depart more and more from normality as we recede from the principal axis of the reflector on which the lines of the grating are ruled. Therefore,

\* Uhler and Wood: Atlas of Absorption Spectra.

a strictly linear scale can not correctly register all the wave-lengths of a grating spectrum. Nevertheless, the grating belonging to the spectrograph was of such short focus that for the region of wave-lengths of the first-order spectrum used, the error just mentioned was negligible in comparison with those explained below.

It is a well-known fact that celluloid negative films, after development, fixing, and drying, differ appreciably in length from the same linear dimension which they possessed before being so treated. If all the films of one make would behave quantitatively in exactly the same way, the variations in length to which attention has just been called, would be of no importance from the present point of view. But films of the same kind change by very different amounts, and this phenomenon is inconvenient, to say the least. Therefore, to have linear scales to fit accurately each and every one of the complete spectrograms, it would be necessary to make as many different scales as there are different distances between the extreme spectral lines, say, throughout the entire series of spectrograms. Obviously, to do this would entail an amount of labor that would be utterly disproportionate to the gain in accuracy finally obtained. Consequently, only four or five negative scales of different total length were obtained by photographic production from the same paper scale, which was ruled and numbered for the present work. Since the negative scales cover the entire range of variation in length of the spectrograms, the wave-lengths of selected lines, when read off from the scales on the published plates, ought not to contain any large error.

In making the positives, the scale line numbered 48 was placed opposite to the corresponding strong emission line of the comparison spectrum. The latter line has a wave-length of about 4,800.1 Ångström units, and is designated by 73 on plate 1 (*a*). It is probable that in a few cases the two lines just named, the one on the negative scale and the other on the negative spectrogram, were displaced a little with respect to each other in the process of printing.

To avoid having the lines of the numbered scale too close together, each of the smallest intervals denotes 25 Ångström units.

The wave-lengths of the numbered lines of plate 1 (*a*)\* were derived from the two following sources:

"An Introduction to the Study of Spectrum Analysis," by W. M. Watts.

"Measurements of the Wave-Lengths of Lines of High Refrangibility in the Spectra of Elementary Substances." Hartley and Adeney. From the Philosophical Transactions of the Royal Society, Part I, 1884.

\*The negative was not a single exposure. To stand reproduction the extreme ultra-violet was "favored."



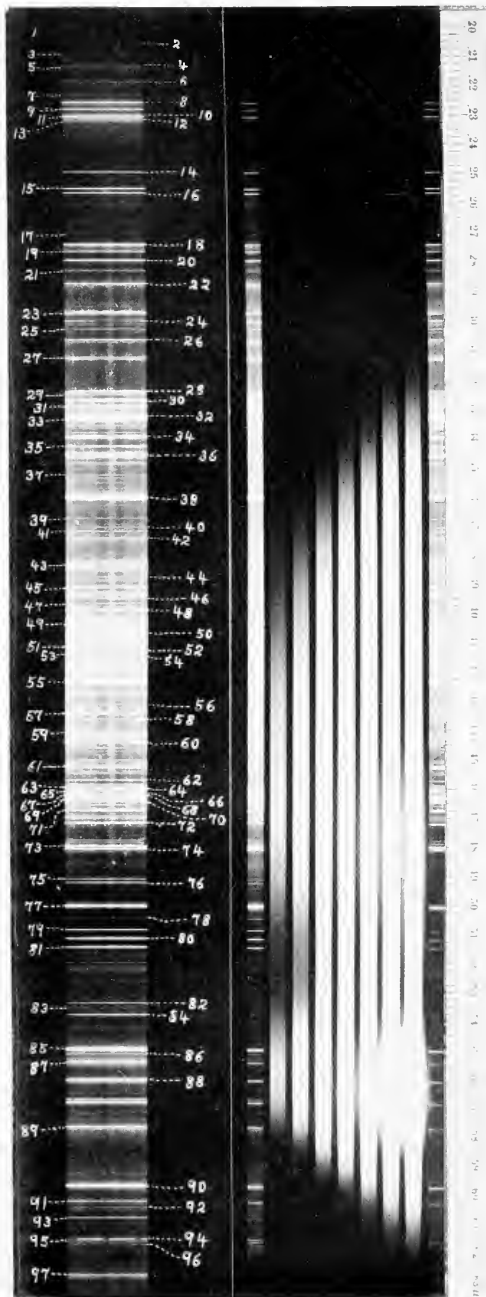

α

β



The numerical values of the wave-lengths of most of the conspicuous spark-lines are given in the subjoined table. The numbers in the first, fourth, and seventh columns are arbitrary and correspond to the like numbers of plate 1(a), thus making the identification of the wave-lengths with the spark-lines easy and unambiguous. The data in the second, fifth, and eighth columns are the wave-lengths expressed in Ångström units. The subscripts <sub>2</sub>, which affect the numbers in the last column, indicate that the associated wave-lengths appertain to spectral lines of the second order.

WAVE-LENGTHS OF REFERENCE LINES.

1	2024.2 Zn	35	3436.9 Air	62	4576.2 Cd 9 <sub>2</sub>
2	{ 2060.8 Zn	36	{ 3466.3 Cd	63	4601.6 Air
	{ 2062.8 Zn		{ 3467.8 Cd	64	4607.3 Air
3	2099.0 Zn	37	535.0 Cd	65	4614.0 Air
4	2138.3 Zn	38	{ 3610.7 Cd	66	4621.6 Air
5	2144.5 Cd		{ 3613.0 Cd	67	4626.0 Cd 11 <sub>2</sub>
6	2194.7 Cd	39	3535.0	68	4630.7 Air
7	2239.9 Cd	40	3712.2 Air	69	{ 4641.9 Air
8	2265.1 Cd	41	3726.6 Air		{ 4643.4 Air
9	2288.1 Cd	42	3749.8 Air	70	4649.2 Air
10	2306.7 Cd	43	{ 3839.3 Air	71	4680.4 Zn
11	2313.0 Cd		{ 3841.7 Air	72	4722.3 Zn
12	2321.2 Cd	44	3881.9 Air	73	4800.1 Cd
13	2329.3 Cd	45	3919.2 Air	74	4810.7 Zn
14	2502.1 Zn	46	{ 3954.8 Air	75	4912.3 Zn
15	2558.0 Zn		{ 3956.2 Air	76	4924.8 Zn
16	2573.1 Cd	47	3972.5 Air	77	{ 5002.7 Air
17	{ 2710.1 Air	48	3995.1 Air		{ 5005.7 Air
	{ 2712.6 Zn	49	4041.4 Air	78	5045.7 Air
18	2748.7 Cd	50	{ 4070.0 Air	79	5086.1 Cd
19	2770.9 Zn		{ 4072.4 Air	80	5116.0 Zn 15 <sub>2</sub>
20	2801.0 Zu		{ 4076.1 Air	81	5146.2 Cd 16 <sub>2</sub>
21	2837.0 Cd	51	4119.4 Air	82	5338.6 Cd
22	2880.9 Cd	52	{ 4132.8 Air	83	5354.4 Cd — <sub>2</sub>
23	2980.8 Cd		{ 4133.8 Air	84	5379.3 Cd
24	3007.0 Air	53	4145.9 Air	85	5497.4 Cd 18 <sub>2</sub>
25	3035.9 Zn	54	{ 4151.9 Air	86	5509.0 Zn — <sub>2</sub>
26	{ 3072.2 Zn		{ 4153.6 Air	87	5541.8 Zn 19 <sub>2</sub>
	{ 3076.0 Zn	{ 4228.5 Air	88	5602.0 Zn 20 <sub>2</sub>	
27	3133.3 Cd	55	{ 4236.7 Air	89	5761.8 Cd 22 <sub>2</sub>
28	3250.5 Cd		{ 4241.9 Air	90	5961.6 Cd 23 <sub>2</sub>
29	3261.2 Cd	56	{ 4316.2 Air	91	6014.0 Air 24 <sub>2</sub>
30	3282.4 Zn		{ 4318.7 Air	92	6035.0 Zn — <sub>2</sub>
31	3302.7 Zn	57	4349.5 Air	93	6071.8 Zn 25 <sub>2</sub>
32	{ 3329.3 Air	58	4367.9 Air	94	6144.4 Zn 26 <sub>2</sub>
	{ 3331.5 Air	59	4415.1 Air	95	6152.0 Zn 26 <sub>2</sub>
33	{ 3345.1 Zn	60	{ 4447.1 Air	96	6160.4 Cd — <sub>2</sub>
	{ 3345.5 Zn		{ 4447.2 Air	97	6266.6 Cd 27 <sub>2</sub>
34	3403.7 Cd	61	4530.1 Air		

## EXPERIMENTAL FACTS AND DATA.

In the succeeding pages the experimental material will be presented in the following order: All the facts obtained by spectrographic means, pertaining to the simple aqueous solutions containing cobalt chloride, will be given first; then those relating to cupric chloride, and finally those pertaining to cupric bromide. Following this, the solutions obtained by adding either calcium chloride, or calcium bromide, or aluminium chloride, to the simple aqueous solutions, will be taken up in the order in which the dehydrating agents have been named. For any set of solutions, the data obtained by the photographic method will appear immediately after the record of the concentrations. The results of eye observations with the spectroscope will then be presented, and following this the freezing-point lowering will be given. Conductivity data (expressed in reciprocal ohms and reciprocal centimeters) will then be presented, and, finally, attention will be called to any other facts that have been noted.

## SOLUTIONS.

The aqueous solutions investigated were made up as follows: A chosen volume of the mother-solution of a colored salt was measured out from a burette into a measuring flask of known capacity. The portion of solution in the flask was then diluted by the addition of pure\* water, until the volume of the resulting homogeneous liquid was exactly equal to the fixed capacity of the flask. The same flask was used in making up all the solutions studied throughout the entire investigation. The concentrations will always be expressed as multiples of normal. The term normal will be used exclusively to mean gram-molecular normal, *i. e.*, a liter of solution which contains just as many grams of anhydrous salt as there are units in the number expressing the molecular weight of the salt, is defined as normal. Hence, if a liquid is composed of  $n\ddagger$  gram-molecules of salt in a liter of solution, its concentration is  $n$  times normal. In general, several solutions of one set were made up with reference to their colors; in other words, in such a manner as to employ as wide a range of concentrations as could be conveniently photographed, and at the same time to bring out the delicate changes in tint, by having the successive differences in concentration as small as desirable.

When a solution contained both a colored salt and a colorless dehydrating agent, it was mixed as follows: A certain known volume of the mother-

\*This water had been distilled several times, so that its conductivity was as low as  $1.1 \times 10^{-7}$  at  $0^\circ$  C. on the average.

$\ddagger n$  can have any positive value, integral or fractional.

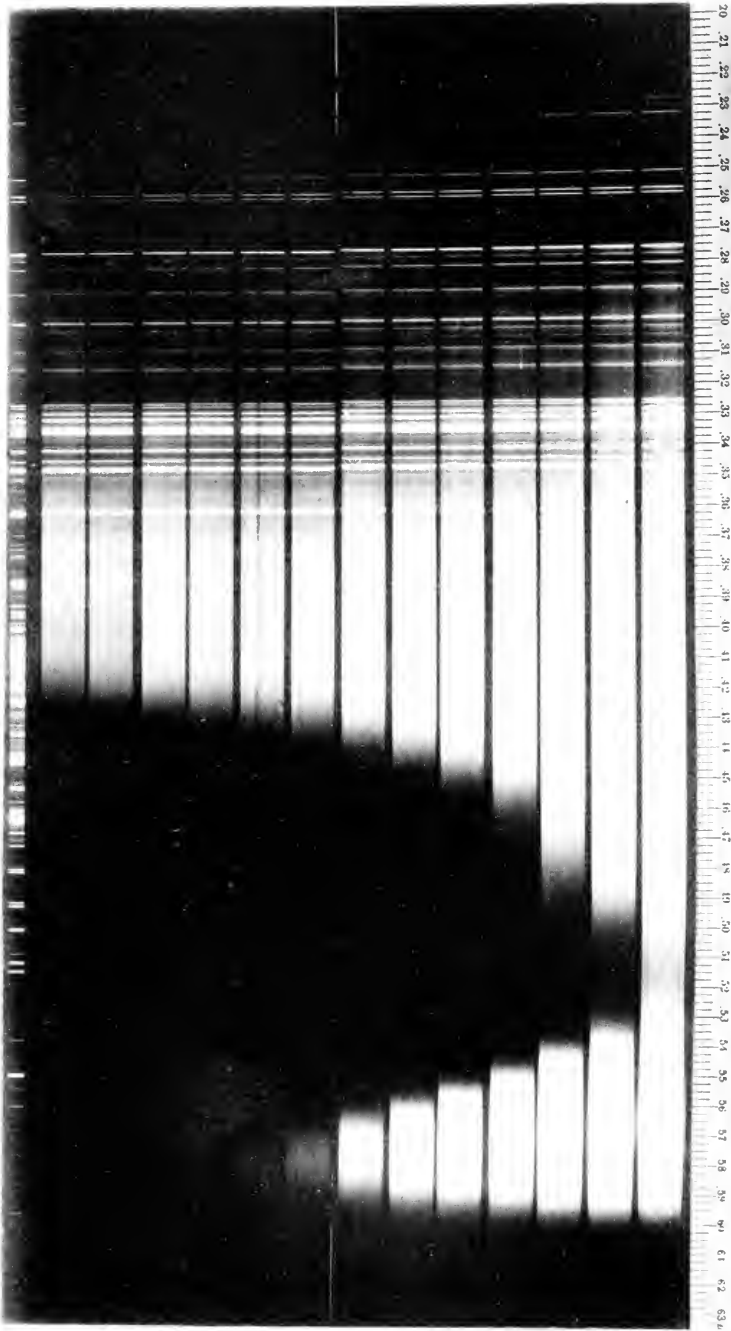



solution of the colored salt was measured out into the flask mentioned above. Then a definite volume of the mother-solution of the dehydrating agent was poured into the flask containing the colored liquid. The sum of the two volumes just specified was less\* than the fixed capacity of the flask. Finally, the mixture of the mother-solutions was made up to the full volume of the measuring flask by the addition of pure water. In a series of solutions containing the same pair of salts, two things were kept constant. First, the mass of colored salt present, and second, the total volume of the solution. The chief variable was the mass of dehydrating agent in the several solutions. As formerly, the color changes were the criteria governing the number and respective concentrations of the solutions of any one series. It was not deemed necessary to determine the specific gravities of the liquids studied. The details relating to the individual salts will not be considered.

COBALT CHLORIDE. [See plates 2, 3 (a), and 4 (b).]

The concentrations of the solution were 0.217, 0.379; 0.542; 0.759, 0.976; 1.192; 1.409; 1.626; 1.843; 2.060; 2.276; 2.493, and 2.170. Therefore, the first two increments of concentration were each equal to 0.1626, and each of the remaining successive differences equal to 0.2168.

The number 2.710 belongs to the mother-solution of cobalt chloride. The color of the liquids increased in depth from a delicate pink or rose color to a very dark red. In layers of more than about a centimeter in thickness, the more concentrated solutions were opaque to ordinary light. The solution whose concentration was 0.217 normal gave the absorption spectrum shown by the photographic strip nearest to the numbered scale of plate 2. The next strip corresponds to the concentration 0.379, etc., across the spectrogram. Thus, the strip nearest to the comparison spectrum is associated with the mother-solution. The common depth of the absorbing layers of liquid was 0.67 cm. The line of separation of the half-films comes between the seventh and eighth photographic strips, counting from the side of the numbered scale. The spectrogram shows two regions of absorption, the one in the remote ultra-violet and the other in the blue and green.

The most dilute solution transmitted the line at 2138.3, but nothing of shorter wave-length.†

The background stops at about 2265. The most concentrated solution barely transmitted the line of wave-length 2502.1, and cut out practically all the continuous background which is more refrangible than 2748; due regard being had for the successive increments of concentration of the solution. For the most dilute solution, the maximum of absorption in the

\* In special cases shrinkage in volume on mixing would make this statement slightly inexact.

† All numerical data were derived from the negatives and not from the plates.

green was at about  $0.515\mu$ . The general contour of the limits of ultra-violet transmission can best be understood by referring to plate 2. The region of absorption encroached on the shorter wave-lengths more rapidly than on the longer ones. The asymmetry of the region may be due to the superposition of two close, unresolved bands, of which the more refrangible was the weaker. For the seventh solution (of concentration 1.409), the middle of the photographic region for absorption was at  $0.503\mu$ . The more refrangible end of this band was at about  $0.432\mu$  for the more concentrated solution.

The absorption spectra of the five most concentrated solutions were photographed with a red sensitive plate, and the result is reproduced as plate 3 (a). The depth of cell was 0.67 cm., as before, but the exposure with the Nernst filament was two minutes in length. The photographic limits of absorption of the solution of concentration 1.843 were about  $0.438\mu$  and  $0.565\mu$ ; while those for the mother-solution were about  $0.427\mu$  and  $0.585\mu$ .

The apparent displacement of the middle of the band from  $0.502\mu$  to  $0.506\mu$ , with increasing concentration, is probably due to weak photographic action in the neighborhood of the less refrangible end of the absorption band of the most concentrated solution. Moreover, the negative plate was undeveloped.

Plate 4 (b) shows the continuous variation with thickness of the absorption of the mother-solution of cobalt chloride. The solution was placed in the wedge-cell and hence the depth varied linearly. To bring out the band in the blue-green, zero depth of absorbing layer could not be used. The least and greatest depths of liquid were 0.53 mm. and 1.09 mm., respectively, and the angle of the cell was  $58.5'$ . As usual, the side of the spectrogram corresponding to the least depth of the liquid lies nearest to the comparison spectrum. The band in the blue-green has its center about  $0.520\mu$ . It seems to be slightly asymmetric, but this appearance is doubtless exaggerated by the great sensitivity of the Seed film to yellow light. The end of the band in the extreme ultra-violet varies slightly with increasing thickness of absorbing layer. Faint transmission begins about  $0.245\mu$ .

A negative taken\* with the cell set at an angle of  $35.1'\dagger$  and commencing at zero depth, showed practically no band in the green, but it did show a definite curved line of absorption in the remote ultra-violet. A general idea of the course of this curve can probably be gathered from the following statements: The least trace of the zinc doublet at 2062 A. V. was shown at the very edge of the negative. The spectral lines of wave-length 2144.5 and 2194.7 jugged out from the edge of the spectrogram through distances

\* Not reproduced for publication.

† Greatest depth equaled 0.32 mm.



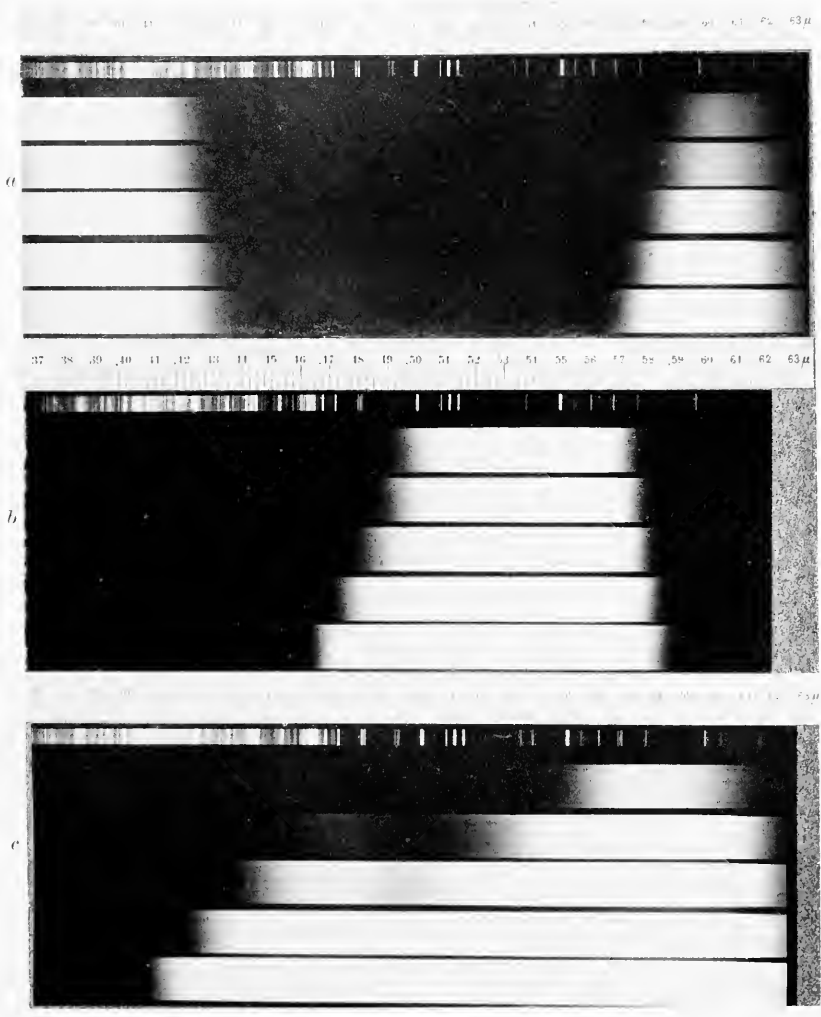

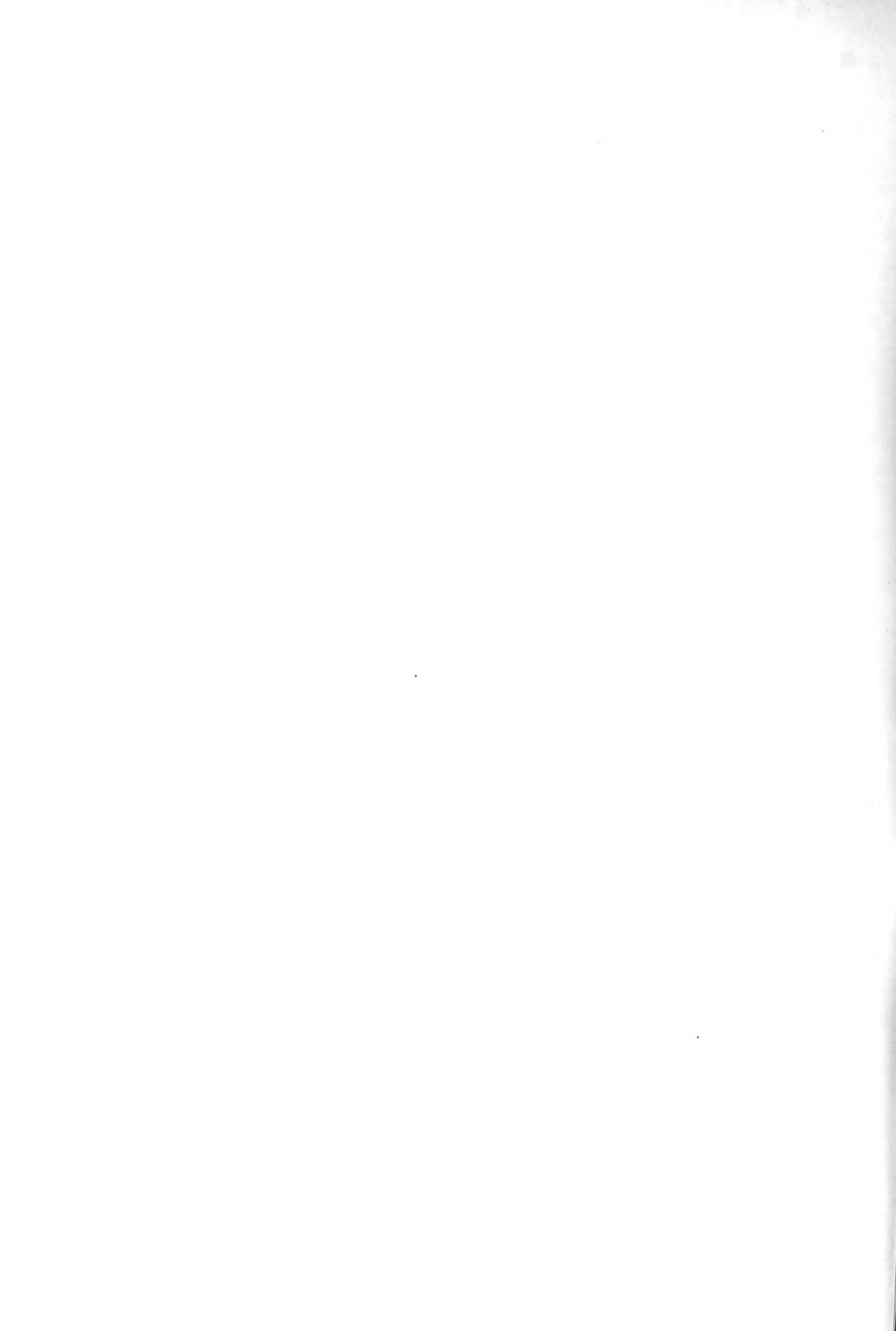

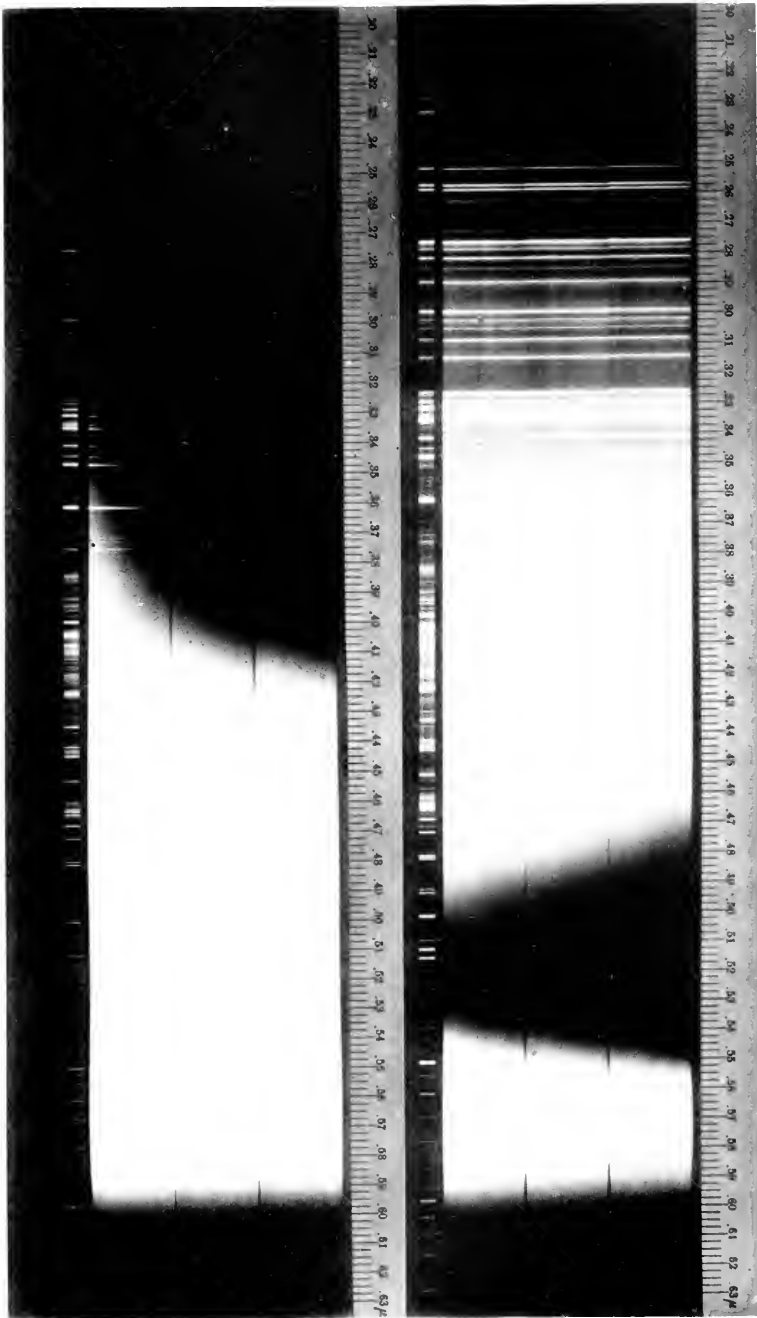

*a*

*b*



of, approximately, 6 and 9 mm. The continuous background ended at  $0.238\mu$ , on the edge of the negative corresponding to the greatest depth of solution in the wedge.

Eye observations with the spectroscope showed the facts recorded below. The depth of the cell was the same as when photographic exposures were being made. For the solution of concentration 0.217 the spectrum began at about  $0.775\mu$ . No bands were visible in the red. The band in the blue-green was very faint and diffuse.

The solution of concentration 0.759 also showed no bands in the red. The most intense absorption seemed to be at  $0.525\mu$ , but the blue-violet side of the region was so much more diffuse\* than the yellow side, that not much importance should be attached to this number. However, the spectroscopic observations confirm qualitatively the spectrographic results.

No bands could be seen in the red for the solution of concentration 1.409, and absorption was complete from about  $0.558\mu$  to about  $0.450\mu$ .

The violet has greatly dimmed.

Similarly, the solution of concentration 2.060 exhibited no bands in the red. The band in the midst of the visible region extended from  $0.571\mu$  to, roughly,  $0.448\mu$ . As previously, the end of the band nearer the yellow was much more definite than the end in the indigo. The violet was rather faintly transmitted.

The mother-solution showed a series of weak bands in the red. Only the orange and certain parts of the red were transmitted, and the light was considerably weakened even in these regions. It would seem at first sight that the last statement is inconsistent with the wave-length  $0.432\mu$ , which the spectrogram gives as the extreme least refrangible boundary of the region of transmission in the ultra-violet and violet, when the well-known fact that the average normal eye is sensitive to waves at least as short as  $0.400\mu$ † is taken into account. The apparent discrepancy is easily accounted for by the following considerations: The photographic film exerted an integrating action over a period of ninety seconds, whereas the retina does not add up successive stimuli of the same spot for nearly so long a time. Moreover, the dispersion of the spectroscope in the violet was much greater, and the spectrum no brighter than that of the grating in the same region. The spectrum began about  $0.773\mu$ . From this point the intensity of transmission rose gradually to a maximum, and then decreased to a faint minimum at  $0.714\mu$ . This faint absorption band was followed by another one at  $0.676\mu$ . The spot of maximum brightness between these bands was at about  $0.669\mu$ . Between  $0.67\mu$  and  $0.59\mu$  the incident light had suffered less general absorption

\* Due allowance has been made for the fact that with a simple prism the dispersion increases as the wave-length decreases.

† Under the prevailing conditions the observer could see the air-line at 3995.1 with certainty.

than anywhere else in the visible spectrum, with the exception that a faint narrow absorption band was just noticeable at  $0.636\mu$ . Transmission ceased at about  $0.588\mu$ .

CUPRIC CHLORIDE. [See plates 3 (b), 4 (a), and 5.]

The concentrations of the solutions were 0.239, 0.318, 0.557, 0.795, 1.113, 1.272, 1.431, 1.590, 1.749, 2.067, 2.385, 2.703, 3.021, 3.339, 3.657, and 3.976. The successive differences in concentration were 0.079, 0.239, 0.239, 0.318, 0.159, 0.159, 0.159, 0.159 for the first nine solutions, and 0.318 for all the rest. The last number belongs to the mother-solution of copper chloride.

The color of the most dilute solution was a delicate blue. Then, as the concentration increased, the color of the solutions passed through various shades of greenish-blue, of bluish-green, of light green, and finally the mother-solution was a deep, dark green.

Plate 5 will be considered first. The solution whose concentration was 0.239 normal has its absorption spectrum shown by the photographic strip nearest to the numbered scale. The remaining strips succeed one another in the order of increasing concentration, so that the strip nearest to the comparison spectrum corresponds to the mother-solution. The effective depth of the cell was 0.67 cm. Ninety seconds and eighty seconds were the respective times of exposure of the Nernst glower and of the spark.

The spectrogram shows two regions of absorption, the one in the ultra-violet, violet-blue, etc., and the other in the orange. Absorption in the region last named is to be inferred from the fact that the ends of the photographic strips corresponding to the more concentrated solutions do not lie in a straight line at right angles to the length of the spectrogram, but recede from the end of the plate as the concentrations increase.

If there has been no strong selective absorption in the yellow-orange, then all the photographic strips would have faded out at the same distance from the end of the plate, due simply to the lack of sensitivity of the Seed negative films to light of relatively small refrangibility. The most dilute solution transmitted a faint trace of the spark line at wave-length  $3250.5$ , but nothing of shorter wave-length. The absorption of the solution of concentration 0.318 was very little more extended than that of the most dilute member of the series.

This is due to the fact that these two solutions did not differ greatly in concentration. To obtain the clearest view of the variation of absorption with concentration, it is best to fix the attention only upon those photographic strips that correspond to the solutions whose concentrations differed by the same amount, *e. g.*, by 0.318. In other words, omit the first, second, third, sixth, and eighth strips from consideration for a moment. It is then seen that a smooth curve is presented by the limits of the region which absorbs

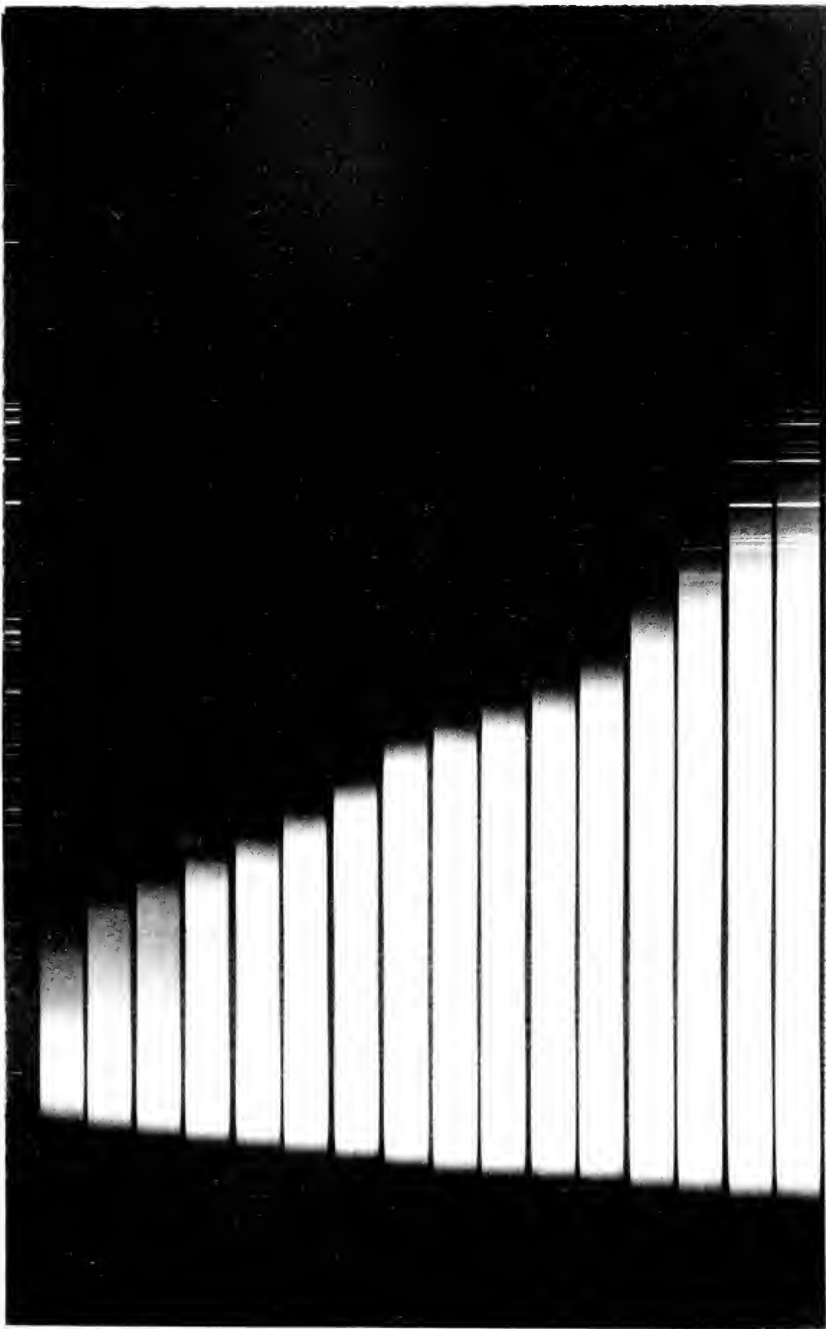

20  
21  
22  
23  
24  
25  
26  
27  
28  
29  
30  
31  
32  
33  
34  
35  
36  
37  
38  
39  
40  
41  
42  
43  
44  
45  
46  
47  
48  
49  
50  
51  
52  
53  
54  
55  
56  
57  
58  
59  
60  
61  
62  
63





all of the shortest waves of light. Also the successive increments of absorption become less and less as the concentrations of the solutions increase. For example, the seventh photographic strip ends about 200 Ångström units farther along than the fifth strip, the twelfth 90 units beyond the eleventh, and the sixteenth 55 units beyond the fifteenth. The region of transmission for the mother-solution extended from about  $0.483\mu$  to  $0.574\mu$ .

The negative for plate 3 (b) was obtained with a Cramer trichromatic plate. The exposure for each of the five most concentrated solutions was two minutes in length. The depth of the cell was 0.67 cm., as before. This spectrogram shows correctly the limits of transmission not only at the blue side, but also towards the red; since the photographic plate would have been made deep black as far as its very ends, if the light had not passed through the absorbing layers of liquid. The limits of the region of transmission for the solution whose concentration was 2.073 were  $0.460\mu$  and  $0.593\mu$ , while the corresponding numbers for the mother-solution were  $0.485\mu$  and  $0.583\mu$ . Therefore, the rate of increase for absorption is greater at the more refrangible end of this region than at the less refrangible end. In fact, the middle of the transparent region shifted towards the red by about 75 A. U. as the concentration increased from 2.073 to 3.976.

Plate 4 (a) was taken with the wedge-cell set at an angle of  $19.5'$  and starting with nearly zero depth. Times of exposure were ninety seconds and eighty seconds with the Nernst filament and spark, respectively. The thinnest layer transmitted a trace of the cadmium line at 3133.3. The boundary of the ultra-violet region of absorption then curved around as is shown by plate 4 (a), and reached about  $0.400\mu$ , corresponding to the thickest part of the wedge. The great intensity of the ultra-violet absorption is worthy of note.

Eye observations fully confirm the results obtained by the photographic method. For the most dilute solution, transmission began at about  $0.727\mu$ , *i. e.*, in the bright red. As more and more concentrated solutions were observed, the absorption at the red end of the spectrum extended gradually to shorter and shorter wave-lengths. The following numbers were recorded as the wave-lengths of the extreme limits of visual transmission for the first, fourth, seventh, tenth, twelfth, fourteenth, and sixteenth solutions, named in the order of increasing concentration, *viz.*,  $0.727\mu$ ,  $0.677\mu$ ,  $0.646\mu$ ,  $0.634\mu$ ,  $0.624\mu$ ,  $0.616\mu$ , and  $0.660\mu$ , respectively. The reasons why the eye observations agree qualitatively, but not quantitatively, with the photographic results scarcely need explanation. The limits of the more refrangible ends of the regions of transmission of the solutions, as obtained with the spectroscope, are not as satisfactory as the results gotten photographically, for the reason that the absorption fades away very gradually in the part of the spectrum under consideration. Therefore, no more wave-lengths will be given for the simple solutions of copper chloride in water.

## CUPRIC BROMIDE. [See plates 3 (c), 6, and 7 (a).]

The concentrations of the solutions photographed were 0.175, 0.350, 0.394, 0.437, 0.481, 0.525, 0.568, 0.612, 0.656, 0.700, 0.874, 1.049, 1.224, 1.399, and 1.574. The first, second, sixth, and tenth solutions, as well as those having greater concentrations than the tenth, form a series in which the successive concentrations differ by the same amount, namely, by 0.175. The remaining solutions were interpolated in the series just mentioned, and the successive increments of concentration thus produced are all equal to 0.044, *i. e.*, to one-quarter of the greater common difference 0.175. In this case the concentration of the mother-solution was 2.186. The solutions when in the plane parallel cell, which was adjusted at a depth of 2 mm., varied from almost no color for the most dilute solution, through different shades of clear green and yellowish-green, to a very dull brownish-green for the solution of concentration 1.574. In the bottles, of course, the colors were much deeper than in the cell, and the more concentrated solutions of the set photographed, together with the mother-solution, were apparently opaque to light.

In plate 6, as usual, the photographic strips showing the absorption spectra of the solutions of concentration 0.175 and 1.574 are adjacent, respectively, to the numbered scale and to the comparison spark spectra. The fifteen strips succeed one another in the order of increasing concentration. The most dilute solution transmitted an extremely faint trace of the line at 3250.5, but nothing of shorter wave-length. Due regard being had for the successive differences in concentration, it is seen from the spectrogram that the region of absorption which includes the ultra-violet increases in a perfectly regular way for about the first twelve solutions. The thirteenth strip begins to show weak absorption at about  $0.517\mu$ , and the fourteenth brings out the presence of this band very noticeably. The long, penumbra-like region which extends from about  $0.45\mu$  to  $0.53\mu$  on the fourteenth strip is entirely absent from the fifteenth. The shortest wave-length recorded by the spectrogram for the most concentrated solution is approximately  $0.543\mu$ . The last three or four photographic strips, which correspond to the more concentrated solutions, indicate the presence of a region of weak general absorption in the orange and red. In drawing conclusions from spectrograms of solutions of copper bromide, care must be taken to avoid errors that might arise from the maxima and minima of sensitivity of the photographic emulsions, especially when Seed orthochromatic films are involved. [See plate 1 (b).]

The statements made above are substantiated for the five most concentrated solutions by plate 3 (c), the negative for which was a trichromatic Cramer plate. The cell was adjusted to a depth of 2 mm. as before, and the length of each exposure to the light from the Nernst glower was two minutes. That the absorption in the orange-red is weak, in general, is shown by the

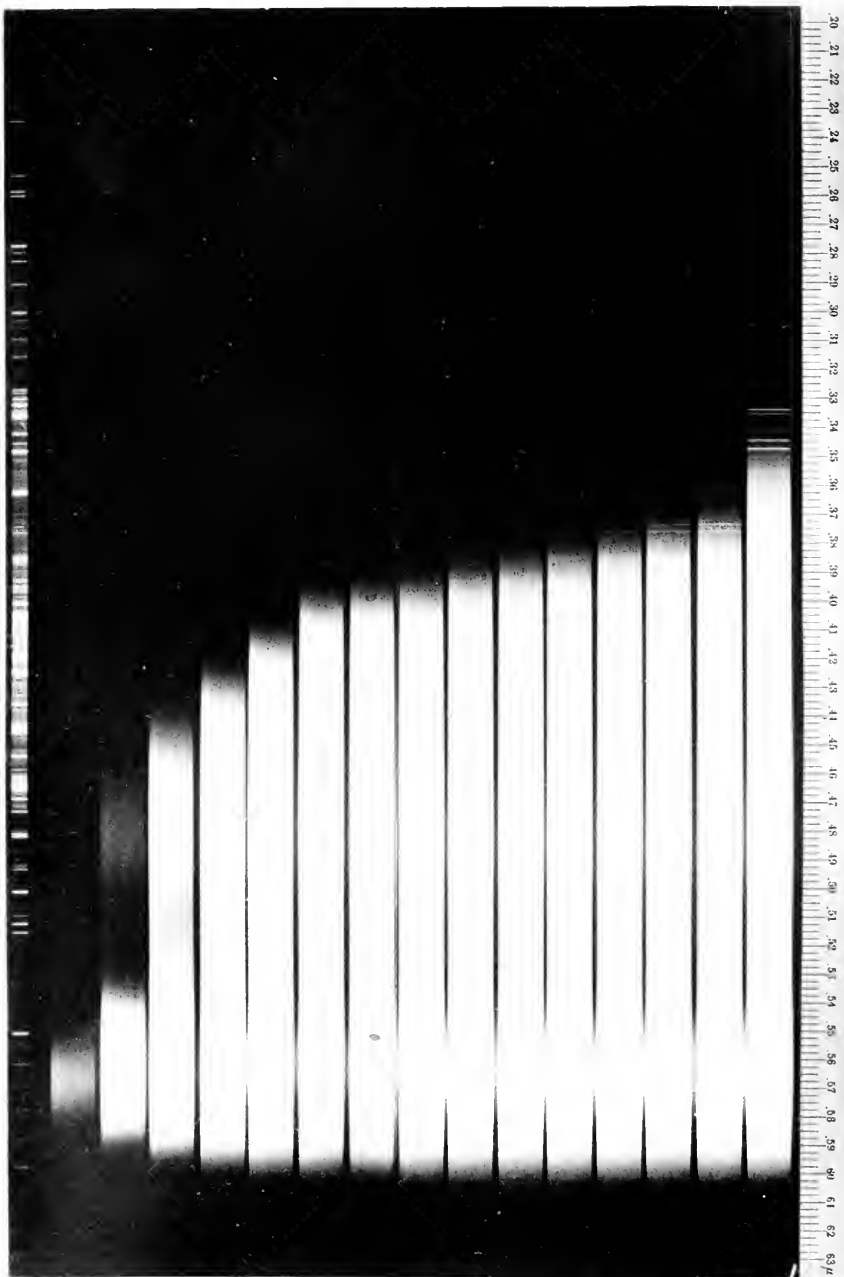



fact that four of the five photographic strips of the negatives were blackened, to a greater or less degree, as far as the end of the field of view of the camera; while the fifth strip was very faint at this limit.

On plate 3 (*c*) the penumbra mentioned above is clearly shown by the third and fourth strips, counting from the sides of the spectrogram adjacent to the numbered scale. Also the fifth strip shows no sign of this region of weak transmission, as was also the case with the fifteenth strip in plate 6. The shortest wave-length recorded on the negative plate 3 (*c*) for the most concentrated solution was  $0.541\mu$ .

The dependence of the limits of absorption upon thickness of layer for the mother-solution of copper bromide was shown graphically by plate 7 (*a*). The angle of the wedge-cell was  $27.3'$  and the depth of solution varied linearly from about zero to 0.25 mm. In the deeper portions of the cell the solution appeared dull brown. The washed-out band in the blue-green was observed with the eyepiece, and hence its presence on the spectrogram is not due to the photographic film alone. As for the chloride of copper, so also for the bromide, the absorption of the ultra-violet is very strong. The shortest wave-length recorded on the negative for the least depth of liquid is  $3250.5$  A.U., and that for the greatest depth is about  $0.438\mu$ . Plate 7 (*a*) shows the boundary of the ultra-violet band sufficiently well to make further comment on this region superfluous. The band in the green has its middle roughly at  $0.518\mu$ . The fact that the ends of the photographic strips resulting from the three successive exposures, which ends are in the vicinity of  $0.597\mu$ , suggest a straight line that slants with respect to the length of the spectrogram, calls attention to the general absorption of the least refrangible portions of the spectrum.

The following facts were obtained by eye observations with the spectro-scope, the cell having the same depth as above: The numbers recorded for the limits of transmission in the red for the first, third, fifth, seventh, ninth, eleventh, thirteenth, and fifteenth solutions named in the order of increasing concentration were  $0.750\mu$ ,  $0.730\mu$ ,  $0.725\mu$ ,  $0.720\mu$ ,  $0.712\mu$ ,  $0.707\mu$ ,  $0.690\mu$ , and  $0.680\mu$ , respectively. Since the band in the red has a diffuse end in the visible spectrum, the data just given are useful only in so far as they indicate roughly the progressive increase of absorption with the like variation in concentration, but they are not to be considered as very accurate. The wave-lengths of the limits of absorption of the band which extends from the ultra-violet into the visible spectrum, as obtained for the solutions mentioned in the above list, agree qualitatively with those derived from the spectrograms, and since the former are less reliable than the latter they will not be given here. Special attention, however, was given to the solutions of concentration 1.224 and 1.574, in order to find out whether there were any abrupt changes in the absorption of the more concentrated solutions of the series,

since the spectrograms of plates 3 (c) and 6 seemed to indicate a change of this kind. In the spectroscope the solution of concentration 1.224 appeared to transmit a spectrum which commenced at about  $0.690\mu$ , rose gradually to a maximum of transmission, then decreased to about half the maximum intensity near  $0.500\mu$ , and finally faded away very gradually to zero value in the neighborhood of  $0.447\mu$ . This type of variation in intensity, which is likewise characteristic of the solution of concentration 1.399, is shown correctly by the photographic strip next to the last, both on plate 3 (c) and on plate 6, only in so far as a weak penumbra is indicated for the green and blue; but the eye did not detect a maximum of general absorption followed by slight increase in intensity of transmission as shorter and shorter wavelengths were observed, as would be inferred from the photographic strip in question.

Furthermore, the spectrum of the most concentrated solution of the set began at about  $0.680\mu$ , rose slowly to a maximum of transmission at  $0.608\mu$ , decreased gradually for a certain distance, then fell off rather abruptly near  $0.545\mu$ , and finally faded away to invisibility in the vicinity of  $0.495\mu$ . The colors which were transmitted clearly enough to be recognized, *i. e.*, bright red, orange, yellow, and green, were greatly weakened in intensity as compared with that of the light incident upon the absorbing layer of solution.

The region of very weak transmission between  $0.545\mu$  and  $0.495\mu$  was not shown by the negative from which plates 3 (c) and 6 were reproduced. The conclusion to be drawn, then, is that there was no abrupt change in the general characteristics of the regions of absorption and of transmission of the several solutions of copper bromide studied, and that the lack of complete agreement between the results obtained, on the one hand by the photographic method, and on the other by observations in the case of the two solutions of greatest concentration, was due to the fact that certain parts of the spectra transmitted were of too feeble intensity to affect the photographic film or plate either at all or in a correct manner. Thus, the case of copper bromide furnishes a good illustration of the desirability, if not of the necessity in general, of supplementing photographic work by eye observations.

COBALT CHLORIDE AND CALCIUM CHLORIDE. [See plates 8, 9 (a), and 9 (b).]

The spectrogram of plate 8 will be first discussed. The concentration of the cobalt chloride in all of the solutions is a constant 0.271. The concentrations of the calcium chloride were 0.000, 1.676, 2.514, 2.724, 2.849, 2.919, 3.007, 3.128, 3.336, and 3.765. These solutions were made up so as to show successive color changes which, judged by the eye, were as uniform as possible. The colors themselves varied from clear red to deep blue, passing through intermediate shades of garnet, purple, violet, etc.,

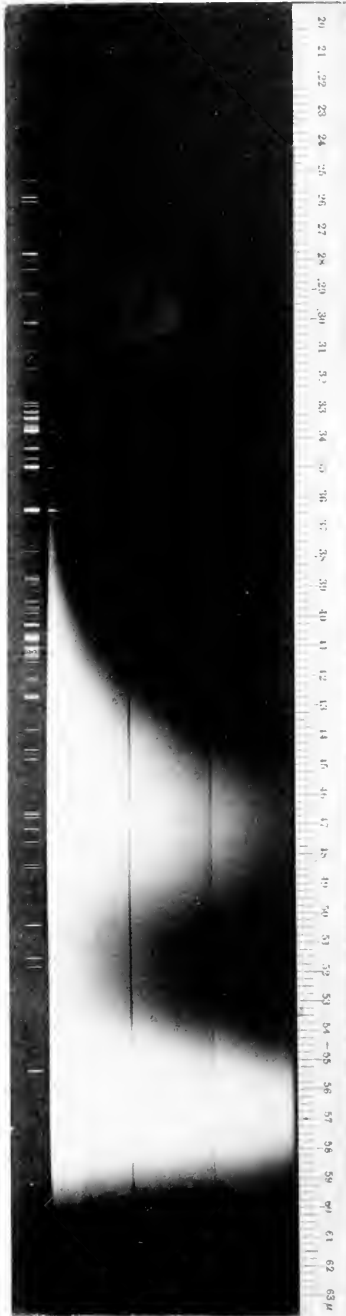

*a*

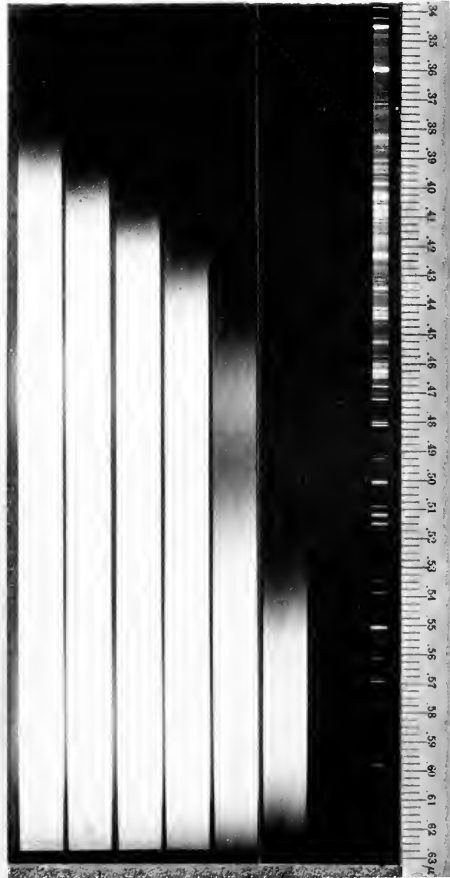

*b*





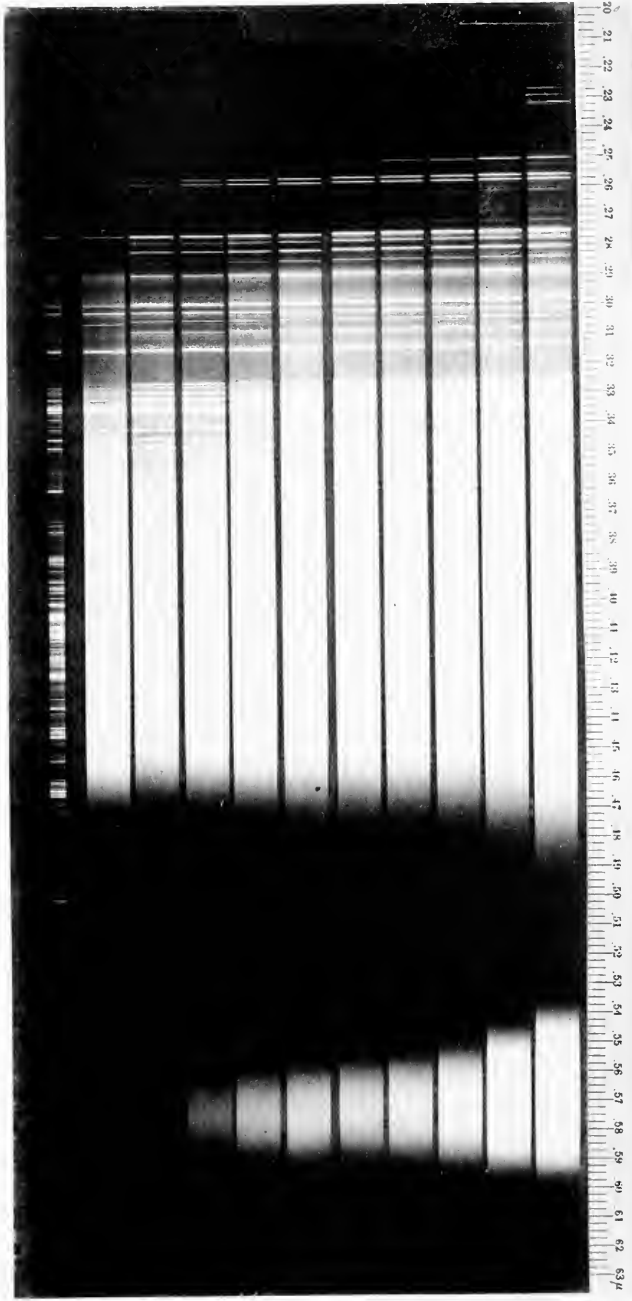



The strip corresponding to the solution that contained no calcium chloride appears next to the numbered scale, while the strip associated with the solution which had the greatest concentration in calcium chloride lies closest to the comparison spectrum. The depth of the cell was 1.41 cm. The line of separation for the half-films lies between the fifth and sixth photographic strips.

These regions of absorption are shown by the spectrogram. One of these is in the extreme ultra-violet, another is in the green, and a third is in the orange and red. The solution of cobalt chloride alone was unusually transparent to short waves of light, transmitting the spark line at 2265.1. The negative showed no shorter wave-lengths. The band in the ultra-violet gradually extended to longer waves, as the concentration of calcium chloride increased. For example, the ninth solution transmitted the line of wave-length 2258.0, but nothing more refrangible, and the continuous background did not persist quite as far as to the spark line last mentioned. The line spectrum of the strip adjacent to the spark scale is not comparable with the other strips, because the Leyden jar broke down in the course of the exposure. This accident had no influence, of course, on that part of the tenth strip, which was obtained by the use of the Nernst filament. The marked lack of intensity of the comparison spectrum was due to the same break. The band in the green extended from about  $0.505\mu$  to  $0.530\mu$ , as shown by the negative for the solution containing no calcium chloride. This band widened out more and more as the concentration of the calcium chloride increased. At the same time, general absorption was present on the orange side of the band, and not on the blue side. This fact, together with the one to be discussed below in connection with the eye observations, namely, that there were bands of continually increasing width in the red, accounts for the change in the resultant color from red to blue when the calcium chloride was added to the solution of cobalt chloride.

Plate 9 (*b*) shows the variation of the absorption of solutions of cobalt chloride and calcium chloride, when the successive increments of concentration were all equal. The electrical conductivities of these solutions were also measured, as will be seen later. The constant concentration of the cobalt salt was 0.271, and the concentrations of the calcium chloride were 0.000, 0.325, 0.650, 0.974, 1.299, 1.624, 1.950. The common difference used in the calculation was 0.3248. The concentrations of mother-solutions of cobalt and of calcium chloride were, respectively, 2.71 and 4.06 normal. The solution which contained the greatest amount of calcium chloride has its photographic strip adjacent to the comparison spectrum. The depth of the cell was the same as for plate 8.

The region of absorption in the ultra-violet widened out from 2194.7 to about  $0.245\mu$ , when the extreme strips were measured. The limits of the

band in the green increased linearly with the like change in the concentration of the calcium chloride. Also the center of this band remained at the same wave-length  $0.518\mu$  for the seven solutions under consideration.

Plate 9 (*a*) gives the absorption spectra of another set of solutions containing the chlorides of cobalt and of calcium. These solutions were made up of such concentrations as to contain the same number of chlorine atoms as the corresponding solutions of a set in which aluminium chloride was the dehydrating agent, instead of calcium chloride. The reasons for this will be discussed later when the facts about the spectra of aluminium chloride are given. Plate 9 (*a*) supplements plate 9 (*b*) from the standpoint of concentration, and also because of the circumstance that the solutions of both of these spectrograms have their conductivity data collected in one table and in a single curve in a later section. The concentration of the cobalt chloride was 0.271, as before, and the concentrations of the calcium chloride were 0.000, 1.676, 2.091, 2.515, 2.671, 2.830, 3.143, 3.555. Therefore, the differences of first order were 1.676, 0.415, 0.524, 0.156, 0.159, 0.313, 0.412. The depth of the absorbing layer, the times of exposure, and the relative positions of the photographic strips are the same for plate 9 (*b*) as for plate 9 (*a*). The negative for 9 (*a*) shows a faint trace of the spark line at 2194.7 A. U. and 2573.1 A. U. for the strips associated, respectively, with the solutions of least and greatest concentration in the calcium salt. The continuous background does not extend quite as far as the wave-lengths just given, especially in the case of the most concentrated solution. The general absorption in the yellow and orange is brought out clearly by the eighth strip.

The question as to how much of the absorption in any given mixture of solutions is to be ascribed to the colored salt, and how much is due to the dehydrating agent, will be taken up immediately after the other matters pertaining to the solutions containing cobalt chloride, together with either calcium chloride, or calcium bromide, or aluminium bromide, shall have been discussed.

The most important facts brought out by the observations of the bands in the orange and red were the following. It is not necessary to give here the data relative to the band in the green, since they confirm in detail the results obtained photographically, and the latter as shown by the spectrograms.

The solutions studied with the spectroscope were the ones which accompany plate 8. The depth of cell used was 2.5 cm. With distilled water in the cell, the red end of the spectrum appeared to begin at about  $0.775\mu$ . The solution containing only cobalt chloride, as well as the one having the concentration 1.676, showed no absorption in the red. For the solution of concentration 2.514 of the calcium salt, two very faint flutings of intensity showed their maxima of absorption at  $0.697\mu$  and  $0.661\mu$ . By moving the

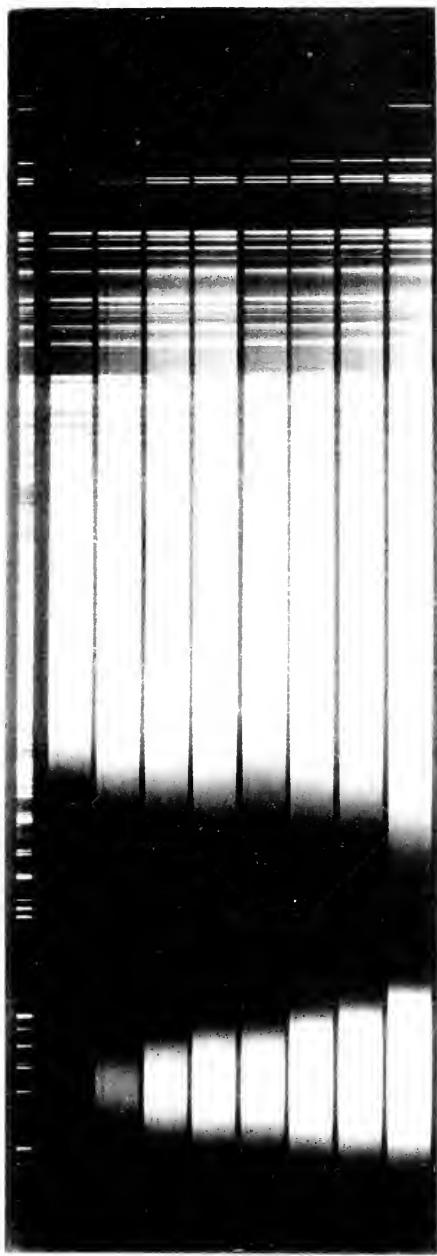

20 21 22 23 24 25 26 27 28 29 30 31 32 33 34 35 36 37 38 39 40 41 42 43 44 45 46 47 48 49 50 51 52 53 54 55 56 57 58 59 60 61 62

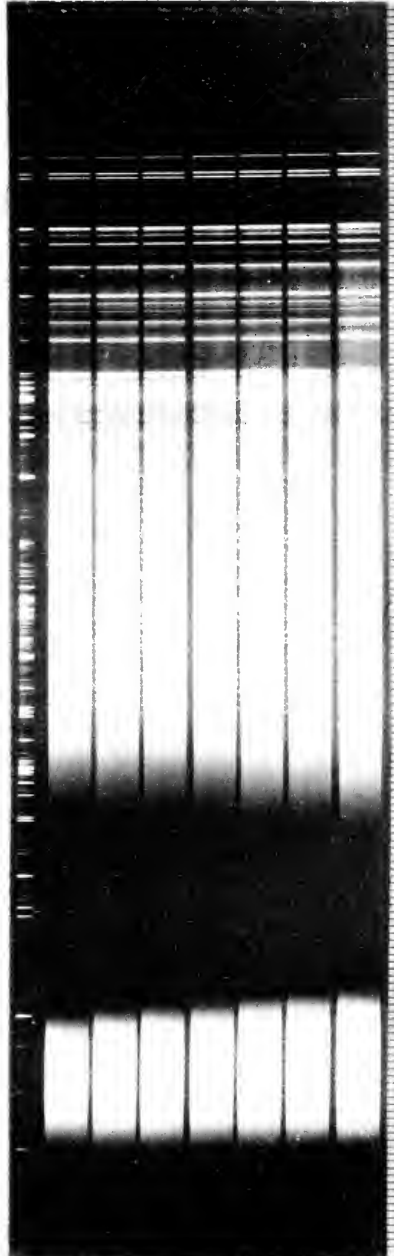

20 21 22 23 24 25 26 27 28 29 30 31 32 33 34 35 36 37 38 39 40 41 42 43 44 45 46 47 48 49 50 51 52 53 54 55 56 57 58 59 60 61 62

a

b



spectrum across the field of view, it was barely possible to see two extremely faint bands which were quite narrow, and which were situated at the shorter wave-length side of the band at  $0.662\mu$ . They were too faint, however, to set upon with the cross-hair. The next solution in order of concentration 2.274 began to transmit faintly at  $0.770\mu$ . The bands at  $0.697\mu$  and  $0.661\mu$  were more intense than before. A faint band appeared at  $0.624\mu$  and a very faint one at  $0.609\mu$ . An extremely faint narrow band between the two just mentioned could be seen with great difficulty.

A general idea of the appearance of the successive regions of transmission and absorption for the solution of concentration 2.849 is given in fig. 71. The abscissæ denote wave-lengths and the ordinates show estimated intensities of transmission. The centers of the red regions of greatest transparency were, respectively,  $0.726\mu$  and  $0.675\mu$ . One absorption band was at  $0.697\mu$  and the center of the next band was at  $0.661\mu$ . The entire region from  $0.767\mu$  to beyond  $0.660\mu$  had the appearance of a weak flat band with two maxima of absorption, the one at  $0.697\mu$  and the other at  $0.661\mu$  superposed upon it. The absorption at  $0.697\mu$  was more intense than at  $0.661\mu$ . Beyond  $0.661\mu$  the general transmission

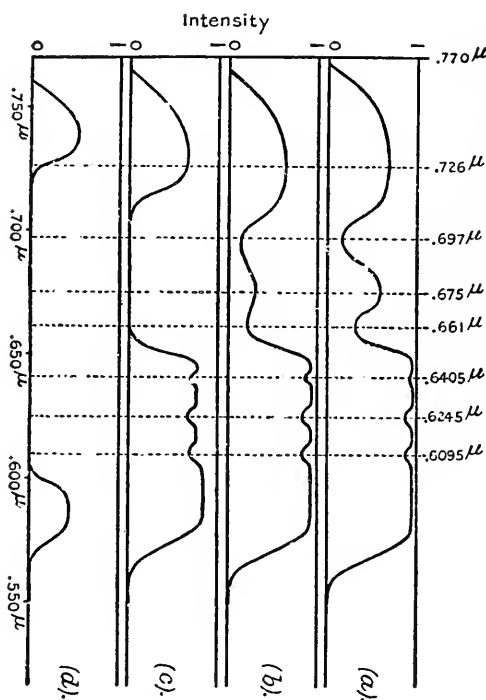

FIG. 71.

was uniformly strong, but not as intense as when the cell contained water alone. The narrow band at  $6405$  was very faint. The next narrow band had the position given by  $6245$ . This band was slightly more intense than the one at  $6095$ . The wave-length of the latter was  $6095$ . The last two bands had about the same width. The spectrum of the solution whose concentration in calcium chloride was 2.919, did not differ enough from that of the solution just discussed to merit further comment. For the solution of concentration 3.007 the band at  $0.697\mu$  extended from  $0.706\mu$  to  $0.686\mu$ . The bright region lying between the bands between  $0.661\mu$  and  $6405$  began at  $0.655\mu$ ; that is, the band  $0.661\mu$  ended rather abruptly at the same wave-

length. In all other particulars the spectrum of this solution was qualitatively similar to the spectra of the two preceding solutions.

The contrasts were more pronounced for the solution of concentration 3.128 than for any of the solutions containing smaller amounts of the dehydrating agent. The spectrum had gradually changed to the form suggested by fig. 71 (b). The maxima of absorption had not changed their wave-lengths. The transmission between  $0.72\mu$  and  $0.66\mu$  had become so weak that it was difficult to distinguish the maximum at  $0.697\mu$ .

The bands at  $0.697\mu$  and  $0.661\mu$  had coalesced completely for the solution of concentration 3.336 of the calcium chloride; in other words, the region of weak transmission at *c* had entirely disappeared. [See fig. 71 (c).] The resultant wide band extended from  $0.714\mu$  to  $0.654\mu$  with rather abrupt boundaries. The narrow bands at 6245 and 6095 had increased appreciably in depth, and the regions of transmission between 6610, 6405, 6245, and 6095 were much weaker, *i. e.*, the bands were joined by strong general absorption.

The solution which contained the largest amount of the dehydrating agent showed only one intense band in the red. [See fig. 71 (d).] This band comprises the interval from  $0.724\mu$  to  $0.603\mu$ . The brightest spot of transmission in the red was at about  $0.739\mu$ . Transmission in the yellow-green was noticeably weakened, and the next region of selective absorption commenced near  $0.578\mu$ , increased to totality at  $0.567\mu$ , and then began to fade away again at  $0.465\mu$ . All the spectra of the several solutions seemed to begin at the same wave-length, namely, at  $0.770\mu$ ; *i. e.*, there was no evidence of selective absorption in the extreme red.

The observed lowerings of the freezing-point of aqueous solutions containing both cobalt chloride and calcium chloride are tabulated below. Certain associated data are also given, but the interpretation of the tables will be deferred to a later section, in which the general bearing of all the experimental facts on the theory of hydrates will be discussed.

The solutions whose concentrations are marked (2) or (3) were made up respectively, on November 21 and on December 11, 1905. The freezing-point lowerings indicated by (4), (5), or (6) were measured on December 7, 1905, and February 16 and February 21, 1906. The arithmetical mean of the numbers in the last column, which correspond to solutions for which either 66 or 71 days elapsed between the times when the solutions were made up and when their freezing-point lowerings were determined, is 1.48. The like mean for the remaining solutions, which had stood only 15 days, is 0.655. These two numbers show conclusively that the two solutions both underwent a change with time, and that the number of effective particles in the solutions increased, *i. e.*, marked hydrolysis took place. Compare especially the numbers in the seventh column associated with concentrations 1.950 and 2.091.



TABLE 102.

1	2	3	4	5	6*	7
Concentration of $\text{CoCl}_2$ in the mixture.	Concentration of $\text{CaCl}_2$ in the mixture.	Observed freezing-point lowering of the mixture.	Lowering of freezing-point if $\text{CaCl}_2$ alone were present.	Molecular lowering of freezing-point if $\text{CaCl}_2$ alone were present.	Molecular lowering of freezing-point for $\text{CaCl}_2$ in $\text{H}_2\text{O}$ alone.	Column 5 minus column 6.
0.271	0.000	1.365°	.....	.....	.....	.....
0.271	0.162 <sup>3</sup>	2.340 <sup>5</sup>	0.975°	6.02°	4.92°	1.10°
0.271	0.325 <sup>3</sup>	3.400 <sup>5</sup>	2.035	6.26	5.05	1.21
0.271	0.650 <sup>3</sup>	6.130 <sup>5</sup>	4.765	7.33	5.55	1.78
0.271	0.974 <sup>3</sup>	9.115 <sup>5</sup>	7.750	7.96	6.29	1.67
0.271	1.299 <sup>3</sup>	12.250 <sup>6</sup>	10.88	8.38	7.06	1.32
0.271	1.462 <sup>3</sup>	14.000 <sup>6</sup>	12.63	8.64	7.38	1.26
0.271	1.624 <sup>3</sup>	16.500 <sup>6</sup>	15.13	9.32	7.88	1.44
0.271	1.676 <sup>3</sup>	16.200 <sup>4</sup>	14.83	8.85	8.03	0.82
0.271	1.950 <sup>3</sup>	23.000 <sup>6</sup>	21.63	11.09	9.03	2.06
0.271	2.091 <sup>2</sup>	21.700 <sup>4</sup>	20.33	9.72	9.32	0.40
0.271	2.515 <sup>2</sup>	29.200 <sup>4</sup>	27.83	11.06	10.90	0.16
0.271	2.671 <sup>2</sup>	34.500 <sup>4</sup>	33.13	12.40	11.53	0.87
0.271	2.830 <sup>2</sup>	39.000 <sup>4</sup>	37.63	13.30	12.32	0.98
0.271	3.143 <sup>2</sup>	47.000 <sup>4</sup>	45.63	14.51	13.81	0.70
0.271	3.555 <sup>2</sup>	.....	.....	.....	.....	.....

\* Interpolated from the table given by Jones and Bassett. Amer. Chem. Journ., **33**, 546 (1905).

The solution of concentration 3.143 was dark blue at room temperature, but red near its freezing-point. This phenomenon has frequently been observed before.

The most concentrated member of the series tabulated not only turned red, but the salt separated out when an attempt was made to determine its freezing-point. Table 103 contains the electrical conductivities, at zero degrees, of the solution of cobalt chloride and calcium chloride. The data are expressed in reciprocal ohms and reciprocal centimeters.

Since the data for the electrical conductivities of standard solutions are usually expressed in terms of the reciprocal of the Siemens mercury unit, it may not be superfluous to explain how the reduction to reciprocal ohms and reciprocal centimeters is effected. The ratio of the Siemens unit of resistance to the ohm is as 1:1.063; hence, to change the number representing the value of the conductivity of a given solution from reciprocal Siemens units to reciprocal ohms, the number must be multiplied by 1.063.\* Further, reduction to reciprocal centimeters is accomplished by dividing the number expressing the conductivity in reciprocal ohms by the product of 1,000 into the "volume" of the solution. For the sake of illustration, for a

\* In certain cases the reduction factor is 1.069.

fiftieth normal aqueous solution of potassium chloride at 25°, the conductivity in reciprocal Siemens units is 129.7; therefore, the conductivity in reciprocal ohms and reciprocal centimeters equals—

$$\frac{129.7 \times 1.063}{1,000 \times 50} = 0.002757 = K_s.$$

Since for a given cell, at a given temperature, the ratio of the specific conductivities of any two solutions is by definition equal to the inverse ratio of the ohmic resistance, it is only necessary to determine successively the resistance in the same cell and at constant temperature of a standard solution and of a solution to be tested, and then to multiply the specific conductivity of the standard solution by the ratio of the ohmic resistance of the standard solution to the ohmic resistance of the solution under investigation, in order to find the value of the specific conductivity of the solution in question. In obvious notation—

$$K_x = K_s \frac{R_s}{R_x} \text{ ohm}^{-1} \text{ cm}^{-1}$$

TABLE 103.

Concentration of CaCl <sub>2</sub> .	Conductivity.	Concentration of CaCl <sub>2</sub> .	Conductivity.
0.000	0.02220	1.950	0.10886
0.162	0.03449	2.091	0.10958
0.325	0.04493	2.515	0.11653
0.650	0.06415	2.671	0.11512
0.974	0.07831	2.830	0.11387
1.299	0.09113	3.143	0.10789
1.462	0.09964	3.555	0.09755
1.624	0.10363	.....	.....

Figure 72 shows graphically the functional relation between the electrical conductivity and the concentration of the solutions under consideration. The abscissæ denote the concentrations of the calcium chloride, and the ordinates give the corresponding conductivities in the units specified above. The concentration of the cobalt chloride was constant = 0.271. It is interesting to notice that the conductivity rose to a maximum value, and then decreased as the quantity of the dehydrating agent in the solutions increased.

COBALT CHLORIDE AND CALCIUM BROMIDE. [See plate 10.]

The cobalt chloride had the concentration 0.271 in all of the solutions of the set now under consideration. The concentrations of the calcium bromide were 0.000, 0.189, 0.379, 0.568, 0.757, 0.947, 1.136, 1.515, 1.893,

2.272, 2.650, 3.143, 3.313, 3.597, 3.938, 4.260. The first six increments of concentration were each 0.189, the next four separately equaled 0.379, and the remainder had the values 0.493, 0.170, 0.284, 0.341, and 0.322. The concentration of the mother-solution of calcium bromide was 4.733. The

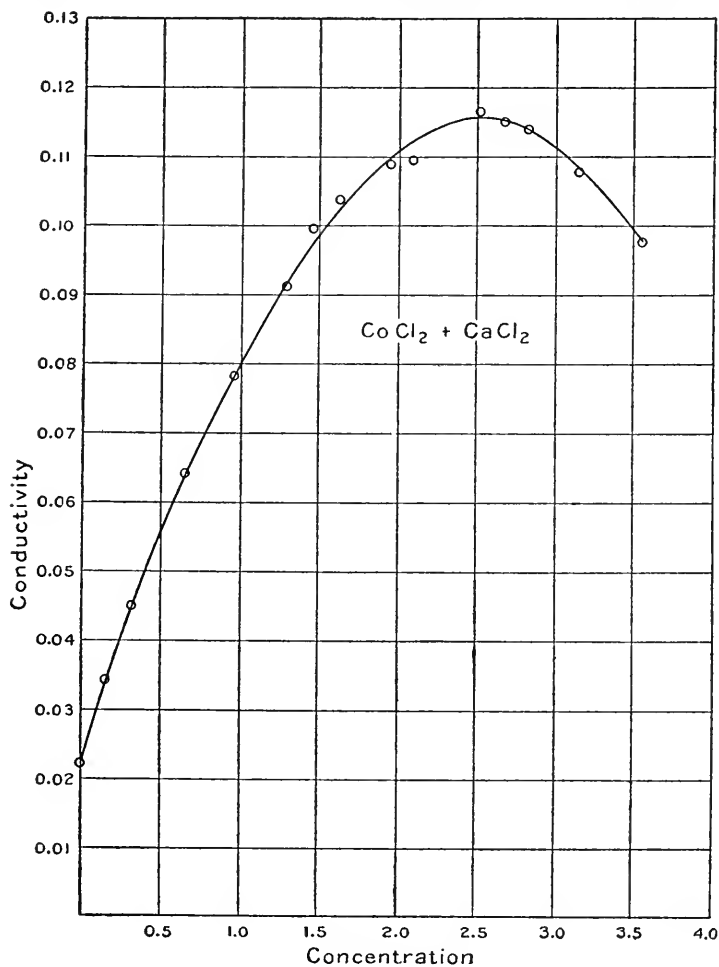

FIG. 72.

solutions containing calcium bromide had colors similar to the solutions in which calcium chloride was present, namely, all shades from red to intense blue. The photographic strips succeed one another from the side of the spectrogram adjacent to the numbered scale, to the edge adjoining the spark spectrum, in the order of increasing concentration of calcium bromide.

The half-films were not developed simultaneously in this particular case. The depth of the cell was 1.41 cm. The spectrogram\* shows qualitatively the same regions of absorption for the solutions made up with calcium bromide, as had been described above for the solutions containing calcium chloride. The negative recorded the line at 2265.1 A. U. as transmitted by the solution in which no dehydrating agent was present. No shorter wave sensibly affected the film. The region of absorption in the ultra-violet extended to longer and longer wave-lengths as the amount of bromide in the solutions became greater and greater. The shortest wave transmitted by the most concentrated solution, as shown by the negative, had a length of 3261.2 A.U. The middle of the band in the green has approximately the position given by  $0.518\mu$ . The strips pertaining to the first eleven solutions show that the width of the band just mentioned varied almost linearly with the like change in concentration of the calcium chloride. This band, according to the negative for the most concentrated solution, possessed complete absorption from  $0.460\mu$  to wave-lengths beyond the nearer end of the spectrogram. The presence of general absorption in the yellow-orange is clearly brought out by the photographic strips beginning with the 12th and ending with the 16th.

Eye observations on typical solutions of the set under consideration were made with the aid of the double-cell, and the most important changes in absorption noted were as follows: The comparison of the 1st and 6th solutions showed no appreciable differences in the orange and red portions of the parallel spectra. The data relative to the band in the green need not be repeated, since they can be obtained in great detail from plate 10.

The 6th and 9th solutions gave spectra of sensibly the same intensity, except in the region of the absorption band in the green. No trace of the bands in the orange and red could be seen in the preceding spectra.

The 12th solution absorbed the extreme red a little more than the 9th. More specifically, if it be said that the spectrum of the former began at  $0.700\mu$ , then the corresponding number for the latter would be  $0.736\mu$ . The narrow bands at 6245 and 6095 (plate 8) could only be seen for the 12th solution by moving the spectrum† across the field of view of the telescope.

The bright regions of transmission were approximately of the same intensity throughout. The 13th solution dimmed almost the entire spectrum a little more than the 12th, and it showed faintly the band at 6405 and more distinctly the bands at 6610, 6245, and 6095. The former solution showed almost complete absorption of all visible light of wave-length greater than  $0.687\mu$ . The absorption in the same region was not so intense for the

\*The slit of the spectrograph was narrower than usual, and this accounts for the partial absence of continuous background in the ultra-violet.

† The axes of the collimator and telescope were fixed at right angles to each other, and the spectrum was moved by rotating the prism by means of the wave-length drum.

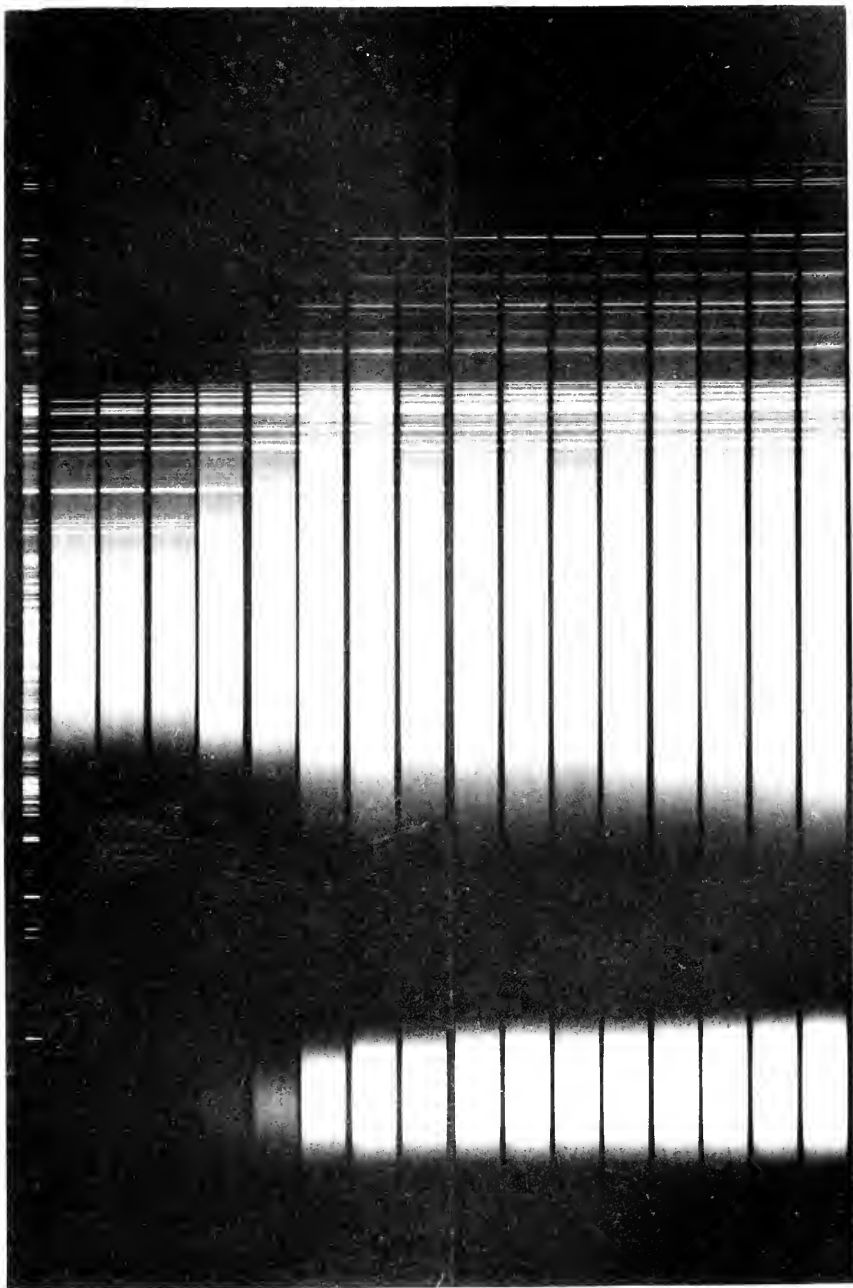

20  
21  
22  
23  
24  
25  
26  
27  
28  
29  
30  
31  
32  
33  
34  
35  
36  
37  
38  
39  
40  
41  
42  
43  
44  
45  
46  
47  
48  
49  
50  
51  
52  
53  
54  
55  
56  
57  
58  
59  
60  
61  
62  
63



12th solution. Both solutions transmitted the violet with about the same intensity.

The 14th solution absorbed completely all the red as far as  $0.632\mu$ , thus including the narrow band at  $6405$ . The yellow was much less intensely transmitted by the more concentrated solution than by the weaker one. A change similar in kind, but not in degree, appeared in the indigo and violet.

Only a short, comparatively faint region of yellow was transmitted by the 15th solution. If it be stated that the 14th solution absorbed everything visible beyond  $0.632\mu$ , then the corresponding number for the 15th solution must be  $0.619\mu$ .

The spectrum of the less concentrated solution of the pair was much brighter in the yellow than that of the more concentrated solution.

The most concentrated solution of the series did not transmit the faintest trace of orange or yellow light. Its spectrum extended from about  $0.460\mu$  to the ultra-violet. The intensity of violet transmitted by the 15th and 16th solutions appeared the same for the two spectra.

The freezing-point lowerings for the solutions containing both cobalt and calcium chloride are given in the following table:

TABLE 104.

1	2	3	4	5	6	7
Concentration of $\text{CoCl}_2$ in the mixture.	Concentration of $\text{CaBr}_2$ in the mixture.	Observed freezing-point lowering of the mixture.	Lowering of freezing-point if $\text{CaBr}_2$ alone were present.	Molecular lowering of freezing-point if $\text{CaBr}_2$ alone were present.	Molecular lowering of freezing-point for $\text{CaBr}_2$ in $\text{H}_2\text{O}$ alone.	Column 5 minus column 6.
0.271	0.000	1.365°	.....	....	....	....
0.271	0.189	2.703	1.338°	7.09	5.19	1.90
0.271	0.379	4.276	2.911	7.68	5.37	2.31
0.271	0.568	5.627	4.262	7.50	5.63	1.87
0.271	0.757	7.600	6.235	8.24	5.76	2.48
0.271	0.947	9.732	8.367	8.84	6.07	2.77
0.271	1.136	11.250	9.880	8.70	6.95	1.75
0.271	1.515	15.000	13.630	9.00	8.70	0.30
0.271	1.893	21.600	20.230	10.69	9.58	1.11
0.271	2.272	29.500	28.130	12.38	11.84	0.54
0.271	2.650	40.000	38.630	14.58	13.84	0.74
0.271	3.143	56.000	54.600	17.37	16.26	1.11
0.271	3.313	65.000	63.600	19.20	(17.09)	(2.11)
0.271	3.597	65.000	.....	.....	.....	.....
0.271	3.938	.....	.....	.....	.....	.....
0.271	4.260	.....	.....	.....	.....	.....

The solutions whose concentrations were between 0.189 and 1.136, inclusive of the limits, had their freezing-point lowerings determined 74 days after they were made up, whereas the corresponding time for each of the remaining

solution of the series was 14 days. The average value of the first six numbers in the last column of table 104 is 2.18 and the mean of the next five numbers is 0.76. Hence, the same increase with time of the number of particles which took part in the lowering of the freezing-point was observed for the solutions containing both cobalt chloride and calcium chloride, as was pointed out in connection with table 1 for the solutions containing the chlorides of cobalt and of calcium. The solutions having the concentrations 3.143, 3.313, and 3.938 became very viscous jellies near their freezing-points, and hence it was not possible to determine the temperatures of these points with even a reasonable degree of accuracy. For this reason two of the numbers in table 104 are inclosed in parentheses. Salt separated out when the attempt was made to ascertain the order of magnitude of the freezing-point lowering produced by the most concentrated solution. All of the most concentrated solutions were blue at room temperature, but they were of the characteristic cobalt rose color in the neighborhood of their respective freezing-points.

Table 105 gives the electrical conductivities at zero degrees of the solutions of cobalt chloride and calcium bromide. As formerly, the conductivity data are expressed in reciprocal ohms and reciprocal centimeters.

TABLE 105.

1	2	3	4
Concentration of CaBr <sub>2</sub> .	Conductivity.	Concentration of CaBr <sub>2</sub> .	Conductivity.
0.000	0.02220	2.272	0.12252
0.189	0.03994	2.650	0.12101
0.379	0.05465	3.143	0.11014
0.568	0.06308	3.313	0.10470
0.757	0.07412	3.597	0.09496
1.136	0.09244	3.938	0.08313
1.515	0.10643	4.260	0.07005
1.893	0.11913	.....	.....

The dependence of the conductivity upon the concentration of the calcium bromide is shown graphically by fig. 73. The abscissæ denote concentrations of the dehydrating agents, and the ordinates give the corresponding conductivities. The concentration of the cobalt chloride was the constant 0.271.

The maximum in the curve for the solutions containing the bromide was even more pronounced than it was for the curve pertaining to the solutions of the chloride of calcium. Moreover, these two maxima occur at roughly the same concentration, *i. e.*, at about 2.5 and 2.4 for the solutions containing the chloride and bromide, respectively.



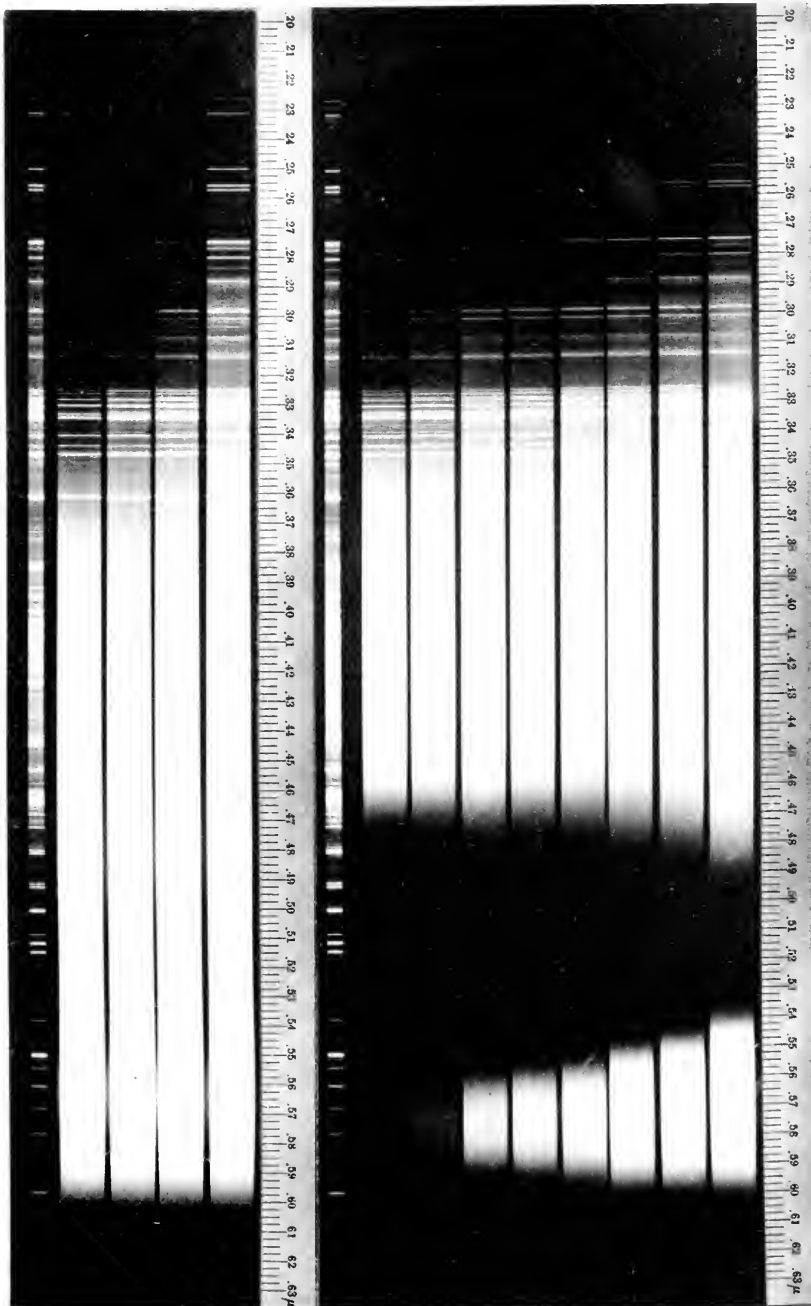

a

b



COBALT CHLORIDE AND ALUMINIUM CHLORIDE. [See plates 11 (b) and 12.]

The concentrations of the aluminium chloride in solutions corresponding to plate 11 (b) were 0.000, 1.118, 1.394, 1.676, 1.781, 1.887, 2.100, and 2.459. The increments of concentration were 1.118, 0.276, 0.282, 0.105, 0.106, 0.213, 0.359. The concentration of the cobalt chloride throughout was 0.271.

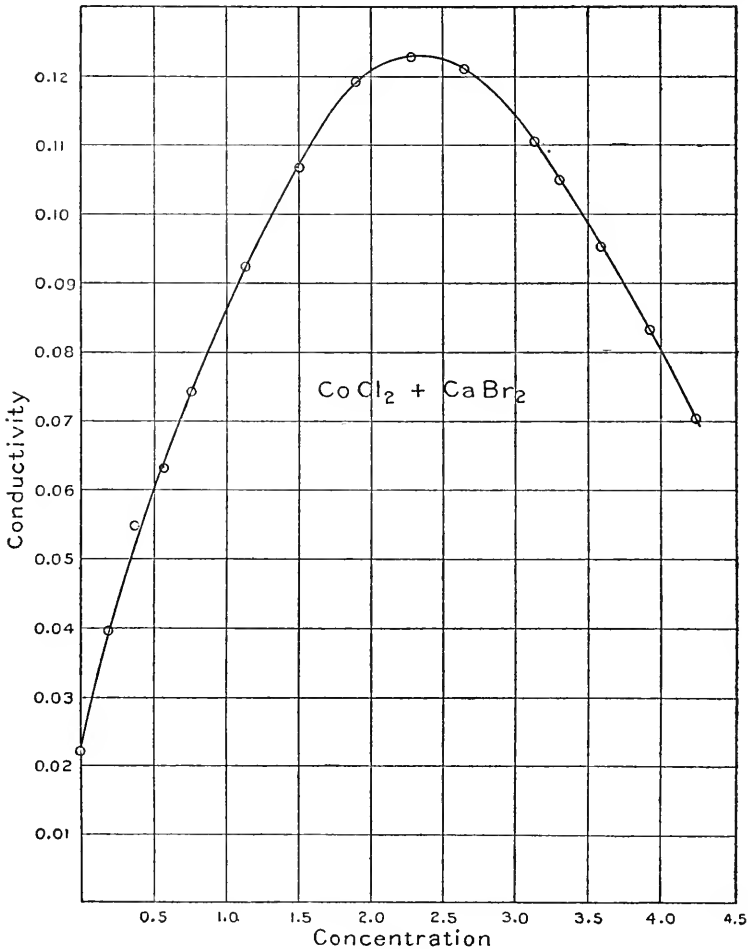

FIG. 73.

The concentration of the mother-solution of aluminium chloride was 2.75. The solutions made up from this mother-solution, and containing cobalt chloride, had colors similar to those of solutions in which either the bromide or chloride of calcium was present, namely, all shades from red to intense

blue. The photographic strips succeed one another from the side of the spectrogram adjacent to the numbered scale, to the edge contiguous to the spark spectrum, in the order of increasing concentration of the dehydrating agent. The depth of the cell was 1.41 cm. The spectrogram shows qualitatively the same regions of absorption as have been noted for all of the preceding series or sets of solutions containing cobalt chloride.

The negative recorded the line at 2265.1 as the most refrangible radiation transmitted by the solution which contained none of the aluminium chloride. The most concentrated solution transmitted a trace of the line of wavelength 2748.7, but the continuous background was completely absorbed beyond 0.288. The absorption band in the green was at about  $0.518\mu$ . The greatest wave-length for light transmitted at the blue side of this band, for the most concentrated solution, was given by the negative as  $0.484\mu$ . The seventh and eighth photographic strips, especially, show general absorption in the orange.

A few attempts were made to find out whether any simple relation might exist between two solutions having apparently the same color, the one containing calcium chloride and the other aluminium chloride. Except for the extremely concentrated solution, it was found that as a first approximation two solutions of the kind just mentioned were isochromatic when they contained equal numbers of chlorine atoms. The number before each comma in the following sequence denotes the concentration of the solution containing the chlorides of cobalt and calcium, and the number immediately following the comma in question signifies the concentration of the corresponding solution containing the same amount of cobalt chloride, and such an amount of aluminium chloride as to possess the same number of chlorine atoms as the solution whose concentration precedes the comma. The pairs are: 1.676, 1.118; 2.091, 1.394; 2.515, 1.676; 2.671, 1.781; 2.830, 1.887; 3.143, 2.100; and 3.555, 2.370. As far as the eye could tell the members of each pair of solutions had the same color when they were viewed in their bottles. All of the calcium chloride solutions and all of the aluminium chloride solutions, except the most concentrated one, have their absorption spectra reproduced by plates 9 (*a*) and 11 (*b*), respectively. To make the comparison easier and more direct, the members of the first, third, sixth, and last pairs of solutions were photographed side by side and in quick succession. The resulting spectrogram is shown on plate 12. Counting from the side of the plate nearest to the numbered scale, the first, third, fifth, and seventh photographic strips correspond to the solutions which contain calcium chloride, and the remaining strips pertain to the solutions which contain aluminium chloride.

The depth of the cell was 1 cm. In the ultra-violet the solutions which contained the aluminium salt showed much stronger absorption than those which were made with the calcium salt. On the other hand, the band in the

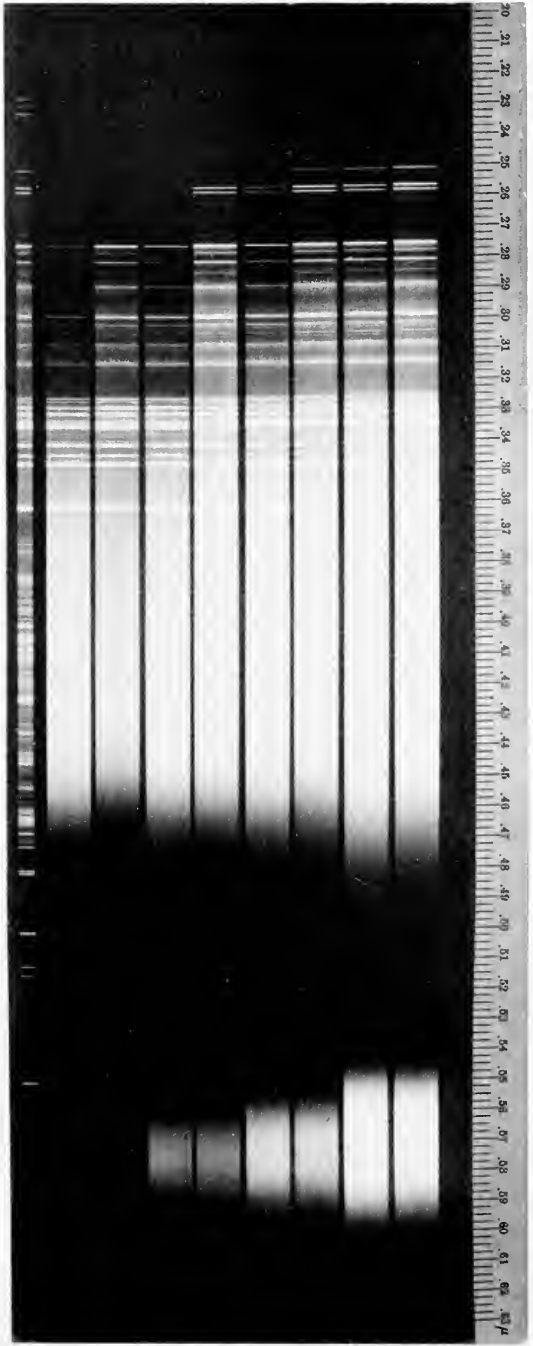

4



green is a little more intense for the solutions which contain calcium chloride than for the solutions of the other set. That this difference, however, is not very appreciable is readily seen from plate 12. Due to the presence of a small quantity of some impurity, the mother-solution of aluminium chloride had a very slight color in layers of 5 cm. or more in thickness. The facts brought out by the spectrogram of the mother-solution of aluminium chloride are given below. Two strips were photographed, the one corresponding to a depth of 15.1 cm. and the other to a depth of 1.41 cm. The Nernst filament was given an exposure each time of two minutes, and the spark was run for 1.5 minutes. The negative shows complete absorption of all the ultra-violet and violet as far as  $0.415\mu$  for the deeper layer, and the entire strip is relatively faint and under-exposed. In fact, the photographic impression fades away about 230 A. U. farther from the longer wave-length end of the negative for the deeper layer than for the shallower one. The faintest trace of the spark line at 2558 was transmitted by the shallow layer of solution; also the line at 2748.7 was barely recorded on the negative. The continuous background began at about  $0.288\mu$ , and did not attain its full intensity for wave-lengths shorter than  $0.325\mu$ .

Eye observations have completely confirmed photographic results in the visible region, especially with regard to appreciable absorption of the violet even for a depth of 5.3 cm., and marked general absorption through the entire spectrum for a depth of 15.1 cm. It was, therefore, evident that the mother-solution of aluminium chloride possessed both selective and general absorption, which were certainly not negligible for long columns of solution, and perhaps not inappreciable for such short columns as 1.41 cm. Consequently, the differences in ultra-violet absorption shown by plate 12 for the successive pairs of solutions, may be due to the strong absorption in this region of the aluminium chloride, and not to the presence of the cobalt chloride, even alone or as influenced by the dehydrating agent.

Before giving the facts obtained by eye observations and by freezing-point and conductivity measurements, with the solutions containing the chlorides of cobalt and of aluminium, it may not be out of place to present the salient points brought out by the photographic comparison of the relative intensities and extents of absorption exerted by the mother-solution of calcium chloride, calcium bromide, and aluminium bromide. The spectra are shown by plate 11 (*a*). The concentration of the calcium chloride solution was 4.51, that of the bromide was 4.236, and that of the aluminium salt was 2.75. The strip nearest to the numbered scale corresponds to distilled water. The next strip pertains to the solution of calcium chloride, the third strip is due to the aluminium chloride, and the strip adjacent to the comparison spectrum is that of calcium bromide. The depth of the cell was 1.41 cm. The negative indicated no absorption at all for the distilled

water; in other words, the zinc line at 2024.2 was recorded. The calcium chloride transmitted a trace of the strong cadmium line at 2265.1. This solution absorbed practically all of the continuous background between  $0.280\mu$  and  $0.202\mu$ . The mother-solution of aluminium chloride transmitted precisely the same lines as did the solution of calcium chloride, but the former absorbed and weakened the continuous background a good deal more than the latter. When the concentrations of these two solutions are taken into account, the relatively great absorbing power of the aluminium salt for the very short waves becomes evident at once. The strong emission line at 2748.7 was weakly transmitted by the solution of calcium bromide, but the continuous background was almost completely absorbed beyond  $0.313\mu$ . Since the concentration of the calcium bromide solution was somewhat less than that of the calcium chloride, the second and fourth photographic strips show conclusively how very much stronger the absorption of the bromide is than that of the chloride for the short light waves. For the depth used in the visible region, the three solutions in question exerted no appreciable absorption.

In the light of what has just been explained, a comparison of the spectrograms of plates 2, 9 (*a*), 9 (*b*), 10, 11 (*a*), and 11 (*b*) leads to the conclusion that, in general, the absorption of the ultra-violet light by the cobalt chloride is masked to some extent by the superposition of the greater absorption of the dehydrating agent in a given solution. Therefore, the absorption bands in the visible spectrum are better criteria for the behavior of the cobalt salt in the presence of some one of the dehydrating agents than the regions of absorption in the ultra-violet. It does not seem necessary to enter into minute details relative to the general principles just stated.

Eye observations on the absorption spectra of the solutions which contained the chlorides of cobalt and aluminium led to practically the same results as were obtained with the other two dehydrating agents under investigation. The chief characteristics of these spectra are shown by the four curves of fig. 71. The depth of column used was 2.5 cm. The solutions of concentration 1.118 and 1.394, in the aluminium salt, did not show even the faintest traces of discrete bands in the red. The entire set of five bands could barely be distinguished with the solution of concentration 1.676. The solution of concentration 1.781 has its systems of bands represented fairly well by fig. 71 (*a*), except that the band at 6405 was hard to see. The bands at 6405, 6245, and 6095 were relatively intense, but not very clear-cut and well-defined for the solution of concentration 1.887. Figure 71 (*c*) gives an idea of the regions of transmission and absorption for the solution of concentration 2.100. For this solution the bands at  $0.697\mu$  and  $0.661\mu$  had coalesced and the resultant region extended from  $0.713\mu$  to  $0.653\mu$ . A deep



shadow joined this region to the narrow band at 6405. The bands at 6245 and 6095 were very intense. The width of the band at 6245 was about 55 Ångström units. A solution having the concentration 2.340 showed the entire group of five bands as one single region of absorption, like that indicated by fig. 71 (d). This region had the limits  $0.724\mu$  and  $0.599\mu$ . The transmission of light in the interval from  $0.599\mu$  to the beginning of the band in the green was very weak. The most concentrated solution of the series transmitted faintly a narrow band of red. The coalesced group extended from  $0.736\mu$  to  $0.590\mu$ . The region of transmission in the yellow-green was very dim, and lay in the penumbra of the absorption band whose maximum was near  $0.518\mu$ . The absorption in the red and yellow was much more complete than for the most concentrated member of the series of solutions that contained calcium chloride.

The freezing-point lowerings for the solutions containing both cobalt chloride and aluminium chloride are given in the following table:

TABLE 106.

1	2	3	4	5	6	7
Concentration of $\text{CoCl}_2$ in the mixture.	Concentration of $\text{AlCl}_3$ in the mixture.	Observed freezing-point lowering of the mixture.	Lowering of freezing-point if $\text{AlCl}_3$ alone were present.	Molecular lowering of freezing-point if $\text{AlCl}_3$ alone were present.	Molecular lowering of freezing-point for $\text{AlCl}_3$ in water alone.*	Column 5 minus column 6.
0.271	0.000	1.365°	.....	.....	.....	.....
0.271	0.165	2.692	1.327°	8.04°	5.72°	2.32°
0.271	0.330	4.350	2.99	9.06	6.27	2.79
0.271	0.495	6.260	4.80	9.70	7.02	2.68
0.271	0.660	8.710	7.35	11.14	7.80	3.34
0.271	0.825	11.4	10.04	12.17	8.79	3.38
0.271	0.990	14.6	13.24	13.37	9.92	3.45
0.271	1.118	17.5	16.14	14.44	10.84	3.60
0.271	1.394	25.6	24.24	17.39	13.23	4.16
0.271	1.485	28.9	27.54	18.55	14.06	4.49
0.271	1.676	38.0	36.64	21.86	15.95	5.91
0.271	1.781	44.0	42.64	23.94	17.18	6.76
0.271	1.887	49.0	47.64	25.20	18.40	6.80
0.271	1.980	54.0	52.60	26.60	19.70	6.90
0.271	2.096	50.0	.....	.....	.....	.....

\* Interpolated from the table given by Jones and Getman: *Ztschr. phys. Chem.* **49**, 422 (1904).

When cooled by the mixture of ethyl alcohol and solid carbon dioxide the most concentrated solutions became very viscous, red jellies, which either under-cooled about 20° and then became solid, or the salt separated out of the jelly. Hence, it was not possible to assign correct values to the

freezing-point lowerings of these solutions. With the exception of the second or third member, the numbers in the last column of table 106 become gradually larger as the concentration of the solution increases.

The electrical conductivities, together with the corresponding concentrations of the solutions containing cobalt chloride and aluminium chloride, are given in table 107. The numbers in the second and fourth columns are expressed in reciprocal ohms and reciprocal centimeters.

TABLE 107.

Concentration.	Conductivity.	Concentration.	Conductivity.
0.000	0.02220	1.485	0.06657
0.165	0.03845	1.676	0.06076
0.330	0.05050	1.781	0.05830
0.495	0.05924	1.887	0.05468
0.660 †	0.06577	1.980	0.05054
0.825 †	0.06889	2.100	0.04747
0.990	0.07078	2.370	0.03736
1.118	0.07204	2.459	0.03279
1.394	0.06887	.....	.....

The data in the above table are plotted in fig. 74. The abscissæ denote concentration, and the ordinates signify conductivity. The mean curve has a decided maximum like the curves for the solutions containing calcium chloride and calcium bromide. There is this difference, however, between the curve of fig. 74 and the other two curves, namely, that whereas the maximum of the curve associated with aluminium chloride corresponds to a concentration of about 1.1, the maxima for the other two dehydrating agents in question occur at the concentrations 2.5 and 2.3.

When a sufficient quantity of water is added to a solution of cobalt chloride, which had previously been made blue by the admixture of a solution of some one of the three dehydrating agents under investigation, the solution turns back to the characteristic cobalt red. It was thought that by adding water to a chosen solution of the given series, until the color of this solution became practically the same as that of the solution containing a somewhat smaller amount of the dehydrating agent, it might be possible to obtain some facts which would bear a quantitative relation to the hydrates formed in the solutions. If it were possible to take infinitesimal steps such data might be obtained. But obviously such a process can not be realized experimentally. In practice either one of two difficulties presents itself: (a) The successive solutions differ so little in concentration that the volume of water which had to be added to the more concentrated solution to bring its color to that of the less concentrated one, is too small to be accurately measured unless

the very greatest precautions are taken. Moreover, two solutions of nearly equal concentrations differ so little in color, as to make the error which necessarily arises in estimating that the colors have been made the same by

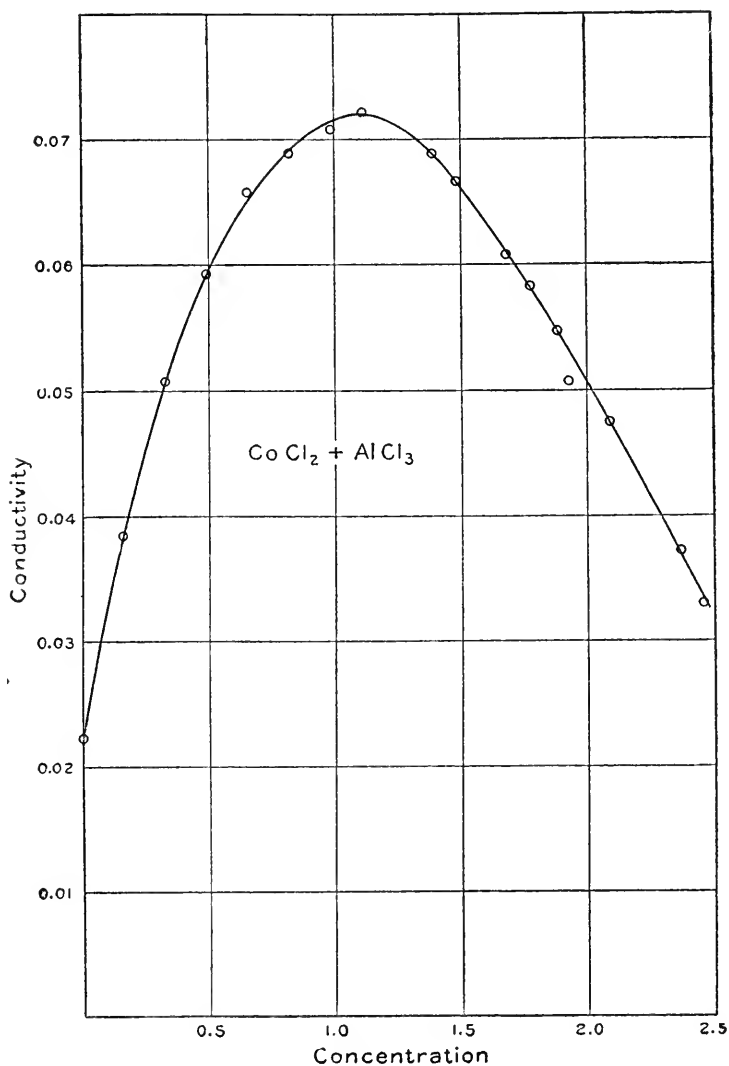

FIG. 74.

the act of diluting, relatively great. (b) When the concentrations of two solutions differ by a reasonable amount, it is not possible to dilute the bluer solution until it assumes the same color as the less blue solution, because the

volume of water added so greatly increases the volume of the solution as to change the concentration of the cobalt chloride itself, quite independently of any change in the amount of hydration of this salt. In other words, the colors of the two solutions can not readily be made the same under comparable conditions, when the concentrations differ very widely.

The matter under consideration was carefully tested for some of the solutions of cobalt chloride and aluminium chloride as follows: The lower compartment of a double-cell was filled with the less concentrated solution of a chosen pair. A measured volume (4 cc.) of the more concentrated solution was placed in the upper compartment of the cell. Then pure water was run into the upper solution from a burette, until the color in the two compartments appeared the same. The upper solution was of course made homogeneous. The volumes of water which were both insufficient and too great to dilute the more concentrated solution to the color of the less concentrated were noted, as well as the volume of water which was necessary to produce approximate equality of color. The mean of several trials was taken. In some cases the solutions were examined with the Hilger spectroscope. In this way it was possible to obtain data which are at least of the right order of magnitude. The results are given in table 108. The first column ( $c_1$ ) gives the concentration of the solution to which the water was added. The second column ( $c_2$ ) gives in the same line the concentration of the solution which was used as the standard for color. The difference in the concentrations ( $c_1 - c_2$ ) is shown by the third column. The volume ( $v$ ) of water necessary to produce equality of color is given in the fourth column. The fifth column gives unit volume of water per unit volume of solution, per unit concentration of aluminium chloride, and per unit change in concentration, *i. e.*,

$$\frac{v}{4c_1 (c_1 - c_2)}$$

TABLE 108.

$c_1$	$c_2$	$c_1 - c_2$	$v$	$\frac{v}{4c_1 (c_1 - c_2)}$
				<i> cub. cent. </i>
1.485	1.394	0.091	0.260	0.48
1.676	1.485	0.191	0.470	0.37
1.781	1.676	0.105	0.180	0.24
1.887	1.781	0.106	0.210	0.26
1.980	1.887	0.093	0.145	0.20
2.100	1.980	0.120	0.155	0.15
2.370	2.100	0.270	0.350	0.14

The numbers in the last column show a definite decrease as the concentration of the dehydrating agent increases.

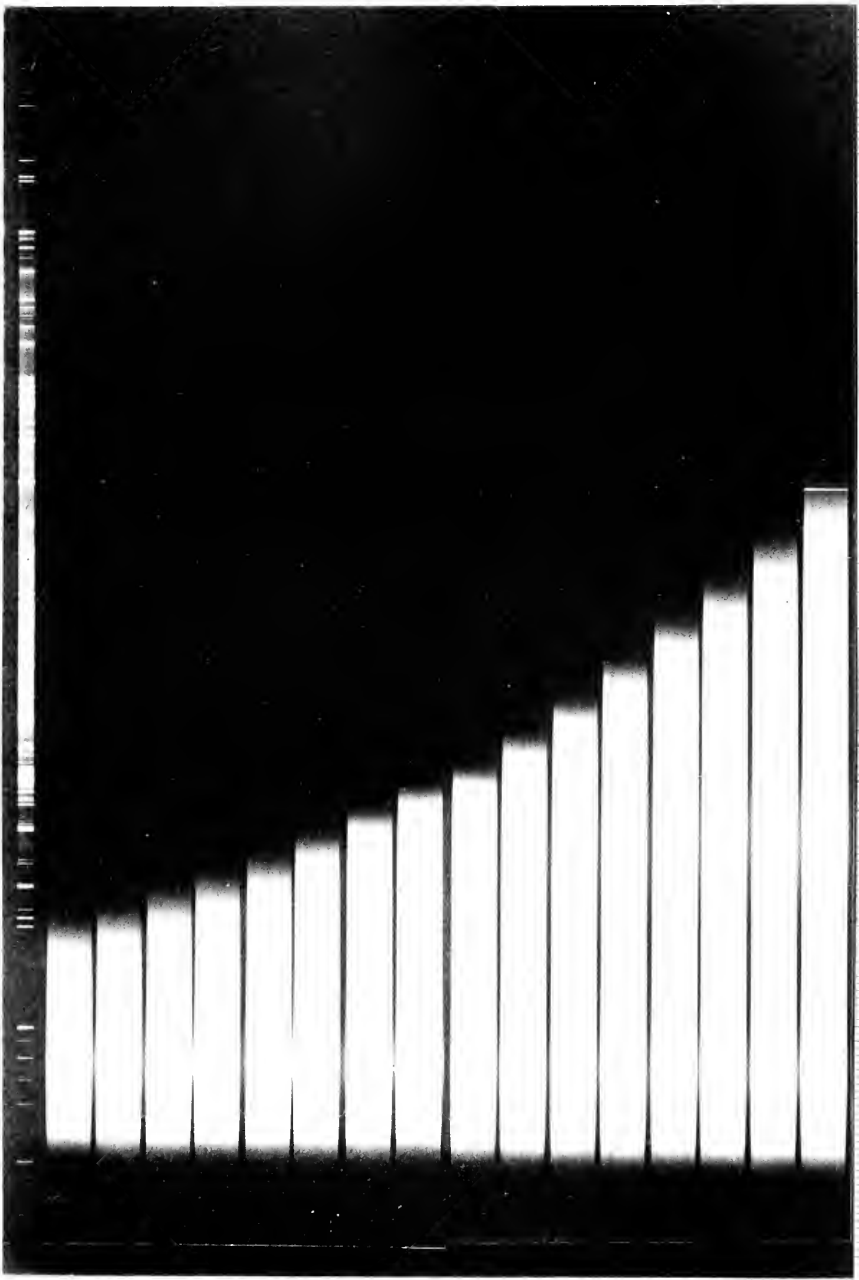



## COPPER CHLORIDE AND CALCIUM CHLORIDE. [See plate 13.]

The concentration of the copper chloride in all of the solutions had a constant value 0.398. The concentrations of the calcium chloride were 0.000, 0.271, 0.541, 0.812, 1.082, 1.353, 1.624, 1.894, 2.165, 2.435, 2.706, 2.977, 3.247, 3.518, 3.788, 4.041. All the increments of concentration have the value 0.2706, except the last one, and its value is 0.253. The concentration of the mother-solution of calcium chloride was 4.51. The colors of the solutions commenced with clear blue for the most dilute solutions, and passed through the various shades of greenish-blue, bluish-green, clear green, and yellowish-green, and the concentration of the calcium chloride increased until a deep greenish-yellow color was reached.

The photographic strip adjacent to the numbered scale corresponds to the solution that did not contain any of the calcium salt. The second strip corresponds to the solution of concentration 0.271, and so on, until finally the strip next to the comparison spectrum pertains to the most concentrated solution in the series. The depth of the cell was 1.41 cm.

The spark line of shortest wave-length recorded by the negative for the most dilute solution was 3436.9 A.V., but the continuous background barely extended to  $0.347\mu$ . For the solution of concentration 4.041 transmission is shown by the negative, and began at  $0.506\mu$ . Since the successive differences in concentration of the first fifteen solutions are all equal, the spectrogram shows at a glance the dependence of the limit of absorption of the region which included the ultra-violet upon the concentration of the dehydrating agent. That the locus of the left-hand ends of the photographic strips is, as would be expected, not a straight line, but a decided smooth curve, is very apparent. In fact, the band increased in width at the only measurable end by approximately 160 A. U. as the concentration changed from 0.271 to 0.541; but this limit of absorption only moved by about 65 A. U. as the concentration passed from 3.518 to 3.788. In other words, the less refrangible end of the ultra-violet band seems to tend towards a definite limit as the concentration of the calcium chloride increased. That this absorption is primarily due to the copper chloride, and not to the ultra-violet band of the calcium salt as such, follows at once from a consideration of plates 3 (*b*), 5, and 11 (*a*), and the remarks on the corresponding pages. The change in color of the solutions from blue to green, with increasing amount of calcium chloride, simply means that the ultra-violet band, which did not encroach upon the visible spectrum in the case of the blue solutions, had advanced into the visible spectrum and absorbed the violet and blue to a greater or less extent in the case of the green and greenish-yellow solutions.

Eye observations of the solutions were made with the aid of the cell having two compartments. The data thus obtained for the shorter wave-lengths

confirmed in detail all the statements made above and derived from the photographs. Each one of the sixteen solutions absorbed the red and orange completely. The more refrangible end of this band moved so gradually to shorter wave-lengths, that it was only possible to see a very slight shift when the spectra of two consecutive members of the set of solutions were viewed simultaneously; but it was not possible to assign a number to the magnitude of the displacement. The best that could be done was to observe the extreme members of the series at the same time, and to obtain the average shift of the visible end of the band by dividing by 15.

The penumbra of the band in question appeared to have the same intensity at  $0.640\mu$ , for the most dilute solution, as at  $0.628\mu$  for the most concentrated. Therefore, the mean observed displacement was 8 A. U. When the last-named solution was compared with distilled water, it was observed that the spectrum transmitted by the water had about the same intensity at  $0.760\mu$  as the penumbra for the solution had at  $0.628\mu$ . Also the solution did not transmit any color as completely as the water; *i. e.*, the former possessed appreciable general absorption between the regions of complete extinction of light.

The freezing-point lowerings for the solution containing the chlorides of copper and of calcium are given in the following table:

TABLE 109.

1	2	3	4	5	6	7
Concentration of $\text{CuCl}_2$ in the mixture.	Concentration of $\text{CaCl}_2$ in the mixture.	Observed freezing-point lowering of the mixture.	Lowering of freezing-point if $\text{CaCl}_2$ alone were present.	Molecular lowering of freezing-point if $\text{CaCl}_2$ alone were present.	Molecular lowering of freezing-point for $\text{CaCl}_2$ in $\text{H}_2\text{O}$ alone.*	Column 5 minus column 6.
0.398	0.000	2.433°	.....	.....	.....	.....
0.398	0.271	4.305	1.872°	6.91°	4.98°	1.93°
0.398	0.541	6.109	3.676	6.80	5.32	1.48
0.398	0.812	8.280	5.847	7.20	5.92	1.28
0.398	1.082	10.500	8.067	7.46	6.54	0.92
0.398	1.353	13.100	10.667	7.88	7.18	0.70
0.398	1.624	16.500	14.070	8.66	7.88	0.78
0.398	1.894	20.750	18.320	9.67	8.64	1.03
0.398	2.165	26.000	23.570	10.89	9.75	1.14
0.398	2.435	31.250	28.820	11.84	10.63	1.21
0.398	2.706	37.500	35.070	12.96	11.70	1.26
0.398	2.977	44.000	41.570	13.96	13.05	0.91
0.398	3.247	52.500	50.070	15.42	14.32	1.10
0.398	3.518	(?)	.....	.....	.....	.....

\* Interpolated from the results of Jones and Basset. Amer. Chem. Journ., 33, 546 (1905).

As the temperature of the green and yellow-green solutions decreased, the color became bluer. The solution of concentration 3.247 was very viscous and jelly-like near its freezing-point.



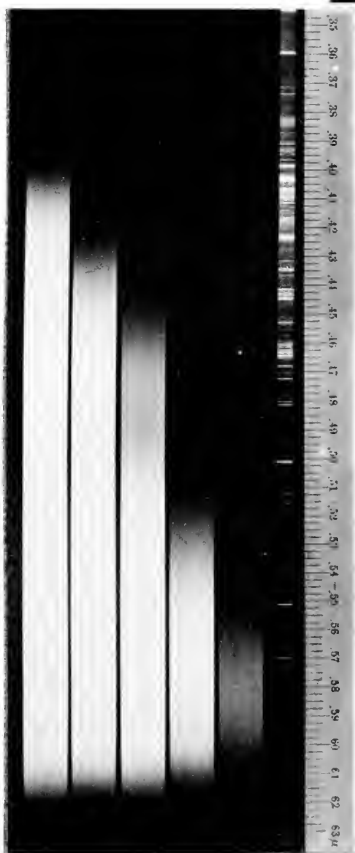

a

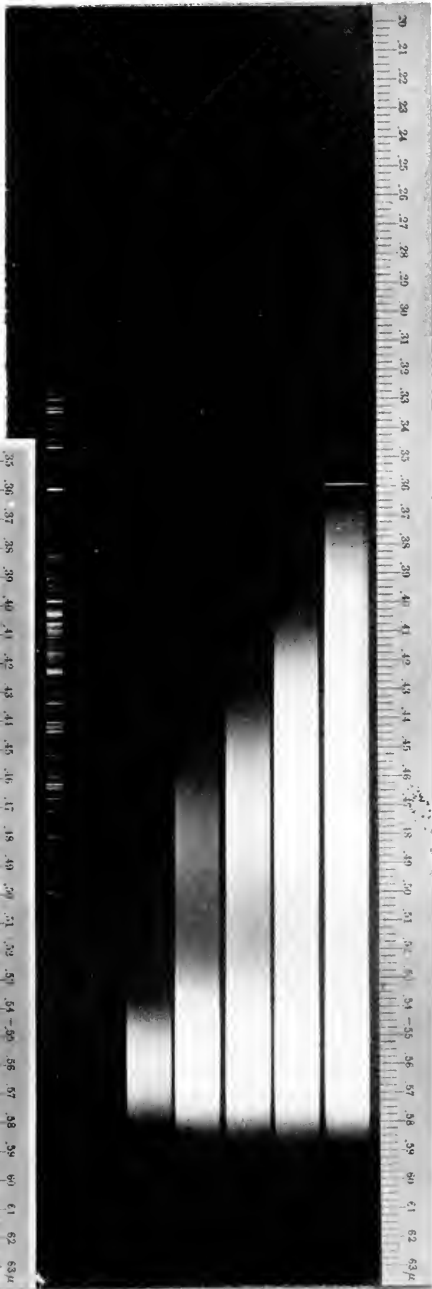

b



The freezing-point lowerings of the last three solutions of the series could not be determined, since the salts separated out when the attempt was made to freeze the solutions.

The electrical conductivities, together with the corresponding concentrations of some of the solutions containing copper chloride and calcium chloride, are given in table 110. The conductivity data are expressed in reciprocal ohms and reciprocal centimeters.

TABLE 110.

Concentration.	Conductivity.	Concentration.	Conductivity.
0.000	0.02938	1.624	0.08643
0.271	0.04601	1.894	0.08864
0.541	0.05586	2.165	0.08955
0.812	0.06512	3.518	0.07937
1.082	0.07320	3.788	0.07222
1.353	0.08146	4.041	0.06517

The data in the above table are plotted in fig. 75. The abscissæ and ordinates denote, respectively, concentration and conductivity. This curve has a well-defined maximum, just like all the preceding curves.

A peculiar difficulty presented itself when an attempt was made to determine the ohmic resistance of certain of the solutions containing copper chloride, and either calcium chloride or aluminium chloride. The resistance (aside from the cell constant) was first large and then decreased to a definite fixed value. For illustration, the successive resistances of the second solution recorded in the above table were 719.6, 706.9, 703.9, 704.3, 703.8. In all cases the mean of three or more determinations, made after the solution seemed to have reached a steady state, was taken as representing the true ohmic resistance of the solution under investigation. That this phenomenon could not be ascribed to changes in temperature, or to air-bubbles, or to absorption by the electrode, or to variable resistance and contact in the electrical circuit, was shown by repeated and careful tests of all of these matters, as well as of such other causes for the trouble as were thought of from time to time. It was not consistent with the investigation as a whole to pursue this question further.

COPPER CHLORIDE AND CALCIUM BROMIDE. [See plates 14 (a), 14 (b), 15 (a), 15 (b), 16 (a), and 16 (b).]

The concentration of the copper chloride in all of the solutions was the constant 0.398. The concentrations of the calcium bromide were 0.000, 0.254, 0.508, 0.763, 1.017, 1.271, 1.525, 2.033, 2.542, 3.050, 3.389, 3.804. Each of the first six increments of concentration equals 0.2542; and each of the next three equals 0.5084. The one next to the last has the value 0.339,

and the last difference equals 0.415. The concentration of the solution of calcium bromide was 4.236.

As the concentration of the dehydrating agent increased, the color of the solutions changed from pale-blue to deep greenish-brown, passing through all

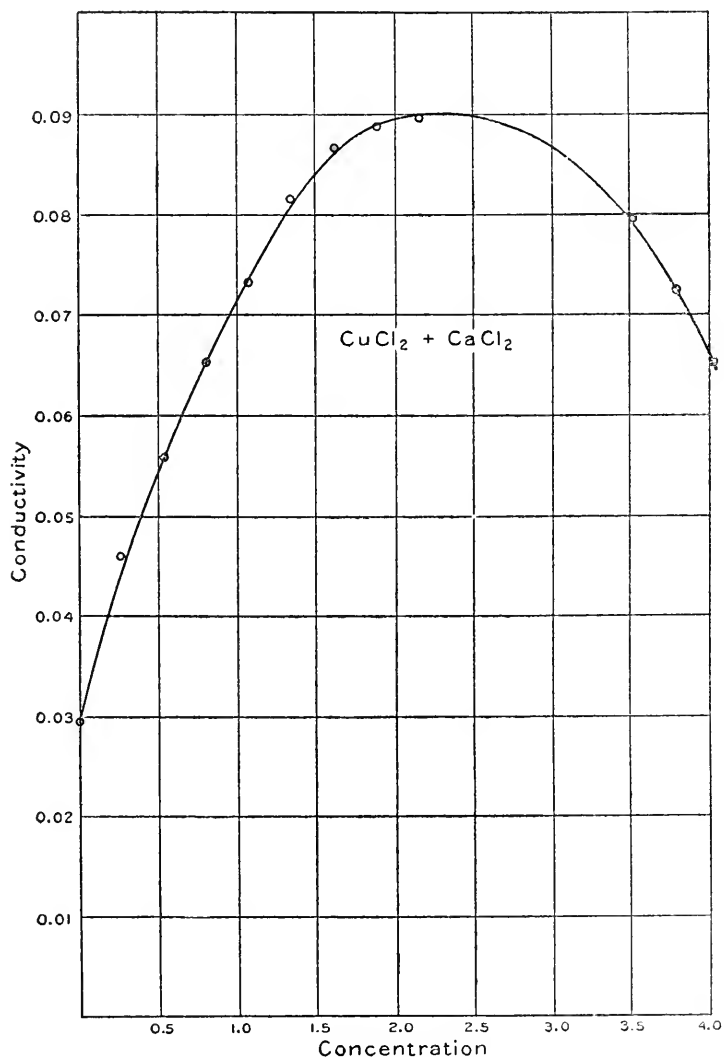

FIG. 75.

intermediate shades of bluish-green, clear green, and yellowish-green. Except in very thin layers, the most concentrated solutions were completely opaque to light. In very thin layers the most concentrated solution was of a dark-red color, similar to that of liquid bromine.

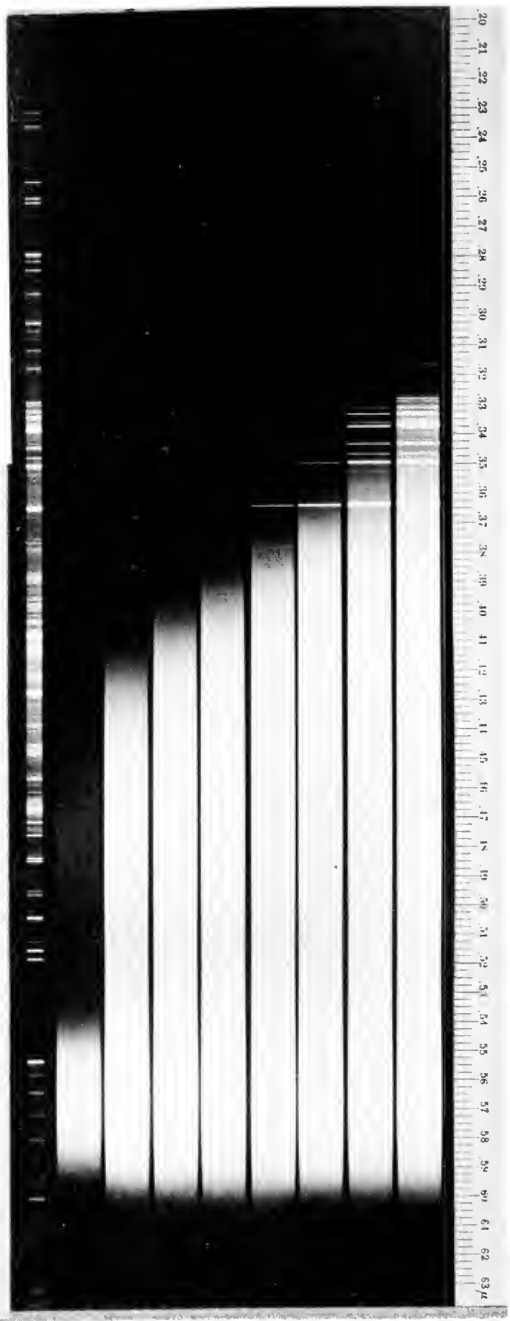
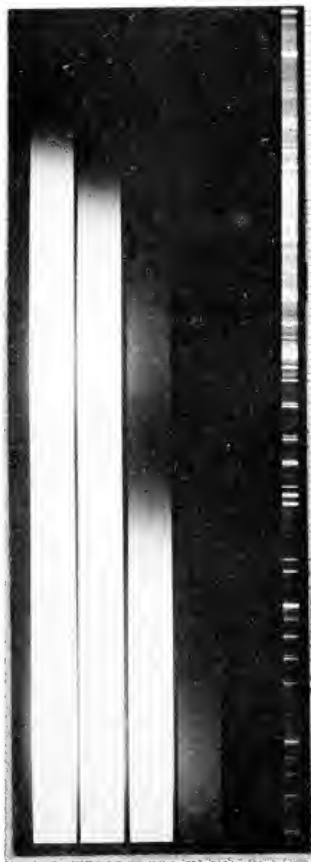



Plate 14 (*b*) will be discussed first. The photographic strip nearest to the numbered scale corresponds to the solution that contained no calcium bromide. The solution of concentration 1.271 has its spectrum shown by the strip adjacent to the spark scale. The depth of cell used was 1.41 cm., in order to obtain a spectrogram comparable with the spectrograms for solutions containing copper chloride and dehydrating agents other than calcium bromide. For this depth, however, it was only possible to photograph the first six solutions of the series. The spark line of shortest wave-length recorded by the negative for the most dilute solution was at 3466.3. The continuous background ceased, however, at about  $0.351\mu$ . The fifth strip on the negative shows very faint transmission from about  $0.477\mu$  to  $0.527\mu$ .

Plate 14 (*b*) gives correctly the details of this strip at the less refrangible side of  $0.527\mu$ . For the 6th solution the negative shows extremely faint transmission from  $0.550\mu$  to  $0.581\mu$ , at which point the sensitivity of the film ceased.

Plate 14 (*a*) gives the spectrogram obtained with the red sensitive photographic plate of the make used throughout the present work. The depth of the cell was 1.41 cm., the same as for plate 14 (*b*). The strip next to the comparison scales corresponds to the solution of concentration 1.271, while the strip adjacent to the outside edge of plate 14 (*a*) was acted upon by light that had passed through the solution which contained the smallest mass of calcium bromide. Each exposure to the light from the glower lasted for 2.5 minutes. The fourth strip of the negative in question, which corresponds to the fifth strip of plate 14 (*b*), shows that transmission began near  $0.500$  and extended to about  $0.618\mu$ . The strip corresponding to the most concentrated solution of the set of six solutions now under discussion showed rather faint transmission from about  $0.543\mu$  to  $0.614\mu$ , with the maximum of intensity at  $0.579\mu$ . It is evident, therefore, that the relative intensities of the region of transmission as recorded by the fifth strip of plate 4 (*b*) are somewhat exaggerated by the peculiarities of the photographic film. Plate 14 (*a*) shows the presence of true absorption in the red.

The next spectrogram to be considered is that of plate 15 (*b*). The first eight solutions of the complete set have their absorption spectra shown by this plate. When a sheet of rough white paper in the daylight was viewed through the cell and the liquid contained in it, the following colors were observed for the several solutions: The first two had no color, the third was faint green, the fourth and fifth were each of a delicate greenish-yellow color, the sixth was a decided yellow-green, the seventh was brown, and the eighth was a dull coffee-brown. The photographic strips corresponding, respectively, to the solutions of concentration 0.000, 2.033, in the calcium bromide, are adjacent to the numbered scale and to the spark spectrum. The depth was only 0.08 cm. The strong cadmium line at wave-

length 2980.8 was the most refrangible radiation recorded by the negative for the first solution of the series. The continuous spectrum did not extend beyond  $0.305\mu$ . For the 7th solution transmission began at about  $0.400\mu$ . The negative strip for the 8th solution recorded very faint transmission from  $0.436\mu$  on in the direction of greater wave-lengths. A minimum was at  $0.518\mu$  and strong transmission began in the neighborhood of  $0.527\mu$ . As often emphasized in preceding paragraphs, great care must be taken to avoid drawing false conclusions from photographic records for which unavoidable under-exposure permitted the variations in sensibility of the photographic emulsion to exert undue influence on the record.

The absorption spectra shown by plate 15 (a) pertained to the 6th, 7th, 8th, 9th, and 10th solutions of the complete set now under discussion. The photographic strip farthest away from the comparison scales corresponds to the most dilute solution of the group whose spectra are given by the plate. The depth of the cell was 0.08 cm. The glower exposures were each 2.5 minutes long. The negative strip corresponding to the most dilute member of this group of five solutions showed that transmission began very weakly near  $0.380\mu$ . It indicated no general absorption in the orange. The third strip, *i. e.*, the one pertaining to the solution of concentration 2.033, showed on the negative that faint transmission began at  $0.434\mu$ , rose to a maximum at  $0.462\mu$ , then faded out to a minimum of almost complete absorption at  $0.495\mu$ , and finally became strong at about  $0.53\mu$  and so continued to the end of the negative. The fourth strip which pertained to the solution of concentration 2.542 showed very faint transmission from  $0.568\mu$  to the end of the negative. The negative recorded nothing for the solution of concentration 3.050.

Plate 16 (b) gives the absorption of the solution which contained the largest amount of calcium bromide (of concentration 3.804) when placed in the wedge-shaped cell. The liquid prism showed a dark, reddish-brown color. The edge of the spectrogram nearest to the comparison spectrum corresponds, of course, to the least thickness of absorbing layer. The angle of the wedge was about  $15.6'$ , and hence, since the cell was adjusted to begin at zero depth, the greatest thickness of absorbing layer was about 0.14 mm. The negative recorded the strong line of wave-length 2265.1 as transmitted by the thinnest portions of the solution, but nothing more refrangible. The continuous background did not extend to shorter radiation than  $0.233\mu$ . The ultra-violet absorption is seen to be very intense when the small thickness of the solution is taken into account. The opacity of the solution began to decrease in the neighborhood of  $0.346\mu$  and rose gradually to a minimum at 4525. The negative recorded the maximum of absorption in the green as at wave-length  $0.515\mu$ . The spectrogram just referred to is supplemented by plate 16 (a). The negative of which this plate is a reproduction was made with a Cramer trichromatic plate. The solution used was the same as



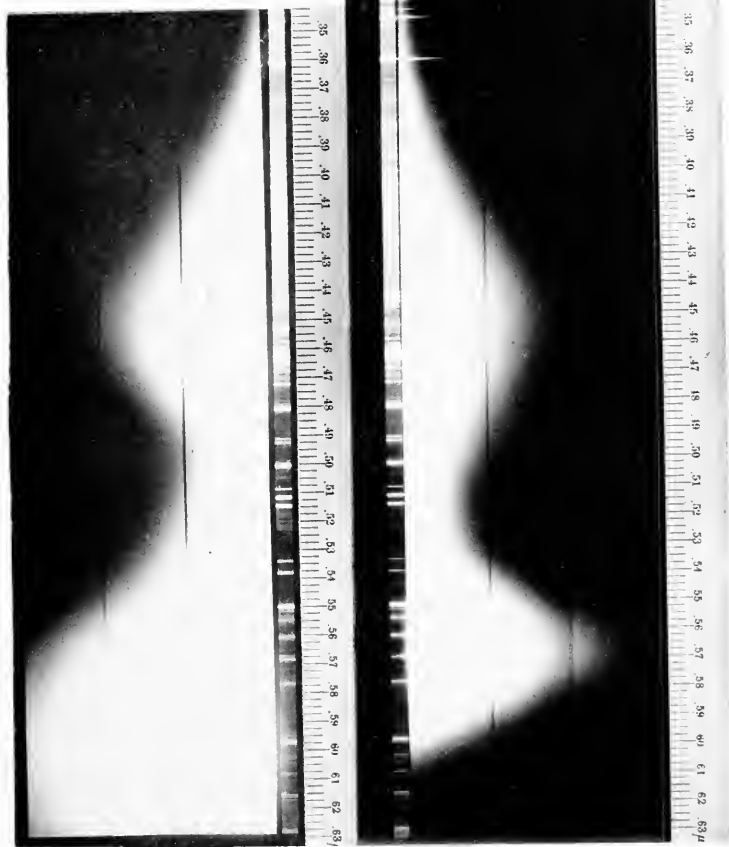

*a*

*b*



for plate 16 (*b*). The angle of the cell was about  $11.7'$  and the absorbing layer varied linearly in depth from zero to 0.11 mm. Each of the three successive exposures with the Nernst glower had a duration of two minutes.

The contour of the regions of absorption was essentially the same as recorded by the negative of plate 16 (*a*) as by the film of plate 16 (*b*). Both emulsions gave the wave-length 4525 for the more refrangible minimum of absorption. The maximum of absorption for the band in the green was at  $0.500\mu$ , according to the trichromatic plate. Therefore, the two spectrograms differed by about 150 A. U. in the wave-lengths which they give for the absorption band in the green. Since this band is wide and diffuse, it is fair to assign the number  $0.508\mu$  as the approximate position of the middle of the band. Plate 16 (*a*) shows correctly the presence of weak general absorption in the red. The spectrograms for the wedge-shaped layers of solution proved beyond question that the band in the green, as indicated by plates 14 (*a*), 14 (*b*), and 15 (*b*) for the more concentrated solutions, had actual existence and was not due solely to the weak regions of sensibility of the photographic emulsions. The two spectrograms of plates 16 (*a*) and 16 (*b*), being placed side by side, illustrate with unusual clearness the part which the photographic plate can play in producing spurious results. This is especially noticeable in the region of the spectrum between  $0.55\mu$  and  $0.63\mu$ .

To serve as a check on the data obtained by the photographic method, as well as for the sake of greater completeness, eye observations were made on the spectra of several of the solutions. The cell with the upper and lower compartments was used; hence, the length of the absorbing layer was 2.5 cm. for each solution. The solution of concentration 0.254 of calcium bromide absorbed the red only a little more than the solution which contained none of this dehydrating agent. These two solutions transmitted the yellow and green with equal intensity, at least as far as the eye could tell. The more concentrated solution absorbed almost all the violet, whereas the less concentrated one readily transmitted this color. This accounts for the fact that the former solution appeared bluish-green in the cell, whereas the latter had a clear blue tint. The solution of concentration 0.508 absorbed the red just a little more than the one of concentration 0.254. The change was too small to admit of quantitative determination with the dispersion used. For both solutions faint transmission began in the neighborhood of  $0.639\mu$ . The yellow and green are not as bright for the more concentrated solution as for the less concentrated one. Also, the former absorbed considerably more of the blue than the latter. Quantitatively, the same changes were observed when the spectrum of the solution of concentration 0.763 was compared with that of the solution of concentration 0.508. The stronger solution of this pair cut off almost all of the blue and very appreciably weakened the green.

The next solution of the series (of concentration 1.017) absorbed the red a little more than the solution of concentration 0.763. The stronger solution exerted marked general absorption on all the light transmitted, and it absorbed completely all the blue and green as far as the beginning of the yellow-green. If the extreme limits of the regions of transmission for the more concentrated solution be given roughly by  $0.630\mu$  and  $0.508\mu$ , then the corresponding wave-lengths for the less concentrated solution would be, respectively,  $0.636\mu$  and  $0.468\mu$ .

The solution which contained the greatest amount of calcium bromide (of concentration 3.804) was completely opaque to all visible light in layers of 0.93 cm. deep. A layer 0.12 cm. thick transmitted weakly a narrow band of red extending from about  $0.716\mu$  to  $0.653\mu$ . Red alone was transmitted by a layer of this solution only at 0.06 cm. in thickness. When placed in the wedge-shaped cell, the solution showed very distinctly the two bands given by plates 16 (a) and 16 (b), *i. e.*, the one in the blue-green and the other in the violet and ultra-violet. The absorption of the solution in question was so very intense that when a little of it was poured on a plane parallel piece of quartz, and allowed to drain off with the quartz placed vertically in front of the slit of the spectroscope, the band in the blue-green could be seen distinctly. The results of the freezing-point determinations for the solutions which contained copper chloride and calcium bromide are given in table 111. The dark-green solutions became much lighter in color when they were cooled down in the neighborhood of their freezing-points.

The electrical conductivities of the solutions in question were not determined.

TABLE 111.

1	2	3	4	5	6	7
Concentration of $\text{CuCl}_2$ in the mixture.	Concentration of $\text{CaBr}_2$ in the mixture.	Observed freezing-point lowering of the mixture.	Lowering of freezing-point if $\text{CaBr}_2$ alone were present.	Molecular lowering of freezing-point if $\text{CaBr}_2$ alone were present.	Molecular lowering of freezing-point for $\text{CaBr}_2$ in $\text{H}_2\text{O}$ alone.*	Column 5 minus column 6.
0.398	0.000	2.433°	.....	.....	.....	.....
0.398	0.254	4.250	1.817°	7.15°	5.22°	1.93°
0.398	0.508	6.480	4.047	7.97	5.58	2.39
0.398	0.763	8.660	6.227	8.16	5.65	2.51
0.398	1.017	11.325	8.892	8.74	6.40	2.34
0.398	1.271	14.400	11.970	9.42	7.59	1.83
0.398	1.525	18.250	15.820	10.37	8.71	1.66
0.398	2.033	28.000	25.570	12.58	10.42	2.16
0.398	2.542	40.000	37.570	14.78	13.31	1.47
0.398	3.050	56.000	53.570	17.56	15.80	1.76
0.398	3.389	.....	.....	.....	.....	.....

\* Interpolated from the results of Jones and Bassett. Amer. Chem. Journ., 33, 550 (1905).

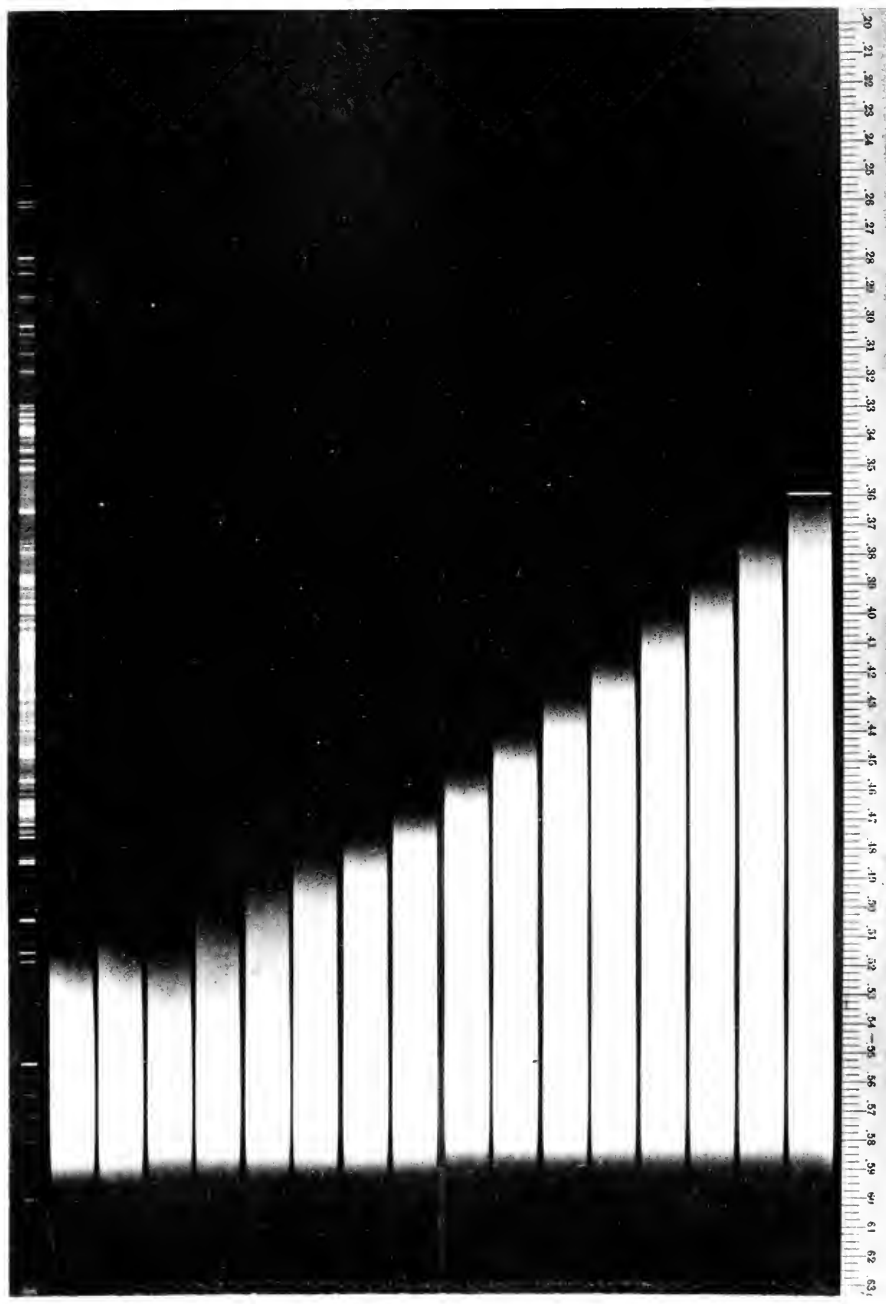



## COPPER CHLORIDE AND ALUMINIUM CHLORIDE. [See plate 17.]

The concentrations of the mother-solutions of the copper and aluminium salts were, respectively, 3.976 and 2.75. The several solutions of the series had the following concentrations of aluminium chloride: 0.000, 0.165, 0.330, 0.495, 0.660, 0.825, 0.990, 1.155, 1.320, 1.485, 1.650, 1.815, 1.980, 2.145, 2.310, 2.482. The successive differences in concentration were all equal to 0.165, except the last, which equaled 0.172. The solutions varied in color from pure blue, through various intermediate shades of greenish-blue, bluish-green, and clear green, to greenish-yellow. The photographic strip next to the numbered scale corresponds to the solution which contained only copper chloride, and the successive strips, of course, became shorter and shorter as the amount of dehydrating agent in the corresponding solutions increased. The depth of the cell was 1.41 cm.

The half-films were not developed simultaneously. The last two strips corresponding to the most concentrated solutions are not quite comparable with the first fourteen, as is shown by the fact that they extend a little too far out towards the red end of the spectrum. This was due to opening the slit of the spectrograph a little too wide as the result of an accidental blow to the micrometer head, and the failure to produce exactly the original adjustment.

The negative for the first strip recorded very faintly the intense cadmium line of wave-length 3403.7 A. U., but nothing more refrangible. The continuous background, however, barely extended to  $0.347\mu$ . According to the negative, the most concentrated solution began to transmit at  $0.504\mu$ .

Since the concentrations of the aluminium chloride are in arithmetical progression, the spectrogram shows at a glance the fundamental relation between the limit of absorption of the shorter waves and the concentration of the solution. That the curve of absorption advanced rapidly along the wave-lengths at first, and then changed by smaller steps, is shown by the fact that about 150 A. U. lie between the more refrangible ends of the third and fourth photographic strips, whereas only 50 such units are comprised in the corresponding interval between the fifteenth and sixteenth strips.

The solutions were studied in pairs, with the aid of the spectrograph and double-compartment cell. The data obtained visually, for the limits of absorption in the violet and blue, agree completely with the photographic results, and, therefore, they will not be repeated. Each solution absorbed the red a little more than the one immediately preceding, and hence the less concentrated member of the set.

The dispersion of the spectroscope was not great enough in this region to enable the observer to obtain quantitative result for consecutive solutions. The most dilute solution began to transmit red at about  $0.644\mu$ , and the most concentrated had approximately the same intensity of transmission at  $0.629\mu$ .

Therefore, since there were 16 solutions (and 15 increments of concentration), the average increase in absorption in the red was 10 A.U. Judged by the eye, the extreme solutions of the series transmitted the yellow-green with the same intensity.

The solution of concentration 2.482 of aluminium chloride was compared with some of the solutions which contained copper chloride and calcium chloride. It was found that the solution having the concentration 3.788 of calcium chloride had almost identically the same region of transmission as the most concentrated solution of the set containing aluminium chloride.

The cryoscopic data for the solutions which contained the chlorides of aluminium and copper are given below in table 112.

TABLE 112.

1	2	3	4	5	6	7
Concentration of $\text{CuCl}_2$ in the mixture.	Concentration of $\text{AlCl}_3$ in the mixture.	Observed freezing-point lowering of the mixture.	Lowering of freezing-point if $\text{AlCl}_3$ alone were present.	Molecular lowering of freezing-point if $\text{AlCl}_3$ alone were present.	Molecular lowering of freezing-point for $\text{AlCl}_3$ in $\text{H}_2\text{O}$ alone.	Column 5 minus column 6.
0.398	0.000	2.433°	.....	.....	.....	.....
0.398	0.165	3.900	1.467°	8.89°	5.72°	3.17°
0.398	0.330	5.740	3.307	10.02	6.27	3.75
0.398	0.495	7.850	5.417	10.94	7.02	3.92
0.398	0.660	10.325	7.892	11.96	7.80	4.16
0.398	0.825	13.300	10.870	13.18	8.79	4.39
0.398	0.990	17.000	14.570	14.72	9.92	4.80
0.398	1.155	21.800	19.370	16.77	11.11	5.66
0.398	1.320	27.000	24.570	18.61	12.55	6.06
0.398	1.485	32.500	30.070	20.25	14.04	6.21
0.398	1.650	38.800	36.370	22.04	15.65	6.39
0.398	1.815	46.500	44.100	24.30	17.57	6.73
0.398	1.980	55.500	53.100	26.82	19.50	7.32
0.398	2.145	66.000	63.600	29.65	21.43	8.42
0.398	2.310	(?)	.....	.....	.....	.....

TABLE 113.

Concentration of $\text{AlCl}_3$ .	Conductivity.	Concentration of $\text{AlCl}_3$ .	Conductivity.
0.000	0.02996	1.485	0.05917
0.165	0.04264	1.650	0.05504
0.330	0.05312	1.815	0.05028
0.495	0.05834	1.980	0.04584
0.660	0.06150	2.145	0.04054
0.990	0.06366	2.310	0.03486
1.155	0.06400	2.482	0.02924
1.320	0.06273	.....	.....



The electrical conductivities, together with the corresponding concentrations of the solution containing copper chloride and aluminium chloride, are given in table 113. The numbers in the second and fourth columns are expressed in reciprocal ohms and reciprocal centimeters.

The data of table 113 are shown graphically by fig. 76. The abscissæ denote concentrations of aluminium chloride, and the ordinates give the

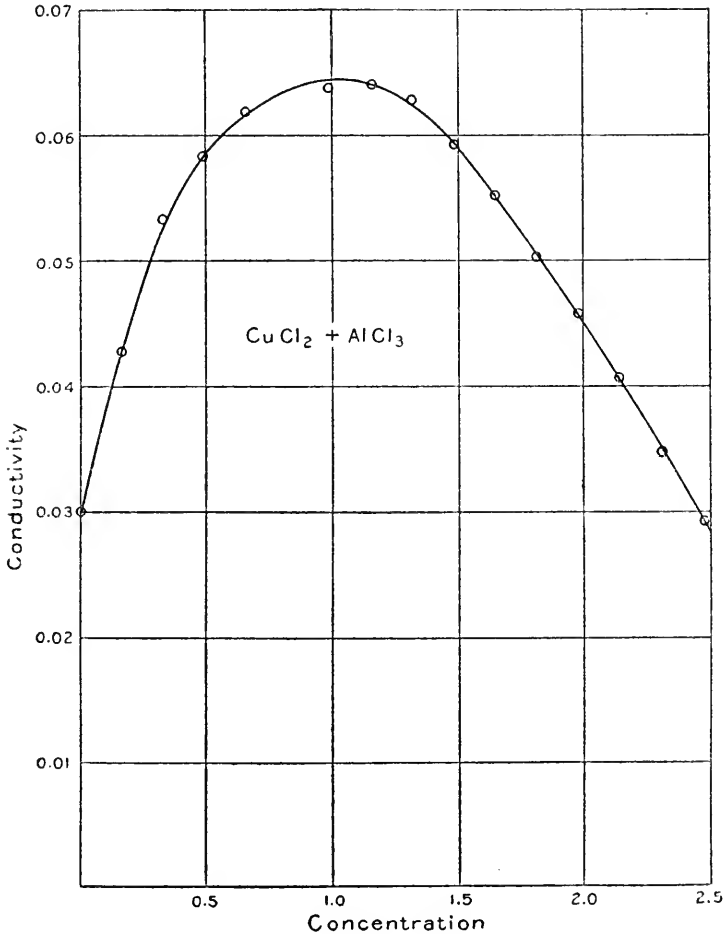

FIG. 76.

corresponding conductivities of the solution. This curve has a marked maximum like all the four preceding curves. Moreover, the concentration associated with the maximum of conductivity in question has the value 1.1, and this is exactly the same value as was found for the corresponding point of the curve pertaining to the solutions which contained cobalt chloride and aluminium chloride.

COPPER BROMIDE AND CALCIUM CHLORIDE. [See plates 18 (a) and 18 (b).]

The concentrations of the mother-solutions of copper bromide and calcium chloride were, respectively, 2.186 and 4.51. The concentrations of the chloride in the solutions, whose absorption spectra are given by the plates designated above, were 0.000, 0.451, 0.902, 1.353, 1.804, 2.255, 2.706, 3.157, 3.608, and 4.059. The successive differences in concentration were all equal to 0.451. The concentration of the copper bromide in all the solutions had the constant value 0.219. By transmitted daylight the solutions in columns 2.5 cm. long had colors that varied from greenish-blue through various shades of green and brownish-green to dark reddish-brown. The photographic strip nearest to the number scale of plate 18 (b) corresponds to the solution that contained only the one salt. The remaining strips succeed one another in the order of increasing amounts of calcium chloride in the solutions, so that the strip adjacent to the comparison spectrum pertains to the solution of concentration 4.059. The depth of the cell was 1.41 cm.

Of the various facts brought out by the negative for plate 18 (b), the following are the most striking: In the most dilute solution, transmission began at  $0.377\mu$ ; the second photographic strip began at  $0.382\mu$ . On the negative the fourth and fifth strips commenced at about, respectively,  $0.419\mu$  and  $0.499\mu$ . Consequently, when the concentration of the calcium chloride was changed from 0.000 to 0.451, the end of the absorption band in the ultra-violet and violet was displaced towards the red by 50 A.U. Again, when the concentration of the dehydrating agent varied from 1.353 to 1.804, the above-mentioned end of the absorption band was displaced by 300 A. U. in the same direction. Therefore, as is easily seen from the spectrogram, up to a certain concentration the end of the band encroached more rapidly on the region of longer waves as the concentration of calcium chloride increased. In all the cases discussed in the preceding pages, the successive increments of absorption decreased steadily as the concentration of the dehydrating agent increased in arithmetical progression. As just noted, the change is exactly the reverse for the solutions of copper bromide and calcium chloride. With the sixth photographic strip the end of the absorption band altered somewhat its nature. The negative showed that very weak transmission began at about  $0.478\mu$ , and extended over a relatively wide range of wave-lengths. In fact, comparatively intense transmission began only near  $0.528\mu$ . The negative strip corresponding to the most concentrated solution showed that transmission was weak and began in the neighborhood of  $0.522\mu$ .

The negative of which plate 18 (a) is a reproduction was taken with a Cramer trichromatic plate. The photographic strip adjacent to the scales corresponds to the most concentrated solution of the set, and the strip at the opposite side of the spectrogram corresponds to the solution of concentration 2.55. The depth of the cell was 1.41 cm. Each exposure to the light

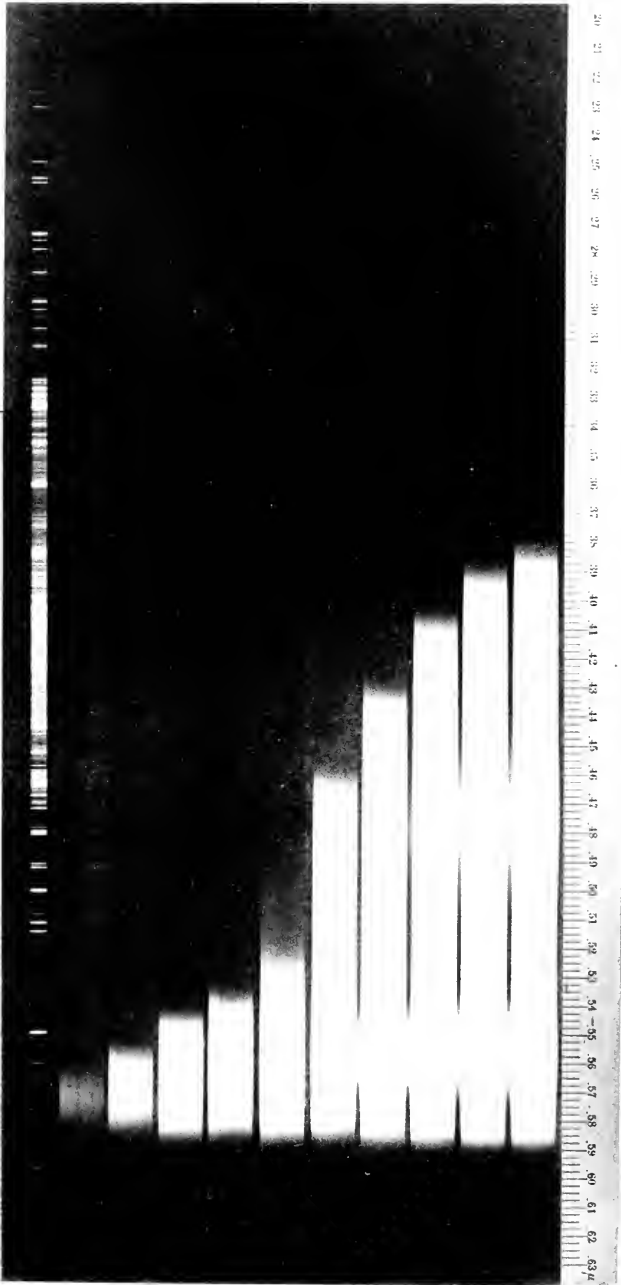
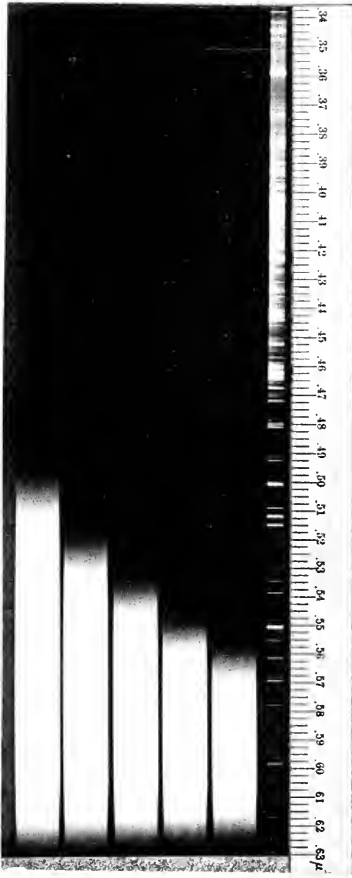

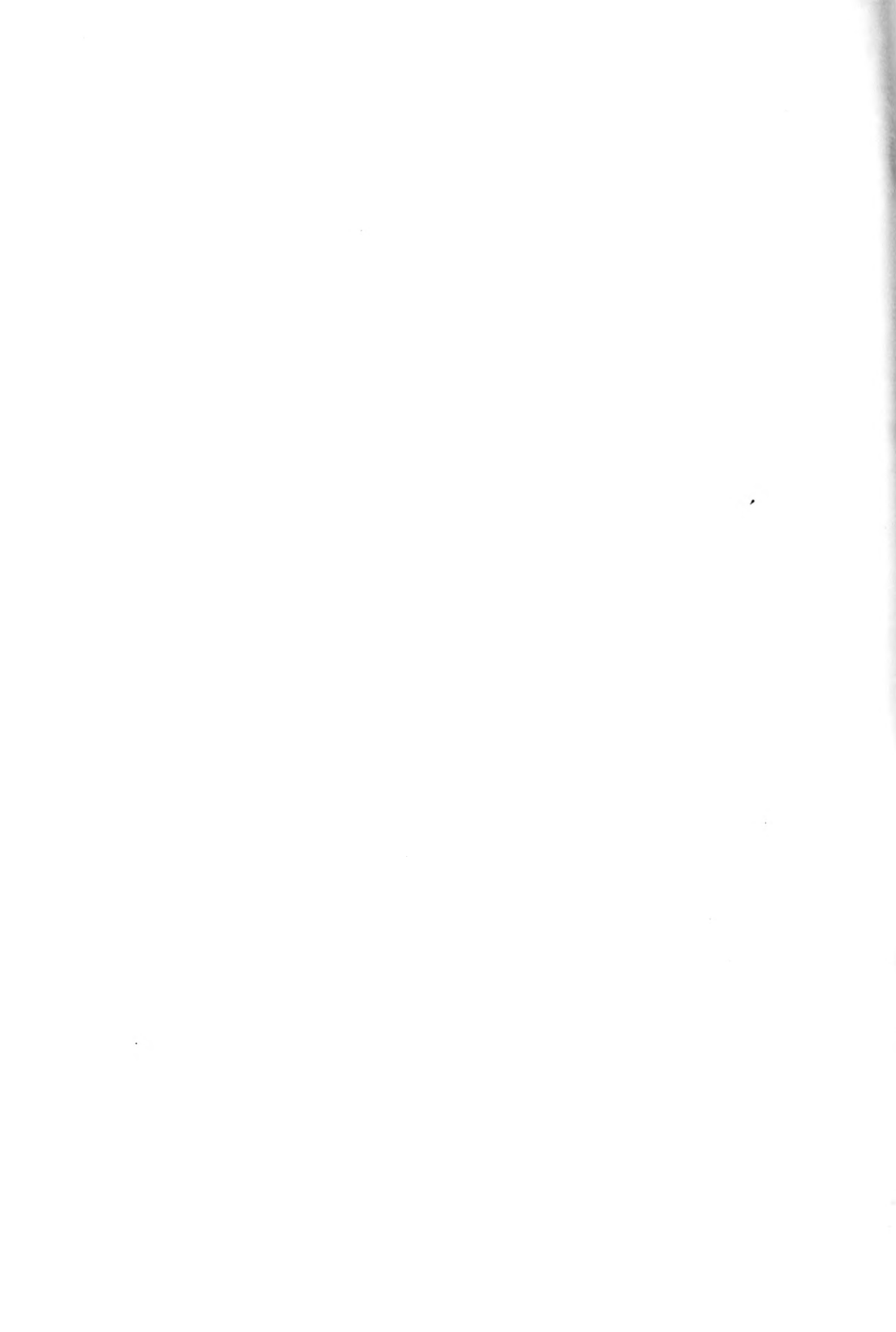

from the Nernst filament was two minutes in length. The negative strip last mentioned showed that faint transmission began near  $0.485\mu$  and continued weak to about  $0.494\mu$ . The apparent lack of agreement between the sixth strip of plate 18 (b) and the fifth strip of plate 18 (a) is due as much to the difference in length of the respective exposures as to the peculiarities of the photographic emulsion. Plate 18 (a) recorded the beginning of transmission as at wave-length  $0.552\mu$ , and this is exactly the same as was obtained from the negative of plate 18 (b).

Eye observations were made on the solutions in pairs, with the aid of the two-compartment cell. The results obtained by the spectroscope confirmed in detail those derived from the negative. It was noted especially that the successive increments of absorption of the band in the violet at first increased with the like change in concentration, and then decreased for the most concentrated solutions. The band in the red extended to the shorter wave-lengths by such small increments, when the passage from one solution to its more concentrated successor was made, that it was only possible to obtain the average value of this displacement. Transmission of equal intensity for the most concentrated solution, and for the one which contained no calcium chloride, began, respectively, at  $0.647\mu$  and  $0.667\mu$ . Since there were nine differences in concentration, the average value of the shift of the end of the band in the red was about 22 A. U. When the spectrum of the most dilute solution was compared with that of distilled water, it was observed that the former lacked the deep-red and the bright-red, and began in the orange-red. These two spectra in the order named appeared to commence, respectively, at  $0.663\mu$  and  $0.772\mu$ .

The freezing-point lowerings of the solution containing copper bromide and calcium chloride are given in table 114.

TABLE 114.

1	2	3	4	5	6	7
Concentration of $\text{CuBr}_2$ in the mixture.	Concentration of $\text{CaCl}_2$ in the mixture.	Observed freezing-point lowering of the mixture.	Lowering of freezing-point if $\text{CaCl}_2$ alone were present.	Molecular lowering of freezing-point if $\text{CaCl}_2$ alone were present.	Molecular lowering of freezing-point for $\text{CaCl}_2$ in $\text{H}_2\text{O}$ alone.*	Column 5 minus column 6.
0.219	0.000	1.200°	.....	.....	.....	.....
0.219	0.451	4.090	2.890°	6.41°	5.20°	1.21°
0.219	0.902	7.620	6.420	7.12	6.12	1.00
0.219	1.353	11.70	10.50	7.76	7.18	0.58
0.219	1.804	16.95	15.75	8.73	8.38	0.35
0.219	2.255	24.50	23.30	10.33	10.03	0.30
0.219	2.706	33.50	32.30	11.94	11.70	0.24
0.219	3.157	45.70	44.50	14.10	13.89	0.21
0.219	3.608	58 (?)	.....	.....	.....	.....

\*Interpolated from the results of Jones and Bassett: Amer. Chem. Journ., 33, 546 (1905).

The solution of concentration 3.157 changed from reddish-brown at room temperature, to greenish-yellow in the neighborhood of its freezing-point. Salts separated out at about  $-58^{\circ}$  for the solution which had the concentration 3.608, and hence the freezing-point lowering could not be determined.

COPPER BROMIDE AND CALCIUM BROMIDE. [See plates 7 (*b*), 19 (*a*), 19 (*b*), 20 (*a*), and 20 (*b*).]

The concentrations of the mother-solutions of copper bromide and of calcium bromide were, respectively, 2.186 and 4.236. The constant concentration of the copper salt in all of the solutions was 0.219. The concentrations of the calcium bromide were 0.000, 0.254, 0.508, 0.762, 1.017, 1.271, 1.525, 1.779, 2.033, 2.287, 2.542, 2.796, 3.050, 3.304, 3.588, and 3.807. All of the successive differences of concentration were equal to 0.2542, except the last one, which had the value 0.249.

The most pronounced colors of these solutions in the order of increasing concentration of the dehydrating agent, were light-blue, bluish-green, green, yellowish-green, brownish-green, and dull brown.

The spectrogram of plate 7 (*b*) will be discussed first. The negatives were taken on Cramer trichromatic plates. The photographic strip adjacent to the scales corresponds to the seventh solution of the series; that is, to the solution which had the concentration 1.525. The depth of the cell was 1.41 cm. Each exposure to light from the glower was 2.25 mm. in length. A spark exposure of 1.5 mm. was given for each one of the strips which pertained to the three most dilute solutions of the set. The negative strip for the solution which did not contain any calcium bromide recorded the beginning of faint transmission at 0.373. The strip pertaining to solution of concentration 1.107 showed that transmission began at  $0.436\mu$  and continued to be weak to about  $0.520\mu$ . Transmission was strong from  $0.520\mu$  to the end of the negative.

The darkening of the next negative strip commenced very faintly at about  $0.504\mu$ , and became very gradually more intense. The strip associated with the solution of concentration 1.525 showed extremely weak transmission from  $0.546\mu$  to the end of the plate, the maximum being at 5875 A. U.

The facts presented by the negative of which plate 19 (*b*) is a reproduction will now be considered. The first eight solutions of the complete series were photographed. The depth of the cell was 0.06 cm., and, therefore, the solutions when in the cell showed practically no color. The strips contiguous to the numbered scale and to the comparison spectrum correspond, respectively, to the solutions of concentration 0.000 and 1.779 of the dehydrating agent. The times of exposure for the glower and spark were as usual. The strip pertaining to the most dilute solution recorded the very faintest trace of the air-line at 3007.0 A.U.; the continuous background, however, ceased near  $0.308\mu$ . The negative strip corresponding to the 8th solution showed that transmission began near  $0.400\mu$ . When due allowance is made for the

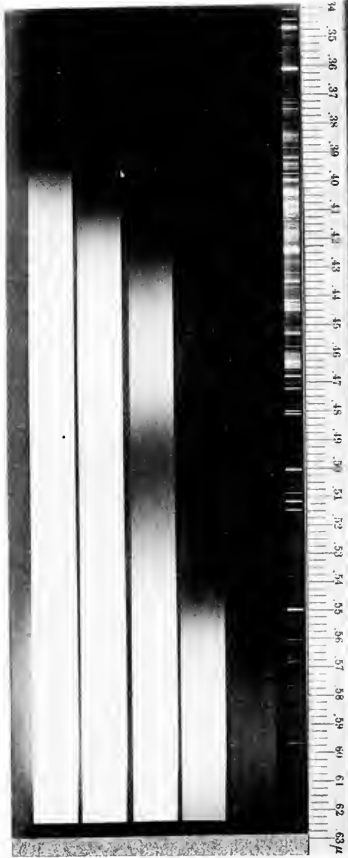

a

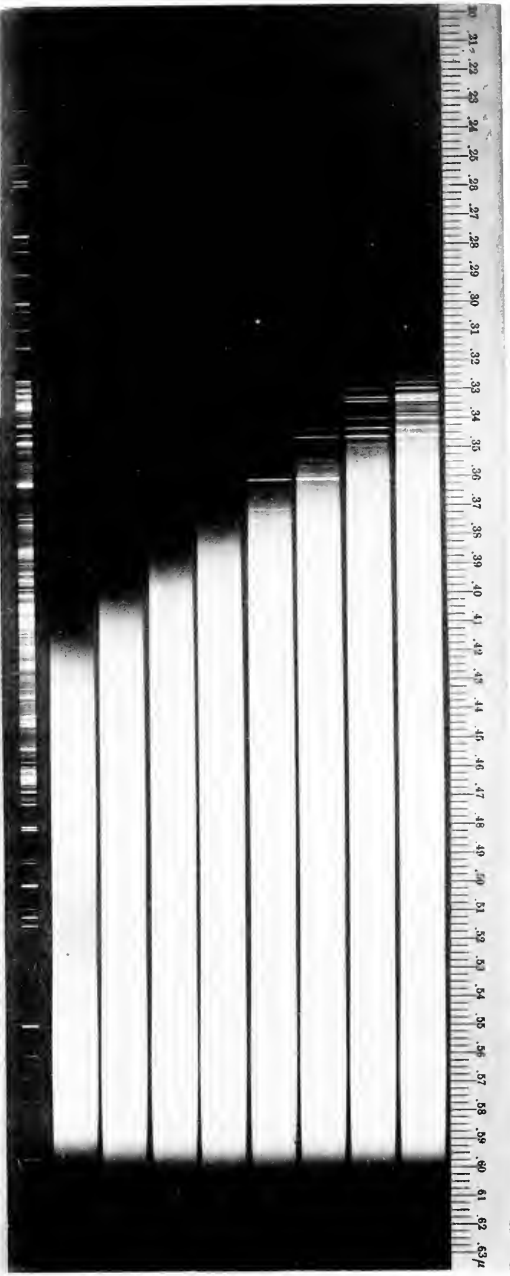

b





known disturbing influences, the eight strips of plate 19 (*b*) seem to show that the end of the ultra-violet absorption band shifted directly proportional to the increments of concentration of the calcium bromide.

It is now desirable to give the most salient points relative to plate 19 (*a*). The negative of the spectrogram in question was made with a Cramer trichromatic plate. The 7th to the 11th solutions, inclusive, had their spectra recorded by this plate. The strips pertaining to the solutions of concentration 1.525 and 2.542 are, respectively, nearest to the outside edge of plate 19 (*a*) and to the scale. The depth of the cell was 0.06 cm. The duration of each exposure to the radiation of the filament was 2.25 mm. Hence, the 7th and 8th solutions of the complete series have their absorption spectra given by both plates 19 (*a*) and 19 (*b*). The negative strip, corresponding to solution of concentration 1.525, showed that transmission began at  $0.383\mu$ . The third strip, counting from the outer edge of plate 19 (*a*), recorded  $0.417\mu$  for the beginning of transmission, and  $0.500\mu$  for the middle of the region of rather weak transmission. The fourth strip showed very weak transmission from  $0.436\mu$  to  $0.484\mu$ , then apparent absorption from  $0.484\mu$  to about  $0.530\mu$ , and finally stronger transmission from  $0.530\mu$  to the end of the spectrogram. The negative strip pertaining to the solution of concentration 2.542 recorded very weak transmission from  $0.555\mu$  to the end of the plate.

The most concentrated solution of the set was so opaque to light, that its absorption spectrum could only be satisfactorily recorded by the aid of the wedge-cell. For plate 20 (*b*) the angle of the liquid wedge was about  $11.7'$ , and the depth of the absorbing layer increased linearly from zero mm. to 0.11 mm. In the cell the solution appeared to be deep red. The absorption band in the blue-green could be distinctly seen with the aid of the eyepiece. The edges of this band are very diffuse and poorly defined. The exposures were as usual. Obviously the edge of the negative closest to the comparison spectrum was produced by the light that passed through the least depth of the solution, *i. e.*, nearest to the refractive edge of the liquid prism. Even for the thinnest layers the continuous background was completely absorbed from  $0.200\mu$  to about  $0.240\mu$ . The negative showed that the absorption began to decrease in the vicinity of  $0.335\mu$ , and continued to do so, according to a curve of gentle slope, until it reached a minimum at  $0.455\mu$ . From this point on the absorption increased to a maximum near  $0.517\mu$ , and then diminished again at the less refrangible side of the absorption band.

Except in so far as the wave-length of the middle of the absorption band in the green is concerned, plate 20 (*a*), whose negative was taken with a Cramer trichromatic plate, fully confirms the facts as recorded by the spectrogram of plate 20 (*b*). The angle of the wedge was only  $7.8'$ , and since the least depth was zero, the greatest depth of absorbing layer was about 0.08 cm. The three successive exposures to the light from the glower were each given

2.25 minutes. The negative was somewhat under-developed. It gave for the first maximum of transmission the wave-length  $0.454\mu$ . The maximum\* of absorption in the green was recorded as  $0.500\mu$ . The spectrogram of plate 19 (a) gives a more correct graphical representation of the band in the blue-green than does that of plate 19 (b). The asymmetry of this band, and its greater width of penumbra on the less refrangible side, was confirmed directly by observations.

The results obtained by a rather extended series of eye observations on the solutions that contained copper bromide and calcium bromide will now be given in some detail.

The solutions were first studied in pairs by the aid of the double-compartment cell. The length of each absorbing column was, therefore, 2.5 cm. As the solutions became more and more concentrated, the band in the red gradually shifted its visible boundary to shorter wave-lengths. The increments of absorption in the violet and blue appeared to become greater and greater as the more and more concentrated solutions were studied. The solution of concentration 1.107 of calcium bromide absorbed the blue-green and blue almost completely, and also dimmed the entire region of transmission appreciably more than the next less concentrated solution. In like manner the solution of concentration 1.271 showed throughout weaker transmission than the next lower member of the series, and it absorbed completely all colors more refrangible than the green. In addition, this color was greatly weakened in intensity. The last two solutions just mentioned showed at the more refrangible side of the green a fairly long region of transmission, which was so extremely faint that the eye could not detect any color as such, but only an indefinite gray. The spectrum of the solution whose concentration was 0.254 was compared with that of distilled water. Very weak transmission of the same intensity began at  $0.665\mu$  and  $0.770\mu$ , respectively, for the solution and for the pure water. The solution also absorbed the extreme violet quite noticeably.

In order to study with the spectroscope the solutions of greater concentration than 1.525, as well as to obtain checks on the data obtained photographically, the cell sketched in fig. 66 was adjusted to a depth of 0.06 cm. and arranged so as to be used with its axis of figure horizontally. The following facts were then observed and noted: In this cell the solution of concentration 2.033 had a light, yellowish-brown color. The spectrum extended from about  $0.747\mu$  to  $0.425\mu$ . The weakening of transmission in the blue-green was very delicate.

The spectrum transmitted by the solution of concentration 2.287 began about  $0.740\mu$ , and continued to be uniformly bright to, say,  $0.540\mu$ . At this wave-length the penumbra of the absorption band in the blue-green com-

---

\*Not the center of the band in the green.

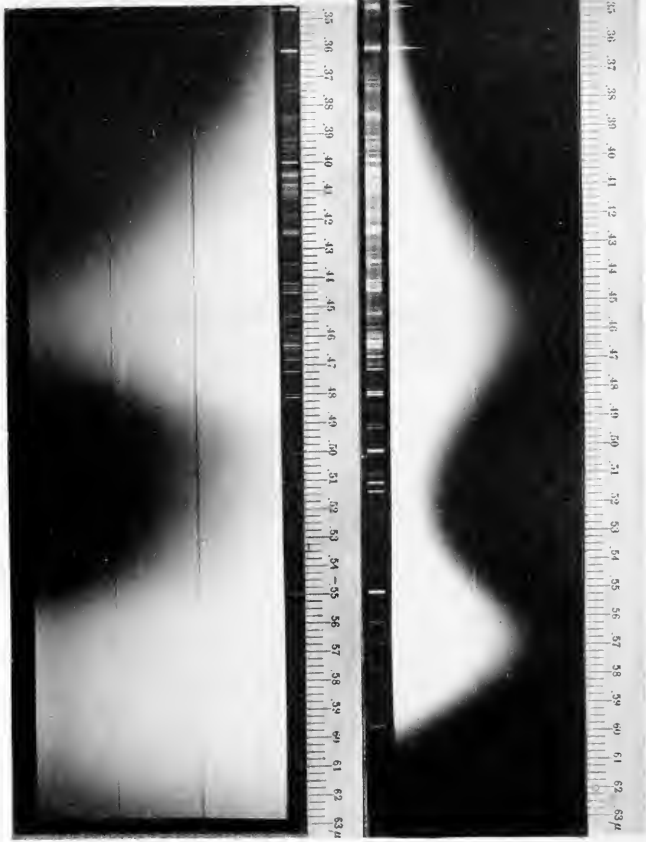

a

b



menced. The maximum of absorption appeared to have the position given by  $0.500\mu$ . This absorption was not complete, since a little light could be seen at all points of the band, not excepting the maximum. Beyond this band transmission rose to a maximum near  $0.465\mu$ , and then faded away to nothing in the vicinity of  $0.435\mu$ .\* The spectrum of the next solution in order of concentration 2.542 was apparently more complex than that of any other solution of the series. Transmission began at  $0.737\mu$ , rose to a maximum at  $0.652\mu$ , and then increased in intensity to  $0.603\mu$ . From this point to about  $0.545\mu$  the brightness of the spectrum seemed to remain constant, but much less bright than at the wave-length  $0.652\mu$ . A definite absorption band, whose middle was approximately at  $0.508\mu$ , began near  $0.545\mu$ . Beyond this band transmission rose to a maximum at  $0.465\mu$ , and then gradually faded out to zero value in the neighborhood of  $0.445\mu$ .

TABLE 115.

1	2	3	4	5	6	7
Concentration of $\text{CuBr}_2$ in the mixture.	Concentration of $\text{CaBr}_2$ in the mixture.	Observed freezing-point lowering of the mixture.	Lowering of freezing-point if $\text{CaBr}_2$ alone were present.	Molecular lowering of freezing-point if $\text{CaBr}_2$ alone were present.	Molecular lowering of freezing-point for $\text{CaBr}_2$ in $\text{H}_2\text{O}$ alone.	Column 5 minus column 6.
0.219	0.000°	1.200°	.....	.....	.....	.....
0.219	0.254	2.836	1.636°	6.44°	5.22°	1.22°
0.219	0.508	4.550	3.350	6.59	5.58	1.01
0.219	0.762	6.696	5.496	7.21	5.76	1.45
0.219	1.017	9.075	7.875	7.74	6.40	1.34
0.219	1.271	11.900	10.700	8.42	7.75	0.67
0.219	1.525	15.350	14.150	9.28	8.71	0.57
0.219	1.779	19.500	18.300	10.29	9.03	1.26
0.219	2.033	24.000	22.800	11.21	10.42	0.79
0.219	2.287	29.500	28.300	12.37	11.93	0.44
0.219	2.542	36.000	34.800	13.69	13.31	0.38
0.219	2.796	43.500	42.300	15.13	14.56	0.57
0.219	3.050	52.400	51.200	16.79	15.80	0.99
0.219	3.304	66.500	65.300	19.76	17.05	2.71
0.219	3.558	(?)	.....	.....	.....	.....

The transmission spectra of the solutions just discussed were comparatively bright, and extended over relatively wide regions of wave-lengths, while the spectra to be described below were less intense and much prescribed. In other words, the transition was rather abrupt.

The solution of concentration 2.796 began to be transparent at  $0.735\mu$ . The spectrum rose to a maximum of intensity near  $0.657\mu$ , and then gradually fell off to small intensity at  $0.600\mu$ . Transmission was pretty uniform between

\*The numbers given for the extreme limits of transmission are obviously not very accurate, and are merely intended to suggest the positions of these boundaries.

0.600 $\mu$  and 0.550 $\mu$ . At the latter wave-length the light decreased abruptly to zero. There was no visible return of transmission in the region of the shorter waves.

Transmission began at 0.730 $\mu$ , rose to a maximum at 0.660 $\mu$ , and decreased to almost no color near 0.590 $\mu$  for the solution of concentration 3.050. An extremely weak region of transmission extended from a little beyond 0.590 $\mu$  to 0.575 $\mu$ . Because of its faintness, the subjective color throughout this region was gray.

The solution of concentration 3.304 transmitted chiefly bright red. The extreme limits of the spectrum were approximately 0.733 $\mu$  and 0.625 $\mu$ , the brightest spot being at 0.670 $\mu$ . Only red from about 0.730 $\mu$  to 0.640 $\mu$  was transmitted by the solution of concentration 3.558. Finally, the most concentrated solution of the series transmitted red from about 0.725 $\mu$  to 0.650 $\mu$ . The most intense portion of this spectrum was near 0.684 $\mu$ .

The lowerings of the freezing-point of water produced by the solutions which contained copper bromide and calcium bromide are given in table 115, page 229.

The solution of concentration 3.558 could not be frozen within the range of the scale of the thermometer, *i. e.*, between zero and  $-80^{\circ}$ .

#### COPPER BROMIDE AND ALUMINIUM CHLORIDE. [See plates 21 (a) and 21 (b).]

The concentrations of the mother-solutions of copper bromide and aluminium chloride were, respectively, 2.186 and 2.75. In the series of solutions discussed below, the constant concentration of the copper salt was 0.219. The concentrations of the dehydrating agent were 0.000, 0.275, 0.550, 0.825, 1.100, 1.375, 1.650, 1.925, 2.200, 2.480. All the successive differences in concentration are equal to 0.275, except the last increment, which equals 0.280. As the amount of the dehydrating agent increased, the solutions changed from greenish-blue to brown, passing through various intermediate shades of bluish-green, green, olive, and brownish-green. The photographic strips corresponding, respectively, to the solutions which contained none of the aluminium chloride, and the greatest amount of this salt, are adjacent to the numbered scale and to the comparison spectrum. The depth of the cell was 1.41 cm. The most noticeable facts shown by the negative of plate 21 are the following:

The faintest trace of the intense cadmium doublet at 3612 was recorded by the strip corresponding to the aqueous solution which contained only copper bromide. The continuous background, however, faded out at about 0.371 $\mu$ . The spectrogram shows very clearly that for the first seven or eight solutions the absorption band, which included the entire ultra-violet region, advanced by ever-increasing increments as the concentration of the aluminium chloride became greater and greater. The seventh negative strip



a

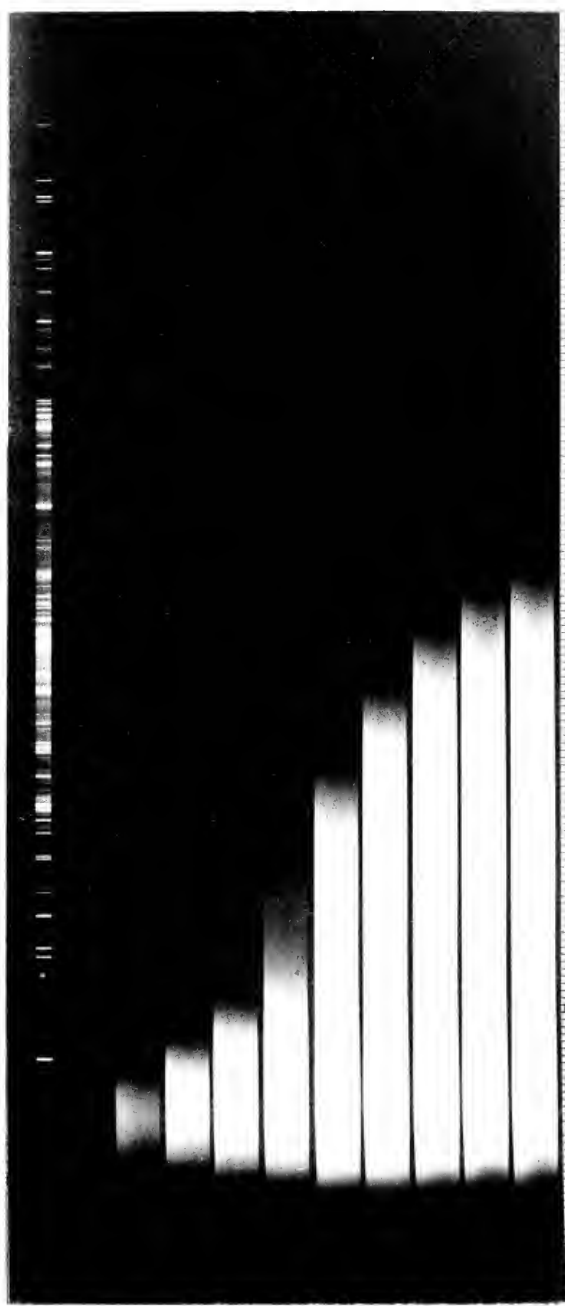

b





showed that transmission began at  $0.502\mu$ , and increased very gradually to about  $0.527\mu$ . From this point on the solution was quite transparent. The strip corresponding to the most concentrated solution recorded relatively weak transmission of the parts of the spectrum less refrangible than  $0.554\mu$ .

The negative of which plate 21 (a) is a reproduction was taken with a Cramer trichromatic plate. The photographic strips correspond to the five more concentrated solutions of the complete set of ten. Obviously the strip nearest to the scales pertains to the solution which contained the greatest amount of aluminium chloride. The depth of the cell was here also 1.41 cm. The time of exposure for the Nernst glower was two minutes. The strip corresponding to the solution of concentration 1.375 showed that transmission began weakly at  $0.473\mu$ , approached gradually its full value, and continued complete nearly to the end of the plate. The photographic record began at about  $0.552\mu$  for the strip pertaining to the most concentrated solution. The general outline suggested by the ends of photographic strips of plate 21 (a) (which ends show the beginnings of transmission) curves in a direction exactly opposite to that of the contour outlined by the first five strips of plate 21 (b). In other words, for the more concentrated solutions of the series, the successive increments of absorption decreased as the concentration of the aluminium chloride increased. By means of the two-compartment cell, eye observations were made on the solutions in pairs. The results obtained photographically were confirmed in all respects. One of the most important facts noted was that as the concentration of the dehydrating agent increased in arithmetical progression, the successive increments of the absorption region, which comprised the ultra-violet, first increased and then subsequently decreased. Stated otherwise, the curve of absorption apparently possessed a point of inflection. The existence of the comparatively long region of weak transmission of the green for the 6th solution was established visually as well as photographically. As far as the red end of the spectrum was concerned, every solution absorbed the red a little more than the next less concentrated member of the series. It was only possible to obtain a value for the mean displacement of the red or orange end of the spectrum. For the aqueous solution which contained only copper bromide, and for the most concentrated member of the set, transmission of about the same intensity began, respectively, at  $0.670\mu$  and at  $0.645\mu$ . Therefore, since there were ten solutions in the series, the average displacement of the red end of the spectrum was 10 A. U.

The lowerings of the freezing-point of water produced by the solutions which contained copper bromide and aluminium chloride are recorded in the table on the following page.

The solution of concentration 1.925 changed from reddish-brown to pea-green as the temperature fell from room value to the neighborhood of  $-50^{\circ}$ .

TABLE 116.

1	2	3	4	5	6	7
Concentration of $\text{CuBr}_2$ in the mixture.	Concentration of $\text{AlCl}_3$ in the mixture.	Observed freezing-point lowering of the mixture.	Lowering of freezing-point if $\text{AlCl}_3$ alone were present.	Molecular lowering of freezing-point if $\text{AlCl}_3$ alone were present.	Molecular lowering of freezing-point for $\text{AlCl}_3$ in $\text{H}_2\text{O}$ alone.	Column 5 minus column 6.
0.219	0.000	1.200°	.....	.....	.....	.....
0.219	0.275	3.538	2.338°	8.50°	6.05°	2.45°
0.219	0.550	6.900	5.700	10.36	7.30	3.06
0.219	0.825	11.200	10.000	12.12	8.79	3.33
0.219	1.100	17.100	15.900	14.45	10.71	3.74
0.219	1.375	25.500	24.300	17.67	13.06	4.61
0.219	1.650	36.000	34.800	21.09	15.65	5.44
0.219	1.925	51.000	49.800	25.87	22.07	3.80
0.219	2.200	(?)	.....	.....	.....	.....

On account of excessive undercooling it was not possible to freeze the solution of concentration 2.200 with the mixture of ethyl alcohol and solid carbon dioxide. This solution became a light-green, very viscous jelly at  $-75^\circ$ .

### GENERAL SUMMARY OF RESULTS.

#### DISCUSSION OF THE SEVERAL THEORIES.

The theory of Engel, that the blue color of solutions of cobalt chloride is due to the presence of double salts, appears to us untenable for a number of reasons. In the first place, it has been shown by Jones and Ota\* and Jones and Knight† that double chlorides in general, even in very concentrated solutions, are largely broken down into the single salts which are dissociated in the usual manner. In such solutions we should not have simply the molecules of the double salt, but a large number of the ions resulting from the dissociation of such a compound.

Again, this theory is entirely out of accord with the fact that a strong, aqueous solution becomes blue when heated. The increase in the hydrolysis with the comparatively slight rise in temperature is not sufficient to liberate enough hydrochloric acid to account for this color change on the basis of a compound being formed with this acid.

Further, this theory is not in accord with the color changes which manifest themselves when water is added to solutions of cobalt chloride, etc., in methyl and ethyl alcohols and acetone, where no double salt can be present.

The following consideration would appear to have very direct bearing upon the theory under discussion: An examination of the spectrogram will show that with increasing amounts of the dehydrating agents or salt the

\* Amer. Chem. Journ., 22, 15 (1899).

† *Ibid.*, 22, 110 (1899).

absorption bands widen out. With increasing amounts of the dehydrating agents used in this work more and more of the double halides, if they existed, would be formed, since the solutions would be more and more concentrated. This would mean that the vibrating, charged particle was becoming more and more complex. The above facts are not in harmony with one another. The most probable interpretation of the widening of the absorption bands with increase of concentration, is that the vibrating charged particle is becoming of smaller and smaller mass, and can thus vibrate in resonance with a larger number of wave-lengths.

There are also a number of objections to the theory proposed by Ostwald to account for the color changes of cobalt chloride. It will be recalled that Ostwald takes the view that the blue color is due to the cobalt molecule, and the red color to the cobalt ion. This would not account for the great color change produced by warming a concentrated, aqueous solution of cobalt chloride. The dissociation would decrease a very small amount for the change in temperature from, say, 25° to 75° or 80°, as is shown by the work of Jones and West\* and especially by that of Noyes and Coolidge.† This slight change in the dissociation would be entirely incapable of accounting for the marked color changes produced. Further, the amount of hydrochloric acid liberated as the result of the increased hydrolysis with rise in temperature would be far too small to drive back the dissociation sufficiently to produce such marked changes in color.

Another objection to this view is that the amount of water required to color a blue alcoholic solution red is altogether too small to produce a sufficient increase in the dissociation to cause the observed color change.

Further, the amount of water that is required to change very appreciably the color of a solution of cobalt chloride rendered blue by the presence of aluminium chloride is very small, indeed, as is shown by table 108. The small amount of water could not, of course, materially increase the dissociation of the solution of cobalt chloride.

This shows that we can not account for the color changes solely, or even primarily, on the basis of dissociation.

That there are serious objections to the theory of Donnan and Bassett, that the blue color is due to complex ions of cobalt, is made evident by the following considerations:

The alcoholic solutions show in general the same color changes when water is added, as are manifested by the aqueous solutions in the presence of dehydrating agents. A comparison of the spectrograms in this section, and the eye observations, with those in the latter part of this monograph, will show that the same absorption bands appear in the aqueous and in the non-aqueous

\* Amer. Chem. Journ., 34, 357 (1905).

† Ztschr. phys. Chem., 46, 323 (1903).

solutions. These bands, however, undergo the well-known shift in position, due to a change in the dielectric constant of the medium produced by the presence of more and more of the dehydrating agent. It is at least very doubtful whether we would have the same ionic complexes in the non-aqueous solutions as in the solutions in water as the solvent.

Having pointed out the most serious defects in the various theories that have been proposed to account for such color changes as have been dealt with in this section, we shall now show how all the facts recorded in the preceding pages seem to confirm the hydrate theory in the form originated and emphasized by Jones.

Since the relations between the selective absorption of light and the existence of hydrates may not be obvious, a brief discussion of this matter will now be given. Of course, in the present stage of our knowledge of the nature of solutions, it is not possible to form a detailed mechanical conception of the various processes that came into play in solutions when arbitrary changes are made in concentration, in the temperature, in the solvent, etc. Nevertheless, the general view which we hold may be explained as follows: In the first place the phenomenon of absorption is primarily one of resonance, and since light waves are electromagnetic waves, it follows that the absorbing system must be electrical in its nature. The energy of a vibration of a given period will be absorbed to the greatest extent by a system whose natural period of vibration is most nearly equal to that of the first vibration, and it may not be absorbed at all by a system whose period differs appreciably from that of the incident waves. In this way the selective phase of the phenomenon of absorption is explained. It is almost superfluous to state that the resonator of which we are conceiving may be very complex, and may have any finite number of discrete periods of vibration. Exactly how this resonator is related to the ion of electrolysis, as this term is usually understood, can not be decided at present. Nor is this relationship a matter of fundamental importance to the question of the existence or non-existence of hydrates. It seems natural to suppose that the vibrations of this resonator would be strongly influenced by the nature of the medium surrounding it, not only by virtue of changes in the viscosity, specific inductive capacity, etc., of the medium, but also by the condensation around it or near it of complexes of water molecules. The way in which these complexes or hydrates might affect the absorption of the resonator is as follows: The vibration of a given period of the resonator might be so greatly damped, either directly or indirectly, by the hydrate, that its amplitude would fall below the value which marks the limit of our experimental means of detecting absorption.

If this were the case we should not be aware of the existence of the absorption, and we should therefore say that no absorption of the given period takes

place. In fact, when we say that pure water is transparent to light of one given period (for example, the  $D_3$  line of helium), we do not mean that the absorption is absolutely zero, with mathematical exactness, but we do mean that it is perhaps indefinitely less than we can detect experimentally. Doubtless, if a column of absolutely pure water of sufficient length could be obtained, it would be found that the region of absorption of the Schumann waves would widen out simultaneously with the bands in the infra-red, until the entire visible spectrum would be dimmed by general absorption. The next question is how should we expect the hydrates to affect the width of a given absorption band, or a limit of a region of absorption. The maximum of absorption of a band would correspond to that vibration of the resonator that was the least damped, and which, therefore, had the greatest amplitude; whereas the penumbra at the boundary of the band would correspond to those vibrations of the resonator which were damped to a great degree and which, therefore, had very small amplitude. It has been tacitly assumed that the incident radiation was continuous, and practically comprised all of the periods of the resonating system. If, now, the hydrate associated with a given resonator increased in mass by the addition of water, it would, of course, damp the vibrations more and more, and thus, by decreasing the amplitudes of the penumbral vibrations, cause the band to become narrower and narrower. That absorption still existed in the region from which it had apparently disappeared, could be shown at once by simply increasing the length of absorbing column until the penumbra had widened out to its original value, everything else being kept constant. Conversely, when the extent of hydration decreases, the regions of absorption would widen out and extend over a greater range of periods and wave-lengths. Assuming that the argument advanced above is valid, then it does not seem possible to escape the conclusion that hydrates exist, since the theory accounts so perfectly for the facts. We shall deduce the evidence for this agreement in some detail from the spectrograms and other sources of information.

Plate 2 shows that the region of absorption in the ultra-violet widens out as the concentration of the cobalt chloride increases. The same fact is shown by the absorption band in the green by plates 2 and 3 (*a*). As the concentration increases, the relative amount of water at the disposal of one cobalt system decreases, and hence, in accordance with the preceding theory, the band must become wider.

The same phenomenon in the ultra-violet is shown by plate 5 for the solutions of copper chloride in water. Plate 3 (*b*) also brings out the facts for the band in the red.

It is obvious that in interpreting the spectrograms, the difference between the observed widening of the absorption bands, and the widening that would have theoretically been produced if a change in concentration had

meant nothing more than an increase in the number of absorbing particles per unit volume, and not a change in their effective mass, had to be taken into account. The well-known theoretical formula involving the laws of Beer and Lambert is  $I = I_0 a^d c$ , where  $d$  symbolizes the thickness of absorbing layer, and  $c$  denotes the concentration. The remaining symbols have obvious definitions.

Further details concerning the laws may be found in the third volume of Kayser's "Handbuch der Spectroscopie," pp. 20, 25, and Chapter II, E.

Plates 3 (*c*) and 6 show conclusively the widening of the bands with increasing concentration, in the case of aqueous solutions of copper bromide. The data obtained from eye observations on the bands in the red confirm completely the spectrographic results.

Plates 8, 9 (*a*), 9 (*b*), and 12 show that the bands in the ultra-violet and green widen out as the amount of calcium chloride in the aqueous solutions of cobalt chloride increased. It will be remembered that in these solutions the mass of cobalt chloride was kept constant, while the quantity of the dehydrating agent was varied. These facts agree perfectly with the theory, since the calcium chloride has a much greater affinity for water particles than the cobalt system. Therefore, as the concentration of the calcium chloride increases, more and more water is taken away from the cobalt chloride, so that the vibrations of the latter are less damped than before, and thus the absorption bands cover a wider range of period.

The same phenomenon is shown by plates 11 (*b*) and 12, for the solutions containing variable amounts of aluminium chloride and a constant quantity of cobalt chloride.

The progress of the ultra-violet region of absorption, as the quantity of calcium chloride in the solutions containing a constant amount of copper chloride is increased, is very clearly shown by plate 13.

Plate 17 brings out the same facts for the solutions having a constant mass of copper chloride and a variable quantity of aluminium chloride.

The absorption bands of solutions of copper bromide, which differ only in the amounts of calcium bromide contained in the solutions, extend over wider ranges of wave-lengths as the percentage of the dehydrating agent increases. This is shown by plates 7 (*b*), 19 (*a*), and 19 (*b*).

The results of the eye observations agree in detail with the facts derived from the photographic negatives. [See especially figure 71 (*a*), (*b*), (*c*), and (*d*).] When to solutions containing constant amounts of cobalt chloride or of copper chloride, varying quantities of calcium bromide are added, the absorption phenomena are in general more complicated than in the cases just discussed, because of the effective formations, respectively, of cobalt bromide and of copper bromide. Similar conditions arise, of course, when either calcium chloride or aluminium chloride is added to solutions containing

a constant amount of copper bromide. A careful study of the negatives corresponding to the mixed solutions of the kind just described shows that the absorption bands of these solutions conform perfectly to the theory in question and do not present any exceptions. Earlier investigations have shown that aluminium chloride is a much stronger dehydrating agent than calcium chloride. This being the case, we should expect to find that a given widening of an absorption band of a colored salt, so called, which had been caused by the addition of a certain amount of calcium chloride, would be produced by a smaller amount of aluminium chloride.

Consider the case of cobalt chloride with the other two chlorides just mentioned. [See plates 9 (*a*), 11 (*b*), and especially plate 12.] The pairs of solutions were made up so as to have the same colors when viewed in their bottles. The successive widths of the absorption band in the green, for the solutions which contained calcium chloride, are slightly, but only slightly wider than those of the band of the corresponding solutions of the aluminium chloride series. On the contrary, the concentrations of the calcium chloride were much greater than the concentrations of the aluminium chloride, everything else being kept constant. The concentrations are compared in table 117.

TABLE 117.

CaCl <sub>2</sub>	AlCl <sub>3</sub>
1.676	1.118
2.091	1.394
2.515	1.676
2.617	1.781
2.830	1.887
3.143	2.100
3.555	2.370

The region of absorption in the ultra-violet is not relevant, because of the intense absorption of the short waves by aluminium chloride *alone*.

Another illustration is afforded by the solutions of copper chloride, together with the chlorides of calcium and aluminium. (See plates 13 and 17.) A careful comparison of the negatives shows that the absorption produced by the most concentrated

solution of aluminium chloride certainly extended farther into the visible spectrum than the corresponding band for the solution of calcium chloride, which was the third from the end of its series. The concentrations of the calcium and aluminium salts were, respectively, 3.518 and 2.482. The same fact may be brought out very sharply as follows: The two concentrations for the calcium chloride series, which come nearest to the concentration of the strongest aluminium chloride solution, and between which the latter concentration falls, are 2.435 and 2.706. The photographic strips pertaining to the calcium chloride solutions are the 10th and 11th of plate 13, counting from the numbered scale towards the comparison spectrum. A single glance shows that both of these bands of transmission extend to much shorter wavelengths than the last strip of plate 17.

That it is in general much more difficult to remove the last molecules of water from a given compound than the first is a well-known fact. Illustrations of this phenomenon are so numerous as to make it almost superfluous

to cite specific cases. For all the cases examined in which only one colored salt was present, and for all the absorption bands that had definite limits and were not accompanied by long regions of weak general absorption, it was found that as the concentrations of the solutions increased in arithmetical progression, the increments of absorption at one side of the band gradually became less and less. This statement applies both to the solution which contained only one salt and to those that contained a dehydrating agent, together with a colored salt. Since a one-sided region of absorption in the ultra-violet may be looked upon for sake of convenience as the least refrangible side of the band whose center lies beyond  $0.200\mu$ , and hence out in the region of the Schumann waves, and since a one-sided region of absorption in the red is actually the more refrangible side of a band whose center is situated in the infra-red, the preceding idea may be generalized by saying that the boundaries of all the absorption bands studied were concave towards their respective centers or maxima, as the case may be. The fact that the increments of absorption decrease as the concentration increases means that the colored system resists the transfer of its associated water molecules to the dehydrating agent more and more, as the actual number of its associated water molecules becomes less and less. From the standpoint of the colored salt the process of making up solutions of the same volume, and at the same time increasing the concentration of the salt, is equivalent to taking away some of its molecules of water. The bearing of this on the decreasing increments of absorption is obvious.

The cases where the spectrograms show that the boundary of the ultra-violet region of absorption was convex towards the shortest wave-lengths are not really at variance with the preceding explanation, since this convexity is due to either of two causes, or to both causes acting simultaneously. One of these conditions is as follows: For a given length of exposure, time of development, color of light, etc., there is an inferior limit of intensity of light, such that if the intensity falls below this value the sensitized film or plate will show no darkening even if over-developed. Now, some of the solutions had very long, weak regions of general absorption at the edge of the ultra-violet region of complete absorption. Also, the intensity of this penumbral companion to the main band increased as the concentrations of the solutions of the series increased, at such a rate as to cause the photographic film to record, apparently, increments of absorption that were too large. In other words, for the more dilute solutions the plate would record the light which was only slightly weakened by the general absorption, as if there were no such absorption at all, and then for the more concentrated solutions it would not give any record of the faint light which passed through the penumbral region. The transition from one condition to the other might be either gradual or apparently sudden, according to obvious circumstances. Spurious



results of this nature were sometimes corrected by the negative taken on the trichromatic plates, and they were always brought to light by the observations with the spectroscope.

The other cause for the apparently anomalous behavior of the contour of the ultra-violet region of absorption is the gradual superposition of the bands belonging to the two colored salts. For example, when calcium chloride was added to the solution containing copper bromide, the absorption is complicated by the production in the solutions of calcium chloride and copper chloride. Of course the compound absorption spectra of solutions of the kind just mentioned can be distorted by the peculiarities of photographic processes, as well as the simpler cases.

The well-known color changes which take place when fairly large variations are made in the temperature of the solutions are in complete agreement with the present theory. For example, when a red solution of cobalt is sufficiently warmed it becomes blue. As already explained the blue and red colors correspond, respectively, to wide and narrow bands, or, in terms of the theory, to small hydration and to relatively large hydration. But we know from other lines of evidence that the complexity of the hydrates decreases with rise in temperature, and thus we have another illustration of the wide applicability of the theory.

When a solution of cobalt chloride has been made deep blue at room temperature, by the addition of some one of the strong dehydrating agents, it turns red when cooled to the neighborhood of its freezing-point. The explanation of this phenomenon in terms of the theory is obvious. The corresponding color changes for the copper salts can be explained in exactly the same manner as has been done for cobalt chloride.

Before concluding the discussion of the interpretation of the spectroscopic data, it is desirable to emphasize the fact that all the color changes investigated take place very gradually and continuously, and that there are not sudden variations in the bands and regions of absorption. Perhaps the most striking color change of all is that from blue to green manifested by copper chloride. The one solution is blue because there is no absorption band in the violet, and yet there is a strong band in the red. The other solution is green because a band has pushed its end out of the ultra-violet into the visible spectrum, and absorbed the violet and perhaps weakened the blue.

The band in the red has likewise encroached on the visible spectrum. The apparently abrupt change from blue to green is only due to the fact that the visible spectrum is limited by the sensitivity of the retina to a certain region of wave-lengths. *If we could see distinctly into the ultra-violet as far as  $0.200\mu$ , we would probably be less hasty in writing about mixtures of the colors of certain ions and molecules. What is meant by the color of an ion? How do absorption bands mix colors?*

In conclusion, it is appropriate to call attention to certain facts that were brought out by the present investigation, and which have no direct bearing on the theory of hydrates.

Tables 101 and 103 for the freezing-point lowerings of cobalt chloride, together with either calcium chloride or calcium bromide, show that these solutions change with time. The nature of the change is such as to increase the molecular lowering of the freezing-point; in other words, the solutions undergo hydrolysis.

Table 108 shows that the volume of water necessary to change a color of the series in question approximately to that of the next more dilute solution of the set decreases as the concentration of the first solution increases. The solutions contain cobalt chloride and aluminium chloride.

The reason for the decrease just noted is as follows: When the solutions are very concentrated they contain a relatively small amount of water and, therefore, it requires the addition of only a very small amount of water to change the color of the solution to that of the next lower member of the series. When, on the other hand, the solution contains a larger amount of water to begin with, it takes a greater amount of water than formerly to bring about a definite color change. In other words, the question is one that concerns the ratio of the amount of water added to the quantity already present, and it does not relate primarily to the absolute volume of water concerned. A careful study of the five curves for electrical conductivity shows that the viscosity is chiefly responsible for the decrease in conductivity with increase in concentration of the dehydrating agent, after a maximum of a curve has been reached. Stated in a slightly different way, the decrease in the velocity of the ions is so much greater than the simultaneous increase in the number of ions that the conductivity decreases with increase in concentration. The fact that the maxima of the curves for the solutions that contained the same dehydrating agent occur at approximately the same concentration of this agent, quite independently of the nature of the colored salt in the solution, is due to the relatively small number of ions of the colored salt as compared with the number of ions of the dehydrating agent. Moreover, as would be expected, the greater the viscosity of the dehydrating agent the lower the concentration corresponding to the maximum of the curve. Compare in this connection the calcium chloride solutions with those of aluminium chloride.

## NON-AQUEOUS SOLUTIONS.

### APPARATUS.

The spectrograph, spectroscope, photographic materials, etc., used in the study of non-aqueous solutions, were the same as those employed in the earlier part of this investigation of the absorption spectra of aqueous solutions. Since, however, the various parts of all the cells used for aqueous solutions were fastened together with cement, which was soluble in the alcohol and acetone, it became necessary to design a cell which would not be so acted upon by the solutions to be investigated. Moreover, since no strongly adhesive cement could be found, which would satisfy the requirements of being insoluble in water, alcohol, acetone, etc., it was decided to construct a cell of entirely new design which would be absolutely free from cement of any kind.

A vertical section of the cell is shown by plate 22, and the details of the several parts may be explained as follows: In its fundamental principles the cell consisted of three distinct parts: (*a*) An outer glass tube with a quartz bottom to hold the liquid; (*b*) an inner glass tube with a quartz plate at the lower end to regulate the depth of the liquid and to cause the upper surface of the absorbing layer of solution to be both plane and parallel to the quartz bottom of the larger glass tube; and (*c*) a mechanism which would act as a stopper to the system of glass and quartz just mentioned, and which would also enable the experimenter to adjust the cell for any desired depth of absorbing layer from zero to the full capacity of the cell, *i. e.*, about 3.5 cm.

The separate parts of this piece of apparatus will be described in the order in which they would be assembled for actual use. M denotes a plane parallel plate of quartz, ground carefully in the form of a frustum of a cone, so as to fit very accurately into the conical hole at the lower end of the glass tube D. The thickness of this quartz plate was 4.6 mm. and its least diameter was 12.6 mm. The glass tube was blown with a thick shoulder at its upper end. The plate M was first slipped into place in the tube D, and then the rubber washer G was pushed down against the quartz by introducing the brass tube C into the glass tube. In order to prevent dust from entering the inner tubes, the plane parallel quartz plate A was permanently set into a cylindrical depression in the upper end of the brass tube C. This plate was 2 mm. thick and 20 mm. in diameter.

The brass tube widened out into a sort of plate at its upper end, and this projection was pierced by three holes at the vertices of an equilateral triangle. Through these holes suitable screws passed, and one of these is shown at B

of plate 22. After the brass tube C had been introduced into the glass tube, the washer R, made of blotting paper, was slipped up over the outside of the glass tube until it would not pass through the shoulder of this tube. Then the group of parts thus far described was let down through the hole at the upper end of the hollow brass cylinder E, as far as it could go, *i. e.*, until the washer R was tightly squeezed between the glass and brass surfaces. The three screws were next pushed through their respective holes, and turned until the quartz plate M was forced, liquid-tight, into the conical hole in the glass tube, care being taken at the same time so to adjust the system as to have the axis of rotation of the glass tube and quartz plate parallel to the axis of the brass cylinder E. A thread of convenient pitch had been accurately cut in the inner surface of this cylinder. The purpose of this thread, as well as that of a fine line or groove which had been turned on the outside of the cylinder in a plane at right angles to the axis of the same, will be explained below.

Whenever the cell had been entirely taken apart (and this was not often necessary) the distance between the plane of the lower surface of the quartz plate M and the plane of the lower end of the cylinder E had to be measured and recorded, since this distance varied with the thickness of the two washers and with the pressure exerted by the screws. The number expressing this distance was one of several numbers which had to be known in order to adjust the cell for a given depth.

The thread at E was next fitted to the thread which had been accurately cut to fit it on the outside of the brass cylinder I. Then the two cylinders were screwed together until the distance between the fine cut around the outside of E and a certain point of the upper plane surface of the flange at the bottom of the cylinder I had the proper value. This distance was, of course, measured along a generating line of the outer surface at E, and hence perpendicular to the plane just located. The assemblage of parts explained above formed a complete system in itself, and comprised all of parts (b) and (c), using the notation of the remarks introductory to the more detailed discussion of the cell. The flange at the bottom of I was provided with three large holes and two small ones, and all of them pierced it parallel to the axis of the cylinder. The larger holes fitted closely over three pillars (H and H), while the smaller ones corresponded to two little screws. The pillars and screws were not in the plane of the diagram. The object of the pillars and screws will be explained a little later. The cylinder I was also turned so as to have a collar on its interior near the top.

When the desired depth of absorbing liquid, the basis of intensity of color, etc., had been determined upon, the distance between the line around E and the upper plane of the flange of I was found by the addition of three numbers. One of these was a constant of the apparatus 1.34 cm. and the

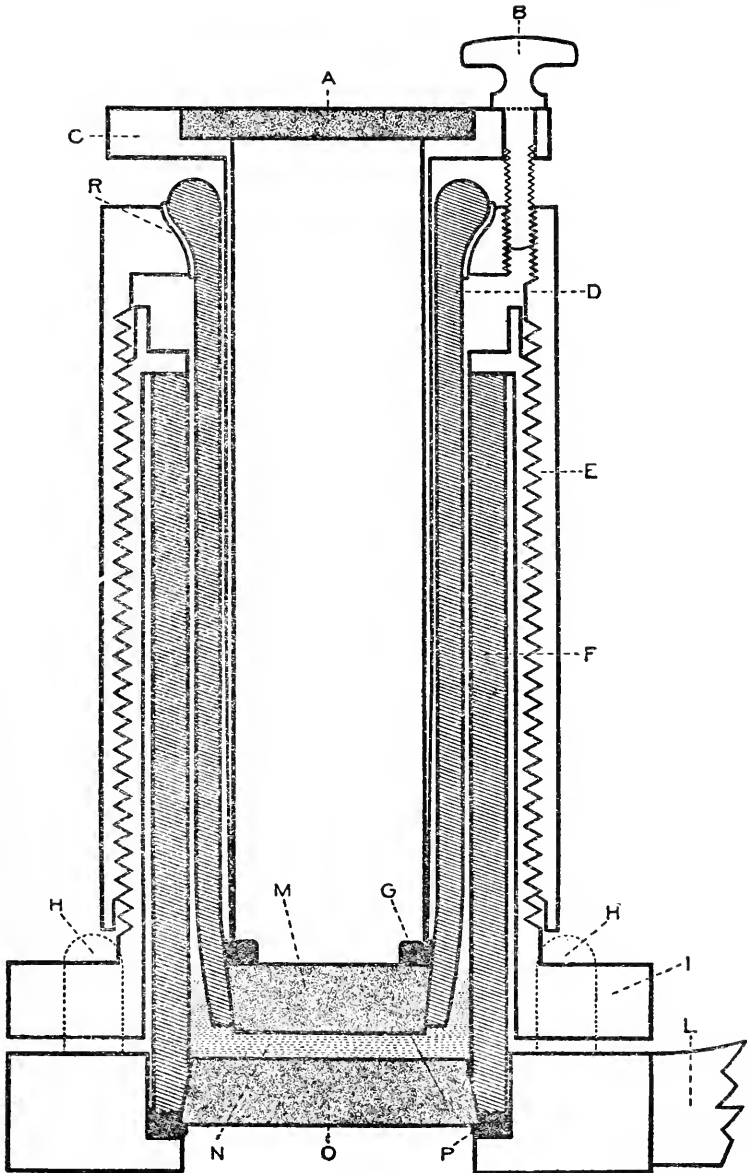



other two expressed, respectively, the required depth of solution and the distance from the lower plane surface of the quartz plate M to the plane of the lower end of the brass cylinder E. As an example from practice, for a depth of 2 cm. the sum was  $1.34+2.00+0.69=4.03$  cm.; *i. e.*, the two cylinders E and I had to be screwed around each other until the fiducial line to the flange was equal to 4.03 cm.

Conversely, knowing this distance, as well as the two-cell data, it was merely a matter of algebraic addition to obtain the effective depth of the cell.

The remaining parts of the apparatus had the characteristics described below and were assembled as follows: L denotes the handle of a stout, hollow cylindrical plate, which formed the bottom of the complete cell. The interior of this plate was turned out so as to leave a flange at the bottom upon which the rubber washer P was placed. The three pillars mentioned above projected vertically from and were rigidly attached to the plate L. Two holes had been tapped out of this plate to correspond accurately to the smooth holes of the flange of I. After laying the washer P on the flange of L, and after pushing and turning the quartz plate M tight up into the conical holes of the glass tube F, the transparent system was set vertically with its lower end resting symmetrically on the washer. The thickness and the smallest diameter of this quartz plate were, respectively, 4.6 mm. and 19 mm. The solution to be studied, N, was next poured into the vessel constituted by F and O. It was necessary to measure the depth of the liquid, and it was found convenient to make this depth 2 mm. greater than the effective depth of the cell.

The assembled system of parts A, B, C, D, G, I, M, R, was next let down over the glass tube F, until the upper flange inside the cylinder I rested on top of this tube. The three pillars H guided the system into the correct position, and prevented any rotation of the cylinders I and L around each other. Lastly, the two little screws were passed through the holes in the lower rim of I, and the two cylinders were screwed tightly together. This operation completed the adjustment of the cell. It is seen at once from the preceding explanation, that the liquid or solution in question came only in contact with glass and quartz surfaces, while the vapor touched both glass and brass walls. Since the vapors of the solutions studied did not act on brass, glass, and quartz, and since the apparatus did not leak, the cell gave entire satisfaction. For vapors that would attack brass but not the silicates, it is easy to see how a system could be designed that would differ from the system just described, in having coaxial glass tubes dip into a trap of some neutral liquid instead of the brass cylinders E and I. Moreover, it would be quite possible to design the parts of the cell in such a way as to impart to the liquid the shape of a wedge or prism of adjustable angle and depth.

## SOLUTIONS.

The solutions were made up as follows: A chosen volume of pure water was run out of a burette into a measuring flask. Then some of the mother-solution of one of the colored salts was run into the flasks, and thoroughly mixed with the water until the volume of the resulting homogeneous solution was exactly equal to the calibrated capacity of the flask. In the following account of the work, the amount of water in a given solution will be expressed in per cent of the total volume of the solution. For example, if 5 cc. of water were made up to 200 cc. of solution, the amount of water would be given as 2.5 per cent, or simply 2.5. The colored salts used were cobalt chloride, copper chloride, and copper bromide. The solvents employed were methyl alcohol, ethyl alcohol, and acetone. Special precautions were taken to have both the colored salts and the solvents as free from water as possible.

## COBALT CHLORIDE IN METHYL ALCOHOL. [See plate 23.]

The concentration of the mother-solution was 0.099. The percentages of water in the solutions were 12.00, 9.50, 7.00, 6.00, 5.00, 4.00, 3.50, 3.00, 2.00, 1.50, 1.26, 1.01, 0.50, 0.00. The successive differences in per cent were 2.50, 2.50, 1.00, 1.00, 1.00, 0.50, 0.50, 1.00, 0.50, 0.24, 0.25, 0.51, 0.50. As the quantity of water increased, the color of the solution gradually changed from the purple of the mother-solution to a pale pink, passing through the intermediate tints. Photographic strips corresponding to the solutions that contained the greatest and least amount of water are adjacent, respectively, to the numbered scale and to the comparison or spark spectrum. The depth of cell was 2 cm. The first seven strips were taken on one half the photographic film, and the remaining seven on the other half.

The spectrogram shows a region of absorption in the ultra-violet and violet, and a band in the green. The air-line at 3007 was very faintly recorded by the strip corresponding to the solution that contained the greatest amount of water, but the continuous background did not extend beyond about  $0.314\mu$ . The middle of the band in the green was  $0.517\mu$ . As shown by the corresponding strip, transmission began near  $0.373\mu$  for the mother-solution of cobalt chloride in the methyl alcohol. The middle of the band in the green was at  $0.525\mu$ . Therefore, one effect of the addition of water is to shift this band towards the blue. It is interesting to note in this connection that the center of the absorption band in the green was displaced towards the red by about 100 A. U. when the solvent was changed from water alone to methyl alcohol. This absorption band widened very gradually as the amount of water in the successive solutions decreased. In fact, for the mother-solution the negative strip indicated that transmission began near  $0.505\mu$  and  $0.540\mu$  at the sides of this absorption band. The band was very weak for the solution containing the greatest amount of water. It must, however, be remem-



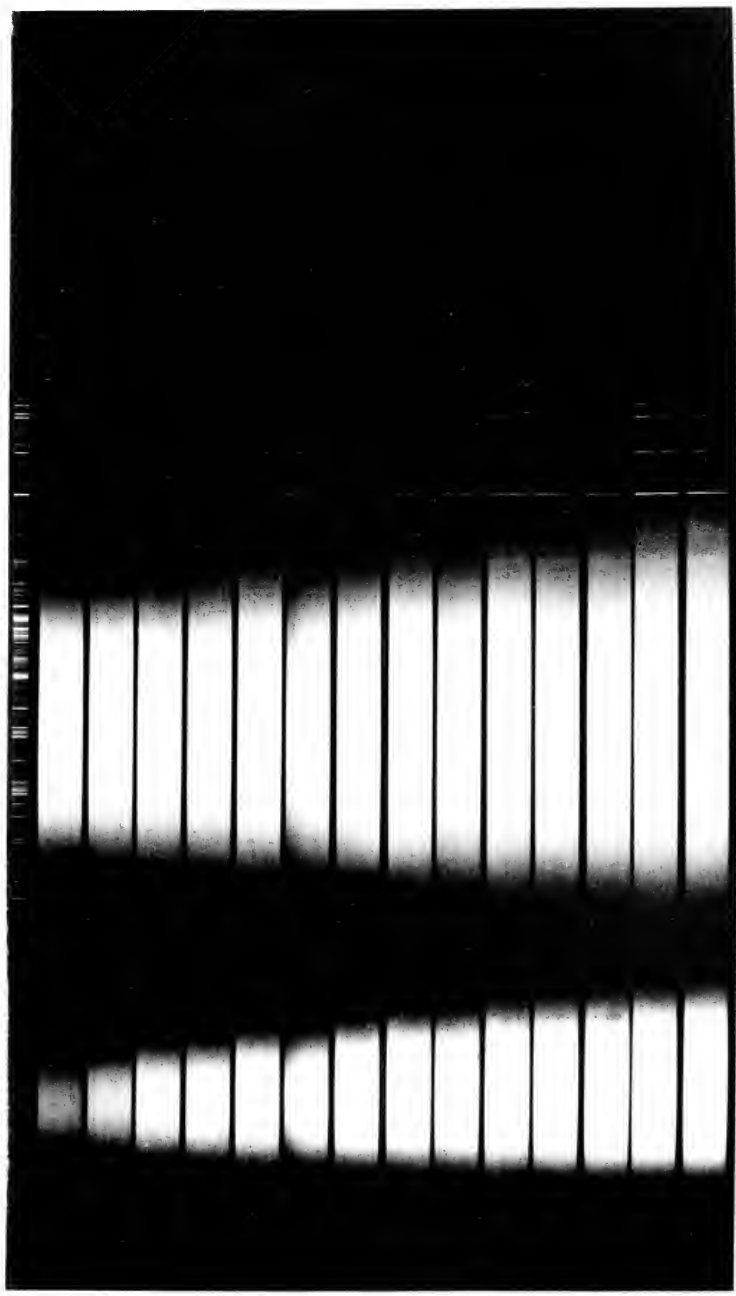

20  
21  
22  
23  
24  
25  
26  
27  
28  
29  
30  
31  
32  
33  
34  
35  
36  
37  
38  
39  
40  
41  
42  
43  
44  
45  
46  
47  
48  
49  
50  
51  
52  
53  
54  
55  
56  
57  
58  
59  
60  
61  
62  
63

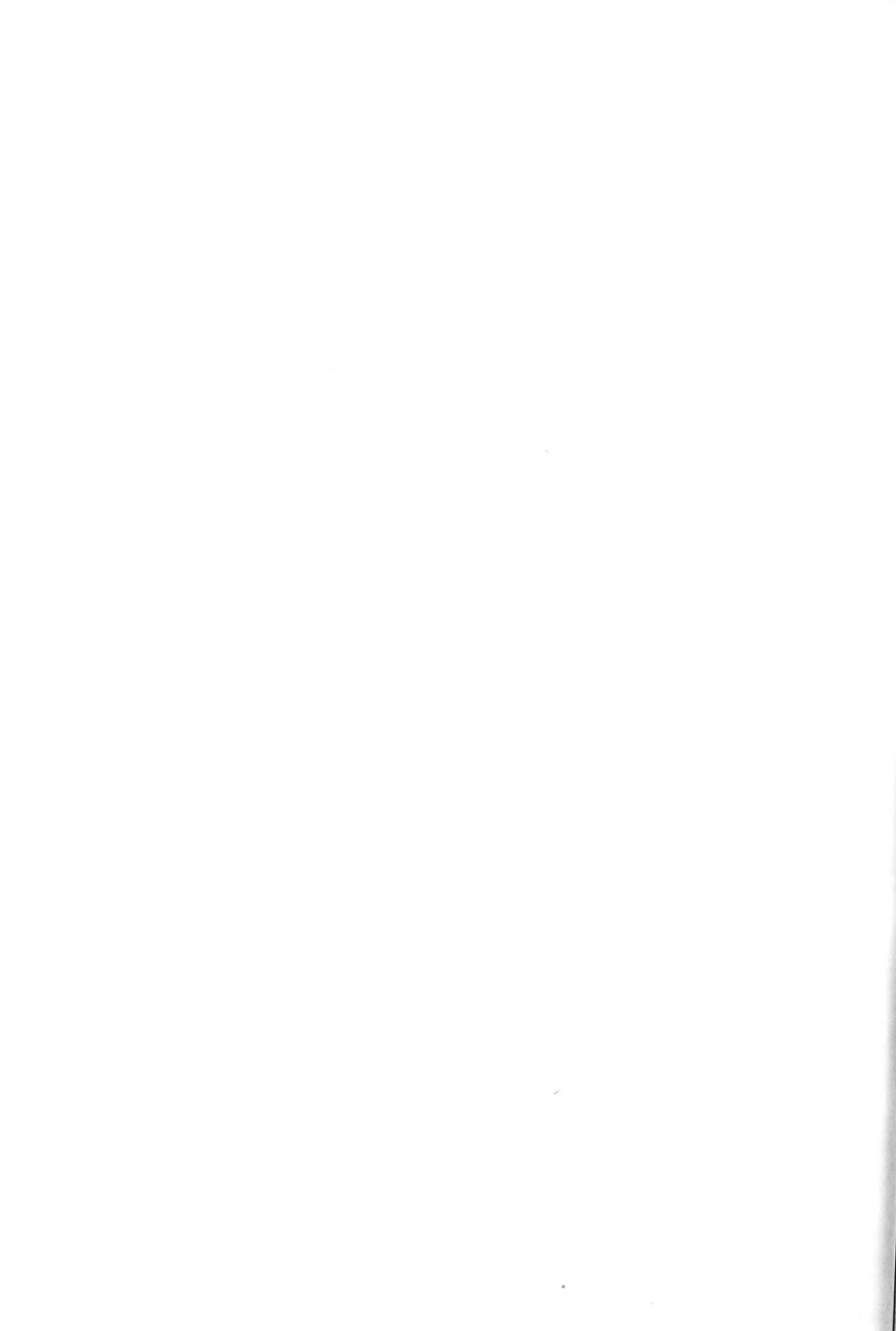

bered that the other solution was not quite tenth-normal, cobalt chloride being only slightly soluble in methyl alcohol.

Eye observations of typical solutions of the set gave the following results: The depth of cell used was 3 cm. The mother-solution had a clear purple color, with a decided reddish tinge when viewed by diffuse daylight transmitted through the cell. Transmission began about  $0.766\mu$  and extended to the beginning of the absorption band in the green. Weak partial absorption appeared in the red at  $0.704\mu$ . The brightest region of transmission was in the immediate neighborhood of  $0.625\mu$ , *i. e.*, in the yellow. No narrow absorption bands in the red, orange, or yellow, such as were observed for aqueous solutions of cobalt chloride, were visible. The band in the green was narrow, but intense, its maximum being near  $0.540\mu$ . It was much more abrupt on the less than on the more refrangible side. For one definite exposure a photographic film does not necessarily show the position of the maximum of intensity of an asymmetric absorption band, so that it is not surprising to find  $0.525\mu$  for the center of the photographic band, and  $0.540\mu$  for the maximum of absorption with the prism spectroscope. To see if there were any other absorption bands the cell was filled to the brim of the larger glass tube, and the rest of the system was not put in place. In this manner a column of solution 4.5 cm. long was obtained. The several faint maxima and minima of transmission could be seen in the red. If the solution could have been made more concentrated, or, better, if the cell had been deeper, it is extremely probable that all the bands observed in aqueous solutions could have been seen with the alcoholic solution in question. As the spectra of the solutions which contained greater and greater amounts of water were brought into the field of view, it was observed that the various regions of absorption grew weaker and weaker, and that the entire spectra remained qualitatively similar to the spectrum of the mother-solution. Of course the regions of weak absorption around  $0.704\mu$  soon disappeared. The maximum of intensity of the absorption band in the green had the wavelength  $0.525\mu$  for the solution which contained the greatest percentage of water, 12.00. Consequently, the maximum of this band was displaced about 150 A. U. towards the blue, when the amount of water in the solution was changed from 0.00% to 12.00%.

COBALT CHLORIDE IN ETHYL ALCOHOL. [See plates 24 and 25 (a).]

The concentration of the mother-solution of cobalt chloride in ethyl alcohol was 0.0967. The percentages of water in the solution were 20.00, 10.00, 8.00, 7.50, 7.00, 6.00, 5.50, 5.00, 4.00, 3.00, 2.00, and 0.00. The successive differences in per cent were 10.00, 2.00, 0.50, 0.50, 1.00, 0.50, 0.50, 1.00, 1.00, 2.00. As the quantity of water decreased, the colors of the solutions changed from pink, through various shades of violet, to deep blue. The photographic strips corresponding to the solutions which contained the

greatest and least amounts of water are contiguous, respectively, to the numbered scale and to the comparison spectrum of plate 24. This spectrogram will be discussed before plate 25 (*a*). The depth of the cell was 2 cm.\* As would be expected, the same general regions and bands of absorption were possessed by the solutions of cobalt chloride in ethyl alcohol and water, as by those in which methyl alcohol took the place of ethyl alcohol. The negative strip pertaining to the solution which contained the greatest amount of water barely recorded the intense zinc line of wave-length 2502.1 A. U. The continuous background ceased about  $0.280\mu$ . The middle of the band in the green as shown by the negative was near  $0.516\mu$ . For the solution whose percentage of water was 2.00, the negative strip gave  $0.519\mu$  as the middle of the band in the green. Hence, the photographic band was displaced towards the blue by about 30 A. U. as the percentage of water was increased from 2.00 to 20.00. The strip corresponding to the mother-solution showed transmission between the extreme limits  $0.384\mu$  and  $0.508\mu$ . The last three strips, and especially the very last one, showed the existence of appreciable general absorption in the yellow and orange. The negative for plate 25 (*a*) was taken with a Cramer trichromatic plate. The solutions used were the last five of the set of twelve; in other words, the five that contained the smallest amounts of water. The strip pertaining to the mother-solution is closest to the scale. The depth of the cell was 2 cm. The exposure for the Nernst filament lasted two minutes. The negative recorded the middle of the absorption band in the green as at  $0.510\mu$  for the solution that contained 5 per cent of water. The five strips show distinctly the gradual shift of the middle of this band towards the red, as the quantity of water in the solutions decreased from 5 to 0 per cent. They also showed the progress of absorption both in the violet and in the orange and yellow. In fact, the strip pertaining to the mother-solution shows no transmission of the yellow. The middle of the region of transmission between the band in the violet and the band in the green moved towards the red, whereas the center of the bright region between the band in the green and the band in the orange shifted towards the blue as the percentage of water decreased.

The results obtained by eye observations with the Hilger spectroscope were as follows: The depth of cell used was 2 cm. With only air in the path of the beam of light, the spectrum began near  $0.776\mu$ . The mother-solution transmitted faintly a band of red from  $0.775\mu$  to  $0.735\mu$ . The more refrangible limit was quite well defined. An intense region of absorption extended from  $0.735\mu$  to  $0.575\mu$ . Transmission began again in the blue-green. This color, however, was weak. Absolutely no light of shorter wave-length than  $0.417\mu$  could be seen, which shows that the ultra-violet region of absorption extended into the visible spectrum by at least 170 A. U.

\* As this number is given from memory, it may not be exact.

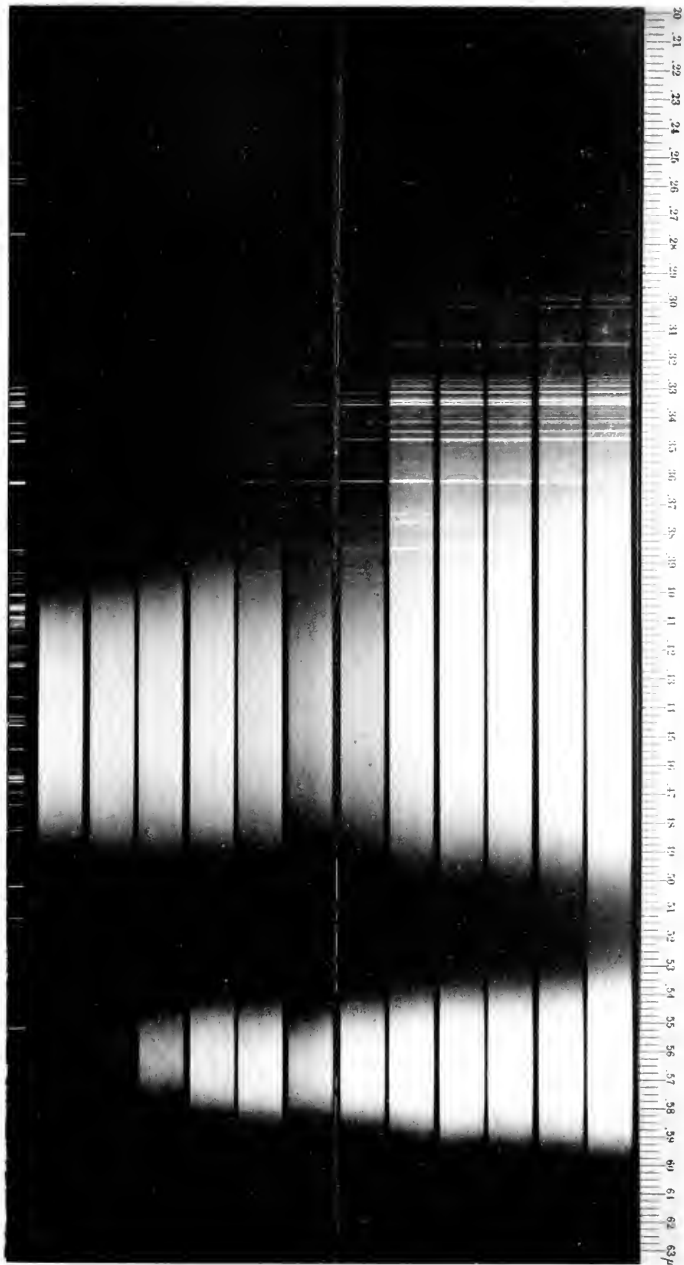



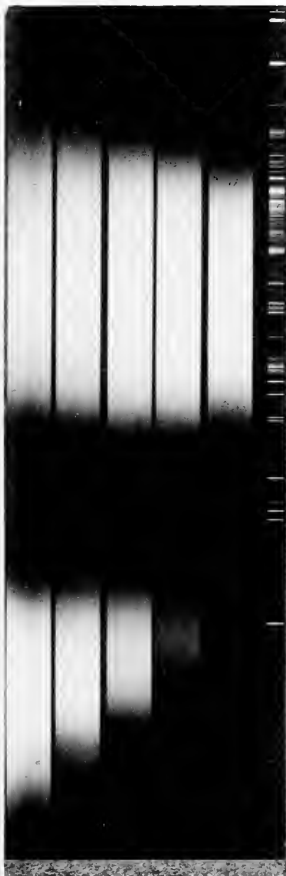

a

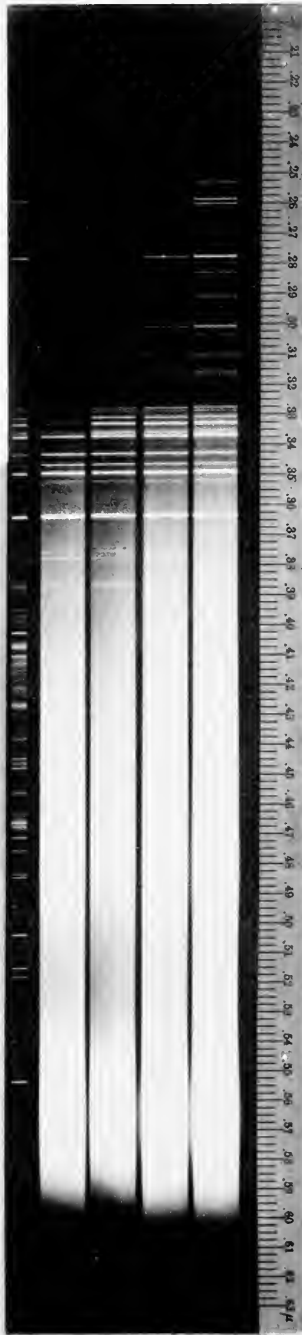

b





The solution which contained 2 per cent of water transmitted a band of red, like the mother-solution. Then the absorption was complete as far as  $0.629\mu$ . Faint transmission began at  $0.269\mu$  and passed over into rather strong transmission in the vicinity of  $0.597\mu$ . In other words, a single broad band possessed by the mother-solution had broken up into two bands, of which the more refrangible was much less intense and well defined than its companion in the red. A relatively weak spot in the transmission appeared near  $0.52\mu$ .

The solution which contained 3 per cent of water had a complicated spectrum, very much like the spectra belonging to aqueous solutions of cobalt chloride to which a comparatively large quantity of calcium chloride, of calcium bromide, or of aluminium chloride had been added. The maximum of transmission in the red was near  $0.734\mu$ , and the adjoining region of intense absorption had its maximum at about  $0.690\mu$ . Then a series of bands of incomplete opacity and transparency succeeded one another. The positions of the maxima of absorption were recorded as  $0.636\mu$ ,  $0.615\mu$ ,  $0.600\mu$ , with the brightest transmission at  $0.627\mu$ ;  $0.608\mu$  marked the center of a very faint maximum of transmission. The next region of relatively strong transmission extended from  $0.596\mu$  to about  $0.535\mu$ . The band in the general neighborhood of  $0.52\mu$  was weak and very diffuse at its limits.

For the solution containing 4 per cent of water there were maxima of transmission at  $0.730\mu$  and  $0.627\mu$ . The maxima of the absorption band had the wave-lengths  $0.695\mu$ ,  $0.636\mu$ ,  $0.615\mu$ , and  $0.600\mu$ . The stronger band at  $0.695\mu$  transmitted a little light even at its maximum. The bands at  $0.615\mu$  and  $0.600\mu$  were very faint. The band in the green was too diffuse and indefinite to have the position even of its center or of its maximum determined. For the 5.5 per cent solution the bands at  $0.636\mu$ ,  $0.615\mu$ ,  $0.600\mu$ , had become so extremely faint that they could only be seen by moving the spectrum across the field of view of the telescope. All the remaining bands were much weaker.

From the 7 per cent solution the band in the red had become very weak, while for the 8 per cent solution it had become a mere shadow and lost its identity as a band.

A solution that contained 40 per cent of water exerted very slight absorption in the extreme red, and very weak diffuse absorption in the blue-green.

COBALT CHLORIDE IN ACETONE. [See plate 26.]

The concentration of the mother-solution of cobalt chloride in acetone was 0.0154. The percentages of water in the solutions were 28, 26, 24, 22, 20, 18, 16, 14, 12, 10, 8, 6, 4, 2, and 0. Each successive difference in this sequence equals 2. When placed in the cell, at a depth of 2 cm., the solutions whose percentages of water varied from 28 to 16, inclusive of the latter number, were delicate pink. Beginning with the solution having 14 per cent of water the color changed to blue, which was at first very

faint and then gradually increased as the amount of water decreased. The mother-solution had a very deep blue color. The photographic strips adjacent to the numbered scale and to the comparison spectrum correspond, respectively, to the solutions that contained the greatest amount of water and no water at all. The spectrogram shows the existence of a region of very intense absorption in the ultra-violet, and another region in the orange. No band appeared photographically in the green. The negative strip for the 28 per cent solution showed that the ultra-violet region of absorption ended abruptly at 3250. That this limit of absorption did not vary rapidly as the amount of water decreased is shown by the fact that the strip for the 2 per cent solution gave the wave-length of complete absorption as 3329 A. U. In other words, this limit only moved by about 80 A. U., while the percentage of water changed from 28 to 2. In addition to the abrupt limit of absorption, the existence of ever-increasing, weak absorption of the extreme violet and least refrangible ultra-violet is shown by the last five or six strips, which correspond to the solutions that contained smaller amounts of water. For the mother-solution, this general absorption was relatively strong. Although the strip for the mother-solution recorded very faintly the air-line at 3331.5, nevertheless the continuous background only began to grow strong near, say,  $0.375\mu$ . The last 8 or 9 negative strips showed distinctly the existence of absorption in the orange and yellow. Also the more refrangible limit of this band did not shift in direct proportion to the percentage of water in the successive solutions. The strip for the mother-solutions shows that transmission of sufficient intensity to affect the photographic film stopped at about  $0.554\mu$ .

The spectroscopic study of the bands in the red and orange brought out the following facts: The cell depth was 2 cm. For the mother-solution transmission began near  $0.570\mu$  and increased to about  $0.554\mu$ . The green and blue regions are not very bright, and the nearest approach to transparency seemed to be in the indigo. Visible transmission ceased at  $0.424\mu$ . The spectrum of the 4 per cent solution was qualitatively like that of the mother-solution. The wave-lengths which corresponded to  $0.570\mu$ ,  $0.554\mu$ , and  $0.424\mu$  for the mother-solution were, respectively,  $0.599\mu$ ,  $0.574\mu$ , and  $0.416\mu$ , in the case of the 4 per cent solution. The solution which contained 6 per cent of water was the first to show definite absorption bands. It transmitted very faintly the red from  $0.77\mu$  to  $0.731\mu$ . One absorption band extended from  $0.731\mu$  to  $0.630\mu$ , and another from  $0.616\mu$  to about  $0.596\mu$ . Slight transmission separated these two bands of complete absorption.

The complete spectrum for the 8 per cent solution was more complicated than that of the 6 per cent solution. The red was faintly transmitted from  $0.77\mu$  to  $0.721\mu$ , with the maximum of brightness near  $0.741\mu$ . Complete absorption from  $0.721\mu$  to  $0.651\mu$  was succeeded by very weak transmis-







11

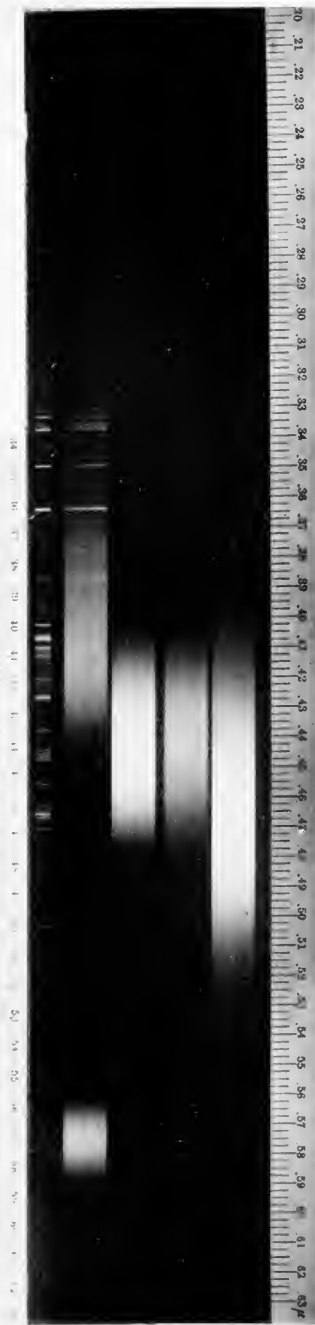

12



sion between  $0.651\mu$  and  $0.634\mu$ . A strip of relatively weak transmission, which, however, was much more intense than its less refrangible neighbor, began at  $0.634\mu$  and had its middle at  $6255$ . This was followed by two comparatively narrow, symmetrical bands of almost complete absorption, whose maxima had the wave-lengths  $0.613\mu$  and  $0.6005\mu$ . The middle of the intervening and very faint band of transmission was at  $0.607\mu$ . The spectrum for the 10 per cent solution was very much like that of the 8 per cent, the absorption bands, of course, being somewhat weaker. For the 12 per cent solutions the bands were very faint indeed. The strongest band had the approximate wave-length  $0.700\mu$ . The narrow bands at  $0.613\mu$  and  $0.6005\mu$  could only be seen by moving the spectrum across the field of view. The 14 per cent solution showed only one absorption band. This band was in the extreme red and was very weak. The 16 per cent solution had no visible bands as such. The transmission from the bluish color of 14 per cent, to the pinkish tinge of the 16 per cent solution, was due to the gradual disappearance of the absorption bands in the red, and not to an abrupt or continuous change of any kind whatsoever. The solution having more than 16 per cent of water showed no absorption bands in the spectroscope.

Before taking up the discussion of the copper salts it is desirable to compare the spectra of the mother-solutions of cobalt chloride with one another, and to consider how much of the ultra-violet absorption was due to the solvents themselves. [See plates 27 (*a*) and 27 (*b*).] Consider first the negative for 27 (*b*). The concentrations of the cobalt chloride in acetone, in ethyl alcohol, in methyl alcohol, and in water were, respectively, 0.010,\* 0.097, 0.099, and 0.325.† The first solution was blue, with a slight greenish tinge. The second solution was blue, with a slight reddish tinge. The second solution was deeper blue than the first, due largely to the difference in concentration. The third and fourth solutions were, respectively, purple and red. The photographic strips nearest to the numbered scale and to the comparison spectrum correspond, respectively, to the solutions in acetone and in water. The four steps are in the same order as that in which the solutions are named above. The depth of the cell was 2.40 cm. The strip pertaining to the acetone solution recorded very faintly the intense doublet at 3330, but the extreme limits of the continuous background were  $0.370\mu$  and  $0.550\mu$ . The strip corresponding to the ethyl alcohol solution gave the extreme limits of transmission as  $0.388\mu$  and  $0.496\mu$ . The negative strip pertaining to the methyl alcohol solution gave the limits of one region of transmission as  $0.385\mu$  and  $0.495\mu$ . Faint transmission was recorded from  $0.555\mu$  towards

\* Not the mother-solution for plate 26.

† Diluted from the original mother-solution used in the preceding study of aqueous solutions.

the red, an absorption band extending from  $0.495\mu$  to  $0.555\mu$ . The density of the negative was greater in the region of the blue and violet for the solution in methyl alcohol than for the one in ethyl alcohol. Also the maxima of transmission as given by the negative for the solutions in acetone and in methyl alcohol were, respectively, near  $0.470\mu$  and  $0.442\mu$ . The strip for the aqueous solution showed the trace of the line at  $2502.1$ , but the continuous background faded away near  $0.288\mu$ . The band of absorption in the green comprised the region from  $0.452\mu$  to  $0.551\mu$ .

The contrasts of the regions of absorption and of transmission of the four solutions under consideration are very distinctly shown by plate 27 (*a*). The negative for this spectrum was taken with a Cramer trichromatic plate. The solutions were the same as for plate 27 (*b*), and their spectra were photographed in the same order. The strip corresponding to the aqueous solution is adjacent to the scales. The depth of the cell was 2 cm. and the length of exposure for the glower was two minutes. The extreme limits of transmission for the solution of acetone were  $0.370\mu$  and  $0.562\mu$ . The corresponding limits for the solutions in methyl alcohol were about  $0.385\mu$  and  $0.497\mu$ . The strips pertaining to the last two solutions showed no return to transparency in the yellow and orange. The solution in methyl alcohol transmitted light from about  $0.390\mu$  to  $0.500\mu$ . This was followed by an absorption band from  $0.500\mu$  to  $0.547\mu$ . The aqueous solution had a band of complete absorption from about  $0.462\mu$  to  $0.543\mu$ . The region of transmission in the yellow and yellow-orange was much more intense for the aqueous solution than for the one in methyl alcohol. The shifts experienced by the centers of the regions of absorption and transmission, when the solvents were changed (due allowance being made for the several concentrations), were large, and are rather strikingly shown by plate 27 (*a*). The results of eye observations on the spectra of the four solutions in question have already been given, so that nothing more than a brief résumé of the facts is necessary. The solution in acetone transmitted a faint band of red, the middle of which was near  $0.761\mu$ . The solution in methyl alcohol transmitted more strongly a region of red from about  $0.775\mu$  to  $0.735\mu$ . The spectrogram of plate 27 (*a*) gives the photographic positions of the less refrangible limit of the absorption band in the green. The solution in methyl alcohol showed a weak absorption band near  $0.704\mu$ , while the aqueous solution was too dilute to give the bands in the red. Therefore, that region of absorption, which for brevity may be called the band in the green, moved its center to shorter and shorter wave-lengths as the solvents successively used were acetone, ethyl alcohol, methyl alcohol, and water.

Plate 25 (*b*) gives the ultra-violet absorption of the four solvents used. The strip adjacent to the numbered scale corresponds to distilled water, and the next strip belongs to methyl alcohol. The strip nearest to the



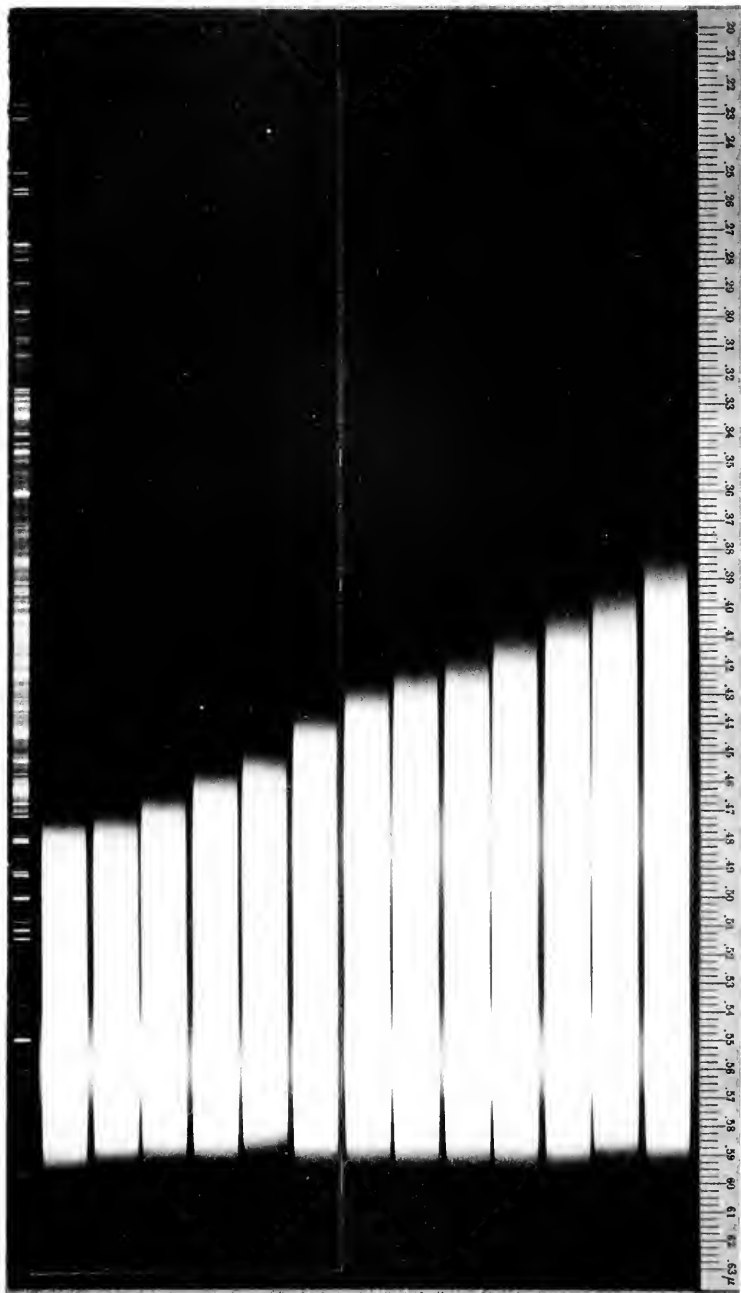



comparison spectrum corresponds to acetone. The remaining strip resulted from light transmitted by ethyl alcohol. The depth of the cell was 1.41 cm. As is well known, water is exceptionally transparent to short light waves, so that the negative strip for this liquid recorded as many lines in the remote ultra-violet as was shown by the comparison spectrum. The shortest wavelength given by the strip for methyl alcohol was 2313.0. The strong cadmium line, however, was just barely visible on the negative. The intense lines at 2558.0, 2573.1, and 2712.6 were rather fully transmitted. The continuous background for waves more refrangible than 2748.7 was extremely weak. The third strip showed that ethyl alcohol was more transparent than methyl alcohol to the remote ultra-violet, since it recorded distinctly the lines at 2265.1, 2288.1, 2313.0, and 2321.2. On the other hand, the lines at 2558.0, 2573.1, and 2721.6 were not quite as strong after passing through the ethyl alcohol as they were after emerging from the methyl alcohol. Taking the continuous background into account, as well as the spark lines, the negative shows that methyl alcohol has a one-sided region of absorption in the ultra-violet, whereas ethyl alcohol has a region of semi-transparency in the neighborhood of 0.230 $\mu$ , with strong absorption on both sides. For all ultra-violet and visible waves less refrangible than 2748.7 the transmission of these two alcohols seems to be identical. Acetone showed intense selective absorption in the ultra-violet, since the associated photographic strip recorded nothing beyond 3282.4. This line was very much weakened, and the correct limit of this region of absorption was 3302.7 A.U. The conclusion is that the ultra-violet absorption of the cobalt chloride was only masked by that of the solvent in the case of acetone. In all of the other cases studied, the ultra-violet absorption was due largely to the cobalt chloride in the solution, and not so much to the solvents as such.

## COPPER CHLORIDE IN METHYL ALCOHOL. [See plate 28.]

The concentration of the mother-solution of copper chloride was 0.283. The percentages of water in the solutions of the series were 40, 36, 32, 28, 26, 24, 22, 20, 16, 12, 8, 4, and 0. All the successive differences in this sequence of numbers were equal to 4 per cent, except the fourth, fifth, sixth, and seventh. Each of the four exceptional increments was equal to 2 per cent. To obtain a general idea of the dependence upon the amount of water present, of the limit of absorption of the band which included the ultra-violet, it is convenient to omit the fifth and seventh photographic strips from consideration. As the amount of water decreased, the color of the solutions varied from greenish-blue through pure green, to a green with a yellow tint.

The strip corresponding to the 40 per cent solution is adjacent to the numbered scale, and that belonging to the mother-solution lies next to the comparison spectrum. The depth of the cell was 2.40 cm. The negative showed only one region of absorption, and it included the entire ultra-violet; the

negative strips corresponding, respectively, to the solution that contained the greatest amount of water, and to the one that was anhydrous, gave the very beginnings of transmission as  $0.375\mu$  and  $0.480\mu$ . The complete spectrogram shows that the increments of absorption decreased gradually as the percentage of water decreased in arithmetical progression.

The spectroscope revealed the existence of a one-sided region of absorption in the red. The depth of cell used was 2.40 cm. The limit of visible transmission moved towards the infra-red as the quantity of water in the solutions increased. The approximate wave-lengths of this limit were  $0.65\mu$  and  $0.67\mu$ , respectively, for the mother-solution and for the solution that contained 40 per cent of water.

#### COPPER CHLORIDE IN ETHYL ALCOHOL. [See plate 29.]

The concentration of the mother-solution of copper chloride was 0.321. The percentages of water in the solutions of the complete set were 56, 52, 48, 44, 40, 36, 32, 28, 24, 20, 16, 12, 8, 4, and 0. Each successive difference equals 4 per cent. The colors of the liquids when viewed in the cell varied from blue, through greenish-blue, bluish-green, green, and yellowish-green, to olive, as the percentage of water decreased from 56 to zero. The photographic strip contiguous to the numbered scale belongs to the solution that contained 56 per cent of water. The next strip corresponds to the 52 per cent solution, etc., until finally the strip adjacent to the comparison spectrum corresponds to the anhydrous mother-solution. The depth of the cell was 2 cm. The spectrogram shows a one-sided region of strong absorption in the ultra-violet and violet, and suggests another like region in the yellow and orange. The negative strip corresponding to the solution that contained the greatest amount of water recorded faintly the strong cadmium doublet at 3467, but the continuous background faded out at near  $0.350\mu$ . Transmission began weakly at  $0.520\mu$  for the mother-solution. The curve outlined by the ends of the photographic strips appeared to be convex towards the ultra-violet region of absorption throughout the greater part of its course, whereas in general the curves obtained for copper chloride, whether in water alone or in water which also contains some dehydrating agent, were concave towards the left.

The spectroscope showed that there was an absorption band in the infra-red which extended into the visible spectrum. For the anhydrous mother-solution transmission began at about  $0.635\mu$ , and for the solution which contained the greatest amount of water it commenced at  $0.700\mu$ . Eye observations on the spectra of the solutions in question showed that the limit of absorption in the red receded to longer wave-lengths as the percentage of water in the solutions increased.

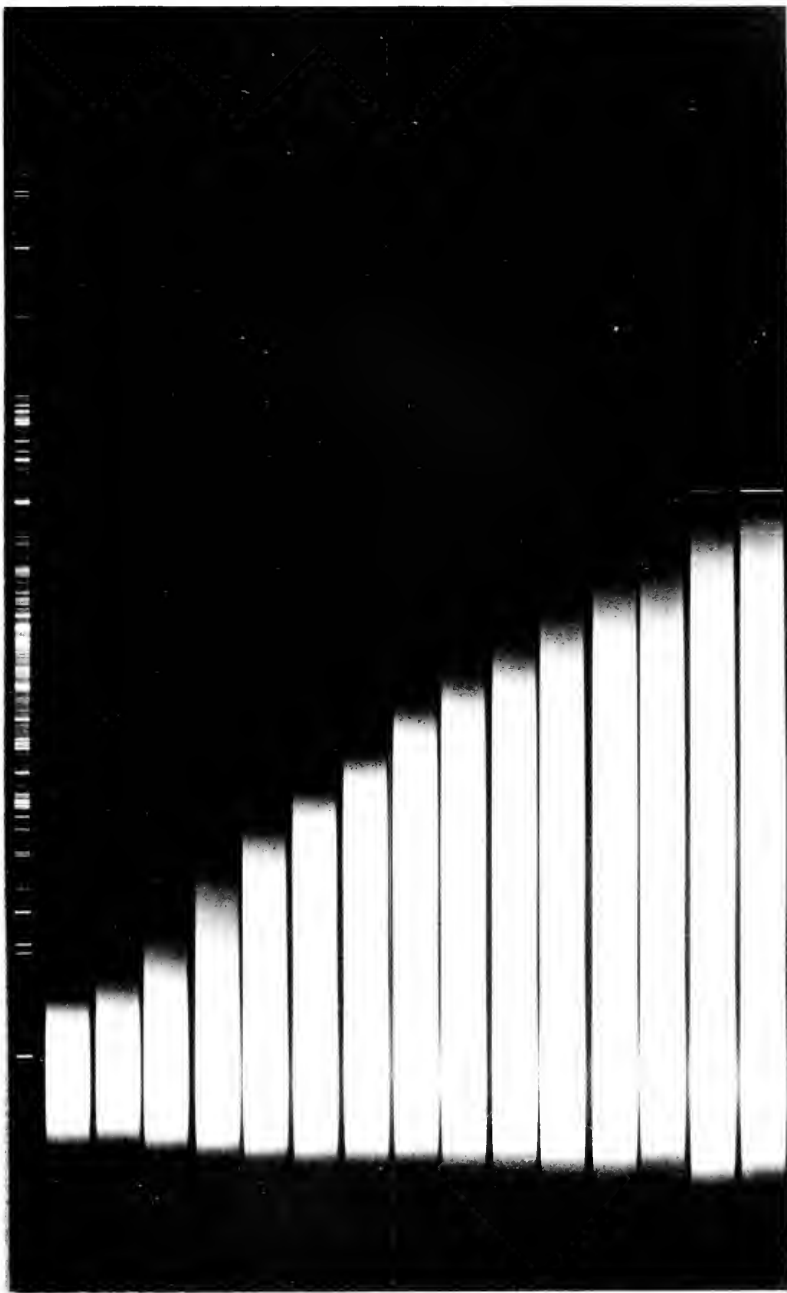

20  
21  
22  
23  
24  
25  
26  
27  
28  
29  
30  
31  
32  
33  
34  
35  
36  
37  
38  
39  
40  
41  
42  
43  
44  
45  
46  
47  
48  
49  
50  
51  
52  
53  
54  
55  
56  
57  
58  
59  
60  
61  
62  
63



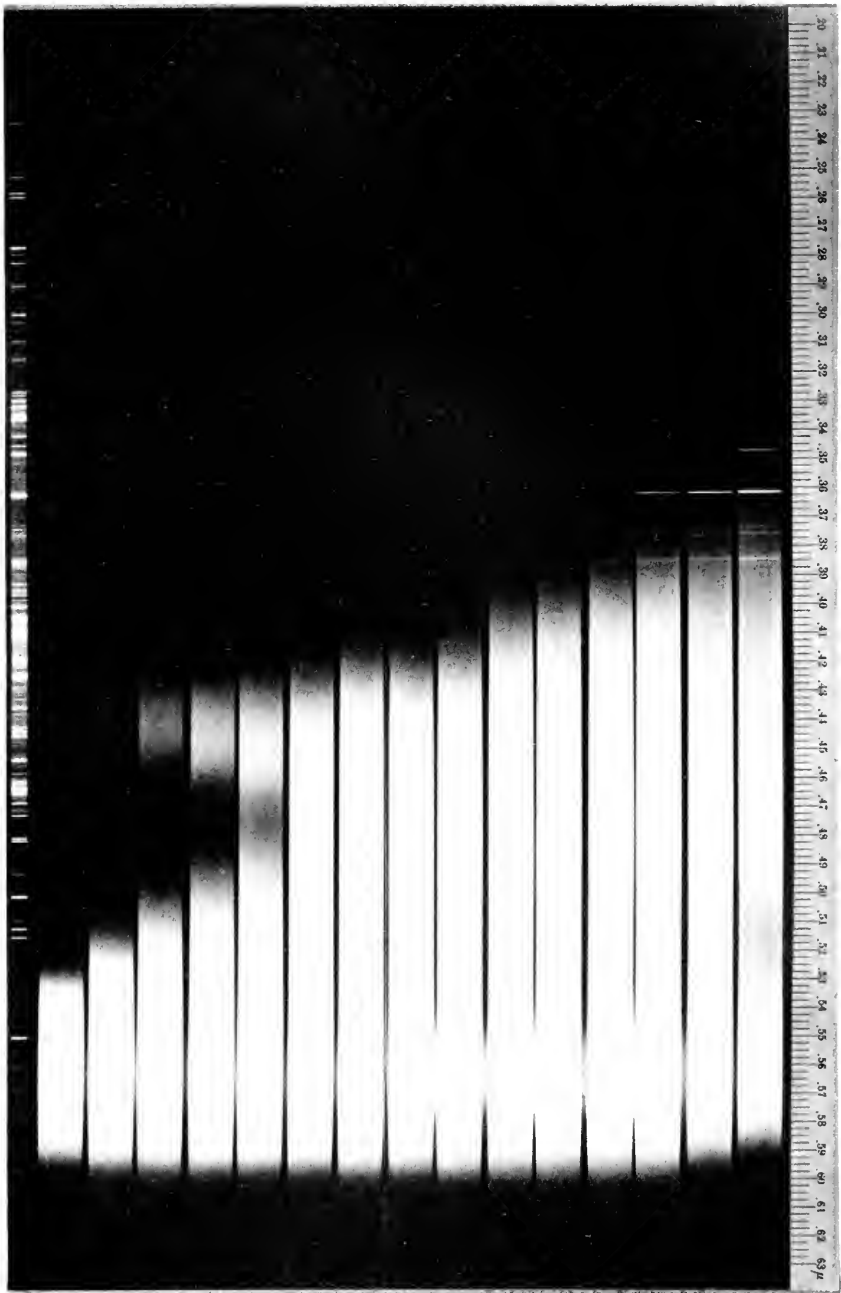





## COPPER CHLORIDE IN ACETONE. [See plate 30.]

The concentration of the mother-solution of copper chloride in acetone was 0.022. The percentages of water in the various solutions of the set were 28, 24, 22, 20, 18, 16, 12, 10, 8, 6, 4, 3, 2, 1, and 0. The first and sixth differences were 4 per cent. The last four increments were each 1 per cent, and all the remaining increments 2 per cent. The solutions varied in color from bluish-green to dark olive as the percentage of water decreased from 28 to 0. The strip most remote from the numbered scale corresponds to the anhydrous mother-solution; the next strip pertaining to the solution which contained 1 per cent of water, and so on until the strip adjacent to the scale corresponds to the solution which contained the greatest amount of water. The depth of the cell was 2 cm. The complete spectrogram shows a region of strong absorption in the ultra-violet and violet, and also a band in the blue-green. The negative strip pertaining to the solution which contained 28 per cent of water, recorded faintly the zinc doublet at  $3345$ , but the continuous background practically ceased at  $0.344\mu$ . The locus of the limits of the region of absorption, which comprise the entire ultra-violet, is a smooth curve concave towards this region. The strip corresponding to the 4 per cent solution barely indicated the existence of an absorption band whose center was at  $0.473\mu$ . The remaining strips, which correspond to the solutions that contain less than 4 per cent of water, show that the band both widened out rapidly and had its center displaced slightly towards the red as the amount of water decreased. In fact, a strip pertaining to the anhydrous solution showed that the band in the blue-green had united with the wide region of absorption in the ultra-violet, so that no light of wave-length shorter than  $0.527\mu$  was transmitted. The middle of the transparent region between the two bands of absorption in question was at about  $0.436\mu$ .

Eye observations with the spectroscope, and with the cell 2 cm. deep, brought out the following facts: The mother-solution transmitted freely orange, yellow, and yellow-green. Its spectrum began at  $0.706\mu$  and ended near  $0.507\mu$ . Since, when the cell was not in the path of the light incident upon the slit of the spectroscope the spectrum began at  $0.775\mu$ , it is evident that the mother-solution absorbed all the deep red. The 2 per cent solution began to transmit at  $0.727\mu$ . The transmission spectrum began to be much weakened near  $0.503\mu$ , and showed a weak band of partial absorption at the more refrangible side of the wave-length. Faint light could be distinguished as far as  $0.435\mu$ . The minimum of transmission in the blue-green could also be observed in the case of the 4 per cent solution. The solution which contained the greatest amount of water began to transmit at about  $0.750\mu$ . The entire series of observations showed that the more refrangible limit of the band which absorbed the red, receded towards the infra-red as the percentage of water in the solution increased.

For the sake of comparison, the spectra of the solutions of copper chloride in the four pure solvents were recorded side by side photographically. [See plates 31 (*a*) and 31 (*b*).] The concentrations of the solutions in water, in methyl alcohol, in ethyl alcohol, and in acetone as solvents were, respectively, 0.795, 0.283, 0.321, 0.022. The depth of cell used was 1.50 cm. for both plates. In the cell the aqueous solution was blue, the solution in methyl alcohol was yellowish-green, the solution in ethyl alcohol was very dark green, and the solution in acetone was brownish-yellow. The negative strips corresponding, respectively, to the solutions in water and in acetone are adjacent to the numbered scale and to the comparison spectrum. The strip nearest to the one that pertains to the aqueous solution, corresponds to the solution in methyl alcohol. The negative of plate 31 (*b*) showed that the extreme limits of transmission for the aqueous solution were  $0.397\mu$  and  $0.598\mu$ . Only the more refrangible limit of the region of visible transmission could be recorded by the Seed film for the solution in methyl alcohol. This limit was given as  $0.472\mu$ . The limits of faint transmission for the solution in ethyl alcohol were recorded as  $0.523\mu$  and  $0.598\mu$ . The negative strip corresponding to the solution in acetone as solvent showed that transmission began at about  $0.519\mu$  and extended beyond the region of sensibility of the photographic emulsion.

The negative for plate 31 (*a*) was taken with a Cramer trichromatic plate. The concentrations of the non-aqueous solutions were the same as for plate 31 (*b*). The concentration of the aqueous solution of copper chloride was 1.590, *i. e.*, twice as great as formerly. This solution was green, with a bluish tinge. The length of the exposure for the Nernst glower was two minutes. The photographic strips succeed one another in exactly the same order for plate 31 (*a*) and for plate 31 (*b*). However, the strip corresponding to the solution in acetone is adjacent to both scales, while the one pertaining to the aqueous solution is nearest to plate 31 (*b*). The extreme limits of transmission were shown by the negative to be  $0.431\mu$  and  $0.591\mu$  for the aqueous solution. The strip corresponding to the solution in methyl alcohol showed that transmission began near  $0.462\mu$ , and only became weakened to a very slight extent at the very end of the plate. The strip pertaining to the solution in ethyl alcohol gave the limits of transmission as  $0.512\mu$  and  $0.608\mu$ . The acetone solution began to transmit at about  $0.507\mu$  and continued to do so beyond the field of view of the spectrograph. The results of eye observations, combined with the data obtained photographically, show that as the solvent for copper chloride was, successively, water, ethyl alcohol, methyl alcohol, and acetone, the middle of the region of transmission in the visible spectrum moved to longer and longer wave-lengths.

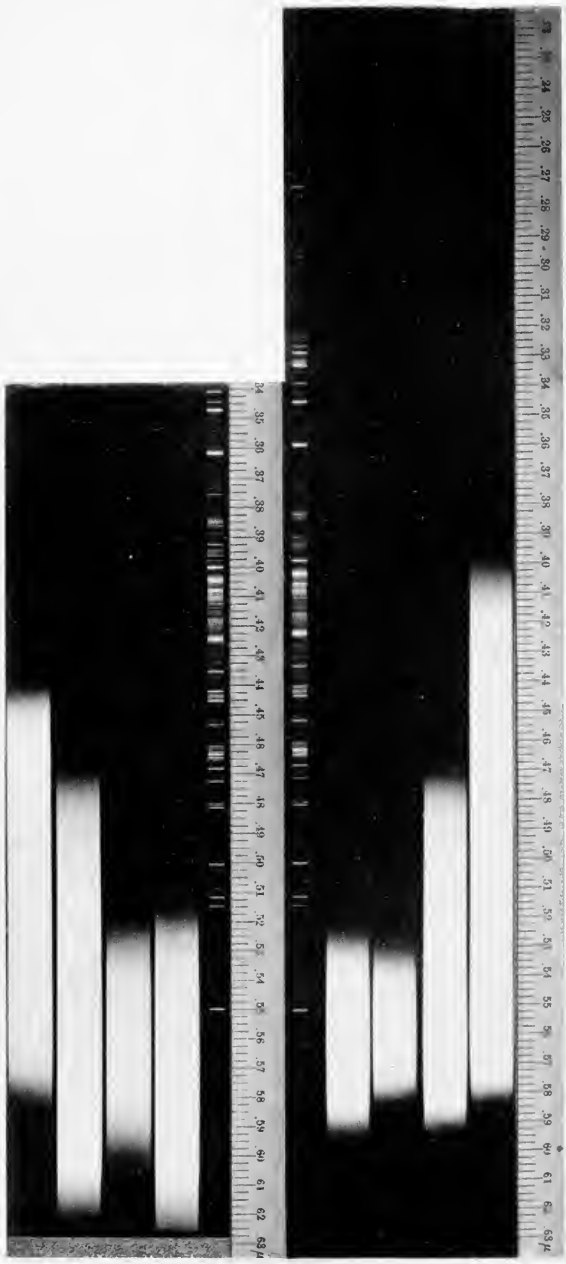

ii

i



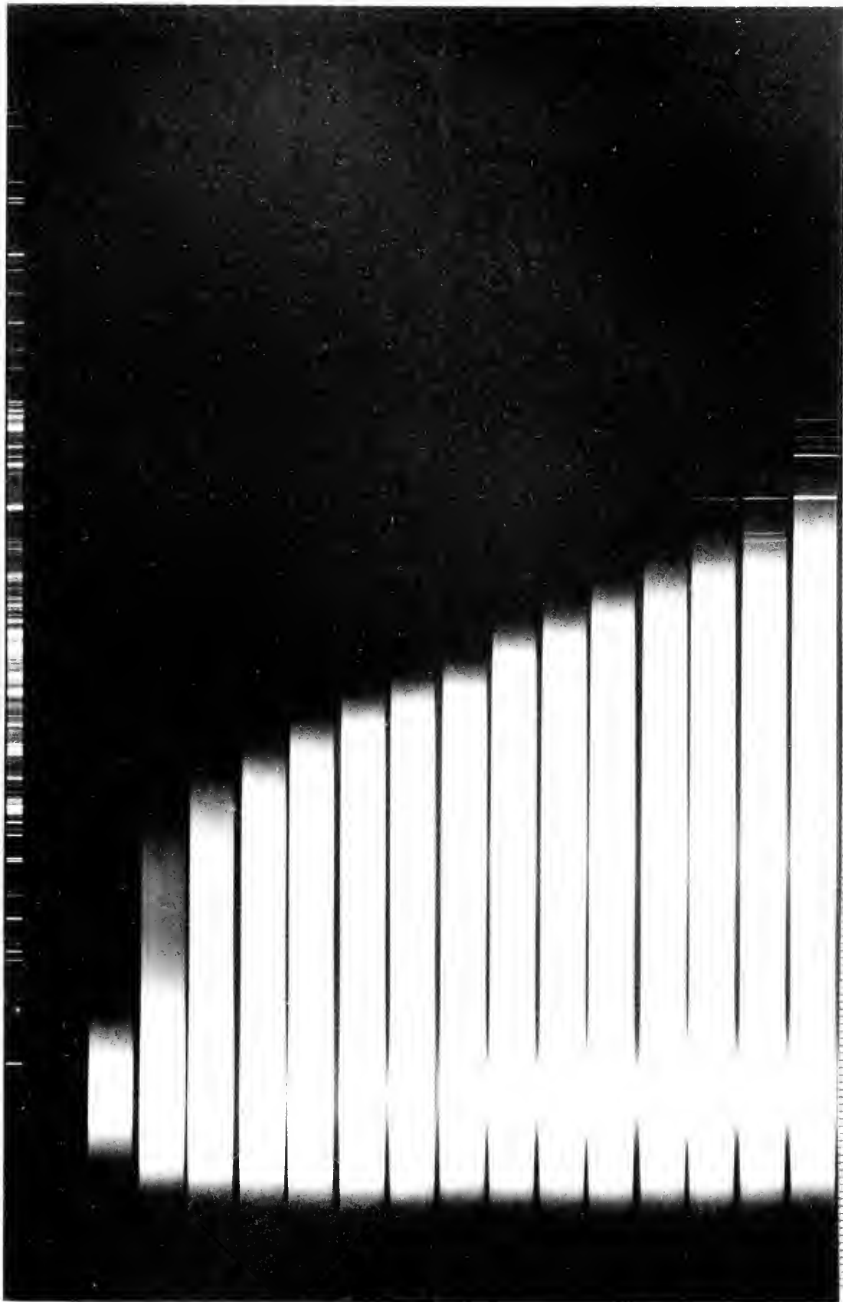



## COPPER BROMIDE IN METHYL ALCOHOL. [See plates 32 and 33 (b).]

The concentration of the mother-solution of copper bromide in methyl alcohol was 0.112. The percentages of water in the solutions of the series were 52, 44, 40, 36, 32, 28, 24, 20, 18, 16, 14, 12, 10, 8, 4, and 0.\* Therefore, the successive differences in percentage were 8, 4, 4, 4, 4, 4, 2, 2, 2, 2, 2, 4, and 4. In the cell which was at a depth of 0.76 cm., the first four solutions were practically colorless, the next three were of an extremely pale brownish-yellow, and the last two dull brown. For the spectrogram of plate 32 the strips corresponding, respectively, to the solution that contained the greatest amount of water, and to the anhydrous solution, are adjacent to the numbered scale and to the comparison spectrum. The negative strip corresponding to the 52 per cent solution recorded faintly the zinc line at  $3282.4$ , but the continuous background hardly extended as far as  $0.334\mu$ . The strip pertaining to the 8 per cent solution showed that weak general absorption had set in beyond the limit of the intense ultra-violet region of absorption. In other words, transmission began at about  $0.453\mu$ , and continued to be relatively weak as far as  $0.527\mu$ . Of course the maxima and minima of photographic sensibility exaggerated the phenomenon in question. The strip corresponding to the 4 per cent solution showed very faint transmission from  $0.482\mu$  to about  $0.530\mu$ .

The strip pertaining to the mother-solution recorded extremely faint transmission from  $0.543\mu$  towards the red. The last three strips showed the existence of general absorption in the orange. Due allowance being made for the values of successive differences in the amounts of water in the solutions, as well as for variations in photographic sensibility, the complete spectrogram shows that the curve for the limit of ultra-violet absorption was convex towards the region of shortest waves, at least throughout the greater part of its course.

The negative for plate 33 (b) was taken with a Cramer trichromatic plate. It gave the spectra of the five solutions of the set in question, which contained the smallest percentages of water, including no water at all. The cell depth was as above, 0.76 cm. Each exposure to the light from the glower was two minutes long. The negative strip corresponding to the 8 per cent solution showed that transmission began at about  $0.453\mu$ , and remained relatively weak as far as  $0.503\mu$ . The strip pertaining to the solution that contained 4 per cent of water gave  $0.498\mu$  as the wave-length of the very beginning of faint transmission. The strip belonging to the anhydrous mother-solution showed an extremely faint transmission from about  $0.530\mu$  to the end of the spectrogram.

\* The solutions of this set, instead of being made up in the usual way, were prepared by measuring the volume of the mother-solution, and adding water to the mark on the measuring flask.

Eye observations with the spectroscope confirmed qualitatively the above results, and also brought out some additional facts relative to the red region in the spectrum. For the mother-solution transmission began at  $0.715\mu$ , rose to a maximum near  $0.651\mu$ , and then decreased to a very small value in the neighborhood of  $0.593\mu$ . Transmission was extremely weak from  $0.593\mu$  to  $0.520\mu$ , *i. e.*, to the beginning of the ultra-violet region of complete absorption. There appeared to be a slight minimum of transmission at  $0.575\mu$ , and a weak maximum at  $0.540\mu$ . Red and orange were obviously the only colors appreciably transmitted. The spectrum of the 4 per cent solution was very much like that of the anhydrous solution. The spectra of both solutions agree in having a relatively bright region of transmission in the red, followed by a long, comparatively weak region in the direction of the shorter wave-lengths. The maximum of transmission was near  $0.640\mu$ , and complete extinction commenced at about  $0.490\mu$ . Green and blue were transmitted much more strongly by the 4 per cent solution than by the mother-solution. The spectrum of the 8 per cent solution showed that the region of weak transmission had left the green and comprised only the blue. There were no appreciable contrasts in the transmitted regions of the spectra of the remaining solutions in the series. As the percentage of water increased from zero to 52, the end of the absorption band in the red receded gradually from about  $0.715\mu$  to  $0.755\mu$ .

COPPER BROMIDE IN ETHYL ALCOHOL. [See plates 33 (*a*) and 34.]

The concentration of the anhydrous mother-solution was 0.101. The percentages of water in the series were 36, 32, 28, 26, 24, 22, 20, 18, 16, 14, 12, 10, 8, 6, 4, and 0. Therefore, all the successive differences are equal to 2 per cent, except the first two and the last one, and each of these is equal to 4 per cent. Viewed in their bottles the solutions varied in color from bluish-green, through the various shades of green and olive, to very dark brown as the amount of water decreased from 36 to 0 per cent. The mother-solution was sensibly opaque except in very thin layers. The same succession of colors was shown by the solutions when in the cell at a depth of 0.24 cm., with the exception that the first four or five solutions appeared practically colorless.

The photographic strips which correspond, respectively, to the solution that contained the greatest amount of water, and to the one that was anhydrous, are adjacent to the numbered scale and to the comparison spectrum of plate 34. The cell depth for both plates 33 and 34 was 0.24 cm. The negative strip belonging to the 36 per cent solution recorded the faintest trace of the cadmium line at  $3261.2$ , but the continuous background became very weak near  $0.340\mu$ . The spectrogram, taken as a whole, shows that the locus of the limit of absorption of the region which included the ultra-violet, was a smooth curve convex towards the region of shortest wave-lengths. Also, the last six or seven photographic strips show that there was general



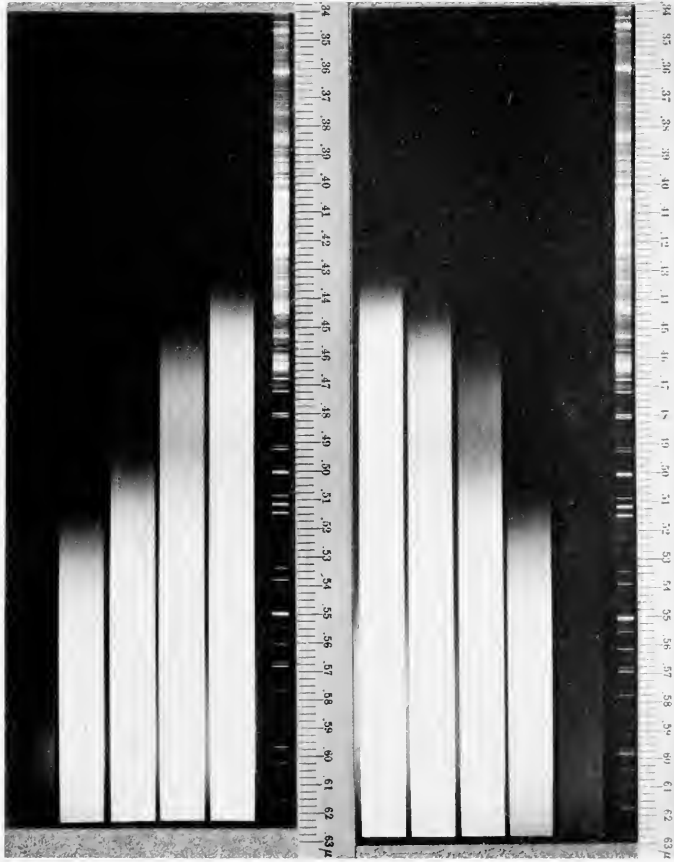

*a*

*b*



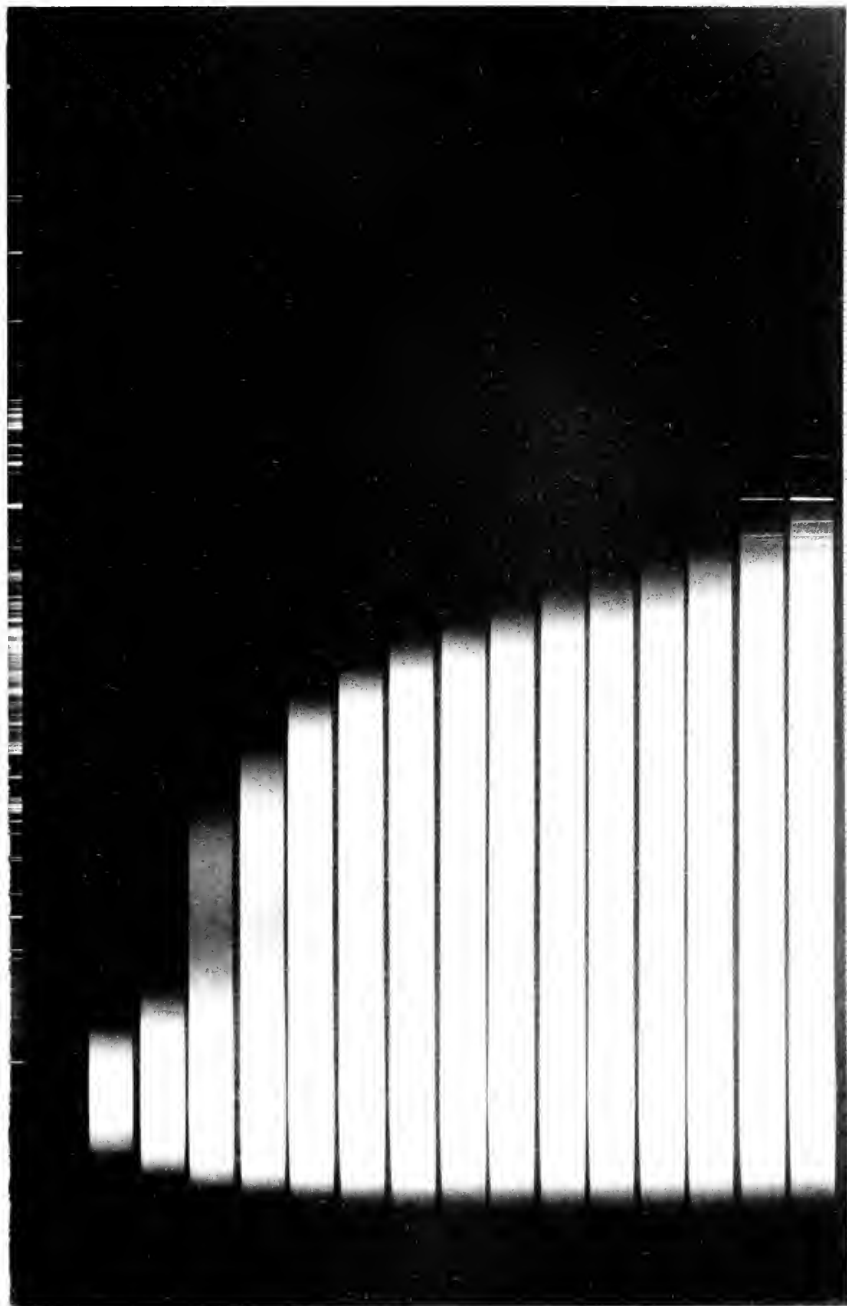

20 21 22 23 24 25 26 27 28 29 30 31 32 33 34 35 36 37 38 39 40 41 42 43 44 45 46 47 48 49 50 51 52 53 54 55 56 57 58 59 60 61 62 63 64 65 66 67 68 69 70 71 72 73 74 75 76 77 78 79 80 81 82 83 84 85 86 87 88 89 90 91 92 93 94 95 96 97 98 99 100



absorption in the orange and red. The strips corresponding to the solution whose percentages of water were 10, 8, 6, and 4, showed that a region of weak general absorption formed a continuation into the blue and green, of the region of intense absorption of the ultra-violet and violet. The strength of this general absorption increased rapidly as the amount of water in the solutions decreased. This is exactly the same phenomenon as was brought to light by the negatives for the solutions of copper bromide in methyl alcohol and varying amounts of water. The strip corresponding to the anhydrous solution recorded extremely faint transmission from  $0.544\mu$  towards the red.

The negative for plate 33 (*a*) was taken with a Cramer trichromatic plate. The spectra photographed corresponded to the five solutions of the series that contained the smallest amount of water, which included, of course, no water. The depth of the cell was 0.24 cm. The exposures to the light from the Nernst filament were each two minutes long. The strip nearest to the scales corresponds to the solution that contained 10 per cent of water. The fifth strip, counting away from the scales, pertains to the mother-solution. The negative strip, corresponding to the 6 per cent solution, recorded the beginning of very faint transmission near  $0.451\mu$ , and showed that relatively intense transmission did not commence until about  $0.510\mu$ . The wave-lengths corresponding, respectively, to the beginning of faint and strong transmission were given as  $0.498\mu$  and  $0.533\mu$  by the strip for the 4 per cent solution. The mother-solution, according to the negative, transmitted very weakly from about  $0.538\mu$  to the end of the field of view of the spectrograph. Eye observations recorded qualitatively the facts revealed by the negative, and also supplemented the latter by giving data for the red end of the spectrum. The depth of cell was, as formerly, 0.24 cm. All light transmitted by the mother-solution was very weak; yet the transmission in the red was relatively intense, as compared with that in the yellow and green. More specifically, transmission began at about  $0.725\mu$ , rose to a maximum at  $0.653\mu$ , and then fell to a very small value in the neighborhood of  $0.598\mu$ . Faint light could be observed from  $0.598\mu$  to about  $0.518\mu$ . At the latter wave-length absorption became complete. The spectrum transmitted by the 4 per cent solution was similar to that of the mother-solution. The yellow and green regions, however, were somewhat stronger, but the blue was very much weakened. The contrast between a relatively bright region of transmission, and a weak region at the more refrangible side of the former, gradually disappeared as the quantity of water in the solutions decreased. The gradations were shown very well by the corresponding negative strips of the spectrogram. For the solution that contained the greatest amount of water the spectrum began near  $0.758\mu$ . The complete series of eye observations showed that the visible end of the absorption band, whose center was in the infra-red, moved towards this region as the percentage of water in the solutions increased.

A series of solutions could not be prepared from copper bromide and acetone, since the latter oxidizes the acetone; it itself probably being reduced to the cuprous condition and immediately precipitated. The spectrograms that were taken for the purpose of comparing with one another the absorption spectra of certain solutions of copper bromide in water, in methyl alcohol, and in ethyl alcohol, are reproduced as plates 35 (a) and 35 (b).

Since the mother-solutions are too opaque to give satisfactory spectrograms, each was diluted with the proper solvent. The concentrations of the solutions of copper bromide in water, in methyl alcohol, and in ethyl alcohol were, respectively, 0.874, 0.036, 0.032. When placed in the cell at a depth of 0.24 cm., the solutions in the order given above were green, light yellow, and yellow with a brownish tinge. For plate 35 (b) the strip adjacent to the numbered scale corresponds to the solution in ethyl alcohol. The middle strip pertains to the solution in methyl alcohol, and the strip nearest to the spark spectrum corresponds to the aqueous solution. The strip for the ethyl alcohol solution showed that transmission began at about  $0.445\mu$ , and remained comparatively weak as far as  $0.527\mu$ . From this latter point on towards the red, transmission was relatively strong. The negative strip pertaining to the solution in methyl alcohol showed that transmission began near  $0.419\mu$ , and continued intense as far as the limit of sensibility of the photographic film. The negative strip corresponding to the aqueous solution showed that transmission began at  $0.403\mu$ , and remained strong to the limit set by the absence of sensitiveness of the film to orange light. The fact that the middle strip extends beyond the adjacent strips at their less refrangible ends, shows that slight general absorption of the orange was exerted by the solutions in ethyl alcohol and in water.

The negative for plate 35 (a) was taken with a Cramer trichromatic plate. The cell depth was 1.5 cm., and each exposure to the light from the Nernst filament was two minutes long. At this depth the solution of methyl alcohol had a deep, dull-brown color. The solution in methyl alcohol was a deep brownish-yellow. The aqueous solution was dark green. The strip adjacent to the scales corresponds to the aqueous solution, the middle strip pertaining to the solution in methyl alcohol as solvent. The negative showed that the ethyl alcohol solution transmitted very weakly from  $0.554\mu$  to the end of the plate. The photographic maximum of transmission was near  $0.595\mu$ . The middle strip showed that the methyl alcohol solution began to transmit at about  $0.480\mu$ , and that transmission was practically complete from  $0.510\mu$  to the end of the field of view of the spectrograph. The negative strip next to the spark spectrum showed that the aqueous solution began to transmit at  $0.455\mu$ , but the brightness of the transmitted light increased very slowly to a maximum in the vicinity of  $0.556\mu$ . Transmission ended at  $0.603\mu$ .

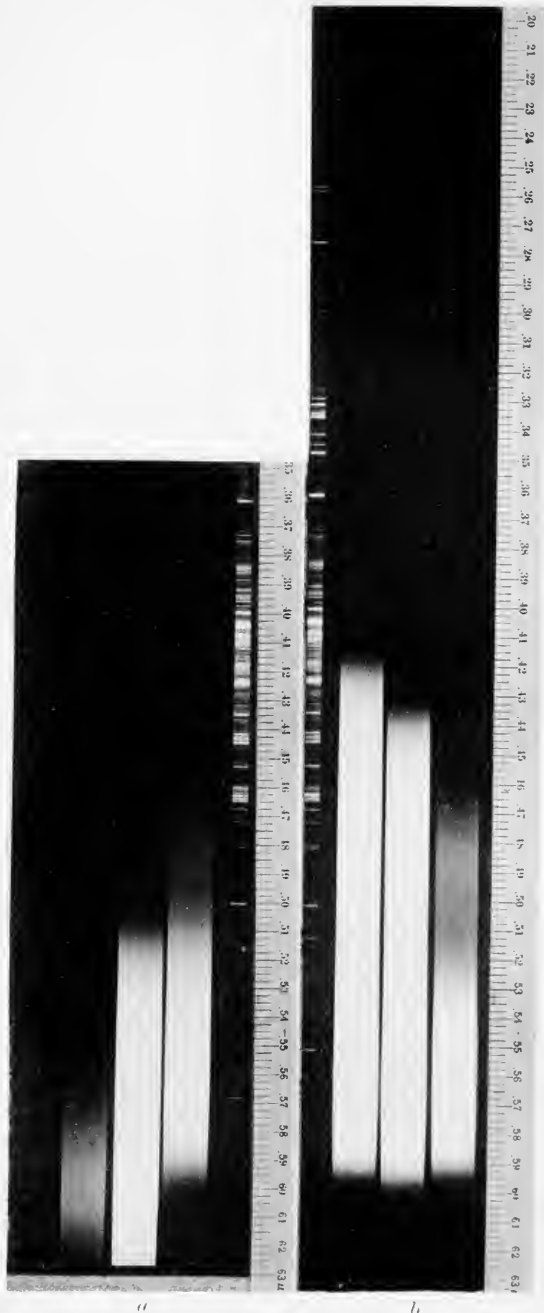





The solutions in question were studied with the spectroscope, the cell having the same depth as for plate 35 (*a*). The solution in methyl alcohol transmitted red and orange fairly well, but yellow and greenish-yellow faintly. The spectrum began at  $0.705\mu$ , rose to a maximum at  $0.640\mu$ , and then decreased to a region of very weak transmission which extended from  $0.588\mu$  to  $0.543\mu$ . The methyl alcohol solution transmitted red and orange pretty well, and yellow quite intensely. The spectrum was relatively weak in the blue. Transmission began at about  $0.716\mu$  and reached its full value in the neighborhood of  $0.610\mu$ . The intensity decreased from about half its maximum value at  $0.525\mu$  to complete absorption at  $0.481\mu$ . The spectrum of copper bromide in methyl alcohol was very much more intense than that for the solution of the same salt in ethyl alcohol. For the aqueous solution transmission began near  $0.636\mu$ , rose to a maximum at about  $0.580\mu$ , and maintained a comparatively small intensity from  $0.520\mu$  to  $0.470\mu$ . The entire spectrum was a good deal weaker than the spectrum of the methyl alcohol solution, and yet appreciably more intense than the solution in ethyl alcohol.

## CONCLUSIONS.

At the close of the account of the investigation of the absorption spectra of certain aqueous solutions, a detailed discussion of the bearing of the spectroscopic results on the existence of hydrates was given. It was shown that the theory was in complete agreement with the observed facts, without a single exception. The fundamental interpretation given to the widening of the absorption bands, either with increase in concentration of the colored salt, or with increase in concentration of dehydrating agent, was that the vibrations of the resonators were becoming less damped, due to the dehydration of the vibrating system. We should expect, then, that the absorption bands characteristic of a given colored salt would become widest for the anhydrous solutions, and would become narrower and narrower on adding more and more water. No further details are necessary, since every spectrogram corresponding to the solutions that contained both a non-aqueous solvent and water, bears out the theory in a most satisfactory manner. The detailed explanation of the significance of the successive increments of absorption need not be repeated for the solutions derived from non-aqueous mother-solutions, since it was discussed so extensively in connection with the aqueous solutions and the dehydrating agents.

The complete spectroscopic investigation seems to leave no reasonable doubt as to the correctness of the theory of hydrates as proposed in this laboratory.

In conclusion we wish to express our thanks to the Physical Department of this University, for placing at our disposal the favorable conditions under which the spectroscopic work was carried out.

## REFERENCES TO PAPERS ALREADY PUBLISHED ON THIS SAME SUBJECT.

1. JONES AND CHAMBERS. On Some Abnormal Freezing-point Lowerings, Produced by Chlorides and Bromides of the Alkaline Earths. *Amer. Chem. Journ.*, **23**, 89 (1900).
2. CHAMBERS AND FRAZER. On a Minimum in the Molecular Lowering of the Freezing-point of Water, Produced by Certain Acids and Salts. *Amer. Chem. Journ.*, **23**, 512 (1900).
3. JONES AND GETMAN. The Lowering of the Freezing-point of Water Produced by Concentrated Solutions of Certain Electrolytes, and the Conductivity of Such Solutions. *Amer. Chem. Journ.*, **27**, 433 (1902).
4. JONES AND GETMAN. The Molecular Lowering of the Freezing-point of Water Produced by Concentrated Solutions of Certain Electrolytes. *Ztschr. phys. Chem.*, **46**, 244 (1903); *Phys. Rev.*, **18**, 146 (1904).
5. JONES AND GETMAN. On the Nature of Concentrated Solutions of Electrolytes. *Amer. Chem. Journ.*, **31**, 303 (1904).
6. JONES AND GETMAN. Über das Vorhandensein von Hydraten in konzentrierten wässrigen Lösungen von Elektrolyten. *Ztschr. phys. Chem.*, **49**, 385 (1904).
7. JONES AND GETMAN. Über die Existenz von Hydraten in konzentrierten wässrigen Lösungen der Elektrolyte und einiger Nichtelectrolyte. *Ber. d. deutsch. chem. Gesell.*, **37**, 1511 (1904).
8. JONES AND GETMAN. The Existence of Hydrates in Solutions of Certain Non-Electrolytes, and the Non-existence of Hydrates in Solutions of Organic Acids. *Amer. Chem. Journ.*, **32**, 308 (1904).
9. JONES AND GETMAN. The Existence of Alcoholates in Solutions of Certain Electrolytes in Alcohol. *Amer. Chem. Journ.*, **32**, 338 (1904).
10. JONES AND BASSETT. The Approximate Composition of the Hydrates Formed by Certain Electrolytes in Aqueous Solutions at Different Concentrations. *Amer. Chem. Journ.*, **33**, 534 (1905).
11. JONES. L'Existence d'Hydrates dans les Solutions aqueuses d'Electrolytes. *Journ. de Chimie physique*, **3**, 455 (1905).
12. JONES AND BASSETT. Der Einfluss der Temperatur auf die Kristallwassermenge als Beweis für die Theorie von den Hydraten in Lösung. *Ztschr. phys. Chem.*, **52**, 231 (1905).
13. JONES AND BASSETT. The Approximate Composition of the Hydrates Formed by a Number of Electrolytes in Aqueous Solutions; Together with a Brief, General Discussion of the Results thus far Obtained. *Amer. Chem. Journ.*, **34**, 291 (1905).
14. JONES. Die annähernde Zusammensetzung der Hydrate welche von verschiedenen Elektrolyten in wässriger Lösung gebildet werden. *Ztschr. phys. Chem.*, **55**, 385 (1906).
15. JONES AND McMASTER. On the Formation of Alcoholates by Certain Salts in Solution in Methyl and Ethyl Alcohols. *Amer. Chem. Journ.*, **35**, 136 (1906).
16. JONES. The Bearing of Hydrates on the Temperature Coefficients of Conductivity of Aqueous Solutions. *Amer. Chem. Journ.*, **35**, 445 (1906).

## INDEX.

	PAGE.		PAGE.
Acetamide	104	Bromide of barium	63
Acetate of sodium	41	cadmium	72
Acetic acid	110	calcium	55
Acetone	104	lithium	31
cobalt chloride in	247	magnesium	67
copper chloride in	253	potassium	43
Acid, acetic	110	sodium	34
chromic	98	strontium	59
citric	115	Bromides, as showing the relation be-	
hydrobromic	94	tween water of crystallization and	
hydrochloric	93	lowering of the freezing-point	22
nitric	96	Cadmium bromide	72
oxalic	112	chloride	72
phosphoric	100	iodide	72
sulphuric	97	nitrate	72
succinic	113	salts	138
tartaric	114	sulphate	73
Acids, organic	142	bromide	55
strong, mineral	140	Calcium bromide and cobalt chloride	200
Alcoholates formed by certain salts in		copper bromide	226
methyl and ethyl alcohols	152	chloride	215
Alcohol, ethyl	102	chloride	54
methyl	101	and cobalt chloride	194
N-propyl	103	copper bromide	224
Aluminium chloride	87	chloride	213
chloride and cobalt chlo-		iodide	57
ride	205	nitrate	58
chloride and copper bro-		salts	137
mide	230	Calculation of the approximate compo-	
chloride and copper chlo-		sition of the hydrates	28
ride	221	Cane-sugar	109
nitrate	88	Carbonate of potassium	45
salts	140	sodium	37
sulphate	89	Cells	171
Ammonium chloride	50	Chambers and Frazer, work of	3
cupric chloride	52	Jones, work of	1
hydroxide	53	Chloral hydrate	105
nitrate	51	Chloride, ammonium cupric	51
salts	137	of aluminium	87
sodium acid phosphate	40	ammonium	50
sulphate	51	barium	62
Apparatus	4, 169, 241	cadmium	72
Aqueous solutions	161	calcium	54
Barium bromide	63	chromium	89
chloride	62	cobalt	80
iodide	64	copper	84
salts	138	iron	90
Bassett and Getman, work of	17	lithium	30
Boiling-point measurements in ethyl		magnesium	65
alcohol	150	manganese	73
measurements in methyl		nickel	76
alcohol	149	potassium	42
method	8	sodium	33

	PAGE.		PAGE.
Chloride of strontium.....	58	Curves, freezing-point, 116, 117, 119, 120,	
zinc.....	70	121, 122, 124, 125,	
potassium cupric.....	49	127, 128, 133, 134	
Chlorides, as showing the relation be-		hydrate.....	130, 131, 132, 134
tween water of crystallization and		refractivity, 118, 122, 123, 125, 126,	
lowering of freezing-point.....	21	128, 129	
Chromate of sodium.....	37	Crystallization, water of, and lowering	
Chromic acid.....	98	of freezing-point,	
Chromium chloride.....	89	relation between..	20
nitrate.....	89	water of, greater the	
salts.....	140	lower the tempera-	
Citric acid.....	115	ture.....	18
Cobalt chloride.....	80, 187	Data and facts.....	186
and aluminium chloride	205	Dichromate of sodium.....	38
calcium bromide..	200	Discussion of the results.....	135
chloride..	194	several theories....	232
in acetone.....	247	Dissociation of potassium ferricyanide..	46
ethyl alcohol.....	245	ferrocyanide..	47
methyl alcohol.....	244	Disodium phosphate.....	39
nitrate.....	82	Earlier work, conclusions from.....	14
salts.....	139	Ethyl alcohol.....	102
sulphate.....	83	cobalt chloride in.....	245
Coefficients, temperature, bearing of		copper bromide in.....	256
hydrates on.....	154	chloride in.....	252
Composition of the hydrates, calcula-		Evidence for the existence of hydrates	17
tion of the approximate.....	28	Experimental work.....	25
Compounds formed, nature of.....	143	Exposures and spectrograms.....	180
Conclusions.....	259	Facts and data.....	186
and summary.....	144	Ferric chloride.....	90
from the earlier work....	14	nitrate.....	92
Conductivities.....	27	Ferrieyanide of potassium, dissociation	46
Conductivity apparatus.....	5, 177	Ferrocyanide of potassium.....	46
curves, 117, 118, 119, 120, 121,		dissociation	47
123, 124, 125, 127, 129		Frazer and Chambers, work of.....	3
large increase in with		Freezing-point apparatus.....	177
rise in temperature,		curves, 116, 117, 119, 120,	
due to decreasing		121, 122, 124, 125,	
complexity of hy-		127, 128, 133, 134	
drates.....	156	lowering, relation be-	
method.....	8	tween water of crys-	
Copper bromide and aluminium chlo-		tallization and....	20
ride.....	230	lowerings.....	26
calcium bromide	226	method.....	7
chloride	224	Fructose.....	107
in ethyl alcohol....	256	General relations.....	142
methyl alcohol...	255	Getman and Bassett, work of.....	17
chloride.....	84	Getman, earlier work of.....	3
and aluminium chloride	221	Glucose.....	107
calcium bromide..	215	Glycerol.....	106
chloride..	213	Hydrate curves.....	130, 131, 132, 134
in acetone.....	253	Hydrate, decreasing complexity of with	
ethyl alcohol.....	252	rise in temperature, is	
methyl alcohol....	251	largely the cause of in-	
nitrate.....	85	crease in conductivity...	156
salts.....	139	theory, new and old.....	143
sulphate.....	86	theory proposed by Jones..	2
Cupric ammonium chloride.....	52	Hydrates, bearing of, on the tempera-	
bromide.....	192	ture coefficients of con-	
chloride.....	190	ductivity.....	153
potassium chloride.....	49	calculation of the approxi-	
Curves, conductivity, 117, 118, 119, 120, 121,		mate composition of...	28
123, 124, 125, 127, 129		evidence for existence of..	17

	PAGE.		PAGE.
Hydrates formed by ions or molecules	143	Nickel chloride	76
in solution, theory of effect		nitrate	78
of temperature on water		salts	139
of crystallization as		sulphate	79
bearing on	17	Nitrate of aluminium	88
Hydrobromic acid	94	ammonium	51
Hydrochloric acid	93	cadmium	72
Hydroxide of ammonium	53	calcium	58
potassium	48	chromium	89
sodium	41	cobalt	82
Introduction	1	copper	85
Introductory	161	iron	92
Iodide of barium	64	lithium	32
cadmium	72	magnesium	68
calcium	57	manganese	75
lithium	32	nickel	78
sodium	35	potassium	44
strontium	60	sodium	36
Iodides, as showing the relation between		strontium	61
water of crystallization and lower-		zinc	70
ing of the freezing-point	23	Nitrates, as showing the relation between	
Ion, mass of, decreases of, with rise in		water of crystallization and	
temperature	153	lowering of the freezing-point	24
Ions or molecules form hydrates	143	Nitric acid	96
with largest hydrating power have		Non-aqueous solutions	241
largest temperature coefficients		Noyes and Coolidge	153, 233
of conductivity	154	Old and the new hydrate theory	143
Iron salts	140	Organic acids	110
Knight and Jones, work of	1	compounds	141
Lactose	109	Ota and Jones, work of	1
Light, sources of	179	Oxalic acid	112
Lithium bromide	31	Papers already published on this same	
chloride	30	subject, references to	260
iodide	32	Phosphate, ammonium sodium acid	40
nitrate	32	disodium	39
salts	135	of potassium, dihydrogen	45
Lowering of freezing-point	26	Phosphoric acid	100
of freezing-point, relation between		Photographic material	178
water of crystallization and	20	Plates	182
Magnesium bromide	67	Potassium bromide	43
chloride	65	carbonate	45
nitrate	68	chloride	42
salts	138	cupric chloride	49
sulphate	69	dihydrogen phosphate	45
Manganese chloride	73	ferricyanide	46
nitrate	75	ferricyanide, dissociation of	46
salts	139	ferrocyanide	46
sulphate	76	ferrocyanide, dissociation of	47
Mannite	108	hydroxide	48
Mass of ion, decreases of, with rise in		nitrate	44
temperature	153	salts	136
McMaster, work of	147	sulphate	44
Methods	7	Propyl alcohol (N)	103
Methyl alcohol	101	Reference lines, wave-lengths of	185
cobalt chloride in	244	References to papers already published	
copper bromide in	255	on this same subject	260
zinc chloride in	251	Refractivity curves, 118, 122, 123, 125, 126,	
Molecules or ions form hydrates	143	128, 129	
Nature of the compounds formed	143	method	8
New and old hydrate theory	143	Relations, general	142
		Results	28

	PAGE.		PAGE.
Results, discussion of.....	134	Sulphate of copper.....	86
obtained in earlier work .....	9	magnesium.....	69
summary of, general .....	232	manganese.....	76
Sodium acetate.....	41	nickel.....	79
ammonium acid phosphate.....	40	potassium.....	44
bromide.....	34	sodium.....	36
carbonate.....	37	zinc.....	71
chloride.....	33	Sulphuric acid.....	97
chromate.....	37	Summary and conclusions.....	144
dichromate.....	38	of results, general.....	232
hydroxide.....	41	Tartaric acid.....	114
iodide.....	35	Temperature coefficients of conductivity,	
nitrate.....	36	bearing of hydrates	
phosphate.....	39	on.....	153
salts.....	136	on water of crystallization,	
sulphate.....	36	effect of, as bearing	
Solutions.....	6, 186, 244	on the theory of hy-	
aqueous.....	161	drates in solution... ..	17
non-aqueous.....	241	Theories, discussion of the several.....	232
Spectrograms and exposures.....	180	Uhler, work of.....	161
Spectrograph.....	169	Urea.....	105
Spectroscope.....	170	Water of crystallization and lowering of	
Strontium bromide.....	59	freezing-point, relation between....	20
chloride.....	58	Water of crystallization, effect of tem-	
iodide.....	60	perature on, as bearing on the	
nitrate.....	61	theory of hydrates in solution.....	17
salts.....	137	Water of crystallization greater the	
Substances employed in earlier work... ..	9	lower the temperature.....	18
that have been studied.....	30	Wave-lengths of reference lines.....	185
Succinic acid.....	113	West, work of.....	151, 156
Sugar.....	109	Zinc chloride.....	70
Sulphate of aluminium.....	89	nitrate.....	70
ammonium.....	51	salts.....	138
cadmium.....	73	sulphate.....	71
cobalt.....	83		











3418

MBL WHOI LIBRARY



WH 18HR 6

