

*

UMASS/AMHERST

*



312066 0103 8164 1

S
73
B39
v. 3

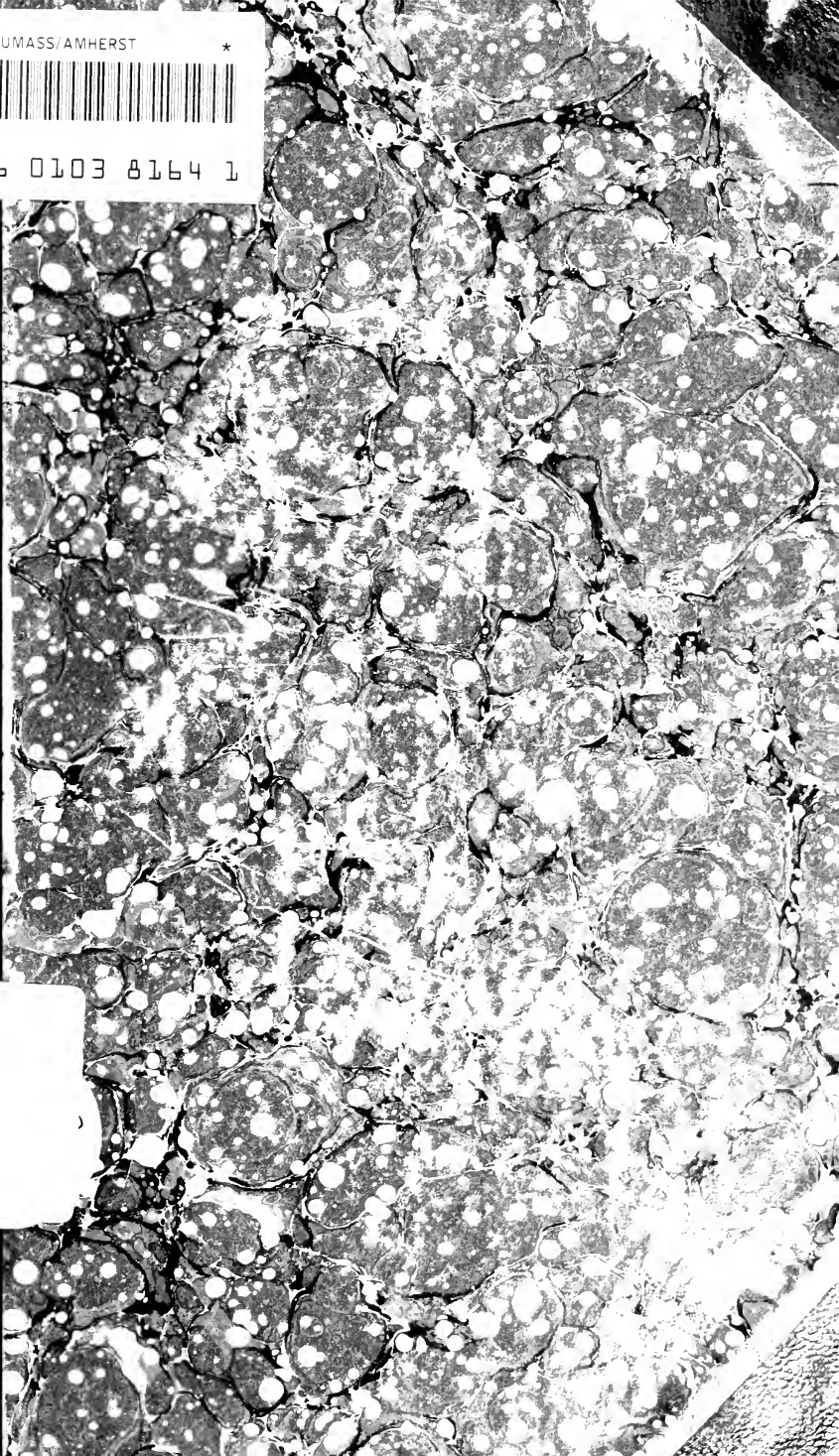

4-10-12



1/2

DATE DUE			
		11:2022431	

UNIVERSITY LIBRARY
UNIVERSITY OF MASSACHUSETTS
AT
AMHERST

S
73
B39

This book may be kept out

TWO WEEKS

only, and is subject to a fine of TWO CENTS a day thereafter. It will be due on the day indicated below.



CATALOGUE

OF THE

THIRD GREAT EXHIBITION

OF THE

BAY · STATE · AGRICULTURAL · SOCIETY,

MECHANICS BUILDING,

OCTOBER 7, 8, 9, 10, 11, 12, 1889.

.. .. .

BOSTON MASS.

PUBLISHED BY L. BARTA & CO.

1889.



PARKER & WOOD

49 North Market Street, Boston, Mass.

ARE HEADQUARTERS FOR

POULTRY SUPPLIES

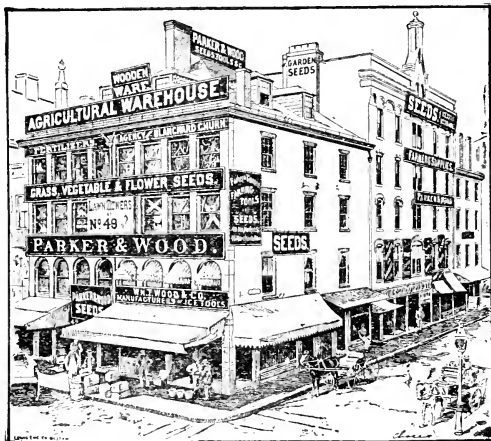

POULTRY SUPPLIES

Excelsior Beef Scraps, Excelsior Ground Oyster Shells,
Dole's Desiccated Fish, Haven's Condition Powders,
Rust's Egg Producer.

We are New England Agents for the above.

Farming Tools of all kinds, Seeds, Woodenware,

WHOLESALE and RETAIL.

HOLLAND BULBS for Fall Planting.

BAY STATE AGRICULTURAL SOCIETY.

COMMITTEE OF ARRANGEMENTS:

President, HENRY S. RUSSELL,* Milton,

Secretary, FRANCIS H. APPLETON,* Peabody,

Treasurer, WM. H. BOWKER, Boston.

E. F. Bowditch,* Framingham,

Edward Burnett, Southboro,

W. W. Rawson, Arlington,

C. Minot Weld, Boston,

W. L. Warner, Sunderland,

N. B. Douglas, Sherborn,

J. D. W. French, No. Andover.

Superintendents.

Cattle	Edward Burnett.
Horses	E. F. Bowditch.
Sheep and Swine	C. Minot Weld.
Poultry	W. F. Bacon.
Agricultural Implements	W. W. Rawson.
Grain and Vegetables	Charles N. Brackett.
Dairy	N. B. Douglass.
Flowers and Fruits	E. W. Wood.
Domestic Manufactures	W. L. Warner.

Consulting Veterinarian, Dr. Austin Peters, Boston.

Chemist, Prof. C. A. Goessman, Amherst.

Business Manager, Charles H. Thayer, Boston.

*Also Trustees of Massachusetts Society for Promoting Agriculture.

“BUILT FOR BUSINESS.”

THE ONLY PRACTICAL
LOW-PRICED ▲ TYPEWRITER.



FIRST-CLASS! . . . RAPID! . . . DURABLE!

World
 Typewriter **\$15** 77 Writes
 Characters.

Catalogue free. Address Typewriter Department, POPE MFG. CO., Makers of **Columbia Cycles**, Boston, New York, Chicago.

\$12,000 IN PREMIUMS

—FOR—

CATTLE, HORSES, SHEEP,

SWINE, POULTRY,

AGRICULTURAL IMPLEMENTS,

GRAIN and VEGETABLES,

DAIRY PRODUCTS,

FRUITS, FLOWERS,

and

DOMESTIC MANUFACTURES,

SEEING IS BELIEVING.

THE
PLYMOUTH ROCK PANTS CO.

Invites the public to visit its workrooms at

11 TO 17 ELIOT STREET,

And SEE Garments Being Made.

This concern never sent a garment to be made in a New York tenement, as it would not risk contagion to its customers. One-half the ready-made clothing sold in this city is made in New York.

EVERY CUSTOMER

of this popular tailoring company has the privilege of

Seeing his Clothes Cut, Trimmed, and Made

under his own eyes. This company never sold a ready-made garment, devoting its whole energies to

PRODUCING A CUSTOM-MADE GARMENT,

of a quality and at a price that would hold the buyer as a steady customer.

PLYMOUTH ROCK PANTS Co.

11 to 17 ELIOT STREET.

Annex, 695 Washington St., and 18 Summer St.

CATALOGUE.

CLASS I. — CATTLE.

NO. 1.—AYRSHIRES.

AYRSHIRE HERDS.

Premium 1—Gold Medal.

- 1 Dudley Wells, Wethersfield, Conn. Bull, Major Bertram, 4516; cows, Flora MacArthur, 4821, Florine, 6520, Florine 2d, 9063, Florine 3d, 9901, Susie MacCrae, 8138; reserve, Lady Mysie, 6524.
- 2 Harry H. Hale, Bradford, Mass. Bull, Athlone, 4332; cows, Creamy 2d, 6354, Miss Mabel 2d, 8930, Miss Flou 3d, 9151, Lady Belle, 9575, Miss Mabel 3d, 9576.
- 3 J. D. W. French, No. Andover, Mass. Bull, Ravenwood, 4323; cows, Mildred, 8547, Modesty 4th, 5452, June Rose, 7517, Sarah Douglas, 4733, Jennie Douglas, 5455, Acorn, 4492.

AYRSHIRE BULLS TWO YEARS OLD.

Premium 3—\$25, \$20.

- 4 Dudley Wells, Wethersfield, Conn. Major Bertram, 4516; bred by Dudley Wells, Wethersfield, Conn.; calved Jan. 29, 1887, sire Donalabain, 4182, dam Dolly 8th, 2251.
- 5 J. D. W. French, No. Andover, Mass. Ravenwood, 4323; bred by C. M. Winslow, Vt.; calved Nov. 23, 1886, sire Emperor, 3355, dam Roxanne, 5955.

Why is it that there are more **NEW TARIFF** and **QUAKER RANGES** sold than any other?

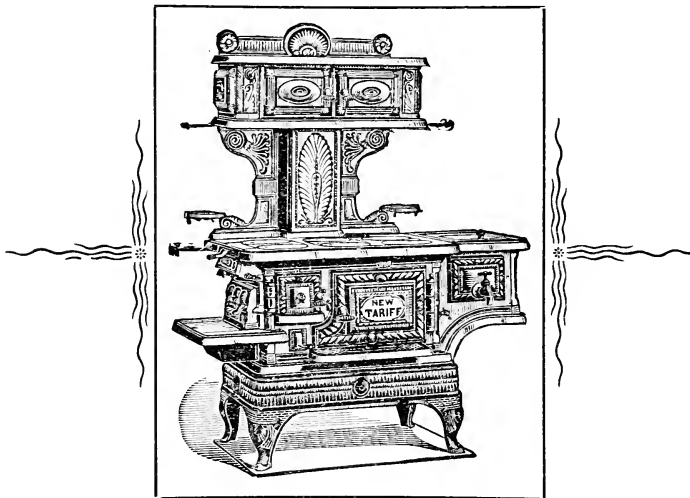

Because they contain more valuable improvements, made and constructed by the most skilled workmen. Indorsed by every good housekeeper. Sold by every first-class dealer. Made in every desirable style and every Range warranted. Manufactured by

Taunton Iron Works Company, Taunton, Mass.

W. H. SWANTON, Manager.

Established 1854.

Warerooms; 87 and 89 Blackstone St., Boston, Mass.

AYRSHIRE BULLS UNDER TWO YEARS.

Premium 4—\$20, \$15.

- 6 Dudley Wells, Wethersfield, Conn. Andrew, bred by Dudley Wells, Wethersfield, Conn.; calved Aug. 30, 1888, sire Menteth, 4183, dam Susie MacCrae.
- 7 Dudley Wells, Wethersfield, Conn. ———, bred by Dudley Wells, Wethersfield, Conn.; calved April 20, 1889, sire Menteth, 4183, dam Flora MacArthur.
- 8 Harry H. Hale, Bradford, Mass. Athlone, 4332; bred by C. M. Winslow, Brandon, Vt.; calved Oct. 18, 1887, sire Rhosus, 3900, dam Roxanne, 5955.
- 9 J. D. W. French, No. Andover, Mass. Prince of Essex, 4666; bred by J. D. W. French; calved Oct. 3, 1888, sire Prince of Ayr 2d, 2283, dam Roxanne 5th, 4606.

AYRSHIRE COWS THREE YEARS OLD OR OVER.

Premium 5—\$25, \$20.

- 10 J. D. W. French, No. Andover, Mass. Mildred, 8547; bred by C. Perley; calved Nov. 20, 1885, sire Max, 2851, dam Rosa McDonald 3d, 4154.
- 11 Dudley Wells, Wethersfield, Conn. Flora MacArthur, 4826; bred by S. M. and D. Wells, Wethersfield, Conn.; calved May 7, 1879, sire Arthur, 952, dam Flora 12th, 2398.
- 12 Dudley Wells, Wethersfield, Conn. Florine, 6520; bred by S. M. and D. Wells, Wethersfield, Conn.; calved Oct. 9, 1880, sire Red King, 2245, dam Flora 12th, 2398.
- 13 Dudley Wells, Wethersfield, Conn. Florine 2d, 9063; bred by D. Wells, Wethersfield, Conn.; calved Dec. 19, 1885, sire Gold King, 2979, dam Florine, 6520.
- 14 Dudley Wells, Wethersfield, Conn. Susie MacCrae; bred by S. M. and D. Wells, Wethersfield, Conn.; calved Oct. 9, 1883, sire Red Knight, 2980, Dam Mysie MacCrae, 4439.
- 15 Harry H. Hale, Bradford, Mass. Creamy 2d, 6354; bred by L. S. Drew, Burlington, Vt.; calved April 10, 1880, sire Athol, 954, dam Creamy, 4482.



A strictly legitimate specific without
deceptive or offensive features of
any kind, for the prompt, pleasant,
and permanent cure of

VITAL EXHAUSTION and DEBILITY

CONCEDED by medical men and press to be the most marvelous medicine of modern times. They act like magic. A few doses work wonders on the vital organs, strengthening the nervous and muscular system, restoring long-lost confidence and arousing the whole physical and mental energy of the human frame. These are "facts," not "fancies," and the best guarantee to the nervous and debilitated is that this specific has a **LARGER SALE THAN ALL OTHERS COMBINED.**

—*—
CATON MEDICAL SPECIFIC CO.
BOSTON, MASS.

- 16 Harry H. Hale, Bradford, Mass. Miss Mabel 2d, 8930; bred by L. S. Drew, South Burlington, Vt.; calved March 13, 1885, sire Bob Conley, 3369, dam Miss Mabel, 6348.
- 17 Harry H. Hale, Bradford, Mass. Miss Flou 3d, 9151; bred by L. S. Drew, South Burlington, Vt.; calved March 14, 1886, sire Bob Conley, 3369, dam Miss Flou, 6345.
- 18 J. D. W. French, No. Andover, Mass. Acorn 4492; bred by C. M. Winslow, Vermont; calved March 6, 1878, sire Sir Archie, 1453, dam Lady Avendale 3d, 3625.
- 19 J. D. W. French, No. Andover, Mass. Modesty 4th, 5442; bred by W. F. Kay; calved Nov. 15, 1878, sire Garibaldi, 1614, Imp. dam Modesty, 3692.
- 20 J. D. W. French, No. Andover, Mass. Sarah Douglas, 4733; bred by E. D. Pearce; calved July 28, 1878, sire Major Drummond, 2006, dam Marion Douglas, 2821.
- 21 J. D. W. French, No. Andover, Mass. Jennie Douglas, 5455; bred by exhibitor; calved Sep. 15, 1878, sire Fitz James, 550, dam Lillie Douglas, 549.
- 22 J. D. W. French, No. Andover, Mass. June Rose, 7517; bred by C. M. Winslow, Vt.; calved June 16, 1883, sire Ayr Douglas, 2865, dam Rebekah, 4496.

AYRSHIRE HEIFERS TWO YEARS OLD AND UNDER THREE.

Premiums 6 and 7—\$20, \$15.

- 23 Dudley Wells, Wethersfield, Conn. Florine 3d, 9901; bred by D. Wells, Wethersfield, Conn.; calved Dec. 18, 1886, sire Gold King, 2979, dam Florine, 6520.
- 24 Dudley Wells, Wethersfield, Conn. Flora Spot 2d, 10136; bred by Dudley Wells, Wethersfield, Conn.; calved Sept., 1887, sire Menteth, 4183, dam Flora Spot, 8141.
- 25 Harry H. Hale, Bradford, Mass. Lady Belle, 9575; bred by L. S. Drew, So. Burlington, Vt.; calved March 1, 1887, sire Bob Conley, 3369, dam Darling of Vermont, 4481.

WEBSTER'S UNABRIDGED

WITH OR WITHOUT PATENT INDEX.

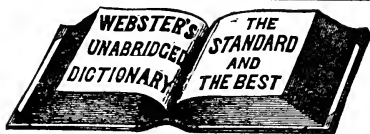

Besides many other valuable tables the latest issue of this work contains

A Dictionary
of 118,000 Words, 3000 Engravings,
A Gazetteer of the World
locating and describing 25,000 Places,
A Biographical Dictionary
of nearly 10,000 Noted Persons,
A Dictionary of Fiction
found only in Webster,
All in One Book.

Webster is Standard Authority in the Gov't Printing Office, and with the U. S. Supreme Court. It is recommended by State Sup'ts of Schools of 36 States.

Sold by all Booksellers.—Illustrated pamphlet mailed free.

Published by G. & C. MERRIAM & CO., Springfield, Mass.

A Library in ITSELF.

The Latest Edition has

3000 more Words,

in its vocabulary, than are found in any other American Dictionary, and nearly three times the number of Engravings.

In quantity of matter, it would make 75 12mo. volumes usually sold for \$1.25 each.

"It is an invaluable companion in every School, and at every Fireside."

- 26 Harry H. Hale, Bradford, Mass. Miss Mabel 3d, 9576; bred by L. S. Drew, So. Burlington, Vt.; calved March 7, 1887, sire Bob Conley, 3369, dam Miss Mabel, 6348.
- 27 J. D. W. French, No. Andover, Mass. Fedalma 2d, 10162; bred by J. D. W. French; calved Sept. 3, 1887, sire Crown Prince, 3590, dam Fedalma, 8231.
- 28 J. D. W. French, No. Andover, Mass. Roxanne 10th, 10509; bred by J. D. W. French; calved Jan. 1887, sire Prince of Ayr 2d, 2283, dam Roxanne, 1816.

AYRSHIRE HEIFERS UNDER TWO YEARS.

Premium 8—\$15, \$8.

- 29 Dudley Wells, Wethersfield Conn. Flora Norton, 10139; bred by D. Wells, Wethersfield, Conn.; calved April 1, 1888, sire Menteth, 4783, dam Flora MacArthur, 4821.
- 30 Dudley Wells, Wethersfield, Conn. Dolly M., 10140; bred by D. Wells, Wethersfield, Conn.; calved June 30, 1888, sire Menteth, 4183, dam Dolly 8th, 2251.
- 31 J. D. W. French, No. Andover, Mass. Princess Rose, 10163; bred by J. D. W. French; calved Dec. 13, 1887, sire Crown Prince, 3590, dam Roxanne 8th, 8536.

SPECIAL PRIZES offered by the Massachusetts Society for Promoting Agriculture:—

Premium 8A—\$75, \$50.

- 32 Harry H. Hale, Bradford, Mass. Bull Athlone, 4332; cows, Creamy 2d, 6354, Miss Mabel 2d, 8930, Miss Flou 4d, 9151, Lady Belle, 9575, Miss Mabel 2d, 9576.
- 33 J. D. W. French, No. Andover, Mass. Ravenwood, 4323; Mildred, 8547, Modesty 4th, 5452, June Rose, 7517, Acorn, 4492, Sarah Douglas, 4733, Jennie Douglas, 5455.

“ORIENTAL”

Condition Powders

FOR
HORSES

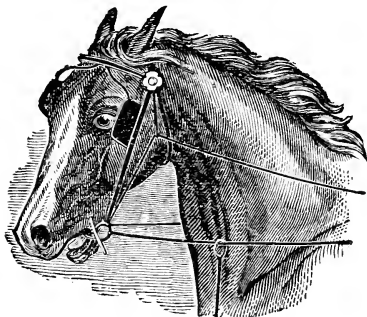

FOR
CATTLE

UNEQUALLED FOR THE CURE OF

Coughs, Colds, Sore Throat, Swollen Glands, Epidemic Catarrh, Nasal Gleet, Distemper, Pink Eye, Acclimating Fever, Hidebound, Skin Diseases, Starring Coat, Worms, Loss of Appetite and General Debility.

DO NOT FAIL

To give these powders a fair and impartial trial and you will soon be convinced of their merit. They are put up in tin boxes, and will keep an indefinite time
PRICE, 50 cents per box. Or will be sent postpaid to any address in the United States on receipt of price.

MANUFACTURED BY

EGYPTIAN CHEMICAL CO.,

LABORATORY AND MAIN OFFICE:

15 Foster's Wharf, Boston, Mass.

BRANCH OFFICE:

513 Walnut Street, St. Louis, Mo.

NO. 2.—JERSEYS.

JERSEY HERDS.

Premium 9—Gold Medal.

- 34 J. M. Sears, Southboro, Mass. Bulls, Darlington's Hugo, 22651, Bomba's Son, 8372; cows, Betty S., 52157, Executrix 2d, 52155, Dora's Daughter, 52153, Lady of Southboro, 40054, Cleopatra de P., 27264, Silver Bijou, 32905.
- 35 John R. Brewer, Hingham, Mass. Bulls, Snappit, 13395, Carl Torment, 18585; cows, Brenda Torment, 45581, Countess Torment, 45583, Daffodil Torment, 53055, Duchess Torment, 53057, Daphne Torment, 53058, Dora Torment, 53056.
- 36 Henry S. Russell, Milton, Mass. Bull, Daniel Pratt, 20480, Am. J. C. Club; cows, Nora P., 374, J.H.B., Sweet Rose, 958, J.H.B., Fusee, 6815, J.H.B., Lady Rosa 2d, 1271, J.H.B., Margotton, 2237, J.H.B., reserve cow, Bonley, 1831, J.H.B.

JERSEY BULLS AND PROGENY.

Premium 10—\$50, \$40.

- 37 J. M. Sears, Southboro, Mass. Bomba's Son, 8372, bred by A. B. Darling; calved June 16, 1882, sire Yellow Bor, dam Bomba. Progeny: Executrix, 30632; bred by H. S. Russell; calved July, 1884, sire Bomba's Son, dam Sylvie 3d. East Wind, 30630; bred by H. S. Russell; calved March 28, 1884, sire Bomba's Son, dam Lady Garenne. Lady of Southboro, 40054; bred by J. M. Sears; calved Oct. 4, 1886, sire Bomba's Son, dam Young Lady Horton. Hawthorn Blossom, 40854; bred by J. M. Sears; calved Nov., 1886, sire Bomba's Son, dam Thorndale Belle 2d.
- 38 John R. Brewer, Hingham, Mass. Snappit, 13395; bred by Davis Collamore; calved Jan. 13, 1884, sire Romp Tormentor, 7126, dam Jolie 2d, 16656. Progeny: Brenda Torment, 45581; bred by J. R. Brewer; calved Dec. 19, 1886, sire Snappit, 13395, dam Cremo 3d, 29426. Cora Torment, 47131; bred by J. R. Brewer; calved Sept. 25, 1887, sire Snappit, 13395, dam Lady Thornton, 34121.

SMITH & WINCHESTER,
19 TO 31 WENDELL STREET, BOSTON.
WIND ENGINES, PUMPS, AND WATER SUPPLY
GOODS OF ALL DESCRIPTIONS.
SEE EXHIBIT.

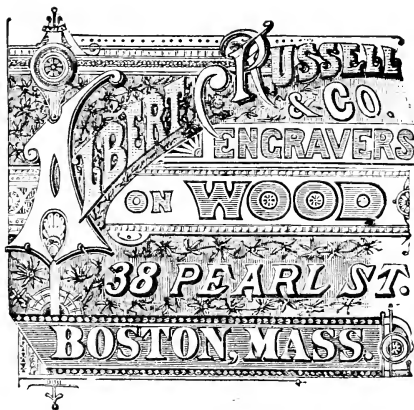

Countess Torment, 45583; bred by John R. Brewer; calved June 4, 1887, sire Snappit, 13395, dam Decatur Celesti, 29427. Daffodil Torment, 53055; bred by J. R. Brewer; calved Jan. 5, 1888, sire Snappit, 13395, dam Cremo 3d, 29426.

JERSEY BULLS TWO YEARS OLD.

Premium 11—\$25, \$20.

- 39 R. Powell, Medfield, Mass. Lord Holland; bred by Mrs. J. E. Phillips; calved March 17, 1887, sire Ramapogis, dam Clethera.
- 40 John R. Brewer, Hingham, Mass. Carl Torment, 18585; bred by John R. Brewer, Hingham; calved May 7, 1887, sire Snappit, 18395, dam Royal Fern, 29144.

JERSEY BULLS UNDER TWO YEARS.

Premium 12—\$20, \$15.

- 42 J. M. Sears, Southboro, Mass. Darlington's Hugo, 22651; bred by A. B. Darlington; calved June 8, 1888.
- 43 Geo. V. Fletcher, Belmont, Mass. Belmont Prince, 23277, bred by Geo. V. Fletcher; calved April 9, 1888, sire Beauty's Duke, 1534, dam Mattie B., 58826.
- 44 John R. Brewer, Hingham, Mass. Dom Pedro Torment, 21308; bred by John R. Brewer, Hingham; calved Aug. 19, 1888, sire Snappit, 13395, dam Lady Thornton, 34121.
- 45 John R. Brewer, Hingham, Mass. Eclipse Torment, 23163; bred by John R. Brewer, Hingham, Mass.; calved April 9, 1889, sire Snappit, 13395, dam Cremo 2d, 29425.
- 46 Henry S. Russell, Milton, Mass. Daniel Pratt, 20480; bred by H. L. Pierce, Boston; calved Oct. 27, 1887, sire Prince Pogis, 10682, dam Moth at St. Lambert, 9775.

LOWNEY'S
 BEST IN THE WORLD.
 \$1.00 PER POUND.
 ELEGANT
 METAL
 BOX.

BY MAIL
 IN ONE AND
 TWO POUND
 BOXES: LARGER
 PACKAGES BY EXPRESS
 RETAIL BRANCH,
 45 WEST ST. BOSTON.

CHOCOLATES
 AND **BON-BONS**

◁ ESTABLISHED 1842. ▷

CHENEY BIGELOW WIRE WORKS,
 SPRINGFIELD, MASS.

BRASS, COPPER,
 AND IRON
 WIRE CLOTH.

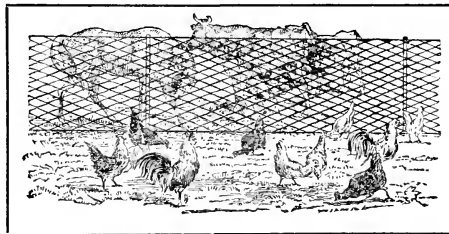

WIRE GUARDS
 AND
 RAILINGS.

Poultry Nettings of all kinds, all widths kept in stock, from 12 inches to 72 inches. Send for prices.

JERSEY COWS THREE YEARS OLD OR OVER.

Premium 13 — \$25, \$20.

- 47 J. M. Sears, Southboro, Mass. Silver Bijou, 32905; bred by S. A. Havemeyer; calved Feb. 14, 1885, sire 9047, dam Bijou le Cerf, 11964.
- 48 J. M. Sears, Southboro, Mass. Cleopatra de Ponterin, 27264, imported; calved March 5, 1881.
- 49 J. M. Sears, Southboro, Mass. Lady of Southboro, 40054; bred by J. M. Sears; calved Oct. 1, 1886, sire Bomba's Son, 8372, dam Young Lady Horton.
- 50 J. M. Sears, Southboro, Mass. Executrix, 30632; bred by H. S. Russell; calved July 18, 1884, sire Bomba's Son, 8372, dam Silvie 3d.
- 51 J. M. Sears, Southboro, Mass. East Wind, 30630; bred by H. S. Russell; calved March 28, 1884, sire Bomba's Son, 8372, dam Lady Garenne.
- 52 Henry S. Russell, Milton, Mass. Lady Rosa 2d, 1271; bred by Ph. Mourant, of Jersey; calved April 5, 1883, sire Governor 2d, 361, dam Lady Rosa, 343.
- 53 Henry S. Russell, Milton, Mass. Margotten, 2237; bred in Jersey; calved May 10, 1885, sire Duke of Melbourne, 383, dam Baron's Mergot, 6187.
- 54 Henry S. Russell, Milton, Mass. Nora, 374; bred by Chas. De Gruchy, of Jersey; calved 1878, sire Jazel P., 159, dam Countess P., 157.
- 55 Henry S. Russell, Milton, Mass. Sweet Rose, 958; bred by P. Mourant, of Jersey, sire Governor, 317, dam Rose, 802.
- 56 Henry S. Russell, Milton, Mass. Fusee, 6815; bred by J. P. Marette, of Jersey; calved Sept. 3, 1882, sire Governor, 317, dam Precoce, 3442.
- 57 Henry S. Russell, Milton, Mass. Rosette 2d, 644; bred by Ph. de Gruchy; calved Feb. 17, 1881, sire Signal, 278, dam La Rose, 1824.

SOME FARMERS DON'T
KNOW THAT

PAIN KILLER

IS THE BEST REMEDY FOR

Horses and Cattle SUFFERING WITH
COLIC, SORE CORDS,
WIND GALLS, ETC.

YOUNG LAMBS,

Exposed to the cold and chilled should be given a dose.

POULTRY.

I have used the Pain Killer for ailing fowls with very good results, and have found it highly beneficial in all cases. Every breeder of poultry should keep it in store. My rule is: one teaspoonful to one pint of water, and no other drink allowed the fowl. Hoping it will prove as satisfactory to others as it has to me, I am yours truly,

Providence, R. I., Oct. 1, 1887.

R. G. DAVIS,

Auditor R. I. Poultry Association.

PERRY DAVIS PAIN KILLER.

- 58 Henry S. Russell, Milton, Mass. Hardy's Hope, 6981; bred by Auguste Hardy; calved March 2, 1883, sire Cruiser, 292, dam Clotha, 2782.
- 59 Henry S. Russell, Milton, Mass. Maiden Blush, 7320; bred by John Picot, Jr., of Jersey; calved 1884, sire Les Cateaux Boy, 497.
- 60 Henry S. Russell, Milton, Mass. Bonley, 1831; bred by John Picot, of Jersey; calved Feb. 2, 1885, sire La Ferme Nestor, 523, dam Result, 3406.

JERSEY HEIFERS TWO YEARS OLD AND UNDER THREE.

Premiums 14 and 15—\$20, \$15.

- 61 J. M. Sears, Southboro, Mass. Hawthorn Blossom, 40854; bred by J. M. Sears; calved Nov. 9, 1886, sire 8372, dam Thorndale Belle 2d, 642.
- 62 John R. Brewer, Hingham, Mass. Countess Torment, 45583; bred by John R. Brewer; calved June 14, 1887, sire Snappit, 13395, dam Decatur Celesti, 29427.
- 63 John R. Brewer, Hingham, Mass. Brenda Torment, 45581; bred by John R. Brewer; calved Dec. 19, 1886, sire Snappit, 13395, dam Cremo 3d, 29426.

JERSEY HEIFERS UNDER TWO YEARS.

Premium 16—\$15, \$8.

- 64 J. M. Sears, Southboro, Mass. Betty S., 52157; bred by J. M. Sears; calved April 11, 1888, sire Bomba's Son, 8372, dam Generous Belle, 27289.
- 65 J. M. Sears, Southboro, Mass. Dora's Daughter, 52153; bred by J. M. Sears; calved Dec. 9, 1887, sire Bomba's Son, dam Dora Wentworth, 32906.
- 66 J. M. Sears, Southboro, Mass. Executrix 2d, 52155; bred by J. M. Sears; calved Jan. 29, 1888, sire Black Prince Pogis, 13995, dam Executrix, 30632.
- 67 Geo. V. Fletcher, Belmont, Mass. Laura B., bred by Geo. V. Fletcher, Belmont, Mass.; calved Feb. 21, 1889, sire Cambridge Duke, dam Nannie B.

C. A. CAMPBELL & CO.,

== COAL ==

59 CONGRESS STREET,

BOSTON.

10 WINNISIMMET STREET, - CHELSEA.

BEACH STREET, - - - REVERE.

BROADWAY, - - - EVERETT.

Telephone 299, Boston.

- 68 Geo. V. Fletcher, Belmont, Mass. Saucy B., bred by Geo. V. Fletcher, Belmont, Mass.; calved Nov. 5, 1888, sire Cambridge Duke 2d, dam Belmont Maid.
- 69 Geo. V. Fletcher, Belmont, Mass. Beauty B., bred by Geo. V. Fletcher, Belmont, Mass.; calved Feb. 28, 1889, sire Cambridge Duke 2d, dam Mattie B.
- 70 John R. Brewer, Hingham, Mass. Daffodil Torment, 53055; bred by John R. Brewer; calved Jan. 5, 1888, sire Snappit, 13395, dam Cremo 3d, 29426.
- 71 John R. Brewer, Hingham, Mass. Duchess Torment, 53057; bred by John R. Brewer; calved March 28, 1888, sire Snappit, 13395, dam Cremo 2d, 29425.
- 71A John R. Brewer, Hingham, Mass. Daphne Torment, 53058; bred by John R. Brewer; calved April 10, 1888, sire Snappit, 13395, dam Decature Celesti, 29427.
- 72 John R. Brewer, Hingham, Mass. Dora Torment, 53056; bred by John R. Brewer; calved Feb. 18, 1888, sire Snappit, 13395, dam Hayesina, 5781.
- 73 Henry S. Russell, Milton, Mass. Calved April 11, 1889, sire Carlo 3d, 827, dam Bonley, 1831.
- 74 Henry S. Russell, Milton, Mass. Calved Jan. 13, 1889, sire Ta'ly Boy, 931, dam Hardy's Hope, 6981.
- 75 Henry S. Russell, Milton, Mass.; calved Jan. 3, 1889, sire Lord Nelson, 900, dam Harvest Maid, 996.
- 76 Henry S. Russell, Milton, Mass. Bonley 2d; bred in Jersey; calved April 21, 1888, sire Lily's Prince, 681, dam Bonley, 1831.

SPECIAL PRIZES offered by the Massachusetts Society for Promoting Agriculture.

Premium 16A—\$75, \$50.

- 77 J. M. Sears, Southboro, Mass. Bulls, Darlington's Hugo, 22651, Bomba's Son, 8372; cows, Betty S., 52157, Executrix 2d, 52155, Dora's Daughter, 52153, Lady of Southboro, 40054, Cleopatra de P., 27264, Silver Bijou, 32905.

PUBLIC TURKISH BATH.



* HOTEL FLOWER, *

The Most Perfect and Palatial Turkish, Russian, and Roman Baths in New England.

Three Turkish Rooms,

Large Russian or Steam Rooms,

Magnificent Deep Sea Salt Water Plunge Bath,

Luxurious Cooling Apartments.

The Service is unsurpassed by any Bath in America.

HOURS FOR BATHERS.

Ladies, 8 A.M. to 12 M., except Sunday; Sunday from 1 to 5 P.M.; Thursday, 8 A.M. to 5 P.M.

Gentlemen, 1 to 10 P.M., except Thursday and Sunday; Thursday, from 6 to 10 P.M.; Sunday, from 8 A.M. to 12 M., and 6 to 10 P.M.

LUNCHES SERVED WHEN DESIRED.

- 78 John R. Brewer, Hingham, Mass. Bull, Snappit, 13395; cows, Brenda Torment, 45581, Countess Torment 45583, Daffodil Torment, 53055, Duchess Torment, 53057, Daphne Torment, 53058, Cora Torment, 47131, Dora Torment, 53056.
- 79 Henry S. Russell, Milton, Mass. Bull, Daniel Pratt, 20480, Am. J. C. Club; cows, Nora P., 374, J. H. B., Sweet Rose, 958, J. H. B., Fusee, 6815, J. H. B., Lady Rosa 2d, 1271, J. H. B., Margotten, 2237, J. H. B., reserve cow, Bonley, 1831, J. H. B.

No. 3.—GUERNSEYS.

GUERNSEY HERDS.

Premium 17—Gold Medal.

- 80 Hopewell Brothers, Natick, Mass. Bull, Morning Star, 255; cows, Dora 3d, 612, Lady of Rosenheim 7th, 1171, Princess Aster 2d, 1519, Bienfaitrice 3d du Desert, 1166, Cream Coat, 4432, and Gipsy 4th, 2076.
- 81 Walter Cutting, Pittsfield, Mass. Momus A. G. C. C. 1435, Clarissa A. G. C. C. 944, Marie's Daughter, 1144, Modesty of Lehigh, 2252, Serenade, 3643, Calliope, 2767, Diana, 146.
- 82 L. P. Morton, Rhinecliff, N. Y. Bull, Lord Stamford; cows, Bienfaitrice 4th, Lillie Orange 2d, Madelene 3d, Roseline 3d, Lady Marion 2d. Reserves, bull, Safeguard, cow, Diss 3d.

GUERNSEY BULL TWO YEARS OLD.

Premium 19—\$25, \$20.

- 83 Walter Cutting, Pittsfield, Mass. Momus, 1435; bred by J. W. Fuller, Catanugua, Penn.; calved Nov. 13, 1886; sire Imp. Herald 2d, 1445, dam Modesty of Lehigh, 2252.
- 83A Hopewell Bros., Natick, Mass. Morning Star, 2130; bred by N. Robin, Grand Clos, Castel; calved Jan., 1887; sire Volage, 98, dam Claire, 1153.

GUERNSEY BULLS UNDER TWO YEARS.

Premium 20—\$20, \$15.

- 84 Walter Cutting, Pittsfield, Mass. Troubadour, 1855; bred by Stephen LaPelley, Island of Guernsey; sire Golden Fleece 2d, 366, dam Serenade, 3643.

REED & BROTHER,

ESTABLISHED 1848.

INSURANCE,

No. 50 KILBY STREET, BOSTON.

AGENTS FOR

SPRINGFIELD FIRE AND MARINE INSURANCE CO.

(Incorporated 1849.)

Cash Capital, \$1,500,000.

MERIDEN FIRE INSURANCE CO., CONN.

(Incorporated 1868.)

Cash Capital, \$200,000.

SECURITY INSURANCE CO., NEW HAVEN, CONN.

(Incorporated 1841.)

Cash Capital, \$250,000.

THE LIBERTY INSURANCE CO., NEW YORK.

(Incorporated 1887.)

Cash Capital, \$800,000.

- 85 L. P. Morton, Rhinecliffe, N. Y. Lord Stamford; bred Island of Guernsey.
- 86 L. P. Morton, Rhinecliffe, N. Y. Midas 2003; bred by S. P. Hutcherson, St. Andrews, Guernsey; calved June 18, 1888, sire Mark Anthony, 386, dam Bella Luce 2d, 3655.

GUERNSEY COWS THREE YEARS OLD OR OVER.

Premium 21—\$25, \$20.

- 87 Hopewell Bros., Natick, Mass. Creamy Coat, 4432; bred in Guernsey; calved March 1883, sire Marmaduke, 162, dam Siles, 500.
- 88 Hopewell Brothers, Natick, Mass. Gipsy 4th, bred by J. L. Patowell, Rameu, St. Peter's Port; calved March 17, 1886, sire Loyal 2d, 110, dam Gipsy, 511.
- 89 Hopewell Brothers, Natick, Mass. Bienfaitrice 3d, bred by J. A. Gavis, Desert St. Saviour; calved Aug. 1, 1885, sire Ransom, 85, dam Bienfaitrice du Desert.
- 90 Hopewell Brothers, Natick, Mass. Lady of Rosenheim, bred by Mrs. Gen. Huyshe, Rosenheim, St. Andrews; calved July 16, 1885, sire Lord John, 144, dam Lady of Rosenheim 4th, 323.
- 91 Hopewell Brother, Natick, Mass. Dora 3d, bred by A. K. Parsons, Kings Mills, Castel; calved July 16, 1883, sire Presto, 14, dam Dora, 1230.
- 92 Walter Cutting, Pittsfield, Mass. Marie's Daughter, 1194; bred by Samuel C. Kent, West Grove, Pa.; calved Oct. 2, 1882, sire Jeweller, 117, dam Marie of Lanfesty, 857.
- 93 L. P. Morton, Rhinecliffe, N. Y. Madelene 3d, 3685; bred by D. O. Le Patourel, Guernsey; calved Oct. 10, 1885, sire Loyal 2d, 110, dam Madelene, 659.
- 94 L. P. Morton, Rhinecliff, N. Y. Roseline 3d, 3697; bred by Thos. H. Mahey, Guernsey; calved June 3, 1885, sire Ruby, 118, dam Roseline, 521.
- 95 L. P. Morton, Rhinecliff, N. Y. Lillie Orange, 3684; bred by Peter Dempsey, Castle Guernsey; calved May 11, 1884, sire Nelson, 195, dam Lillie Orange, 1119.

MAKE HENS LAY

WE SEND BY MAIL

ALARGE 2 $\frac{1}{4}$ POUND CAN FOR \$1.20,
TWO
SMALL PACKS 50^{CTS} POST PAID.

NOTHING ON EARTH
WILL
MAKE HENS LAY
LIKE
SHERIDAN'S CONDITION POWDER.

Sheridan's Condition Powder

is absolutely pure and highly concentrated. One ounce is worth a pound of any other kind. Strictly a medicine, to be given in the food, once daily, in small doses. Prevents and cures all diseases of hens. Worth its weight in gold when hens are moulting, and to keep them healthy. Testimonials sent free by mail. Ask your druggist, grocer, general store, or feed dealer for it. If you can't get it, send at once to us. Take no other kind. We will send postpaid by mail as follows:—A new, enlarged, elegantly illustrated copy of the "FARMERS' POULTRY RAISING GUIDE" (price 25 cents; tells how to make money with a few hens), and two small packages of Powder for 60 cents; or, one large 2 1-4 pound can and Guide, \$1.20. Sample package of Powder, 25 cents, five for \$1.00. Six large cans, express prepaid, for \$5.00. Send stamps or cash. I. S. JOHNSON & CO., 22 Custom-House Street, Boston, Mass.

PULLETS SHOULD BE LAYING.

Young pullets hatched in March and April ought all to be laying this month. Later hatched ones, if not laying by November, will probably if left to themselves not lay before spring, when eggs are down to fifteen cents per dozen. A well-known poultry farmer showed us recently his account for last December, with 125 pullets. The net profit for that month from eggs alone was \$39.39; from the same pullets in April following the profit was \$14.97, and he got fifty dozen more eggs in April than in December. Now this is a striking lesson to all who keep hens for profit. Get all the eggs you can this dull year when other crops are short, as eggs always bring cash. Probably 45 cents per dozen by Christmas. Therefore get the pullets to laying early when prices are highest. Rev. S. W. Squires, of Franklin, Mass., says: "For the purpose of seeing how many eggs I could obtain last winter from twelve hens, I used four large cans of Sheridan's Condition Powder. I believe it is the best preparation known to increase egg production. I saved part of the eggs for hatching after forcing the hens four months for all they were worth with the Sheridan's Powder, and I never had a greater per cent. of fertile eggs or more vigorous chickens. In brief, I do not believe I can afford to be without the Powder to give health and vigor to young hens." Six cans of Sheridan's Powder will pay a good dividend in eggs if you commence early. If you cannot get it near home, I. S. JOHNSON & Co., 22 Custom House Street, Boston, Mass. (the only makers of Sheridan's Condition Powder), will send it as above.

- 96 L. P. Morton, Rhinecliff, N. Y. Bienfaitrice, bred by E. F. Hutcherson, St. Andrews, Guernsey; calved April 23, 1885, sire Lord John, 144, dam Bienfaitrice, 27.

GUERNSEY HEIFERS TWO YEARS OLD AND UNDER THREE.

Premiums 22 and 23—\$20, \$15.

- 97 Hopewell Brothers, Natick, Mass. Princess Aster 2d; bred by Jas. L. Page, Villiocq, Castel; calved Feb. 6, 1887, sire Philidore, 275, dam Princess Aster.
- 98 Walter Cutting, Pittsfield, Mass. Clarabel, 3415; bred by Dr. I. Nelson Borland, New London, Ct.; sire Herald 2d, 994, dam Clarissa, 944.
- 99 L. P. Morton, Rhinecliff, N. Y. Lady Marion 2d, 3681; bred by Col. Bissett, Guernsey; calved Dec. 10, 1886, sire Baron Vauxbelts 2d, 155, dam Lady Marion, 1472.
- 100 L. P. Morton, Rhinecliff, N. Y. Princess Victoria 3d, 3690; bred by Frank Carey, Castel, Guernsey; calved June 24, 1887, sire Zanzibar, 305, P. S., dam Princess Victoria, 182, P. S.

GUERNSEY HEIFERS UNDER TWO YEARS.

Premium 24—\$15, \$8.

- 101 Walter Cutting, Pittsfield, Mass. Coy, 4105; bred by Walter Cutting; calved May 14, 1888, sire Julian, 888, dam Modesty of Lehigh, 2252.
- 102 L. P. Morton, Rhinecliff, N. Y. Phantom, 3952; bred by F. Falla, Castel, Guernsey; calved Jan. 22, 1888, sire Zanzibar, 305 P. S., dam Fantaisie 3d, 3668.
- 103 L. P. Morton, Rhinecliff, N. Y. Floral, 4180; bred by F. Bison, Island of Guernsey; calved July 21, 1888, sire Safeguard, 1790, dam Flora of Eilerslie, 3669.

SPECIAL PRIZES offered by the Massachusetts Society for Promoting Agriculture.

* ESTABLISHED IN 1831. *

WASHBURN & MOEN MFG. CO.,

WORCESTER, MASS.

Makers of Iron and Steel, and Manufacturers of Wire for all Purposes.

HARD AND SOFT DRAWN COPPER WIRE.

Plain and Galvanized Iron and Steel Telegraph and Telephone Wire for Electrical Purposes.

Wire Rope and Cable of Every Description.



Galvanized Steel Wire Cables for Suspension Bridges. Galvanized Iron Wire Rope for Ship's Rigging, etc. Transmission and Standing Ropes. Phosphor, Bronze, and Copper Wire Rope. Hoisting Ropes. Tiller Ropes. Switch Ropes. Copper, Iron, and Tinned Sash Cord. Wire Clothes Lines. Picture Cord. Galvanized Wire Seizing. And all the fixtures and Appliances Required for Use with the foregoing.

GLIDDEN PATENT STEEL BARB FENCING.

Patent Steel Wire Bale Ties. Pump Chain. Watch and Clock Main Springs. Eyeglass Springs. Two Strand Twisted and Flat Twisted Fence Wire, without Barbs. Steel Wire for Needles and Drills. Fence Staples, Stretchers, etc. Bright, Annealed, Tinned, Galvanized, and Copper Wire, on Spools 1 ounce to 1 pound.

Send for Price Lists, Circulars, and Descriptive Pamphlets.

NEW YORK WAREHOUSE:
16 Cliff Street.

CHICAGO WAREHOUSE:
107 Lake Street.

 Premium 24A—\$75, \$50.

- 104 Walter Cutting, Pittsfield, Mass. Bull, Momus, 1435; cows, Clarissa, 944, Marie's Daughter, 1144, Modesty of Lehigh, 2252, Serenade, 3643, Calliope, 2767, Diana, 146.
- 105 Hopewell Bros., Natick, Mass. Bull, Morning Star, 255; cows, Dora 3d, 612, Lady of Rosenheim 7th, 1171, Princess Aster 2d, 1519, Bienfaitrice 3d du Desert, 1166, Cream Coat, 4432, Gypsy 4th, 2076.

No. 4.—HOLSTEINS.

HOLSTEIN HERDS.

Premium 25—Gold Medal.

- 106 Wm. H. Bent, Cochituate, Mass. Bulls, Clothilde 4th, Imperial, Sir Olany Clothilde; cows, Lakeside Clarissa, Klaske L, Coriander 2d, Aaggie Cornelia 5th, Aaggie Duchess, Doetje Welling 2d.
- 107 Isaac Damon, Cochituate, Mass. Bull, Soldene 2ds, Netherland, 8619; cows, Waconsta, 4267, Spiræa, 7029, Marquita, 9305, Northern Queen, 2933, Netherland Chaperon's Clothilde, 10272, Zan 3ds, Princess.
- 108 John A. Frye, Marlboro, Mass. Bulls, Mercedes Prince, Korter 3ds, Keyes; cows, Clasina Hengeweld 2d, Swopkje, Butterfly 3d, Poyneritje, Antiqua, Krazitje Yonktze.
- 109 H. W. Keyes, Newbury, Vt. Bulls, Netherland Monarch 2d, 1128, H. F. Aaggie Flora's Banjo, 2093, H. F.; cows, Silhouette, 1787, H., Heslinger of Pine Grove, 12816, H. F., Lieze of Pine Grove, 12815, H. F., Gerbeus of Pine Grove, 12837, H. F., Basma of Pine Grove, 12839, Queen of Hillside, 1620, D. F.
- 110 Chas. Robinson & Son, Barre Plains, Mass. Artis Peer, 9048, Queen of Pawling, 2420, Maudina 3d, 3377, Maudina 4th, 6323, Addie Van Kampen, 6853, Maid of Orleans 2d, 8633.
- 111 Chas. Robinson & Son, Barre Plains, Mass. Forster, 2771, Jepna, 2d, 733, Carlotta 2d, 3555, Tacona, 8142, Eunice Clay, 1007, Mabel Douglas, 1109.

THERE ARE 4,781 ENTRIES,

More or less, in this exhibition. Some are pretty, some unique, some instructive. None can do you as MUCH GOOD as a year's subscription to the oldest, brightest, ablest, most reliable agricultural and family newspaper, the **NEW ENGLAND FARMER**, which has been from the first an **EARNEST ALLY** of the Bay State Agricultural Society, or its grange twin — **OUR GRANGE HOMES**. We can show immense piles of testimonials proving that **THOUSANDS OF PEOPLE** think that it has wonderfully improved since managed by Geo. M. Whittaker, M. A.; that Mr. A. W. Cheever is absolutely without a peer as an agricultural editor; that Mrs. A. E. Whittaker's "Women's Interests" page is in itself worth the small assessment on those whose names are booked on our roll of honor; that Mr. A. F. Hunter is an unsurpassed poultry expert whose department is worth \$1.99 of any man's money; that the dairy department is just "boss"; that it is unexcelled as an all round, general purpose agricultural paper; that all the best agricultural writers contribute to its columns; that its market reports are incomparable; that it is unsurpassed as a grange organ; that Mr. Messer, master of the Vermont State Grange, is an A 1 grange and agricultural editor; that there is good reason for the officers of State and national granges endorsing and approving it; in short, that the above features, with the editorial, out'ook, news, story, literary, educational, humorous, puzzle, and other general departments combine to make an array of talent, enterprise, reliability, instruction, and entertainment, to be found nowhere else.

TERMS. — \$2 per year, in advance, \$1.50 in clubs. 3 months' trial, 25 cents. Liberal premiums.

SPECIAL OFFER. — To every sixth person who mails to us this offer, with 25 cents for a three-month's trial subscription, we will send the paper free one year.

**NEW ENGLAND FARMER,
OUR GRANGE HOMES,**

34 Merchants Row, BOSTON.

- 112 W. A. Russell, No. Andover, Mass. Lavinia 2ds, Bismark, 2128, H. F. H. B., Esther Marion's Prince, 489, H. F. H. B.; cows, Lady Shepard, 1586, H. F. H. B., Maud Clay, 390, H. F. H. B., Lady Lyons, 6805, H. F. H. B., Belle Fairfax, 1117, H. F. H. B., Maud Clay 2d, 9712, H. F. H. B., Lady Bess, 1051.
- 113 W. A. Russell, No. Andover, Mass. Nitalias Ondinus, 6910, Prince Betz Independence, Sireza Archer, 8368, H. F. H. B., Princess Willem Archer, 8366, H. F. H. B., Belle Thyrsa, 8442, H. F. H. B., Francis F. Marion, 8369, H. F. H. B., Gracie A. 8367, H. F. H. B., Daisy Shepard.

HOLSTEIN BULLS AND PROGENY.

Premium 26 — \$50, \$40.

- 114 John A. Frye, Marlboro, Mass. Mercedes Prince, 2150; bred by Thomas B. Wales; calved April 14, 1882, sire Jaap, 452, dam Mercedes, 723. Progeny: Mercedes Prince 8th, 12634, March 9, 1889, sire Mercedes Prince, dam Rangely, 12032, Tritonia 2ds, Mercedes Prince, Mercedes Manaqua, March 28, 1889, sire Mercedes Prince, dam Seatack, Mercedes Butterfly, June 16, 1889, sire Mercedes Prince, dam Butterfly.
- 115 Chas. Robinson & Son, Barre Plains, Mass. Forster, 2771; bred by B. B. Lord; calved March 14, 1884, sire Barrington, 2103, dam Lillith, 5138. Progeny: Queen of Pawling, 2420; bred by J. B. Dutcher; calved Jan. 24, 1886, sire Forster, 2771, dam Maid of Pawling, 7408, Maudina 3d, 3377; bred by J. B. Dutcher; calved March 23, 1886, sire Forster, 2771, dam Maudina, 6349, Maudina 4th, 6323; bred by Dutcher & Son; calved Feb. 25, 1887, sire Forster, 2771, dam Maudina, 6349, Addie Van Campen, 6853; bred by Dutcher & Son; calved March 4, 1887, sire Forster, 2771, dam Annie Van Campen, 740.
- 116 W. A. Russell, No. Andover, Mass. Royal Archer, 3263; bred by J. L. T. Groneman, North Holland; calved March 18, 1885, sire Nicholas, 322, N. H. B., dam Christina, 926 N. H. B. Progeny: Sireza Archer, 8368; calved June 1, 1889, dam Sireza, 1050, Princess Willem Archer, 8366; calved May 16, 1887, dam Princess

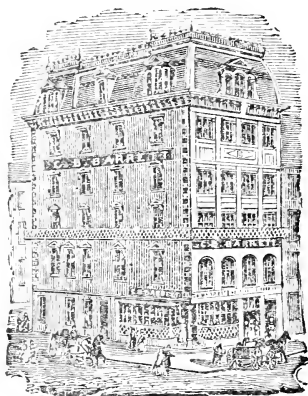

GERMAN PEAT MOSS

FOR STABLE BEDDING.

IT WILL NOT BURN.

The Best, Cheapest, and Healthiest in the world; keeping the horses clean, feet soft, and giving pure air in the stable.

\$5.00 worth will last one horse a year. Try it, and use no other.

PRICES:—\$3.00 single bale.
2.75 for 5 bales or more.
15.00 per ton, on board cars.

BY THE BALE, TON, OR CARLOAD AT LOWEST CUT PRICES.

C. B. BARRETT, IMPORTER,
45 North Market St., BOSTON, MASS.

PLEASE SEND FOR OUR CIRCULAR.

BUY YOUR PIPES OF THE IMPORTER.

F. ABRAHAM,

25, 27 and 29 COURT ST., BOSTON, MASS.

The * Largest * Establishment * of * this * Branch * in * the * United * States.

MEERSCHAUM PIPES AND HOLDERS

OF EVERY DESCRIPTION,

MADE AND REPAIRED ON THE PREMISES.

Willem, 4454, Belle Thyrsa, 8442; calved May 30, 1887, dam Theresa, 7473, Francis F. Marion, 8369; calved June 10, 1887, dam Maid Marion 2d, 4734.

HOLSTEIN BULLS TWO YEARS OLD.

Premium 27—\$25, \$20.

- 117 Wm. H. Bent, Cochituate, Mass. Clothilde 4ths, Imperial, 1281; bred by Smith & Powell, Syracuse, N.Y.; calved Oct. 21, 1885, sire 1164, Prince Imperial, dam 3480, Clothilde 4th.
- 118 John A. Frye, Marlboro, Mass. Mercedes Prince, 2150; bred by F. B. Wales, Iowa City, Iowa; calved April 14, 1882, sire Jaap, 432, dam Mercedes 723.
- 119 W. A. Russell, No. Andover, Mass. Natalias Ondinus, 6910; bred W. A. Russell, No. Andover; calved April 11, 1887, sire Ondinus of Peterboro, dam Natalia, 7028.
- 120 W. A. Russell, No. Andover, Mass. Royal Archer, 3263; bred by J. L. T. Gronenan, North Holland; calved March 5, 1885, sire Nicolaoas, 322, N. H. B., dam Christina, 926.
- 121 W. A. Russell, No. Andover, Mass. Esther Marion's Prince, 489; bred by W. A. Russell, No. Andover; calved July 22, 1885, sire Lord of Cornwall, 3429, dam Esther Marion, 1585.
- 122 W. A. Russell, No. Andover, Mass. Lavinia 2ds, Bismark, 2128; bred by W. A. Russell; calved Jan. 7, 1885, sire Lord of Cornwall, 3429, dam Lavinia 2d, 1115.
- 123 Everett Smith, Waltham, Mass. Piersma 2ds, Promoter, 6770; bred by Luther Ball, Lee, Mass.; calved May 5, 1887, sire Mugwump, 3606, dam Piersma 2d, 10044.

HOLSTEIN BULLS UNDER TWO YEARS.

Premium 28—\$20, \$15.

- 124 Wm. H. Bent, Cochituate, Mass. Sir Olany Clothilde, bred by Smith, Powell & Lamb, Syracuse, N. Y.; calved March 18, 1888, dam Olany, sire Clothilde 4th Imperial.

CHARTERED, 1835.

ORGANIZED, 1843.

NEW ENGLAND MUTUAL LIFE INSURANCE COMPANY,

POST-OFFICE SQUARE,
BOSTON, MASSACHUSETTS.

BENJ. F. STEVENS, *President.*
S. F. TRULL, *Secretary.*

JOS. M. GIBBENS, *Vice-President.*
WM. B. TURNER, *Ass't Secretary.*

The benefits of Life Insurance as a part of our business and social civilization are too patent to need any further arguments to impress the fact. Therefore, taking it for granted that the advantages of the business are appreciated, the attention of the public is called to a few reasons why a Massachusetts company should be selected, and especially the **New England Mutual Life**, of Boston, the oldest and largest company in that State, — chartered in 1835.

I. The Insurance Laws of Massachusetts are conceded to be the most equitable for the policy-holder yet enacted by any State.

II. All policies on which two or more payments have been made are **NON-FORFEITABLE** by State law without action of the assured.

III. When a policy-holder ceases to need the protection, or for any reason discontinues the payment of his premium, this law provides for a cash surrender, or paid-up insurance value.

IV. These values are not "estimates," but are fixed amounts, and are endorsed on the policy, thus forming part of the contract. They are also larger than are paid by companies not bound by this law.

V. The **LIFE RATE ENDOWMENTS**, issued at the same rate formerly charged for ordinary life policies, are the most desirable policies written, as they furnish protection (which is the primary object of all insurance) at the lowest price consistent with safety.

Pamphlets, Rates, Etc., furnished upon application to the Home Office.

- 125 Isaac Damon, Cochituate, Mass. Soldene 2ds, Netherland's, 8519; bred by Smith, Powell & Lamb, Syracuse, N. Y.; calved Feb. 3, 1888, sire Netherland Statesman, dam Soldene 2d, 9808.
- 126 John A. Frye, Marlboro, Mass. Mercedes Prince 8th, bred by John A. Frye; calved March 9, 1889, sire Mercedes Prince, 2150, dam Rangely, 12032.
- 127 John A. Frye, Marlboro, Mass. Seatacks Mercedes Prince, 12635, bred by John A. Frye; calved March 28, 1889, sire Mercedes Prince, 2150, dam Seatacks, 8426.
- 128 John A. Frye, Marlboro, Mass. Ademus 2ds, 9176; bred by John A. Frye; calved May 6, 1888, sire Ademus, 6776, dam Neah, 8278.
- 129 H. W. Keyes, Newbury, Vt. Patron of Pine Grove, 10898; bred by J. Man, Holland; calved March, 1888, dam Princesje, 12830, H. F.
- 130 H. W. Keyes, Newbury Vt. Peter of Pine Grove, 10892; bred by K. H. K. Jepma, Friesland; calved Feb. 16, 1888, sire Doedt 2d (1092 Friesian), dam Dina of Pine Grove. (12828 H. F.)
- 131 H. W. Keyes, Newbury, Vt. ———, bred by H. W. Keyes; calved March 12, 1889, sire Netherland Monarch 2d, 1128, H. F., dam Trintje of Pine Grove, 12822, H. F.
- 132 Chas. Robinson & Son, Barre Plains, Mass. Mercedes Prince 7th, 9840; bred by Thos. B. Wales, Iowa City, Iowa; calved March 26, 1888, sire Mercedes Prince, 2150, dam Tietje 2d, 726.
- 133 William G. White, St. Paul, Minn. Tritomia 2d, Mercedes Prince, 12122; bred by T. B. Wales, Iowa City, Iowa; calved Aug. 12, 1888, sire Mercedes Prince, 2150, dam Tritomia, 4567.
- 134 James C. Poor, No. Andover. Prince Betz Independence; bred by John E. Gale, Haverhill, Mass.; calved July 4, 1888, sire Casulita 4355, dam Betz 2d, 1770.

HOLSTEIN COWS THREE YEARS OLD OR OVER.

Premium 29 — \$25, \$20.

- 135 Wm. H. Bent, Cochituate, Mass. Aaggie Cornelia 5th, 6733; bred by F. Groot, Midwood, N. H.; calved March 20, 1883, sire Tromp, 188 N. H. B., dam Aaggie Cornelia, 4410.

== USE ONLY ==
ELECTRIC LUSTRE STARCH



FOR LAUNDRY PURPOSES IF YOU HAVE ANY COMMON SENSE.

It is the best, and the best people use it; anybody who does not use it must be a simpleton. Ask your Grocer for it. Full Pound Packages, 10 Cents.

- 136 Wm. H. Bent, Cochituate, Mass. Lakeside Clarissa; bred by P. Stapel, Shellinkport, N. H.; calved Feb. 26, 1884, sire Willem 3d, dam Niesje, 105.
- 137 Wm. H. Bent, Cochituate, Mass. Klaska L., 5860; bred by S. Oppedisk, Winsum, Kriesland; calved March 27, 1881, dam Klaske, sire Zalle.
- 138 Wm. H. Bent, Cochituate, Mass. Coriander 2d, 2866; bred by R. M. Yarrington, Pine Island, N. Y.; calved March 31, 1885, sire Chestnut, 1949 H. H. B., dam Coriander 3568 H. H. B.
- 139 Isaac Damon, Cochituate, Mass. Zan 3d, 3235; calved April 1, 1880.
- 140 Isaac Damon, Cochituate, Mass. Marquita 9305; calved April, 1883.
- 141 Isaac Damon, Cochituate, Mass. Northern Queen, 2933; calved March, 1883.
- 142 Isaac Damon, Cochituate, Mass. Waconsta, 4267; calved March 10, 1883.
- 143 Isaac Damon, Cochituate, Mass. Spiræa, 7029; calved April 20, 1882.
- 144 John A. Frye, Marlboro, Mass. Neah, bred by G. S. Barda, Frisco; calved March 28, 1881; dam Grietje.
- 145 John A. Frye, Marlboro, Mass. Swopkje; calved April, 1883, sire Garfield, dam Kwack.
- 146 John A. Frye, Marlboro, Mass. Kitty Fisher, 5627; bred by A. Blokker, March 15, 1883, sire Zwartkop, dam Weineds.
- 147 John A. Frye, Marlboro, Mass. Antiqua, 8425; bred by R. T. Koldyk, Friesland; calved in 1884.
- 148 John A. Frye, Marlboro, Mass. Brazitje Jonkje, 8280; bred by K. J. Bouma, Friesland; calved Feb. 19, 1882, dam Janke, 2879.
- 149 John A. Frye, Marlboro, Mass. Butterfly, 906; calved March 15, 1878, sire District Bull of Beemeter, dam Koos.
- 150 John A. Frye, Marlboro, Mass. Klasina Hengeveld 2d, 4998; bred by J. Posch; calved March 15, 1879; sire District Bull of Midwoud, dam Klasina Hengeveld, 656.

CONDY'S FLUID,

ODORLESS, NON-POISONOUS, INEXPENSIVE

DISINFECTANT,

Kills every foul smell INSTANTLY.

ONE PINT BOTTLE MAKES

25 GALLONS.

Unequalled for disinfecting Sick Rooms, Ice Chests, Drains,
STABLES, Shops, Washing Floors, Sinks, etc.

SOLD BY ALL LEADING GROCERS AND DRUGGISTS.

PRICE, 50 CENTS.

BOSTON CHEMICAL CO.,

26 India Square, Boston.

- 151 John A. Frye, Marlboro Mass. Poyneritje, 8264; bred by John Steensra; calved January 24, 1885, sire Albert, dam Swarthah.
- 152 John A. Frye, Marlboro, Mass. Tobago, 8435; bred by T. H. de Jong, Friesland; calved April, 1883.
- 153 John A. Frye, Marlboro, Mass. Tonquin, 2428; bred by J. Jaarsma, Friesland; calved February 26, 1886, sire Garfield, dam Jaasmar Cow.
- 154 H. W. Keyes, Newbury, Vt. Silhouette, 1787; bred by Jacob Toll; calved March 18, 1880, sire Toll's Bull, dam Chaos.
- 155 H. W. Keyes, Newbury, Vt. Heslinger of Pine Grove, 12816; bred by P. S. Hessling, Friesland; calved 1882.
- 156 H. W. Keyes, Newbury, Vt. Lieze, 12815; bred by J. Mann, Brewster, Holland; calved 1881, sire Promp, dam Lieze.
- 157 H. W. Keyes, Newbury, Vt. Queen of Hillside, 1620, D. F.; bred by W. A. Oosterbaam, Friesland; calved March 17, 1884, sire Rembrandt, 172, Friesian, dam Heildtje, 752, Friesian.
- 158 Chas. Robinson & Son, Barre Plains, Mass. Jepna 2d, 733; bred by M. T. Koldyk, Friesland; calved Jan. 17, 1879.
- 159 Chas. Robinson & Son, Barre Plains, Mass. Carlotta 2d, 3555; bred by Smiths, Powell & Lamb, Syracuse, N. Y.; calved June 8, 1883, sire Netherland Prince, 716, dam Carlotta, 1266.
- 160 Chas. Robinson & Son, Barre Plains, Mass. Tacona, 8142; bred by Wm. N. Chapin, Sheffield, Mass.; calved Feb. 22, 1884, sire Paragon, 1175, dam Queen of the Hills 3d, 2149.
- 161 Chas. Robinson & Son, Barre Plains, Mass. Eunice Clay, 1007; bred by W. A. Russell, Lawrence, Mass.; calved July 3, 1885, sire Lord of Cornwall, 3429, dam Emma Clay, 1588.
- 162 Chas. Robinson & Son, Barre Plains, Mass. Mabel Douglas, 1109; bred by W. A. Russell, Lawrence, Mass.; calved July 20, 1880, sire Lord Clifden, 572, dam Ale Marie.
- 163 W. A. Russell, No. Andover, Mass. Lady Sheppard, 1586; bred by W. A. Russell; calved Feb. 6, 1881, sire Lord Clifden, 572, dam Cathrena, 105.

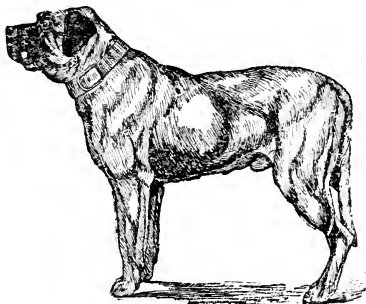

Austin's Dog Bread.

Dog food is whatever goes to the building up of the tissues of the animal and enables it to perform its functions of life. The development of the muscular tissues depends upon the quality and nature of the blood, which in turn depends upon the nature and quality of the food.

AUSTIN'S DOG BREAD, as now manufactured, is unquestionably the best dog food in the market. Its value as a nutrient, and its effective development of muscle, can be readily seen after a short trial. The desire of the manufacturers to produce the very best dog food has not been attained without difficulty. After a long series of experiments we now have a combination that is perfect. To insure satisfactory results we use only the best materials in its composition. To meet the constantly increasing demand for dog bread we have been obliged to enlarge our facilities for its manufacture, and are now able to supply Bench Shows, Kennel Clubs, and Dog Owners, and all orders will be promptly filled by addressing

AUSTIN & GRAVES,

Manufacturers of All Kinds of Crackers and Ship Bread,

116 COMMERCIAL ST., BOSTON, MASS.

- 164 W. A. Russell, No. Andover, Mass. Maud Clay, 390; bred by W. A. Russell, No. Andover; calved March 17, 1876, sire Dictator, 82, dam Lady Clay, 158.
- 165 W. A. Russell, No. Andover, Mass. Lady Lyons, 6805; bred by A. K. Kaan, North Holland; calved July 1, 1884.
- 166 W. A. Russell, No. Andover, Mass. Belle Fairfax, 1117; bred by W. A. Russell; calved Jan. 18, 1879, sire Dictator, 82, dam Maid Fairfax, 377.
- 167 W. A. Russell, No. Andover, Mass. Lady Bess, bred by W. A. Russell, No. Andover; calved March 11, 1879, sire 1st Consul, 100, dam Catarena, 105.
- 168 W. A. Russell, No. Andover, Mass. Maud Clay 2d, 9712; bred by W. A. Russell; calved Jan. 26, 1885, sire Sligo, 621, dam Maud Clay, 390.
- 169 Everett Smith, Waltham, Mass. Lievea, 5717; bred by Kr. Nuperrus, Friesland, Holland; calved April, 1880, sire Zan, dam Levica.

HOLSTEIN HEIFERS TWO YEARS OLD AND UNDER THREE.

Premiums 30 and 31 — \$20, \$15.

- 170 Wm. H. Bent, Cochituate, Mass. Aaggie Duchess; bred by Tailor Bros., Collins, N. Y.; calved March 16, 1887, sire Aaggie Rosa's Prince, dam Myth.
- 171 H. W. Keyes, Newbury, Vt. Bosma of Pine Grove, 12839; bred by K. N. Kuperus, Friesland; calved March 29, 1887, sire Pel Bosma (673 Friesian,) dam Bosma (770 Friesian).
- 172 H. W. Keyes, Newbury, Vt. Gerbeus of Pine Grove, 12837; bred by K. N. Kuperus, Friesland; calved March 12, 1887, sire Pel Bosma (973 Friesian), dam Gerbeus (1085 Friesian).
- 173 Chas. Robinson & Son, Barre Plains, Mass. Maid of Orleans 2d, 8633; bred by J. B. Dutcher & Son, Pawling, N. Y.; calved Sept. 29, 1887; sire Forster, 2771, dam Maid of Orleans, 2201.

HYNEMAN BROTHERS,
 IMPORTERS OF
 FINE * HAVANA * CIGARS,
 AND MANUFACTURERS OF
 ↔ THE THREE CIGAR. ↔
 18 & 20 P. O. SQUARE, ✂ 94 MILK STREET,
 BOSTON.

18 LAMPARILLA, HAVANA.

A. HYNEMAN.

L. HYNEMAN.

B. HYNEMAN.

EDWARD H. BAKER, Prest. INCORPORATED 1889. NEWELL A. THOMPSON, Treas.

THOMPSON & BAKER COAL CO.
 DEALERS IN
ANTHRACITE AND BITUMINOUS COAL,
HARD AND SOFT WOOD.

GENERAL OFFICE, 25 CONGRESS ST., BOSTON.

WHARVES: 9th, cor. Old Harbor Street, SOUTH BOSTON.

81 Main Street, CAMBRIDGEPORT.

CONNECTED BY TELEPHONE.

We make a Specialty of delivering COAL IN BAGS containing 100 lbs. and upwards.

BRANCH OFFICES: Broadway, cor. Dorchester Ave.; K, cor. Fourth St., So. Boston; 482 Broadway, So. Boston; 73 Cambridge St., Boston; 78 Warren St., Roxbury; 600 Main St., Cambridgeport; 11 Brattle St., Cambridge.

- 174 Chas. Robinson & Son, Barre Plains, Mass. Addie Van Campen, 6853; bred by J. B. Dutcher & Son, Pawling, N.Y.; calved March 8, 1887, sire Forster, 2771, dam Annie Van Campen, 740.
- 175 Chas. Robinson & Son, Barre Plains, Mass. Maudina 4th; bred by J. B. Dutcher & Son, Pawling, N. Y.; calved Feb., 1887, sire Forster, 2771, dam Maudina, 6349.
- 176 W. A. Russell, No. Andover, Mass. Sireza Archer, 8368; bred by W. A. Russell, No. Andover; calved June 1, 1887, sire Royal Archer, 3263, dam Sireza, 1050.
- 177 W. A. Russell, No. Andover, Mass. Gracie A., 8367; bred by W. A. Russell, No. Andover; calved May 11, 1887, sire Royal Archer, 3263, dam Geertrudia M., 4445.
- 178 W. A. Russell, No. Andover, Mass. Francis F. Marion, 8369; bred by W. A. Russell, No. Andover; calved June 10, 1887, sire Royal Archer, dam Maid Marion 2d, 4734.
- 179 Everett Smith, Waltham, Mass. Gerretsje 2d, 10645; bred by E. Smith; calved Sept. 20, 1887, sire Bertus, 2915, dam Gerretsje, 3323.
- 180 Everett Smith, Waltham, Mass. Kendrikje 2d, 10140; bred by E. Smith; calved Aug. 20, 1887, sire Taurus Welling, 2651, dam Kendrikje, 3234.

HOLSTEIN HEIFERS UNDER TWO YEARS.

Premium 32—\$15, \$8.

- 181 Wm. H. Bent, Cochituate, Mass. Neptune's Coriander.
- 182 Wm. H. Bent, Cochituate, Mass. Neptune's Coriander; bred by Smiths, Powell & Lamb, Syracuse, N. Y.; calved Feb. 4, 1888, sire Neptune H.H.B., 711, dam Coriander 2d, H.F.H.B., 2866.
- 183 Isaac Damon, Cochituate, Mass. Zan 3ds, Princess; bred by Isaac Damon; calved June 9, 1888, sire Prince Imperial, dam Zan 3d.
- 184 Isaac Damon, Cochituate, Mass. Netherland Chaperon's Clothilde; bred by Smiths, Powell & Lamb, Syracuse, N. Y.; calved Feb. 2, 1888, sire Clothilde 4ths, Imperial, dam Netherland Chaperone.

**THE BOSTON
DAILY AND SUNDAY
GLOBE.**

**Largest Circulation in Boston or New
England.**

THE GLOBE,

Daily and Sunday,

is the best advertising medium in New England.

THE GLOBE,

Daily and Sunday,

Contains the latest news from all parts of the world, and is always ahead. If you do not read the GLOBE regularly you should begin to-day.

When you have occasion to advertise, try the GLOBE, and compare results with other papers.

- 185 John A. Frye, Marlboro, Mass. Lightning Butterfly; bred by John A. Frye, Marlboro, Mass.; calved March 28, 1888, sire Lightning, dam Butterfly.
- 186 John A. Frye, Marlboro, Mass. Mercedes Managua; bred by John A. Frye; calved April 12, 1889, sire Mercedes Prince, dam Managua.
- 187 John A. Frye, Marlboro, Mass. Mercedes Butterfly; bred by John A. Frye; calved June 16, 1889, sire Mercedes Prince, dam Butterfly.
- 188 John A. Frye, Marlboro, Mass. Mercedes Hornell; bred by John A. Frye; calved March 17, 1889, sire Mercedes Prince, dam Lady Hornell.
- 189 H. W. Keyes, Newbury, Vt. Creole of Pine Grove, 13144; bred by H. W. Keyes, Newbury, Vt.; calved March, 28, 1888, sire Banjo, 564, dam Silhouette, 1787.
- 190 H. W. Keyes, Newbury, Vt. Hazel of Pine Grove, 13477; bred by H. W. Keyes; calved Feb. 23, 1888, sire Rooker of Pine Grove, 3971, H. F., dam Jacob Wits Butterfly.
- 191 H. W. Keyes, Newbury, Vt. Norma of Pine Grove, 13139; bred by H. W. Keyes; calved Feb. 26, 1888, sire Banjo, 564, dam Poem, 1430.
- 192 H. W. Keyes, Newbury, Vt. Needle of Pine Grove, 13136; bred by H. W. Keyes; calved Feb. 2, 1888, sire Netherland Monarch 2d, dam Netherland Star.
- 193 H. W. Keyes, Newbury, Vt. ———; bred by H. W. Keyes; calved Feb. 11, 1889, sire Rooker of Pine Grove, dam Netherland Star, 2665, H. F.
- 194 H. W. Keyes, Newbury, Vt. ———; bred by H. W. Keyes; calved Feb. 1, 1889, sire Netherland Monarch 2d, 1128, H. F., dam Midsummer, 9860, H.
- 195 Chas. Robinson & Son, Barre Plains, Mass. Aaggie Clay, 13873; bred by Chas. Robinson, Barre Plains; calved Sept. 7, 1888, sire Hovia's Princess Aaggie Royal, 5867, dam Eunice Clay, 1007.

A SPECIAL FEATURE OF THE FAIR

WILL BE

HUMPHREY'S EQUINE ACTORS,

who will perform at intervals many wonderful and interesting acts,
among them being

A MILITARY DRILL,

BY

TWELVE ✦ TEXAS ✦ BRONCHOS.

Who Answer the Roll Call. Form in Line. March in Single File.
Double File. Counter-march. March in Columns of Four.
March in Columns of Six and in Solid Column,
and Form in Dress Parade.

✦ TWO WHITE BRONCHOS ✦

Perform a wonderful act on a TEETER BOARD.

A Magnificent Dapple Grey Horse,

GOVERNOR,

gives an exhibition of Dancing, Walking Lame, Spanish Twist, Walks,
Trots, Gallops at the word of command; Walks Backward,
Walks Sideways, Marches and Poses as a Statue.

A REALISTIC BATTLE

is fought by four horses, who fire cannons strapped on their backs
and do other startling tricks.

[SEE PAGE 50.]

- 196 William G. White, St. Paul, Minn. Imkje's Mercedes 2d; bred by T. B. Wales, Iowa City, Iowa; calved Aug. 9, 1888, sire Netherland Harold, 3695, dam Imkje's Mercedes, 9490.
- 197 William G. White, St. Paul, Minn. Gold Leaf's Mercedes Princess, 15046; bred by Thomas B. Wales, Iowa City, Iowa; calved July 12, 1888, sire Mercedes Prince, 2150, dam Gold Leaf, 6547.
- 198 William G. White, St. Paul, Minn. Comedia 3d, 15057; bred by Jerre Allis, Isinours, Minn.; calved Oct. 14, 1888, sire Netherland Carl, 3279, dam Comedia, 6997.
- 199 William G. White, St. Paul, Minn. Fatinitza 5th; bred by Jerre Allis, Isnours, Minn.; calved Sept. 9, 1888, sire Netherland Carl, 3279, dam Fatinitza, 2723.
- 200 W. A. Russell, No. Andover, Mass. Daisy Shepard; bred by W. A. Russell, No. Andover; calved Aug. 14, 1888, sire Lord of Cornwall, 2439, dam Lady Shepard, 1586.
- 201 W. A. Russell, No. Andover, Mass. Hattie C. Clay; bred by W. A. Russell; calved Feb. 22, 1889, sire Natalius Ondinus, 6910, dam Moednia Clay, 5373.
- 202 Everett Smith, Waltham, Mass. Doucette 2d, bred by E. Smith; calved June 25, 1889, sire Piersma 2d, Promotor, 6770, dam Doucette, 3608.
- 203 Everett Smith, Waltham, Mass. Knjilliske Princess, bred by E. Smith; calved July 25, 1889, sire Sandusky Prince, 3805, dam; Knjilliske, 3440.

SPECIAL PRIZES offered by the Massachusetts Society for Promoting Agriculture:—

Premium 32A—\$75, \$50.

- 204 Wm. H. Bent, Cochituate, Mass. Bull, Clothilde 4th Imperial. Sir Olany Clothilde; cows, Lakeside Clarissa, Klaske L., Coriander 2d, Aaggie Duchess, Dortje Welling 2d, Aaggie Cornelia 5th.
- 205 Isaac Damon, Cochituate, Mass. Bull, Soldene 2d, Netherland, 8519; cows, Waconsta, 4267, Spiraea, 7029, Marquita, 9306, Northern Queen, 2933, Netherlands Chaperon's Clothilde, 10272, Zan 3d, Princess.

A BEAUTIFUL BAY MARE,

TOPSY,

answers questions of all kinds; Plays on Organ, Rings Bells, Picks out Different Colors, Jumps Skipping Rope, Dances, Shoots Pistols, stands with four feet on a Pedestal ten inches wide,
Rolls a Barrel with her nose.

A TRICK MULE, JERRY,

Fans himself, Rings Bells, Swings himself, and if any one will ride him, makes it very interesting for the rider and the audience.

THE JUMPING PONIES,

BURT,

PHIDO, KNI O'KITCH,

WALPOT,

Give exhibitions of leaping hurdles and high jumping. The smallest of the four,

⇒ **BURT,** ⇐

will jump higher than any pony of his size in the world.

- 206 John A. Frye, Marlboro, Mass. Bull, Mercedes Prince; reserve, Korter 3d, Keyes; cows, Klasina Hengeweld 2d, Kwopkje, Butterfly 3d, Poyneritje, Antiqua, Krazitje Yonktze.
- 207 Chas. Robinson & Son, Barre, Mass. Bull, Artis Peer, 9048; cows, Queen of Pawling, 2420, Maudina 3d, 3377, Maudina 4th, 6323, Addie Van Kampen, 6853, Maid of Orleans 2d, 8633.
- 208 Chas. Robinson & Son, Barre, Mass. Bull, Forster; cows, Jepma 2d, 733, Carlotta 2d, 3555, Tacona, 8142, Eunice Clay, 1007, Mabel Douglas, 1109.
- 209 Wm. A. Russell, North Andover, Mass. Bull, Lavinia 2d, Bismark, 2128; reserve, Esther Marion's Prince; cows, Lady Shepard, 1586, Maude Clay, 390, Lady Lyons, 6805, Belle Fairfax, 1117, Maude Clay 2d, 9712, Lady Bess, 1051.
- 210 Wm. A. Russell, No. Andover, Mass. Bull, Nitalius Ondinus, 6910; reserve, Prince Betz Independence; cows, Sireza Archer, 8368, Princess Willem Archer, 8366, Belle Thyrsa, 8442, Francis F. Marion, 8369, Gracie A., 8367, Daisy Shepard.

NO. 5.—SWISS.

SWISS HERDS.

Premium 33—Gold Medal.

- 211 John A. Bancroft, Worcester, Mass. Bull.
- 212 O. A. Kelley, Worcester, Mass. Fred Tell, 254, Ethel 3d, 96, Gertrude, 295, Angie, 189, Mary 23, Ethel 4th.

SWISS BULLS TWO YEARS OLD.

Premium 35—\$25, \$20.

- 213 John A. Bancroft, Worcester, Mass. Darius, bred by J. A. Bancroft, Worcester, Mass; calved March 7, 1887, sire Nyon, 83, dam Thora, 187.
- 214 John A. Bancroft, Worcester, Mass. Barnard Tell, bred by J. A. Bancroft; calved July 14, 1883, sire Asa Tell, 63, dam Delia, 85.
- 215 O. A. Kelley, Worcester, Mass. Alfonzo Tell; calved March 21, 1887.

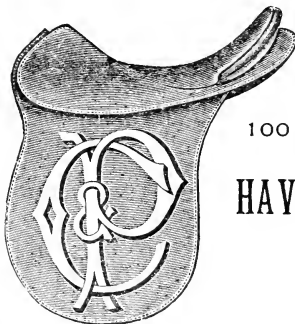
PAGE**&****COFFIN,**

(Formerly
100 Federal Street),

HAVE REMOVED

TO

252 DEVONSHIRE STREET

(WINTHROP SQUARE),

Importers and Dealers In

SADDLERY HARDWARE,

and Manufacturers of

HORSE-BLANKETS,**JAPANESE ROBES,****RUSSIAN DOG-ROBES,****WOOL and PLUSH ROBES,****Coachman's Fur Capes, &c., &c.****Harness of every description.**

SWISS BULLS UNDER TWO YEARS.

Premium 36—\$20, \$15.

- 216 John A. Bancroft, Worcester, Mass. Stowell, bred by J. A. Bancroft, Worcester, Mass.; calved October 29, 1887, sire Nyon Tell, 83, dam Delia, 85.
- 217 O. A. Kelley, Worcester, Mass. Leo Tell, 335; calved November, 26, 1887.
- 218 O. A. Kelley, Worcester, Mass. Shoefly Tell; calved March 16, 1889, sire Fred Tell.

SWISS COWS THREE YEARS OLD OR OVER.

Premium 37—\$25, \$20.

- 219 John A. Bancroft, Worcester, Mass. Delia, bred by J. A. Bancroft, Worcester, Mass.; calved June 12, 1880, sire David G. Tell, dam Rachel, 61.
- 221 John A. Bancroft, Worcester, Mass. Grace, bred by J. A. Bancroft, Worcester, Mass.; calved July 4, 1878, sire Charlie Tell, No. 7, dam Lady Warwick, No. 38.
- 222 John A. Bancroft, Worcester, Mass. Twinkle, bred by J. A. Bancroft, Worcester, Mass.; calved April 7, 1885, sire David G. Tell, No. 31, dam Carrie, No. 106.
- 223 John A. Bancroft, Worcester, Mass. Lyra, bred by J. A. Bancroft, Worcester, Mass.; calved May 10, 1886, sire David G. Tell, dam Ethel, No. 14.
- 224 O. A. Kelley, Worcester, Mass. Mary, 23.

SWISS HEIFERS TWO YEARS OLD AND UNDER THREE.

Premiums 38, 39 — \$20, \$15.

- 225 John A. Bancroft, Worcester, Mass. Carrie, bred by J. A. Bancroft, Worcester, Mass.; calved April 13, 1878, sire William Tell, No. 1, dam Christine, No. 6.

- 226 O. A. Kelley, Worcester, Mass. Virginia, 464; calved Nov. 24, 1886.
- 227 John A. Bancroft, Worcester, Mass. Rowena, bred by J. A. Bancroft, Worcester, Mass.; calved Feb. 4, 1887, sire Nyon, No. 83, dam Martha, No. 70.
- 228 O. A. Kelley, Worcester, Mass. Boston Lady, 463; calved Oct. 22, 1886.

SWISS HEIFERS UNDER TWO YEARS.

Premium 40 — \$15, \$8.

- 229 John A. Bancroft, Worcester, Mass. Wanda, bred by J. A. Bancroft, Worcester, Mass.; calved Feb. 28, 1888, sire Plato, 216, dam Ethel, 14.
- 230 John A. Bancroft, Worcester, Mass. Ax Lirastta; bred by J. A. Bancroft; calved March 8, 1889, sire Barnard Tell, dam Lyra, 367.
- 231 O. A. Kelley, Worcester, Mass. Idlewild, 523; calved May 1, 1888.
- 232 O. A. Kelley, Worcester, Mass. Worcester Belle; calved May 1, 1889, sire Fred Tell, dam Angie, 189.

NO. 6.—SHORTHORNS.

SHORTHORN HERD.

Premium 41—Gold Medal.

- 233 Harry H. Hale, Bradford, Mass. Bull, Duke of Bradford; cows, Mary Queen of the West, 14658; Cherry, 14652; Harriet 4th, Harriet 5th; Rose of Anoka 3d; reserve, Desdemonia.

SHORTHORN BULLS UNDER TWO YEARS.

Premium 44—\$20, \$15.

- 234 Harry H. Hale, Bradford, Mass. Duke of Bradford; bred by George Harding, Waukesha, Wis.; calved Dec. 15, 1887, sire Noxbee Duke, 88223, dam Rose of Anoka.

SHORTHORN COW THREE YEARS OLD OR OVER.

Premium 45—\$25, 20.

- 235 Harry H. Hale, Bradford, Mass. Mary Queen of the West, 14658; bred by Capt. Jack Whittaker, Stone Bank, Wis.; calved March 17, 1882, sire Lord Brompton, 8816, dam British Baron's Beauty.
- 236 Harry H. Hale, Bradford, Mass. Cherry, 14652; bred by Capt. Jack Whittaker, Stone Bank, Wis.; calved September 18, 1884, sire Lord Brompton, 8816, dam Mrs. Mitchem, 14656.
- 237 Harry H. Hale, Bradford, Mass. Harriet 4th; bred by George Harding, Waukesha, Wis.; calved September 15, 1885, sire Oak-land Duke 2d, 33353, dam Harriet 3d.

SHORTHORN HEIFERS TWO YEARS OLD AND UNDER THREE.

Premiums 46 and 47—\$20, \$15.

- 238 Harry H. Hale, Bradford, Mass. Harriet 5th; bred by George Harding, Waukesha, Wis.; calved September 20, 1887, sire Nox-ubee Duke, 88223, dam Harriet 3d, 8960.
- 239 Harry H. Hale, Bradford, Mass. Rose of Anoka 3d; bred by George Harding, Waukesha, Wis.; calved September 27, 1887, sire Noxubee Duke, 88223, dam Red Rose 7th.

SHORTHORN HEIFERS UNDER TWO YEARS.

Premium 48—\$15, \$8.

- 240 Harry H. Hale, Bradford, Mass. Gabrilla of Anoka 5th; bred by George Harding, Waukesha, Wis.; calved February 15, 1888, Sire Pappys Barrington Duke, 88498, dam Gabrilla 35th, 4527.
- 241 Harry H. Hale, Bradford, Mass. Annex; bred by Capt. Jack Whittaker, Stone Bank, Wis.; calved November 8, 1888, sire Capt. Booth (2306), 84997, dam Cherry, 14652.

- 242 Harry H. Hale, Bradford, Mass. Mary Queen of Bradford; bred by Capt. Jack Whittaker, Stone Bank, Wis.; calved December 19, 1888, sire Capt. Booth (2306), 84997, dam Mary, Queen of the West.

SPECIAL PRIZES offered by the Massachusetts Society for the Promoting of Agriculture.

Premium 48A— \$75, \$50.

- 243 Harry H. Hale, Bradford, Mass. Bull, Duke of Bradford; cows, Mary, Queen of the West, 14658, Cherry, 14652, Harriet 4th, Harriet 5th, Rose of Anoka 3d; reserve, Desdemonia.

NO 7.—DEVONS.

DEVON HERD.

Premium 49— Gold Medal.

- 244 Jonathan Hoag, Tomhamrock, N. Y. Bull, Atwood, 4147; reserve, Grover, 4691; cows, Vera, 7204, Modesta, 6982, Princess Vera, 6179, Maid of Orleans, 7408, Queen Vera, 7967.

DEVON BULLS TWO YEARS OLD.

Premium 51— \$25, \$20.

- 245 Jonathan Hoag, Tomhamrock, N. Y. Atwood, 4147, bred by Chauncy Atwood, Woodbury, Ct.; calved May 12, 1887, sire Big, 3283, dam Vera.
- 246 C. H. Baldwin, Whitman, Mass. Bridgewater Boy.

DEVON BULLS UNDER TWO YEARS.

Premium 52—\$20, \$15.

- 247 Jonathan Hoag, Tomhamrock, N. Y. Grover, 4691; bred by Jacob Blakeslee, Watertown, Conn.; calved April 4, 1888, sire Nohabed, 2585, dam Minnie B., 3907.

DEVON COWS THREE YEARS OLD OR OVER.

Premium 53—\$25, \$20.

- 248 Jonathan Hoag, Tomhamrock, N. Y. Vera, 7204; bred by C. Atwood, Woodbury, Ct.; calved March 8, 1883, sire Cornwall, 2079, dam Beauty, 600.
- 249 Jonathan Hoag, Tomhamrock, N. Y. Modesta, 6982; bred by J. Hoag; calved March 6, 1886, sire Fortune, 2250, dam Susie, 4145.
- 250 Jonathan Hoag, Tomhamrock, N. Y. Princess Vera, 6179; bred by J. Hoag; calved Feb., 1885, sire Fortune, 2250, dam Meg, 4950.

DEVON HEIFERS TWO YEARS OLD AND UNDER THREE.

Premiums 54, 55—\$20, \$15.

- 251 Jonathan Hoag, Tomhamrock, N. Y. Maid of Orleans, 7408; bred by J. Hoag; calved March 7, 1887, sire Take Prize, 2921, dam Snowbound, 5754.

DEVON HEIFERS UNDER TWO YEARS.

Premium 56—\$15, \$8.

- 252 Jonathan Hoag, Tomhamrock, N. Y. Queen Wanda; bred by J. Hoag; calved March, 1889, sire Shiloh, 3845, dam Vera, 7204.
- 253 Jonathan Hoag, Tomhamrock, N. Y. Queen Vera, 7967; bred by J. Hoag; calved April 1, 1888, sire Shiloh, 3845, dam Vera, 7204.

NO. 8.—HEREFORDS.

HEREFORD HERD.

Premium 57—Gold Medal.

- 254 E. A. Bailey, Winthrop, Me. Bull, Grove Wilton, 28853; cows—Pearl 3d, 16987, Modest Mary, 15916, Honest Mary, 15915, High, land Mary, 15917, Marygold, 25027, Graceful Mary.

HEREFORD BULL ANY AGE.

Premium 58 — \$25, \$20.

- 255 E. A. Bailey, Winthrop, Me. Grove Wilton; bred by M. H. Cochrane, Hillhurst, Que.; calved June 30, 1886, sire Casio, dam Jessie 3d, 113215.

HEREFORD COW OR HEIFER OF ANY AGE.

Premium 59 — \$25, \$20.

- 256 E. A. Bailey, Winthrop, Me. Modest Mary; bred by J. H. B. Lutley, Worcester, Eng.; calved Jan. 6, 1883, sire Cupid, 7631, dam Gentle Mary, 7668.
- 257 E. A. Bailey, Winthrop, Me. Honest Mary; bred by J. H. B. Lutley, Worcester, Eng.; calved Feb. 4, 1882, sire Cupid, 7631, dam Gentle Mary, 7668.
- 258 E. A. Bailey, Winthrop, Me. Highland Mary; bred by Burleigh & Bodwell, Vassalboro, Me.; calved Jan 1, 1884, sire Surprise, 11461, dam Gentle Mary, 7668.

NO. 9. —

POLLED CATTLE BULL OF ANY AGE.

Premium 61 — \$25, \$20.

- 259 Theo. N. Vail, Lyndon Centre, Vt. Rubicon, 6534; bred by M. H. Cochrane; calved May 6, 1883, sire Paris 3d, 1163, dam Ruby 4th, 3941.
- 260 Theo. N. Vale, Lyndon Centre, Vt. Titus; bred by T. N. Vale; calved April 9, 1889, sire Rubicon, 6535, dam Tibbie, 3882.

POLLED CATTLE COW OR HEIFER OF ANY AGE.

Premium 62 — \$25, \$20.

- 261 Theo. N. Vail, Lyndon Centre, Vt. Lady Ann, 3894; bred by Thompson, of Morsedale, Hull; calved April 16, 1881, sire Cromwell of Tilliefore, 1351, dam Lady Ann of Tilliefore, 3868.

- 262 Theo. N. Vail, Lyndon Centre, Vt. Queen Mary, 3915; bred by M. H. Cochrane; calved June 21, 1883.

NO. 10.--DAIRY CATTLE.

A MILCH CATTLE COW, THREE YEARS OLD OR OVER.

Premium 64—\$25, \$20.

- 263 Theo. N. Vale, Lyndon Centre, Vt. Queen Mary, 3915; bred by M. H. Cochrane; calved June 21, 1883, sire Paris 3d, 2276, dam Queen Mary of Altyne, 4761.
- 264 J. D. W. French, No. Andover, Mass. Ruby Hebron; bred by C. M. Winslow, Vermont; calved March 10, 1880 sire Hebron, 2083, dam Rosa, 3143.
- 265 J. D. W. French, No. Andover, Mass. Acorn, 4492; bred by C. M. Winslow, Vermont; calved March 6, 1878, sire Sir Archie, 1453, dam Lady Avondale 3d, 2625.
- 266 Dudley Wells, Wethersfield, Conn. Susie MacCrae.
- 267 Dudley Wells, Wethersfield, Conn. Florine 2d.
- 268 Dudley Wells, Wethersfield, Conn. Florine.
- 269 Chas. Robinson & Son, Barre Plains, Mass. Mabel Douglas, 1109; bred by W. A. Russell, Lawrence; calved July 20, 1880, sire Lord Clifden, 572, dam Ale Marie, 75.
- 270 John A. Frye, Marlboro, Mass. Five cows.
- 271 John A. Frye, Marlboro, Mass. Two cows.
- 272 Isaac Damon, Cochituate, Mass. Northern Queen.

A MILCH CATTLE HEIFER UNDER THREE YEARS

Premium 65—\$20, \$15.

- 273 John A. Frye, Marlboro, Mass. One heifer.

F. BUTTER CATTLE, HERD OF FIVE COWS TWO YEARS OLD
OR OVER.

Premium 66—\$50, \$40.

- 274 Walter Cutting, Pittsfield, Mass. Clarissa, 944. Marie's Daughter,
1144. Modesty of Lehigh, 2252, Serenade, 3643, Calliope, 2767,
Diana, 146.

F. BUTTER CATTLE, COW THREE YEARS OLD OR OVER.

Premium 67—\$25, \$20.

- 275 Chas. Robinson & Son, Barre Plains, Mass. Eunice Clay, 1007;
bred by W. A. Russell, Lawrence, Mass.; calved July 3, 1885,
sire Lord of Cornwall, dam Emma Clay.
- 276 Isaac Damon, Cochituate, Mass. Zan 3d.
- 276A Hopewell Bros., Natick, Mass. Dora 3d, 4434.
- 276B John A. Frye, Marlboro, Mass. One cow.

NO. 11.—FAT CATTLE, OXEN AND STEERS.

FAT OX, FOUR YEARS OLD OR OVER.

Premium 69—\$25, \$20.

- 277 James C. Poor, North Andover, Mass. Dan.
- 278 James C. Poor, No. Andover, Mass. Dick.
- 279 E. A. Bailey, Winthrop, Me. Pair of Oxen.

FAT STEER THREE YEARS OLD.

Premium 70—\$25, \$20.

- 280 E. A. Bailey, Winthrop, Me. Pair of Steers.

FAT STEER UNDER THREE YEARS OLD.

Premium 71—\$20, \$15.

- 281 E. A. Bailey, Winthrop, Me. Pair of steers.

FAT COW OVER THREE YEARS OLD.

Premium 72--\$20, \$15.

282 E. A. Bailey, Winthrop, Me. Two cows.

FAT HEIFER, UNDER THREE YEARS OLD.

Premium 73—\$15, \$10.

283 E. A. Bailey, Winthrop, Me. Two heifers.

CLASS NO. 2.—HORSES.

NO. 13.—PERCHERONS.

PERCHERON STALLION, FOUR YEARS OLD OR OVER, WITH AT
LEAST THREE OF HIS PROGENY.

Premium 78 — Gold Medal or \$40, \$25.

284 Harry H. Hale, Bradford, Mass. Major Dome, 4345; Black,
16, 6 years.

PERCHERON STALLION FOUR YEARS OLD OR OVER, WITHOUT
PROGENY.

Premium 79—\$30, \$20.

285 L. G. Burnham, Boston, Mass. Prince, Jr.

286 Willard White, Boston. Zephyr, dark gray, 16; bred by M.
Desire, France, got by Brilliant, dam Perlette.

287 Harry H. Hale, Bradford, Mass. Major Dome, 4345; black, 16.

PERCHERON MARES FOUR YEARS OLD OR OVER.

Premium 82—\$20, \$10.

- 288 Harry H. Hale, Bradford, Mass. Vivienne, 4736, black, 17, 7 years.
- 289 Harry H. Hale, Bradford, Mass. Marita, 4353, black, 16½, 6 years.

PERCHERON FILLY TWO YEARS OLD.

Premium 84—\$15, \$8.

- 290 Harry H. Hale, Bradford, Mass. Beatrice, 9097; by Major Dome, 4345; dam Marita, 4353; black.

PERCHERON MARE WITH FOAL AT FOOT.

Premium 86—\$30, \$15.

- 291 Harry H. Hale, Bradford, Mass. Vivienne, 4736; brown.
- 292 Harry H. Hale, Bradford, Mass. Marita, 4353.

NO. 14.—THOROUGHBREDS.

STALLION FOUR YEARS OLD OR OVER.

Premium 88—\$30, \$20.

- 293 George B. Inches, Boston, Mass. Binnacle, dark bay, 15.3½, 6 years, by Algerine, dam Nannie H.

MARE FOUR YEARS OLD OR OVER.

Premium 92—\$20, \$10.

- 294 H. S. Russell, Milton, Mass. Miss Longfellow, 5 years; sire Long Tow, he by Longfellow, dam Ivy H., by Kinmet.

FILLY THREE YEARS OLD..

Premium 93—\$20, \$10.

- 295 Jas. M. Smith, Boston. Imported thoroughbred bay, 15.3, sire Gladstone, dam by General Benefit.

NO. 15. — COACH HORSES.

STALLION FOUR YEARS OLD OR OVER, WITHOUT PROGENY.

Premium 98 — \$30, \$20.

- 295A Blanchard & Nevins. Homere, Chestnut, 16, foaled 1885 at Normandie, France, dam Lisetta from Loustic, daughter of Pilot, sire Criston by Interprise from a daughter of West Australian.

STALLION ONE YEAR OLD.

Premium 101 — \$10, \$5.

- 296 Julius Dennis, Furnace, Mass.

FILLY TWO YEARS OLD.

Premium \$104 — \$15, 8.

- 297 Agustus Hall, North Brookfield, Mass.

MARE WITH FOAL AT FOOT.

Premium 106 — \$30, \$15.

- 298 Julius Dennis, Furnace, Mass.

NO. 16. — TROTTING HORSES.

STALLION FOUR YEARS OLD OR OVER, WITH AT LEAST THREE OF HIS PROGENY.

Premium 107 — Gold Medal or \$40, \$25.

- 299 E. D. Wiggin, Boston, Mass. Charlie Wilkes, 3563, bay, 15.1, by Red Wilkes, 1749, dam Kate Bradley.
- 300 Harry H. Hale, Bradford, Mass. Warder, 5318, by Belmont 64, dam Waterwitch, 15½, chestnut, 6 years.
- 301 C. F. Clark, Boston, Mass. Roland, 4088, brown, 16, 14 years, by Crown Chief, dam Abe Strauss with colts, young Roland, Hattie C. Genevieve.

STALLION FOUR YEARS OLD OR OVER WITHOUT PROGENY.

Premium 108—\$30, \$20.

- 302 Bates Farm, Watertown, Mass. Splitwood, by Wedgewood, dam Cigarette by Hambletonian.
- 303 Waldo T. Peirce, Boston. Sir Walter, 7800, Jr., ch. s. (2.18¼), by Sir Walter, son of Aberdeen, dam Kate Clark by American Clay, 2d dam Mimosa by Alex. Churchill, 3d dam Lux by Wagner.
- 304 J. H. Nay, Readville, Mass. Norman Abdallah 4772; black, 15.3½; bred by B. J. Tracey, Lexington, Ky.; sire Woodford Abdallah by Woodford Mambrino, dam Carrie Norman by Alexander Norman, sire of Zulu 215 and May Queen 220.
- 305 Waldo J. Stokes, West Roxbury, Mass. Northcote, 3426; sire Mambrino, dam Nicknack.
- 306 C. F. Clark, Boston, Mass. Young Roland, black, 5 years, by Roland, dam Hattie Jefferson (Standard).

STALLION THREE YEARS OLD.

Premium 109—\$25, \$15.

- 307 H. S. Russell, Milton, Mass. Crescent, sire Sultan, dam Lady Dey, by California Dexter.
- 308 H. W. Keyes, Newbury, Vt. P. G. F., by Eastern Boy, 9304, dam Billy Root Morgan.
- 309 E. D. Wiggins, Boston, Mass. Arrival, 5123, 15.2, by Charlie Wilkes, dam Aspasia by Alcantara, 2d dam Miss Buchanan by Clark Chief 89.
- 310 H. G. Wood, Natick, Mass. Electryon, bay 15.3, 3 years, sire Electioneer, dam Lina K. by Don Victor by Belmont, 2d dam Mohawk Chief by Hambletonian.
- 311 H. G. Wood, Natick, Mass. Pure Wilkes, bay, 15.2, 3 years; sire Red Wilkes, dam Purity by Brignoli, 2d dam by Daniel Lambert.

STALLION TWO YEARS OLD.

Premium 110—\$20, \$10.

- 312 H. S. Russell, Milton, Mass. Orton, sire Alcantara, dam Ilka, by Smuggler.

- 313 E. D. Wiggins, Boston, Mass. Emperor Wilkes, 15, by Charlie Wilkes, dam Ella Jackson full sister to Aristos, 2d dam Fanny Jackson.
- 314 E. D. Wiggins, Boston, Mass. Albrazia, 15.2, by Absolute, 4619, dam Ida Bessie Wilkes, by Red Wilkes, 2d dam Carrie T, by Almont.
- 315 C. F. Clark, Boston, Mass. Guy Kohl, 10724, bay, 2 years, by Guy Wilkes, dam Mamie Kohl.
- 316 C. F. Clark, Boston, Mass. Young Falmouth, bay, 2 years, by Roland, dam Hattie Jefferson (Standard).
- 317 B. H. Warren, Boston. Standard bred bay, 14.3½, sire Monte Carlo by Monaco, dam Polka by Richard the Third.

STALLION ONE YEAR OLD.

Premium 111—\$10, \$5.

- 318 E. D. Wiggins, Boston, Mass. Ellard, 14.3, by Charlie Wilkes.
- 319 Harry H. Hale, Bradford, Mass. Waterman, 9293, by Warder, 5318, dam Lillie Wilkes by Mambrino Wilkes, 14½, chestnut.
- 320 J. H. Nay, Readville, Mass. Marshall Nay, bay, 14.2; bred by J. H. Nay, by Glendon by Nutwood (2.18⅓), dam Kenilworth by Richmon by Mambrino Pilot, sire of Hannis (2.19¼), Mambrino Gift, 2.20.
- 321 C. F. Clark, Boston, Mass. Clark Chief, bay, 2 years, by Haldane, dam Comfort.
- 322 H. S. Russell, Milton, Mass. Porcellian, sired by Alcantara, dam Ilka, by Smuggler.

MARE FOUR YEARS OLD OR OVER.

Premium 112—\$20, \$10.

- 323 E. D. Wiggins, Boston, Mass. Noblesse, 15.2, by Alcryone, dam Fair Lady by Dictator, 2d dam by Almont.
- 324 C. F. Clark, Boston, Mass. Comfort, bay, 6 years, by Roland, dam by Rhode Island.

THE SECOND ANNUAL
❖ EXHIBITION ❖
OF THE
Boston Horse Show Association,
WILL TAKE PLACE AT
MECHANICS BUILDING, BOSTON,
April 21, 22, 23, 24, 25, 26,
❖ 1890. ❖

OFFICE OF THE ASSOCIATION,
No. 74 TREMONT STREET, BOSTON.

- 325 C. F. Clark, Boston, Mass. Kitty Roland, black, 5 years, by Roland, dam Miss Carter.

FILLY THREE YEARS OLD.

Premium 113—\$20, \$10.

- 326 C. A. Campbell, Chelsea. Bay, 15.2½, Kismette by Kismet by Sultan by the Moor.
- 327 C. A. Campbell, Chelsea. Black, 15.1, Lunet by Lumps by Geo. Wilkes, dam Star by North Star.
- 328 H. W. Keyes, Newbury, Vt. Egdale, by Egbert, dam Sue by Thorndale (2.22¼).
- 329 Geo. A. Fletcher, Milton, Mass. Bay by Magic by American Clay out of Starr Queen by Whipple.
- 330 C. F. Clark, Boston, Mass. Hattie C., black, 15.2, 3 years, by Roland, dam Hattie Jefferson (Standard).

FILLY TWO YEARS OLD.

Premium 114—\$15, \$8.

- 331 H. W. Keyes, Newbury, Vt. Ticia, by Tennessee Dictator, dam Voltaire.
- 332 Harry H. Hale, Bradford, Mass. Thornless, bay, 15, sire Buckthorn, 2197, dam by Redpath.
- 333 C. F. Clark, Boston, Mass. Mary F., grey, 2 years, by Roland, dam Beauty.
- 334 C. F. Clark, Boston, Mass. Genevieve, brown, 2 years, by Roland, dam Salem mare.
- 335 Geo. H. Warren. Lightning, foaled June 15, 1887, by Alcantara, son of Geo. Wilkes, dam Protia.
- 335A C. A. Campbell, Chelsea. Bay, 15, Lady Cohannet by Cohannet, dam Lady Almont.

AN EIGHT PER CENT. INCOME.

8% REAL ESTATE BONDS. 8%

Interest payable semi-annually. GUARANTEED.

These Bonds participate in profits of sale of the property securing the bonds and will undoubtedly net investors 100% in addition to principal and interest.

8 PER CENT. FIRST MORTGAGES 8 PER CENT.

Principal and Interest Guaranteed.

6 PER CENT. Improved Real Estate Bonds. 6 PER CENT.

Secured by a large office and banking building at Kansas City, Mo.

STOCK BONUS WITH BONDS.

SEND FOR PAMPHLETS AND MONTHLY CIRCULARS.

THE WINNER INVESTMENT CO.

CAPITAL, FULL PAID, \$500,000.

WILLIAM H. PARMENTER, General Agent,

50 STATE STREET, BOSTON.

FILLY ONE YEAR OLD.

Premium 115—\$8, \$5.

- 336 H. W. Keyes, Newbury, Vt. Romona, by Eastern Boy, 9304, dam Tabor's Morgan.
- 337 E. D. Wiggins, Boston, Mass. Carlotta Wilkes, 14.2, full sister to Arrival, 5123.
- 338 Harry H. Hale, Bradford, Mass. Wataka, by Warder, 5318, dam Kantaka, chestnut, 14½.
- 339 Geo. H. Warren. Protum; foaled May 2, 1888, by Glendon by Nutwood, dam Protia. Foal at foot April 7, 1889, by Charles Wilkes, dam Protia.
- 340 C. F. Clark, Boston, Mass. Corisande, brown, 1 year, by Young Roland, dam Salem Mare.
- 341 C. F. Clark, Boston, Mass. Choice Stamboul, bay, 1 year, by Stamboul, dam Choice by Dictator.

MARE WITH FOAL AT FOOT.

Premium 116—\$30, \$15.

- 342 H. S. Russell, Milton, Mass. Peoria Girl, sire Indianapolis, foal by Simmons, born April 17.
- 343 H. S. Russell, Milton, Mass. Soncy Lass, sire Sultan, foal by Bell Boy, born June 17.
- 344 H. S. Russell, Milton, Mass. Kate, sire Stocking Chief, foal by Sultan, born April 29.
- 345 H. S. Russell, Milton, Mass. Addie H., sire Ashland Chief, foal by Simmons, born May 7.
- 346 H. S. Russell, Milton, Mass. Gurgle, sire Pocahontas Boy, foal by Simmons, born April 6.
- 347 H. S. Russell, Milton, Mass. Emily R., sire Peacemaker, foal by Simmons, born April 29.
- 348 Jas. M. Smith, Boston. Helen, bay, 15.2, sire Dreadnaught, dam Hecla; sire of foal Nelson (2.14¼); foaled May 22, 1889.

A. KOHLER & CO.

Manufacturers of the

KOHLER DOUBLE RADIATING HOT AIR SURFACE

FURNACE.

(Patented by Ambrose Kohler.)

85

UNION

STREET,

BOSTON.

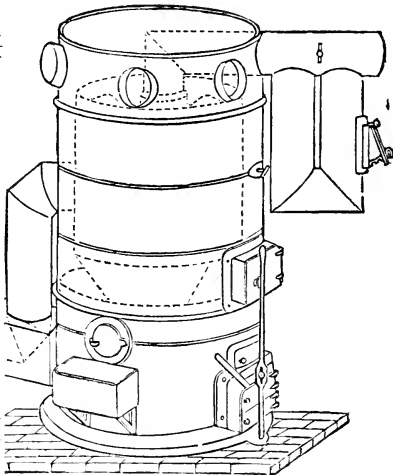

FACTORY,

143 to 153

VERNON

STREET,

ROXBURY.

The only Furnace with Two Currents of Hot Air, by which Hot Air can be sent to all parts of the House alike. To be found only at

85 UNION STREET, BOSTON, MASS.

- 349 H. W. Keyes, Newbury, Vt. Gladys, by Solicitor, 1025, dam Son of Pilot, Jr.
- 350 E. D. Wiggins, Boston, Mass. Martha Wilkes, 15.3, by Alcryone, dam by Clark Chief.
- 351 Harry H. Hale, Bradford, Mass. Ada Wilkes, by Hambletonian Wilkes, 1679, brown; dam by the dam of Mambrino Sparkle; 15¾, 6 years.
- 352 C. F. Clark, Boston, Mass. King's Beauty, brown, 15½, 11 years, by Mambrino's King, dam Gencoe, with foal at foot, by Alandorf No. 1.
- 353 Geo. H. Warren. Portia (2.29¼), 14.3; bred by Robt. Bonner, N. Y.; foaled Sept. 27, 1875, sire Startle, son of Rysdyke's Hambletonian, Startle, sire Majolica (2.15), dam Lady Pettee by Peter, son of Monte Chief.

NO. 17.—GENERAL PURPOSE HORSES.

STALLION 16 HANDS HIGH OR OVER, WITH AT LEAST THREE OF HIS PROGENY.

Premium 117—Gold Medal, or \$40, \$25.

- 354 Luther Crawford, New Braintree, Mass. Administrator, Jr., black, 16.3, 5 years, sire Administrator.

STALLION, 16 HANDS HIGH OR OVER, WITHOUT PROGENY.

Premium 118—\$30, \$20.

- 355 Harry H. Hale, Bradford, Mass. Hudson, 2831, by Kentucky Prince, dam by Rysdyke's Hambletonian; bay, 16, 7 years.

STALLION FOUR YEARS OLD OR OVER, UNDER 16 HANDS HIGH, WITHOUT PROGENY.

Premium 120—\$30, \$20.

- 356 Luther Crawford, New Braintree, Mass. Robert L., dark bay, 15.3, 7 years, sire Morrill Bay.

LEADING AGRICULTURAL PAPER IN NEW ENGLAND,

Massachusetts Ploughman

AND

New England Journal of Agriculture.

Enlarged to an eight-page paper, and one of the largest of the kind in New England. Devoted to Agriculture, Horticulture, Sheep Husbandry, Stock Raising, Domestic Economy, Choice Literature, General News, Wool Markets, Produce Markets, Cattle Markets, etc.

CONTRIBUTED TO BY THE BEST WRITERS.

The PLOUGHMAN publishes Phonographic Reports of Weekly Meetings of Farmers in its own hall, and

HAS PHONOGRAPHIC REPORTERS

at all the great public meetings where subjects are being discussed of importance to the agricultural community, in whatever section of New England they may be held.

Sample copies sent everywhere on application.

Terms, Two Dollars a Year in Advance.

LINUS DARLING, Proprietor,

45 MILK STREET, COR. DEVONSHIRE, BOSTON, MASS.

- 357 J. H. Nay, Readville, Mass. Norman Abdallah, 4772, black, 15. 3½; bred by B. J. Tracev, Lexington, Ky.; sire Woodford Abdallah by Woodford Mambrino, dam Carrie Norman by Alexander Norman, sire Zulu 215, and May Queen, 220.

STALLION THREE YEARS OLD.

Premium 121—\$25, \$15.

- 358 Luther Crawford, New Braintree, Mass. L. C., dark chestnut, 15.3, 3 years, sire Volmont.
- 359 B. H. Warren, Boston. Standard bred bay, 14.3½, sire Monte Carlo by Monaca, dam Polka by Richard III.

MARE OVER FOUR YEARS OLD.

Premium 124—\$20, \$10.

- 360 Luther Crawford, New Braintree, Mass. Sarah, bay, 16, 4 years; sire Administrator.
- 361 Harry H. Hale, Bradford, Mass. St. Laura, bay, 16, 6 years.

FILLY THREE YEARS OLD.

Premium 125—\$20, \$10.

- 362 Geo. A. Fletcher, Milton, Mass. Brown, by Steele, he by Startle out of Hetty Sunbury by Young Eaton.

FILLY TWO YEARS OLD.

Premium 126—\$15, \$8.

- 363 Luther Crawford, New Braintree, Mass. Jennie B., chestnut, 15.3, 2 years; sire Abdalpatchen.
- 364 A. B. Haskell, Gilbertville, Mass. Daisy D., black, 15.
- 365 Daniel G. Tenney, Bradford, Mass. Spright, sire Redpath, son of Gen. Sherman, 862; dam Lue by Vampire by Taggoldt's Abdallah 16; bred by Daniel Tenney.

“ECLIPSE” WIND MILLS.

Manufactured in Nineteen Sizes, from Six Feet Diameter of Wheel to Sixty Feet.

The Eclipse has been the standard wind mill of the country for twenty years.

We manufacture our own goods, and know what we are selling.

Our Power Mills guaranteed to develop more than any other wheel of equal size.

Our Factory is the largest of its kind in the world, and the quality of the goods turned out the best.

The Eclipse has a record in New England of fifteen years' standing, and for **light running, simplicity of parts, direct acting, and long life**, is unsurpassed.

Also Agent for the Ohio Dry Feed and Ensilage Cutters.

The Keystone Double Acting, Non-Freezing, Hand Force Pumps.

Our Treatise on Ensilage, compiled from various sources, mailed free on application,

L. H. WHEELER,
174 High Street - Boston, Mass.

L. BARTA & CO.,

PRINTERS,

54 PEARL STREET - BOSTON.

Our office is well equipped to do

ALL CLASSES OF PRINTING.

**PEDIGREES, CIRCULARS, PAMPHLETS, CARDS, BOOKS,
NEWSPAPERS, ILLUSTRATED CATALOGUES,
PRICE LISTS, ETC.**

YOUR FAVORS ARE SOLICITED.

**IT WILL PAY EVERY ADVERTISER WHO READS THIS TO SEND
TWO DOLLARS TO A. M. THAYER & CO., 79 MILK ST.,
BOSTON, FOR A COPY OF**

“ABOUT ADVERTISING AND PRINTING.”

NO. 18.—SHETLAND PONIES.

STALLION AND MARES.

Premiums 129, 130—\$10, \$8, \$5.

366-377 M. Coleman, Boston, 12 ponies.

378 Elizabeth F. Bowditch and John Perry Bowditch, Framingham.
Joanna (imported), 6 years; Armajo (imported), 5 years, with foal Bettyjo, 3 months (educated).

379 J. A. Hathaway, Brighton. Two brood mares (one with foal);
Primrose and Daisy, 10 and 8 years; also stallion Dick, 8 years.

380 H. L. Murphy, Brighton. Mare, Queen Victoria (with foal at side),
4 years old, bred in Wales.

NO. 19.—HARNESS AND SADDLE HORSES.

COUPE HORSE NOT LESS THAN 16 HANDS OR 1150 POUNDS.

Premium 133—\$25, \$15.

381 Geo. A. Fletcher, Milton, Mass. Bay gelding, 16, 8 years.

382 Luther Crawford, New Braintree, Mass. Star King, bay, 16, 6
years, sire Morrill Boy.

ROADSTER PAIR.

Premium 134—\$40, \$25.

383 Albert L. Murdock, Boston, Mass. One pair iron gray half-bred
Percherons; sire thorough-bred stallion Saturne, 3687, (625) 16,
3 years 2 months.

384 H. S. Russell, Milton, Mass. Ruby Robinson, 6 years, and
Gertrude A., 5 years.

NO. 20.—MULES.

Premium 139—\$25, \$15.

385 C. F. Clark, Boston, Mass. Black, 16½; Belle and Lizzie.

386 C. F. Clark, Boston, Mass. Brown, 16; Una and mate.

THE AMERICAN CULTIVATOR.

ESTABLISHED 1837.

THE MOST POPULAR
AGRICULTURAL JOURNAL
IN AMERICA.

Has the Largest Circulation.
Circulates in every State in the Union.
Authority in the Farm and Garden.
Most Complete Market Reports.
Special Horse Department.

Its Columns Liberally Patronized by all the
LEADING ADVERTISERS.

Specimen Copies Free to all Applicants.

AMERICAN CULTIVATOR CO.,
No. 220 Washington St., Boston, Mass.

**The Following Numbers entered by Chas. H. Thayer for
Exhibition Only.**

- 387 Performing horse. Governor. Kentucky. Dapple gray gelding,
7 years. Entered by Chas. H. Thayer.
- 388 Performing horse. Tapsey. Morgan. Brown mare, 3 years.
Entered by Chas. H. Thayer.
- 389 Leaping pony. Burt. Bay gelding, 8 years. Entered by Chas.
H. Thayer.
- 390 Performing Spanish mule. Jerry. Mouse gelding, 5 years.
Entered by Chas. H. Thayer.
- 391 Performing horse. Denver. Texan. Sorrel gelding, 8 years.
Entered by Chas. H. Thayer.
- 392 Performing horse. Sultan. Texan. Bay gelding, 6 years.
Entered by Chas. H. Thayer.
- 393 Performing horse. Diamond. Texan. Bay gelding, 5 years.
Entered by Chas. H. Thayer.
- 394 Performing horse. Ingomar. Texan. Sorrel gelding, 5 years.
Entered by Chas. H. Thayer.
- 395 Performing horse. Bravo. Texan. Dun gelding, 5 years.
Entered by Chas. H. Thayer.
- 396 Performing horse. Bonita. Texan. Sorrel gelding, 5 years.
Entered by Chas. H. Thayer.
- 397 Performing horse. Albert. Texan. Gray gelding, 4 years.
Entered by Chas. H. Thayer.
- 398 Performing horse. Cupid. Texan. Gray gelding, 4 years.
Entered by Chas. H. Thayer.
- 399 Performing horse. Barney. Texan. Bay gelding, 4 years.
Entered by Chas. H. Thayer.
- 400 Performing horse. Jim. Texan. Gray gelding, 4 years.
Entered by Chas. H. Thayer.
- 401 Performing horse. Duke. Texan. Bay gelding, 4 years.
Entered by Chas. H. Thayer.
- 402 Performing horse. Spot. Texan. Spotted gelding, 5 years.
Entered by Chas. H. Thayer.

HORSE AND STABLE.

A WEEKLY JOURNAL

Devoted to the Interests of New England Horse Owners.

It has for special features, articles on the theory of Breeding; a department on the Rearing and Training of Colts; scientific articles on "How to Shoe Properly," and a series of "Experiences of New England's most famous Drivers." Horse and Stable gives all the news from the horse world weekly.

Subscription Price, \$2 a Year in Advance.

SEND FOR SAMPLE COPY TO

HORSE AND STABLE,

P. O. Box 197, Boston.

- 403 Jumping pony. Phido. Dun gelding, aged. Entered by Chas. H. Thayer.
- 404 Jumping pony. Kni O'Kitch. Dun gelding. Entered by Chas. H. Thayer.

CLASS III. SHEEP AND SWINE.

NO. 21.—LONG WOOLED SHEEP.

RAM TWO YEARS OLD OR OVER WITH THREE OF HIS GET.

Premium 140—\$20, \$15.

- 405 G. W. Flagg, Braintree, Vt., 2 years old.
- 406 R. G. Hill, So. Elmore, Vt.
- 407 A. C. & F. Phillip, Glover, Vt., 3 years old, bred by R. G. Hill.

RAM ONE YEAR OLD.

Premium 141—\$15, \$10.

- 408 G. W. Flagg, Braintree, Vt.
- 409 G. W. Goddard, Greenville, N. H.; bred by exhibitor.
- 410 R. G. Hill, So. Elmore, Vt.
- 411 A. C. & F. Phillip, Glover, Vt.; bred by exhibitor.

RAM LAMB.

Premium 142—\$10, \$5.

- 412 G. W. Flagg, Braintree, Vt.
- 413 R. G. Hill, So. Elmore, Vt.
- 414 A. C. & F. Phillip, Glover, Vt.; bred by exhibitor.

PEN OF THREE EWES TWO YEARS OLD OR OVER.

Premium 143—\$20, \$15.

- 415 G. W. Flagg, Braintree, Vt.

Bay State Agricultural Society's Fair.

The following days and hours will be devoted to judging :

- MONDAY, OCT. 7. Class 4, *POULTRY.*
- TUESDAY, OCT. 8. Morning, commencing at 9 o'clock.
 Class 1, No. 4. *HOLSTEINS.*
 No. 11. *FAT CATTLE.*
 No. 12. *WORKING OXEN.*
 Class 3, *SHEEP and SWINE.*
 Class 6, *GRAIN and VEGETABLES*
 Class 7, *DAIRY.*
 Class 8, *FLOWERS and FRUITS.*
 Class 9, *DOMESTIC.*
 Afternoon, commencing at 2 o'clock.
 Class 2, No. 13. *PERCHERONS.*
 No. 15. *COACH HORSES.*
 No. 17. *GEN'L PURPOSE HORSES*
 No. 20. *MULES.*
 Class 1, No. 6. *SHORTHORNS.*
- WEDNESDAY, OCT. 9. Morning, commencing at 9 o'clock.
 Class 1, No. 2. *JERSEYS.*
 No. 5. *SWISS.*
 No. 8. *HEREFORDS.*
 No. 9. *POLLED.*
 Afternoon, commencing at 2 o'clock.
 Class 2, No. 16. *TROTTING HORSES.*
 No. 19. *HARNESS and SADDLE.*
 No. 14. *THOROUGHBREDS.*
- THURSDAY, OCT. 10. Morning, commencing at 9 o'clock.
 Class 1, No. 1. *AYRSHIRES.*
 No. 7. *DEVONS.*
 No. 3. *GUERNSEYS.*

- 416 R. G. Hill, So. Elmore, Vt.
417 A. C. & F. Phillip, Glover, Vt.; bred by exhibitor.

PEN OF THREE YEARLING EWES.

Premium 144—\$15, \$10.

- 418 G. W. Flagg, Braintree, Vt.
419 R. G. Hill, So. Elmore, Vt.
420 A. C. & F. Phillip, Glover, Vt.; bred by exhibitor.

PEN OF THREE EWE LAMBS.

Premium 145—\$10, \$15.

- 421 G. W. Flagg, Braintree, Vt.
422 R. G. Hill, So. Elmore, Vt.
423 A. C. & F. Phillip, Glover, Vt.

SPECIAL PRIZES offered by the Massachusetts Society for Promoting
Agriculture.

FLOCK, ONE RAM, FIVE EWES THAT HAVE HAD LAMBS IN 1889,
AND FIVE EWE LAMBS.

Premium 145A—\$10, \$30.

- 424 G. W. Flagg, Braintree, Vt.
425 R. G. Hill, So. Elmore, Vt.
426 A. C. & F. Phillips, Glover, Vt.

NO. 22.—MIDDLE WOOLED SHEEP.

A. SOUTHDOWNS.

RAM TWO YEARS OLD OR OVER WITH THREE OF HIS GET.

Premium 146—\$20, \$15.

- 427 Geo. K. Boutelle, Waterville, Me.; 2 years old; bred by exhibitor.

PRUSSIAN ARMY HARNES OIL BLACKING

IS UNIVERSALLY ACKNOWLEDGED SUPERIOR TO ALL OTHERS.



BLACKS, PRESERVES, SOFTENS

Harness, Carriage Tops, and all Black Leather Goods.

EASILY APPLIED, PERFECT RESULTS.

It is **Waterproof**, contains **no injurious chemicals**, and will make an old harness as soft and pliable as new.

WILL NOT SMUT, GUM, OR CRACK.

In all sizes of package from pints to barrels.

P. A. P. P.
PRUSSIAN ARMY PASTE POLISH.

A new Polish, **Free from Dust**, that contains **no acid**, and will not scratch the most carefully burnished surface of **GOLD, SILVER, NICKLE, BRASS, TIN, or GLASS.**

Endorsed as **THE BEST** by everybody who tries it.

PRUSSIAN ARMY HARNES SOAP

Is an Excellent Black Soap that should be used in every Stable.

BARS, PAILS, AND TUBS.

If your dealer cannot supply you, send for prices to

PRUSSIAN ARMY OIL MANUFACTURING COMPANY,

33 INDIA WHARF * BOSTON, MASS.

- 428 C. A. Hawkes, Charlemont, Mass. Rigdon (2), 2954; bred by Geo Jonas; 3 years old.
429 N. R. Boutelle, Waterville, Maine; 5 years old; bred by J. H. Warren.

RAM ONE YEAR OLD.

Premium 147—\$15, \$10.

- 430 Geo. K. Boutelle, Waterville, Me.; bred by exhibitor.
431 C. A. Hawkes, Charlemont, Mass.; — sired by 1275, from 3070.
432 C. A. Hawkes, Charlemont, Mass.; — sired by 2954, from 2951.
433 N. R. Boutelle, Waterville, Me.; bred by exhibitor.

RAM LAMB.

Premium 148—\$10, \$5.

- 434 Geo. K. Boutelle, Waterville, Me.; bred by exhibitor.
435 C. A. Hawkes, Charlemont, Mass.
436 N. R. Boutelle, Waterville, Me.; bred by exhibitor.

PEN OF THREE EWES TWO YEARS OLD.

Premium 149—\$20, \$15.

- 437 Geo. K. Boutelle, Waterville, Me.; bred by exhibitor.
438 C. A. Hawkes, Charlemont, Mass.
439 C. A. Hawkes, Charlemont, Mass.
440 N. R. Boutelle, Waterville, Me.; bred by exhibitor.

PEN OF THREE YEARLING EWES.

Premium 150—\$15, \$10.

- 441 Geo. K. Boutelle, Waterville, Me.; bred by exhibitor.
442 C. A. Hawkes, Charlemont, Mass.
443 N. R. Boutelle, Waterville, Me.; bred by exhibitor.

Adriance, Platt & Co., Poughkeepsie, N. Y.,

Manufacturers of

ADRIANCE **MOWERS,**
BUCKEYE **REAPERS,**
BINDERS.

Thomas Manufacturing Co., Springfield, Ohio,

Manufacturers of

ROYAL SULKY HAY RAKES,
THOMAS **HAY TEDDERS, LAWN MOWERS,**
FORCE PUMPS, LIFT PUMPS.

Moseley & Stoddard Mfg. Co., Rutland, Vt.,

CREAMERIES and CHURNS.

A. W. Gray's Sons, Middleton Springs, Vt.,

HORSE POWERS AND SAWING MACHINES.

THE DANIELS
THE FREEMAN

ENSILAGE CUTTERS.

G. & G. **STEEL PLOWS,**
HARD METAL PLOWS.

We are exclusive Boston Agents on the above goods, all of which we are now exhibiting at this fair. In our warerooms, we have at all times, a complete stock of everything wanted for **FARM, GARDEN AND LAWN.**

GILBRIDE & GREY, 49 So. Market St., Boston, Mass.

PEN OF THREE EWE LAMBS.

Premium 151—\$10, \$5.

- 444 Geo. K. Boutelle, Waterville, Me.; bred by exhibitor.
- 445 C. A. Hawkes, Charlemont, Mass.
- 446 C. A. Hawkes, Charlemont, Mass.
- 447 N. R. Boutelle, Waterville, Me.; bred by exhibitor.
- 448 N. R. Boutelle, Waterville, Me.; bred by exhibitor. (Lambs.)

SPECIAL PRIZES offered by the Massachusetts Society for Promoting Agriculture.

ONE RAM, FIVE EWES THAT HAVE HAD LAMBS IN 1889, AND FIVE EWE LAMBS.

Premium 151B—\$40, \$0.

- 449 Geo. K. Boutelle, Waterville, Me.; bred by exhibitor.

B. SHROPSHIRE.

RAM TWO YEARS OLD OR OVER WITH THREE OF HIS GET.

Premium 152—\$20, \$15.

- 450 L. B. Harris, Lyndon Centre, Vt.; 2 years old, bred by A. Mansell.

RAM LAMB.

Premium 154—\$10, \$5.

- 451 L. B. Harris, Lyndon Centre, Vt.; bred by exhibitor.

PEN OF THREE EWES TWO YEARS OLD OR OVER.

Premium 155—\$20, \$15.

- 452 L. B. Harris, Lyndon Centre, Vt.; bred by A. Mansell.

PEN OF THREE YEARLING EWES.

Premium 156—\$15, \$10.

- 453 L. B. Harris, Lyndon Centre, Vt.; bred by A. Mansell.

"THE GREAT MILK-PRODUCING FOOD OF THE AGE."

Chas. Pope Glucose Co.'s **GLUTEN MEAL.**

It contains all the Fat, or Gluten, of the Corn.

It is absolutely free from all injurious substances. No Alkali, Acid, nor other hurtful chemicals are used in its manufacture.

It is the most highly concentrated food in the world.

It contains all the Flesh and Muscle-producing properties of the corn.

It is a perfectly healthy and safe food.

It is the most profitable food for milch cows in the world.

It is perfectly kiln-dried, and is guaranteed to keep in any climate.

Corn Meal has a feeding value \$1.15 per 100 pounds.
Cotton-Seed Meal feeding value 1.56 per 100 pounds.
Linseed Meal feeding value 1.59 per 100 pounds.
Chas. Pope Glucose Co.'s Gluten Meal feeding value, \$2.42 per 100 pounds.

I return as directed the desired analysis of the sample of feed stuff — the Chas. Pope's Gluten Meal — sent us for that purpose. The material is different from any kind of Gluten meal thus far tested by me. The value of the article, based on the known digestibility of the Gluten meal would be \$2.42 per hundred weight, or \$48.40 per ton. The fat is counted on an equal basis as the nitrogenous matter (Protein), 4.33 cents per pound; its large percentage causes the valuation:—

	Per Cent.	Amounts Digestible Per Cent.
Crude Ash	1.82
Crude Cellulose	1.61	1.55
Crude Fat	17.36	13.19
Crude Protein	14.10	34.94
Non-Nitrogenous Extract	38.11	35.82
Fertilizing value per ton (2,000 lbs.), \$21.23.	100.00	85.50

C. A. GOESSMANN.

Order a Sample Bag of your Grain Dealer and TRY IT. Sold only in one-hundred-pound sacks. See that our seal, with our initials (C. P. G. Co.) is on each bag.

SOLD BY GRAIN DEALERS EVERYWHERE.

W. E. DENNIS, Gen. Selling Agt., 1 Central Wharf, Boston.

PEN OF THREE EWE LAMBS.

Premium 157—\$10, \$5.

454 L. B. Harris, Lyndon Centre, Vt.; bred by exhibitor.

SPECIAL PRIZES offered by the Massachusetts Society for Promoting Agriculture.

FLOCK: ONE RAM, FIVE EWES THAT HAVE HAD LAMBS IN 1889, AND FIVE EWE LAMBS.

Premium 157C—\$40, \$30.

455 L. B. Harris, Lyndon Centre, Vt., bred by exhibitor and Mansell.

C. HAMPSHIRE.

RAM TWO YEARS OLD OR OVER WITH THREE OF HIS GET.

Premium 158—\$20, \$15.

456 E. F. Bowditch, Framingham, Mass. McGregor, 5 years; bred by Phillips & McGregor.

RAM ONE YEAR OLD.

Premium 159—\$15, \$10.

457 E. F. Bowditch, Framingham, Mass. Yearling by McGregor, bred by exhibitor.

RAM LAMB.

Premium 160—\$10, \$5.

458 Woodward & Jaques, Wright's Corner, N. Y.

459 E. F. Bowditch, Framingham, Mass.; bred by E. F. Bowditch.

PEN OF THREE EWES TWO YEARS OLD OR OVER.

Premium 161 — \$20, \$15.

460 Woodward and Jaques, Wright's Corner, N. Y.

461 E. F. Bowditch, Framingham, Mass.; bred by E. F. Bowditch.

NO STEAM!

NO ODOR!

Hill's Champion Steam Cooker.



CHEAP.

DURABLE.

CONVENIENT.

SAVES TIME.

SAVES LABOR.

SAVES MONEY.

Warranted Seamless and Odorless or Money Refunded.

Cabbage, onions, ham, etc., no longer a terror to the household. Our Cooker has an iron base, a tube which carries the surplus steam and odor into the fire box, and a water joint cover. It can be used for boiling or steam cooking, or both at the same time. Very simple and convenient, costs about half the price of other cookers.

No Melting Nor Rusting of Bottoms. Good for a Lifetime.

Send for circular. Agents wanted everywhere.

LEAVITT & CO., 149 Pearl Street, Boston, Mass.

PEN OF THREE YEARLING EWES.

Premium 162—\$15, \$10.

- 462 Woodward & Jaques, Wright's Corner, N. Y.
 463 E. F. Bowditch, Framingham, Mass.; bred by E. F. Bowditch.

PEN OF THREE EWE LAMBS.

Premium 163—\$10, \$5.

- 464 Woodward & Jaques, Wright's Corner, N. Y.
 465 E. F. Bowditch, Framingham, Mass.; bred by E. F. Bowditch.

SPECIAL PRIZES offered by the Massachusetts Society for Promoting Agriculture.

FLOCK: ONE RAM, FIVE EWES THAT HAVE HAD LAMBS IN 1889,
 AND FIVE EWE LAMBS.

Premium 163 D—\$40, \$30.

- 466 E. F. Bowditch, Framingham, Mass. Flock: McGregor and ewes.

D. HORNED DORSETS.

RAM TWO YEARS OLD OR OVER WITH THREE LAMBS OF HIS GET.

Premium 164—\$20, \$15.

- 467 E. F. Bowditch, Framingham, Mass. Geo. Henry, 2 years; imported; bred by Thos. Chick.
 468 Woodward & Jaques, Wright's Corner, N. Y. 2 years old.

RAM ONE YEAR OLD.

Premium 165—\$15, \$10.

- 469 E. F. Bowditch, Framingham, Mass. Rob; bred by Wm. Rolph.
 470 Woodward & Jaques, Wright's Corner, N. Y.
 471 T. S. Cooper, Coopersburg, Pa.

RAM LAMB.

Premium 166 — \$10, \$5.

- 472 E. F. Bowditch, Framingham, Mass. Ram Lamb by Geo. Henry bred by exhibitor.
 473 Woodward & Jaques, Wright's Corner, N. Y.
 474 T. S. Cooper, Coopersburg, Pa.
 475 T. S. Cooper, Coopersburg, Pa.

PEN OF THREE EWES TWO YEARS OLD OR OVER.

Premium 167 — \$20, \$15.

- 476 E. F. Bowditch, Framingham, Mass. Imported; bred by Thos. Chick.
 477 Woodward & Jaques, Wright's Corner, N. Y.
 478 Woodward & Jaques, Wright's Corner, N. Y.
 479 T. S. Cooper, Coopersburg, Pa.
 480 T. S. Cooper, Coopersburg, Pa.

PEN OF THREE YEARLING EWES.

Premium 168 — \$15, \$10.

- 481 Woodward & Jaques, Wright's Corner, N. Y.
 482 T. S. Cooper, Coopersburg, Pa.
 483 T. S. Cooper, Coopersburg, Pa.

PEN OF THREE EWE LAMBS.

Premium 169 — \$10, \$5.

- 484 E. A. Bowditch, Framingham, Mass. Lambs by Geo. Henry; bred by exhibitor.
 485 Woodward & Jaques, Wright's Corner, N. Y.
 486 Woodward & Jaques, Wright's Corner, N. Y.
 487 T. S. Cooper, Coopersburg, Pa.
 488 T. S. Cooper, Coopersburg, Pa.

FLOCK: ONE RAM, FIVE EWES THAT HAVE HAD LAMBS IN 1889,
AND FIVE EWE LAMBS.

Premium 169 E — \$40, \$30.

- 489 E. F. Bowditch, Framingham, Mass. Flock: Geo. Henry and ewes.
490 Woodward and Jaques, Wright's Corner, N. Y.
491 T. S. Cooper, Coopersburg, Pa.

NO. 24.—FAT SHEEP.

PEN OF FOUR FAT WETHERS ONE YEAR OLD OR OVER.

Premium 182 — \$15, \$10.

- 492 L. B. Harris, Lyndon Centre, Vt.; bred by exhibitor.

PEN OF FOUR FAT EWES ONE YEAR OLD OR OVER.

Premium 183 — \$15, \$10.

- 493 N. R. Boutelle, Waterville, Maine; bred by exhibitor.
494 L. B. Harris, Lyndon Centre, Vt.; bred by exhibitor.

NO. 25.—SWINE.

LARGE YORKSHIRE.

BOAR OVER ONE YEAR WITH THREE OF HIS PROGENY.

Premium 184 — \$20, \$10.

- 495 Warren Heustis & Son, Belmont, Mass. Brilliant.
496 Warren Heustis & Son, Belmont, Mass. Stratagem.

SOW OVER ONE YEAR OLD.

Premium 186 — \$15, \$10.

- 497 Warren Heustis & Son, Belmont, Mass. Grand Duchess.

SOW UNDER ONE YEAR OLD.

Premium 187 — \$10, \$8.

- 498 Warren Heustis & Son, Belmont, Mass. Grand Duchess 2.
 499 Warren Heustis & Son, Belmont, Mass. Brilliant.
 500 Warren Heustis & Son, Belmont, Mass. Stratagem.
 501 Warren Heustis & Son, Belmont, Mass. Grand Duchess.

MEDIUM YORKSHIRES.

BOAR OVER ONE YEAR OLD WITH THREE OF HIS PROGENY.

Premium 188 — \$20, \$10.

- 502 W. E. Pendleton, New London, Conn. Shoat and three of his get.
 503 W. W. Rawson, Arlington, Mass. Surf, 630; bred by W. Heustis.
 504 Warren Heustis & Son, Belmont, Mass. Brunswick.

BOAR UNDER ONE YEAR OLD.

Premium 189 — \$10, \$8.

- 505 Warren Heustis & Son, Belmont, Mass. Duke of Teck.
 506 Warren Heustis & Son, Belmont, Mass. Advance.
 507 Warren Heustis & Son, Belmont, Mass. Magna Charta.

SOW OVER ONE YEAR OLD.

Premium 190 — \$15, \$10.

- 508 W. E. Pendleton, New London, Conn. Sow.
 509 W. W. Rawson, Arlington, Mass. Arlington Queen, 916; bred by J. Borland.
 510 Warren Heustis & Son, Belmont, Mass. Lady Spencer 2d.
 511 Warren Heustis & Son, Belmont, Mass. Lady Spencer.

SOW UNDER ONE YEAR OLD.

Premium 191—\$10, \$8.

- 512 W. E. Pendleton, New London, Conn. Boar, Piquot Chief, and
sow, Middlesex Queen.
- 513 Warren Heustis & Son, Belmont, Mass. Hermasoa, 10.
- 514 Warren Heustis & Son, Belmont, Mass. Hermasoa, 9.
- 515 Warren Heustis & Son, Belmont, Mass. Brunswick.
- 516 Warren Heustis & Son, Belmont, Mass. Magna Charta.
- 517 Warren Heustis & Son, Belmont, Mass. Lady Spencer.
- 518 Warren Heustis & Son, Belmont, Mass. Lady Spencer 2d.

SMALL YORKSHIRES.

BOAR OVER ONE YEAR OLD.

Premium 192—\$20, \$10.

- 519 W. E. Pendleton, New London, Conn. Shoat and three of his get.
- 520 Chas. L. Marshall, Lowell, Mass. Gov. 3d; bred by C. L.
Marshall.
- 521 Warren Heustis & Son, Belmont, Mass. Eclipse.
- 522 Warren Heustis & Son, Belmont, Mass. Tony.

BOAR UNDER ONE YEAR OLD.

Premium 193—\$10, \$8.

- 523 W. E. Pendleton, New London, Conn. Shoat.
- 524 Warren Heustis & Son, Belmont, Mass. Eclipse 2d.
- 525 Warren Heustis & Son, Belmont, Mass. Eclipse 3d.

SOW OVER ONE YEAR OLD.

Premium 194—\$15, \$10.

- 526 W. E. Pendleton, New London, Conn. Sow, Snow Drop.
- 527 W. E. Pendleton, New London, Conn. Sow, Pretty Girl.

- 528 W. E. Pendleton, New London, Conn. Sow, Duchess of Waterford.
 529 Chas. L. Marshall, Lowell, Mass. Belle of Middlesex; bred by C. L. Marshall.
 530 Warren Heustis & Son, Belmont, Mass. Belle of Oak Hill.
 531 Warren Heustis & Son, Belmont, Mass. Arturia.

SOW UNDER ONE YEAR OLD.

Premium 195—\$10, \$8.

- 532 W. E. Pendleton, New London, Conn. 3 sows; Joyful, Joyful Girl, and Joyful Maid.
 533 W. E. Pendleton, New London, Conn. Boar, Groton; sows, Snowdrop, Pretty Girl, and Duchess of Waterford.
 534 Chas. L. Marshall, Lowell, Mass. Belle of Middlesex 2d; bred by C. L. Marshall.
 535 Warren Heustis & Son, Belmont, Mass. Puritan 2d.
 536 Warren Heustis & Son, Belmont, Mass. Puritan 3d.
 537 Warren Heustis & Son, Belmont, Mass. Eclipse.
 538 Warren Heustis & Son, Belmont, Mass. Tony.
 539 Warren Heustis & Son, Belmont, Mass. Belle of Oak Hill.
 540 Warren Heustis & Son, Belmont, Mass. Arturia.

CHESTER WHITES.

BOAR OVER ONE YEAR OLD.

Premium 196—\$20, \$10.

- 541 C. A. Hawkes, Charlemont, Mass. Ben Franklin, 3897.
 542 C. A. Hawkes, Charlemont, Mass. Buffalo Bill, sire by 3849.
 543 C. A. Hawkes, Charlemont, Mass. Young Clifton, 3849, N.C.W.R.

BOAR UNDER ONE YEAR OLD.

Premium 197—\$10, \$8.

- 544 C. A. Hawkes, Charlemont, Mass.
 545 C. A. Hawkes, Charlemont, Mass. Ivanhoe, by 3849 from 3148.

SOW OVER ONE YEAR OLD.

Premium 198—\$15, \$10.

- 546 C. A. Hawkes, Charlemont, Mass. Lady Franklin, 5892.
 547 C. A. Hawkes, Charlemont, Mass. Lucille, by 3849 from 6260.

SOW UNDER ONE YEAR OLD.

Premium 199—\$10, \$8.

- 548 C. A. Hawkes, Charlemont, Mass. 3847 from Lady Byron 3d.
 549 C. A. Hawkes, Charlemont, Mass. by 3849 from 3184.
 550 J. M. Sears, Southboro, Mass. Bred by exhibitor.
 551 J. M. Sears, Southboro, Mass. Bred by exhibitor.
 552 J. M. Sears, Southboro, Mass. Bred by exhibitor.
 553 J. M. Sears, Southboro, Mass. Bred by exhibitor.
 554 J. M. Sears, Southboro, Mass. Bred by exhibitor.
 555 J. M. Sears, Southboro, Mass. Bred by exhibitor.
 556 J. M. Sears, Southboro, Mass. Bred by exhibitor.
 557 J. M. Sears, Southboro, Mass. Bred by exhibitor.

BERKSHIRE.

BOAR OVER ONE YEAR OLD.

Premium 200—\$20, \$10.

- 558 Lucas & Vosbergh, Waterloo, N. Y. Berkshire Boar.
 559 G. W. Goddard, Greenville, N. H. Breeder G. W. Goddard.

BOAR UNDER ONE YEAR OLD.

Premium 201—\$10, \$8.

- 561 G. W. Goddard, Greenville, N. H. Bred by exhibitor.

SOW OVER ONE YEAR OLD.

Premium 202—\$15, \$10.

- 562 Lucas & Vosbergh, Waterloo, N. Y. Berkshire Sow.
 563 G. W. Goddard, Greenville, N. H. Bred by exhibitor.

SOW UNDER ONE YEAR OLD.

Premium 203—\$10, \$8.

- 564 Lucas & Vosbergh, Waterloo, N. Y. Sow.
 565 Lucas & Vosbergh, Waterloo, N. Y. Sow.

POLAND, CHINA.

BOAR OVER ONE YEAR OLD.

Premium 204—\$20, \$10.

- 566 R. F. Seeley, Waterloo, N. Y. Bred by John Doyle.
 567 Smith Harding, South Deerfield, Mass. Boar, "Kay's Choice"
 2 yrs.

BOAR UNDER ONE YEAR OLD.

Premium 205—\$10, \$8.

- 568 R. F. Seeley, Waterloo, N. Y.; bred by John Doyle.
 569 Smith Harding, So. Deerfield, Mass. Boar, 7 mos.
 570 Smith Harding, So. Deerfield, Mass. Boar, 6 mos.

SOW OVER ONE YEAR OLD.

Premium 206—\$15, \$10.

- 571 R. F. Seeley, Waterloo, N. Y.; bred by Jeff Stear.
 572 Smith Harding, So. Deerfield, Mass. Sow, 1 year and 3 mos.
 573 Smith Harding, So. Deerfield, Mass. Sow, Cheerful, 2 years, with
 litter of six pigs.

SOW UNDER ONE YEAR OLD.

Premium 207—\$10, \$8.

- 574 Smith Harding, So. Deerfield, Mass. Sow, 7 mos.
 575 Smith Harding, So. Deerfield, Mass. Sow, 4 mos.
 576 R. F. Seeley, Waterloo, N. Y.; bred by R. F. Seeley.
 577 R. F. Seeley, Waterloo, N. Y.; bred by John Doyle.

SPECIAL PRIZES offered by the Massachusetts Society for Promoting Agriculture.

BOAR OF ANY AGE.

Premium 203I—\$40, \$30.

- 578 Lucas & Vosbergh, Waterloo, N. Y.
579 G. W. Goddard, Greenville, N. H.

SOW OF ANY AGE.

Premium 203K—\$40, \$30.

- 580 Lucas & Vosbergh, Waterloo, N. Y.
581 G. W. Goddard, Greenville, N. H.

BOAR OF ANY AGE.

Premium 207L—\$40, \$30.

- 582 R. F. Seeley, Waterloo, N. Y.

SOW OF ANY AGE.

Premium 207M—\$40, \$30.

- 583 R. F. Seeley, Waterloo, N. Y.
584 R. F. Seeley, Waterloo, N. Y.

TAMWORTH SOWS, 8 TO 10 MONTHS OLD.

FOR EXHIBITION ONLY.

- 585 J. M. Sears, Southboro, Mass. Bred in England; imported in July, 1889.

CLASS IV.—POULTRY, ETC.

Cat'l. Prem.
No. No.

- William B. Coffin, Fair Haven, Mass.
586 222 Pen white Plymouth Rocks.
E. T. Rice, Newton Lower Falls, Mass.
587 260 Pair black breasted red game.
588 260 Pair black breasted red game.
589 260 Pair black breasted red game.

EMERSON

FINEST TONE,
BEST WORK
AND MATERIAL.

(ESTABLISHED IN 1849.)

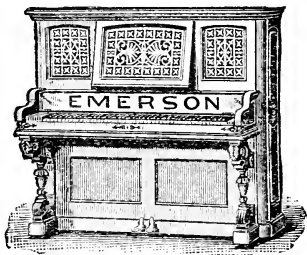

**50,000
MADE AND
IN USE.**

*Every Instrument
Fully
Warranted.*

*PRICES MODERATE AND
TERMS REASONABLE.*

PIANOS

ILLUSTRATED CATALOGUES FREE.

EMERSON PIANO Co.

WAREROOMS:

174 Tremont Street,
92 Fifth Avenue,
202 Main Street,

Boston, Mass.
New York.
Brockton, Mass.

- 590 260 Pair black breasted red game.
 591 262 Pair silver duck wing games.
 B. S. Upham, Wilsonville, Conn.
- 592 268 One pen black red game Bantams.
 593 368 One pen silver duck wing Bantams.
 594 268 One pen golden duck wing Bantams.
 595 268 One pen white game Bantams.
 596 276 One pen golden Sebright Bantams.
 M. J. Kane, Lynn, Mass.
- 597 310 One pair black carrier pigeons.
 598 313 One pair black pied pouter pigeons.
 599 317 One pair black Barbs.
 600 321 One pair white Barbs.
 601 324 One pair blue S. H. fantails.
 602 378 One pair blue S. H. magpies.
 603 396 One pair blue Dragoons.
 604 397½ One pair blue Antwerps.
 J. L. Odiorne, Cambridgeport, Mass.
- 605 279 One pair black rose comb Bantams.
 Warren L. Bacon, Cambridgeport, Mass.
- 606 397½ One pair silver homing pigeons.
 William R. Schaefer, Cambridgeport, Mass.
- 607 225 One pen Wyandottes.
 Turner and Elliott, West Bridgewater, Mass.
- 608 210 One pair light Brahmas.
 609 210 One pair light Brahmas.
 610 210 One pair light Brahmas.
 611 210 One pair light Brahmas.
 David L. Story, Beverly, Mass.
- 612 210 Pair light Brahmas.
 613 209 Breeding pen light Brahmas.
 Geo. W. Plen, Pittsfield, Mass.
- 614 259 Breeding pen brown breasted red game.
 615 259 Breeding pen brown breasted red game.
 616 259 Breeding pen red Pyle Game.
 617 268 Breeding pen red Pyle Bantams.

CATARRH CURED BY ELECTRICITY !

MRS. DR. AUGUSTA SOLOMON'S
ELECTRIC
CATARRH CURE

Is a Quick and Certain Cure for

**CATARRH, NEURALGIA, HEADACHE,
HAY FEVER AND COLDS,**

And all kindred diseases. It clears the head, sweetens the breath, and cures the disease in all its stages.

The Worst Nervous Headache Cured in from one to three minutes.

PRICE, \$1.00 PER BOTTLE.

One Bottle WARRANTED TO CURE the Worst Case.

MRS. DR. AUGUSTA SOLOMON,
75 COURT STREET, - - BOSTON, MASS.

The trade supplied by Weeks & Potter, Boston.

- 618 268 Breeding pen red Pyle Bantams.
 619 247 Breeding pen Bearded Polish.
 620 222 Breeding pen white Plymouth Rocks.
 S. L. Holbrook, Lynn, Mass.
 621— 12 pair pigeons.
 Reuben W. Ropes, Salem, Mass.
- 622 235 Breeding pen white Leghorns.
 623 235 Breeding pen white Leghorns.
 624 237 Pair white Leghorns.
 625 237 Pair white Leghorns.
 626 237 Pair white Leghorns.
 627 224 Pair Plymouth Rocks.
 628 224 Pair Plymouth Rocks.
 629 222 Breeding pen Plymouth Rocks.
 630 293 Pair Pekin ducks.
 631 293 Pair Pekin ducks.
 James Rankin, South Easton, Mass.
- 632 293 One pair Pekin ducks.
 633 293 One pair Pekin ducks.
 Horace M. Hunt, Rockland, Mass.
- 634 — One pair of English Red Caps.
 635 — One pair of English Red Caps.
 636 224 One pair Plymouth Rocks.
 Thomas Thorpe, Highlandville, Mass.
- 637 222 Breeding pen silver Wyandottes.
 638 222 Breeding pen silver Wyandottes.
 639 222 Breeding pen silver Wyandottes.
 640 222 Breeding pen silver Wyandottes.
 641 222 Breeding pen silver Wyandottes.
 642 222 Breeding pen silver Wyandottes.
 643 222 Breeding pen silver Wyandottes.
 644 222 Breeding pen silver Wyandottes.
 645 222 Breeding pen silver Wyandottes.
 646 222 Breeding pen silver Wyandottes.
 James W. Allen, Needham, Mass.
- 647 223 Pair black fantail pigeons.
 648 324 Pair blue fantail pigeons.

- 649 377 Pair black S. H. magpies.
 650 378 One pair blue S. H. magpies.
 651 379 One pair red S. H. magpies.
 652 389 One pair red beard.
 653 397½ One pair blue Antwerps.
 654 397½ One pair blue checkered Antwerps.
 655 397½ One pair red checkered Antwerps.
 656 327 One pair of dun fantails.
 Charles S. Flanders, Concord, N. H.
- 657 222B One pen golden Wyandottes.
 658 225B One pair golden Wyandottes.
 659 225B One pair golden Wyandottes.
 Nathan B. Hartford, Watertown, Mass.
- 660 238 Pair brown Leghorns.
 661 238 Pair brown Leghorns.
 662 235 Breeding pen brown Leghorns.
 W. H. Perkins, Watertown, Mass.
- 663 222 One breeding pen golden laced Wyandottes.
 C. B. Cutter, Auburndale, Mass.
- 664 222½ Breeding pen white Plymouth Rocks.
 665 222½ Breeding pen white Plymouth Rocks.
 666 224½ One pair white Plymouth Rocks.
 667 224½ One pair white Plymouth Rocks.
 668 224½ One pair white Plymouth Rocks.
 W. H. Jennings, Newton Lower Falls, Mass.
- 669 220 Silver gray Dorkings.
 670 220 Silver gray Dorkings.
 671 237 One pair white Leghorns.
 672 238 One pair brown Leghorns.
 W. W. Harrington, Wellesley Hills, Mass.
- 673 235 Pen brown Leghorns.
 674 235 Pen brown Leghorns.
 675 235 Pen brown Leghorns.
 676 238 One pair brown Leghorns.
 677 239 Pair black Leghorns.
 678 235 Pen black Leghorns.

- H. Earnshaw, West Roxbury, Mass.
 679 228 One pen silver penciled Hamburg.
- B. W. Gooding, Plymouth, Mass.
 680 247 White crested Black Polish.
 681 248 Pair white crested Black Polish.
- E. P. Rogers, Chelsea, Mass.
 682 247 One pair bald head Terbits.
 683 390 One pair Tumblers.
- John G. Godrey, Salem, Mass.
 684 222 Pen silver laced Wyandottes.
 685 225 Pair silver laced Wyandottes.
- Chas. A. Ballou, Worcester, Mass.
 686 211 One pair dark Brahas.
 687 209 One pen dark Brahas.
 688 259 One pen black breasted red game Bantams.
 689 260 One pair black breasted red game Bantams.
 690 213 One pair partridge Cochins.
- G. F. Hallowell, Boston, Mass.
 691 269 One pair B. B. red game Bantams.
- Thomas & Hopkins, Conway, Mass.
 692 209 Breeding pen buff Cochins.
 693 212 Pair buff Cochins.
 694 212 Pair buff Cochins.
 695 224½ Pair white Plymouth Rocks.
- Robert G. Howard, Newton, Mass.
 696 222 Breeding pen Wyandottes.
- Forest E. Newhall, West Roxbury, Mass.
 697 237 Pair white Leghorns.
 698 237 Pair white Leghorns.
 699 235 Pen white Leghorns.
- L. W. Leach, Lincoln, Mass.
 700 237 Pair white Leghorns.
 701 237 Pair white Leghorns.
- A. C. Smith, Worcester, Mass.
 702 239 Pair brown Leghorns.
 703 239 Pair brown Leghorns.

August Schmitt, Roxbury, Mass.

704 266 One pair games.

705 259 One pair games.

E. L. Sanderson, Waltham, Mass.

706 225 Pair Wyandottes.

Fred Heintz, Roxbury, Mass.

707 353 One pair black winged Terbits.

708 354 One pair blue winged Terbits.

709 356 One pair red winged Terbits.

710 360 One pair black Jacobins.

711 371 One pair white Trumpeters.

712 371 One pair white Trumpeters.

713 374 One pair blue Swallows.

714 391 One pair black Nuns.

715 391 One pair black Nuns.

716 324 One pair S. H. blue Fantails.

J. A. Hubbard, Cambridge, Mass.

717 222 One pen Wyandottes.

John B. Bowker, Worcester, Mass.

718 222 One breeding pen Plymouth Rocks.

719 224 One pair Plymouth Rocks.

720 224 One pair Plymouth Rocks.

Arthur Smith, Conway, Mass.

721 247 One pen B. G. Polish.

722 255 One pair B. G. Polish.

T. S. Hager, Auburndale, Mass.

723 222 One pen silver laced Wyandottes.

724 222 One pen silver laced Wyandottes.

F. L. Weston, Boston, Mass.

725 269 Black breasted red game Bantams.

726 269 Black breasted red game Bantams.

S. F. Weston, Medford, Mass.

727 397½ Pair blue Antwerps.

728 397½ Pair silver Antwerps.

729 397½ Pair blue checkered Antwerps.

A. W. McKinstry, Chicopee, Mass.

730 235 Pen black Spanish.

731 236 Pair black Spanish.

W. P. Cutler, Woburn, Mass.

732 231 One pair golden penciled Hamburgs.

F. J. Kingsley, North Dighton, Mass.

733 209 Pair black Cochins.

734 215 Pair black Cochins.

735 209 Pair black Langshans.

736 216 Pair Langshans.

A. F. Pierce, Winchester, N. H.

737 260 B. B. red games.

738 261 Brown red games.

739 262 Pair silver duck wing.

740 264 Pair red Pyle Game.

741 267 Black Sumatra.

J. L. Hope, Rhinecliff, N. Y.

742 220 One pair S. G. Dorking.

743 268 One pen black breasted R. G. Bantams.

744 260 One pair black breasted red game.

C. F. A. Smith, Waltham, Mass.

745 222 One pen white Wyandottes.

746 225A One pair white Wyandottes.

747 225A One pair white Wyandottes.

Nathan E. Smith, Waltham, Mass.

748 225 One pair laced Wyandottes.

749 222 One pen laced Wyandottes.

J. U. Jones, Somerville, Mass.

750 277 One pair Bantams.

H. M. Chorek, New Bedford, Mass.

751 209 One pen dark Brahmas.

C. S. Calhoun, New Bedford, Mass.

752 228 Pen black Hamburgs.

753 233 Pair black Hamburgs.

C. E. Drew, Avon, Mass.

754 215 One pair black Cochins.

M. I. Ellis, Norwood, Mass.

- 755 222 One pen Plymouth Rocks.
 756 222 One pen Plymouth Rocks.
 757 224 Pair Plymouth Rocks.
 758 224 Pair Plymouth Rocks.
 759 224 Pair Plymouth Rocks.
 760 224 Pair Plymouth Rocks.

C. H. Herbert, Concord, N. H.

- 761 213 One pair Partridge Cochins.

Gideon Terrill, North Abington, Mass.

- 762 225B One pen gold laced Wyandottes.
 763 225B Pair gold laced Wyandottes.

W. A. Loud, North Abington, Mass.

- 764 212 Pair buff Cochins.

A. H. Cooleage, Brookline, Mass.

- 765 268 Pair black breasted red game Bantams.
 766 269 Pen black breasted red game Bantams.

J. T. Cothran, Greenwich, N. Y.

- 767 222 One pen gold Wyandottes.
 768 225B One pair gold Wyandottes.
 769 228 One pen G. P. Hamburgs.
 770 231 Pair G. P. Hamburgs.
 771 232 Pair S. P. Hamburgs.
 772 277 Pair golden seabright Bantams.

James L. Little, Jr., Brookline, Mass.

- 773 235 Pen black Leghorns.
 774 269 Pair B. B. red game Bantams.

W. L. Bacon, Cambridgeport, Mass.

- 775 262 Pair red Jacobins.
 776 262 Pair red Jacobins.
 777 360 Pair black Jacobins.
 778 360 Pair black Jacobins.
 779 363 Pair yellow Jacobins.

F. W. Legg, Woburn, Mass.

- 780 260 One pair B. B. R. Games.

- E. A. Legg, Woburn, Mass.
- 781 268 One pen B. B. R. game Bantams.
- S. H. Warren, Weston, Mass.
- 782 222 One pen mottled Javas.
- 783 227 Pair mottled Javas.
- Arthur Holbrook, Saugus, Mass.
- 784 268 Pen B. B. R. game Bantams.
- Sumner Paine, Cambridge, Mass.
- 785 264 One pair red Pyle Game.
- 786 264 One pair red Pyle Game.
- 787 271 One pair red Pyle Bantams.
- 788 271 One pair red Pyle Bantams.
- 789 269 Pair B. B. R. Bantams.
- 790 272 Pair white game.
- 791 265 Pair black game.
- 792 269 Pair games.
- Martin J. Kane, Lynn, Mass.
- 793 241 Pair white Leghorns.
- Wm. H. Buck, Webster, Mass.
- 794 245 Pen Houdans.
- 795 245 Pair Houdans.
- Shepard & Buffington, Fall River, Mass.
- 796 410 One incubator.
- 797 408 One brooder.
- Wood & Page, Lynn, Mass.
- 798 410 One incubator.
- 799 408 One brooder.
- J. Irving Payson, Jamaica Plain, Mass.
- 800 269 Black breasted red game Bantam.
- F. W. Dolliver, Brookline, Mass.
- 801 269 One pair black breasted red game Bantams.
- Lester B. Gunn, Lanesboro, Mass.
- 802 232 Silver penciled Hamburg.

803	255	Bearded golded Polish.
804	260	Black B. R. Games.
805	261	Brown B. R. Games.
806	263	Yellow D. W. Games.
807	267	Black Sumatras.
808	264	Red Pyle Game.
809	265	Black Game.
810	292	Pair colored Muscovy Ducks.

C. C. Paine, So. Randolph, Vermont.

811	212	Pair buff Cochins.
812	225B	Pair golden Wyandottes.
813	222B	Pen golden Wyandottes.
814	222	Pen golden Wyandottes.
815	241	Pair rose comb white Leghorns.
816	245	Pair Houdans.
817	250	Pair golden Polish.
818	247	Pen golden Polish.
819	274	Pair Y. D. game Bantams.
820	283	Pair Pekin Bantams.
821	288	Pair Rouen Ducks.
822	290	Pair Cayuga Ducks.
823	291	Pair white Muscovy Ducks.
824	292	Pair colored Muscovy Ducks.
825	294	Pair white crested Ducks.
826	302	Pair white Guineas.

W. P. Perkins, Danvers, Mass.

827	271	Pair red Pyle Game Bantams.
828	274	Pair G. D. Game Bantams.
829	283	Pair Pekin Bantams.
830	288	Pair of Rouen Ducks.
831	291	Pair White Muscovy.
832	293	Pair Pekin Ducks.
833	293	Pair Pekin Ducks.
834	294	Pair white crested Ducks.
835	297	Pair white Call Ducks.
836	297	Pair white Call Ducks.
837	298	Pair gray Call Ducks.

- 838 299 Pair Wood Ducks.
839 301 Pair pearl Guineas.

George Feather, Dorchester, Mass.

- 840 351 Pair solid white Terbit pigeons.
841 351 Pair solid white Terbit pigeons.
842 348 Pair black Terbit pigeons.
843 354 Pair blue winged Terbits.
844 354 Pair blue winged Terbits.
845 355 One pair silver winged Terbits.
846 356 One pair red winged Terbits.
847 357 One pair yellow winged Terbits.
848 335 Pair blue English owls.
849 335 Pair blue English owls.
850 336 Pair silver English owls.
851 336 Pair silver English owls.
852 339 One pair Yellow English owls.
853 334 One black English owl.
854 337 Pair white English owls.
855 379 Pair red S. H. magpies.
856 379 Pair black crested magpies.
857 385 Pair blue B. H. Tumblers.
858 384 Black B. H. Tumblers.
859 383 Pair red Tumblers.

W. A. Graves, Brookline, Mass.

- 860 383 One pair yellow Tumblers.
861 383 One pair yellow Tumblers.
862 — Pair black Tumblers.
863 336 Silver English owls.

Frank H. Church, New Bedford, Mass.

- 864 209 One pen Langshans.

E. P. Rogers, Chelsea, Mass.

- 865 357 Pair white Terbits.
866 — Pair B. B. Baldheads.

Philander Williams, Taunton, Mass.

- 867 209 One breeding pen partridge Cochins.

868	213	One pair partridge Cochins.
869	209	One breeding pen light Brahmas.
870	210	One pair light Brahmas.
871	209	One breeding pen dark Brahmas.
872	211	One pair dark Brahmas.
873	209	One breeding pen black Cochins.
874	215	One pair black Cochins.
875	222	One breeding pen Plymouth Rock.
876	224	One pair Plymouth Rocks.
877	222	One breeding pen white Plymouth Rocks.
878	224½	One pair white Plymouth Rocks.
879	235	One breeding pen rose comb brown Leghorns.
880	242	One pair rose comb brown Leghorns.
881	268	One breeding pen gold laced Sebrights.
882	277	One pair gold laced Sebrights.
883	268	One breeding pen black Pekin Bantams.
884	—	One pair black Pekin Bantams.
885	276	One breeding pen black rose comb Bantams.
886	—	One pair black rose comb Bantams.
887	283	One pair buff Pekin Bantams.
888	326	One pair S. H. yellow fantail pigeons.
889	332	One pair of crested yellow fantail pigeons.
890	367	One pair black Russian Trumpeters.
891	372	One pair mottled Russian Trumpeters.
892	222	One breeding pen silver laced Wyandottes.
893	225	One pair silver laced Wyandottes.

C. A. Gasset, Lewiston, Maine.

894	228	One pen black Hamburgs.
895	228	One pen golden spangled Hamburgs.
896	228	One pen silver spangled Hamburgs.
897	230	One pair silver spangled Hamburgs.
898	235	One pen brown Leghorns.
899	237	One pair white Leghorns.
900	245	One pair Houdans.
901	—	One pen Erminettes.
902	268	One pen S. D. Game Bantams.
903	271	One pair red Pyle Game Bantams.
904	283	One pair Pekin Bantams.

905 288 One pair Rouen ducks.

F. H. Andrews, South Woodstock, Conn.

906 247 Buff laced Polish.

907 209 Light Brahmas.

908 235 White faced black Spanish.

909 248 Pair buff laced Polish.

910 218 White Dorkings.

911 218 Colored Dorkings.

912 — Black Minorcas.

913 259 B. B. R. Game.

914 260 One pair B. B. R. Game.

915 259 Brown red Game.

916 261 Pair brown red Game.

917 259 Red Pyle Game.

918 264 Pair red Pyle Game.

919 259 White Game.

920 — One pair white doves.

921 238 One pair brown Leghorns.

922 239 Pair black Leghorns.

923 252 Pair buff Polish.

924 249 Pair white Polish.

W. B. Atherton, Newton Lower Falls, Mass.

925 222 One pen American Dominiques.

926 223 One pair American Dominiques.

927 223 One pair American Dominiques.

928 247 One pen white Polish.

929 249 One pair white Polish.

930 322 Six pair S. H. white Fantails.

931 328 Three pair crested white Fantails.

932 323 Four pair S. H. black Fantails.

933 — Two pair colored Fantails.

934 314 One pair blue Pied Pouters.

935 313 One pair black Pied Pouters.

936 312 One pair black Pouters.

937 312 One pair yellow Pouters.

938 312 One pair white Pouters.

939 — One pair black mottled Tumblers.

} One collection.
 }
 } One collection.

CATALOGUE ADDENDA.

- Premium No. 1.—1A Dudley Wells, Mathersfield, Conn. Cow, Lady Mysie, 6524; reserved.
- Premiums No. 14 and 15.—62A John R. Brewer, Hingham, Mass. Cora Torment, 47,131; calved Sept. 25, 1887; sire Snappit, 13,395, dam Lady Thornton 34,121.
- Premium No. 17.—82A Levi P. Morton, Rhinecliffe, N. Y. Safeguard; reserved. 82B Diss 3d; reserved.
- Premium No. 25.—109A H. W. Keyes, Newbury, Vt. Aaggie Flora's Banjo, 2093 H. F.; reserved.
- Premium No. 26.—114A J. A. Frye, Marlboro, Mass. Fritoma 2d's Mercedes Prince, 7 mo. 115A Chas. Robinson & Son, Barre Plains, Mass. Queen of Pawling, 2420. 115B Maudina 3d, 3377. 116A W. A. Russell, No. Andover, Mass. Princess Willem Archer 8366. 116B Belle Thyrsa, 8442.
- Premium No. 27.—118A John A. Frye, Marlboro, Mass. Koster 3d, Keyes; reserved.
- Premiums No. 30 and 31.—178A W. A. Russell, No. Andover, Mass. Catheena Shepard, 8372, H. F.
- Premium No. 33. 212A O. A. Kelley, Worcester, Mass. Ethel 3d, 96.—212B Gertrude, 295. 212C Angie, 189. 212D Ethel 4th.
- Premium No. 41.—233A Harry H. Hale, Bradford, Mass. Desdemona; reserved.
- Premium No. 57.—254A E. A. Bailey, Winthrop, Me. Pearl 3d, 16,987. 254B Marygold, 25,027. 254 C Milly 4th, 17,789; reserved.
- Premium No. 66.—274A Walter Cutting, Pittsfield, Mass. Clarissa, 944. 274B Modesty of Lehigh, 2252. 274C Serenade, 3643. 274D Calliope, 2767 274E. Diana, 146.
- No. 46, page 17, last line.—Dam Moth at St. Lambert, should be Moth of St. Lambert.
- No. 312, page 64.—Horse printed Orton should be Orion.

PROGRAMME

OF JUDGING

SPECIAL FEATURES

BAND CONCERTS

AND

LIST OF IMPLEMENT EXHIBITORS

Bay :: State :: Agricultural :: Society

CATTLE SHOW AND FAIR

Mechanics Building

OCTOBER SEVEN TO TWELVE

1889

Among the SPECIAL FEATURES that will be exhibited in the

EXHIBITION RING

during the Fair will be

E. W. LYON'S TROUPE OF TRAINED STEERS,

who will perform all the

WONDERFUL TRICKS

that have ever been attempted by any animal.



Another SPECIAL FEATURE of the EXHIBITION RING
will be

3 PAIRS OF TRAINED OXEN,

which will be exhibited by MR. E. W. BAILEY. They will
perform many

MARVELLOUS AND INTELLIGENT FEATS.

PROGRAMME OF MUSIC TO BE PERFORMED BY

BALDWIN'S BOSTON CADET BAND.

MONDAY, OCTOBER 7.

AFTERNOON.

1. MARCH. "Festival" *Lewis*
2. OVERTURE. "Semiramide" *Rossini*
3. CONCERT. "Remembrance of Naples" *Bennett*
4. GRAND SELECTION. "Il Lombardi" *Verdi*
5. CORNET SOLO. "Pollaca" *Henry*
Mr. THOMAS W. HENRY.
6. NOCTURNE RELIGIEUSE. "The Monastery Bells" *Wely*
7. IMPROMPTU. "L'Alerte" *Behr*
8. CONCERT WALTZ. "Gorenadier Militaire" *Waldteufel*
9. POTPOURRI. From Offenbach's Opera *Godfrey*
10. SCHERZO. "A La Russian" *Balmeihd*

EVENING.

1. MARCH. "Commonwealth" *Bagley*
2. OVERTURE. "Merry Wives of Windsor" *Nicolai*
3. CONCERT WALTZ. "Beautiful Maiden" *Weis*
4. GRAND SELECTION. "Nadjy" *Chassaigune*
5. PICCOLO SOLO. "Through the Air" *Damm*
AUGUST DAMM.
6. MEDLEY OF FAVORITE AIRS. "Among the Minstrels" . . . *Lewis*
7. COURT GAVOTTE. "Whispered Love" *Abecasis*
8. CAPRICE DI CONCERT. "Ilma" *Baldwin*
9. SELECTION. "Martha" *Flotow*
10. GALOP. "On the Road" *Ramsdell*

J. THOMAS BALDWIN, Conductor.

THE GERMANIA BAND

WILL PERFORM THE FOLLOWING PROGRAMME.

TUESDAY, OCTOBER 8.

AFTERNOON.

1. GRAND MARCH. From "The Queen of Sheba" *Gounod*
2. OVERTURE. "Jubel" *Ch. Bach*
3. CONCERT WALZ. "Rhein Sagen". *Gung'l*
4. GRAND SELECTION. From "Simon Bocanegra" *Verdi*
5. SEXTETTE. From "Lucia" *Donizetti*
6. OVERTURE. "Egmont" *Beethoven*
7. ENTRE ACT. "Colombe" *Gounod*
8. { *a* "The Irish Patrol" *Puerner*
 { *b* "Exit Boulanger" *Wiegand*
9. REMINISCENCES OF VERDI *Heinecke*
10. GALOP. "Inferno" *Parlow*

EVENING.

1. MARCH. "Militaire Francaise" *Saint-Saens*
2. OVERTURE. "William Tell" *Rossini*
3. CONCERT WALZ. "Santiago" *Corbin*
4. GRAND SELECTION. From "Don Carlos" *Verdi*
5. ANVIL POLKA *Parlow*
6. OVERTURE. "Furandot" *Lachner*
7. GRAND POTPOURRI OF IRISH MELODIES *Beyer*
8. SERENADE *Moskowski*
9. "TEN MINUTES WITH THE MINSTRELS" *G. Bowron*
10. GALOP. "Thunder and Lightning" *Strauss*

PROGRAMME OF MUSIC TO BE PERFORMED BY

BALDWIN'S BOSTON CADET BAND.

WEDNESDAY, OCTOBER 9.

AFTERNOON.

1. MARCH. "Sheridan" *Appeles*
2. OVERTURE. "Fra Diavolo" *Auber*
3. CONCERT WALTZER. "Our Colonel"
4. CORNET SOLO. "Oxford and Cambridge" *Halevy*
FRANK E. PARTRIDGE.
5. GRAND SELECTION. "Bohemian Girl" *Balfe*
6. COMIC PATROL. "Comique"
7. POPULAR MEDLEY. "Southern Plantation" *Conterno*
8. ROMANCE. "Beautiful Vienna" *Bohne*
9. FINALE. From "Ariele" *Bach*
10. CONCERT GALOP. "La De Ku" *Wadsworth*

EVENING.

1. MARCH. "Elizabeth" *Budik*
2. OVERTURE. "Oberon" *Weber*
3. CONCERT WALTZ. "A Toi" *Waldteufel*
4. SELECTION. From Bellini *Godfrey*
5. PICCOLO SOLO. "Brunette" *Di Carlo*
AUGUST DAMM.
6. CZARDAS. "Hungarian Melody" *Hasselmann*
7. ON THE PLANTATION *Puerner*
8. GRAND SELECTION. "Carmen" *Bizet*
9. CAPRICE. "La Baladine" *Lysberg*
10. FINALE. "Die Rose" *Spohr*

J. THOMAS BALDWIN, *Conductor.*

THE GERMANIA BAND

WILL GIVE TWO CONCERTS AS FOLLOWS.

THURSDAY, OCTOBER 10.

AFTERNOON.

1. GRAND MARCH. From Suite in Bb *Lachner*
2. OVERTURE. "Fest" *Leutner*
3. CONCERT WALTZ. "Vienna Bloods" *Strauss*
4. DUO FOR CORNET AND BARITONE. From "Linda" *Donizetti*
5. GRAND SELECTION. From "Faust" *Gounod*
6. OVERTURE. "Masaniello" *Auber*
7. BOLERO. *Arditi*
8. HUNTING SCENE. From "Sylvia" *Delibes*
9. { *a* MAZURKA DE CONCERT. "Terisina" *Faust*
 { *b* GAVOTTE. "Heart's Delight" *Warren*
10. A NIGHT IN NEW YORK *Brooks*

EVENING.

1. MARCH. "Col. Taylor's" *Stewart*
2. OVERTURE. "Semiramide" *Rossini*
3. CONCERT WALTZ. "New Vienna" *Strauss*
4. PICCOLO SOLO. "Polka Brillante" *Schade*
 PAUL FOX.
5. GRAND SELECTION. - From "Maritana" *Wallace*
6. OVERTURE. "Giraldi" *Adam*
7. PILGRIMS' CHORUS. From "Tannhauser" *Wagner*
8. PLANTATION DIVERTISSEMENT *G. Bowron*
9. PARAPHRASE. "Loreley" *Nesvalba*
10. THE GERMANS BEFORE PARIS *Trenkler*

BALDWIN'S BOSTON CADET BAND

WILL PERFORM THE FOLLOWING PROGRAMME.

FRIDAY, OCTOBER 11.

AFTERNOON.

1. MARCH. "Chevalier" *W. Lewis*
2. OVERTURE. "Le Fidele Berger" *A. Adam*
3. CONCERT WALTZER. "Fedora" *Bucalossi*
4. CORNET SOLO. "The Dude" *Guilford*
Mr. C. COOLIDGE WARD.
5. GEMS. From Donizetti's Operas *Godfrey*
6. CAPRICE. "Loose Leaves" *Reiner*
7. HUMORISTIQUE. "The Darkies' Patrol" *Lansing*
8. SELECTION. From Orphee aux Enfers" *Offenbach*
9. CONCERT GALOP. "A la Turquie" *Koppitz*

EVENING.

1. MARCH. "Seimiter" *Ramsdell*
2. OVERTURE. "Pygmalion and Galatea" *Suppe*
3. CONCERT WALTZ. "Capitola" *Auerbach*
4. CLARINET SOLO. "Air Manie" *Cavallini*
Mr. LORENZO WHITE.
5. GRAND SELECTION. From "Trovatore" *Verdi*
6. CONCERT GAVOTTE. "Magnolia" *Eldridge*
7. DANSE DES SULTANES *Daniels*
8. CONCERT WALTZER. "Immer Heiterer" *Strauss*
9. SELECTION. "Faust" *Gounod*
10. FINALE. "Venea" *Behrier*

J. THOMAS BALDWIN, Conductor.

Bay State Agricultural Society's Fair.

The following days and hours will be devoted to judging :

- MONDAY, OCT. 7. Class 4, *POULTRY.*
- TUESDAY, OCT. 8. Morning, commencing at 9 o'clock.
Class 1, No. 4. *HOLSTEINS.*
No. 11. *FAT CATTLE.*
No. 12. *WORKING OXEN.*
Class 3, *SHEEP and SWINE.*
Class 6, *GRAIN and VEGETABLES*
Class 7, *DAIRY.*
Class 8, *FLOWERS and FRUITS.*
Class 9, *DOMESTIC.*
Afternoon, commencing at 2 o'clock.
Class 2, No. 13. *PERCHERONS.*
No. 15. *COACH HORSES.*
No. 17. *GEN'L PURPOSE HORSES*
No. 20. *MULES.*
Class 1, No. 6. *SHORTHORNS.*
- WEDNESDAY, OCT. 9. Morning, commencing at 9 o'clock.
Class 1, No. 2. *JERSEYS.*
No. 5. *SWISS.*
No. 8. *HEREFORDS.*
No. 9. *POLLED.*
Afternoon, commencing at 2 o'clock.
Class 2, No. 16. *TROTTING HORSES.*
No. 19. *HARNESS and SADDLE.*
No. 14. *THOROUGHBREDS.*
- THURSDAY, OCT. 10. Morning, commencing at 9 o'clock.
Class 1, No. 1. *AYRSHIRES.*
No. 7. *DEVONS.*
No. 3. *GUERNSEYS.*

THE FOLLOWING are the names of Exhibitors
in the IMPLEMENT DEPARTMENT of the Bay
State Fair:

CLINTON WIRE CLOTH CO.

J. A. CROSS.

D. H. PRIEST.

H. J. BAKER & BRO.

PARKER & WOOD.

WIARD PLOW CO.

AMES PLOW CO.

J. B. SMALL & CO.

REYNOLDS BROS.

GRAY HORSE POWER MACHINE CO.

C. A. WHITTEMORE.

TROY CARRIAGE WORKS.

E. P. CURTIS.

GEO. TYLER & CO.

MURDOCK LIQUID FOOD CO.

HIGGAMUN MFG. CO.

SMITH & WINCHESTER.

C. E. BRADLEY.

STUDEBAKER BROS.

F. C. PIERS.

H. I. CARVER & CO.

HENRY O. PEABODY.

WM. HARRIOT, Agent.

GEO. S. REDFIELD.

PRUSSIAN ARMY OIL MFG. CO.

O. H. ROBERTSON.

CHAS. G. ALLEN & CO.

W. H. FERGUSON, Agent.

FRANK A. RUGGLES.

GILBRIDE & GREY.

L. H. WHEELER.

BRADLEY & CO.

M. L. ARNOLD.

EGYPTIAN CHEMICAL CO.

E. L. CLARK.

LYDIA PINKHAM.

W. S. MACOMBER.

R. & J. FARQUHAR.

HASKEL ANTI-RATTLER CO.

JOHN E. HOBBS.

THEOBROMA WINE CO.

DR. SOLOMON.

UNIVERSAL WEEDER CO.

GOWAN MFG. CO.

W. W. RAWSON, Supt.

A SPECIAL FEATURE OF THE FAIR

WILL BE

HUMPHREY'S EQUINE ACTORS,

who will perform at intervals many wonderful and interesting acts,
among them being

A MILITARY DRILL,

BY

TWELVE ✧ TEXAS ✧ BRONCHOS.

Who Answer the Roll Call. Form in Line. March in Single File.
Double File. Counter-march. March in Columns of Four.
March in Columns of Six and in Solid Column,
and Form in Dress Parade.

✧ TWO WHITE BRONCHOS ✧

Perform a wonderful act on a TEETER BOARD.

A Magnificent Dapple Grey Horse,

— GOVERNOR, —

gives an exhibition of Dancing, Walking Lame, Spanish Twist, Walks,
Trots, Gallops at the word of command; Walks Backward,
Walks Sideways, Marches and Poses as a Statue.

A REALISTIC BATTLE

is fought by four horses, who fire cannons strapped on their backs
and do other startling tricks.

[See Next Page.]

A BEAUTIFUL BAY MARE,

TOPSY,

answers questions of all kinds ; Plays on Organ, Rings Bells, Picks out
Different Colors, Jumps Skipping Rope, Dances, Shoots Pistols,
stands with four feet on a Pedestal ten inches wide,
Rolls a Barrel with her nose.

A TRICK MULE, JERRY,

Fans himself, Rings Bells, Swings himself, and if any one will ride him,
makes it very interesting for the rider and the audience.

THE JUMPING PONIES,

BURT,

PHIDO, KNI O KITCH,

WALPOT,

Give exhibitions of leaping hurdles and high jumping. The smallest
of the four,

⇒ **BURT,** ⇐

will jump higher than any pony of his size in the world.

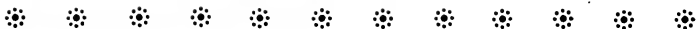

A

SUPERB

RESTAURANT

will be found on the Balcony Floor of

EXHIBITION HALL.

OPEN ALL HOURS

DAY AND EVENING.



Entries Close Wednesday, September 4, 1889.

BAY STATE AGRICULTURAL SOCIETY,

List of Premiums,

AND

REGULATIONS,

FOR THE

THIRD CATTLE SHOW AND FAIR,

TO BE HELD AT THE

Mechanics' Charitable Association Building,

BOSTON.

October 7, 8, 9, 10, 11 and 12, 1889.

It will be esteemed a favor if YOU will send us the address of any friend to whom you would like this prize list sent.

SALEM, MASS.:
OBSERVER BOOK AND JOB PRINT,
1889.

OFFICERS.

President,

HENRY S. RUSSELL. Milton.

Vice-Presidents.

Barnstable Co. . . .	E. Pierson Beebe, Falmouth.
Berkshire Co. . . .	Merritt I. Wheeler, Gt. Barrington.
Bristol Co.	Philander Williams, Taunton.
Dukes Co.	—————
Essex Co.	Aaron Low, Essex.
Franklin Co.	H. C. Haskell, Deerfield.
Hampden Co.	B. L. Bragg, Springfield.
Hampshire Co.	J. Howe Demond, Northampton.
Middlesex Co.	W. W. Rawson, Arlington.
Nantucket Co.	—————
Norfolk Co.	James M. Ellis, West Dedham.
Plymouth Co.	Davis Copeland, West Bridgewater.
Suffolk Co.	C. Minot Weld, Boston.
Worcester Co.	George M. Whitaker, Southbridge.

Treasurer.

WM. H. BOWKER, Boston,

P. O., 43 Chatham Street.

Secretary.

FRANCIS H. APPLETON, Peabody.

P. O., 23 Court St., Boston.

BAY STATE AGRICULTURAL SOCIETY.

GENERAL REGULATIONS

FOR THE

THIRD CATTLE SHOW AND FAIR AT BOSTON, OCTOBER 7, 8, 9, 10, 11 & 12, 1889.

Entries close Wednesday, Sept. 4th.

Committee of Arrangements.

President, HENRY S. RUSSELL,* Milton.

Secretary, Francis H. Appleton,* Peabody.

Treasurer, Wm. H. Bowker, Boston.

E. F. Bowditch,* Framingham. Edward Burnett, Southboro.

W. W. Rawson, Arlington. C. Minot Weld, Boston.

W. L. Warner, Sunderland. N. B. Douglas, Sherborn.

J. D. W. French, No. Andover.

Superintendents.

Class I, Cattle, Edward Burnett.

Class II, Horses, E. F. Bowditch.

Class III, Sheep and Swine, C. Minot Weld.

Class IV, Poultry, W. F. Bacon.

Class V, Agricultural Implements, W. W. Rawson.

Class VI, Grain and Vegetables, Charles N. Brackett.

Class VII, Dairy, N. B. Douglas.

Class VIII, Flowers and Fruits, E. W. Wood.

Class IX, Domestic Manufactures, W. L. Warner.

Consulting Veterinarian, Dr. Austin Peters, Boston.

Chemist, Prof. C. A. Goessman, Amherst.

Business Manager, Charles H. Thayer, Boston.

*Also Trustees of Massachusetts Society for Promoting Agriculture.

ADMISSION.

1. Each Exhibitor will be given a ticket, *not transferable*. Applications for passes for employees must be made in writing by the Exhibitor, stating each employee's name, to the Superintendent of the Exhibitor's Class. Members of the Society, on application to the Secretary, will receive badges entitling them to admission at any time during the exhibition. The fee for membership is \$5, which can be sent to the Secretary, who will return a Certificate of Membership.

EXHIBITORS.

2. The books of entry will be closed September 4th. This regulation applies to articles entered for "exhibition only," as well as to those put in competition for premiums, and to all the classes, except classes IV. (Poultry), and VII. (Dairy, including Bread and Honey), in which entries close October 1st; VI. (Grain and Vegetables), and VIII. (Flowers and Fruits), in which entries may be made up to 12 o'clock M., on Monday, October 7th; and IX. (Domestic Manufactures), in which entries may be made up to 6 o'clock P. M., on Monday, October 7th.

3. The Entrance Fees must be remitted with the entries, a description of which will be found under the several Classes of Premiums.

All exhibits in Classes VI., VII., VIII. and IX., must be in place by 6 P. M., Monday, October 7th.

4. Entries must be made by letter, addressed to Bay State Agricultural Society, Boston, Mass., on or before September 4th, except in Classes VI., VII., VIII. and IX.

5. Copies of this premium list and blank forms for entries will be furnished on application by mail to the Society's office. Letters should be addressed to the Bay State Agricultural Society, Boston, Mass.

6. Exhibitors must make themselves acquainted with the premium list, regulations and requirements, and be sure in what classes and divisions their entries properly belong.

7. No animal or article may be removed from the show grounds until the close of the Fair. Transgression of this rule will incur forfeiture of any premiums awarded.

8. Exhibitors will not be allowed to sell goods to be delivered during the Fair (though they may receive and book orders), nor will they be permitted to call attention to their wares in any noisy or disorderly manner; and only such signs and placards may be put up as the officers shall approve and allow.

9. All exhibitors must (except in the case of live stock) state at the time of entry, the space needed by them, in order that proper quantity of space may be reserved.

The Society reserves the right to refuse any entries, or parts of entries, offered, particularly such as require an unreasonable amount of room.

10. Exhibitors having business cards, are requested to send them with their entries; also to give full particulars as to the objects entered.

11. Owing to the somewhat limited space for the Department of Implements and Machines, the Committee of Arrangements reserve to themselves full powers to invite the display of such implements and machines as in their judgment seem desirable; and also full powers to disregard or reject, any or all offers of exhibits, and applications for space in this Department.

All exhibits in the Department of Implements and Machines, must be put in place, and taken out of the building within three days after the close of the show, by, and at the expense of, the exhibitors.

12. The Society will take every precaution for the safe keeping of articles and goods of exhibitors, but assumes no responsibility in case of loss or damage; and upon this condition entries are received.

13. Goods and stock must be delivered in the Building or Pens, and put in place by the exhibitors, and promptly removed by them at the close of the Fair. All freight and expressage intended for exhibitors, should be addressed to the respective exhibitors, at Mechanics' Building, Huntington Avenue, Boston.

All freight and express charges must be prepaid and receipts taken.

14. Exhibitors wishing to erect additional structures, or exhibitors requiring additional work, must secure permission to do so from the Superintendent of his class; and in all such cases the exhibitor must bear the expense.

15. Exhibitors can ascertain from the Superintendents of the several departments, when the Judges may be expected to examine their animals or articles. No complaint or appeal based upon the statement that the Judges have overlooked animals or articles, will be considered by the Executive Committee.

16. All protests must be in writing, must state plainly the cause of complaint or appeal, be signed by the protestor, and will not be received unless delivered to the Secretary before 10 P. M. of the day of judging. All protests will be decided by the

Committee of Arrangements, and their decision shall not be subject to any appeal.

17. All entries in competition for prizes must be made in the name of the owners, or the names of the joint owners, if of animals. In Classes VI., VII., VIII. and IX., all articles must be the product of the exhibitor. The penalty for transgression of this rule will be exclusion from the present and all future exhibitions of the Society.

18. Premiums will not be awarded to animals or articles not worthy. If there be but one exhibitor in any division, or subdivision, of a class, only one premium will be awarded—the first or a lower premium, as the Judges may think deserved.

19. Implements and machines exhibited, must be labelled with the name of the exhibitor, name of the machine, its use and the retail price; and they are required to be the same in construction and finish as those sold to the farmer,—not specimens gotten up for exhibition.

20. The Society reserves the right to withhold the premiums awarded in every case in which it shall appear to the Committee of Arrangements that the regulations have not been complied with, or that fraud or deception has been practiced or attempted.

21. No person having entered anything for competition may afterwards withdraw it; nor may any one refuse any premium awarded, and prize cards and ribands *must* be displayed during the Fair. Any infraction of these rules will incur the forfeiture of all premiums awarded to the exhibitor, and such further penalty as the Committee of Arrangements may order. All Premiums remaining unclaimed on November 15th, 1889, will be considered donated to the Society.

LIVE STOCK.

22. All exhibitors of live stock must pay such entrance fee as is stated hereafter under the several Classes, to be sent with the applications, or the applications will not be accepted; and in such latter case no notice will be sent to the owner making the application.

Stalls or pens, except for pigeons, will be provided upon the grounds, and hay, bedding and water will be furnished for cattle, horses and sheep, without charge, and also grain, for swine and poultry, from the Saturday preceding the opening until the close of the Fair, so that the stock may be taken to the grounds immediately on arrival. Grain for cattle, horses and sheep, will be for sale upon the grounds at reasonable prices.

23. The ages of all animals must be given, and satisfactory

evidence furnished if required. All ages will be computed to the first of October to determine in what division the animals shall be entered.

24. The Herd Book, or Register, number of all pure-blood animals, and statements of the breeding of all animals entered as grades, must be given, or filed with the application. Blank forms will be furnished by applying to the Secretary.

25. No animal may compete in more than one class or division, except that cattle may compete as individuals and for the Herd, Bulls and Progeny, Dairy, and any special prizes, and horses, sheep and swine in their proper classes and for any special prizes to which they may be eligible. All animals will be judged and shown in the ring, and exhibitors must be ready to bring them out when called for.

JUDGES.

26. The Judges are requested to report, and have their names entered, at the Secretary's office, in the Mechanics' Building, Huntington Avenue, immediately upon their arrival, where they will be furnished with their badges and informed when they will be called and where. Judges will apply to the Superintendent of their Class in all cases of doubt or difficulty. The Committee of Arrangements will fill vacancies in the list of Judges, and receive their awards signed by *all* the Judges acting in their respective classes, and said Committee, in case of protest, shall have full power to decide. The Judges are requested to hand in their more extended reports before the close of the Fair.

They are requested to report fully upon all objects of interest and value, and to make such recommendations as circumstances or their experience may suggest; but they must not award any extra premiums.

27. It is desired that the Judges in each Class go together to hand in their report, instead of sending it by one of their number, in order that cases of error or doubt may be more promptly and easily made right.

28. Judges will in no case award a premium where there is no merit; and in case there is but one exhibitor in a division of a class, they will award only one premium in that division—the highest, or a second or third premium, as may be proper.

29. In addition to the Prizes in money, the Judges are authorized to award two Commendations in both Class I and Class II, if the entries are numerous, and the animals of sufficient merit. These Commendations to consist of "Highly Commended" and "Commended."

LIST OF PREMIUMS,

(Open to Unrestricted Competition.)

FOR THE

Third Cattle Show and Fair,

TO BE HELD AT

BOSTON, OCTOBER 7, 8, 9, 10, 11 and 12, 1889.

LAST DAY OF ENTRY, SEPTEMBER 4TH.

Class I.—CATTLE.

Superintendent.—EDWARD BURNETT, Southboro.

All exhibitors, will be charged an entrance fee of two dollars (\$2.), [which must be sent with the entry] for each animal entered, without regard to age, one-half of which will be refunded upon such animals as have been exhibited in accordance with the Society's rules.

Herd Prizes.

For the best herd, of one bull and five cows or heifers, all over one year old, of which such as were not bred by the exhibitor have been his property during the six months previous to the exhibition, Ayrshires, Jerseys, Guernseys, Holsteins, Swiss, Shorthorns, Devons, Hereford, and Polled.

The Society's Gold Medal.

The animals to compete for these prizes must be named at the time of entry, but the exhibitor may at the same time name, as reserves, two other animals, one of either sex, qualified as above, to be shown only in case any of the herd entered by him die, or become unfit for exhibition, between the time of entry and time of showing.

Prizes for Bulls and Progeny.

For the bull with which shall be shown four cows or heifers of his own get (all to have had a calf—grades being eligible for competition) in each of the following classes of pure-blood cattle. Ayrshires, Jerseys, Guernseys, Holstein, Swiss, Shorthorns, Devons.

1st prize, \$50; 2nd prize, \$40.

The bulls to compete for these prizes must be specially entered, and they and their progeny to be shown with them must also be entered individually in the proper divisions of the classes to which they belong. It is not required that the progeny be the property of the exhibitor of the sire.

All special prizes, offered in any class, and not herein stated, will be made known through the press.

CATTLE.

1. In the classes of pure-blood cattle, only animals registered, or eligible to registry in recognized Herd Books, will be admitted. See Rule 24. Not more than four entries of cattle for any one premium may be made by any exhibitor, or firm of exhibitors.

2. Cows and heifers in milk must be milked clean on each morning of the Fair, between the hours of six and nine o'clock.

3. No bull over one year old will be allowed upon the grounds without a ring in his nose, nor be led out of his stall except by a staff.

4. No individual will be allowed to exhibit more than 18 head of cattle of any single breed.

5. The Judges will see Rule 29 for conditions under which Commendations can be awarded.

No. 1. Ayrshires.

Premium Number.		1st Prize.	2nd Prize.
1.	Herd,	} Gold } Medal.	
2.	Bull and Progeny—(See explanation on previous pages),	\$50	\$40
3.	Bull, two years old,	25	20
4.	Bull, under two years old,	20	15
5.	Cow, three years old or over,	25	20
6.	Heifer, two years old and under three, in milk,	20	15
7.	Heifer, two years old and under three, not in milk,	20	15
8.	Heifer, under two years old,	15	8

SPECIAL PRIZES offered by the Massachusetts Society for promoting agriculture:—

8 A. Ayrshire herd, bull and five cows, owned in Massachusetts,	\$75	\$50
---------------------------------------------------------------------------	------	------

No. 2. Jerseys.

9. Herd,	} Gold } Medal.	
10. Bull and Progeny—(See explanation on previous pages),	\$50	\$40

Premium Number.		1st Prize.	2nd Prize.
11.	Bull, two years old.	25	20
12.	Bull, under two years old	20	15
13.	Cow, three years old or over,	25	20
14.	Heifer, two years old and under three, in milk,	20	15
15.	Heifer, two years old and under three, not in milk.	20	15
16.	Heifer, under two years old,	15	8

SPECIAL PRIZES offered by the Massachusetts Society for promoting agriculture:—

16 A.	Jersey herd, bull and five cows, owned in Massachusetts,	\$75	\$50
-------	----------------------------------------------------------	------	------

No. 3. Guernseys.

17.	Herd,	} Gold Medal.	
18.	Bull and Progeny—(See explanation on previous pages),	\$50	\$40
19.	Bull, two years old,	25	20
20.	Bull, under two years old,	20	15
21.	Cow, three years old or over,	25	20
22.	Heifer, two years old and under three, in milk,	20	15
23.	Heifer, two years old and under three, not in milk,	20	15
24.	Heifer, under two years old,	15	8

SPECIAL PRIZES offered by the Massachusetts Society for promoting agriculture:—

24 A.	Guernsey herd, bull and five cows, owned in Massachusetts,	\$75	\$50
-------	------------------------------------------------------------	------	------

No. 4. Holsteins.

25.	Herd,	} Gold Medal.	
26.	Bull and Progeny—(See explanation on previous pages),	\$50	\$40
27.	Bull, two years old,	25	20
28.	Bull, under two years old,	20	15
29.	Cow, three years old or over,	25	20
30.	Heifer, two years old and under three, in milk,	20	15
31.	Heifer, two years old and under three, not in milk,	20	15
32.	Heifer, under two years old,	15	8

SPECIAL PRIZES offered by the Massachusetts Society for promoting agriculture:—

32 A.	Holstein herd, bull and five cows, owned in Massachusetts,	\$75	\$50
-------	------------------------------------------------------------	------	------

No. 5. Swiss.

Premium Number.		1st Prize.	2nd Prize.
33.	Herd,	} Gold Medal.	
34.	Bull and Progeny—(See explanation on previous pages),		
35.	Bull, two years old,	25	20
36.	Bull, under two years old,	20	15
37.	Cow, three years old or over,	25	20
38.	Heifer, two years old and under three, in milk,	20	15
39.	Heifer, two years old, and under three, not in milk,	20	15
40.	Heifer, under two years old,	15	8

No. 6. Shorthorns.

41.	Herd,	} Gold Medal.	
42.	Bull and Progeny—(See explanation on previous pages),		
43.	Bull, two years old,	25	20
44.	Bull, under two years old,	20	15
45.	Cow, three years old or over,	25	20
46.	Heifer, two years old and under three, in milk,	20	15
47.	Heifer, two years old and under three, not in milk,	20	15
48.	Heifer, under two years old,	15	8

SPECIAL PRIZES offered by the Massachusetts Society for promoting agriculture:—

48 A.	Shorthorn herd, bull and five cows, owned in Massachusetts,	\$75	\$50
-------	-----------------------------------------------------------------------	------	------

No. 7. Devons.

49.	Herd,	} Gold Medal.	
50.	Bull and Progeny—(See explanation on previous pages),		
51.	Bull, two years old,	25	20
52.	Bull, under two years old,	20	15
53.	Cow three years old or over,	25	20
54.	Heifer, two years old and under three, in milk,	20	15
55.	Heifer, two years old and under three, not in milk,	20	15
56.	Heifer, under two years old,	15	8

No. 8. Herefords.

57.	Herd,	} Gold Medal.	
58.	Bull, of any age,		
59.	Cow, or Heifer, of any age,	25	20

No. 9. Polled Cattle.

Premium Number.		1st Prize.	2nd Prize.
60.	Herd,	} Gold Medal.	
61.	Bull, of any age,		\$25
62.	Cow, or Heifer, of any age,	25	20

No. 10. Dairy Cattle.

In this class, cows and heifers competing in herds, may also compete as individuals. No cow or heifer can compete in both Milch and Butter classes. Pure-bloods and grades can both enter under this class. Pure-bloods may also enter in their respective classes. The milk of all cows must contain 13 per cent. of solids.

The cream will be raised and churned in the Building; and all the tests will be under the direction of the Society's Dairy Expert.

a. Milch Cattle.

63.	Herd, of five cows or heifers, 2 years old or over,	\$50	\$40
64.	Cow, three years old or over,	25	20
65.	Heifer, under three years old,	20	15

b. Butter Cattle.

66.	Herd, of five cows or heifers, 2 years old or over,	50	40
67.	Cow, three years old or over,	25	20
68.	Heifer, under three years old,	20	15

No. 11. Fat Cattle, Oxen and Steers.

Prizes in this class are to be awarded to those animals in best condition for beef for market, and not to those animals loaded with superfluous fat.

69.	Fat Ox, four years old or over,	\$25	\$20
70.	Fat Steer, three years old,	25	20
71.	Fat Steer, under three years old,	20	15
72.	Fat Cow, over three years old,	20	15
73.	Fat Heifer, under three years old,	15	10

No. 12. Working Oxen and Steers.

74.	Pair of Working Oxen, four years old, or over,	\$25	\$15	\$10
75.	Pair of Working Steers, three years old,	25	15	10
76.	Pair of Working Steers, under three years old,	20	15	10

STEERS TRAINED BY BOYS.

77.	Pair of Steers, of any age, trained by a boy under 15 years old,	20	15	10
-----	----------------------------------------------------------------------------	----	----	----

Class II.—HORSES.

Superintendent.—E. F. BOWDITCH, Framingham.

All exhibitors will be charged an entrance fee of two dollars (\$2.) [which must be sent with the entry] for each animal entered, without regard to age, one half of which will be refunded upon such animals as have been exhibited in accordance with the Society's rules.

Horses.

1. No horse will be allowed a premium unless sound, except in case of stallions and brood mares injured by accidents, which do not lessen their usefulness for breeding purposes.

2. Horses must be shown uncovered, and in such manner as the Judges may require or allow, and if exhibitors refuse to submit to the proper requirements of the Judges, their animals will be ruled out. Exhibitors will have the privilege of showing their horses as the Superintendent shall direct.

3. As horses possessing no merit whatever, and not worthy of exhibition, have in some cases been entered merely to secure stabling at the expense of the Society, the Superintendent in charge of this department is empowered and directed, when any cases of this kind are known by him, or reported to him by his assistant, at once to order the animals so entered out of the Building, and the entrance money paid for such animals shall be forfeited.

4. The Judges will see Rule 29 for conditions under which commendations can be awarded.

No. 13. Percherons.

(See Rule 24.)

Premium Number.		1st Prize.	2d Prize.
78.	Stallion, four years old or over, with at least 3 of his progeny,	Gold Medal, or \$40	\$25
79.	Stallion, four years old or over, without progeny,	30	20
80.	Stallion, three years old,	25	15
81.	Stallion, two years old,	20	10
81.	Stallion, one year old,	10	5
82.	Mare, four years old or over,	20	10
83.	Filly, three years old,	20	10
84.	Filly, two years old,	15	8
85.	Filly, one year old,	8	5
86.	Mare, with foal at foot,	30	15

No. 14. Thoroughbreds.

Premium Number.		1st Prize.	2nd Prize.
	(See Rule 24.)		
87.	Stallion, four years old or over, with at least 3 of his progeny,	{ Gold Medal, or \$40	\$25
88.	Stallion, four years old or over, without progeny,	30	20
89.	Stallion, three years old,	25	15
90.	Stallion, two years old,	20	10
91.	Stallion, one year old,	10	5
92.	Mare, four years old or over,	20	10
93.	Filly, three years old,	20	10
94.	Filly, two years old,	15	8
95.	Filly, one year old,	8	5
96.	Mare, with foal at foot,	30	15

No. 15. Coach Horses.

	(See Rule 24.)		
97.	Stallion, four years old or over, with at least 3 of his progeny,	{ Gold Medal, or \$40	\$25
98.	Stallion, four years old or over, without progeny,	30	20
99.	Stallion, three years old,	25	15
100.	Stallion, two years old,	20	10
101.	Stallion, one year old,	10	5
102.	Mare, four years old or over,	20	10
103.	Filly, three years old,	20	10
104.	Filly, two years old,	15	8
105.	Filly, one year old,	8	5
106.	Mare, with foal at foot,	30	15

No. 16. Trotting Horses.

	(See Rule 24.)		
107.	Stallion, four years old or over, with at least 3 of his progeny,	{ Gold Medal, or \$40	\$25
108.	Stallion, four years old or over, without progeny,	30	20
109.	Stallion, three years old,	25	15
110.	Stallion, two years old,	20	10
111.	Stallion, one year old,	10	5
112.	Mare, four years old or over,	20	10
113.	Filly, three years old,	20	10
114.	Filly, two years old,	15	8
115.	Filly, one year old,	8	5
116.	Mare, with foal at foot,	30	15

No. 17. General Purpose Horses.

(Trotting record not to influence the awards.)

117.	Stallion, 16 hands high or over, with at least 3 of his progeny,	{ Gold Medal, or \$40	\$25
118.	Stallion, 16 hands high or over, without progeny,	\$30	\$20
119.	Stallion, 4 years old or over, under 16 hands high, with at least 3 of his progeny,	{ Gold Medal, or \$40	\$25

Premium Number.		1st Prize.	2nd Prize.
120.	Stallion, four years old or over, under 16 hands high, without progeny,	30	20
121.	Stallion, three years old,	25	15
122.	Stallion, two years old	20	10
123.	Stallion, one year old,	10	5
124.	Mare, over four years old,	20	10
125.	Filly, three years old	20	10
126.	Filly, two years old,	15	8
127.	Filly, one year old,	8	5
128.	Mare, with foal at foot,	30	15

No. 18. *Shetland Ponies.*

Premium Number.		1st Prize.	2nd Prize.	3rd Prize.
129.	Stallion,	\$10	\$8	\$5
130.	Mare,	10	8	5

No. 19. *Harness and Saddle Horses.*

131.	Farm and Draught pair,	\$40	\$25
132.	Coach pair, not less than 16 hands, or 1150 lbs.	40	25
133.	Coupé horse, not less than 16 hands or 1150 lbs.	25	15
134.	Roadster pair,	40	25
135.	Roadster single,	25	15
136.	Saddle horse,	25	15
137.	Ponies, pair, under 13 hands high,	20	15
138.	Pony, single, under 13 hands high,	10	5

No. 20. *Mules.*

139.	Pair of mules, not less than 15½ hands,	\$25	\$15
------	---------------------------------------------------	------	------

ERRATA. Under the head of No. 13, Percherons, No. 81, Stallion, one year old, should be 8½.

Class III.—SHEEP AND SWINE.

Superintendent,—C. MINOT WELD, Boston.

All exhibitors will be charged an entrance fee of one dollar (\$1), [which must be sent with the entry], for each animal entered, without regard to age, one half of which will be refunded upon such animals as have been exhibited in accordance with the Society's rules.

SHEEP.

1. Sheep must in all cases have been evenly and closely shorn, not earlier than the first of April before the Fair, and the date of shearing must be verified by affidavit at the time of entry. If not evenly shorn at shearing time, they will be excluded from competition, and any clipping or trimming, except on head, legs, and belly, will debar from competition.

2. Ewes over two years old, entered for prizes, must have had living lambs the last spring, and suckled lambs for three months during the season. The fact must be certified and evidence furnished if required.

No. 21. Long-Wooled Sheep.

(See Rule 24.)

Premium Number.		1st Prize.	2nd Prize.
140.	Ram, two years old or over, with three lambs of his get,	\$20	\$15
141.	Ram, one year old,	15	10
142.	Ram lamb,	10	5
143.	Pen of three ewes, two years old or over,	20	15
144.	Pen of three yearling ewes,	15	10
145.	Pen of three ewe lambs,	10	5

SPECIAL PRIZES offered by the Massachusetts Society for Promoting Agriculture:—

145.	A. Flock, one ram, five ewes that have had lambs in 1889, and five ewe lambs,	\$40	\$30
------	-----------------------------------------------------------------------------------------	------	------

No. 22. Middle-Wooled Sheep.

A. SOUTH-DOWNS.

146.	Ram, two years old or over, with three lambs of his get,	\$20	\$15
147.	Ram, one year old,	15	10
148.	Ram lamb,	10	5
149.	Pen of three ewes, two years old or over,	20	15
150.	Pen of three yearling ewes,	15	10
151.	Pen of three ewe lambs,	10	5

SPECIAL PRIZES offered by the Massachusetts Society for Promoting Agriculture:—

151.	B. Flock; one ram, five ewes that have had lambs in 1889, and five ewe lambs,	\$40	\$30
------	-----------------------------------------------------------------------------------------	------	------

B. SHROPSHIRE.

152.	Ram, two years old or over, with three lambs of his get,	\$20	\$15
153.	Ram, one year old,	15	10
154.	Ram lamb,	10	5
155.	Pen of three ewes, two years old or over,	20	15
156.	Pen of three yearling ewes,	15	10
157.	Pen of three ewe lambs,	10	5

SPECIAL PRIZES offered by the Massachusetts Society for Promoting Agriculture:—

157.	C. Flock; one ram, five ewes that have had lambs in 1889, and five ewe lambs,	\$40	\$30
------	-----------------------------------------------------------------------------------------	------	------

C. HAMPSHIRE.

Premium Number.		1st Prize.	2nd Prize.
158.	Ram, two years old or over, with three lambs of his get,	\$20	\$15
159.	Ram, one year old,	15	10
160.	Ram lamb,	10	5
161.	Pen of three ewes, two years old or over,	20	15
162.	Pen of three yearling ewes,	15	10
163.	Pen of three ewe lambs,	10	5

SPECIAL PRIZES offered by the Massachusetts Society for Promoting Agriculture:—

163.	D. Flock; one ram, five ewes that have had lambs in 1889, and five ewe lambs,	\$40	\$30
------	-----------------------------------------------------------------------------------------	------	------

D. HORNED DORSET.

164.	Ram, two years old or over, with three lambs of his get,	\$20	\$15
165.	Ram, one year old,	15	10
166.	Ram lamb,	10	5
167.	Pen of three ewes, two years old or over.	20	15
168.	Pen of three yearling ewes,	15	10
169.	Pen of three ewe lambs,	10	5

SPECIAL PRIZES offered by the Massachusetts Society for Promoting Agriculture:—

169 E.	Flock; one ram, five ewes that have had lambs in 1889, and five ewe lambs,	40	30
--------	--------------------------------------------------------------------------------------	----	----

No. 23. Merinos.

A. BRED FOR FINENESS OF WOOL.

170.	Ram, two years old or over, with three lambs of his get,	\$20	\$15
171.	Ram, one year old,	10	5
172.	Ram lamb,	5	3
173.	Pen of three ewes, two years old or over,	15	10
174.	Pen of three yearling ewes,	10	5
175.	Pen of three ewe lambs,	5	3

SPECIAL PRIZES offered by the Massachusetts Society for Promoting Agriculture:—

175 F.	Flock; one ram, five ewes that have had lambs in 1889, and five ewe lambs,	40	30
--------	--------------------------------------------------------------------------------------	----	----

B. BRED FOR LENGTH OF STAPLE.

176.	Ram, two years old or over, with three lambs of his get,	\$20	15
177.	Ram, one year old,	10	5
178.	Ram lamb,	5	3
179.	Pen of three ewes, two years old or over,	15	10
180.	Pen of three yearling ewes,	10	5
181.	Pen of three ewe lambs,	5	3

SPECIAL PRIZES offered by the Massachusetts Society for Promoting Agriculture:—

Premium Number.		1st Prize.	2nd Prize.
181 G.	Flock; one ram, five ewes that have had lambs in 1889, and five ewe lambs,	40	30

No. 24. Fat Sheep.

182.	Pen of four fat wethers, one year old or over,	\$15	\$10
183.	Pen of four fat ewes, one year old or over.	15	10

No. 25. Swine.

Sows with or without pigs to compete together.

LARGE YORKSHIRE.

To weigh not less than 450 pounds at 18 months old.

184.	Boar, over one year old, with 3 of his progeny,	\$20	\$10
185.	Boar, under one year old,	10	8
186.	Sow, over one year old,	15	10
187.	Sow, under one year old,	10	8

MEDIUM YORKSHIRE.

To weigh not less than 300 pounds; nor more than 450 lbs. at 18 months old.

188.	Boar, over one year old, with 3 of his progeny,	\$20	\$10
189.	Boar, under one year old,	10	8
190.	Sow, over one year old,	15	10
191.	Sow, under one year old,	10	8

SMALL YORKSHIRE.

To weigh not more than 300 pounds at 18 months old.

192.	Boar, over one year old,	\$20	\$10
193.	Boar under one year old,	10	8
194.	Sow, over one year old,	15	10
195.	Sow, under one year old,	10	8

CHESTER WHITES.

196.	Boar, over one year old,	\$20	\$10
197.	Boar, under one year old,	10	8
198.	Sow, over one year old,	15	10
199.	Sow, under one year old,	10	8

BERKSHIRE.

200.	Boar, over one year old,	\$20	\$10
201.	Boar under one year old,	10	8
202.	Sow, over one year old,	15	10
203.	Sow, under one year old,	10	8

POLAND CHINA.

204.	Boar, over one year old,	\$20	\$10
205.	Boar, under, one year old,	10	8
206.	Sow, over one year old,	15	10
207.	Sow, under one year old,	10	8

SPECIAL PRIZES offered by the Massachusetts Society for Promoting Agriculture:—

In each of the following classes of Swine—Large Yorkshire, 187, A and B; Medium Yorkshire, 191, C and D; Small Yorkshire, 195, E and F; Berkshire, 199, G and H; Chester Whites, 203, I and K; Poland China, 207, L and M.

Boar, of any age,	\$40	\$30
Sow, of any age,	40	30

Class IV.—POULTRY.

Superintendent.—W. F. BACON, Cambridgeport, Mass.

All exhibitors, will be charged an entrance fee of twenty-five cents (\$.25) for each pair, and fifty cents (\$.50) for each pen entered.

1. Prizes are not to be awarded for birds impaired in value for breeding purposes. Until further orders, the rules of the American Poultry Association shall be the guide in judging.

2. All fowls are to be shown in pairs or in breeding pens; a breeding pen to be one cock or cockerel, and four hens or pullets.

3. Pairs must score for first premium 175, for second premium 165, and for third premium 160 points, or be in the estimation of the judges such as will score so many points when in full feather. Breeding pens must score proportionately.

4. Coops will be furnished, free of charge, for the fowls to be exhibited in, but not for pigeons.

5. Collections of pigeons must consist of not less than five pairs and be shown in one coop or cage. If birds being parts of collections are also to compete for prizes as pairs, they must be marked before leaving home, as under paragraph 38.

6. Entries positively close October 1st.

8. A breeding pen cannot compete for prizes offered on pairs.

No. 26. Poultry, Etc.

Premium Number.		1st Prize.	2d Prize.
208.	Display of Fowls or Chicks,	\$15	\$10
ASIATICS.			
209.	Breeding pen, each variety of Asiatics,	\$5	\$3
210.	Pair light Brahmas,	2	1
211.	Pair dark Brahmas,	2	1
212.	Pair Buff Cochins,	2	1
213.	Pair Patridge Cochins,	2	1
214.	Pair White Cochins,	2	1
215.	Pair Black Cochins,	2	1
216.	Pair Langshans,	2	1
217.	Pair peacomb Patridge Cochins,	2	1

		DORKINGS.	
Premium Number.		1st Prize.	2nd Prize.
218.	Breeding pen, each variety of Dorkings,	\$5	\$3
219.	Pair colored Dorkings,	2	1
220.	Pair silver gray Dorkings,	2	1
221.	Pair white Dorkings,	2	1
		AMERICAN.	
222.	Breeding pen, each American variety,	\$5	\$3
223.	Pair American Dominiques,	2	1
224.	Pair Plymouth Rocks,	2	1
224½.	White Plymouth Rocks,	2	1
225.	Pair Wyandottes,	2	1
225 a.	White Wyandottes,	2	1
225 b.	Gold Laced Wyandottes.	2	1
226.	Pair black Javas,	2	1
227.	Pair mottled Javas,	2	1
		HAMBURGS.	
228.	Breeding pen, each variety,	\$5	\$3
229.	Pair golden spangled Hamburgs,	2	1
230.	Pair silver spangled Hamburgs,	2	1
231.	Pair golden penciled Hamburgs,	2	1
232.	Pair silver penciled Hamburgs,	2	1
233.	Pair black Hamburgs,	2	1
234.	Pair white Hamburgs,	2	1
		SPANISH.	
235.	Breeding pen, each Spanish variety,	\$5	\$3
236.	Pair Black Spanish,	2	1
237.	Pair White Leghorns,	2	1
238.	Pair Brown Leghorns,	2	1
239.	Pair Black Leghorns,	2	1
240.	Pair Andalusians,	2	1
241.	Pair Rose-combed White Leghorns,	2	1
242.	Pair Rose-combed Brown Leghorns,	2	1
		FRENCH.	
243.	Breeding pen, any French variety,	\$5	\$3
244.	Pair Creve Cœurs,	2	1
245.	Pair Houdans,	2	1
246.	Pair La Feche,	2	1
		POLISH.	
247.	Breeding pen, any variety of Polish,	\$5	\$3
248.	Pair White-crested Black Polish,	2	1
249.	Pair White Polish,	2	1
250.	Pair Golden Polish,	2	1
251.	Pair Silver Polish,	2	1
252.	Pair Buff Polish,	2	1
253.	Sultans,	2	1
254.	Silkies,	2	1
255.	Bearded Golden Polish,	2	1

Premium Number.		1st Prize.	2nd Prize.
256.	Bearded Silver Polish,	2	1
257.	Bearded White,	2	1
258.	Bearded Buff Polish,	2	1

GAMES.

259.	Breeding pen, any variety of pure Games,	\$5	\$3
260.	Pair Black-breasted Red Games,	2	1
261.	Pair Brown-breasted Red Games,	2	1
262.	Pair Silver Duckwing Games,	2	1
263.	Pair Yellow Duckwing Games,	2	1
264.	Pair Red Pile Games,	2	1
265.	Pair Black Games,	2	1
266.	Pair White Games,	2	1
267.	Pair Black Sumatras,	2	1

GAME BANTAMS.

268.	Breeding pen, any variety of Game Bantams,	\$5	\$3
269.	Pair Black-breasted Red Game Bantams,	1	.50
270.	Pair Brown-breasted Red Game Bantams,	1	.50
271.	Pair Red Pile Game Bantams,	1	.50
272.	Pair White Game Bantams,	1	.50
273.	Pair Silver Duckwing Game Bantams,	1	.50
274.	Pair Yellow Duckwing Game Bantams,	1	.50
275.	Pair Black Game Bantams,	1	.50

BANTAMS OTHER THAN GAME.

276.	Breeding pen, any variety of Bantams other than Game,	\$5	\$3
277.	Golden Sebright,	1	.50
278.	Silver Sebright,	1	.50
279.	Rose-combed Black,	1	.50
280.	Rose-combed White,	1	.50
281.	Booted White,	1	.50
282.	Japanese,	1	.50
283.	Pekin, or Cochin,	1	.50

TURKEYS, ETC.

284.	Pair Bronze Turkeys,	\$2	\$1
285.	Pair White Turkeys,	2	1
286.	Pair Narragansett Turkeys,	2	1
287.	Pair Buff Turkeys,	2	1

DUCKS.

288.	Pair Rouen Ducks,	\$3	\$2
289.	Pair Aylesbury Ducks,	2	1
290.	Pair Cayuga Ducks,	2	1
291.	Pair White Muscovy Ducks,	2	1
292.	Pair Colored Muscovy Ducks,	2	1
293.	Pair Pekin Ducks,	2	1
294.	Pair Crested White Ducks,	2	1
295.	Pair Call Ducks,	2	1
296.	Pair Black East Indian Ducks,	2	1

Premium Number.		1st Prize.	2nd Prize.
297.	Pair White Call Ducks,	2	1
298.	Pair Gray Call Ducks,	2	1
299.	Pair Wood Ducks,	2	1
300.	Pair Mandarin Ducks,	2	1

ORNAMENTAL FOWLS.

301.	Pair Pearl Guinea Fowls,	\$2	\$1
302.	Pair White Guinea Fowls,	2	1
303.	Pair Pea Fowls,	2	1
304.	Pair White Pea Fowls,	2	1
305.	Pair Golden Pheasants,	2	1
306.	Pair Silver Pheasants,	2	1
307.	Pair English Pheasants,	2	1
308.	Pen of Partridges, not less than five pairs,	2	1
309.	Pen of Quail, not less than five pairs,	2	1

PIGEONS.

All exhibitors will be charged an entrance fee of ten cents for each pair of pigeons entered.

310.	Pair Black Carriers,	\$1	\$0.50
311.	Pair Dun Carriers,	1	.50
312.	Pair any other carriers—all compete together,	1	.50
313.	Pair Black Pied Pouters,	1	.50
314.	Pair Blue Pied Pouters,	1	.50
315.	Pair White Pouters,	1	.50
316.	Pair any other Pouters—all compete together,	1	.50
317.	Pair Black Barbs,	1	.50
318.	Pair Red Barbs,	1	.50
319.	Pair Yellow Barbs,	1	.50
320.	Pair Dnn Barbs,	1	.50
321.	Pair White Barbs,	1	.50
322.	Pair White Fantails—S. H.	1	.50
323.	Pair Black Fantails—S. H.	1	.50
324.	Pair Blue Fantails—S. H.	1	.50
325.	Pair Red Fantails—S. H.	1	.50
326.	Pair Yellow Fantails—S. H.	1	.50
327.	Pair Dun Fantails—S. H.	1	.50
328.	Pair White Fantails—Crested,	1	.50
329.	Pair Black Fantails—Crested,	1	.50
330.	Pair Blue Fantails—Crested,	1	.50
331.	Pair Red Fantails—Crested	1	.50
332.	Pair Yellow Fantails—Crested,	1	.50
333.	Pair Dun Fantails—Crested,	1	.50
334.	Pair Black English Owls,	1	.50
335.	Pair Blue English Owls,	1	.50
336.	Pair Silver English Owls,	1	.50
337.	Pair White English Owls,	1	.50
338.	Pair Red English Owls,	1	.50
339.	Pair Yellow English Owls,	1	.50
340.	Pair Dun English Owls,	1	.50
341.	Pair Black African Owls,	1	.50
342.	Pair Blue African Owls,	1	.50
343.	Pair Silver African Owls,	1	.50

Premium Number.		1st Prize.	2nd Prize.
344.	Pair White African Owls,	1	.50
345.	Pair Red African Owls,	1	.50
346.	Pair Yellow African Owls,	1	.50
347.	Pair Dun African Owls,	1	.50
348.	Pair Black Turbits,	1	.50
349.	Pair Blue Turbits,	1	.50
350.	Pair Silver Turbits,	1	.50
351.	Pair White Turbits,	1	.50
352.	Pair Yellow Turbits,	1	.50
353.	Pair Black-winged Turbits,	1	.50
354.	Pair Blue-winged Turbits,	1	.50
355.	Pair Silver-winged Turbits,	1	.50
356.	Pair Red-winged Turbits,	1	.50
357.	Pair Yellow-winged Turbits,	1	.50
358.	Pair Black-tailed winged Turbits,	1	.50
359.	Pair Blue-tailed winged Turbits,	1	.50
360.	Pair Black Jacobins,	1	.50
361.	Pair Blue Jacobins,	1	.50
362.	Pair Red Jacobins,	1	.50
363.	Pair Yellow Jacobins,	1	.50
364.	Pair Dun Jacobins,	1	.50
365.	Pair White Jacobins,	1	.50
366.	Pair Pigmy Pouters—all colors compete together,	1	.50
367.	Pair Black Trumpeters,	1	.50
368.	Pair Dun Trumpeters,	1	.50
369.	Pair Red Trumpeters,	1	.50
370.	Pair Yellow Trumpeters,	1	.50
371.	Pair White Trumpeters,	1	.50
372.	Pair Black Mottled Trumpeters,	1	.50
373.	Pair Black Swallows,	1	.50
374.	Pair Blue Swallows,	1	.50
375.	Pair Red Swallows,	1	.50
376.	Pair Yellow Swallows,	1	.50
377.	Pair Black Magpies, capped and smooth-heads— compete together,	1	.50
378.	Pair Blue Magpies, capped and smooth-heads— compete together.	1	.50
379.	Pair Red Magpies, capped and smooth-heads— compete together.	1	.50
380.	Pair Yellow Magpies, capped and smooth-heads— compete together,	1	.50
381.	Pair Almond Short-faced Tumblers,	1	.50
382.	Pair Red or Yellow Agate Mottled Short-faced Tumblers,	1	.50
383.	Pair Red or Yellow Self Colored Short-faced Tumblers.	1	.50
384.	Pair Black Baldhead Tumblers,	1	.50
385.	Pair Blue Baldhead Tumblers,	1	.50
386.	Pair any other Baldhead Tumblers—all compete together,	1	.50
387.	Pair Black Beard Tumblers,	1	.50
388.	Pair Blue Beard Tumblers,	1	.50
389.	Pair any other Beard Tumblers—all compete together,	1	.50

Premium Number.		1st Prize.	2nd Prize.
390.	Pair Tumblers Inside—all colors compete together.	1	.50
391.	Pair Black Nuns,	1	.50
392.	Pair Red Nuns,	1	.50
393.	Pair Yellow Nuns.	1	.50
394.	Pair Priests—all colors compete together,	1	.50
395.	Pair Black Dragoons,	1	.50
396.	Pair Blue Dragoons,	1	.50
397.	Pair any other Dragoons—all three colors compete together,	1	.50
397½.	Pair Antwerps, all colors compete together,	1	.50
398.	Pair Runts—all colors compete together	1	.50
399.	Pair Helmets—all colors compete together,	1	.50
400.	Pair Archangels,	1	.50
401.	Pair Ice Pigeons,	1	.50
402.	Best five pairs Pouters,	2	
403.	Best five pairs Jacobins,	2	
404.	Best five pairs Owls,	2	
405.	Best five pairs Trumpeters,	2	
406.	Best five pairs Turbits,	2	
407.	Best five pairs Fantails,	2	

HATCHING APPARATUS.

408.	Artificial Mother or Brooder,	\$10	\$5
409.	Model, not exceeding 24 inches long, of house for artificial rearing of chickens, with ground plan and statement of points of merit,	5	3
410.	Incubator hatching the largest percentage of chickens during the Exhibition,	15	10

Class V.

IMPLEMENTS AND MACHINES.

Superintendent.—W. W. RAWSON, Arlington.

Owing to the limited space for this Department, the Committee of Arrangements reserve to themselves full powers to invite the display of such implements and machines as in their judgment seem desirable; and also full power to disregard, or reject, any or all offers of exhibits and application for space in this Department.

All exhibits in this Department must be put in place, and taken out of the Building within three days after the close of the Show, by and at the expense of the Exhibitors.

Certificates of merit will be awarded to such articles as may be deemed to be deserving of approval or commendation.

Class VI.

GRAIN AND VEGETABLES.

Superintendent.—CHARLES N. BRACKETT, Newton.

All articles for competition and exhibition must be ready for examination by the Judges at 6 P. M. on Monday, October 7.

All exhibitors will be charged an entrance fee of one dollar (\$1.), which must accompany the entry. Exhibitors will place their exhibits on the tables in the places assigned by the Superintendent, or his authorized assistant.

The General Rules and Regulations given under Class VIII, Fruits and Flowers, will apply to Grain and Vegetables.

No. 27. Grain, Seeds, &c., grown in 1889.

Premium Number.	1st Prize.	2nd Prize.	3d Prize.
411. White winter Wheat, one peck, . . .	\$3	\$2	
412. Red Winter Wheat, one peck, . . .	3	2	
413. Spring Wheat, one peck, . . .	3	2	
414. Winter Rye, one peck, . . .	3	2	
415. Spring Rye, one peck, . . .	3	2	
416. White Oats, one peck, . . .	3	2	
417. Black or Gray Oats, one peck, . . .	3	2	
418. Winter Barley, one peck, . . .	3	2	
419. Two-rowed Spring Barley, one peck, . . .	3	2	
420. Four-rowed Spring Barley, one peck, . . .	3	2	
421. Buckwheat, one peck, . . .	3	2	
422. Twenty Seed Ears Yellow Corn, . . .	3	2	\$1
423. Twenty Seed Ears Early Sweet Corn, . . .	3	2	1
424. Twenty Seed Ears Late Sweet Corn, . . .	3	2	1
425. Hops, 1 bale of 100 lbs. or over, . . .	3	2	1

No. 28. Vegetables.

No Entry to Compete in Two Places.

426. Best Display of Grain, Vegetables and Fruits (Individuals, Granges, and Farmers' Clubs are invited to compete), . . .	\$50	\$25	\$10
427. Best Collection of Vegetables, 1st prem. \$25, 2nd prem. \$15, 3rd prem. \$10, 4th prem. \$5.			
428. Beets, Turnip Rooted, twelve specimens, . . .	3	2	1
429. Carrots, Long Orange, twelve specimens, . . .	3	2	1
430. Carrots, Intermediate, twelve specimens, . . .	3	2	1
431. Parsnips, Long, twelve specimens, . . .	3	2	1
431½. Parsnips, Intermediate, twelve specimens, . . .	3	2	1

POTATOES.

432.	Collection of not less than ten varieties, twelve specimens each,	\$10	\$5	
433.	Early Rose, twelve specimens,	3	2	1
434.	Clark's No. 1, twelve specimens,	3	2	1
435.	Beauty of Hebron, twelve specimens,	3	2	1
436.	Pearl of Savoy, twelve specimens,	3	2	1
437.	Essex, twelve specimens,	3	2	1
438.	Hampden Beauty, twelve specimens,	3	2	1
439.	All other varieties compete together, twelve specimens each,	3	2	1
440.	Sweet, twelve specimens each,	3	2	1
441.	EGG PLANT, four specimens,	5	3	1

CABBAGES.

442.	Collection of not less than five varieties, three specimens each,	\$10	\$5	
443.	Stone Mason, three specimens,	3	2	\$1
444.	Brunswick, three specimens,	3	2	1
445.	Curled Savoy, three specimens,	3	2	1
446.	Drumhead Savoy, three specimens,	3	2	1
447.	Red, three specimens,	3	2	1

CELERY.

448.	Boston Market, best kept during Exhibition, four roots,	\$10	\$5	
449.	Any variety, best kept during Exhibition, four roots,	10	5	
450.	Arlington, best kept during Exhibition,	10	5	
451.	Boston Market, four roots,	5	3	\$1
452.	Arlington, four roots,	5	3	1
453.	White Plume, four roots,	5	3	1
454.	Any other varieties compete together, four roots,	5	3	1

CAULIFLOWERS.

455.	Collection of not less than three varieties, four specimens each,	\$10	\$5	
456.	Henderson's Snow Ball, four specimens,	5	3	\$1
457.	Erfurt, four specimens,	5	3	1
458.	All other varieties compete together, four specimens,	5	3	1

ONIONS.

459.	Collection of not less than three varieties, twelve specimens each,	\$5	\$3	
460.	Danvers Yellow, twelve specimens,	3	2	\$1
461.	Portugal, twelve specimens,	3	2	1
462.	Red, twelve specimens,	3	2	1

MELONS.

463.	Montreal, three specimens,	\$3	\$2	\$1
464.	Hackensack, twelve specimens,	3	2	1
465.	Long Musk, three specimens,	3	2	1
466.	Water, three specimens,	3	2	1

TURNIPS.

Premium Number.		1st Prize.	2nd Prize.	3rd Prize.
467.	Flat, twelve specimens,	\$3	\$2	\$1
468.	Swedish, twelve specimens,	3	2	1
469.	SALSIFY, twelve specimens each,	3	2	1

TOMATOES.

470.	Collection of not less than ten varieties, twelve specimens,	\$5	\$3	
471.	Acme, twelve specimens,	3	2	\$1
472.	New Beauty, twelve specimens,	3	2	1
473.	Emery, twelve specimens,	3	2	1
474.	Essex Hybrid, twelve specimens,	3	2	1
475.	Perfection, twelve specimens,	3	2	1
476.	Puritan, twelve specimens,	3	2	1
477.	Any other varieties compete together, four specimens,	3	2	1
478.	ENDIVE, four specimens,	3	2	
479.	MARTYNIA, twenty-four specimens,	3	2	
480.	OKRA, twenty-four specimens,	3	2	
481.	HORSE RADISH, four specimens,	3	2	
482.	BEANS, Large Lima, two quarts,	3	2	
483.	BEANS, Small Lima, two quarts,	3	2	
484.	CORN, Sweet, twelve ears,	3	2	
485.	PEPPERS, twenty-four specimens,	3	2	1
485½.	PICKLES, twenty-four specimens,	3	2	1

SQUASHES.

486.	Marrow, three specimens,	\$3	\$2	\$1
487.	Hubbard, three specimens,	3	2	1
488.	Sibly, or Pike's Peak, three specimens,	3	2	1
489.	Marblehead, three specimens,	3	2	1
490.	Turban, three specimens,	3	2	1
491.	Hybrid, three specimens,	3	2	1
492.	Bay State, three specimens,	3	2	1
493.	Largest Squash, one specimen,	3	2	1
494.	PUMPKINS, three specimens,	3	2	1
495.	LETTUCE, any variety, four heads,	3	1	
496.	PARSLEY, one peck,	3	1	
497.	MUSHROOMS, shown on plate,	2	1	
498.	CUCUMBERS, pair,	2	1	
499.	RADISHES, four bunches,	2	1	

There is also placed at the disposal of the Judges, to be awarded as Gratuities to any novelties which in their judgment are worthy, \$30.

CLASS VII.—DAIRY.

Superintendent.—N. B. DOUGLAS, Sherborn.

All exhibitors will be charged an entrance fee of one dollar (\$1.), which must accompany the entry.

No. 29. Butter.

Entries of Butter, Cheese, Bread, and Bees and Honey close October 1st.

Persons making entries for these Butter Prizes are required to furnish full statements, in writing, as to the kind and treatment of the cows from which the butter was made, and full particulars as to the method of making the butter. Such statements must be sent to the Secretary at the time when the entry is made. No prizes will be awarded when this rule is not followed. Only one prize will be given under any butter class to any one Exhibitor.

Premium Number.		1st Prize.	2nd Prize.	3rd Prize.
500.	Best collection; box of not less than five pounds, five pounds of prints, and two pounds of granulated butter; the highest score to be the test,	The Society's Gold Medal.		
501.	Five packages, not less than 30 lbs. each net, made at the same dairy, creamery or factory, at any time,	\$30	\$20	
502.	Package, not less than 30 lbs. net, made anywhere and prior to July, 1889,	20	10	\$5
503.	Package, not less than 30 lbs. net, made at any time, at a creamery or factory,	20	10	5
504.	Package, not less than 30 lbs. net, made at any time, at a private farm or dairy,	20	10	5
505.	Package, not less than five pounds, nor over 10 lbs. net, in form for delivery unbroken to consumer,	15	10	5
506.	Sample, not less than 3 lbs., in prints, moulds or rolls, made at a creamery or factory,	15	10	5
507.	Sample, not less than 3 lbs., in prints, moulds or rolls, made at a private farm or dairy,	15	10	5
508.	Sample of granular butter, shown in brine in a glass jar, not less than 2 lbs.	15	10	5

No. 30. Cheese.

Similar statements to those required for Butter exhibited must accompany the entries for Cheese, to include the method of manufacture and preparation of the rennet.

Cheese will be judged upon a scale of points, and in the class of Five Cheeses, uniformity in size, shape, color and flavor, in the respective entries, will be considered points of merit.

Premium Number.		1st Prize.	2nd Prize.
509.	Five Cheeses, not less than 20 lbs. each, made at any time, from the same factory or dairy,	\$25	\$15

Premium Number.		1st Prize.	2nd Prize.
510.	American Cheese of the usual shape and character, not less than 20 lbs. weight, over one year old,	20	10
511.	American Cheese, of the usual shape and character, not less than 20 lbs. weight, less than one year old,	20	10

The Judges may also award, not exceeding \$25 to exhibitors of fancy styles, or new kinds of cheese, if the exhibits are found worthy.

No. 31. Bread.

512.	Wheat Bread of fine flour,	\$5	\$3	\$2
513.	Unbolted Wheat, or Graham, Bread,	5	3	2
514.	Rye Bread,	5	3	2
515.	Indian, or Rye and Indian, Bread,	5	3	2

No. 32. Bees and Honey.

516.	Italian Bees, in observatory hive,	\$5	\$3
517.	Black Bees, in observatory hive,	5	3
518.	Frame with queen cells, as built by the bees, and shown with the bees in an observatory hive,	5	3
519.	Comb honey, white clover or linden, not less than 20 lbs.	5	3
520.	Comb Honey, fall flowers, not less than 20 lbs.	5	3
521.	Extracted Honey, not less than 20 lbs.	5	3

As to bees, regard to be had to quality of queens and bees. As to honey, both quality and style of packages to be considered.

522.	Beeswax—20 lb. lots,	5	3
523.	Best Movable Comb Hive, with implements connected with the apiary,	5	3

Class VIII.

FLOWERS AND FRUITS.

Superintendent.—E. W. WOOD, Newton.

Entries in this class close Monday, Oct. 7th, at 6 o'clock. P. M.

No. 33. Plants and Flowers.

 All articles for competition and exhibition must be ready for examination by the Judges at 6 P. M., on Monday, Oct. 7th.

All exhibitors will be charged an entrance fee of one dollar (\$1.), which must accompany the entry.

Each Exhibitor to place his Exhibits upon the tables in the places assigned by the Superintendent, or his authorized assistant.

General Rules and Regulations.

1. All Flowers and Fruits offered for Prizes, must have their names annexed, and must have been grown by the competitors. Specimens offered for exhibition by others than the growers, must in all cases have the names of the growers affixed, if known.
2. Where a certain number or quantity of Plants, Flowers and Fruits is designated in the Schedule, there must be neither more nor less than that number or quantity of specimens shown; and in no case can any other varieties than those named in the schedule be in the stand.
3. When only one prize is offered for any article, only a single specimen or collection can be shown by one person; but when a second, third, or fourth prize is offered, two, three or four specimens or collections may be exhibited, but no variety can be duplicated.
4. All persons exhibiting Plants, Flowers and Fruits, *who desire reports of the same*, must hand lists to the Superintendent of this Class.
5. After the articles are arranged, they will be under the exclusive charge of the Superintendent, and *not even the owners* will have liberty to *remove* or *touch* them, until the exhibition is closed, when they will be delivered as the contributors may direct.
6. No Flowers or Fruits will be entitled to a prize unless they possess points of superiority.
7. Competitors will be required to furnish information as to their modes of cultivation, and to present specimens for trial and examination if necessary.
8. No cards of a business nature will be allowed in any exhibition.
9. In awarding Premiums for Fruits, adaptation to general Cultivation will be deemed indispensable.
10. Attention is called to the Special Rules for Flowers and Fruits, and all articles not offered in conformity to the Rules will be disqualified, and Prizes will be awarded only to exhibitors who have complied with the Rules and Regulations.
11. It is understood that all persons placing any article in any exhibition thereby signify their assent to all the Rules and Regulations, General and Special.

Special Rules for Flowers and Plants.

1. All named varieties of Plants and Flowers exhibited for premiums, must have the name *legibly* and correctly written on stiff card, wood, or some other permanent substance; and each separate plant or flower must have its name attached, also have the number of the prizes for which they are offered.

2. Plants in Pots, to be entitled to Prizes, must evince skilful culture in the profusion of bloom, and the beauty, symmetry and vigor of the specimens.

3. No person can compete for any Prize for a single specimen, with a variety shown in a collection.

4. When Prizes are offered for the same flower in different classes, any person may exhibit in more than one class, but no variety can be duplicated.

5. All exhibitors, not strictly complying with the above rules, will be excluded from competition for Premium.

Special Rules for Fruits.

1. All Fruits offered for Premiums must be correctly named. Indefinite appellations, such as "Pippin," "Sweeting," "Greening," will not be considered as names.

2. All Fruits offered for Premiums must be composed of exactly the number of specimens or quantity named in the Schedule. A "dish" of Apples, Pears, Peaches, Plums, Nectarines, Quinces, Figs, Apricots, etc., is understood to contain twelve specimens, and this number will be required of all Fruits when not otherwise specified.

3. The whole quantity required of any one variety of Fruit must be shown in a single dish or basket.

4. Contributors of Fruits for Exhibition or Prizes, must present the same in the Society's dishes. Market baskets will not be allowed on the tables.

5. No person can compete for more than one Prize with the same variety or varieties of Fruit; except that a single dish may be of the same variety,—but not the same specimens,—as one of a collection.

6. Grapes grown on girdled vines cannot compete for a Premium.

7. All Fruits offered for Prizes, except when otherwise stated, and those for foreign Grapes, must be of out-door culture.

8. The Fruit Judges, in making their awards, will consider the flavor, beauty and size of the specimens, comparing

each of these properties with a fair standard of the variety. The adaptation of the variety to general cultivation will also be taken into account. Other things being equal, specimens most nearly in perfection, as regards ripeness, will have the preference.

FLOWERS AND PLANTS.

Entries in this class close Monday, Oct. 7th, at 6 o'clock, P. M.

Premium Number.		1st Prize.	2nd Prize.	3rd Prize.
524.	Evergreen Trees and Shrubs.—Display in pots of other than Native Evergreens of New England, named, three prizes.	\$10	\$8	\$6

PLANTS IN POTS.

525.	Greenhouse Plants.—Six greenhouse and stove plants, of different named varieties, one Croton admissible, four prizes.	\$30	\$25	\$20	\$15
526.	Specimen Flowering Plants.—Three named varieties, in bloom, three prizes.	\$10	\$8	\$6	
527.	Single named specimen, three prizes.	5	4	3	
528.	Variegated Leaved Plants.—Six named varieties, not offered in the collection of greenhouse plants, Crotons and Dracenas not admissible, three prizes.	12	10	8	
529.	Single specimen, named, not offered in any collection, three prizes.	5	4	3	
530.	Caladiums.—Four named varieties, two prizes.		5	4	
531.	Ferns.—Six named varieties, no Adiantums admissible, three prizes.	8	6	4	
532.	Adiantums.—Six named varieties, three prizes.	6	4	3	
533.	Tree Fern.—Single specimen, named, two prizes.		6	4	
534.	Lycopods.—Four named varieties, two prizes.		3	2	
535.	Dracenas.—Six named varieties, two prizes.		8	6	
536.	Crotons.—Six named varieties, in not exceeding six-inch pots, three prizes.	6	4	3	
537.	Palm.—Single specimen, named, two prizes.		6	5	
538.	Nepenthes.—Three plants, named, two prizes.		6	5	
539.	Succulents.—Collection of twelve named species and varieties, two prizes.		4	3	
540.	Orchids.—Six plants, named varieties, in bloom, three prizes.	12	10	8	
541.	Three plants, named varieties, in bloom, three prizes.	8	6	5	
542.	Single plant in bloom, four prizes.	\$5	4	3	2

CUT FLOWERS.

Premium Number.		1st Prize.	2nd Prize.	3d Prize.
543.	Gladioli.—Best display, and best kept during exhibition, of named or unnamed varieties, filling one hundred bottles, two prizes,		8	6
544.	Dahlias.—To be examined by the Judges each day of the exhibition, the prizes to be awarded on the last day. Twelve named varieties, three prizes,	4	3	2
545.	Six named varieties, three prizes,	3	2	1
546.	Three named varieties, two prizes,		2	1
547.	Lilliputian Dahlias.—General display, filling twenty-five bottles, three prizes,	3	2	1
548.	Cut Flowers.—Best display, and best kept during the exhibition, filling one hundred and fifty bottles, five prizes,	\$12	\$10	8 6 4
549.	Baskets, Vases and Designs of Flowers.—Best arranged, and best kept through the exhibition, six prizes,	\$8	7 6 5 4 3	
549 A.	Best plantation of Trees grown for ship timber in Massachusetts,		\$10	

No. 34. Fruits.

All exhibitors will be charged an entrance fee of one dollar (\$1), which must accompany the entry.

Entries in this class close Monday, Oct. 7th at 6 o'clock P. M.

See Special Rules for Fruits, Nos. 2, 3 and 4.

550.	Collection of Apples, Pears, Grapes and other fruits; no duplicate plates of any variety allowed,	\$50	\$30	\$20
------	---------------------------------------------------------------------------------------------------	------	------	------

FOREIGN GRAPES.

Premium Number.		1st Prize.	2nd Prize.	3rd Prize.	4th Prize.
551.	Heaviest and Best-ripened Bunch of any Foreign Black Grape, not less than five pounds,	\$8			
552.	Heaviest and Best-ripened Bunch of any Foreign White Grape, not less than five pounds,	8			

APPLES.

553.	Baldwin,	\$4	\$3	\$2
554.	Danvers Sweet,	3	2	1
555.	Dutch Codlin,	2	1	
556.	Fall Orange, or Holden,	3	2	1
557.	Fameuse,	3	2	1
558.	Foundling,	4	3	2
559.	Garden Royal,	3	2	1
560.	Golden Russet,	2	1	
561.	Gravenstein,	4	3	2
562.	Hubbardston,	4	3	2

Premium Number.		1st Prize.	2nd Prize.	3rd Prize.	4th Prize.
563.	Hunt Russet,	3	2	1	
564.	Lady's Sweet,	2	1		
565.	Leicester,	2	1		
566.	Maiden's Blush,	2	1		
567.	Mother,	3	2	1	
568.	Northern Spy,	3	2	1	
569.	Porter,	3	2	1	
570.	Pumpkin Sweet,	2	1		
571.	Rhode Island Greening,	4	3	2	
572.	Roxbury Russet,	4	3	2	
573.	Tolman's Sweet,	3	2	1	
574.	Tompkins King,	3	2	1	
575.	Washington Royal, or Palmer,	3	2		
576.	Washington Strawberry,	2	1		
577.	Any other variety,	3	2	1	

CRAB APPLES.

578.	Hyslop, twenty-four specimens,	\$2	\$1		
579.	Transcendent, twenty-four specimens,	2	1		

PEARS.

580.	Angouleme,	\$4	\$3	\$2	
581.	Anjou,	4	3	2	1
582.	Bartlett,	4	3	2	1
583.	Belle Lucrative,	3	2	1	
584.	Bosc,	4	3	2	1
585.	Boussock,	3	2	1	
586.	Clairgeau,	3	2	1	
587.	Comice,	3	2	1	
588.	Dana's Hovey,	4	3	2	
589.	Diel,	3	2	1	
590.	Goodale,	3	2	1	
591.	Hardy,	3	2	1	
592.	Howell,	3	2	1	
593.	Lawrence,	3	2	1	
594.	Louise Bonne of Jersey,	3	2	1	
595.	Marie Louise,	3	2	1	
596.	Merriam,	3	2	1	
597.	Onondaga,	3	2	1	
598.	Paradise of Autumn,	3	2	1	
599.	Seckel,	4	3	2	
600.	Sheldon,	4	3	2	
601.	Souvenir du Congrès,	3	2	1	
602.	St. Michael Archangel,	3	2	1	
603.	Superfin,	3	2	1	
604.	Urbaniste,	3	2	1	
605.	Vicar,	3	2	1	
606.	Winter Nelis,	3	2	1	
607.	Any other variety,	3	2	1	

PEACHES.

608.	Coolidge's Favorite,	\$3	\$2	\$1	
609.	Crawford's Early,	3	2	1	

Premium Number.	1st Prize.	2nd Prize.	3rd Prize.	4th Prize.
610. Foster,	3	2	1	
611. Old Mixon Freestone,	3	2	1	
612. Stump the world,	3	2	1	
613. Any other variety,	3	2	1	
614. Orchard House Culture, any variety of Peaches,	4	3		
615. NECTARINES, any variety,	2	1		
616. PLUMS, not less than four varieties,	5	4	3	
617. PLUMS, any one variety,	3	2	1	

NATIVE GRAPES.

618. Six bunches of Brighton,	\$3	\$2	\$1	
619. Six bunches of Concord,	3	2	1	
620. Six bunches of Cottage,	3	2	1	
621. Six bunches of Delaware,	3	2	1	
622. Six bunches of Massasoit,	3	2	1	
623. Six bunches of Moore's Early,	3	2	1	
624. Six bunches of Wilder,	3	2	1	
625. Six bunches of Worden,	3	2	1	
626. Six bunches of Hayes,	3	2	1	
627. Six bunches of any other varieties,	3	2	1	

FOREIGN GRAPES.

628. Four varieties, two bunches each,	\$10	\$8	\$6	\$4
629. Two bunches Black Hamburg,	5	4	3	
630. Two bunches Wilmot's Hamburg,	5	4	3	
631. Two bunches Muscat of Alexandria,	5	4	3	
632. Two bunches of any other variety,	5	4	3	

CRANBERRIES.

633. Half-peck,	3	2	1	
---------------------------	---	---	---	--

Class IX.

DOMESTIC MANUFACTURES.

Superintendent.—W. L. WARNER, Sunderland.

Exhibitors will be charged an entrance fee of one dollar (\$1) which must accompany the entry.

Entries in this class close Monday, Oct. 7th, at 12 o'clock M.

The sum of Fifty Dollars in hands of Committee to pay premiums on articles not mentioned in the above class.

The Committee may reject any articles they may think unworthy of premium.

No. 35.

634. Largest and best display of Needlework made and exhibited by one person,	\$10	\$8	\$4	
635. Best Embroidered Portière,	4	3	2	
636. Best Embroidered Piano Cover,	5	4	3	

637.	Best Embroidered Table Cover,	4	3	2
638.	Best Silk Bed Spread,	5	4	3
639.	Best Embroidered Screen,	3	2	1
640.	Best Embroidered Sofa Pillow,	3	2	1
641.	Best Embroidered Mantle Lambrequin,	3	2	1
642.	Best Specimen Applique,	3	2	1
643.	Best Large Afghan,	5	4	3
644.	Best Specimen Linen drawn work,	3	2	1
645.	Best Display Silk Embroidery,	3	2	1
646.	Best Chair Back,	2	1	
647.	Best Embroidered Infant's Skirt,	2	1	
648.	Best Embroidered Child's Dress,	2	1	
649.	Best Embroidered Toilet Set,	2	1	
650.	Best Hand-knit Ladies' Skirt,	2	1	
651.	Best Crochet Ladies' Skirt,	2	1	
652.	Best Cotton Patch-work Quilt,	2	1	
653.	Best Patch-work Quilt by child 12 years old,	2	1	
654.	Best Silk Knit Hose,	2	1	
655.	Best Hand-knit Bed Spread,	3	2	1
656.	Best Hand-made Silk Rug,	3	2	1
657.	Best Home-made Worsted Rug,	3	2	1
658.	Best Hand-made Yarn Rug,	3	2	1
659.	Best Home-made Drawn Rug,	3	2	1
660.	Best Six Pairs Home-made Woolen Hose,	2	1	
661.	Best Five Yards Home-made Woolen Carpet,	2	1	
662.	Best Five Yards Rag Carpet,	2	1	

PAINTINGS, ETC.

663.	Best Oil Painting, Landscape,	5	4	3
664.	Best Oil Painting, Flowers,	5	4	3
665.	Best Oil Painting, Fruit,	5	4	3
666.	Best Oil Painting, Animals,	5	4	3
667.	Best Water Colors,	4	3	2
668.	Best Painting on Silk,	3	2	1
669.	Best Painted Screen,	4	3	2
670.	Best Specimens of Pencil or Crayon Drawings by pupils of common schools,	3	2	1
671.	Double Farm Harness,		4	3
672.	Single Farm Harness,		3	2
673.	Single Cart Harness,		3	2
674.	Double Coach Harness,		4	3
675.	Single Coupé Harness,		3	2
676.	Light Double Harness,		4	3
677.	Light Single Harness,		3	2
678.	Single Russet Leather Harness,		3	2
679.	Men's Saddle and Bridle,		3	2
680.	Side Saddle and Bridle,		3	2
681.	Horse Clothing, sets of heavy weight for stable use,		3	2
682.	Horse Clothing, sets of light weight for stable use,		3	2
683.	Horse Blankets, for farm use, serviceability and cheapness considered,	2	1	.50

