

3 1761 06706054 1

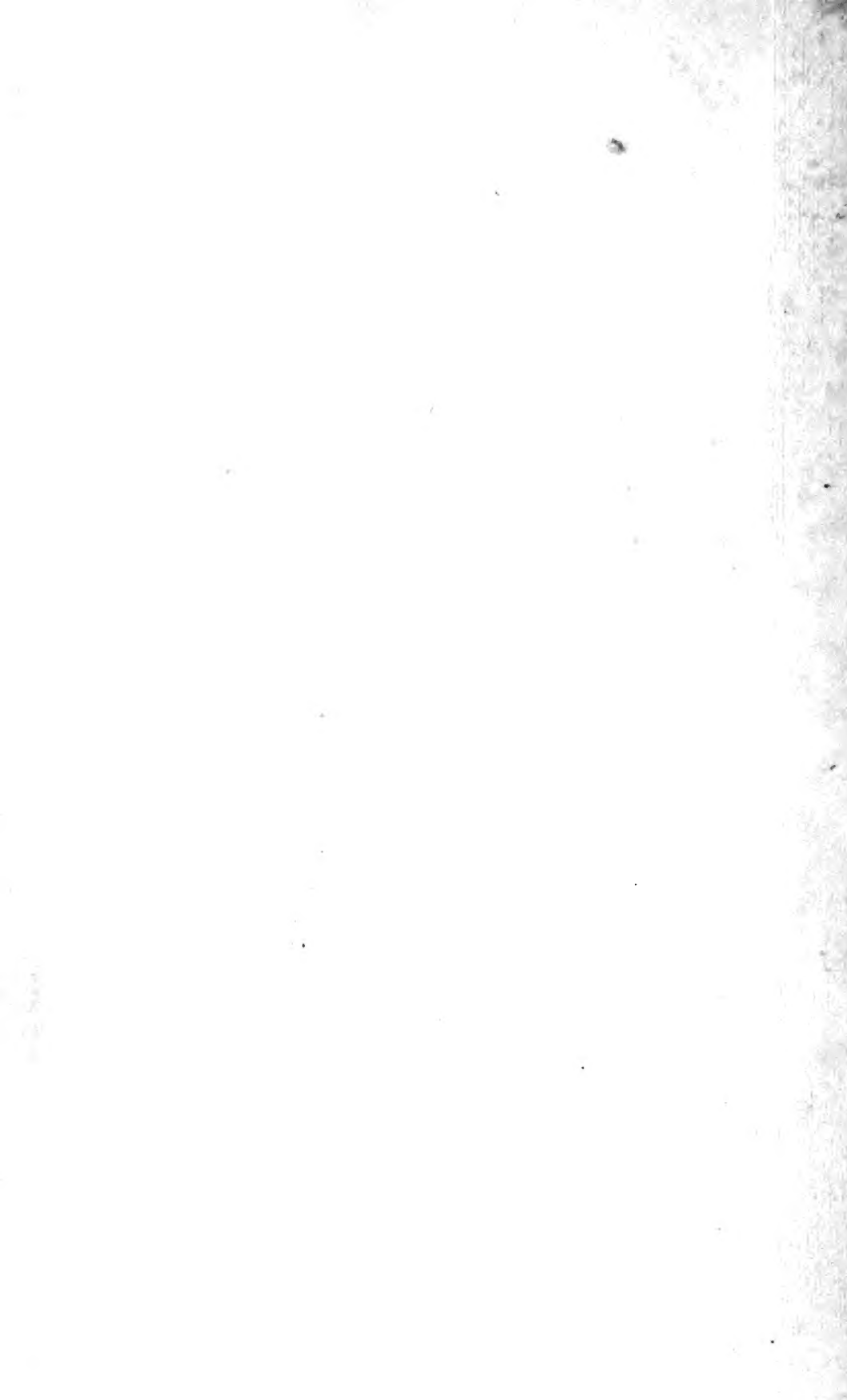

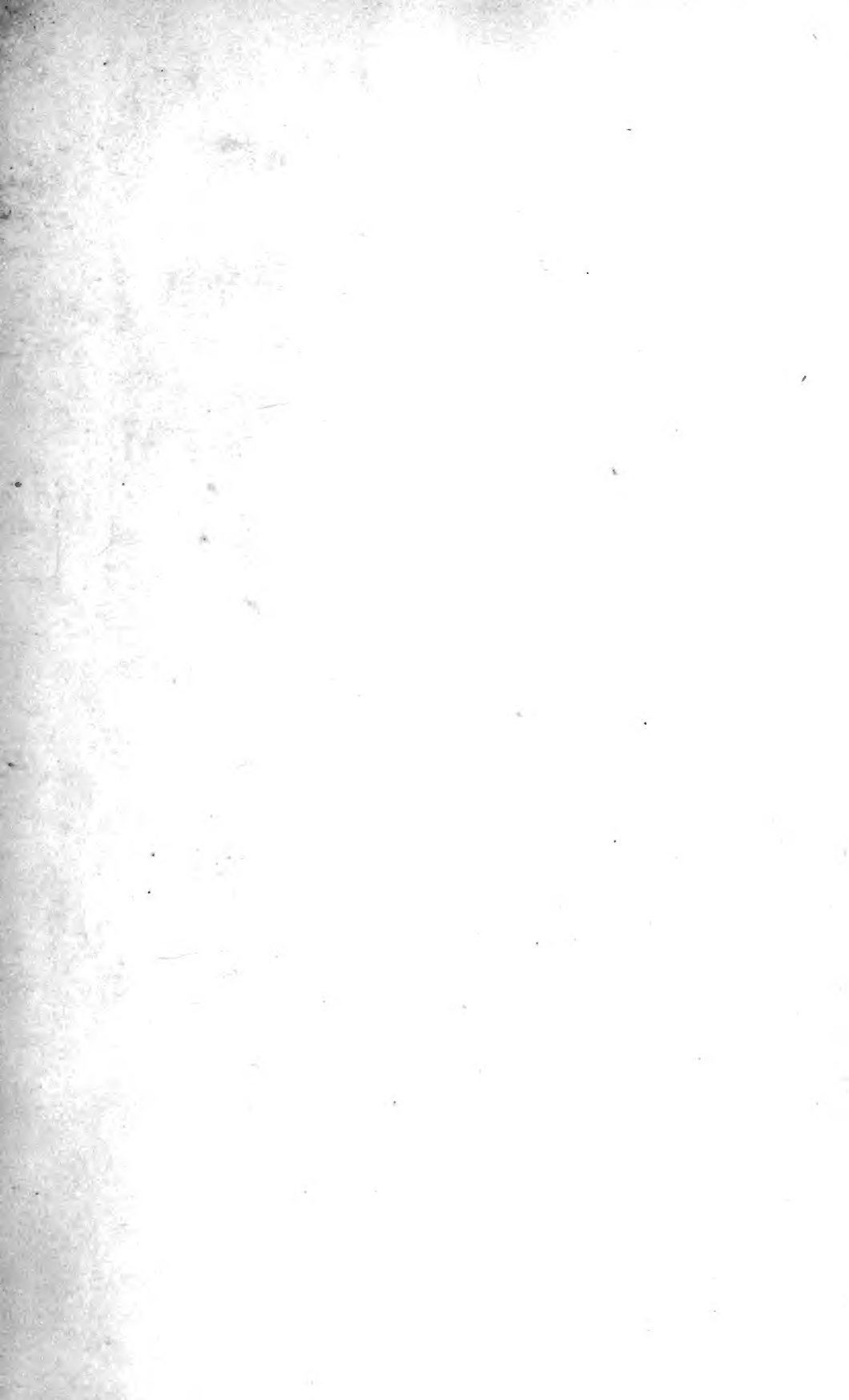

Digitized by the Internet Archive
in 2007 with funding from
Microsoft Corporation



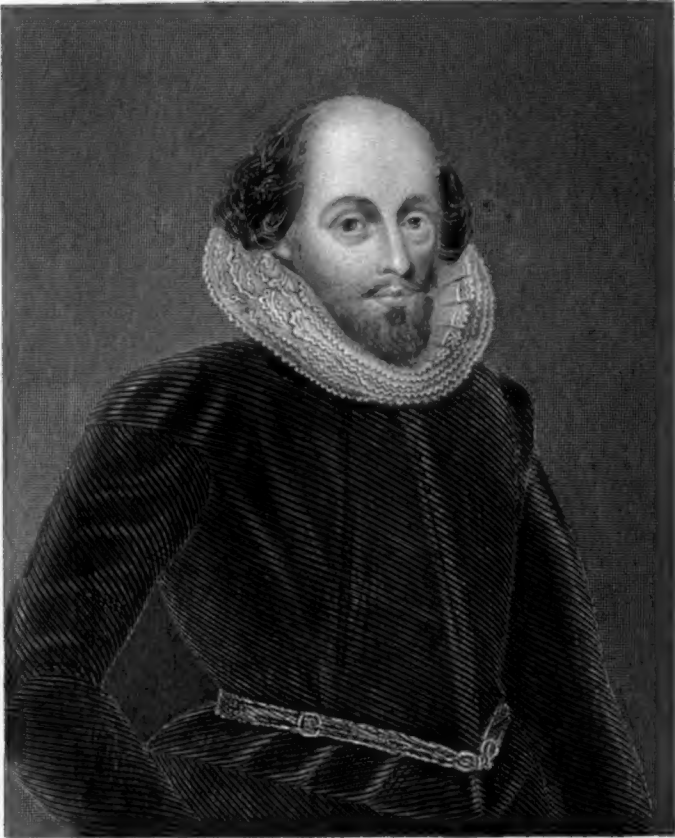

W. Shakespeare
1616

S.D
C4457



CHAMBERS'S ENCYCLOPÆDIA

A DICTIONARY
OF
UNIVERSAL KNOWLEDGE

NEW EDITION

VOL. IX

ROUND TO SWANSEA



54406
22/7/02

WILLIAM & ROBERT CHAMBERS, LIMITED
LONDON AND EDINBURGH

J. B. LIPPINCOTT COMPANY, PHILADELPHIA

1902

All Rights reserved

The following Articles in this Volume, originally Copyrighted in 1892, as now revised are Copyrighted by J. B. LIPPINCOTT COMPANY, in 1897 and 1900, in the United States of America :

RUSSIA.	SHERIDAN, P. H.
ST LOUIS (Missouri).	SHERMAN.
ST PAUL (Minnesota).	SHIPBUILDING.
SAN FRANCISCO.	SILK.
SCANDINAVIAN MYTHOLOGY.	SILVER.
SCOTT, SIR WALTER.	SLANG.
SEWAGE.	SODA.
SEWARD, W. H.	SOUTH CAROLINA.
SEWING-MACHINE.	SPAIN.
SHAKERS.	SPIRITUALISM.
SHAKESPEARE.	SUGAR.
SHELLEY.	SUMNER.

Among the more important articles in this Volume are the following:

ROUND TOWERS.....	DR JOSEPH ANDERSON.	SIDNEY, SIR PHILIP.....	F. T. PALGRAVE.
ROUSSEAU.....	REV. H. G. GRAHAM.	SIEGE.....	LIEUT.-COL. H. D. B. DUNLOP.
ROWING.....	W. B. WOODGATE.	SIGNALLING.....	JAMES BOLAM.
RUBENS.....	J. M. GRAY.	SILK.....	SIR THOMAS WARDLE, F.C.S.
RUGBY.....	HENRY LEE WARNER.	SILURIAN SYSTEM.....	PROFESSOR JAMES GEIKIE.
RUNES.....	ORROR ISAAC TAYLOR.	SIMON MAGUS.....	REV. J. SUTHERLAND BLACK, LL.D.
RUSSIA.....	PRINCE KROPOTKINE.	SISTERHOODS.....	MARIA TRENCH.
SACRIFICE.....	REV. JAMES STRACHAN.	SKATING.....	DR. MAXWELL WITHAM.
ST ANDREWS.....	D. HAY FLEMING.	SKULL.....	DR. DAVID HEPBURN.
SAINTE-BEUVE.....	P. HUME BROWN, LL.D.	SLANG.....	CHARLES GODFREY LELAND.
ST LOUIS.....	C. S. YOST.	SLAVS.....	W. R. MORFILL.
SAINTE-SIMON, DUC DE.....	THOMAS DAVIDSON.	SLEEP; SOMNAMBULISM.....	DR A. W. MACFARLANE.
SALISBURY.....	A. R. MALDEN.	SLOYD.....	JOHN STRUTHERS.
SALISBURY, LORD.....	FREDERICK GREENWOOD.	SMITH, ADAM.....	JOHN HILL BURTON.
SALMON.....	ARCHIBALD YOUNG.	SMOKE.....	ROBERT IRVINE.
SALT; SILVER; SODA.....	A. GALLETT.	SMOLLETT.....	DAVID HERBERT.
SALVATION ARMY.....	BRAMWELL BOOTE.	SNAIL; SLUG.....	T. D. A. COCKERELL.
SAMOA.....	C. P. LUCAS.	SNAKES; SPIDERS.....	PROFESSOR J. ARTHUR THOMSON.
SAND, GEORGE.....	PROFESSOR SAINTSBURY.	SNOW.....	R. T. OMOND.
SAN FRANCISCO.....	DR W. C. BARTLETT.	SOAP.....	JOHN MACARTHUR.
SANSKRIT.....	PROFESSOR KOEHLING.	SOCIALISM.....	THOMAS KIRKUP.
SAVINGS-BANKS.....	URQUHART A. FORBES.	SOCRATES; SOPHISTS.....	PROFESSOR D. G. RITCHIE.
SCAND. MYTHOLOGY.....	PROFESSOR RASMUS ANDERSEN.	SOILS.....	JOHN HUNTER, F.C.S.
SCARLATINA.....	DR LUNDIE.	SOLICITOR.....	FRANCIS WAIT.
SCHILLER.....	J. T. BEALBY.	SOLON.....	ROBERT P. DAVIDSON.
SCHLEIERMACHER.....	PROFESSOR FLEIDERER.	SOMERSETSHIRE.....	F. N. WORTH.
SCHNITZER (Kashmir Peaks).....	DR R. W. FELKIN.	SONNET.....	THEODORE WATTS-DUNTON.
SCHOLASTICISM.....	P. HUME BROWN, LL.D.	SOPHOCLES.....	PROFESSOR LEWIS CAMPBELL.
SCHOOL INSPECTORS.....	JOHN KERR, LL.D., H.M.I.S.	SOUND; SPECTRUM.....	PROFESSOR KNOTT.
SCHOPENHAUER.....	PROFESSOR WILLIAM CALDWELL.	SOUTHAMPTON.....	CAPTAIN S. C. N. GRANT, R.E.
SCHUBERT.....	HARRY WHITEHEAD.	SOUTH AUSTRALIA.....	JAMES BONWICK.
SCHUMANN.....	FRANKLIN PETERSON.	SOUTH CAROLINA.....	PROFESSOR N. B. WEBSTER.
SCOTLAND (History).....	PROFESSOR GEORGE GRUB.	SOUTHEY.....	F. HINDES GROOME.
" (Language).....	DR J. A. H. MURRAY.	SPAIN.....	REV. WENTWORTH WEBSTER.
" (Literature).....	P. HUME BROWN, LL.D.	" (Lang. and Lit.).....	H. BUTLER-CLARKE.
SCOTT, GENERAL.....	PROFESSOR J. P. LAMBERTON.	SPENCER, HERBERT.....	PROFESSOR SORLEY.
SCOTT, SIR WALTER.....	ANDREW LANG.	SPENCER, EDMUND.....	PROFESSOR HALES.
SCOTTISH PHILOSOPHY.....	PROFESSOR SETH.	SPINAL CORD.....	DR ALEXANDER BRUCE.
SCULPTURE.....	CHARLES WHISLEY.	SPINNING.....	JAMES PATON.
SCULPTURED STONES.....	DR JOSEPH ANDERSON.	SPINOZA.....	EMANUEL DEUTSCH.
SEA; SOUNDING.....	DR JOHN MURRAY.	SPIRITUALISM.....	ALFRED RUSSEL WALLACE.
SEAL; SOLE.....	J. T. CUNNINGHAM.	SQUIRREL.....	W. E. HOYLE.
SEA-SERPENT.....	DR ANDREW WILSON.	STAËL, MME. DE.....	THOMAS DAVIDSON.
SEAWEEDS.....	R. J. HARVEY GIMON.	STANLEY, DEAN.....	PROFESSOR STORY.
SECULARISM.....	G. J. HOLYOAKE.	STANLEY, H. M.....	JOHN S. KELTIE, F.R.G.S.
SÉVIGNÉ, MME. DE.....	THOMAS DAVIDSON.	STATE RELIGION.....	CADON CURTIS.
SEWAGE.....	BALDWIN LATHAM, M. INST. C.E.	STATUTES.....	SIR PETER BENSON MAXWELL.
SEWARD.....	PROFESSOR W. HAMILTON KIRK.	STEAM-ENGINE.....	PROFESSOR A. B. W. KENNEDY, F.R.S.
SEWING-MACHINE.....	MRS CARRIE B. KILGORE.	STEAM-HAMMER.....	PROFESSOR T. H. BEARE.
SEX.....	PROFESSOR J. ARTHUR THOMSON.	STEEL.....	W. MATTIEU WILLIAMS.
SHAKERS.....	MRS CARRIE B. KILGORE.	STEELE, SIR RICHARD.....	AUSTIN DOBSON.
SHAKESPEARE.....	PROFESSOR DOWDEN.	STERNE, LAURENCE.....	H. D. TRAILL, D.C.L.
SHEEP.....	JAMES MACDONALD.	STOCK-EXCHANGE.....	R. MARSON, of the <i>Statist</i> .
SHEFFIELD.....	REV. ALFRED GATTY, D.D.	STORMS.....	DR BUCHAN.
SHELLEY.....	PROFESSOR DOWDEN.	STRAFFORD.....	F. HINDES GROOME.
SHERIDAN, R. B.....	MRS OLIPHANT.	STRAFFORD DE REDCL.....	STANLEY LANE-POOLE.
SHERMAN; SHERIDAN.....	GENERAL GRANT WILSON.	STRAWBERRY.....	R. D. BLACKMORE.
SHIELDS, N. AND S.....	W. W. TOMLINSON.	SUGAR.....	THOMAS BAYLEY.
SHIPBUILDING.....	DAVID POLLOCK.	SUICIDE.....	DR CLOUSTON.
SHORTHAND.....	SIR ISAAC PITMAN.	SUMATRA.....	H. A. WEBSTER.
SIAM.....	J. E. BLACK, H.B.M. Legation.	SUMNER.....	JOHN FOSTER KIRK, LL.D.
SIBERIA.....	PRINCE KROPOTKINE.	SUN; STARS.....	REV. E. B. KIRK.
SICILY.....	W. DUNDAS WALKER.	SUNDAY-SCHOOLS.....	ROBERT COCHRANE.
SIDDONS, MRS.....	R. W. LOWE.	SURGERY.....	DR J. P. STEELE.

The Publishers beg to tender their thanks, for revising articles, to the Principal of St Bees, the Rector of Stonyhurst, the Superiors of the two orders of Christian Brothers in Ireland, the Head-masters of St Paul's, Shrewsbury, and Sherborne Schools, and the town-clerks of Scarborough, Southport, Stafford, Stirling, Stockport, Swansea, &c.; to the Factor of St Kilda; to the Secretary of the Sunday-school Union; to Mr RICHARD SAVAGE, for revising 'Stratford-on-Avon;' to Mr E. T. COOK, for revising 'Ruskin;' to Mr R. B. HALDANE, M.P., for revising 'Adam Smith;' and to Mr HERBERT SPENCER, for revising the exposition of his philosophy.



CHAMBERS'S ENCYCLOPÆDIA

A DICTIONARY OF UNIVERSAL KNOWLEDGE



Round, in Music, a short vocal composition, similar to the catch, and like it, peculiar to England. It is in the form of an infinite Canon (q.v.) at the unison or octave, each part in succession taking up the subject at a regular rhythmic interval, and returning from the conclu-

sion to the commencement, and so on, *ad libitum*, till an agreed-on pause. The most ancient specimen now extant of vocal composition in polyphony is the famous *Rota* or Round, 'Sumer is icumen in,' of the 13th century. Well-known roundelays are 'The Great Bells of Osney,' 'Row the Boat, Whittington,' Aldrich's 'Hark the Bonny Christ-church Bells,' and the well-known 'Three Blind Mice.' See Metcalfe's *Rounds, Canons, and Catches of England*, with introduction by Rimbault.

Round Churches. See ROMANESQUE ARCHITECTURE. There are four surviving circular churches in England,—the Temple Church in London (see **TEMPLARS**), the church of the Holy Sepulchre in Cambridge (q.v.), one of the same name in Northampton (q.v.), and one at Little Maplestead in Essex.

Roundheads, the nickname given by the adherents of Charles I. during the Great Rebellion to the Puritans, or friends of the parliament, who, with Prynne, denounced the 'unloveliness of love-locks,' and were understood to distinguish themselves by having their hair cut close, while the Cavaliers wore theirs in long ringlets. According to Clarendon and Rushworth the term was first publicly used in December 1641 by a Captain David Hine, who, drawing his sword, swore he would 'cut the throats of those round-headed, cropp'd-eared dogs that bawled against the bishops.'

Round-robin (Fr. *rond*, 'round,' and *ruban*, 'ribbon'), a name given to a protest or remonstrance signed by a number of persons in a circular form, so that no one shall be obliged to head the

list. It is said to have originated in a usage of the French officers. The most memorable round-robin in literary history is that sent by Burke, Gibbon, Sir Joshua Reynolds, Joseph Warton, and others to Dr Johnson, requesting him to amend the epitaph for Goldsmith's monument, and suggesting that it should be written in English, not Latin. Johnson took it kindly, but told Sir Joshua, who carried it to him, that he would 'never consent to disgrace the walls of Westminster Abbey with an English inscription.'

Round Table. See **ARTHUR**, and **ROMANCES**. By the *Round Table Conference* is meant an ineffectual series of meetings begun in January 1887, for the purpose of arranging terms for a reunion of the Gladstonian or Home Rule section of the Liberal party and the Liberal Unionists, the members being Lord Herschell, Mr Morley, Mr Chamberlain, Sir W. V. Harcourt, and Sir George Trevelyan.

Round Towers. Tall narrow circular towers tapering gradually from the base to the summit, found abundantly in Ireland, and occasionally in Scotland, are among the earliest and most remarkable relics of the ecclesiastical architecture of the British Islands. They have long been the subject of conjecture and speculation, but there can be now no doubt that they are the work of Christian architects, and built for religious purposes. They seem to have been in all cases attached to the immediate neighbourhood of a church or monastery, and, like other early church-towers, they were capable of being used as strongholds, into which, in times of danger, the ecclesiastics could retreat with their valuables. In the Irish records, for two centuries after 950 A.D., they are invariably called *Cloictheach* or bell-towers, and are often mentioned as special objects of attack by the Northmen. About 118 towers of this description are yet to be seen in Ireland, twenty of which are entire or nearly so; and Scotland possesses three similar towers—at Brechin, Abernethy, and Eglisay in

Orkney. They are usually capped by a conical roof, and divided into stories, sometimes by yet existing floors of masonry, though oftener the floors have been of wood. Ladders were the means of communication from story to story. There is generally a small window on each story, and four windows immediately below the conical roof. The door is in nearly all cases a considerable height from the ground. The figure represents the tower at Ardmore, County Waterford, which is one of the most remarkable of those remaining in Ireland. Rising from a double plinth course at the bottom to a total height of 95 feet, it is divided

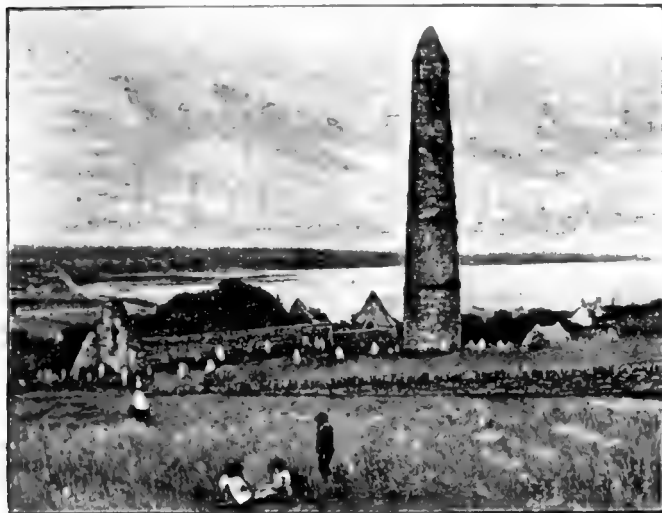

Round Tower, Ardmore.

(From a Photograph by J. Lawrence, Dublin.)

into three stages by external bands at the offsets, corresponding to the levels of three floors within, the fourth being also marked by a slight offset. Most of these towers, however, have only a slight batter externally from top to bottom. Some, like that of Devenish, are carefully and strongly built of stones cut to the round, and laid in courses, with little cement; others, such as those at Cashel and Monasterboice, have the stones merely hammered and irregularly coursed; others, again, like those of Lusk and Clondalkin, are constructed of gathered stones untouched by hammer or chisel, roughly coursed, and jointed with coarse gravelly mortar; while in others, as at Kells and Drumlane, part of the tower is of ashlar, and the rest of rubble masonry. The average height of these towers is from 100 to 120 feet, the average circumference at the base about 50 feet, and the average thickness of the wall at the base from 3 feet 6 inches to 4 feet; the average internal diameter at the level of the doorway is from 7 to 9 feet, and the average height of the doorway above the ground-level about 13 feet. These doorways always face the entrance of the church to which the towers belonged. All the apertures of the towers have inclined instead of perpendicular jambs, which is also an architectural characteristic of the churches of the same period, and the sculptured ornamentation of the apertures or walls of the towers is in the same style as that of the churches. Dr Petrie was inclined to think that a few of these remarkable structures may be as old as the 6th century, but they are now assigned to a period ranging from the 9th to the 12th centuries. The source whence this form of tower was derived, and the cause why it was so long persisted in by the Irish architects, are points,

however, on which there is not the same unanimity of opinion. Two round towers, similar to the Irish type, are to be seen in the yet extant plan of the monastery of St Gall in Switzerland, of the first half of the 9th century; and, in the Latin description attached to the plan, they are said to be *ad universa superspicienda*. The church and towers as rebuilt at that date are no longer in existence; but Miss Stokes has pointed out a passage in the life of St Tenenan of Brittany which shows that this type of round tower detached from the church was in use on the Continent in the 7th century, 'wherein to deposit the silver-plate and treasure of the church and protect them from the sacrilegious hands of the barbarians should they wish to pillage the church.' Lord Dunraven has traced the type from Ireland through France to Ravenna, where there are still six remaining out of eleven recorded examples. Hulsch considers the detached round towers or campaniles of the Ravenna churches to be of the same date as the churches themselves, or mostly earlier than the close of the 6th century; but Freeman, on the other hand, maintains that they are all later than the days of Charlemagne, as the local writer Agnellus, writing soon after his time, describes the churches of Ravenna much as they are, but says nothing of bell-towers. Suffolk and Norfolk contain more round-towered churches than does all the rest of England, probably because the flint there prevalent is worked into this form more readily than any other stone. A modern round tower is O'Connell's monument in Glasnevin Cemetery, which is 160 feet in height.

See Dr G. Petrie's *Ecclesiastical Architecture of Ireland* (Dublin, 1845); vol. ii. of Lord Dunraven's *Notes on Irish Architecture* (Lond. 1877); Dr J. Anderson's *Scotland in Early Christian Times* (Edin. 1881); and Miss Stokes's *Early Christian Art in Ireland* (Lond. 1887).

Roundway Down, a hill about $1\frac{1}{2}$ mile N. of Devizes, in Wiltshire, the scene of Waller's defeat by the royalists under Lord Wilmot in July 1643. Waller was besieging Devizes when Wilmot came up to relieve the town, whereupon he turned at once to meet him, but was quickly crushed between Wilmot on the one side and a sally of the garrison on the other. Waller escaped, but only with the loss of his artillery and most of his men.

Round Worms (*Nematoda*), a class of worms in which the body is elongated and more or less cylindrical. Most are parasitic, such as *Ascaris lumbricoides* and *Oxyuris vermicularis*, common in man, and numerous species of *Tylenchus*, which infest plants. Many genera, however, live in water or in moist earth, and many of the parasites are free-living during part of their life. They are called round worms, in contrast to the flat worms or Plathelminthes, such as tapeworms and flukes. For classification, see THREAD-WORMS.

Roup is one of the most serious diseases which the poultry or pheasant keeper has to fight, because in it there is generally an affection other than the mere cold which develops and makes it apparent. It is usually found that the system is scrofulous, which is the milder form; but sometimes it takes a diphtheric development, and this is the most severe and deadly disease known to poultry-keepers.

Whether scrofulous or diphtheric, it is highly contagious, and very seldom is any bird in a yard attacked without nearly all the others being also affected. The difference between ordinary cold and roup is very easy to determine, though the symptoms are in some respects the same. But when it is merely cold the running at the eyes and nostrils is not at all offensive, whereas it is strongly so in the case of roup from scrofula, the breath being most repulsive. This fact, as well as the swelling of the face, may be taken at once to determine when it is roup. The cause may generally be sought for in bad feeding, housing, or ventilation, which have charged the blood with scrofulous matter, and the outward symptoms are induced by cold. When first noticed the birds affected should at once be isolated, in order to prevent the spreading of the disease, which will speedily follow if all are kept together. The treatment must be dual, namely to cure the cold and to remove the scrofula from the blood. For the former any of the roup pills sold can be used, or it may be removed by homœopathic tincture of aconite given three or four times a day, the birds being kept in a warm and draughtless place. The scrofula is not so easily eradicated, and will require patience. Ordinary-sized pills made of powdered charcoal 10 parts, dried sulphate of iron 1 part, and capsicum 1 part, made up with butter, and given twice a day, form an excellent medicine, when the roup proper in its more active state is removed. To do this, however, it is desirable to clear the mouth, nostrils, and eyes from the mucus which accumulates there and which will suffocate the bird if not removed. In milder cases it is enough to wash the parts with vinegar and water, but in more severe cases it is better to use solution of chlorinated soda, as it is much more effective. Should the nostrils be very full of mucus, a small bent syringe should be filled with the solution, which must be inserted into the slit in the bird's mouth, through which the liquid is forced, and will effectually clear the passages. It is most essential in returning the birds to the house again to see that they are entirely recovered. When diphtheric roup is present the matter assumes a more serious aspect, because of the danger not only to other birds, but also to human beings, who have been known to contract this fell disease from birds. For that reason the greatest care must be taken, and, except in the case of very valuable fowls, it is much safer to kill those affected and bury them in quicklime. The outward symptoms in diphtheric roup are not nearly so apparent at first sight, because less prominent; still, the bird is noticed to be dull and lethargic. Unless checked the disease runs its course in a few hours, and the bird dies. Very often it is not known that diphtheric roup is present until several deaths have taken place. Its presence is easily distinguished by the skin-like substance formed over the throat. Treatment is doubtful, and Professor Whalley recommends that it should take the heroic form of dabbing the throat with carbolic acid, which will kill or cure.

Roup, in Scotland. See AUCTION.

Rous, FRANCIS, was born at Halton, Cornwall, in 1579, and educated in Oxford at Broadgate Hall, now Pembroke College. He was a member of the Long Parliament, sat in the Westminster Assembly of Divines, and in 1643 was made provost of Eton. He died at Acton, 7th January 1659, his writings having been collected two years before. Wood is abusive even beyond his wont to 'the old illiterate Jew of Eaton' and his 'enthusiastic canting.' His metrical version of the Psalms was recommended by the House of Commons to the Westminster Assembly, and is still substantially the Presbyterian Psalter. It is easy to abuse

his version—Sir Walter Scott's verdict was that, though homely, it is 'plain, forcible, and intelligible, and very often possesses a rude sort of majesty, which perhaps would be ill exchanged for mere elegance.'

Rousseau, JEAN BAPTISTE, a great lyric poet of France, was born at Paris, 6th April 1670, the son of a shoemaker who gave him a sound education. At an early age he became acquainted with Boileau, and began to produce pieces for the theatre, with but little success. Among his earliest patrons were Breteuil and Tallard, and the latter carried him in his suite to London. His turn for satire soon brought him troubles as well as reputation, and some lampoons upon the literary frequenters of the Café Laurent, chief of whom were La Motte and Saurin, brought down upon his head a quarrel that distressed the remainder of his life. Defeated by La Motte in 1710 in his canvass for T. Corneille's chair at the French Academy, he was soon after taken by everybody for the author of a fresh series of scurrilous and indecent couplets. He charged Saurin with writing them and attempting to foist the paternity upon him, and raised an action against him. Failing to make good the charge, he found himself in 1712 condemned in absence to perpetual banishment *par contumace*. Henceforth he lived abroad under the patronage of the Comte de Luc, French ambassador to Switzerland, and afterwards of Prince Eugene and the Duc d'Artemberg. At Brussels he made the acquaintance of Voltaire, but from a friend the latter soon became a bitter enemy. Rousseau visited England, and there published in 1723 a new edition of his works. He was never successful in getting his banishment annulled, although once at least he visited Paris incognito. He died at Brussels, March 17, 1741. Rousseau was not a great, only a supremely clever poet. His sacred odes and *cantates* are splendidly elaborate, frigid, and artificial; his epigrams, on the other hand, are bright, vigorous, sharp, with stinging satire, and unerring in their aim.

Editions are by Amar (1820) and A. de Latour (1869). See also his *Œuvres Lyriques*, by Manuel (1852), and *Contes inédits*, by Luzarche (Brussels, 1881).

Rousseau, JEAN JACQUES, was born on June 28, 1712, in Geneva, where his family had been settled since 1550, when Didier Rousseau, a French Protestant, sought shelter from persecution. His mother died immediately after his birth, and he was left to the companionship of his father, Isaac Rousseau, a watchmaker and dancing-master, a man selfish and sentimental, passionate, dissipated, and frivolous. In 1722 his father having involved himself in a brawl fled the city to escape imprisonment, and left him to the charitable care of his relations. When he was thirteen his uncle apprenticed him to a notary, who soon found him utterly incompetent, and sent him back as a fool; and thereafter he was apprenticed to an engraver, whose cruelty during the three years he lived with him, he says, made him stupid by tyranny, cunning from fear, and wretched by ill-treatment. One evening, having rambled beyond the city walls till the gates were closed, he was too terrified to face his master, and resolved never to return, but to seek elsewhere his fortune. Now, in 1728, began his adventurous and vagrant career, for the details of which his *Confessions* form our chief authority, in which with picturesqueness and charming vivacity, with marvellous frankness, if not with scrupulous accuracy, he tells the story of his life. As he wandered on he was entertained by a priest of Savoy, eager for proselytes from heresy, and Jean Jacques, pretending to be eager to espouse the Catholic faith, was sent off to Madame de Warens at Annecy, who should look after the

Calvinistic vagrant. By her he was hospitably received and then transmitted to a hospice in Turin filled with some fellow-catechumens; and soon initiated into the faith and duly baptised, he was discharged with a few francs in his pocket. He in vain sought work as an engraver, till a shop-keeper's wife gave him employment, and to her he acted in the double capacity of servant and lover, till on her husband's return he was kicked out of doors. He next became footman to a Comtesse de Vercellis, and on her death not long after he took service again as lackey to Comte de Gouvon, and as nondescript secretary to the abbé, his master's son, till he became intolerable both to his masters and his fellow-servants, and was summarily dismissed.

Now in 1731 he travelled back to Madame de Warens, who welcomed him and installed him as permanent inmate of her house. Madame de Warens or, as her name was otherwise written and pronounced, Vorrans or Vuarrans, lived apart from her husband a very independent life, having a pension, which late investigation suggests may have been earned by acting as a political spy. She was twenty-eight years old, pretty and piquant, kindly in disposition, not rigid in morals, but rich in sentiment. She was clever and flighty, dabbling in chemistry and alchemy, dabbling also in commercial speculations which made her the dupe of adventurers, and indulging in religious speculations which combined Deism in creed with Roman Catholicism in worship. To her Jean Jacques, now nineteen years old, became pupil and friend, factotum, and ultimately lover, through nearly nine years. This period was diversified by adventurous interruptions: he at one time set himself up in Lausanne as a teacher of music though hardly able to play a tune, and as a composer though not able to write a score; became secretary to an archimandrite of the Greek Church, collecting subscriptions to restore the Holy Sepulchre; and then went to Paris as servant to an officer. Thereafter he returned to live with Madame de Warens at Chambéry, and from 1736 at Charmettes, in which lovely retreat his happiest and idlest years were spent, in desultory reading with his *maman*, in music, indolence and sentiment. This attachment and companionship ceased ingloriously at last when on returning from recruiting his health at Montpellier he found himself supplanted in the heart of Madame de Warens by one Vintzenried, whom he describes as a journeyman wig-maker, ugly and a fool, who as a lover was tyrannising over his facile mistress, mismanaging her affairs and dissipating her money. In disgust in 1740 Jean Jacques quitted his beloved Charmettes, the idyllic memories of which lived in his heart, as by his picturesque description they live immortal in literature. He became now tutor in Lyons to the sons of M. de Mably, the brother of the famous Condillac and of the once well-known Abbé de Mably, where he taught with lamentable incapacity.

In 1741 he set off to seek his fortune in Paris, with a little money, some letters of introduction to Parisian notables, and a system of musical notation by which he expected to make his reputation. He had to live in a dirty, shabby inn, and to earn a meagre livelihood by copying music, while his musical system was pronounced by the Academy of Sciences 'neither useful nor original.' After a sojourn of eighteen months at Venice, where he acted as cheap secretary to the embassy till he quarrelled with the ambassador, he returned to his inn, his copying, and a secretaryship with M. de Francueil. Meanwhile he had formed a companionship with a girl he found acting as drudge at the inn, called Thérèse le Vasseur,

utterly illiterate, densely stupid, plain-featured, mean and vulgar, although he imagined her possessed of every grace in body, mind, and soul. By her he had five children, each in turn deserted and consigned by him to the hospital for foundlings. He had gained acquaintance with men of letters, with D'Alembert and Diderot, as needy as himself; and when they were producing the famous encyclopædia he wrote articles, of which the most notable were those on music and political economy. His first distinguished appearance in literature was in 1749 by a *Discourse on Arts and Sciences*, written successfully for a prize offered by the Academy of Dijon on the problem whether science and the arts have corrupted or purified morals. Here with bold paradox he denounces fiercely and eloquently letters, arts, sciences, and all culture as alike proofs of and causes of corruption. The audacious independence of his thought, the freshness of his brilliant style, made him at once celebrated in literary and welcome to fashionable circles of society. In 1753 he next made himself distinguished as a composer by his opera the *Devin du Village*, full of novel and sparkling airs (one of which, slightly modified, is the well-known hymn-tune called *Rousseau's Dream*), which was first played with success before the court at Fontainebleau, and when performed in Paris achieved for him a popularity which was not sustained by subsequent efforts. It was in the same year that there appeared his *Discourse on the Origin of Inequality*, which, though unsuccessful in winning the prize from the Academy at Dijon, was successful in establishing his position as a writer in France. In this discourse he argues that all civilisation is a state of social degradation, that all science and literature, all social institutions and refinements are forms of degeneration from the primeval savage life, which, with all its ignorance and brutishness, he audaciously pronounces the state of human simplicity and perfection. All property is asserted to be derived from confiscation, all wealth is a crime, all government is tyranny, all social laws are unjust.

His brilliant denunciation of society made him the more attractive in society; but hating alike the company of wits and of courtiers, and despising fashionable conventions, he lived poorly, dressed meanly, and acted churlishly to show his independence, with that morose self-consciousness, blended with vanity, which was becoming with him a disease. Gladly he accepted from Madame d'Épinay the offer of a retired cottage, the Hermitage, on the skirts of the forest of Montmorency, near her own château Chevette. There he retired with Thérèse, her obnoxious mother, and his meagre chattels. Still earning his living by copying music, which produced about £60 a year, he employed his days amidst the woods of Montmorency with conceiving and writing his romance, *The New Heloise*, inspired in the composition of its rapturous passages by a passion he had formed for Madame d'Houdetot, the sister of Madame d'Épinay. His suspicious temper fostered misunderstandings with his patroness, and bitter quarrels with her friend Baron Grimm, and with his own warm friend Diderot; and he quitted the beloved Hermitage with reluctance for a cottage at Montlouis not far off, where he found kind friends in the Duke and Duchess of Luxemburg. In 1760 the *New Heloise* was published, and was instantly received with applause, and Rousseau became the idol of the sentimental though artificial society of Paris. His work was followed in 1762 by the treatise on the *Social Contract*, published in Amsterdam in order to escape French censorship; and there two months later also appeared *Émile*. By the first work the recluse rose to the first rank

as a writer of the romance of sentiment; by the second as a political socialist; by the third as an educationist.

But the views in *Emile* on kings and government made him obnoxious to the state, and the parliament condemned the author to be arrested and his book to be burned; while its deistic teaching in the Savoyard vicar's confession made him hateful to the church, and called forth a denunciatory pastoral from the Archbishop of Paris. Rousseau in terror fled from France, and found shelter at Motiers, an obscure village in Neuchâtel, where he was safe under the tolerant rule of Frederick the Great, and the friendship of the Earl Marischal, George Keith, the governor of the province. Although he lived unobtrusively in botanising rambles, in making laces, and in writing his aggressive *Letters from the Mountain*, and his powerful reply to the Archbishop of Paris, religious rancour followed him to the remote and peaceful Val de Travers. The ministers stirred up the villagers against the heretic, and to escape their open hostility he took flight in 1764. A residence of delicious quietude in St Pierre on Lake Bienné was ended by threat of prosecution from the government of Berne; and he accepted the offer of a home in England, given through David Hume. Under the charge of the good-natured historian, the irritated and sensitive fugitive came to England in January 1766. During about eighteen months he lived at Wootton in Staffordshire, solitary and quiet: here he busied himself with botany and his *Botanical Dictionary*, and especially in composing his *Confessions*, in which he determined to write his memoirs, to expose his enemies, to reveal himself—in spite of every fault, which he resolved to own—as one of the very 'best of men.' His suspicious nature, his morbid distrust and fears, had increased with his trials and his years. He had quarrelled with almost every friend, imagining the worst meaning in the best of motives; he believed that his truest friends, like Hume, acted with the most sinister designs, that the English government sought his life, and that he was everywhere dogged by spies. Suddenly he quitted Wootton, and, crossing the Channel, got a shelter from the *doctrinaire* Marquis de Mirabeau, and then from the Prince de Conti at Trye; and there he lived, under the name of 'M. Renon,' till he fancied that he was insulted by the domestics and that he was suspected of poisoning a servant. After various shifty changes he lived at Monquin, a retired, quiet spot, where he composed those later parts of his *Confessions*, in which each incident is coloured by his gathering delusions as to the motives of every one with whom he came in contact. In 1770 he returned to Paris, and remained unmolested, following his old life as copyist at ten sous a page, in a fifth story in the Rue Plâtrière, maintaining a surly independence, distrusting his friends, rebuffing admirers, insulting his customers. During these years, in different moods of mind and changing conditions of his broken health, he wrote the wild, half-mad dialogues, *Rousseau juge de Jean Jacques*, in which he vindicates his character in a strain which casts doubt on his sanity, and his *Réveries du Promeneur Solitaire*, which, in singular contrast, are calm in their tone, idyllic in their beauty, and perfect in their style. Still the delusions increased, and his mental misery deepened till he even craved for shelter in a hospital; everywhere he felt watched by spies, hated by the very children in the streets. In 1778 he accepted the last of these many offers of shelter, and retired to a cottage given him by M. de Girardin on his estate at Ermenonville, 20 miles from Paris. There he suffered from the misconduct of Thérèse, and from inveterate delusions, till, with a suddenness which has given

much ground for suspicion of suicide, Jean Jacques Rousseau died on July 2, 1778. His body now rests in the Panthéon.

If the character of Rousseau can be learned from the judgment of his friends and foes, it can be also discovered from his own writings, which tell the story of his life—his *Confessions*, his *Letters*, his *Reveries*. We may receive his own version of many of his own acts with doubt, and his interpretation of the acts of others with reserve, while details in the *Confessions* are known to be in many cases inaccurate; but as a picture of the man they are strikingly truthful. He is moved by a daring determination to conceal nothing, believing that every defect will only show the intrinsic beauty of his character as patches show off better the complexion of the face. Therefore he tells his ignoble intrigues and his paltry actions, how he deserted his companion when he fell in a fit, how he basely accused a poor girl, his fellow-servant, of theft to conceal his own dishonesty. He exhibits his jealousies and his hates, his lofty sentiments and his petty practices, his unbounded confidence in himself not only as a man of genius, but as a man of supreme rectitude. In spite of the worst he confesses and the worst charged against him by others, he needs commiseration in his faults, as arising from a mind disordered, and he deserves respect for his sincerity of thought, his independence of conduct in spite of its coarseness, his spirit of reverence, and his generosity of heart and hand. As a writer his influence has been exercised in diverse directions. His *New Héloïse*, suggested alike in its clumsy form of letters, its didactic passages, and its fervid romance by Richardson's novels, stirred by its strain of passion a spirit of sentiment in the society and literature of France, Germany, and Italy; by its idyllic pictures and exquisite descriptions it awakened a new admiration for nature in its grand and wild aspects, and touched the fashionable world with interest in rural life and in its simple ways. Amidst all its falsetto passion, it taught an artificial society the rights of the poor and the duties of the rich. The *Social Contract* proceeds on the premise that the basis of society is an original compact by which each member surrenders his will to the will of all, on the condition that he gets protection or defence; and arguing that the community is the true sovereign, that each member of it has equal power and right to make its laws, Rousseau arrives at the conclusion that kings are usurpers, that no laws are binding to which the whole people's assent has not been gained. True to his own Genevan traditions and tastes, he considers a republic in which all the people have personal votes as alone valid, and his doctrines of liberty, equality, and fraternity were adopted by leaders of the people, were carried by demagogues to logical extremes he never dreamt of, and became war-cries of the Revolution. By *Emile*, in which the man who abandoned his own offspring becomes the instructor of the age on the nursing of infants, the rearing of children, and the education of youth, with keen observation of life he pointed out the defects of common methods in the nursery and the school-room. The work had marked results in discouraging the faults and neglects in artificial society towards children, and in indicating a more natural and less pedantic method of training and developing the physical, mental, and moral faculties; and his ideas on this head (while many absurdities and whimsicalities in the book were avoided) were in large measure carried out by educationists like Froebel and Pestalozzi, and affected the educational methods of all Europe. By his famous chapter on the Savoyard vicar's confession he gave a confession of his own deistic faith, which disgusted

Voltaire, D'Alembert, and D'Holbach by its strain of religious fervour and conviction, and horrified the church by its scornful denial of orthodoxy and supernaturalism. Meanwhile it kindled in France a spirit of severest theism instead of cynical scepticism or blank denial, and inspired Revolutionists like Robespierre with the doctrine that belief in a God is essential for society and the state.

See Musset-Pathay, *Histoire de la Vie et les Ouvrages de J. J. Rousseau* (1821); Streckeison-Moulton, *Rousseau: Ses Amis et ses Ennemis* (1865); St Marc Girardin, *J. J. Rousseau, sa Vie et ses Ouvrages* (2 vols. 1875); John Morley, *Rousseau* (2 vols. 1873; 2d ed. 1886); Berthoud, *Rousseau au Val de Travers* (1870); Morveau, *Rousseau et le Siècle Philosophique* (1870); Desnoiresterres, *Rousseau et Voltaire* (1874); *Dernières Années de Madame d'Épinay*, edited by Percy and Maugrat (1881); the present writer's monograph in the 'Foreign Classics' series (1883); Jansen, *Rousseau als Musiker* (1885); Mahrenholz, *Rousseaus Leben* (1889); Mobius, *Rousseaus Krankheitsgeschichte* (1889); *Madame de Warens et Rousseau*, by François Mugnier (1890); Carteret, *Rousseau jugé par les Français d'aujourd'hui* (1890); Rousseau's *Lettres Inédites*, edited by H. de Rothschild (1892); Chuquet's study in the 'Grand Écrivains' series (1893); besides essays on Rousseau as a pedagogy by Quick and others.

Rousseau, PIERRE ETIENNE THÉODORE, one of the most distinguished of the modern landscape-painters of France, was born in Paris on the 15th April 1812, the son of a well-to-do merchant tailor of the city, a native of Salines in the Jura. There were several artists among his mother's kinsmen; and one of these, Alexandre Pau de Saint Martin, having seen a landscape, 'The Signal Station on Montmartre,' which the boy painted at the age of fourteen, gave him some instruction, and persuaded his parents to abandon their intention of entering their son at the École Polytechnique for an engineer, and to place him, instead, under Remond the landscape-painter. The classical ideal and methods of this artist were little to the liking of his pupil, who next worked under Guillon-Lethière, and in the École des Beaux-Arts; but his best teachers were the old masters in the Louvre, and his happiest hours were those spent in sketching from nature in the environs of Paris. In 1830 he was painting in Auvergne and Normandy, and he studied landscape in nearly every district of France; but by 1833 he had begun sketching in the Forest of Fontainebleau, which ever after was his favourite painting-ground, and where he finally settled, in the village of Barbizon, in 1848. He first exhibited in the Salon of 1831, and in 1834 his 'Border of the Forest of Compiègne' gained a third-class medal and was bought by the Duke d'Orléans; but in the following year his 'Descent of Cows in Autumn,' painted in the Jura, afterwards purchased by Ary Scheffer, and 'The Alley of Chestnut Trees,' one of his finest works, were rejected—in excellent company—through the influence of Bidault and Rochette, the president and secretary of the Academy. Some twelve years of more or less complete neglect and discouragement followed, and left such baneful effects upon a mind naturally proud and melancholic as may account for the petulance and acerbity which marked certain passages of Rousseau's later life. But in 1848 the painters themselves assumed the management of the Salon exhibitions; he was elected one of the jury; and in the following year he resumed exhibiting, and gained a first-class medal. His works were prominently hung in the Exposition Universelle of 1855; as also in that of 1867, when he was president of the jury, and the only landscape-painter who won a grand medal. Soon afterwards he was appointed an officer of the Legion of Honour; but before he was decorated he had been attacked by paralysis, and, after lingering six months, he died on the 22d of December 1867.

Though Rousseau was most deliberate in his art methods, and would often keep his canvases long in hand, altering and retouching them, he was yet an exceedingly prolific, if a somewhat unequal, painter. At his best his works are characterised by true dignity and originality of style, by noble richness of colouring, and are informed by deep sentiment and emotion. His productions now command immense prices, his 'Early Summer Morning' having sold in New York, at the Proboscio sale in 1887, for \$21,000. See Sensier, *Souvenirs de Théodore Rousseau* (1872); and D. C. Thomson, *The Barbizon School* (1890).

Rousselaere. See ROULERS.

Roussillon, formerly a province of France, surrounded by Languedoc, the Mediterranean, the Pyrenees, and the county of Foix. It now forms the French department of Pyrénées-Orientales. In ancient times the capital was *Ruscino*, which stood in the vicinity of the modern Perpignan.

Routh, MARTIN JOSEPH, born of Yorkshire ancestry at St Margaret's South Elmham, Suffolk, on 18th September 1755. His father, a clergyman, in 1758 settled as schoolmaster at Beccles, whence Martin in 1770 went up to Queen's College, Oxford. In 1771 he was elected a demy, in 1775 a fellow, and in 1791 president, of Magdalen. He took deacon's orders in 1777, but priest's not till 1810, when he was presented to the rectory of Tylehurst, near Reading, worth £1000 a year; ten years later he married Eliza Agnes Blagrove (1790–1869). He died at Magdalen, 22d December 1854, in his hundredth year.

A little shrunken figure, with 'such a wig as one only sees in old pictures,' he had grown very deaf, but till well after ninety retained his eyesight and marvellous memory, could walk six miles and climb a stiff hill, mount the library steps, and study till past midnight. Newman and Bancroft were among his later friends and acquaintances; the earlier had included Dr Parr, Samuel Johnson, and Porson. He was a great patristic scholar when patristic scholars were few, a Caroline churchman, a liberal Tory, a lover of his dogs and canary and joke, a mighty book-buyer to the last—his 16,000 volumes he bequeathed to Durham University. For just seventy years he was publishing, but his works number only six; and two of these are editions of Burnet ('I know the man to be a liar, and I am determined to prove him so'). He will be remembered by his *Reliquiæ Sacræ* (5 vols. 1814–48), but still more for his sage advice, 'Always verify your references, sir.' And Dr Routh it was who in 1783 induced Dr Seabury of New York to apply for consecration as bishop of Connecticut, not to the Danish Church, but to the Scottish episcopate. See Burgon's *Lives of Twelve Good Men* (1888).

Roveredo, a town of the Austrian Tyrol, stands close to the left bank of the Adige, 14 miles S. of Trent by rail. It has been since the 15th century the centre of the Tyrolean silk industry; it has also leather and tobacco factories, and carries on an active transit trade. Pop. 8864. Here the French defeated the Austrians, September 3–4, 1796. Rosmini was born here in 1797. See Bertanza, *Storia di Roveredo* (1883).

Rovigno, a seaport of Austria, stands on the west side of the peninsula of Istria, opposite the mouth of the Po and 40 miles S. by W. of Trieste. The neighbourhood produces olive-oil and the best Istrian wine. The tunny and sardine fisheries, with oil-pressing and the preparation of pastes and tobacco, are the chief industries. Pop. 9722.

Rovigo, a city in Italy, 27 miles by rail S. of Padua, has a cathedral (1696), an academy of sciences, a library of 80,000 volumes, and a picture-

gallery. Pop. 7560.—The province has an area of 643 sq. m. and a pop. (1898) of 247,626.

Rovuma, a river of East Africa, rises on the east side of Lake Nyassa, flows eastward, and enters the Indian Ocean, after a course of more than 450 miles, a little north of Cape Delgado. During the greater part of its length it forms the boundary between the German and the Portuguese East African possessions. It was first ascended by Livingstone and Kirk in 1862.

Row (pron. *Roo*), a village of Dumbartonshire, on the east shore of the Gare Loch, 2 miles N.W. of Helensburgh, which is included within the parish, and with which it is connected by railway (1894). The saintly John M'Leod Campbell (q.v.) was minister of Row from 1825 till his deposition for alleged heresies in 1831.

Row, JOHN, a Scottish Reformer, was born near Stirling about 1525, studied at St Andrews, and in 1550 was sent by the Scottish clergy as their representative to Rome. While in Italy he took the degree of Doctor of Laws at Padua. In 1558 he returned to Scotland, and next year abandoned the Roman faith. In 1560 he aided in compiling a *Confession of Faith* and the *First Book of Discipline*, became minister of Perth, and sat in the first General Assembly of the Church of Scotland. Four times moderator, he helped to prepare the *Second Book of Discipline*, and died in 1580.—His third surviving son, JOHN ROW, was born at Perth in 1568, studied at Edinburgh, became minister of Carnock in 1592, and died in 1646. He wrote a dull and prolix but reliable *History of the Kirk of Scotland*, which was at length printed by the Maitland Club (2 vols. 1842) and the Wodrow Society (ed. by David Laing). It extends from 1553 to 1637, but was continued to 1639 after the author's death by his second son, JOHN ROW (c. 1600), successively rector of Perth grammar-school, minister at Aberdeen, moderator of the provincial assembly there in 1644, and, by appointment of Monk's commission of colonels, principal of King's College in 1651. Like his father and grandfather a learned Hebraist, and published in 1634 *Hebraica Linguae Institutiones*, and in 1644 *Chilias Hebraicae seu Vocabularium*.

Rowan Tree, MOUNTAIN ASH, or QUICKEN TREE (*Pyrus aucuparia*; *Sorbus aucuparia* of



Rowan (*Pyrus aucuparia*) in flower.

many botanists), a tree belonging to the natural order Rosaceae, abundant in Britain, especially in the Highlands of Scotland, and in many parts of continental Europe. It does not attain a great

size, but is one of the most ornamental trees that occur in British woodlands. The wood is valued for its compactness and fine grain, and is capable of taking a high polish. In the superstitions of the Scottish Highlands, and also of the Lowlands, a peculiar importance was assigned to the rowan tree, a mere twig of which was supposed to have great efficacy in scaring away evil spirits. The fruit (*Rowan berries*) is sometimes used for preserves. It has much acidity, and a peculiar bitterness. In some parts of northern Europe the berries are dried and ground into flour as a substitute for wheaten flour in times of scarcity of the latter. By fermentation they yield an agreeable liqueur, and by distillation a powerful spirit. In Russia a tincture is formed of the ripe berries, which is greatly esteemed as a stomachic. It is made by filling a cask two-thirds full with berries, which have been carefully picked and cleaned. The cask is then filled up with brandy, gin, or rum, and allowed to stand in a cool cellar for twelve months, when the liqueur is run off, and is found impregnated with both the colour and the flavour of the fruit. The fruit of the rowan tree is generally red, but there is a variety with yellow fruit, and a very nearly allied species, *P. americana*, a native of North America, has purple fruit.

Rowe, NICHOLAS, dramatist and translator, a contemporary and friend of Congreve, Pope, Addison, and Steele, was the son of a serjeant-at-law, and was born at Little Barford, in Bedfordshire, June 30, 1674. He was educated at Westminster under Busby, and studied law in the Middle Temple; but early inheriting a small competency by the death of his father, he devoted himself to literature. Between 1700 and 1714 he produced eight plays, of which three were long popular, and deservedly: *Tamerlane* (1702), *The Fair Penitent* (1703), and *Jane Shore* (1714). The character of Lothario in *The Fair Penitent* was the prototype of Lovelace in Richardson's *Clarissa Harlowe*, and indeed the name is still the proverbial synonym for a fashionable rake. Rowe translated Lucan's *Pharsalia*, and his work, says Dr Johnson, 'deserves more notice than it obtains, and as it is more read will be more esteemed.' His edition of Shakespeare (7 vols. 1709-10) at least contributed to the popularity of his author. Rowe's comedy, *The Biter* (1705), lived only to be damned as it deserved. Rowe, we are told, had no heart, yet his vivacity and engaging manners procured him many friends and several lucrative offices. The Duke of Queensberry made him his Under-secretary of State. In 1715 he succeeded Tate as poet-laureate; and the same year he was appointed one of the surveyors of customs to the port of London; the Prince of Wales made him Clerk of his Council, and the Lord Chancellor Parker secretary of Presentations in Chancery. He died December 6, 1718, and was buried in Westminster Abbey.

Rowing. The oarsman sits with his face to the stern of the boat, his feet planted flush against his 'stretcher' or footboard, and the handle of his oar in his hands, the loom of the oar resting in the rowlock, the 'button' being inside the thowl-pin. He should sit upright, with a rigid back, and do his work mainly with his back and legs, using his arms as couplings between his body and the oar-handle, and only bending them towards the finish of his stroke. To row a stroke, swing the body forward from the hips straight towards the toes; extend the arms rigidly, brace the shoulders, and keep the head up. The hands should be holding the oar-handle about $3\frac{1}{2}$ inches apart. The grasp should be with fingers and not fist—i.e. the lower knuckles of the hand should be very slightly bent, almost straight, the

hold being retained by the upper joints of the fingers and by the thumb. This mode of holding the oar gives freer play to the wrist-joints for the 'feather,' of which more anon. The body being thus extended, and the legs opened at the knees to allow the body free swing forward, and the hands thus grasping the oar-handle, then the stroke is begun by raising the hands enough to allow the blade of the oar to sink into the water square. (It is most important that the blade should be square to the plane of the surface of the water; otherwise, as soon as the stroke commences, the blade fails to preserve its own plane, and sinks too deep, or springs out of water, according as the face of it is inclined at an obtuse or acute angle to the water.) When the oar has been thus lowered into the water, by raising the hands over the stretcher, the stroke should commence—sharply, by bracing the muscles of back, loins, shoulders, and legs, and throwing the body backwards, swinging from the hips, the feet firmly pressing against the stretcher, the arms rigid; so that the weight of the body is eased as much as possible off the seat, and is transferred to the oar-handle and the stretcher. When the body has reached the perpendicular, in the swing, back the arms should begin to come in. The action of bringing them in should be from the shoulders, the elbow-joints gradually bending, but the forearm remaining as near as possible parallel to the water. The 'biceps' should not be exerted, else the forearms bend upwards, the hands rise, and the blade buries. The body should not 'wait' for the arms and hands to overtake it: it should be still swinging back till the hands overtake it.

When the hands reach the breast-bone they should be sharply dropped about two inches: this raises the oar out of the water. After this drop of hands they should be turned sharply from the wrists till the knuckles touch the body. This turn produces the 'feather.' If the turn is made too soon, before the hands have reached the chest, the action is faulty, and produces what is called 'feather under water,' by turning the oar edgewise in the water instead of after the oar has left the water. So soon as the drop and turn of wrists has ended and 'feather' has been performed, the 'recovery' should commence. The body should instantly, and without 'hang' or delay, commence to swing forward again like a pendulum. The hands should at the same instant be shot out and the arms extended, reaching their extension by the time that the body has once more attained the perpendicular in its forward swing. The swing should continue forward till full reach has been attained for a new stroke; then once more the hands should be raised, the oar lowered into the water, and a new stroke rowed. In rowing behind another oarsman the eyes should catch the back in front of the oarsman, who should take time and swing from it—keeping 'eyes in the boat.' The oarsman at first finds it difficult to 'govern' his blade—i.e. to keep it in the right plane—and at the correct elevation or depression, according to whether he is rowing the stroke or is 'recovering.' In time his wrists become more apt, and time their action to the ever-varying positions of the body. The more he attends to a correct grasp of his oar-handle the easier will be the play of his wrists, and the greater facility will he find in regulating the plane of his blade. It has been said before that the blade should be 'square' to the water throughout the stroke. So it appears to the oarsman; but in well-constructed boats the 'thowl' is slightly inclined in the direction in which the oarsman is looking; this inclination gives the oar-blade a correspondingly slight inclination forward, making it describe a trifle less than a rectangle with the water, and so obviates any tendency to

row 'deep.' It will suffice if the beginner thinks of keeping his blade 'square;' and the small deviation from the square, reducing the angle that is effected by the slope of the thowl for his benefit, will then be produced naturally by the mechanism of his work. If this inclination of the thowl is made too great the oar has a tendency to fly out of the water.

To stop the way of a boat she should be 'held.' This is done by laying the blade flat, and thus slightly sinking the edge which lies towards the direction in which the boat is travelling. This causes the blade to bury at an acute angle to the plane of the water. This checks the way until it is reduced enough to allow the oarsman to turn the blade square, reverse way, and to 'back' water. If he tries to back water with any pace on, before he has first 'held' the boat, the resistance to his blade not only risks fracture, but is likely to be beyond his strength, to lay him flat on his back, and to make him 'catch a crab.' In backing water the process of the stroke, described above, should be reversed, so far as circumstances will allow—i.e. the oarsman has no stretcher to press against, and is 'pushing' with his weight instead of 'pulling.' In most 'tub' boats, and in all racing boats, straps are laid across the stretcher, to hold the feet at the instep, and so to facilitate recovery. The strap should only be used as an adjunct to recovery, not as the sole means: the loins should play their part in swinging the body forwards; and the arms, by being rapidly shot out, should aid the action of the loins. If a tyro is found to rely too much on his strap, a mentor may with advantage remove the strap until proper use of the loins has been effected.

Sculling.—In sculling each hand holds one scull, instead of there being two hands on one oar as in 'rowing.' The principles of action of body, legs, and arms are the same as in rowing, except that the body, when sculling, may with advantage be swung farther back at each stroke than in rowing. The grip of a scull should be on the same principle, as regards holding in fingers and not in fist. The thumb should not clasp under the handle, but cap the butt of the scull with the top joint. In rowing this would be wrong; but in sculling it is found to secure the better hold, and to give freer play to the wrists for feathering. It is important that both hands should work together, both blades entering and quitting the water together, and both wrists feathering simultaneously. If one hand is later than the other the course of the boat is distorted at each stroke.

BOAT-RACING.—Virgil, in *Æneid*, v., describes a boat-race between four Trojan galleys; and the word 'regatta' is of Italian origin. But boat-racing may be said to be almost exclusively an Anglo-Saxon sport. Germans of late have slightly taken it up, but 95 per cent. of the sport is found in Britain and her colonies and the United States.

Eton and Westminster schools practised boat-racing in the early part of the century; thence the pastime seems to have spread to the universities. One of the earliest races of the century was between Westminster boys and the 'Temple' crew, in six oars, the boys winning. As early as 1815 college 'bumping' races in eight oars had begun at Oxford. In those days only three or four colleges manned eight. Cambridge adopted a similar sport at much the same date, or a year or so later. In 1829 the first Oxford and Cambridge match was rowed—Hambledon lock to Henley Bridge. The next was in 1836, Westminster to Putney; after that at intervals till 1856, since which date these matches have been annual. Up to 1898 Oxford had won 32 and Cambridge 22 of them. There was one 'dead heat' (1877). Also, five times have the U.B.C.'s been drawn together in the same

beat for the 'Grand Challenge' at Henley, of which Oxford won 3 and Cambridge 2 encounters; and once Oxford beat Cambridge in an encounter for the 'Gold Cup' at the now extinct Thames regatta of the 'forties.' 'Outriggers' were first used by the two university crews in 1846. Sliding seats were first used by them in 1873. 'Keelless' eights were first used by them in 1857. In 1845 the Putney to Mortlake course was first adopted for these matches. Outriggers are a contrivance for artificially extending the gunwales of a boat, so as to give the required leverage for the oar in the rowlock, while the rest of the hull is narrowed to offer less resistance to the water. The earliest application of the principle was with wooden outriggers on the Tyne before 1836. Iron outriggers were first used by H. Clasper for a Tyne firm in a Thames regatta in 1844.

Professional Racing.—The earliest recorded professional champion sculling race was in 1831, when one Campbell, Thames waterman, beat one Williams for the championship of the Thames from Westminster to Putney. In 1847 the Putney to Mortlake course was first adopted for these watermen's matches. In 1859 the title first left the Thames, and was won by R. Chambers of the Tyne. It oscillated between the representatives of these rivers, aliens and colonials now and then competing unsuccessfully, until 1876, when E. Trickett of Australia beat J. Sadler of the Thames. Since that date the sculling premiership has oscillated between Canada and Australia; E. Hanlan of Toronto, W. Beach of Sydney, and W. Searle of Sydney being the most noted holders. In 1889 Searle the holder died; and there being no tribunal to decide which two of various aspirants had the first claim to compete for the vacancy, or how many must compete before a new premier could be recognised, some doubt arose as to which, M'Lean or Stansbury of Australia or O'Connor, United States, had the best claim at this moment to the honour.

The 'Amateur Sculling Championship' is symbolised by the 'Wingfield Sculls,' established in 1830. The trophy now carries with it the amateur championship of England. The holder has to meet the best of all challengers once a year, on a date fixed by a committee of old champions, about July, or to abandon in favour of the best challenger.

Regattas.—Henley regatta was founded 1839. In 1886 the course was changed as to some 300 yards of its length, to avoid a corner which gave unfair advantages. It is now a three days' meeting, and comes off early in July each year. The prizes are 'Grand Challenge,' for best eight oars; 'Stewards' Cup,' for best four oars; 'Ladies' Plate,' for college and school eights; 'Thames Cup,' for second-class eights; 'Wyfold Cup,' for second-class fours; 'Visitors,' for college and school fours; 'Silver Goblets,' for any pair of oarsmen; and 'Diamond,' for sculls. By first and second class eights and fours are meant the classes which usually compete at the races referred to—e.g. no one who rows for 'Grand Challenge' may row for 'Thames Cup' the same year; nor if he rows for 'Stewards' fours may he row in a Wyfold crew; and as the 'Grand' and 'Steward' are the more valuable prizes, the better eights and fours usually elect to do battle for them, and the weaker reserve themselves for the lesser races. There are other regattas of less importance—e.g. 'Metropolitan,' on the Thames tideway, Kingston-on-Thames, Walton-on-Thames, Moulsey, Reading, &c.; and provincial regattas at Tewkesbury, Bridgnorth, Worcester, Tyne, Durham, Burton-on-Trent, Bedford, &c.

The best regattas affiliate themselves to the 'Amateur Rowing Association,' a sort of jockey club of oarsmanship, the object of which is to pro-

mote rowing, and to put a stop to performances inconsistent with amateur status—e.g. rowing for money prizes, and the introduction of competitions against artisans, mechanics, &c. Such classes, by making a business of muscular toil, have an advantage for muscular development over amateurs, whose more sedentary vocations give them less opportunity for developing muscle. At the same time it is the opinion of good judges that at the present day the best amateur oarsmen would in rowing defeat the best professional oarsmen. In sculling, apparently, the best colonial professional scullers are still superior to the best British amateur scullers; but the British professionals are probably no better than, if so good as, the average amateur Wingfield sculler of the present day. The Amateur Rowing Association publishes a code of regatta rules. All regattas which are affiliated to the Amateur Rowing Association adopt this code. Oarsmen who row at regattas where this code is not in force become thereby ineligible to row afterwards at regattas where it holds good.

Professional Regattas and Prizes.—A professional regatta for watermen was revived in 1890 and promises to continue. It is under the patronage of the leading amateurs of the day. There were similar regattas between 1843 and 1849 inclusive, again between 1854 and 1866 inclusive, and again between 1868 and 1876 inclusive. In the other years not specified no local professional regattas were conducted by leading amateurs; but in 1876-77-78 a 'speculative' regatta for gate-money and traffic purposes was got up by the Steamboat Company and contingent railways. 'Doggett's Coat and Badge' is an old-established race dating from 1719. Mr Doggett, a comedian, provided it. It is for watermen's apprentices; the winner gets an ornamental red coat, a silver badge, and 'freedom' of the Thames—i.e. his fees for taking up his freedom as a waterman are paid for him. No one who is not 'free' of the Thames may ply for hire upon it to carry passengers. This regulation dates from days when the Thames was more of a highway for passenger rowing boats than it now is. Watermen's wherries then plied from numerous stairs, and it was important that none but competent and certified oarsmen should have the charge of passengers. There are other coats and badges extant, given at divers times by philanthropists to encourage watermen's apprentices. An apprentice has to serve seven years to a waterman before he is qualified to be 'free' of the river.

Bumping Races.—In 'bumping' races at the universities the various boats start in line, 120 feet apart, by signal of cannon. The order of starting depends on order of precedence in the last previous race, whether the same year or the year before. If a boat is touched from behind in the race, both boats row into the bank, and the 'bumped' boat loses a place and changes order next time with the boat that so 'bumped' it. The head boat of the river at Oxford holds a challenge cup given in 1862 by the late Mr G. Morrison.

Time Races.—At Oxford and Cambridge, owing to the narrowness and curvatures of their respective rivers, other races, such as for four oars or sculls, are rowed as 'time' races. The boats start two at a time, 80 yards apart, their respective winning-posts are the like distance apart, and their respective arrivals at their goals are announced by pistol shots.

Level Racing Rules, &c.—In regattas and matches boats start abreast, and in modern times to ensure equal starting the rudder of each competitor is held from a starting-boat, one for each racing crew, moored in line. 'Fouling' is not allowed; each boat has to keep its own water; the umpire is sole judge of the course and of fouling, and usually follows the race in a fast eight or steam-launch.

All boats abide by their accidents—e.g. of broken gear or upsets.

Sliding Seats.—The use of sliding seats began in 1871 in England. Americans had previously used but thought little of the novelties. A Tyne crew, captained by F. Taylor, matched against another Tyne crew, used such seats in a match, November 1871, and won with them. Next year four Henley crews adopted them with marked success, and the London Rowing Club used them in a winning match v. Atalanta Rowing Club, of New York. In 1873 they became universally adopted. Leading amateur clubs prohibit use of slides by their beginners, till swing on fixed seats has been first mastered, else there is a tendency in a tyro to sacrifice swing to slide. Slide should conclude with swing. The slide should be held till the body is nearly or quite perpendicular in the swing back. Then the slide may be released, and the legs should be extended gradually, the extension to terminate contemporaneously with the oar reaching the chest.

Faults in Rowing.—A 'coach' or tutor of a crew endeavours to cure faults by admonition, so as to get his crew into 'form' and style. Uniformity of oars and of action of bodies has much to do with pace in a racing boat, though, of course, strength is also an important factor. Still a strong oar who mars uniformity among his comrades often does more harm than good, and is well replaced by a lighter and neater oarsman. Among salient faults may be specified 'rowing out of time,' by letting the oar enter or leave the water too soon or too late; 'rowing light'—i.e. not covering the blade; 'rowing deep'—i.e. burying the shank as well as the blade of the oar; 'feathering under water;' 'sliding too soon' or too suddenly. Among 'faults of swing' are 'hanging' with the body before recovery, or when forward before dropping the oar in; delay in shooting out the hands; 'bending the arms' too soon; bending the back in the middle of the stroke instead of swinging from hips; hunching the shoulders; 'screwing'—i.e. not swinging straight in a line with the keel; 'meeting the oar'—i.e. swinging to meet the oar-handle instead of rowing it well home; 'rowing short'—i.e. not swinging to full reach forward.

Stroke and 'No. 7.'—A 'stroke' is selected to set a good style to the men who are to copy him. Hence style more than rough strength is of importance for this post. A stroke should be lively in swing; sharp in catching hold of the first part of the stroke; long in reach; even in swing; even in time, like a pendulum; a good judge of the pace of stroke which he is rowing; capable of 'spurning'—i.e. of quickening the pace of stroke when extra speed is needed, and this without getting short in reach. Thirty strokes a minute is a fair practice stroke. In racing for a mile or mile-and-half course as many as forty-four a minute can be rowed long by good crews. Over a four mile course thirty-seven a minute, well rowed at full length of reach, is about as much as can be done, excepting a final 'spurt.' 'No. 7' is second to none in importance in an eight oar. He couples stroke to the crew. The best man in the team should if possible be placed here; a weak No. 7 takes many points of merit off a crew, and cripples the work of good but rough men behind him.

Steering.—Four oars are now rowed without coxswains, except in junior or second-class races. One of the oarsmen steers with levers attached to his stretcher and connected with the rudder by wires. In an eight, a coxswain is an important factor; he should have nerve and judgment, and be capable of reminding his crew of faults, when, as in a race, no 'coach' or mentor can attend them. The main art in steering is to keep the

boat in a straight course by gentle touch and adjustment of the rudder lines, not by hard pulls, which tend to spoil equilibrium, and to bring the boat round too sharply. In going round a curve the bows should not be expected to point in the direction required. They must of necessity point outwards, because the boat lies as a tangent to a curve.

Rowing Clubs.—Among leading amateur rowing clubs, besides the universities, may be mentioned the Leander, the London Rowing Club, Thames Rowing Club, Kingston, Moulsey; these usually supply the competitors at Henley, together with the universities. There are good provincial clubs at Durham, Worcester, Bridgnorth, Bedford, Huntingdon, Burton, &c. Among schools Eton, Radley, Westminster, Magdalen (Oxford), Bedford 'Grammar' and Bedford 'Modern' supply good oarsmen—Eton especially. Of university crews nearly one-half are made up on the average of old Etonians.

Training.—'Condition' promotes endurance in a contest, whether of horse or man. Hence training is an important item in preparation for a boat-race. Hard work trains; regulated diet keeps the oarsman up to this hard work, and puts on extra muscle to replace fat which hard work has sweated off. Five weeks is a minimum time for full training where oarsmen have been out of work for some time; a shorter period may suffice if they have not been inactive for long. Professionals usually train for three months before a match. The usual rules are early rising—say 7 A.M.—a short morning walk, bath, breakfast, morning row (if studies or business hours admit of it), luncheon or mid-day dinner, afternoon or evening row (according to season of year), late dinner or supper, a short post-prandial stroll, a cup of gruel or chocolate, and bed for nine hours. After each row the body should be well washed and rubbed down. As to diet. For breakfast: beef or mutton, cold or broiled; some fish, if wanted; an egg; water-cress or lettuce; and two cups of tea; stale bread or toast. Luncheon: cold meat and some green food; or broiled meat and vegetables. Dinner: fish; joints of beef or mutton; vegetables—any greens, asparagus, spinach, a potato or two, &c.; now and then a modicum of poultry as an extra course; stewed fruit; rice or plain farinaceous pudding. Drink: at luncheon or dinner, ale, claret and water, or champagne. A pint at each meal usually suffices; in sultry weather a little more fluid may be allowed, in which case it is best to let the extra supply be water only. Oranges or strawberries are allowed for dessert, and a glass or two of claret or one of port. Pork and veal are tabooed, as being indigestible in the large quantities which hungry men consume. Such is modern training. In earlier decades less liberality was allowed. Steaks, chops, and plain joints formed the staple supplies, and the hobby was to have them 'underdone,' almost to semi-rawness. This system often produces disorder of blood, resulting in boils, the effect of too much animal food without sufficient green meat. Professionals still adhere to old creeds of training more tenaciously than do modern amateurs.

See *Rowing* by Rowe and Pitman (Badminton series, 1898); *Rowing* by Lehmann (Isthmian series, 1897); *Boating* (1888), *Rowing and Sculling* (1889), and *Oars and Sculls* (2d ed. 1889), by the present writer.

Rowlandson, THOMAS, caricaturist, was born in the Old Jewry in July 1756. He was sent to Paris at fifteen, and here he studied art and gained a taste for the pleasures of the town. The over-indulgence of a wealthy French aunt first taught him improvidence, and the £7000 she left him he quickly gambled away, once continuing at the gaming-table, we are told, for thirty-six hours continuously. Yet he maintained his uprightnes

of character, hated debt, and when he had played the fool turned to his work as his resource. He travelled over England and Wales, often visited Plymouth, Portsmouth, Southampton, and especially Yarmouth, and, being a humorist to the marrow, enjoyed life to the full in his tavern, with his tankard and his pipe, and the company of friends like Moreland, Gillray, and Bunbury. He died April 22, 1827. Rowlandson took little pains over his work, yet his drawings never lack the essential elements of his strength, variety, and humour. He possessed rare dexterity of touch, fertility of imagination, and knowledge of the human figure, and, though he was not seldom vulgar, he was never feeble. He was a relentless hater of Napoleon to his fall, belittling his greatness by countless travesties; and though he took his part in many of the political contests of his day, he was never a mere party satirist. His strength lay in broadly human humour, as seen at its richest among the lower orders of the population, as in his famous Vauxhall drawing. Some of his best-known works are his *Imitations of Modern Drawings* (1784-88), and his caricature illustrations to Syntax's *Three Tours*, the *Dance of Death*, the *Military Adventures of Johnny Newcome*, Sterne's *Sentimental Journey*, Peter Pindar, the *Bath Guide*, *Munchausen's Travels*, &c.

See Joseph Grego's exhaustive *Rowlandson the Caricaturist* (2 vols. 1880).

Rowley, WILLIAM, an actor and playwright under James I., of whose life but little is known, save that he was honoured by collaborating with such illustrious dramatists as Dekker, Middleton, Heywood, Webster, Massinger, and Ford, most probably for his skill in stage situation, not less than the amiability of his character. Four plays connected with his name are extant: *A New Wonder, a Woman never veat* (1632, in vol. xii. of Dodsley); *All's Lost by Lust*, a tragedy (1633); *A Match at Midnight* (1633); and *A Shoemaker a Gentleman* (1638).

Rowley Regis, a town of Staffordshire, 3 miles SE. of Dudley, within whose parliamentary limits it partly lies. The parish church dates from the 13th century, but was rebuilt in 1840 (the tower in 1858). There are collieries, ironworks, stone-quarries, potteries, implement-works, and breweries. Pop. (1851) 14,249; (1891) 30,791.

Rowton Heath, a battle of the Great Rebellion, fought under the walls of Chester, September 24, 1645. After the crushing disaster of Naseby the king fled to Wales, and next formed the desperate project to march northwards to Montrose. The city of Chester was then being besieged by Sir William Brereton, but the king succeeded in finding an entrance, and charged Sir Marmaduke Langdale to raise the siege. The parliamentarians had just been reinforced by Poyntz's Yorkshire horse when Sir Marmaduke attacked them. He was utterly defeated, with a loss of 300 killed and 1000 prisoners, and the disaster, added to Philiphaugh, stripped the unhappy king of his last hope.

Roxburgh Club. See BOOK-CLUB.

Roxburghiaceæ, a natural order of monocotyledonous plants, perhaps better called *Stemonaceæ*. The species are very few, natives of the hotter parts of the East Indies. The stems of *Roxburghia* (*Stemona viridiflora*, a native of Chittagong, the Malayan Islands, &c.), are sometimes 100 fathoms long. The thick tuberous roots are boiled and soaked in lime-water, to remove their acridity, and are then candied with sugar and taken with tea, but are considered rather insipid. The name was given by Sir Joseph Banks, in honour of the botanist Roxburgh.

Roxburghshire, a Scotch Border county, bounded by Berwickshire, Northumberland and Cumberland, Dumfriesshire, Selkirkshire, and Midlothian. Its greatest length is 42 miles; its greatest breadth 30 miles; and its area 670 sq. m., or 428,494 acres. In the north the Tweed winds 25 miles eastward, receiving in this course Gala and Leader Waters and the Teviot, which last runs 37 miles north-eastward from above Hawick to Kelso, and itself receives the Ale, Slitrig, Rule, Jed, &c. Thus the whole county, often called Teviotdale, drains to the German Ocean, with the exception only of Liddesdale, or Castleton parish, in the extreme south, whose 106 sq. m. belong to the western basin of the Solway Firth. The Cheviots (q.v.) extend along the south-eastern boundary, their highest point here Auchopecairn (2382 feet); in the interior rise Ruberslaw (1392) and the triple Eildons (1385). Much of the low ground is of fair fertility, and great improvements have been made in agriculture; but rather less than two-thirds of the entire area is in cultivation, and the raising of crops is of much less importance than the grazing of half a million sheep. Rents, however, increased two- or threefold, or even fourfold, between 1750 and 1815, and the county valuation advanced steadily from £254,130 in that year to a maximum of £439,860 in 1877, since which date it has again declined considerably owing to agricultural depression. Roxburgh, which gave the county its name, has been quite superseded by Kelso (q.v.); and Jedburgh, the county town, is very much smaller than Hawick; other places are Melrose, Denholm, St Boswells, Yetholm, &c. Chief seats are Floors Castle, Mount Teviot, Minto House, and Abbotsford; and the dukes of Buccleuch and Roxburgh are much the largest proprietors. The antiquities include hill-forts; long stretches of the Catrail and Watling Street; the castles or peel-towers of Hermitage, Branxholm, Harden, Ferniehirst, Smailholm, &c.; and the noble monastic ruins of Melrose, Jedburgh, and Kelso. Besides many more worthies, four poets—James Thomson, Jean Elliot, Leyden, and Aird—were natives; but, although not his birthplace, Roxburghshire is pre-eminently the land of Scott. It witnessed many a fray, but no battle greater than Ancrum Moor (q.v.). The county returns one member to parliament. Pop. (1801) 33,721; (1831) 43,663; (1861) 54,119; (1891) 53,741.

See Jeffrey's *History of Roxburghshire* (4 vols. 1857-64), and other works cited at BORDERS, BALLAD, HAWICK, TWEED, MELROSE, &c.

Roxbury, formerly a separate city of Massachusetts, annexed in 1867 to Boston (q.v.), of which it forms the 13th, 14th, and 15th wards. Pop. (1870) 34,772; (1890) 66,791.

Roy, WILLIAM, the first of British geodesists, was born May 4, 1726, at Miltonhead, in Carlisle parish, Lanarkshire, his father being factor and gardener to the Hamiltons of Hallcraig. He was educated at the parish school and Lanark grammar-school, and in 1747 is found acting as deputy-quartermaster in the Royal Engineers corps, engaged on the survey of Scotland. His name first figures in the *Army List* in 1757, and he gradually rose to be lieutenant-colonel (1764), colonel (1777), and major-general (1781). In 1783 he undertook as a labour of love to measure a base line (see ORDNANCE SURVEY) on Hounslow Heath, of 27,404½ feet, or about 5¼ miles, which, though the first measurement of the kind in Britain pretending to accuracy, was executed with such care that, on being remeasured after Roy's death, the difference between the two results was found to be only 2½ inches. For this splendid labour Roy received the Royal Society's Copley medal. His

labours connected with the work extended from July 1787 till September 1788, when he returned to London in ill-health, which necessitated his removal to the warmer latitude of Lisbon in the winter of 1789; but he returned to London, and died there suddenly, 30th June 1790. In 1767 Roy was elected a Fellow of the Royal Society, to whose *Transactions* he contributed, in 1777, 'Experiments made in Britain to obtain a Rule for Measuring Heights with the Barometer.' He had also during survey-work in Scotland (1764) paid particular attention to the camps and other Roman remains in that country, and his *Military Antiquities of the Romans in Britain* was published in 1793 by the Society of Antiquaries. Roy was also surveyor-general of the coasts of Great Britain.

See two articles in the *Proc. Soc. Antiquaries Scot.* (i. p. 147, 1855; and ix. p. 562, 1873).

Royal Academy. Previous to the foundation of the Royal Academy various more or less successful attempts had been made in England to raise the status of artists, to consolidate their aims and efforts, to provide means for presenting their works to the public, and to furnish systematic art instruction. The succession of art schools from Kneller to Shipley is given at ART INSTRUCTION (Vol. I. p. 456). In 1745 Hogarth and others, with the view of making their works known, presented certain of them to the Foundling Hospital. The public having been greatly attracted, they, in 1760, opened a free exhibition in the rooms of the Society of Arts; and, in the following year, a series of exhibitions was begun in Spring Gardens, and its promoters, styled 'The Incorporated Society of Artists of Great Britain,' received a royal charter in 1765. Disputes having arisen, twenty-nine members of this society (not—according to Redgrave—twenty-two only, as stated by Sandby) memorialised George III. to establish an academy for the encouragement of the arts of design, and the plan they submitted having been approved, the 'Royal Academy of Arts in London' was founded, 10th December 1768. The 'Instrument' of foundation provided for forty academicians, from whom the president and other officials, including professors of fine art in its various branches, should be elected; and annual exhibitions were stipulated for, their proceeds to be devoted to the aid of indigent artists and to the support of the Academy. In 1769 a class of twenty associates (to have no share in the government of the body, a restriction since modified) was created, and also a class of six associate-engravers, on the same footing, excepting that they were ineligible for election as academicians, a restriction now withdrawn. In 1780 George III. assigned rooms to the academy in Somerset House, and during twelve years he contributed £5116 to its funds from the privy purse. As tersely stated by Redgrave, 'the strength of the new institution consisted in its combining, under a well-framed code of laws, the most esteemed artists of the day, empowered to manage their own affairs.' Thirty-nine artists are named in the instrument of incorporation, including Reynolds, Gainsborough, and Richard Wilson, and ten of them were foreigners; Sir Joshua was, by acclamation, elected the first president. The management and results of the Royal Academy formed the subject of parliamentary inquiry in 1835-36, and in 1863. See Sandby's *History of the Royal Academy* (1862).

The Royal Hibernian Academy was founded by charter in 1823, consisting of fourteen academicians and ten associates, and its first president, Francis Johnston, presented ground and erected buildings thereon for the use of the body.

The Scottish Academy, the successor of such exhibiting bodies as the society of 'Associated

Artists' and the Royal Institution, was founded in 1826, under the presidentship of George Watson, consisting of thirty academicians and sixteen associates (the latter increased in 1830 to twenty). In 1838 it received a charter, entitling it to the style of 'The Royal Scottish Academy of Painting, Sculpture, and Architecture;' and in 1891 a supplementary charter was granted, admitting associates to a share in the management of the body, and removing any limit to their numbers (but providing that only twenty shall participate in the pension fund), and granting extended powers for dealing with non-resident and non-exhibiting members. See Sir G. Harvey's *Notes of the Early History of the Royal Scottish Academy* (2d ed. 1873).

Royal Academy of Music, the name first given in England to an association for performing operas, mainly those of Handel, founded by the king and the principal nobility and gentry of the country, which survived for but a few years. The well-known educational institute now bearing the name was founded in 1823 by Lord Burghersh (1784-1859, afterwards eleventh Earl of Westmorland, and not less distinguished as a musician than as soldier and diplomatist), who saw with regret the great disadvantages under which natives of Great Britain suffered as compared with those of foreign countries in respect of musical education. The institution, which received a charter in 1830, was designed to give concerts as well as to provide musical education; and it has instructed many of the leading instrumentalists and vocalists of both sexes. Since its reconstitution in 1866 the most distinguished principals have been Sir George Macfarren (1876-87) and Dr A. C. Mackenzie (appointed 1888). The Royal Academy of Music is distinct from the Royal College of Music (see CONSERVATOIRE), though allied with it for promoting musical education throughout the country by means of an 'Associated Board.'

Royal Assent. See PARLIAMENT; and for royal prerogative, &c., see SOVEREIGN, WARRANT, SUPREMACY, COMMISSIONS, CHARTER, BOUNTY, HOUSEHOLD, HUMANE SOCIETY. For the Royal Arms, see HERALDRY; also CIVIL LIST, SOCIETIES.

Royal Family. By the law of England royal rank is conceded to the wife or husband, children or other descendants, and collateral relatives of the sovereign. For the position and rights of a Queen-consort or Queen-dowager, see the article QUEEN. The husband of a reigning queen does not acquire any share in her prerogative rights, but it is usual to grant him special precedence; King Philip and William III. were associated in title and power with their wives by act of parliament. Of the sovereign's children the eldest son is, of course, heir-apparent; he is born Duke of Cornwall, and he is always created Prince of Wales (q.v.). The Prince and Princess of Wales and the Princess Royal (the eldest daughter of the sovereign) are within the protection of the statute of Edward III. relating to Treason (q.v.). An heir-presumptive to the throne has no special rank or precedence as such. The younger children of the sovereign take rank after the heir-apparent; by a statute of 1540 a place is assigned to them at the side of the cloth of estate in the parliament chamber; it is customary to confer peerages on all the younger sons. On a reference by George II. to the House of Lords it was held that Edward, Duke of York, second son of the Prince of Wales, was entitled to a place among the king's children. Members of the royal family enjoy considerable privileges; they pay no tolls or duties, and they are exempted from succession duty and some other taxes.

In order to protect the succession to the crown against the dangers which might arise from unsuit-

able alliances, the following special rules are applied to members of the royal family: (1) By the Royal Marriage Act of 1772 it is enacted that no descendant of George II. (other than the issue of princesses married into foreign families) may marry without the consent of the sovereign; any marriage contracted without such consent is void. But any such descendant, if above the age of twenty-five, may, after twelve months' notice to the Privy-council, contract marriage without such consent, unless both Houses of Parliament declare their disapproval. All persons who solemnise or are present at a marriage contrary to the act are liable to the penalties of *præmunire*. The act was passed in consequence of the marriage of the Duke of Gloucester with the widow of Lord Waldegrave and of the Duke of Cumberland with the widow of Colonel Horton. In 1793 the Duke of Sussex was married at Rome to Lady Augusta Murray; the marriage was declared void by the Prerogative Court, and the claims of Sir Augustus d'Este, eldest son of the marriage, were rejected by the House of Lords in 1844. (2) The grandchildren of the sovereign (not being the issue of princesses married to foreigners and residing abroad) are under the control of the sovereign, who may order the place of their abode, without regard to the wishes of their parents. The law was so laid down by a majority of the judges in the case of the children of Frederick, Prince of Wales, in 1737. The policy of these rules has been much questioned, and the conduct of George IV. in regard to his marriage with Mrs Fitzherbert (q.v.) in 1785 affords a strong argument against the existing law.

The civil list being found inadequate to the maintenance of the royal family, Queen Victoria was empowered to grant to various members of her family, annuities payable out of the Consolidated Fund; these aggregated £188,000 per annum at the time of her death. Any proposed grant to a royal personage is tolerably certain to be opposed in the House of Commons; the arguments in favour of such grants were forcibly stated by Mr Gladstone in his speech on the proposal to make provision for the children of the Prince of Wales, delivered during the session of 1890.

Royal Fern (*Osmunda*), the most striking of British ferns; it grows in damp places, and used to



Royal Fern (*Osmunda regalis*):
a, leaflet of barren frond; b, portion of fertile frond.

be fairly common in the districts of Scotland and Ireland of a very moist climate, but is disappearing

before collectors. It has two kinds of leaves, sterile and fertile; the sterile are bipinnate; the fertile, covered with spore-cases, have the appearance of a pinnated inflorescence, due to the absorption of the central tissues—hence the name Flowering Fern. The genus is allied to another, *Todea*, which has only one kind of leaf, and the two are included in the order Osmundaceæ. There are only a very few species. The order occupies a position between the typical ferns and the Marattiaceæ. The spores give rise at once to the prothallium without the intervention of a protonema; and the prothalli tend to be unisexual—i.e. to have the male and female organs on separate plants; or the male organs appear on the prothallus before the female. The bases of the leaves and root-stocks are rich in mucilage, which, being extracted by boiling water, is sometimes used in north Europe instead of starch.

Royal George. See WRECKS.

Royal Institution, founded in 1799 by Count Rumford, Sir Joseph Banks, and others, received a royal charter in 1800, and had for its objects the facilitating of mechanical inventions, the promotion of their use, and the teaching of science and its applications by means of lectures and experiments. It was reconstituted in 1810. Among its lecturers have been Thomas Young, Davy, Brande, Faraday, Tyndall, Frankland, and Rayleigh. It maintains professors of natural philosophy, chemistry and physiology, and has laboratories (including since 1896 the Davy-Faraday research laboratory presented by Dr Ludwig Mond).

Royal Military Asylum, an institution at Chelsea for educating the sons—generally orphans—of British soldiers. For these there are a model school and an infant school, and the boys have a completely military organisation, with scarlet uniform, band, &c. The school was originally established in 1803 by the Duke of York, whence it is still commonly known as the 'Duke of York's School.' There is a similar institution, the Royal Hibernian Military School, at the Phoenix Park, Dublin. As a result of their training a large proportion of the pupils ultimately volunteer into the army; and the military bands are largely recruited from these schools. See MILITARY SCHOOLS, BAND.

Royal Society. The origin of this society may be traced back to those stirring years of civil strife that brought in the Commonwealth. Clubs for political, theological, and sectarian purposes were then numerous and active; and in the year 1645 'divers worthy persons, inquisitive into natural philosophy, and other parts of human learning, did, by agreements, meet weekly in London on a certain day, to treat and discourse of such affairs.' Among these worthy persons were certain medical men, Dr Wilkins, afterwards Bishop of Chester; Foster, professor of astronomy in Gresham College; Wallis, the mathematician; and others, including Haak, a learned German from the Palatinate; and out of their meetings arose the now world-famous Royal Society. Wallis records that the subjects discoursed of were 'the circulation of the blood; the valves in the veins; the venæ lacteæ; the lymphatic vessels; the Copernican hypothesis; the nature of comets and new stars; the satellites of Jupiter; the oval shape of Saturn; the spots in the sun, and its turning on its own axis; the inequalities and selenography of the moon; the several phases of Venus and Mercury; the improvement of telescopes, and grinding of glasses for that purpose; the weight of air; the possibility or impossibility of vacuities, and nature's abhorrence thereof; the Torricellian experiment in quicksilver; the descent of heavy bodies, and the

degrees of acceleration therein; and divers other things of like nature.' In 1662 the persevering 'philosophers' (as students of the mathematical and natural sciences were then usually called) were, through the 'grace and favour' of Charles II., incorporated by charter, in which they were described as the Royal Society of London for the Promotion of Natural Knowledge. The king gave them also a mace, and subsequently granted two other charters conferring additional powers and privileges. They are inscribed in a handsome volume known as the Charter Book, which, containing, as it does, the sign-manual of the founder, of other royal personages, and of nearly every Fellow elected into the society, presents a collection of autographs unequalled in the world.

Through many difficulties the young society pursued their way. Their meetings were interrupted by the plague and the great fire; but in March 1664-65 they had published the first number of the *Philosophical Transactions*, and thus commenced a record of their labours and researches, and at the same time a history of science of the highest value, which now comprises upwards of one hundred and eighty quarto volumes. Besides this, the society publish an octavo serial entitled *Proceedings*, in which an account of the ordinary meetings is set forth. This serial was commenced in 1800, and now fills over forty-eight volumes. Another publication, in eleven quarto volumes, is the *Catalogue of Scientific Papers*, containing the titles of scientific papers published in all parts of the world from 1800 downwards. This great work, invaluable for purposes of reference, was compiled at the cost of the society, and gives in methodical form a record of the scientific progress of the century. These works are not restricted to the Fellows, but are sold to the general public. By increase of numbers—including scientific men on the Continent, who were elected as foreign members—the society widened their sphere of usefulness. They promoted the publication of Newton's *Principia* and optical works; they lent instruments to Greenwich Observatory in its early days, and were appointed visitors of that establishment by Queen Anne—a function which they still exercise; they aided travellers and scientific investigators; through force of circumstances, they became the advisers of the government on scientific subjects; Cook's celebrated voyage to observe the transit of Venus was undertaken at their instance; and from the voyage of the *Endeavour* down to the voyage of the *Challenger* it would be difficult to specify a scientific expedition which had not been equipped under the advice of the Royal Society. In 1710 the society removed to a house which they bought in Crane Court, Fleet Street. In 1780, by order of George III., quarters were assigned to them in the then new palatial building, Somerset House. There they abode until 1857, when, at the request of the government, they migrated westward to Burlington House, a wing of which they now occupy.

The society's session commences on the third Thursday in November, and ends on the third Thursday in June. During this period meetings are held weekly at 4.30 P.M. for the reading and discussion of papers, and these papers are for the most part afterwards published in the *Proceedings* or the *Philosophical Transactions*. The anniversary meeting is held on November 30. At that meeting the society elect a council to carry on their work through the ensuing year. This council, comprising president, treasurer, and secretaries, numbers twenty-one persons. The number of candidates for election into the society averages between fifty and sixty every year. From these the council elects fifteen, whose names are printed and sent to every Fellow, and in June the annual meeting takes place

at which the fifteen are elected; but any Fellow is at liberty to alter the list of names. There are in all about 500 Fellows, including 50 foreign members. The society's income is derived from funded and landed property, and the annual contributions of the Fellows. Each Fellow contributed £4 yearly, or paid a life-composition of £60, with an admission fee of £10, till, a few years ago, a fund was raised to abolish admission fees and reduce the annual contribution to £3. Each Fellow is entitled to the *Philosophical Transactions* and *Proceedings*, and to the use of the library of about 45,000 volumes. The society formerly undertook the administration of the £1000 annually voted by parliament for scientific purposes, and also assisted in the administration of an additional grant. In 1882 a single grant of £4000 was substituted for the fund and grant of past years. The society also assists in the naming of the Meteorological Council, which receives a government grant. The president is a trustee of the British Museum. In fulfilment of trusts the society award annually, in recognition of scientific work and discoveries, the Copley medal and two Royal medals; the Rumford medal every two years for researches in light or heat; and the Davy medal for chemical investigations. Some of the most illustrious names in the annals of science appear on the roll of presidents of the Royal Society.

The ROYAL SOCIETY OF EDINBURGH, which took the place of the Philosophical Society of that city, was incorporated by royal charter in 1783. It owed its origin to Principal Robertson the historian, who successfully laboured to found in Edinburgh a society on the model of the Berlin Academy, for the investigation and discussion of subjects in every branch of science, erudition, and taste. In obtaining the royal charter the Principal was aided by the influence of Henry, Duke of Buccleuch, who zealously co-operated in the foundation of the society. The society was formally constituted at a meeting held in the College Library on the 23d June 1783, where the subsequent meetings were held till 1810, when the society purchased a house in George Street. In 1826 the society removed to its present apartments, leased from government, in the Royal Institution buildings in Princes Street. The original list of members included the names of most of the literati of Scotland—such as David Hume, Dugald Stewart, Henry Mackenzie, Adam Smith, Thomas Reid, Joseph Home, Sir James Hall, Joseph Black, James Hutton, and James Watt. The first president was Henry, Duke of Buccleuch; and amongst his successors have been Sir Walter Scott, the Duke of Argyll, Sir David Brewster, and Sir William Thomson.

The meetings of the society are held on the first and third Mondays of every month from December to July. The funds derived from fees are supplemented by an annual grant of £300 voted by parliament. The papers read before this learned body are published in its *Transactions*, of which thirty-five volumes have been published in quarto. Abstracts of the papers also appear in its *Proceedings*, of which seventeen volumes have appeared in octavo. The number of ordinary Fellows is about 490, of honorary British Fellows 20, and of honorary Foreign Fellows 36. The society has the disposal of some valuable prizes, which are bestowed on the authors of the best communications on scientific and other subjects. These are the Keith Prize, founded by Alexander Keith of Dunnottar; the M'Dougall Brisbane Prize, by Sir Thomas M. Brisbane; the Neill Prize, by Dr Patrick Neill; and the Gunning Victoria Jubilee Prize, by Dr R. H. Gunning. See the history of the society in Neill's index to the *Transactions*.

Royalty, originally the seigniorage paid to the crown for a manor of which the king is lord, or a

tax paid to the king for lands or to a superior as representing the crown; but most familiar nowadays in two derived senses of modified signification. **Royalty** is the term for the sum paid on minerals removed from a mine, not necessarily to the crown, but to the landlord, on the theory that the landlord owns the soil to the centre of the earth, and accordingly all the minerals found beneath his land (see **MINING**). This burden is frequently regarded as a grievance, and its abolition, with or without compensation, advocated by advanced politicians. Another sense of the word is the sum paid to the holder of a patent, by percentage for each article manufactured under the patent, or for the use of patent articles hired out by the patentee (see **PATENTS**).

Royan, a small seaport of France (dept. Char-enté-Inférieure), stands on the north side of the estuary of the Gironde, 60 miles NW. of Bordeaux. It is one of the most frequented seaside places on the Atlantic coast of France, attracting 20,000 visitors every year. Its people catch sardines (called *royans* locally). There are beautiful woods, a museum, a casino, &c. Pop. 5629.

Royat, a watering-place in the French department of Puy de Dôme, occupies a beautiful site 3 miles SW. of Clermont-Ferrand, and has numerous chalybeate, alkaline, and arsenical springs, (80°-95° F.), the waters of which have been used since Roman times. Pop. 1499.

Roy Bareilly. See **RAI BARELL**.

Royer-Collard, **PIERRE PAUL**, a French statesman, was born 21st June 1763, at Sompuis (dept. Marne). On the outbreak of the Revolution he was elected a member of the municipality of Paris, and from 1790 to 1792 acted as joint-secretary. Having incurred the enmity of the Jacobins, he lived in hiding at Sompuis during the Reign of Terror. Three years afterwards (1797) chosen to the Council of the Five Hundred, he took an active part in the work of that assembly, until the 18th Fructidor. In 1811 he was appointed professor of Philosophy in Paris, and exercised an immense influence on the philosophy of France. Rejecting the purely sensuous system of Condillac, he gave special prominence to the principles of the Scottish school (see **SCOTTISH PHILOSOPHY**) of Reid and Stewart. Strongly 'spiritualist' as opposed to materialism, he originated the 'Doctrinaire' school, of which Jouffroy and Cousin were the chief representatives. He was appointed president of the Commission of Public Instruction in 1815, but resigned that post in 1820; in 1815 also he returned to political life as deputy for the department of Marne. The French Academy opened its doors to him in 1827; and in 1828 he was named president of the Chamber of Representatives, and in that capacity presented the address of the 221 deputies (March 1830) withdrawing their support from the government, which the king refused to hear read. Next day the Chamber was prorogued. From 1842 Royer-Collard completely withdrew from public life; he died, 4th September 1845, at his country seat of Châteauneuf, near St Aignan (Loir-et-Cher). His salon was latterly the resort of such men as Cousin, Guizot, De Broglie, Casimir Périer, Villemain, De Rémusat, and others. He never was a writer, and he became a philosopher only by accident: his true interest in life was politics, his real eminence as a political orator after the ancient pattern, rather than that of the modern parliamentary debater. His idea of the monarchy was utopian; the famous *charte* was found impracticable as the sheet-anchor of liberty; even his best speeches, triumphs of dialectic as they often were, fell short of the effect that seemed secure, whether because ever in human things facts overturn the

conclusions of reason, or because reason does not reach the profound depths in which are generated the opinions of men, to wit, their passions and their interests.

See the biographies by Philippe (1857) and Barante (new ed. 1878), the latter mainly a collection of its subject's speeches; also Scherer's *Études sur la Litt. Contemp.* vol. i., and Fagnet, *Politiques et Monarchistes du XIX^e Siècle* (1891).

Royton, a town of Lancashire, 2 miles NNW. of Oldham, with large cotton-factories. Pop. (1851) 6974; (1891) 13,395.

Rsheff, or **RJEV**, a town of European Russia, on the Volga, 135 miles NW. of Moscow, is a river-port with a very extensive transit trade in agricultural produce, collected from the governments of Orel, Kaluga, and Smolensk, and sent to Riga and St Petersburg. Hemp is spun and boats are built. Pop. 35,810.

Ruabon, a town of Denbighshire, 4½ miles SSW. of Wrexham, with collieries and ironworks. Pop. of parish (1851) 11,507; (1891) 17,609.

Ruatan, or **RATTAN**, a long, narrow island in the Bay of Honduras in the Caribbean Sea, belonging since 1860 to the republic of Honduras. Area, 106 sq. m.; estimated pop. 2000, mostly Negroes.

Rubasse, a mineral prized for ornamental uses, is rock-crystal, limpid or slightly amethystine, filled internally with minute brown spangles of specular iron, which reflect a bright red, equal to that of the most brilliant ruby. There is an artificial rubasse, made by heating very pure rock-crystal red hot, and repeatedly plunging it into a coloured liquid.

Rubble, a common kind of masonry, in which the stones are irregular in size and shape. Walls faced with ashlar are generally packed with rubble at the back. Rubble is of various kinds, according to the amount of dressing given to the stones. Common rubble is built with stones left almost as they come from the quarry. Hammer-dressed rubble is so called when the stones are squared with the mason's hammer; coursed rubble, when the stones are squared and equal in height, &c.

Rubefacients are external agents employed in medicine for the purpose of stimulating, and consequently reddening, the part to which they are applied. All agents which, after a certain period, act as Blisters (q.v.) may be made to act as rubefacients, if their time of action is shortened. The mildest rubefacients are hot poultices, cloths soaked in very hot water, moderately stimulating liniments—as, for example, soap-liniment, with various proportions of liniment of ammonia, or chloroform, &c. Spanish fly, in the form of *Emplastrum Calefaciens*, or warm plaster, in which the active ingredient is blunted by the free admixture of soap-plaster, resin-plaster, &c., is a good form of this class of agents. Capsicum or Cayenne pepper, in the form of a poultice, is an excellent rubefacient; it is much used in the West Indies, but is seldom employed in this country. Mustard, in the form of *Cataplasma Sinapis*, or mustard poultice, and oil of turpentine are perhaps the best of the ordinary rubefacients. The former is applied to the soles of the feet and the calves of the legs in the low stage of typhus fever, in apoplexy and coma, in narcotic poisoning, &c. It is also applied to the chest, with much advantage, in many cases of pulmonary and cardiac disease, and to the surface of the abdomen in various affections of the abdominal viscera. The best method of employing turpentine is to sprinkle it freely on three or four folds of clean flannel, wrung out of boiling water. The sprinkled surface of this pad is placed upon the skin, and a warm dry towel is laid over the flannel. Two or three such applications will produce a powerful rube-

facient effect. Turpentine thus applied is serviceable in all the cases mentioned in the remarks on Mustard, as well as in sore throat, chronic rheumatism, neuralgia, &c.

Rubens, PETER PAUL, the most celebrated painter of the Flemish school, was born on the 29th of June 1577 at Siegen, in Westphalia, where his father, John Rubens, an eminent lawyer, was living in disgrace, in consequence of his intrigue with Anne of Saxony, second wife of William the Silent. In 1578 his parents settled in Cologne; and upon the death of her husband in the year 1587, his mother returned to her native city of Antwerp, where the boy was educated in the Jesuits' college. He served for a short time as a page in the household of Margaret de Ligne, widow of the Count of Lanain, and was intended for the profession of law; but he was animated by a strong desire to become a painter, and at the age of thirteen he began the study of art, first, for a brief period, under Tobias van Haeght, a skilful landscape-painter; then for four years under Adam van Noort, a painter of religious subjects, distinguished for his excellent colouring; until finally, in his nineteenth year, he passed into the studio of Othon van Veen, court-painter to the Archduke Albert, governor of the Netherlands.

In 1599 he was admitted a master of the Brotherhood of St Luke in Antwerp; and in the following year he started for Italy, making his way to Venice, where he studied the works of Titian and Veronese. He next entered the service of Vincenzo Gonzaga, the magnificent and luxurious Duke of Mantua, as gentleman of the chamber and court-painter; and in 1605 was despatched on a mission to Philip III. of Spain, thus beginning the career of a diplomatist, for which his keen intellect, his polished urbanity, and his linguistic attainments so admirably qualified him. While at Madrid he executed portraits of many of the Spanish nobility, as well as several historical subjects. On his return from Spain he travelled in Italy, copying celebrated works for the Duke of Mantua; and to this period is referable the sketch, now in the National Gallery, London, from one of the subjects of Mantegna's 'Triumph of Julius Caesar.' In 1608, while in Genoa, he received news of his mother's illness, and returned home, but too late to see her alive. Settling in Antwerp, he was appointed in 1609 court-painter to the Archduke Albert and his wife Isabella, and soon afterwards married his first wife, Isabella Brant, whom his pencil has often portrayed, and who appears, seated hand in hand with himself, in the famous full-length group at Munich.

The painter was now rapidly approaching his full artistic maturity, and his 'Descent from the Cross' in the cathedral of Antwerp, begun in 1611 and completed in 1614, and usually regarded as his masterpiece, is a work in which both his earlier and later manner may be traced. It is a triptych, showing on the interior of its wings The Visitation and The Presentation in the Temple, and on their exterior subjects of St Christopher and a Hermit bearing a lantern.

In 1620 Rubens was invited to France by Marie de' Medici, the queen-mother, who was then engaged in decorating the palace of the Luxembourg in Paris; and he undertook for her twenty-one large subjects commemorating her marriage to Henry IV., works, completed with the aid of assistants in 1625, which are now in the Louvre, most of the sketches by the master's own hand being at Munich. In 1628 he was despatched by the Infanta Isabella upon a diplomatic mission to Philip IV. of Spain. He remained for nine months in Madrid, and there he made the acquaintance of Velasquez, and executed some forty works, includ-

ing five portraits of the Spanish monarch. In 1629 he was appointed envoy to Charles I. of England, to treat for peace; and, while he conducted a delicate negotiation with perfect tact and success, his brush was not idle, for he painted the 'Peace and War,' now in the National Gallery, London, and the portrait of the king and his queen as St George and Cleolinde, a work now at Windsor, and also made sketches for the Apotheosis of James I. for the Banqueting-hall at Whitehall, completing the pictures on his return to Antwerp. In acknowledgment of his services he was knighted by Charles I.; and he received a similar honour from Philip IV.

In 1630 Rubens married his second wife, Helena Fourment, a beautiful girl of sixteen; in 1635 he designed the decorations which celebrated the entry of the Cardinal Infant Ferdinand into Antwerp as governor of the Netherlands; and, having with much difficulty completed a picture of 'The Crucifixion of St Peter' for the church dedicated to that saint in Cologne, he died at Antwerp on the 30th of May 1640, and was interred with great pomp in the church of St Jacques, his body being deposited, two years afterwards, in a chapel specially built there for its reception.

Not only was Rubens great as a subject-painter, but he was equally distinguished as a portraitist, an animal-painter, and a landscapist. The main characteristics of his productions are their power, spirit, and vivacity, their sense of energy, of exuberant life. As Reynolds has truly said, 'Rubens was perhaps the greatest master in the mechanical part of the art; the best workman with his tools that ever used a pencil; and he was great alike in handling and as a colourist. It is, however, mainly on technical grounds that he claims supremacy, for his works are wanting in the dignity, quietude, refinement, and in the profound imagination which distinguish the greatest Italian painters. He was a most prolific artist; his works number in all several thousands, of which Smith in his *Catalogue* has described over thirteen hundred; and about twelve hundred prints have been executed after his paintings and designs, frequently under his personal supervision by such of the best contemporary engravers as Pontius, Vosterman, Soutman, and the Bolswerts. Many of his finest works are still at Antwerp; but his art may probably be most adequately studied in the Pinakothek at Munich, which contains nearly a hundred examples of his brush, several of them ranking with his noblest efforts. Among the most distinguished of his many pupils were Van Dyck, Van Diepenbeck, Jordaens, and Snyders.

See *Lettres Inédites de P. P. Rubens*, publiées par Emile Gachet (Brussels, 1840); De Waagen's *Life of Rubens*, published in Raumer's *Historisches Taschenbuch* (Berlin, 1833; trans. by R. R. Noel, Lond. 1840); *Original Unpublished Papers Illustrative of the Life of Sir P. P. Rubens, as an Artist and a Diplomatist*, by W. Noel Sainsbury (Lond. 1859); *Rubens et l'École d'Anvers*, par A. Michiels (Paris, 1877); the volume in the 'Great Artists' series by C. W. Kett (1880); and the posthumous work of M. Charles Ruelens, of the Brussels Library.

Rube'ola. See MEASLES.

Rübezahl. See RIESENBERGIRGE.

Rubiaceæ, a natural order of dicotyledonous plants, in which, according to many botanists, the Cinchonaceæ are included as a sub-order; but which, as restricted by others (Stellatæ of Ray, Galiaceæ of Lindley), consists entirely of herbaceous plants, with whorled leaves, angular stems, and numerous very small flowers; the calyx superior, with four, five, or six lobes, or almost wanting; the corolla wheel-shaped, or tubular, regular, inserted into the calyx, and with the

same number of divisions as the calyx; the stamens equal in number with the lobes of the corolla; two styles; the fruit a dry pericarp with two cells, and one seed in each cell. There are between 300 and 400 known species, chiefly abounding in the northern parts of the northern hemisphere, and on the mountains of tropical regions. The most important plant of the order is Madder (q.v.). To this order belong also Bedstraw (q.v.) and Woodruff (q.v.).

Rubicon, a stream of Central Italy, falling into the Adriatic a little north of Ariminum, has obtained a proverbial celebrity from the well-known story of its passage by Cæsar, in the middle of January, 49 B.C. It formed the southern boundary of his province, so that by crossing it he virtually declared war against the Republic. Cæsar himself makes no mention of its passage; Suetonius, Plutarch, and Lucan tell how he hesitated while on the bank and then crossed with the words, *Facta est alca*. A papal bull of 1756 identified the Rubicon with the modern Luso, but a comparison of distances shows that it must rather have been the Fiamicino or Rujone.

Rubidium (sym. Rb; atom. wt. 85) is one of the alkali metals. Its salts exist in very minute quantities in numerous mineral waters, and in these rubidium salts, along with cesium salts, were detected by Bunsen and Kirchoff by means of spectrum analysis. The mineral lepidolite is the best material from which to prepare rubidium compounds. The metal is, like cesium, silver-white. It melts at 38.5° C., but is still soft at -10° C. Its sp. gr. is 1.52. Like cesium, it takes fire spontaneously in the air, and it decomposes water at the ordinary temperature, in the latter respect resembling all the other alkali metals. The salts of rubidium resemble generally those of potassium. The name rubidium is derived from *rubidus*, 'dark red,' in allusion to the colour imparted to a flame by the salts of the metal.

Rubinstein, ANTON, pianist and musical composer, was born, the son of a Polish Jew and a German Jewess, near Jassy in Moldavia, on 28th November 1829, and was trained to music in Moscow by his mother and a master. Liszt heard him, 'an infant prodigy,' play in Paris in 1841, recognised his genius, and encouraged him to go on and play in other cities. After some further 'touring,' he gave himself to serious study in Berlin and Vienna, and in 1848 settled in St Petersburg as teacher of music. In 1854 he set off on another musical tour, with the reputation of being a second Liszt, and 'the coming' composer. On his return to St Petersburg he succeeded in getting a musical conservatoire founded (1862) there, and became its director. But his concert tours engrossed a good deal of his time, and in 1867 he resigned the directorship of the conservatoire. In 1872 he went to the United States and had an enthusiastic reception. He wound up his concert tours in 1886, his last having had for its object a series of seven pianoforte recitals illustrating the great masters of music historically. He was induced in the following year to resume the directorship of the conservatoire at St Petersburg. Rubinstein was both composer and player. Amongst his best musical productions are the operas, *The Maccabees*, *The Demon*, *Feramos* (the libretto from Moore's *Lalla Rookh*), and *Kalashnikoff*; the two symphonies, *Ocean* and *Dramatic*; and the sacred operas, *Paradise Lost*, *The Tower of Babel*, and *Sulamith*. His numerous songs and pieces of chamber music are highly esteemed and more widely known. His style, while of course embracing fuller modern developments, presents several points of likeness to

Schubert's; there is the same predominance of the lyric, rhythmic, and formal elements over the dramatic; an exuberant melodiousness, frequently charming, but sometimes falling below the mark; an absence of meretricious effects, and a tendency to protracted length, not to say occasional prolixity; while in feeling he is more akin to Mendelssohn. He was a strongly pronounced opponent of the principles of Wagner. As a pianist he held the highest rank, being usually reckoned the greatest since Liszt. His mastery of technique was supreme; opinions differed about his fidelity to a composer's intentions, but the depth of feeling and significance he could impart to even the simplest piece evinced a rare musical susceptibility at once intense and widely sympathetic. He retired from the platform some years before his death, 20th November 1894. See his *Autobiography*, trans. from the Russian by Aline Delano (1891), a Study by M'Arthur (1889), and the Life by Zabel (Leip. 1892).

Ruble. See ROUBLE.

Rubrics (Lat. *rubrica*, from *ruber*, 'red'), in classic use, meant the titles or headings of chapters in law-books, and is derived from the red colour of the ink in which these titles were written, in order to distinguish them from the text. In mediæval and modern use the name is restricted to the directions in the service-books of the church as to the ordering of the prayers and the performance of the ceremonies that accompany them. The first printed missals have few rubrics, and the printing of both the words and ceremonies of the mass in full dates only from 1485. The same name, together with the usage itself, is retained in the Book of Common Prayer; and in all cases, even where the direction has ceased to be printed in red ink, the name rubric is still retained. Where red ink is not employed the rubric is distinguished from the text by italics or some other variety of print.

Rubruquis, WILLIAM DE, a mediæval traveller, was born, it is pretty certain, at Rubrouck (8 miles N.E. of St Omer, in northern France), and not at Ruysbroeck, near Brussels, early in the 13th century. He entered the Franciscan order, and was sent by Louis IX. of France into central Asia for the purpose of opening up communications with Sartak, the son of the Mongol prince, Batû Khan, a supposed Christian. Friar William travelled (1253) by way of Constantinople across the Black Sea and the Crimea to the Volga. Sartak referred him to his father, Batû, and that prince sent him forward to the Mongol emperor, Mangû Khan, whom he found on 27th December, about 10 days' journey south of Karakorum in Mongolia. With that sovereign he remained until July 1254, then returned to the Volga, penetrated the defiles of the Caucasus, proceeded through Armenia, Persia, and Asia Minor, to Syria, and arrived at Tripoli in August 1255. King Louis had meanwhile returned to France, and Friar William wrote him the account of his journey which has come down to us. The best edition is that of D'Arvezac in vol. iv. of *Recueil de Voyages* (1839) of the Paris Geographical Society. Of the later history of Rubruquis the only fact known is that he was living in 1293, when Marco Polo was returning from the East.

Rubus (Blackberry or Bramble, &c.), a genus of plants of the natural order Rosaceæ, sub-order Rubææ, distinguished by a 5-lobed calyx without bracts, and the fruit formed by an aggregation of small drupes adhering to each other upon a long torus. The fruit is eatable in all, or almost all, the species. The genus is a large one, comprising, according to Bentham and Hooker, about 100 species, widely distributed over nearly every part of the globe. Among the most important species

are *R. Chamæmorus*, the Cloudberry (q.v.); *R. Idæus*, the Raspberry; *R. cæsius*, the Dewberry; *R. arcticus*, characterised by Linnaeus as the prince of wild berries; *R. fruticosus*, the Common Bramble (q.v.); and *R. saxatilis*, the Stone Bramble. Of the Common Bramble a number of varieties having very large luscious fruit have been introduced into Britain from North America within the last few years with the view of cultivating them for their fruit. The opinion of gardeners as to their merits for profitable culture in Britain is varied, but they are much appreciated in Canada and in the United States of America. The varieties which are most approved are the Lawton, Wilson Junior, Early Harvest, and Mammoth. The ornamental species frequently planted in British gardens are *R. odoratus*, the Virginian Raspberry; *R. laciniatus*, with large flowers and elegant leaves; and *R. biflorus*, whose snow-white bark contrasts strikingly with the dark-green leaves.

Ruby, a gem much prized, is a pure transparent, red-coloured Corundum (q.v.), just as Sapphire (q.v.) is a blue variety of the same mineral. It is inferior in hardness to the diamond only among gems. Although usually red, yet violet, pink, and purple rubies are met with, but the most highly esteemed are those which have the colour of pigeon's blood. The finest true oriental rubies are more highly prized than diamonds of similar size and quality; those over a carat in weight are worth from £20 to £100 per carat, and no stone increases so much in value in proportion to increase in size. But perfect specimens, as regards colour, transparency, and freedom from flaws, are much less common than good diamonds. Gems of this character seldom exceed 8 or 10 carats; but Gustavus III. of Sweden presented one, now in the Russian regalia, to the Empress Catharine, which was of the size of a pigeon's egg. The throne of the Great Mogul, according to Tavernier, was adorned with 108 rubies of from 100 to 200 carats each. One possessed by the king of Ceylon was, according to Marco Polo, a span in length, as thick as a man's arm, and without a flaw; Kublai Khan offered for it the value of a city, but the king would not part with it. The Burmese government sent two rubies to London in 1875, one of which, reduced by recutting to $32\frac{1}{2}$ carats, was sold for £10,000; the other, of $38\frac{1}{2}$ carats, was sold for £20,000. The specific gravity of the ruby (3.900 to 4.2833) exceeds that of all other gems. When rubbed it becomes electrical, and remains so for some time. The finest rubies—those having the colour of pigeon's blood—come from Upper Burma, near Mogok, north of Mandalay (see BURMA, Vol. II. p. 563). Dark-red rubies, sometimes with a brownish tint, are found in Siam, and purplish rubies in Ceylon. Rubies are also met with in the mountain-region of Yunnan in China, in Afghanistan, and in the basin of the Oxus. The true or oriental ruby, as above described, occurs in crystalline limestone in Burma, and in alluvial deposits which have been derived from the denudation of granitoid igneous and schistose rocks. Ruby-bearing gravels and sands occur sparingly in Europe, as in Auvergne, Bohemia, the Urals, &c. Small rubies have also been detected in such rocks as basalt, as in Victoria and New South Wales; and fine rubies have been reported to be found in New Guinea. Many of the so-called rubies of jewellers are not true or oriental rubies, but varieties of Spinel (q.v.), a mineral composed chiefly of alumina and magnesia, inferior in hardness and of less specific gravity than the oriental ruby, and crystallising in the cubical system. Oriental rubies belong to the hexagonal system, and, unlike the spinel, are always dichroic. Spinel rubies are found in the form of crystals or rounded pebbles in alluvial deposits and

in the beds of rivers in Ceylon, Siam, Pegu, Badakshan, and other eastern countries, having been derived like the true ruby from crystalline igneous and schistose rocks. They occur also in crystalline limestone and in serpentine. Small rounded spinel-rubies occur in the sands of mountain-streams in Wicklow; and large crystals have been found in various parts of North America, but rarely, if ever, fit for the purposes of the jeweller. Spinels are also found in Australia. *Spinel-ruby* is the name given by jewellers to a stone of a deep carmine-red; a rose-red stone is distinguished as *Balas-ruby*; red with a decided tinge of orange is *Vermeil* or *Vermeille*; yellow or orange-red is *Rubicelle*; violet is *Almandine ruby*. There are also transparent spinels, which when large and fine are treated as jewels. All these, however, are merely variously-tinted varieties of one and the same mineral—spinel—which is allied to Corundum (q.v.), being composed mainly of alumina, with a smaller proportion of magnesia.

As early as 1837 small rubies were produced chemically by fusion of alumina; but it was not till 1878 that Frey and Verneuil produced rubies on a scale of commercial importance, though less brilliant than oriental rubies. In 1890 they succeeded in making larger and finer stones, which for the purposes of the watchmaker quite equalled natural rubies.

Rückert, FRIEDRICH, German poet, was born at Schweinfurt, 16th May 1788, and educated there and at Würzburg. For some years he led a wandering life, studying philology and poetry, and cultivating the muses. During this period of his life he helped Arndt and Theodor Körner to fan the flame of German patriotism by his *Deutsche Gedichte* (1814), especially by the *Geharnischte Sonette* included in this volume. From 1826 to 1841 he filled the chair of Oriental Languages at Erlangen; but the greater part of his summers were passed at the country seat of his wife's parents, Neuses near Coburg. After learning Persian, Arabic, and Turkish, incited thereto by Hammer-Purgstall at Vienna (1818), Rückert recast in German verse, with great skill, several of the famous books of the East, as *Die Verwandlungen des Abu Seid* of Hariri (1826), *Nal und Damajanti* from the *Mahābhārata* (1828), *Rostem und Suhrab* from Firdaus's *Shah-Nameh* (1838), *Amrīkās* (1843), *Hamāsa* (1846), a collection of Arabic folk-songs, and others. His most popular books are the collection of lyrics entitled *Liebesfrühling* (1844; 14th ed. 1888) and the reflective poems gathered together as *Die Weisheit des Brahmanen* (1836–39; 12th ed. 1886). In 1841 Frederick-William IV. invited him to Berlin, making him professor of Oriental Languages; but the poet preferred his idyllic life at Neuses, and went back there in 1848. There he died on 31st January 1866. Rückert wrote with fatal ease; he tried nearly all forms of poetical composition, and produced too much. Nevertheless he penned several charming little lyrics, which may be read in the selected *Gedichte* (1841; 22d ed. 1886). Two qualities distinguish his work in general—a marvellous command of language and rhyme, and the gift of giving poetic expression to philosophic thought. The former has sometimes led him into mannerisms of form and unpleasing *tours de force*; the latter often betrays him into throwing a poetic glamour over dull, pedantic, and unimportant ideas. His posthumously published work includes German adaptations of Theocritus, Aristophanes, Kālidāsa's *Sākuntala* (1867), Sādi's *Bostān* (1882), and a good deal of original poetry.

See biographical works by Beyer (3 vols. 1868–77), Boxberger (1878), Konrad Fischer (1889), and F. Reuter's *Rückert in Erlangen und Joseph Kopp* (1891).

Rudd. See RED-EYE.

Rudder. See STEERING.

Rudder-fish, a name loosely applied to at least three different kinds of fish, of which the Pilot-fish (q.v.) is one.

Ruddiman, THOMAS, Latin grammarian, was born near Banff in 1674, and in 1690 gained a bursary near King's College, Aberdeen, taking his M.A. four years later. In 1695 he became parish schoolmaster of Laurencekirk, and here in 1699 accidentally made the acquaintance of the celebrated physician and Latinist, Dr Archibald Pitcairne, who was so impressed with his learning and sagacity that he got him appointed assistant-keeper of the Advocates' Library, Edinburgh. His new office gave him ample opportunity for prosecuting his favourite studies, but the remuneration was so small (£8, 6s. 8d. per annum) that, in 1707, he started business as a book auctioneer. In that year he edited Florence Wilson's Latin *Dialogue on the Tranquillity of the Mind*, to which he prefixed a life of the author; in 1709 Arthur Johnston's *Poetical Paraphrase of the Song of Solomon and Cantica*—both also in Latin. In 1714 appeared his well-known *Rudiments of the Latin Tongue*; in 1715 his great edition of Buchanan's works. He now exchanged the calling of a book auctioneer for the more congenial one of printer; and in 1728 he was appointed printer to the university, in 1730 principal keeper of the Advocates' Library. In 1725-32 he published his great *Grammaticæ Latinæ Institutiones*, on which his philological reputation mainly rests; in 1739 he completed Anderson's magnificent *Diplomata et Numismata Scotiæ*, writing the learned Latin introduction and appendices. Controversy as to the respective merit of the Latin verse of Johnston and Buchanan, and as to the hereditary right of the kings of Scotland to the crown, consumed a great part of his time, but did not so preoccupy his thoughts as to prevent him from publishing in 1751 an edition of Livy, still known as the 'immaculate,' from its entire exemption from errors of the press. Ruddiman died in Edinburgh, January 19, 1757. He was in politics, like his friend Pitcairne, an ardent Jacobite, and in private life a most upright and estimable man. Besides the publications already noted, and a multitude of minor tracts, he edited Gawin Douglas' translation of the *Æneid*, and appended a very valuable glossary (folio, 1710). He also founded the *Caledonian Mercury* newspaper. See his Life by George Chalmers (1794).

Rüdesheim, a town of Prussia, on the right bank of the Rhine, opposite Bingen, at the foot of the Niederwald (q.v.), and 16 miles W. of Mainz. Round Rüdesheim is grown one of the most esteemed of the Rhine-wines, the Rüdesheimer. Pop. 4040.

Rudolf, or RUDOLPH, German king and founder of the present imperial dynasty of Austria, was born in Limburg castle in the Breisgau, on 1st May 1218. He became a warm partisan of Frederick II., distinguished himself in arms, and spent much of the early years of his manhood in quarrels with the bishops of Basel and Strasburg. His possessions were greatly increased by inheritance and by his marriage, until he was the most powerful prince in Swabia. In 1273 the electors chose him to be German king; as never having been crowned by the pope, he was not entitled to be called kaiser or emperor. His accession was opposed by none; the pope's consent was secured at the price of certain rights already parted with by Rudolf's predecessors. Ottocar of Bohemia, however, refused to tender his allegiance. He was put under the ban of the empire in 1276, but, sub-

mitting on Rudolf's approach with an army, was invested with Bohemia. Having soon afterwards taken the field against his suzerain, he was defeated and slain in 1278 at Marchfeld beside the Danube. Rudolf spent the greater part of his life that remained in suppressing the castles of the robber knights and putting an end to their lawless practices. He died at Spiers, 15th July 1291, and was buried in the cathedral there. His son Albert, to whom (and his brother Rudolf) Austria, Styria, and Carniola had been given in 1278, succeeded him as German king. Rudolf was a pattern knight, tall in person, upright, pious, valiant, and energetic. See Lives by Schönhuth (1844), Kopp (1845), and Hirn (1874); Lorenz, *Deutsche Geschichte in 13. und 14. Jahrhundert* (1863-67); and a work by Kaltenbrunner (Prague, 1890).

Rudolf II., eldest son of the Emperor Maximilian II., was born at Vienna on 18th July 1552, and educated at the Spanish court by the Jesuits. He was made king of Hungary in 1572, king of Bohemia, with the title King of the Romans, in 1575, and on the death of his father in 1576 succeeded to the imperial crown. Gloomy, taciturn, bigoted, indolent both in body and mind, he put himself in the hands of the Jesuits and low favourites, and left the empire to govern itself. His attention was given to his curiosities, his stable, his alchemical and magical studies; nevertheless his taste for astrology and the occult sciences, and his desire to discover the philosopher's stone, made him extend his patronage to Kepler and Tycho Brahé. The astronomical calculations begun by Tycho, and continued by Kepler, known as *The Rudolphine Tables*, derive their name from this emperor. Meanwhile the Protestants were bitterly persecuted by the Jesuits throughout the empire; the Turks invaded Hungary and defeated the archduke Maximilian (1596); Transylvania and Hungary rose in revolt; and at last Rudolf's brother Matthias wrested from him the crowns of Hungary and Bohemia, and the states of Austria and Moravia. Less than a year after losing the crown of Bohemia he died, unmarried, on 20th January 1612, and was succeeded by Matthias. See works by Gindely (1865) and Von Bezold (1885).

Rudolf, LAKE, an equatorial sea in British East Africa, near the edge of the Kaffa or South Ethiopian highlands, is long and narrow, stretching 160 miles N.E. and S.W. by 20 broad, with an area of 3000 sq. m., at a height of 1300 feet above the sea. It is crossed by 4° N. lat. and 35° E. long. It has no visible outlet, and its waters are very brackish. It was discovered by Count Teleki in 1888. See his *Discovery of Lakes Rudolf and Stephanie* (Eng. trans. 1894).

Rudolstadt, the chief town of the German principality of Schwarzburg-Rudolstadt, lies in a hill-girt valley, on the left bank of the Saale, 18 miles S. of Weimar. There are two royal castles, a library, picture-gallery, &c., and factories for porcelain, chemicals, and wool. Pop. (1890) 12,247.

Rudra is, in Vedic mythology, a collective name of the gods of the tempest, or Maruts. In later and Puranic mythology Rudra ('the terrible') is a name of Siva, and the Rudras are his offspring.

Rue (*Ruta*), a genus of plants of the natural order Rutaceæ. The species are half-shrubby plants, natives of the south of Europe, the north of Africa, the Canary Isles, and the temperate parts of Asia. Common Rue, or Garden Rue (*R. graveolens*), grows in sunny stony places in the countries near the Mediterranean. It has greenish-yellow flowers, the first of which that open have ten stamens, the others eight only (they are of unequal

length, and each one is bent inwards in turn to touch the pistil, and when the pollen is shed it bends back again), and glaucous evergreen leaves with small oblong leaflets, the terminal leaflets obovate. It is not a native of Britain, but is frequently cultivated in gardens. It was formerly called *Herb of Grace* (see *Hamlet*, act iv. scene 5), because it was used for sprinkling the people with



Common Rue (*Ruta graveolens*).

holy water. It was in great repute among the ancients, having been hung about the neck as an amulet against witchcraft in the time of Aristotle. It is the *Peganon* of Hippocrates. Rue is still employed in medicine as a powerful stimulant, but the leaves must be used fresh, as they lose their virtues by drying. The smell of rue, when fresh, is very strong, and to many very disagreeable; yet the Romans used it much for flavouring food, and it is still so used in some parts of Europe. The leaves chopped small are also eaten with bread and butter as a stomachic, but they must be used sparingly, as they are acrid enough to blister the skin if much handled, and in large doses act as a narcotic poison. All their properties depend on an acrid volatile oil, which is itself used for making *Syrup of Rue*, eight or ten drops of oil to a pint of syrup; and this, in doses of a teaspoonful or two, is found a useful medicine in flatulent colic of children. The expressed juice of rue, mixed with water, and employed as a wash, is believed to promote the growth of the hair.

Ruff (*Machætes pugnax*), a bird, the sole representative of the genus, belonging to the Sandpiper (q.v.) sub-family of the Snipe family (Scolopacidae). In the British Isles it is now little more than a visitor in its spring and autumn migrations, owing to the draining of its marshy breeding-places and the practice of capturing it in spring when game is out of season. It is more common on the east than on the west coast of England. The same is true of the east coast of Scotland, where it is found from Berwick to the Orkneys and Shetlands, but it has been recorded from the Outer Hebrides. As a straggler it is found on the Faroes and Iceland, in Canada, in some of the eastern United States, and it has been found once in Barbadoes and once on the Upper Orinoco. It breeds over the greater part of northern Europe; it is found as a migrant over the rest of Europe, the southern shores of the Mediterranean, and the east and west coasts of Africa as far as the Cape; in Asia it extends from Siberia to Japan, Burma, and India.

The male bird, the *Ruff*, is about a foot long. In spring it sheds the feathers of the face; curled tufts of feathers appear on the sides of the head; and an erectile ruff is developed which lasts for a couple of months. This ruff, as well as the feathers on the back, shows every variation of colour in different birds; but each bird annually regains its own peculiar colour. After moulting the neck and upper breast are of a buff colour; the under parts dull white; the feathers of the upper parts are dark brown with buff margins; and the primary wing-feathers are dusky brown. The female, the *Reeve*, is about one-fourth smaller in size, and shows very much the same colours as the moulted male. In habit these birds are polygamous; the males fight for possession of the females, and in battle the ruff serves for defence. The nest is made among the coarse grass of a dry tussock in a moist swampy place. The eggs, four in number,



Ruff (*Machætes pugnax*).

are grayish green marked with reddish brown. The food consists of insects and their larvæ, worms, seeds, rice, and other vegetable substances. When captured and being fattened for the table, the birds are fed on boiled wheat, bread and milk, and bruised hemp-seed.

Ruffe, or **POPE** (*Acerina cernua*), a small freshwater fish of the Perch family (Percidæ), abundant in the lakes, slow rivers, and ditches of many parts of the middle of Europe and of England. It is five



Ruffe, or Pope (*Acerina cernua*).

or six inches in length, of an olive-green colour mottled with brown, and has only one dorsal fin. The flesh of the ruffe is highly esteemed for the table.

Rufji, or **LUFJI**, the chief river of German East Africa, which rising far in the interior enters the sea through a delta opposite the island of Mafia. Shoals and bars at the mouth prevent the access of large ships; but the river is navigable by smaller boats throughout great part of its course. The valley is extremely fertile.

Rugby, a town giving name to the south-east division of Warwickshire, of which it stands at the northern corner, is situated at the junction of several railways in the middle of country such as George Eliot describes in *Felix Holt*. By rail it is 83 miles NW. of London and 30 ESE. of Birmingham. At the foot of the hill on which it stands the Swift gave John Wyclif's ashes to the Avon; close by at Ashby and at Dunchurch the Gunpowder Plot was hatched; the battlefield of Naseby was visited by Carlyle from its schoolhouse in 1842 a few days before Arnold's death; it is within a drive of Stratford-on-Avon, Coventry, Kenilworth. It is at once the centre of a great hunting district and the seat of a public school. This probably accounts for the large number of residential houses there. John Moultrie (q.v.) was long rector of the parish. Pop. (1851) 6317; (1891) 11,262.

The school was founded in 1567 by Lawrence Sheriff, a grocer and a staunch supporter of Queen Elizabeth, by a gift of property in Manchester Square, London. After maintaining its position for some time as a good school for the Warwickshire gentry and a few others, specially under Dr James and Dr Wool, it became of national reputation under Dr Arnold, who in raising his school raised at the same time the dignity of his whole profession. Since his time the school has never lacked able teachers, remarkable for independence of mind. When Arnold died in 1842, Archbishop Tait succeeded him, having as coadjutors Lord Lingen, Dean Bradley, Principal Shairp, Thomas Evans, Theodore Walrond, Bishop Cotton. Dean Goulburn (1850-58) had as an assistant the future Archbishop Benson. The next heads were Dr Temple (1857-69), afterwards Archbishop of Canterbury; Dr Hayman (1869-74); Dr Jex-Blake (1874-87); Dr Percival (1887-95), afterwards Bishop of Hereford; and Dr H. A. James (since 1895). The Public Schools Commission reported of Rugby in Dr Temple's days that the general teaching of classics was absolutely unsurpassed; that Rugby School was the only public school in which physical science was a regular part of the curriculum; that only Harrow had done as much as Rugby in awakening interest in history. Having secured this tribute for his teaching and having collected enough money to rebuild the chapel, to erect a gymnasium, and to build new schools, Dr Temple was succeeded by Dr Hayman. To him succeeded Dr Jex-Blake, who inaugurated a still greater building era. When he resigned in 1887 he left behind him a school simply unrivalled in its appointments. He was succeeded by Dr Percival. Of illustrious Rugbeians may be named the poets Landor, Clough, and Matthew Arnold; Dean Stanley, who had the rare privilege of recording the work of his great head-master in biography; Judge Hughes, who did the same equally felicitously in *Tom Brown's School-days*; Dean Vaughan, Lord Derby, Lord Cross, Mr Goschen, Sir R. Temple, Franck Bright and York Powell the historians, Justice Bowen, Sir W. Palliser, Professor Sidgwick, Robinson Ellis and Arthur Sidgwick, C. Stuart-Wortley, and Arthur Acland. From Rugby went the first head-master to Marlborough, Wellington, Clifton, Haileybury, Fettes College, and Newcastle High School. Mission work found its Rugby worker in Fox, in whose memory the school still keeps up a missionary at Masulipatam. The learned author of *Gothic Architecture*, Matthew H. Bloxam, was taught and lived at Rugby, where he died in 1888, leaving his valuable collection of antiquities and books to the school. The school possesses an observatory, given by Archdeacon Wilson, and the Natural History Reports, written by members of the school, have often been of exceptional value.

See, besides Stanley's *Life of Arnold* and *Tom Brown's School-days*, *The Book of Rugby School*, edited by Dean Goulburn (1856); M. H. Bloxam and Rev. W. H. Payne Smith, *Rugby: Its School and Neighbourhood* (1889); *Rugby School Registers, 1567-1887* (1881-91); A. Rimmer, *Rambles round Rugby* (1892); W. H. D. Rouse, *A History of Rugby School* (Public Schools series, 1898).

Rugby, TENNESSEE. See HUGHES (THOMAS).

Ruge, ARNOLD, German writer, was born at Bergen on the island of Rügen, on 13th September 1802, studied philosophy at Jena and Halle, and took such a warm interest in the Burschenschaft (q.v.) agitations of 1821-24 as to bring down upon himself a sentence of six years' imprisonment in a fortress. After his release he taught at Halle, from 1832 as a *privat-docent* at the university. Along with Echtermeyer he founded in 1837 the critical journal *Hallesche Jahrbücher* (later *Deutsche Jahrbücher*), which as the organ of Young Germany and the Young Hegelian School filled an influential place in the world of letters. Its liberal political tendencies drew upon it the condemnation of the Prussian censor, and after an attempt to transplant it to Dresden, thwarted by the censorship, Ruge withdrew to Paris. After spending some years there and in Switzerland, he started a bookseller's business in Leipzig, until the stormy revolutionary movement of 1848 drew him into its vortex. He published the democratic journal *Die Reform*, took his seat in the Frankfort parliament for Breslau, attended the Democratic Congress in Berlin, and took part in the disturbances at Leipzig in May 1849. In the following year he found it expedient to repair to England. In London he organised along with Mazzini and Ledru-Rollin the Central European Democratic Committee, but in 1850 withdrew to Brighton, where he lived by teaching and writing. For the services he rendered the Prussian government, by supporting it against Austria in 1866 and against France in 1870, he was rewarded with a yearly pension of £150. He died at Brighton on 31st December 1880. A thorough doctrinaire, Ruge advocated a universal democratic state, of which the several nations should be provinces, and put cosmopolitan dreams above national ideals. Unstable by nature, he readily changed his political opinions; and he was intemperate in language, and brimful of the shallow humours and prejudices of a little nature. Ruge wrote numerous books, plays, novels, &c., including the outlines of a *Geschichte unserer Zeit* (1881), *Manifest an die Deutsche Nation* (1866), his autobiography in *Aus früherer Zeit* (4 vols. 1863-67), and translations into German of Buckle's *History of Civilisation*, the *Letters of Junius*, Bulwer's *Lord Palmerston*, &c. See Ruge's *Briefwechsel*, &c., ed. by Nerlich (2 vols. 1885-86).

Rugeley, a market-town of Staffordshire, on the Trent, 10 miles ESE. of Stafford. It has good public buildings (1879), a grammar-school, iron-works, and neighbouring collieries. Pop. (1851) 3054; (1881) 4249; (1891) 4181.

Rügen, an island of Prussia, lies in the Baltic, off the coast of Hither Pomerania. Greatest length, 33 miles; greatest breadth, 25 miles; area, 374 sq. m. Pop. (1895) 46,732. It is separated from the mainland by a strait about a mile in width. The island, which is deeply indented by the sea, terminates at the north-eastern extremity in the precipitous cliff called the *Stubbenkammer* (400 feet). Erratic boulders are common all over the island. Numerous barrows exist. Hertha Lake is believed to be the place where, according to Tacitus, the ancient Germanic goddess Hertha (Earth) was worshipped. The soil is productive, and yields good wheat; cattle are reared; and fishing is carried on. The scenery, everywhere pleasing, is frequently romantic, and, together with the facilities for

sea-bathing, attracts numerous visitors. Chief town, Bergen (pop. 3761), in the middle of the island. Rügen was occupied originally by Germanic tribes, then by Slavs, was conquered by the Danes in 1168, threw off their supremacy in 1209, and formed an independent principality until 1478, when it was incorporated with Pomerania (q.v.).

Ruhmkorff, HEINRICH DANIEL, electrician, born at Hanover in 1803, in 1839 settled in Paris, and died there 21st December 1877. His Induction Coil, exhibited in 1855, is described and figured in Vol. VI. p. 129.

Ruhnken, DAVID, classical philologist, was born 21 January 1723 at Stolpe, in Pomerania, received his education at Königsberg, at Wittenberg University, and at Leyden under Hemsterhuis, who taught him Greek. Ruhnken's first works were to prepare a new edition of Plato, to collect the scholia on that author, and publish an edition of Timæus' *Lexicon Vocum Platoniarum* (Leyden, 1754; a much improved edition, 1789). In 1755 he went to Paris, and spent a whole year there examining the MSS. of the Royal Library and of the Library of St Germain. Hemsterhuis then got him appointed assistant to himself (1757) at Leyden. In 1761 he succeeded Oudendorp in the chair of Eloquence and History. In 1774 he succeeded Gronovius as librarian to the university, which he enriched with a multitude of valuable books and MSS. He died 14th May 1798. One of the best scholars and critics of the 18th century, Ruhnken possessed fine taste and sagacity, vast learning, and a remarkably lucid and graceful Latin style. His principal literary works embraced *Epistolæ Criticæ* (1749-51), an edition of Rutilius Lupus (1768), of Velleius Paterculus (1779), of Muretus (1789), &c. His pupil Wytenbach wrote his Life (Leyden, 1799).

Ruhr, a right-hand affluent of the Rhine, rises in Westphalia, near the south-west frontier of Waldeck, flows generally west, and, after a course of 144 miles, joins the Rhine at Ruhrort.

Ruhrort, a town of Rhenish Prussia, situated at the influx of the Ruhr into the Rhine, 26 miles by rail N. of Düsseldorf, is one of the busiest river-ports on the Rhine, carrying on a large trade in corn, timber, iron, &c. In the vicinity there are large ironworks and coal-mines. Pop. (1890) 11,099.

Ruisdael. See RUYSDAEL.

Rule, ST. See REGULUS.

Rule Nisi. See DIVORCE.

Rule of Faith, not the sum of the Christian faith as laid down in Creeds (q.v.) and Confessions (q.v.); but, in polemical theology, the sources whence the doctrines of the faith are to be authoritatively derived—the Scriptures, the tradition of the Church, the teaching of the fathers, &c. See ROMAN CATHOLIC CHURCH, REFORMATION, CHILLINGWORTH, NEWMAN, &c.

Rule of the Road. This phrase includes the regulations to be observed in the movements of conveyances either on land or at sea. *On Land*: In England drivers, riders, and cyclists keep the side of the road next their left hand when meeting, and that next their right when overtaking and passing other horses or conveyances. The person neglecting this rule is liable for any damage that may happen through such neglect. A man riding against a horse, or a conveyance driving against another that is standing still, is answerable for any damage that may ensue. On the Continent and in America drivers and riders keep to the right. *At Sea*: If two steamers are meeting end on or nearly end on, both alter their courses to starboard—i.e. both turn to their right hand. If two steamers are crossing each other, the one which

has the other on the starboard (right hand) side keeps out of the way. A steamer must keep out of the way of a sailing ship. A steamer shall slacken speed or stop and reverse if necessary. If two sailing ships are approaching each other, whether meeting or crossing, one running free keeps out of the way of one close-hauled; one close-hauled on the port tack keeps out of the way of one close-hauled on the starboard tack; one with the wind free on the port side keeps out of the way of one with the wind free on the starboard side; where both have the wind free on the same side the one to windward keeps out of the way of the one to leeward; and a ship with the wind aft keeps out of the way of the other ship. Notwithstanding the above rules, a ship, whether a sailing ship or steamship, overtaking any other must keep out of the way of the overtaken ship. Where one ship is to keep out of the way, the other must keep her course. Regard, however, is to be paid to all dangers of navigation, and to any special circumstances which may render a departure from the rules necessary to avoid immediate danger. See Marsden on *Collisions*.

Rullion Green. See PENTLAND HILLS.

Rum, a mountainous island of Argyllshire, belonging to the group of the Inner Hebrides, 15 miles N. by W. of Ardmurchan Point. It is 8½ miles long, 8 miles broad, and 42 sq. m. in area, only 300 acres being arable, and the rest deer-forest and moorland. The surface presents a mass of high sharp-peaked mountains, rising in Halival and Haiskeval to the height of 2368 and 2659 feet. In 1826 the crofters, numbering fully 400, were, all but one family, cleared off to America, and Rum was converted into a single sheep-farm; but in 1845 it was sold (as again in 1888) for a deer-forest. Pop. (1851) 162; (1881) 89; (1891) 53.

Rum, a kind of spirit made by fermenting and distilling the 'sweets' that accrue in making sugar from cane-juice. The scummings from the sugar-pans give the best rum that any particular plantation can produce; scummings and molasses the next quality; and molasses the lowest. Before fermentation water is added, till the 'sett' or wort is of the strength of about 12 per cent. of sugar; and every ten gallons yields one gallon of rum, or rather more. The flavour of rum depends mainly on soil and climate, and is not good where canes grow rankly. Pine-apples and guavas are at times thrown into the still, but on the great scale no attempt is made to influence flavour artificially. The finest-flavoured rums are produced by the old-fashioned small stills. The modern stills, which produce a strong spirit at one operation, are unfavourable to flavour. The colour of rum is imparted after distillation by adding a certain proportion (varying with the varying taste of the market) of caramel, or sugar melted without water, and thus slightly charred. Rum is usually distilled at about 40 per cent. overproof; and it is calculated that from nine to ten acres of land will produce two hogsheds of sugar as well as about a puncheon of rum. Rum is greatly improved by age, and old rum is very often highly prized; at a sale in Carlisle in 1865 rum known to be 140 years old sold for three guineas per bottle. It forms a very important part of colonial produce: the quantity imported into Britain in 1848 was 6,858,981 gallons; in 1875, 8,815,681 gallons; in 1881, 4,816,887 gallons (value £485,685); in 1889, 4,087,109 gallons (value £340,026). In the production of rum Jamaica claims the first place and Demerara the second. It is produced also in some of the French possessions.

RUM SHRUB, a liqueur in which the alcoholic base is rum, and the other materials are sugar,

lime or lemon juice, and the rind of these fruits added to give flavour. Almost every maker has his own receipt, and much credit is assumed by each for his own especial mixture.

Rumania. See ROUMANIA.

Rumford, COUNT. Benjamin Thompson, a man of many talents, was born of an old colonial stock at Woburn, in Massachusetts, on 26th March 1753. His youth was spent as an assistant in a goods store at Salem and at Boston, and as a school teacher. But having married a lady of standing, he was made major in a New Hampshire regiment, and, through his royalist opinions, incurred the hostility of the colonists to such an extent that he found it best to cross the ocean to England (1775). In London he gave valuable information to the government as to the state of the colony, and was rewarded with an appointment in the Colonial Office. From his boyhood he had had a passion for physical investigations; in England he experimented largely with gunpowder, and was elected a Fellow of the Royal Society (1779). In 1782 he was back in America, with a lieutenant-colonel's commission in the king's army. After peace was concluded he was knighted, and entered the service of the Elector of Bavaria. In this new sphere he showed great reforming energy: he thoroughly reformed the army, drained the marshes round Mannheim, established in Munich a cannon-foundry and a military academy, cleared the country of the swarms of beggars and planned a poor-law system, spread widely the cultivation of the potato, disseminated a knowledge of cheap and good dishes (especially the Rumford soup) and foods, devised an economical fireplace, kitchen, and oven (the Rumford roaster), improved the breeds of horses and cattle in Bavaria, and laid out the English Garden in Munich. For these services he was rewarded by election to membership of the Academies of Science in Munich, Mannheim, and Berlin, by being put at the head of the War Department of Bavaria, and by being made a count of the Holy Roman Empire—he chose the title of Rumford, the former name of the town of Concord in Massachusetts. During the course of a visit to England in 1796 he endowed the two Rumford medals of the Royal Society of London, and he also endowed two similar medals of the American Academy of Science and Art, all four for researches in light and heat. Three years later was founded on his initiative the Royal Institution (q. v.) for diffusing the knowledge of mechanical inventions. Going back to Munich in the same year, he found it threatened by the opposing French and Austrian armies. The Elector fled, leaving Count Rumford president of the Council of Regency, generalissimo of the forces, and head of the police. In 1799 he retired from the service of the Elector. His remaining years were principally occupied with physical investigations, especially in heat, which he clearly recognised to be some form of motion, besides showing that a definite quantity of heat could be produced by a definite amount of mechanical work. In 1804 he married the widow of Lavoisier, the celebrated chemist, and soon after settled at Autenil, near Paris, where he died on 21st August 1814. See the *Memoir* prefixed to his *Scientific Writings* (5 vols. London, 1876), and the biography by Bauernfeind (Munich, 1889).

Ruminants, a name applied to those even-toed or Artiodactyl Ungulates which 'chew the cud.' These are (a) the Tragulidæ, often called musk-deer; (b) the Cotylophora, including antelopes, sheep, goats, oxen, giraffes, deer; (c) the Camelidæ, or camels and llamas. Their characteristics and the process of rumination are described in the article ARTIODACTYLA, with which those on DIGESTION and on CATTLE should be compared.

Rump Parliament. See LONG PARLIAMENT, CROMWELL.

Runcorn, a thriving market and manufacturing town and river-port of Cheshire, on the left bank of the tidal Mersey, 12 miles ESE. of Liverpool and 28 WSW. of Manchester. The river is crossed here by a railway viaduct, which, erected in 1864-69 at a cost of over £300,000, is 1500 feet long and 95 feet above high-water mark. An ancient place, where a castle was founded by the Princess Ethelfreda in 916, and a priory in 1133, it yet dates all its prosperity from the construction of the Bridgewater Canal (1762-72), which at Runcorn descends to the Mersey by a succession of locks. More canal-boats plied to and from Runcorn than from anywhere else in the kingdom even before the opening of the Manchester Ship-canal (1887-94; see MANCHESTER, and CANAL, Vol. II. p. 700); and there are besides spacious docks with considerable shipping, Runcorn having been made a head-port in 1847. The industries include shipbuilding, iron-founding, rope-making, the manufacture of chemicals, quarrying, &c. Pop. (1851) 8049; (1871) 12,443; (1891) 20,050.

Runeberg, JOHAN LUDVIG, the greatest poet who has written in Swedish, and the national poet of Finland, was born in that country, at Jacobstad on the Gulf of Bothnia, on 5th February 1804. His father, a retired sea-captain, gave him a good education; though from the time he entered (1822) the university of Åbo he supported himself. In 1830, after three years of private 'coaching,' Runeberg was given a secretaryship in the university (removed to Helsingfors in 1827) and was named reader in Eloquence (Latin literature), and in the following year added to these offices that of teacher in the lyceum. In these years he published his first books—in 1830 a volume of *Lyric Poems* and in 1831 a narrative poem, *The Grave in Perrho*, for which the Swedish Academy gave him its minor gold medal. Other books followed in quick succession, as a beautiful epic idyll, *The Elk-hunters* (1832), one of his finest pieces of work; a second volume of *Poems* (1833), containing amongst other things a second epic idyll, *Christmas Eve*; and a third epic idyll, *Hanna*, which is almost equal to *The Elk-hunters* in beauty and finish of style. All three are written in hexameters, which Runeberg manages with admirable effect; like other poems of the same class, they deal with the rural life of the interior of Finland, *Hanna* with the joys and sorrows of the quiet parsonage, *The Elk-hunters* with the peasantry and country-folk, and *Christmas Eve* with the manor-house and its dependents. Runeberg describes the fresh, unconventional manners and the old-world, patriarchal style of living of these people with great wealth of picturesque detail, with excellent taste, with tender sympathy, with grace and simplicity and beauty of form. The atmosphere that envelops his poetry was the immediate creation of his own wholesome, healthy, manly temperament and genius; one sterling ingredient is a quaint natural humour, deep-seated and pure in quality. Runeberg's poetry is moreover the written embodiment of the deepest feelings and sentiments of the dual people of Finland, of the Finns no less than of the descendants of the Swedish immigrants, and with his name all Finlanders associate their passionate devotion to their country.

From 1832 Runeberg added to his already numerous duties those of editor of the bi-weekly *Helsingfors Morning News*. But, with all these irons in the fire, he had too much work and too little pay, and there was little prospect of a good permanent position in the university; so in 1837 he applied

for, and obtained, the post of reader of Roman Literature in the college of Borgå, where he spent the rest of his life, and died 6th May 1877. During these last years he wrote an epic of Russian life, *Nadeschda* (1841); a third volume of *Poems* (1843); an epic of old Norse times, *King Fjalar* (1844); *Ensign Stål's Stories* (2 vols. 1848 and 1860); a slight but merry little comedy, *Can't* (1862); a fine tragedy in the old Greek spirit, *The Kings in Salamis* (1863); and some short *Prose Writings* (1854). *King Fjalar* is, artistically, his greatest achievement, if not the greatest achievement in Swedish literature; but its fame has been eclipsed by Ensign Stål's glowing stories of Finland's heroic struggle against the giant Russia in 1809. The opening poem of the series, 'Our land, our land,' has been fittingly chosen as the national song of Finland. The very heart of the people throbs in these stirring songs. In 1857, after four years' labour, Runeberg edited for the Lutheran Church of Finland a *Psalm-book*, in which were included above sixty pieces from his own pen. He also excelled as a translator of folk-songs from Servian, German, and other languages. There is only one single poem in all his longer works that lacks the finished simplicity, beauty, and classic restraint which are so characteristic of him; that is a cycle entitled *Nights of Jealousy*, written in early youth.

The best biography (but only reaching down to 1837) is J. E. Strömberg's (3 parts, Helsingfors, 1880-89). This must be supplemented by Nyblom's preface to Runeberg's *Samlade Skrifter* (6 vols. Stockholm, 1873-74) and monographs (in Swedish) by Dietrichson and Rancken (Stockholm, 1864), Cygnäus (Helsingfors, 1873), and Vasenius (Helsingfors, 1890), a Life (in German) by Peschier (Stuttgart, 1881), and the preface to Eigenbrodt's excellent German translation of Runeberg's epic poems (2 vols. Halle, 1891). English readers will find a useful account of Runeberg's life, with specimens of his poems translated, in E. W. Gosse's *Northern Studies* (1879); a fairly faithful translation of his lyric poems, with a biographical notice, in Magnusson and Palmer's *Runeberg's Lyrical Songs* (1878); and an indifferent translation of *Nadeschda* by Mrs Shipley (1891).

Runes. In the Scandinavian lands, Sweden, Denmark, and Norway, thousands of inscriptions have been found written in the ancient alphabet of the heathen Northmen. Similar records are scattered sparsely and sporadically over the regions which were overrun or settled by the Baltic tribes between the 2d century and the 10th. A few are found in Kent, which was conquered by the Jutes, others in Cumberland, Dumfriesshire, Orkney, and the Isle of Man, which were occupied by the Norwegians, and in Yorkshire, which was settled by the Angles. One or two have been found in the valley of the Danube, which was the earliest halting place of the Goths in their migration southwards; and there is reason to believe that a similar alphabet was used by the Visigoths and Burgundians in Spain and France, while it is noteworthy that there is no trace of this writing having been used in Germany, or by the Saxons and Franks.

The writing is called Runic, the individual letters are called rune-staves, or less correctly runes, and the runic alphabet is called the Futhorc, from the first six letters *f, u, th, o, r, c*. The Old Norse word *run* originally meant something 'secret' or magical. The oldest extant runic records may date from the 1st century A.D., the latest from the 15th or 16th, the greater number being older than the 11th century, when after the conversion of the Scandinavians the futhorc was superseded by the Latin alphabet. The form, number, and value of the runic letters changed considerably during the many centuries they were in use, the runes of different periods and countries exhibiting

considerable differences. They may, however, be arranged in three main divisions: (1) the Gothic or old Scandinavian runes, which are chiefly found in inscriptions earlier than the 6th century; (2) the Anglian runes, used in Northumbria from the 7th to the 9th century; (3) the later Scandinavian runes, used in Sweden and Norway in the 7th and following centuries. These futhorcs are shown in

Names.	Values.	Goth.	Angl.	Scand.
fech, feh, fe	f	𐌺	𐌸	𐌺
ur	u	𐌹	𐌹	𐌹
thorn	th	𐌴	𐌴	𐌴
asc, asc, os	a, a, o	𐌹	𐌹	𐌹
rad, rat	r	𐌹	𐌹	𐌹
cen	c, k	𐌺	𐌺	𐌺
gifu	g	𐌺	𐌺	
wen	w	𐌺	𐌺	
hegl, hagal	h	𐌺	𐌺	*
nyd, nod	n	𐌺	𐌺	𐌺
is	i	𐌺	𐌺	𐌺
ger, yr, ar	ge, y, a	𐌺	𐌺	𐌺
ih, eoh	yo, eo	𐌺	𐌺	
peorth, pero	p	𐌺	𐌺	𐌺
ilix, calc	a, i, k, x	𐌺	𐌺	
sigil	s	𐌺	𐌺	𐌺
tir	t	𐌺	𐌺	𐌺
berc	b	𐌺	𐌺	𐌺
ech, eh	e	𐌺	𐌺	
man	m	𐌺	𐌺	𐌺
lagu	l	𐌺	𐌺	𐌺
ing	ng	𐌺	𐌺	
dag	d	𐌺	𐌺	
othil	o, œ	𐌺	𐌺	

the table. The oldest is the Gothic futhorc of twenty-four runes, divided into three families, each of eight runes. This is used in about 200 inscriptions, several of which can be approximately dated from the 3d century to the 5th, while others, from the more archaic forms of the runes, must belong to an earlier period. The oldest to which a date can be assigned is on a golden torque from a temple of the heathen Goths in Wallachia, which must be earlier than the conversion of the Goths in the 3d century. In the Anglian futhorc, which was derived from the Gothic, many new runes were obtained by differentiation, and the phonetic values underwent considerable changes. The Anglian runes are from 25 to 40 in number. The later Scandinavian futhorc, in which the greater number of runic inscriptions were written, consists of a definite alphabet of 16 runes.

The origin of the runic writing has been a matter of prolonged controversy. The runes were formerly supposed to have originated out of the Phœnician or the Latin letters, but it is now generally agreed that they must have been derived about the 6th century B.C., from an early form of the Greek alphabet which was employed by the Milesian traders and colonists of Olbia and other towns on the northern shores of the Black Sea. These traders, as we know from Herodotus, penetrated to the north by the trade-route of the Dnieper, as far probably as the territory occupied by the Goths on the head-waters of the Vistula. This conjecture is confirmed by the fact that Greek coins struck in

the 5th century B.C. have been found in the region of the Baltic. The oldest runic inscriptions being retrograde, the Goths must have obtained the art of writing from the Greeks at a time when Greek was still written in the retrograde direction from right to left, which gives us a date earlier than the 5th century, but after the new letters *omega* and *chi* had been evolved, and while H retained the value both of *h*, which it has in the Latin alphabet, and of *ē*, which it has in the Greek, and also before *koppa*, which became Q in Latin, fell into disuse among the Greeks. From these and similar data it appears that the runic writing must have been obtained from the Greeks after the 7th and earlier than the 5th century B.C. That the runic alphabet was developed from the Greek is proved among other things by the facts that it contains a symbol for *ō* which was developed from *omega*, a letter peculiar to the Greeks, and that it contains a symbol for *ng*, which proves to be a ligature of two *ganmas*, Greek being the only language in which *gg* has the phonetic value of *ng*. The value of the runes must have changed to some extent after the symbols were obtained from the Greeks, owing to the sound changes tabulated in Grimm's Law (q.v.) not having been completed at the time when the runic writing was obtained. Thus, according to Grimm's Law, a Greek *th* answers to a Gothic *d*, and a Greek *ch* to a Gothic *g*, and we find, as we should expect, that the *d* rune was derived from *theta*, and the *g* rune from *chi*. The forms of the runes were considerably modified by the fact that they were cut with a knife on wooden slabs; consequently horizontal strokes, which would follow the grain of the wood, are necessarily avoided, and all the strokes are either vertical or slanting.

There are several interesting runic inscriptions in England, among which may be mentioned that on the Ruthwell (q.v.) cross in Dumfriesshire, and that on the Bewcastle (q.v.) cross in Cumberland, a fac-simile of which is given here. It is a memorial of Alcfrid, son of Oswin, king of Northumbria, and dates from the 7th century. Several crosses in the Isle of Man are carved with the old Irish interlaced ornament, and are in the form of the old Irish cross. As they have also runic inscriptions, this style of Irish ornament has wrongly acquired the name of runic knot-work, and the Irish form of cross is often called the runic cross. These names originated at a time when archaeological

knowledge was less advanced than it is now, and should be rejected.

Fac-similes of the chief runic inscriptions have been conveniently collected by Dr G. Stephens of Copenhagen in his *Handbook of Runic Monuments* (1884), which is an abridgment of his larger work on the *Old Northern Runic Monuments* (3 vols. 1866-68-84). The origin of the runes is discussed by the present author in his book on *The Alphabet* (1885), and at greater length in a monograph entitled *Greeks and Goths: a Study on the Runes* (1879). The works of Dr Wimmer, Dr Bugge, Mr Haigh, and Dr Kirchoff may also be consulted.

Runjeet-Singh. See RANJIT.

Run of Cutch. See CUTCH.

Runner, in Botany, is a long, slender branch proceeding from a lateral bud of a herbaceous plant with very short axis, or, in popular language, without stem. It extends along the ground, and produces buds as it proceeds, which often take

root and form new plants. Strawberries afford a familiar example. Another is found in *Potentilla anserina*. Runners are common in the genus *Ranunculus*.

Runners. See BEAN.

Runnimead, a long stretch of green meadow, lying along the right bank of the Thames, 1 mile above Staines and 36 miles by river WSW. of London. Here, or on Charta Island, a little way off the shore, Magna Charta (q.v.) was signed by King John, June 15, 1215. It bears to have been signed '*per manum nostram in prato quod vocatur Runnimead*.'

Running. See ATHLETIC SPORTS.

Runrig Lands are a species of ownership, still existing in different parts of Scotland and Ireland, under which the alternate ridges of a field belong to separate proprietors. The right of the several parties to the alternate ridges is absolute, and thus this kind of possession differs from common property. These runrig, runridge, or rundale lands, as they are variously called, are survivals of the simple form of open-field husbandry, under the tribal system once universally prevalent in the western districts of Britain, and well suited to the precarious and shifting agriculture of those times. The form of rural economy which gave rise to this mode of tenure has lately been carefully and successfully investigated by several students, prominent among whom is Mr Frederic Seebohm, who has published the results of his researches in his well-known work on the *English Village Community*. The obstruction to agricultural improvement resulting from the land being thus dispersed in small pieces intermixed with each other led, in the end of the 17th century, to the introduction of a mode of compulsory division or allotment of such lands. By statute 1695, chap. 23, it was provided that, 'wherever lands of different heritors be runrig, application may be made to the judge ordinary or justices of the peace 'to the effect that these lands may be divided according to their respective interests.' This remedy, however, does not apply to burgh acres or to patches of land less than four acres in extent.

Rupee, a silver coin current in India, of the value of 2s. English (see INDIA, Vol. VI. p. 114). Owing to the depreciation of silver, the present average value of the rupee is 1s. 2½d. A lac (or lakh) of rupees is 100,000 (at the old value of 2s. = £10,000), and a crore is 10,000,000. Coins are struck in silver of the value of 1, 2, ½, ¼, and ⅓ rupee. The first rupee was struck by Sher Shah, the Afghan emperor of Delhi (1540-45), and was adopted by Akbar and his successors; but in the decline of the Mohammedan empire every petty chief coined his own rupee, varying in weight and value, though usually bearing the name and titles of the reigning emperor. The rupee is the official money of account in the island of Mauritius.

Rupert, PRINCE, third son of the Elector Palatine Frederick V. and Elizabeth, daughter of James I. of England, was born at Prague on 18th December 1619, his parents having the month before been crowned king and queen of Bohemia. He studied at Leyden, and became well grounded in mathematics and religion ('indeed, made Jesuit-proof'), as well as in French, Spanish, and Italian, and above all the art of war. After a year and a half at the English court, where it was proposed to make a bishop of him or viceroy of Madagascar, he served in 1637-38, during the Thirty Years' War, against the Imperialists, until at Lemgo he was taken prisoner, and confined for nearly three years at Linz. In 1642 he returned to England,

in time to be present at the raising of the king's standard at Nottingham; and for the next three years the 'Mad Cavalier' was the life and soul of the royalist cause, winning many a battle by his resistless charges, to lose it as often by a too headlong pursuit. He had fought at Worcester, Edgehill, Brentford, Chalgrove, Newbury, Bolton, Marston Moor, Newbury again, and Naseby, when in August 1645 his surrender of Bristol after a three weeks' siege so irritated Charles, who the year before had created him Duke of Cumberland and generalissimo, that he curtly dismissed him, and sent him his passport to quit the kingdom. A court-martial, however, completely cleared him, and he resumed his duties, only to surrender at Oxford to Fairfax in the following June. He now took service with France, but in 1648 accepted the command of that portion of the English fleet which had espoused the king's cause. As admiral or corsair, Prince Rupert acquitted himself with all his old daring and somewhat more caution; and for three years he kept his ships afloat, escaping at last the blockade in which for nearly a twelve-month he was held at Kinsale on the Irish coast by Blake. But in 1651 the latter attacked his squadron, and burned or sunk most of his vessels. With the remnant the prince escaped to the West Indies, where, along with his brother Maurice, till the loss of the latter in a hurricane (1652), he led a buccaneering life, maintaining himself as before by the seizure of English and other merchantmen. In 1653 he was back in France, where and in Germany he chiefly resided till the Restoration. Thereafter he served with distinction under the Duke of York, and, in concert with the Duke of Albemarle, in naval operations against the Dutch; and he died at his house in Spring Gardens, 29th November 1682, in the enjoyment of various offices and dignities, being a privy-councillor, governor of Windsor, an F.R.S., &c. He left a natural daughter, Ruperta, born to him in 1673 by Margaret Hughes, actress. His last ten years had been spent in retirement in the pursuit of chemical, physical, and mechanical researches, for which he evinced considerable aptitude. Though he was not the inventor of mezzotint (see ENGRAVING, Vol. IV. p. 381), Prince Rupert no doubt improved the processes of the art, which he described to the Royal Society in 1662, after executing several interesting engravings on the new principle. Among his discoveries were an improved gunpowder, the composition known as 'Prince's metal,' and perhaps the 'Prince Rupert's Drops,' or curious glass bubbles described under Annealing (q. v.).

See Eliot Warburton's *Memoirs of Prince Rupert and the Cavaliers* (3 vols. 1849); Lord Ronald Gower's *Rupert of the Rhine* (1890); and other works cited at ELIZABETH (of Bohemia), CHARLES I., and CHARLES II.

Rupert's Land. See HUDSON BAY COMPANY.

Rupia is a somewhat severe form of skin disease. It is characterised by flatish, distinct *bullæ* or blebs, containing a serous, purulent, or sanious fluid, which become changed into thick scabs. Several varieties of this disease have been established by dermatologists. In its simplest form the blebs are not preceded by any inflammatory symptoms, are about an inch in diameter, and contain a fluid which is originally thin and transparent, but soon thickens, becomes purulent, and dries into brown, ragged scabs, which are elevated in the centre. The scabs are easily separated, and leave ulcerated surfaces, on which several successive scabs usually form before healing ensues. In a more severe form, known as *Rupia prominens*, the scab projects so much in the centre as to resemble a limpet-shell in form.

Rupia is a chronic disease, and is usually limited to the limbs, the loins, and the nates. It is not contagious, and generally attacks persons debilitated by old age, intemperance, bad living, or previous diseases, especially smallpox, scarlatina, and syphilis. The general treatment consists mainly in the administration of tonics (e.g. quinia), the mineral acids, ale, wine, animal food, &c. Some writers strongly recommend the tincture of serpentaria; and there is no doubt that certain cases which will not yield to tonics rapidly improve when treated with iodide of potassium. The local treatment consists in puncturing the blebs as soon as they arise, in removing the scabs by poulticing, and in applying a slightly stimulating application—such as a solution of nitrate of silver—to the subjacent ulcers. The disease is frequently tedious and obstinate, but the patient almost always ultimately recovers.

Ruppin, NEU, a town of Prussia, on a small lake of the same name, which communicates with the Elbe, 48 miles by rail NW. of Berlin. It was built by Frederick William II. after a fire in 1787, and is a handsome town with (1895) 15,521 inhabitants, who manufacture cloth, picture-books, machinery, starch, brushes, &c.

Rupture. See HERNIA.

Rural Dean. See DEAN.

Rurik, the founder of the Russian monarchy. See NORTHMEN, and RUSSIA.

Rurki, a town in the North-west Provinces of India, 22 miles E. of Saharanpur, with the Thomason Engineering College, a station for British troops, mission school, and meteorological observatory. Pop. 15,953.

Rush, BENJAMIN, an American physician, was born in what is now the twenty-third ward of Philadelphia, December 24, 1745, graduated at Princeton in 1760, studied medicine in Philadelphia, Edinburgh, London, and Paris, and in 1769 was made professor of Chemistry in the Philadelphia Medical College. Elected a member of the Continental Congress, he signed the Declaration of Independence (1776). In April 1777 he was appointed Surgeon-general, and in July Physician-general, of the Continental army. His duties did not prevent him from writing a series of letters against the articles of confederation of 1776. In 1778 he resigned his post in the army, because he could not prevent frauds upon soldiers in the hospital stores, and returned to his professorship. He was a founder of the Philadelphia dispensary, the first in the United States, and of the College of Physicians, was active in the establishment of public schools, was a member of the state conventions which ratified the Federal constitution and formed the state constitution. He next became professor of the Theory and Practice of Medicine at Philadelphia, to which chair he added those of the Institutes and Practice of Medicine and Clinical Practice (1791), and of the Practice of Physic (1797); and during the epidemic of 1793 he was as successful as devoted in the treatment of yellow fever. Virulently attacked, owing to his methods of practice, by William Cobbett, who published a newspaper in Philadelphia, he prosecuted him for libel, and recovered \$5000 damages. In 1799 Rush was appointed treasurer of the United States Mint, which post he held till his death, 19th April 1813. He was called 'the Sydenham of America,' and his medical works brought him honours from several European sovereigns. The chief of them were *Medical Inquiries and Observations* (5 vols. 1789-93), *Essays* (1798), and *Diseases of the Mind* (1821; 5th ed. 1835).—His son, RICHARD (1780-1859), a lawyer

and statesman, was minister to England in 1817–25, where he negotiated the important Fisheries and North-eastern Boundary Treaties, and was Secretary of the Treasury from 1825 to 1829. In 1828 he was an unsuccessful candidate for the vice-presidency of the United States; and in 1836–38 he secured for his country the whole of the legacy which James Smithson had left to found the Smithsonian Institution.

Rush, a seaport of Ireland, 16 miles by rail NE. of Dublin. Pop. 1071.

Rush (*Juncus*), a genus of plants of the natural order Juncææ, having a glume-like (not coloured) perianth, smooth filaments, and a many-seeded, generally three-celled capsule. The species are numerous, mostly natives of wet or marshy places in the colder parts of the world; some are found in tropical regions. Some are absolutely destitute of leaves, but have barren scapes (flower-stems) resembling leaves; some have leafy stems, the leaves rounded or somewhat compressed, and usually jointed internally; some have plane or grooved leaves on the stems; some have very narrow leaves, all from the root. The name Rush perhaps properly belongs to those species which have no proper leaves; the round stems of which, bearing or not bearing small lateral heads of flowers, are

popularly known as *Rushes*. The Soft Rush (*J. effusus*) is a native of Japan as well as of Britain, and is cultivated in Japan for making mats. The Common Rush (*J. conglomeratus*) and the Soft Rush are largely used for the bottoms of chairs and for mats, and in ruder times, when carpets were little known, they were much used for covering the floors of rooms; to this many allusions will be found in early English writers. The stems of the true rushes contain a large pith or soft central substance, which is sometimes used for wicks to small candles, called rushlights. There are twenty or twenty-two British species of rush, some of which are very rare, some found only on the highest mountains, but



Common Rush (*Juncus conglomeratus*).

some are among the most common of plants. They are often very troublesome weeds to the farmer. Thorough drainage is the best means of getting rid of them. Lime, dry ashes, road scrapings, &c. are also useful. Tufts of rushes in pasture are a sure sign of insufficient drainage. Many marshy and boggy places abound in some of the species having leafy stems and the leaves jointed internally, popularly called *Sprots* or *Sprits*, as *J. acutiflorus*, *J. lamprocarpus*, and *J. obtusiflorus*. They afford very little nourishment to cattle; but are useful for making coarse ropes for ricks, &c., which are stronger than those made of hay.—Rushlights or candles with rush-wicks were anciently much in use, and Gilbert White tells us how, by carefully dipping the rush in grease with a little wax added, the poor man might enjoy five and a half hours of comfortable light for a farthing. Rushes, with a few sweet herbs, were used to strew the floors before carpets came into use, and, as they were seldom entirely renewed, the insanitary consequences may be imagined. The stage was also strewed with rushes in Shakespeare's time, as well as the churches with rushes or straw according to

the season of the year—a custom still honoured at the Hull Trinity House—and anciently rushes were scattered in the way where processions were to pass. To order fresh rushes was a sincere mark of honour to a guest. The strewing of the churches grew into a religious festival conducted with much pomp and circumstance. This ceremonious rush-bearing lingered long in the northern counties, and has been occasionally revived in modern times, as at Grasmere in 1884, &c.

Rush-nut (*Cyperus esculentus*). See CYPERUS.

Rushworth, JOHN, whose *Historical Collections of Private Passages of State, Weighty Matters of Law, Remarkable Proceedings in Five Parliaments*, is an important contribution to our knowledge of the Civil War, and the events that led to it, belonged to an ancient family in Northumberland, and was born there about 1607. He studied at Oxford, and settled in London as a barrister. He appears to have spent a great deal of his time for many years in attending the Star Chamber, the Court of Honour, the Exchequer Chamber, Parliament, &c., and in taking down shorthand notes of the proceedings. When the Long Parliament met in 1640 he was appointed assistant to Henry Elsyngne, clerk of the House of Commons. He sat in parliament as member for Berwick; was in 1645 secretary to Sir Thomas Fairfax, and in 1677 to the Lord Keeper of the Great Seal. In 1684 he was flung into the King's Bench for debt, and here he died, 12th May 1690. Rushworth's *Historical Collections* cover the period 1618–48, and were published in four instalments—in 1659, 1680, 1692, and 1701. The whole was republished in 1721 in 7 vols. Rushworth had the instinct of perpetuity, for he sets forth as the motive for his labour 'the impossibility for any man in after ages to ground a true History, by relying on the printed pamphlets of our days, which passed the press while it was without control.' The work has been blamed by royalist authors as unfair, and Carlyle often rails on its worthy author as a Dryasdust.

Ruskin, JOHN, the most eloquent and original of all writers upon art, and a strenuous preacher of righteousness, was born in London, 8th February 1819. He was an only child; his father (1785–1864), a wealthy wine-merchant, was an Edinburgh man settled in London. He was educated in his father's house, first in London and afterwards at Denmark-hill, till he went, as a gentleman commoner of Christ Church, to Oxford. There he gained the Newdigate prize for English poetry—by a poem on *Salsette and Elephantia*—in 1839, and took his degree in 1842. He studied painting under Copley Fielding and Harding; but his masters in the art were, he says, Rubens and Rembrandt. The story of the earlier years of his life has been told by Ruskin himself very fully in his *Præterita*, one of the most charming autobiographies in the language. In 1843 appeared the first volume of his *Modern Painters*, the primary design of which (in reply to a criticism of Turner in *Blackwood's Magazine*) was to prove the superiority of modern landscape-painters, and more especially of Turner, to the Old Masters; but in the later volumes (the fifth and last was published in 1860) the work expanded into a vast discursive treatise on the principles of art, interspersed with artistic and symbolical descriptions of nature, more elaborate and imaginative than any writer, prose or poetic, had ever before attempted. *Modern Painters* was essentially revolutionary in its spirit and aim, many of the most distinguished landscape-painters, both of old and new schools, being summarily dealt with and condemned; and the work naturally excited the aversion and hostility of the conservatives in art. But the unequalled splendour of its

style gave it a place in literature; the originality of its views, the lofty conception of the painter's art displayed in it, and the evident justness of much of the criticism, secured recognition. Disciples soon appeared; and the views of art enunciated by Ruskin gradually made way, and have largely determined the course and character of later English art. The first volume was published in a much altered form in 1846. The last three volumes contained illustrations by the author. A revised and altered edition appeared in 1860-67; another in 1873; and an edition in six volumes, with some additional plates, an epilogue, and new index, in 1889. In 1849 appeared *The Seven Lamps of Architecture*; and in 1851-53 *The Stones of Venice*, both being efforts to introduce a new and loftier conception of the significance of domestic architecture. They were exquisitely illustrated by the author himself. About this time Pre-Raphaelitism (q.v.) began to develop itself as a distinctive phase of modern art, and Ruskin warmly espoused its cause in letters, pamphlets, and *Notes on the Academy Exhibition* (1855-60). He was the earliest literary advocate of this school, whose leading principle he defined as the resolve 'to paint things as they probably did look and happen, not as, by rules of art developed under Raphael, they might be supposed gracefully, deliciously, or sublimely to have happened.'

In 1854 he published four admirable and suggestive *Lectures on Architecture and Painting*; and in 1858 two *Lectures on the Political Economy of Art*. The *Notes on the Construction of Sheepfolds* (1851), dealing with the discipline of the church, illustrate his ingenuity in devising picturesque titles that suggest no notion of the subject treated. *The King of the Golden River*, a fairy story, was published in 1851; and in 1854 *The Two Paths*, lectures on art and its application to decoration and manufacture. The *Elements of Drawing* and the *Elements of Perspective* appeared in 1857 and 1859. The *Crown of Wild Olive* is a series of four essays on work, traffic, war, and the future of England; *Sesame and Lilies*, lectures on good literature. *The Queen of the Air* is a study of the Greek myths of cloud and storm; *Ethics of the Dust*, lectures on crystallisation; *Ariadne Florentina*, on wood and metal engraving; *Aratra Pentelici*, on the principles of sculpture. The *Laws of Fesole* are the elements of painting and drawing; *Frondes Agrestes* are readings from 'Modern Painters'; *Giotto and His Works*, *Love's Meinie* (on Birds), and *Deucalion* (on Geology) are other publications. *Munera Pulveris* contains the elements of political economy according to Ruskin; while *Unto this Last*—in Ruskin's opinion, the best of his works—attacks the current doctrines of the 'dismal science.' *Val d'Arno* contains lectures on the art of the 13th century in Pisa and Florence; later courses dealt with the modern art of England and English history (*Pleasures of England*). *Mornings in Florence* are studies of Christian art for English travellers; and *St Mark's Rest* is on the history of Venice. *The Eagle's Nest* discusses the relation of natural science to art; *Time and Tide* are letters to a working-man of Sunderland. *Arrows of the Chace* is a selection of his letters; *On the Old Road* is the title of a republication of his miscellaneous pamphlets, articles, and essays contributed to various reviews and magazines, containing famous utterances on Samuel Prout, the History of Christian Art, the Lord's Prayer, the 'Cestus of Aglaia,' &c. An early volume of poems, issued for private circulation, became a much sought after bibliographical treasure; in 1891 it was reprinted (in 2 vols.) with many additional pieces and illustrations from the author's drawings. *Fors Clavigera* appeared as a sort of periodical at irregular inter-

vals for several years, in the form of letters to the workmen and labourers of Great Britain, on a great variety of topics (vols. 1.-viii. with full index, 1887). *Proserpina*, published in the same way, gives studies of wayside flowers. *Hortus Inclusus* (1887) is a series of letters 'to the ladies of the Thwaite.' Second-hand copies of the early works are still eagerly bought up at high prices; thus, the old edition of *Modern Painters*, worth £8, 10s. at its publication in 1860-67, has repeatedly been sold since 1880 for £30 or £35. All Mr Ruskin's books were for a time published privately at Orpington in Kent; but eventually he published them through an agent of his own in the usual way, except that the author insisted on their being sold at net prices. From 1869 till 1879 Ruskin was Slade professor of Art at Oxford; in 1871 he gave £5000 for the endowment of a master of drawing there; in 1883 he was re-elected professor, but resigned in the following year. He was a D.C.L. of Oxford, and an honorary student of Christ Church. In 1871 the degree of LL.D. was bestowed upon him by the university of Cambridge. Subsequently he founded a museum at Walkley, near Sheffield (in 1890 transferred to Sheffield itself), where he bestowed part of his own priceless library and art treasures. In his later years he established himself at Brantwood, on Coniston Lake, in the Lake Country. He died 20th January 1900.

Ruskin is or was primarily a critic of art; but, as the titles of his works indicate, his teaching has extended over a wide area. Art for him is closely and inseparably bound up with truth, with morals, with religion; and in most departments of political philosophy, in social and political economy, Ruskin has been constant, in season and out of season, in lifting up his testimony against what he conceives to be low views, perverted ideals, coarse and vulgar complacencies. Like Carlyle, whose pupil he professes to be, he holds the world in these later days to have gone on a wrong tack; in his views of nature and life he is, he says, 'alone in the midst of a modern crowd, which rejects them all,' and has to 'maintain himself against the contradiction of every one of his best friends.' Within the sphere of art criticism he declares that an important part of his life-work has been to teach 'the supremacy of five great painters, despised till he spoke of them—Turner, Tintoret, Luini, Botticelli, and Carpaccio.' His life-long contention with political economy is based on the belief that the science has been used to inculcate the unchecked and competitive pursuit of merely material wealth. He affirms broadly that his *Munera Pulveris* contains the first accurate analysis of the laws of political economy which has been published in England. What is usually called political economy is in reality nothing more than the investigation of some accidental phenomena of modern commercial operations, and has no connection with political economy as treated by the great thinkers of the past—such as Plato, Xenophon, Cicero, Bacon. True political economy regulates the acts and habits of a society or state, with reference to its maintenance, as domestic economy does those of a household. It is neither an art nor a science, but a system of conduct and legislation, founded on the sciences, directing the arts, and impossible except under certain conditions of moral culture. By the maintenance of the state, which is the object of political economy, is to be understood the support of its population in healthy and happy life, and the increase of their numbers, so far as is consistent with their happiness. It is the 'multiplication of human life at the highest standard,' cherishing and developing the noblest type of manhood, alike in beauty, in intelligence, and in character. The wealth of which Ruskin takes cognisance is not

mere exchangeable value, but intrinsic and effectual wealth, consisting of things contributing to the support of life in its fullest sense—as land, houses, furniture, instruments, food, medicine, clothing, books, works of art. The subject of political economy, therefore, embraces a large part of the sphere of private and public morals, and of political philosophy. It deals with the relation of master to servant, employer to workman, of the state to its subjects, with the province of sanitary and commercial legislation, and with the duty of the state in promoting education, suppressing luxury, regulating the hours and wages of labour. He is as confident as the most revolutionary reformer that the conditions of modern society must be completely changed and reconstructed; his ideals coincide in many points with those of some Socialists, though many of his aims would be regarded as distinctly reactionary. A 'violent illiberal' rather than a conservative, Ruskin regards reverence for natural beauty, truth, and godliness as the highest elements in life, and would give properly constituted authority extensive powers; usury of any kind is as indefensible as avarice or dishonesty. Till of late he was seldom treated as a serious political economist; but it has recently been admitted that he has actually pointed out some real weaknesses of the old abstract political economy as a scientific theory. He devoted a great part of his originally large fortune to founding the St George's Guild, which was intended to be a kind of primitive agricultural community, where the old-world virtues should be strenuously inculcated on young and old, and where ancient and homely methods might be cherished in defiance of all modern mechanical and manufacturing processes. He also strove to promote home industries in various places. Not more remarkable than the eloquence, power, and richness of his English style are the confidence and dogmatism of his assertions, the audacity of his paradoxes, the fearlessness of his denunciations; while his earnestness, conviction, and self-denying honesty of purpose are undisputed. His influence in creating a new interest in the beauty of nature and of art in England has been profound; and although the world rejects his theories of social economy as perverse, paradoxical, and impracticable, he has done much to vivify ideals of life, and ennoble our standards of conduct.

See E. T. Cook, *Studies on Ruskin* (1890); Shepherd's *Bibliography* (5th ed. 1882); J. P. Smart, Junr., *A Ruskin Bibliography* (1890-91); W. G. Collingwood, *The Life and Work of John Ruskin* (2 vols. 1893); and various collections of Ruskin's papers, unpublished lectures (1894), and letters to a college friend (1894). A new edition of the works was appearing in 1894. The Ruskin Society was founded in 1881; the Ruskin Reading Guild, in 1887.

Russell, a great Whig house, whose origin has been traced back to Thor, through 'Olaf the sharp-eyed, king of Rerik,' Drogo, brother of Rollo, the first Duke of Normandy, and Hugh Bertrand, lord of Le Rozel, a follower of the Conqueror's. Anyhow, a John Russell was constable of Corfe Castle in Dorsetshire in 1221; and from him have sprung twenty-two generations of Russells, whose seats have been Kingston Russell, near Dorchester; Cheneys, in Bucks, near Amersham; and Woburn Abbey, in Bedfordshire. Among them, besides William Lord Russell and Earl Russell (both noticed separately below), the following may be mentioned: Sir John Russell, Speaker of the House of Commons in 1424 and 1432; John, created in 1539 Baron Russell of Cheneys, and in 1550 Earl of Bedford, who got the abbey lands of Tavistock and Woburn; Sir William Russell, who in 1594 became Lord Deputy of Ireland, and in 1603 was

created Baron Russell of Thornhaugh; Francis, fourth Earl (died 1641), the drainer of the Bedford Level; William, fifth Earl, created in 1694 Marquis of Tavistock and Duke of Bedford; Admiral Edward Russell (1651-1727), who, semi-Jacobite though he was, beat the French at La Hogue in 1692, and for his victory was made Earl of Orford; John, fourth Duke (1710-71), Lord-lieutenant of Ireland; his grandson, Lord William Russell (1767-1840), who was murdered by his valet Courvoisier; Francis, ninth Duke (1819-91); and his brother Odo (1829-84), who from 1871 was ambassador to the German court, and in 1881 was made Baron Amptill.

See J. H. Wiffen's *Historical Memoirs of the House of Russell* (1833) and Froude's *Short Studies* (4th ser. 1884).

WILLIAM RUSSELL, LORD RUSSELL, was born 29th September 1639, third son of the fifth Earl of Bedford by Lady Anne Carr, daughter of the poisoner Countess of Somerset; by the death of his brothers (one in infancy, the other in manhood) he succeeded (1678) to the courtesy title of Lord Russell. He was educated at Cambridge, and travelled on the Continent. At the Restoration he was elected M.P. for Tavistock, and was 'drawn by the court into some disorders' (debts and duelling), from which he was rescued by his marriage in 1669 with Lady Rachel Wriothesley (1636-1723), second daughter and co-heiress of the Earl of Southampton and widow of Lord Vaughan. He was a silent member till 1674, when he spoke against the doings of the Cabal, and thenceforth we find him an active adherent of the Country party. He dallied unwisely with France, but took no bribe; he shared honestly in the delusion of the Popish Plot; he presented the Duke of York as a recusant; and he carried the Exclusion Bill up to the House of Lords. The king and his brother resolved to be revenged on him and the other leaders of the Whig party; and he, Essex, and Sidney were arrested as participators in the Rye-house Plot. On 13th July 1683 he was arraigned of high-treason at the Old Bailey, and, infamous witnesses easily satisfying a packed jury, was found guilty. His father's proffer, through the Duchess of Portsmouth, of £100,000 for his life availed nothing, nor his own solemn disavowal of any idea against the king's life or any contrivance of altering the government; and on the 21st he was beheaded in Lincoln's Inn Fields. The pity of his judicial murder, the pathos of Burnet's story of his end, and the exquisite letters of his noble wife, who at his trial appeared in court as his secretary, have secured him a place in history that else he had never attained to, for he was a man of virtues, not genius, a Christian hero rather than a statesman.

See his life by Lord John Russell (1819; 4th ed. 1853); the *Letters of Lady Russell* (1773; 14th ed. 1853); and the *Lives of her by Miss Berry* (1819), Lord John Russell (1820), and Guizot (Eng. trans. 1855).

JOHN RUSSELL, EARL RUSSELL, K.G., was born on 18th August 1792, in Hertford Street, Mayfair, London, the third son of the sixth Duke of Bedford. A sickly child, he was educated at Sunbury, at Westminster (1803-4), and then at Woodnesborough vicarage, near Sandwich, until, in 1809, after a nine months' visit with Lord and Lady Holland to Spain and Portugal, he entered the university of Edinburgh. He lived there three years with Professor Playfair, studying under Dugald Stewart and Dr Thomas Brown, first exercising his powers of debate at the meetings of the Speculative Society, and paying two more visits to the Peninsula. In July 1813, while still a minor, he was returned for the family borough of Tavistock, but, though he spoke in 1815 against the renewal of war with France, foreign travel and literature for some years engrossed him rather than

politics. He made his first motion in favour of parliamentary reform in 1819, and continued to bring the subject almost annually before the House. He was also the strenuous advocate of the repeal of the Test and Corporation Acts, of Catholic Emancipation, and of other measures of civil and religious liberty. At the general election of 1830, caused by the death of George IV., the rallying cry of reform won many fresh seats for the Liberals; the 'Great Duke' was driven from office, and Earl Grey proceeded to form a ministry. Lord John became Paymaster of the Forces, without a seat in the cabinet; but he was one of the four members of the government entrusted with the task of framing the first Reform Bill, and on him devolved the great and memorable honour of proposing it. The fortunes of the measure belong to the history of the day; enough that on 4th June 1832 it received the royal assent, and the country was saved from the throes of revolution that at one time seemed imminent. In November 1834 Lord John left office with the Melbourne government, which had succeeded Grey's; in March 1835 he brought forward a motion in favour of applying the surplus revenues of the Irish Church to educational purposes; and the success of his motion caused the downfall of Peel and the return of Melbourne to power.

As Home Secretary and leader of the Lower House Lord John now attained the zenith of his career, four measures with which his name is associated being the Municipal Reform Act (1835), and the Tithes Commutation, Registration, and Marriage Acts (1836). In 1839 he exchanged the seals of the Home for those of the Colonial Office; in 1841 he proposed a fixed duty of 8s. per quarter on foreign corn and a reduction of the duties on sugar and timber. Defeated by the opposition, the Melbourne government appealed to the country without success, so once more made way for Peel. In this general election Lord John, who meanwhile had sat for Hunts, Bandon Bridge, Devon, and Stroud, boldly challenged the verdict of London on free trade by standing for the City. He was returned by the narrow majority of 9, and continued to represent the City until his elevation to the Upper House.

In November 1845 he wrote a letter from Edinburgh to his London constituents, announcing his conversion to the total and immediate repeal of the Corn Laws. This letter led to Peel's resignation; and Lord John on 11th December was commissioned by the Queen to form an administration. He failed, however, owing to Lord Grey's antipathy to Palmerston, so Peel was forced back to office, and carried the repeal. On the very day on which the bill passed the Lords the Peel ministry was defeated in the Commons on a question of Irish coercion by a coalition of Whigs and Protectionists, whereupon a Whig ministry succeeded, with Lord John for prime-minister (1846). It succeeded to a difficult position. In Ireland there was the famine, followed by a foolish rebellion, whilst at home there was Chartism and the so-called 'Papal aggression,' which evoked from Lord John an indignant protest, first in the form of a letter to the Bishop of Durham, and next in the Ecclesiastical Titles Bill of 1851. In the winter of that year Lord Palmerston's approval of the French *coup d'état* without the Queen's or Lord John Russell's knowledge procured him his dismissal from the office of Foreign Secretary; within two months he 'gave Russell his tit-for-tat,' defeating him over a militia bill (February 1852). After a short-lived Derby government, Lord Aberdeen in December formed a coalition ministry of Whigs and Peelites, with Russell for Foreign Secretary and leader in the Commons.

His inopportune Reform Bill (1854), the Crimean mismanagement, his resignation (January 1855), and his bungling that same year at the Vienna Conference, all combined to render him thoroughly unpopular; and for four years he remained out of office. But in June 1859, in the second Palmerston administration, he became Foreign Secretary, which office he held six years, having meanwhile in 1861 been created Earl Russell. He did much for the cause of Italian unity; still, non-intervention was his leading principle—e.g. during the American civil war and the Sleswick-Holstein difficulty. On Palmerston's death in 1865 Earl Russell for the second time became prime-minister, but the defeat in the following June of his new Reform Bill left no alternative but resignation. He continued, however, busy with tongue and pen till his death, which took place at his residence, Pembroke Lodge, Richmond Park, on 28th May 1878. He is buried at Cheneys. Earl Russell was twice married, and by his second wife, a daughter of the Earl of Minto, was the father of John Viscount Amberley (1842-76), who was author of the posthumous *Analysis of Religious Belief*, and whose son succeeded as second earl.

The 'Lycurgus of the Lower House,' as Sydney Smith dubbed him, this 'little great man' was honest in all his convictions, in none more so than in his belief in himself. 'He knew he was right' gives the key to both his career and his character. Of his voluminous works, a score in number, and including a tale and two tragedies, need only be mentioned his *Life of William Lord Russell* (1819), *Memoirs of the Affairs of Europe* (1824), *The Correspondence of John, fourth Duke of Bedford* (3 vols. 1842-46), and the *Memoirs of Fox and Moore*.

See his *Selections from Speeches and Despatches* (1870), his *Recollections and Suggestions* (1875), and Spencer Walpole's *Life of Lord John Russell* (2 vols. 1889).

Russell, WILLIAM CLARK, a popular nautical novelist, was born in New York, 24th February 1844, son of the vocalist Henry Russell (born c. 1810), the composer of 'Cheer, Boys, Cheer,' 'There's a Good Time Coming,' 'A Life on the Ocean Wave,' &c. He had his schooling at Winchester and in France, and went to sea at thirteen. After about eight years' service he left the sea to devote himself to the life of letters. He was employed writing for the *Newcastle Daily Chronicle* and the *London Daily Telegraph*, but from 1887 reserved his energies mainly for fiction, in which he had already scored a remarkable success with *John Holdsworth, Chief Mate* (1874), *The Wreck of the Grosvenor* (1877), *An Ocean Free Lance* (1880), *The Lady Maud* (1882), *Jack's Courtship* (1884), and *A Strange Voyage* (1885). Later novels were *The Death-ship* (1888), *Marooned* (1889), *My Shipmate Louise* (1890), *An Ocean Tragedy* (1890), and *My Danish Sweetheart* (1891). Other works are his collections of papers: *Round the Galley Fire* (1883), *In the Middle Watch* (1885), and *On the Fok'sle Head* (1884); a short *Life of Nelson* (1890), and another of Collingwood (1891).

Russell, WILLIAM HOWARD, the first and the most famous of 'special correspondents,' was born at Lilyvale in County Dublin, 28th March 1821, had his education at Trinity College, Dublin, joined the staff of the *Times* in 1843, and was called to the bar in 1850. He went out to the Crimea at the beginning of the war, and there remained till the close, writing home those famous letters which opened the eyes of Englishmen to the shameful sufferings of the soldiers during the winter siege of 1854-55, and quickly brought about the fall of the Aberdeen ministry. He next witnessed the events of the Indian Mutiny, returning to England in 1858. He established the *Army and Navy Gazette*

in 1860, and next year the opening of the civil war drew him to America, which he soon made too hot for him by a too truthful account of the Federal defeat at Bull Run. He at once returned to England; accompanied the Austrians during the war with Prussia (1866), and the Prussians during the war with France (1870-71); visited Egypt and the East (1874) and India (1877), as private secretary to the Prince of Wales; and went with Wolsley to South Africa in 1879. He contested Chelsea without success in the Conservative interest in 1869. Most of his letters were collected into volumes, which had great success in their day; three books that may be named are *The Adventures of Doctor Brady* (1868); a novel, *Hesperothen, or Notes from the West* (1882); and *A Visit to Chile and the Nitrate Fields of Tarapaca* (1890). Besides holding many medals and decorations, he is a Knight of the Iron Cross, and a Commander of the Legion of Honour.

Russia, except the British empire the largest government on the globe, extending over eastern Europe and northern and central Asia. It is bounded on the N. by the Arctic Ocean; on the E. by the North Pacific Ocean and Chinese empire; on the W. by Sweden, the Baltic Sea, Prussia, Austria, and Roumania; and on the S. by the Black Sea, Asiatic Turkey, Persia, Afghanistan, East Turkestan, and the Chinese empire. Its extreme limits are 38° 30' and 78° N. lat. and 17° 19' and 190° E. long. This territory, which covers an area more than twice as large as the entire area of Europe, and embraces one sixth of the land-surface of the globe, has a population estimated at more than 115,000,000, the annual increase of which usually exceeds 1,500,000. The Russian empire consists of several well-defined parts—viz. European Russia, which embraces a little less than one-fourth of the whole, but includes nearly three-fourths of its population; Finland; Poland; Caucasus; Siberia; Turkestan; and the Transcaspian region. Two central Asian states, Khiva and Bokhara (112,000 sq. m., 3,200,000 inhabitants), are vassal states of Russia. The Russian dominions in America (Alaska) were sold to the United States in 1867 for \$7,200,000.

The territory of the empire, however different its separate parts as regards latitude and climate, is more homogeneous than it appears at the first sight. It belongs to the great orographical division of Eurasia, which embodies both the plains of European Russia and the lowlands and plains that extend in the north of the two great plateaus of Asia—the high plateau of east Asia and the western plateau of Persia and Armenia (see ASIA, Vol. I. p. 486). However, the Russians are rapidly passing the limits of the lowlands. They crossed the narrow northern extremity of the plateau, and established themselves on the coasts of the Sea of Okhotsk. In 1855-59 they spread over the Pacific slope of the plateau, down the Amur and up the Usuri. The high steppes of Mongolia fell under their influence; in Turkestan their military outposts are now stationed in the Pamirs; Armenia has been partly absorbed; and in 1898 Manchuria (q.v.) became practically Russian, and was being connected with the great Siberian railway. The extent of Russian Asia (not including Manchuria) as compared with Chinese and British territory is shown on the map of Asia, Vol. I. p. 494.

A census of the empire was attempted in 1897, and gave a grand total of 128,931,827, of whom 94,215,415 were in European Russia, 9,455,943 in Poland, 9,248,695 in Caucasus, 5,727,090 in Siberia, 7,721,684 in Central Asia. The following are the figures calculated for 1890-95:

Governments and Territories.	Area in sq. miles.	Population.	Density of pop. per sq. m.
EUROPEAN RUSSIA—			
Archangelsk.....	831,505	840,251	1
Astrakhan.....	91,327	932,539	10
Bessarabia.....	17,619	1,588,329	90
Courland.....	10,535	676,582	64
Don, Region of.....	61,886	1,896,113	80
Ekaterinoslav.....	26,148	1,874,162	71
Esthonia.....	7,818	392,738	50
Grodno.....	14,931	1,354,425	90
Kaluga.....	11,942	1,190,882	100
Kazan.....	24,601	2,140,702	87
Kieff.....	19,691	2,917,997	148
Kostroma.....	32,702	1,354,162	41
Kovno.....	15,692	1,532,747	97
Kursk.....	17,937	2,666,573	148
Kharkoff.....	21,041	2,322,039	110
Kherson.....	27,523	2,026,853	73
Livonia.....	18,158	1,229,468	67
Minsk.....	85,293	1,680,615	47
Moghilev.....	18,551	1,294,116	69
Moscow.....	12,859	2,210,791	171
Nijni-Novgorod.....	19,797	1,513,318	76
Novgorod.....	47,236	1,213,058	25
Olonez.....	57,439	841,568	5
Orël.....	18,042	2,021,239	112
Orenburg.....	73,816	1,289,358	17
Penza.....	14,997	1,522,537	101
Perm.....	123,211	2,713,967	21
Podolia.....	16,224	2,423,755	149
Poltava.....	19,265	2,794,739	145
Pskov.....	17,069	965,355	56
Ryazan.....	16,255	1,843,345	113
St Petersburg.....	20,790	1,680,273	80
Samara.....	58,321	2,614,405	43
Saratoff.....	82,624	2,311,220	70
Sibirsk.....	19,110	1,579,847	82
Smolensk.....	21,633	1,339,444	61
Tamboff.....	25,710	2,730,145	106
Taurida.....	24,539	1,096,870	44
Tchernigoff.....	20,238	2,109,983	104
Tula.....	11,954	1,445,600	120
Tver.....	25,225	1,781,861	70
Ufa.....	47,122	2,018,356	41
Vilna.....	16,421	1,304,788	79
Vitebsk.....	15,440	1,275,954	78
Vladimir.....	18,854	1,403,172	74
Volhynia.....	27,743	2,254,897	71
Vologda.....	155,498	1,239,754	7
Voronej.....	25,443	2,588,933	101
Yaroslavl.....	59,117	2,914,344	49
Yaroslavl.....	19,751	1,126,891	81
Sea of Azov.....	14,478	—	—
	1,902,092	85,464,140	45
POLAND—			
Kalisz.....	4,392	837,317	190
Kielce.....	3,897	692,328	177
Lomza.....	4,667	608,683	130
Lublin.....	6,499	979,700	150
Piotrkow.....	4,729	1,061,282	230
Plock.....	4,209	600,662	143
Radom.....	4,769	716,164	150
Siedlee.....	5,535	671,698	121
Suwalki.....	4,846	656,982	135
Warsaw.....	5,623	1,465,131	260
	49,157	8,319,797	169
FINLAND—			
Abo-Björneborg.....	9,385	880,501	40
Kuopio.....	16,469	277,635	16
Nyland.....	4,596	227,389	49
St Michel.....	8,819	175,110	19
Tavastehus.....	8,334	245,690	29
Uleåborg.....	68,971	234,015	3
Viborg.....	16,627	330,823	19
Vasa.....	16,084	399,750	24
	144,255	2,270,912	15
CAUCASUS—			
<i>Northern Caucasus—</i>			
Kuban.....	36,439	1,286,622	35
Stavropol.....	23,397	667,511	28
Terek.....	26,822	719,468	26
<i>Transcaucasia—</i>			
Baku.....	15,177	744,030	49
Daghestan.....	11,492	597,356	51
Elizabethpol.....	17,041	753,395	44
Erivan.....	10,745	677,491	63
Kars.....	7,200	237,114	32
Kutais.....	14,084	955,000	67
Tiflis.....	17,223	819,264	18
	182,457	7,458,151	40

Governments and Territories.	Area in sq. miles.	Population.	Density of pop. per sq. m.
KIRGHIZ STEPPES—			
Akmolinsk	229,609	500,180	2
Semipalatinsk	184,681	576,578	3
Turgai	176,219	364,600	2
Uralsk	189,168	559,552	3
Lake Aral	26,166	—	—
	755,793	2,000,970	3
TURKESSTAN—			
Samarcand	26,627	680,135	25
Ferghana	35,654	775,600	22
Semirechenak	152,280	671,878	4
Syr-Daria	194,853	1,214,300	6
	409,414	3,341,913	8
TRANS-CASPIAN TER.—			
Caspian Sea	214,237	301,476	—
	169,381	—	—
	883,618	301,476	1
SIBERIA—			
<i>Western Siberia—</i>			
Tobolsk	539,659	1,375,455	2
Tomsk	331,159	1,299,729	7
<i>Eastern Siberia—</i>			
Irkutsk	287,061	421,187	1
Transbaikalia	236,868	565,477	2
Yakutsk	1,533,397	255,671	0.1
Yeniseisk	987,186	458,572	0.4
<i>Amur Region—</i>			
Amur	172,850	87,705	0.5
Maritime province	(?) 715,980	120,000	0.2
Sakhalin	29,336	14,645	0.5
	4,833,496	4,598,441	9
Total—			
Asiatic Dominions ..	6,564,778	17,700,951	3
Russia in Europe ...	2,095,504	98,047,849	46
Grand Total—			
Russian Empire	8,660,282	118,748,800	13

Seaboard, Islands.—Until the end of the 17th century Russia's seaboard was limited to the Arctic Ocean, and she had to wage a long series of wars before she secured a firm footing on the Baltic and the Black Sea. The latter, however, still remains an inland sea, the entrance to which is in the hands of a foreign power. The Arctic Ocean, which offers excellent fishing grounds in its western part, makes a deep indentation on the north coast of Russia—viz. the White Sea (q.v.); but its gulfs, Kandalaksha, Onega, and Dwina, are ice-bound for nine months every year. The only port of any moment, Archangel, has now lost its former importance. Farther east, Tchesskaya and Petchora bays are surrounded by frozen deserts. The Kara Sea, between the crescent-shaped island of Novaya Zemlya (Nova Zembla) and the coast of Siberia, is navigable for a few weeks only every year (see SIBERIA). The islands of Kolgueff, Vagatch, Novaya Zemlya, and the islands of Siberia—New Siberia, Medvyezhi, and others—are uninhabited. As to the Behring Sea and the Sea of Okhotsk, which contain good fishing and hunting grounds, their coasts are most inhospitable. The same is true of that part of the Japanese Sea which belongs to Russia. Its only great gulf, Peter the Great's, has in Vladivostok one of the finest roadsteads in the world; but this gulf is separated from the interior by wide tracts of uninhabited marshes and forests. The Baltic Sea, with the Gulfs of Bothnia, Finland, and Riga, is the chief sea of Russia; but it nowhere touches purely Russian territory, its coasts being peopled by Finns, Letts, Estonians, and Germans. Nevertheless, four out of the five chief ports of Russia—St Petersburg, Revel, Libau, and Riga—are situated on the Baltic Sea. Three of them are frozen for from four to five months every year; and Libau

is the only one which has its roadsteads open nearly all the year round. The chief islands of the Baltic are the Aland archipelago, belonging to Finland; Dagö, Oesel, Mohn, and Worms at the entrance of the Gulf of Riga; Hochland and Kotlin (with the fortress of Cronstadt) in the Gulf of Finland.

The Black Sea acquires more and more importance every year. The fertile steppes of its littoral are being rapidly settled, and the centre of gravity of Russia's population is gradually shifting south. The Black Sea suffers, however, from a lack of good ports. Its great gulf, the Sea of Azov (ports Taganrog and Rostoff), is very shallow; the fine ports of the Crimea are too remote from the mainland; and the seaboard of Northern Caucasia is separated from the interior by a high chain of mountains. Odessa is the chief port of this sea; and it has no rival in Russia except St Petersburg. Nikolaieff is the principal naval arsenal; and Sebastopol remains a naval station. Batoum, the chief port of Transcaucasia, is of great importance for the export of petroleum.—The Caspian Sea, which receives the chief river of European Russia—the Volga—is an excellent medium of communication between the central Asian dominions of the empire and the Caucasus, as also for trade with Persia (to which the south coast belongs); but it has no outlet to the ocean, nor is there any probability of connecting it advantageously by canal with the Black Sea, because its level is 70 feet below the level of the ocean. The fisheries in the Caspian supply Russia with considerable quantities of fish.

Colonies.—Russia has no colonies properly so called. Its possessions in Asia are mere reserve-grounds for surplus population. Russian immigrants are already the prevailing element in the population of Siberia and Northern Caucasia, numbering about 4,500,000 against less than 700,000 natives in Siberia, and about 2,000,000 in Caucasia.

Orography.—The geographical features of Finland, Poland, Caucasus, Siberia, and Turkestan being dealt with under those respective headings, the following remarks relate only to European Russia. The leading feature in its physical structure is a broad, flat swelling about 700 miles wide, with an average height of 800 feet, which crosses it from south-west to north-east and connects the elevated plains of middle Europe with the Urals. A belt of lowlands stretching from East Prussia to the White Sea fringes this central plateau on the north-west, separating it from the hilly tracts of Finland; while the plains of Bessarabia, Kherson, the Sea of Azov, and the lower Volga limit it on the south-east. The highest parts of the central plateau, hardly attaining 1000 to 1100 feet above the sea, lie along its north-western border—viz. the Kielec mountains of Poland, the plateaus of Grodno and Minsk, the Valdai Hills, and the hilly tracts of the Sukhona and Vytchegda (upper Dwina). In middle Russia the same altitude is attained by the flat eminences of the plateau about Kursk, in the hills on the right bank of the Volga, and in the spurs of the Carpathians. In all these places the country assumes a hilly aspect on account of the deep ravines which intersect it. The central plateau is, however, diversified by three depressions. One of these stretches south-east to north-west up the broad valley of the Dneiper and thence to the Vistula; another follows the Don and joins the valley of the Oka; and the third extends from the north shore of the Caspian along the left bank of the Volga to the bend it makes at Samara. During the Postglacial period an elongated gulf of the Caspian Sea extended in that direction up the valleys of the Volga and the Kama as far as 55° N. lat. A fourth depression, about Nijni-Novgorod,



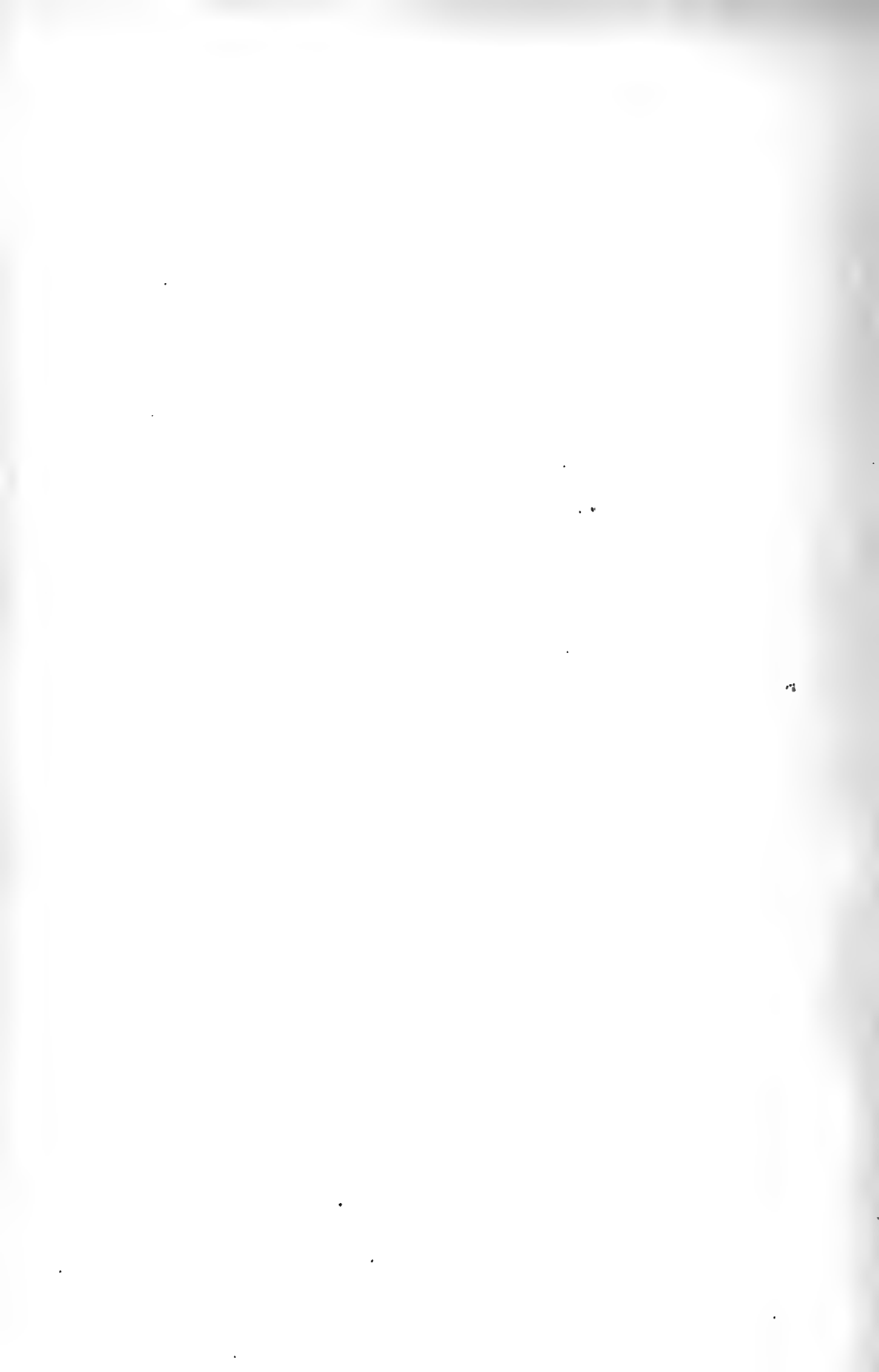

bears traces of a great lake which was filled up during the same epoch.

The Urals, which separate the lowlands of European Russia from those of Siberia, are not the narrow chain of mountains running north and south which they appear to be on many maps. In the south they consist of a series of parallel ridges running south-west to north-east, their chief summits reaching 4680 feet in Ireme¹, and 3260 in Taganai. Farther north, up to the latitude of 61°, they must be considered as a continuation of the central plateau, bordered by several low ridges (north-west to south-east) which become more distinctly apparent between the Denejkin-kameñ (4950 feet) and the Toll-poss (5115 feet). They connect with a ridge that runs north-east into the Yalmal peninsula. And finally, in the extreme north, a low ridge, the Pai-kho, crosses over into the island of Vaigatch and the southern part of Novaya Zemlya. Thus the Urals exhibit the same great lines of upheaval—in a south-western and a north-eastern direction—which are characteristic features in the orographical structure of the great continent of Europe and Asia.

Rivers.—The chief rivers of Russia take their origins along the north-western border of the plateau, and some of them flow, broadly speaking, north-westwards, while the others, though describing great curves over the surface of the plateau, take a general direction towards the south-east. The Niemen, the Dwina, the Lovat (continued by the Volkhoff and the Neva), and the two chief streams that reach the White Sea, the Onega and the North Dwina, are in the first case; while the Dnieper, the Don, and the Volga belong to the second category. The Dniester and the Pruth on the Roumanian frontier are the only rivers of Russia that rise on foreign territory; the Vistula has its mouth in Prussia.—The tributaries of distant seas thus rising amidst the same marshes, on the same level of the plateau, and flowing in opposite directions, boats that have been brought up one river can easily be carried across a flat and marshy water-parting (*vólok*) into the basin of another river and be floated towards another sea. The advantages that can be derived from such a disposition of the rivers are evident at a glance. At an early epoch of history it favoured the progress of the Russians from their cradle in Novgorod and Kieff towards the east; and later on it facilitated intercourse between distant parts of the territory upon which they had settled, and so maintained the unity of the separate parts. The whole making of Russia was closely dependent upon the courses of its rivers. At the present time vast quantities of corn, timber, and other heavy or bulky goods are shipped up and down the rivers—the total length of the navigable river-net reaching 33,500 miles. Several of them have been improved for navigation and connected by canals (total length, 453 miles), and many more could be, and certainly will be, improved. By means of three lines of canals and canalised rivers, which connect the upper tributaries of the Volga with the streams that flow into lakes Onega and Ladoga, the real mouth of the chief artery of Russia, the Volga, has been transferred from the Caspian to the Gulf of Finland—St Petersburg being the chief port of the Volga basin. The upper Volga and the upper Kama are also connected by canals with the North Dwina, and the Dnieper with the Düna, the Nieman, and the Vistula. Yet navigable rivers are unequally distributed over the territory; and the rivers of Russia, though exceeding in length those of western Europe, discharge a comparatively smaller volume of water. The rainfall all over Russia is small, and as part of it falls in the shape of snow, which is rapidly thawed in the spring, the rivers

are flooded at that season and in early summer, and they grow shallow by the autumn. It has been estimated that one-third of the total volume of water discharged during the whole year by the rivers is carried during the spring and early summer floods. The amount of water discharged by the rivers also varies very much from year to year—a river which is navigable one year being often reduced next year to a small streamlet. During the winter navigation of course ceases.

Climate.—All over European Russia, with the exception of the Baltic Provinces, the south of the Crimea, and a narrow strip of land on the Black Sea, the climate is decidedly continental. A very cold winter, followed by a spring which sets in rapidly, and has therefore a charm hardly known to western Europe; a hot summer, the duration of which varies with the latitude; an autumn that is cooler than the corresponding months of advanced spring; early frosts; and a small rainfall, chiefly during the summer and the autumn—such are the characteristics of the climate of Russia. The winter is cold everywhere. All over Russia the average temperature of January is below the freezing-point, and it only varies between 22° F. in the west and 5° to 7° in the east. To find in Russia a winter as mild as at Königsberg (28° being the average of the three winter months) it is necessary to go as far south as Odessa. As for the southern Urals, they have a winter as cold as it is at Archangel. Even in south-west Russia the average temperature of March is a couple of degrees below the freezing-point, while in the south-east it falls as low as 16° and 20°. All the rivers are frozen over in the first part of December, and they remain under ice for an average of from 100 days in the south to 150, and even 167, days in the north. At Astrakhan ice remains on the Volga for 90 days every year, while on the Vistula at Warsaw it lasts only 77 days. On the other hand, in summer the temperature is so high all over Russia that it is only beyond the 60th degree of latitude that the average temperature of July is less than 62°. In middle Russia it rises to between 64° and 70°, and it reaches 78° at Astrakhan. The yearly temperature averages only 54° in the south and 32° in the north. The annual rainfall is very low as a rule. It averages from 14 inches in the east to 22 inches and occasionally 28 inches in the west. The moderating influence of the western winds is felt to some extent all over the country. But their tempering influence decreases very rapidly as they make their way across the cold, dry plains. The strength of the wind, especially in winter, is greater, as a rule, than in western Europe; by the end of winter blizzards often bury the railways under snow, and are very destructive to cattle.

Flora and Fauna.—With regard to its flora Russia may be subdivided into four regions: (a) The *tundras* of the Arctic littoral, which are devoid of tree vegetation. They are chiefly covered with mosses, lichens, and shrubs—the dwarf birch, the dwarf willow, and so forth, with the addition of a few herbaceous plants in the dryer and more sheltered places, wherever sufficient humus has accumulated; the whole flora of the *tundras* does not embrace more than 280 flowering plants. (b) The *forest-region*, which covers the whole of northern and middle Russia, from the *tundras* to the Steppes, and must be subdivided into two parts, the forest-region proper and the intermediate region of prairies dotted with forests. The forest-region has again two distinct parts—that of the coniferous forests, which cover nearly the whole of northern Russia beyond the upper and middle Volga, and the oak region. The forests of the latter class consist of various deciduous trees (birch, aspen, oak, &c., as well as the ash and the hornbeam farther

south), and appear as islands in the midst of corn-fields and rich meadows, adorned with a great variety of flowers. The numbers of species of flowering plants, all belonging to the middle European flora, varies from 800 in the north to 1600 in the south-west. The beech, so characteristic of the western European flora, does not in Russia extend farther than the frontiers of Poland (it reappears in the south-west and in the Crimea); and in the north-east the botanist finds an admixture of species of Siberian extraction. A line drawn from Kieff to the sources of the Ural would separate roughly the forest-region from an intermediate region—the *Ante-Steppe*—in which the forests and the Steppes struggle with alternating success for every square mile of land; and another line, almost parallel to the above, drawn from Ekaterinoslav to Uralsk, may be taken as the limit of (c) the *Steppes*. These are immense plains covered with grass, but devoid of forests, very much like the *prairies* of America and the *pushtas* of Hungary. A great variety of plants characteristic of the Steppes are found in this belt in addition to the species that occur in middle Russia; while towards the Caspian a great number of species characteristic of the Aral-Caspian deserts penetrate into European Russia. Finally, (d) the flora of the Mediterranean region occupies a narrow strip along the southern coast of the Crimea. No less than 1650 species of flowering plants, many of them quite unknown in the continental part of Russia, have been described from that narrow strip of land.—The fauna of European Russia is very much like that of middle Europe, the chief difference being the occurrence of a few species, now extinct in Europe but still inhabiting Asia, and in the south-east there are several species characteristic of central Asia. Wolves and bears are common in the north. The reindeer is still met with in one or two governments; the wild boar and the bison are each limited to one district; the elk, the lynx, the glutton, the beaver, once common, are now very scarce.

Baltic Provinces.—The chief physical features of Russia, briefly indicated under the preceding headings, give a general idea of the country; but its different parts differ so widely from one another that they must be dealt with separately. Accordingly we review, first, the territory north-west of the central plateau, then the plateau itself, and finally the lowlands to the south of it, proceeding in each case from west to east.

The Baltic region, comprising Courland, Livonia, West Kovno, and part of Esthonia, is an undulating plain 300 to 800 feet above the sea, cut up by ravines and taking a decidedly hilly aspect in what is known as 'Wendish Switzerland.' A few flat summits attain more than 1000 feet above sea-level. Owing to the influence of the sea, this region enjoys a milder climate than the rest of Russia, and has maintained its excellent forests, chiefly of oak. The soil is of moderate fertility, and is well cultivated on the estates of the German landlords; but the peasants, who belong to conquered races (Esthonia, Letts, and Cours, akin to the Finns), and have no land of their own, live in a condition of deplorable poverty. This region is watered by the Dwina, and has the important ports of Riga, Libau, and Reval.

The Lake-region.—A depression, the surface of which is less than 300 feet above sea-level, stretches between the central plateau and the hills of Finland and Olonetz, from the Gulf of Riga to Lake Onega, and is continued over a low watershed towards the lowlands of Archangel. It has but recently emerged from the Postglacial sea, and is dotted with marshes and numberless lakes, of which Peipus, Ilmeñ, Ladoga, Onega, and Vodlo

are the largest. Low, flat ridges, partly carved out of the rocks by the ice-sheet, and partly of morainic origin, intersect the country; the soil is unferile, and mostly too wet for the successful prosecution of either agriculture or cattle-breeding. The marshy forests are mostly thickets of thin firs, birches, aspens, &c., of poor aspect. Numberless rivers connect the lakes with one another, or with the Gulf of Finland. It is in the lake-region, at the head of the Gulf of Finland, that Russia has its capital, St Petersburg, surrounded by nearly uninhabitable marshy plains.

The plains of the lower Dwina and Mezeñ, which fringe the White Sea and the Arctic Ocean, bear the same character, the vegetation being, of course, even poorer than in the lake-region; while the coasts of the ocean are fringed by a belt of treeless *tundras*. To the north-west of the lake-region lies the peninsula of Kola, a marshy tableland, inhabited by only a few Lapps. And in the far north-east, between the Timansky ridge and the Urals, there is an immense territory—the *Petchora region*—covered with *tundras* in the north, and with impenetrable forests in the south; it is thinly inhabited by some 10,000 Russians settled along the courses of the rivers, and by Samoyedes and Zyrian hunters in the forests.

The *central plateau* contains the most populous agricultural and industrial parts of European Russia. Its physical aspects vary, however, a good deal in the different parts.

The *Lithuanian provinces* of Kovno, Vilna, and part of Grodno and Vitebsk, which occupy the north-west, are drained by the Niemen and the upper Dwina, and embrace the eastern continuation of the broad swelling, 600 to 700 feet high, which separates Poland from East Prussia, and is known as the 'Baltic Lake-region.' It is dotted with numberless small lakes and ponds, and has immense forests, which, however, are being rapidly cleared. One, the Byelovezh forest (850 sq. m.), still preserves its primitive aspect, and shelters a herd of bison, formerly common throughout Europe, but now only found in Lithuania and the Caucasus. The population consists chiefly of Lithuanians and Letts, mixed with White Russians in the east, and with Jews and Tartars. The Poles are the principal owners of land; they also constitute the bulk of the artisan population in the towns. On the whole, the region is very poor, and the condition of the peasantry is deplorable.

White Russia.—The territory watered by the upper Dnieper and its right-hand tributaries, comprising the governments of Moghileff, Minsk, and southern Vitebsk, as well as parts of Grodno, Vilna, and Smolensk, is one of the poorest regions of Russia. About one-tenth of the total area is covered with marshes; and the soil that is not under water consists chiefly of peat-bogs, hard boulder-clay, and sands. The depression between the Pripet and the Berezina called *Polyesie* ('the woods'), also spoken of as the Rokitno swamp, is for hundreds of miles an almost uninterrupted marshy forest, flooded with water in the spring. White Russians are the predominant element in the population of the country; having to live on a most unproductive soil, and ruined as they were by Polish and Russian landowners, they are in extreme poverty, and great numbers of them wander over Russia in search of labour, especially in navy's work.

Little Russia, or Ukraine.—Little Russia, comprising the governments of Tchernigoff, Kieff, Poltava, and part of Kharkoff, as well as Volhynia and Podolia on the spurs of the Carpathians, belongs to the richest and most populous parts of Russia. The soil is mostly a rich black earth, and assumes farther south the aspect of fine grassy steppes, or prairies, yielding rich crops

of wheat. The climate of this region is relatively mild, especially in Volhynia, and gardening is extensively carried on. Cattle-breeding and especially sheep-breeding are prosecuted on a grand scale on the prairies. In the north of the territory beet is much cultivated for sugar. Kieff is one of the chief industrial centres of Russia, and woollen cloth mills are rapidly spreading in Podolia. The population is chiefly Little Russian, with a considerable number of Moldavians in Podolia.

Middle Russia.—The provinces of Tver, Moscow, Vladimir, Smolensk, Orel, Tula, Kaluga, Kursk, Ryazan, Tamboff, Penza, part of Voronezh, southern Yaroslavl, and Simbirsk are comprised under the general name of Middle Russia. They contain a population of more than 25,000,000 Great Russians, the average density being over 100 inhabitants per square mile. Except on its outskirts, this region presents everywhere the same aspects, wide undulating plains covered with cornfields and dotted with small deciduous forests. The soil is of very moderate fertility in the north, where it chiefly consists of boulder-clay; but towards the south it becomes very fertile in the black earth belt. The population is thoroughly Great Russian, with but a small admixture of White Russians and Little Russians in the west, and of Tartars and Finnish stocks, mostly Russianised, towards the east. They live in large villages, pursue agriculture in summer, and carry on a great variety of domestic trades in the winter. Moscow and the surrounding governments are the busiest industrial region of Russia.

Upper Volga and Kama.—Farther north-east the country is more elevated, but less effectively drained; and vast forests stretch from the upper Volga to the Urals. The governments of Kostroma, Vologda, and Vyatka, together with those parts of Nijni-Novgorod and Kazan which lie on the left bank of the Volga, belong to this domain. Its population is thin—5 to 50 inhabitants per square mile. The villages and towns are separated by wide uninhabited tracts, and intercommunication is difficult, the Kama and its tributaries being the principal highways to middle Russia. The governments of Perm (which includes the mining districts on the Asiatic slope of the Urals) and North Ufa are the chief centres for the iron industry, and supply both middle Russia and Siberia with iron and iron goods.

The Middle Volga Governments of Simbirsk, Saratoff, and Samara, and the South Ural governments of South Ufa and Orenburg, belong to a great extent to the steppe-region of South Russia. The forests, which are still extensive in Kazan and in the hilly tracts of the Urals, gradually thin away, till towards the south the territory becomes a wide prairie, which often suffers from want of rain. The dry, hot winds of central Asia make their influence felt. The population, mostly Great Russian, contains a large percentage of Turkish and Finnish race. Its density is 70 to 82 inhabitants per square mile on the right hand of the Volga; and a stream of Russian emigration is rapidly extending eastwards into the fertile lands of the Bashkirs.

The Steppe-region occupies a belt more than 200 miles wide along the littoral of the Black Sea and the Sea of Azov, and extends eastwards through the region of the lower Volga and Ural till it meets the steppes of central Asia. As far as the eye can reach there are gently undulating plains, clothed with rich grass, and entirely destitute of trees; yet in the bottoms of the deep ravines, concealed by the undulations of the surface of the steppes, there grow a variety of trees and shrubs, as willows, wild cherries, wild apricots, and so forth. The whole is coated with a thick layer

of fertile 'black earth.' For many centuries the Russians coveted these fertile grounds, but it was not until the 18th century that they actually took possession of them; they have since rapidly covered them with their villages. But in order to people Bessarabia without depriving the Russian land-owners of their serfs, several races of foreigners, as Moldavians, Wallachians (Vlachs), Servians, Greeks, Germans, and even Scotsmen, were freely invited to settle there. The population of the steppe-region exceeds 13,000,000, and its density, from 90 to 71 per square mile in the west and 30 in the east, is rapidly increasing.

The same steppe-land extends into the peninsula of the *Crimea*, but there the soil is no longer black earth, but a clay impregnated with salt. Its extreme dryness prevents it from being utilised for agriculture. A narrow ridge of mountains, the Yaila, reaching 4000 to 5100 feet in their highest summits, rises on the south-east coast of the Crimea. Its southern slope is the most beautiful corner of Russia, owing to its Mediterranean climate and Mediterranean flora. Farther east the *Caspian Steppes*, in respect both of their physical features and of their population, form an intermediate link between Europe and Asia. They only emerged from the sea in quite recent geological times, and their surface, perfectly flat, still lies below sea-level for a distance of more than 150 miles from the shores of the Caspian. The small streams which cross them mostly dry up through evaporation, and seldom reach the sea. The Volga and the Ural divide into numerous branches before entering the Caspian Sea, and afford the richest fishing grounds in the world. Numerous salt lakes, whence Russia gets her supply of salt, are scattered over the steppes. The population consists to a great extent of Tartars, Kirghizes, and Kalmucks. Cattle-breeding is the industry mostly followed; and fishing is a valuable source of income.

Ethnography.—The population of the empire embraces a great variety of nationalities; but the Russians, comprising the Velikorusses or Great Russians, the Malorusses or Little Russians, and the Byelorusses or White Russians, are by a long way the predominant race. They number no less than 77,000,000, of whom 70,000,000 inhabit European Russia. None of the three is, of course, a pure race. The Great Russians, who invaded a territory occupied by Finnish tribes, ended by assimilating them. The Little Russians underwent a mixture with Turkish tribes, and the White Russians with Lithuanians. However, the Russians gave origin to no half-breed races; they mostly 'Russianised' the natives whom they came in contact with. The Great Russians inhabit middle Russia in a compact mass of over 35,000,000, and even in east and north Russia they constitute from two-thirds to three-fourths of the population. The Little Russians, nearly 15,000,000 in all, are settled in a solid body in Little Russia, which contains but a slight admixture of other races—chiefly in the borderlands—besides about 12 per cent. of Jews, and from 3 to 6 per cent. of Poles. The White Russians, who number about 5,000,000, also dwell in a compact mass in the west, but they are more mixed with Poles, Jews, and Little Russians. The Poles number about 5,000,000 in Poland (q. v.), and about 1,000,000 in the western governments of Russia. Some 120,000 other Slavs—Servians, Bulgarians, and Bohemians—exist in small colonies in Bessarabia and Kherson. The Letts and the Lithuanians number about 2,600,000 in Russia and 400,000 in Poland, but the latter are rapidly losing their national characteristics. Armenians, Kurds, and Persians and other Iranians number nearly 1,300,000, and live chiefly in Caucasia. The Cau-

casus (q.v.), inhabited by a great variety of races and tribes, has a population estimated at 7,500,000. Jews are very numerous in the towns of west Russia (about 2,500,000) and Poland (1,000,000). Contrary to the current opinion that all Jews are merchants or money-lenders, it is the fact that nearly three-fourths of the Russian Jews are artisans or factory-workers, while the 30,000 Jews settled on the land in Bessarabia and Khereson have proved themselves good agriculturists. The Finnish stems include the Finns and the Karelians (1,850,000 in Finland and 350,000 in European Russia); the Esthonians, the people of Livonia, and other Western Finns in the Baltic Provinces (about 1,000,000); the Lapps and the Samoyedes in the far north; and the Volga Finns and the Ugrians (1,750,000 in European Russia and 50,000 in Siberia). The Eastern Finns are being rapidly absorbed by the Russians; but the Western Finns still maintain and warmly foster their nationality. The Turko-Tartars—i.e. Tartars, Bashkirs, Kirghizes, &c.—are mere feeble remnants of the tribes who once conquered Russia. They number, however, no less than 3,500,000 in European Russia, 4,500,000 in central Asia, 1,500,000 in the Caucasus, and 350,000 (Tartars and Yakuts) in Siberia. The Mongol race is represented by some 480,000 Kalmucks in Russia and central Asia, as well as by 250,000 Buriats in Siberia; while the Manchurian tribes of the Tunguses, Golds, &c., and the Hyperboreans number respectively about 50,000 and 12,000 in Siberia (q.v.). Of west Europeans the Germans (about 1,000,000, out of whom 500,000 in Poland) are the most numerous. They have prosperous colonies in south Russia; and in the chief towns there are numbers of Germans, artisans and merchants. The Swedes number about 300,000 in Finland. There are, besides, nearly 900,000 Roumanians in south-west Russia, and about 1,000,000 Europeans of various nationalities scattered throughout the empire.

Density and Increase of Population.—By the census of 1897 it appears that the average density of population in European Russia, exclusive of Poland, is only 51 per square mile; Podolia having as many as 187 and Kieff 181, while Vologda has but 9, Olonetz 7, and Archangel province (as in Siberia) 1 per mile. The average in Poland is 193, rising to 286 in Warsaw province, and 297 in Piotrkow. In Europe, owing to the prevalence of early marriages among the peasants, the birth-rate is very high—from 35 to 63 in the thousand, the average having been of late about 47. But the death-rate is also very high—viz. about 33. It is only in the Baltic and western provinces, which have also a lower birth-rate, that it falls to 20 and 18 in the thousand; in the east, however, it goes up to 45, and occasionally is even more. The mortality is terrible among the children of the peasantry; on an average more than two-fifths die before reaching five years of age. In spite of this the surplus of births over deaths varies between 1,600,000 and 2,000,000 throughout the empire, and between 1,300,000 and 1,660,000 in European Russia. The population is thus rapidly increasing; and while it was 74,000,000 in 1859, it exceeded 115,000,000 in 1891. The Russians proper emigrate but little from the empire; but great numbers of European Russians emigrate every year to the Asiatic dominions.

Religion.—The great bulk of the Russians—excepting a few White Russians professing the Union—belong to the Græco-Russian Church, officially styled the Orthodox-Catholic Church, or to one of its numberless sects of dissenters (*raskol*). The Poles and most of the Lithuanians are Roman Catholics (8,500,000); while the Finns, the

Esthonians, and other Western Finns, the Swedes, and the Germans are Protestants (about 4,000,000). Nearly all the Jews obey the injunctions of the Talmud, with the exception of a few Karaites in the Crimea and west Russia. Islam has a large number of followers—all the Turco-Tartars, Bashkirs, and Kirghizes. Buddhism has its followers in the Kalmucks and the Buriats. Shamanism is the religion of most of the natives of Siberia, as well as of the nominally Christian Mordvins, Votyaks, Tchuvashes, and the nominally Moslem Mescheryaks, and (partly) the Kirghizes. The Voguls, the Samoyedes, and other inhabitants of the far north are fetich worshippers. For the relations of the Russian Church with the rest of the Orthodox Eastern Church, see GREEK CHURCH. All these religions are recognised by the government, and the Græco-Russian, Roman Catholic, Lutheran, Moslem, Jewish, and Buddhist clergy are maintained or protected by the state. As a rule religious intolerance is not a part of the national character. The government, however, from time to time proceeds to 'Russianise' this or the other part of the empire, and, without openly persecuting this or that religion, imposes all sorts of vexatious measures upon its followers. One or two nonconformist sects are the only ones who are openly persecuted. The making of proselytes from among the adherents of the Greek Church is severely punished.

The Dissenters.—A most important part is played in the popular life of Russia by the numerous sects of dissenters, or *raskolniki*, to which nearly one-third, or more, of the so-called Orthodox Russians belong. New sects arise every year, and even among the Little Russians, who used so piously to preserve their traditional religion in the face of the Catholic propaganda, a nonconformist movement has sprung up of late and spread with wonderful rapidity under the name of the 'Stunda.'

The Russian dissenters may be classed under three divisions, all equally numerous: the 'Popovtsy' (who have priests), the 'Bezpopovtsy' (who have none), and the 'Dukhovnyie Khristiane' (spiritualist Christians). The first named object to the revision of the sacred books which was accomplished under the patriarch Nikon (see *History*, below), as well as to the hierarchy of the Russian Church. They are hostile to all kinds of 'novelties,' maintain the patriarchal style of family arrangement, and get their priests either from Austria or from priests who have left the Orthodox Græco-Russian Church. A branch of the Popovtsy, the 'Yedinovyertsy,' recognise Russian priests on condition of their keeping to the unrevised books.

The Bezpopovtsy repudiate the Orthodox ritual and the sacraments, and have no priests. Any man or woman may conduct divine service if recognised by the community. The state is considered by them as an entire invention of the Antichrist, and the tsar is Antichrist himself. Yet very few amongst them really break off all connection with the state, and lead a life of outcasts, as the 'Stranniki' (the Errants) do.

The 'Spiritualists' comprise very many sects, all more or less imbued with either Protestant or rationalist teachings, as well as with communist tendencies more or less carried into practice. The chief of them are the 'Dukhobortsy' (warriors of the spirit), the 'Molokany' (Milk-eaters), both a kind of Baptists—the former have a strong leaven of practical communism—and the 'Stundists,' who are much under Protestant influence. The 'Khlysty,' or Flagellants, and the 'Skakuny,' or Shakers, belong to the same division. The Skoptsy (Castrati) have isolated adherents everywhere, even among the Lutheran Finns.

The Popovtsy draw their adherents chiefly from

the merchant class and the wealthier trading peasants; while the Bezpopovtsy and the Spiritualists reckon their adherents by the million among the masses of the peasants. Mutual aid is the rule among all dissenters, and the peasants who belong to some dissenting sect are, as a rule, wealthier than those who belong to the Orthodox Church. Several sects practise partial communism; and in all of them, especially among the Bezpopovtsy and Spiritualists, women occupy a higher position. The 'seeking of truth' being limited to the interpretation of the Bible, many absurd practices prevail ('love-feasts,' flagellation, and so forth), but free-thought also finds its way among them. Besides, most of the *raskolniks* are imbued with a Mennonite spirit of opposition to the authority of the state, its military service, taxation, and similar institutions. In the colonisation of the wildernesses of the Urals and, later on, of Siberia, the dissenters were the most numerous and most successful pioneers.

Government.—The political organisation of Russia is a very heterogeneous structure. It has at bottom a very great deal of self-government, based upon quite democratic principles. But above this stands the imperial authority, represented by an army of officials, whose powers, down to those of the very humblest rural policeman, are extremely vague and very extensive; and these officials are constantly interfering with the local self-government, and paralysing it, without, however, being able either to destroy it or to reduce it entirely into submission to the central authority. The entire legislation has this double character. The empire is an absolute and hereditary monarchy. The final decision in all legislative, executive, and judicial questions rests with the emperor, whose will is law. He nominates the ministers, and they practically enjoy wide latitude in interpreting the laws. A state council, composed of about sixty members, nominated by the emperor, discusses the legislative measures elaborated and proposed by the separate ministries, but the final decision is always given by the head of the state. The senate promulgates the laws; and the Holy Synod, composed of bishops nominated by the emperor, has the superintendence in religious affairs.

For administrative purposes the empire is divided into governments and territories, the names of which are given in the table on pp. 31-32. Each is ruled by a governor, whose rights are very extensive and ill defined, and who has direct control of the police in the eight to twelve districts into which each government is divided. Poland, Finland, Moscow, Kieff, and Vilna in Russia in Europe, and Caucasia, Turkestan, the Kirghiz Steppes, East Siberia, and the Amur region in Asia have governors-general, who are at the same time the commanders of the local troops. For military purposes the empire is divided into districts; so also for judicial and educational purposes.

Finland (q.v.) is a separate state, having its own money, finance, and representative institutions; but its autonomy has been much curtailed, especially since the summer of 1890.

Local Government.—The population of Russia still remains divided into social orders or classes, each of which enjoys separate and distinctive rights. The bulk of the population (over four-fifths) belong to the 'peasants.' Next come the burghers and the 'merchants' (9 per cent. in European Russia), the clergy (less than 1 per cent.), the nobility (1·3 per cent.), the military (6·1), foreigners (0·3), and lastly, the 'various.' The peasants, including those who are settled upon the state domains and the liberated serfs, have from time immemorial had institutions of their own, recently recognized by law. They are grouped

in village communes (107,943 in European Russia and Poland); and the assembly of all the householders of the commune, the *mir*, enjoys a certain degree of self-government. The land being held in common throughout Great Russia and Siberia, it is the *mir* that periodically distributes the land into allotments and then assigns them to the several households according to their respective working capacities. The *mir* can also open schools, support a midwife or a doctor, and undertake all kinds of works of public utility. It always elects its own executive, the *starosta* (elder), the tax-collector, and so on. This institution of the *mir* forms the basis of village life among all Great Russians, and traces of it are found among the Little Russians as well. All investigators of the *mir* are unanimous in recognising that, though the growing difference of fortune tends to undermine the institution, nevertheless it shows a wonderful elasticity in accommodating itself to new conditions. Some village communities buy in common modern agricultural machinery, others (in the industrial regions) form productive associations, while others again cultivate part of the land in common to supply the village stores, or undertake the boring of Artesian wells, and similar matters. The *mir*, they conclude, is not a superannuated institution; it can adapt itself to further economical progress. Several communes make a canton; and the cantonal assembly, composed of one delegate for every ten households, enjoys similar prerogatives. It also elects an elder, and a peasants' tribunal, composed of ten to twelve judges, who settle disputes amongst the peasants in accordance with the local common law. Special boards 'for peasants' affairs' are maintained in each province by the ministry of the Interior. Minor criminal charges, as well as civil causes up to the value of £30, are adjudicated upon by the justices of peace, in central Russia elected and elsewhere nominated. Appeal against their decisions can be made to the session of all the judges of the district, and from them to the senate. The justices of the peace, who materially contributed to the eradication of the old practices in vogue in the days of serfdom, are a most popular institution. But they were abolished in 1889 nearly all over Russia, and in their place were substituted 'chiefs of the district,' who combine in their hands judicial and administrative powers and are nominated by the governor from among candidates selected by the nobility, who have their own institutions—viz. district and provincial assemblies, each presided over by a marshal of the nobility.

The Zemstvos.—The administration of the economic affairs of the district and the province was in 1866 committed to the district and provincial assemblies, or *zemstvos*. Their members are elected by the peasantry, the householders in the towns, the clergy, and the landed proprietors—the census being so adjusted as to always give to the nobles and the householders the same number of representatives, or even more than the number sent by the peasantry. The *zemstvos*, both in the district and the province, elect their own executive. Although very much hampered by their limited powers of taxation, and still more by the heavy drain upon them for imperial purposes (justice, police, prisons, barracks, conscription expenses, roads, &c.), the *zemstvos*, which have been introduced in thirty-four governments of European Russia, have rendered great services to the country. They have opened numbers of schools, general and special, elementary and technical, created hospitals, and organised sanitary stations regularly visited once a week by a doctor; they have introduced mutual insurance against fire, and created the village postal institutions. Certain of

the *zemstvos* have devoted their attention to the opening of new channels for national prosperity, by supplying the villages with agricultural machinery, agricultural inspectors, and so on, or by supporting the domestic trades, and the productive associations. Many *zemstvos* have gathered really valuable statistical information by means of detailed house-to-house inquiries. Unhappily their rights were much curtailed in 1890.

A similar form of self-government, similarly hampered in its actions, has been introduced in the cities and towns; the *dumas* are composed in like manner of representatives of the population, and they elect their own executive officers. But, except in the greater cities, the municipal institutions have shown much less vitality than the *zemstvos*.

Judicial System.—This was entirely reformed in 1864. Trial by jury was introduced, proceedings in the law-courts were to be public, and corporal punishment by law was abolished. The preliminary inquiry was, however, maintained secret, as in France, and the benefits of the new law have not been extended over all Russia. Political affairs and political offences are still in the hands of the department of State Police in the ministry of the Interior. Certain political cases are brought from time to time before a special department of the senate, and heard with closed doors, but the greater number are disposed of by the department mentioned, suspect persons being transported to Siberia without bringing them to trial before a court. The prisons of Russia are extremely overcrowded, and on the whole in a very deplorable condition. Every year from 15,000 to 20,000 offenders against the common law are transported to Siberia, one-half in consequence of decisions of the courts, and the remainder by order of the administration (see *SIBERIA*). Capital punishment for common-law offences was abolished about 1770; murder is punished by hard labour in Siberia. But death is still inflicted for political offences.

Army and Navy.—Since 1874 military service has been rendered obligatory upon all able citizens between twenty-one and forty-three, though the duration of service is shortened in proportion to the education of the conscript. But of the actual total (860,000) liable for conscription every year little more than one-third (260,000) are selected for an effective four years' service with the colours; the remainder are inscribed either in the reserve troops (*Landwehr*) or the militia. In time of peace the army numbers nearly 814,000 men scattered all over the empire; the war-footing is reckoned at 2,221,000, with 550,000 horses and 5100 guns. In reality these last figures ought to be very greatly reduced. Russia might drag on a war for a long time by levying new armies in succession; but, with the present organization, she could hardly have a sufficiently numerous force to oppose successfully the shock of a rapid invasion. The navy, much improved of late, consists of 327 ships and torpedo boats, manned by 27,100 sailors; of the former 44 are ironclads.

Education.—When the serfs were liberated in 1861, and all the institutions of old Russia were being remodelled, a great movement for spreading education among the illiterate peasants was started by the richer and educated classes. Schools, Sunday-schools, and evening classes were opened in great numbers; methods of teaching were elaborated; and a rich literature of class-books and books for popular reading was brought into existence. The universities were thrown open to students, male and female. But the government soon put a stop to the movement, and placed all matters appertaining to education under the jealous control of the ministry of Public Instruction. Later

on, when the *zemstvos* were introduced, they sought to promote education into the country districts by opening various kinds of schools. All these efforts were bitterly opposed by the ministry, which directed its attention chiefly to spreading classical education among the privileged classes, whilst elementary, scientific, and technical education were totally neglected. During the present reign the ministry has begun to show special favour to the parish schools, which are conducted by the clergy. Schoolmasters of these schools are not required to pass the regulation examinations, since they are nominated by the bishops, as the clerical schoolmasters were in France before the school reform of 1880. Some progress has undoubtedly been made during the last thirty years in the education of the masses; but in 1888 only one-fifth of the army recruits could read and write. At the present time there are in the empire about 50,000 elementary schools with 2½ million pupils; nearly 1000 middle schools (classical gymnasiums, *Realschulen*, &c.) with 140,000 boys and 80,000 girls; and 31 higher institutions, of which eight are universities, with 20,000 male and 600 female students.

The education of women stands better than in many European countries, owing to the persistent efforts of the Russian women themselves. They managed to get by 1886 four university colleges for ladies with 1442 students, one medical academy with 500 students, and numerous intermediate schools between the gymnasium and the university. All these high schools, though maintained by private subscription, were closed by Alexander III. in 1886; but two colleges were reopened again in 1890, and they now have about 500 lady students. There are on the lists of the medical department no less than 695 lady doctors, of whom nearly one-half are employed in the civil service, chiefly by the *zemstvos*.

Finance.—The finances of Russia are in a precarious state. Though the state revenue increased from £58,700,000 in 1877 to £94,800,000 in 1890, the interest and annuities on the public debt increased during the same period from £11,400,000 to £26,600,000. The total of the public debt amounted on January 1, 1890, to the sum of £552,524,000, or nearly £5 per inhabitant. The peasantry are taxed so heavily that arrears accumulate every year, and attain formidable proportions after every failure of the crops.

Land-tenure.—European Russia, exclusive of Finland, covers nearly 1237 million acres; 1019 millions of these have been registered, and it appears that nearly one-fifth of that surface is unproductive and two-fifths are under forests. The remainder is partly meadow or pasture-ground and partly arable land, in the proportion of two to three. Two-fifths of the registered area belongs to the crown, one-third (317½ million acres) is held by the peasants' communes, representing an aggregate of nearly 25,000,000 men, and one-fourth part (252 million acres) is held by 481,400 private proprietors. Most of the land that is private property belongs to the nobility (197 million acres, 115,000 land-lords) and to 'merchants' (31½ million acres, 70,630 owners), who in recent years have bought large estates, especially in the steppe-region, chiefly in order to rent land to the peasants. The estates of the nobles are well cultivated only in west Russia.

Agriculture.—Agriculture is the chief occupation of the people of Russia; only in central Russia (Moscow, Vladimir, Nijni) does industry take the lead. The conditions of agriculture are obviously very different in different parts of the country. A line drawn across European Russia, from Kieff to Nijni-Novgorod and Vyatka, will divide the country into two parts, of which the south-eastern has a surplus of wheat and rye and exports them,

while the other has to import both. More than one-half of European Russia thus produces less wheat and rye than is needed for home consumption. If all the wheat and rye produced by Russia in an average year were consumed within the country itself, the annual consumption of wheat, which is now very low (85 lb. per inhabitant), would only be increased by 40 lb. per inhabitant; and that of rye, which is now 330 lb. per inhabitant, would be increased by 36 lb. only. The total annual consumption of wheat and rye per inhabitant would then be 491 lb. instead of 415 lb., which it is now—i.e. if no corn at all were exported from Russia the consumption of bread throughout the country altogether would be about the same as what is habitual in France (505 lb.). These facts, the result of recent and careful investigation, dispose at once of the theory that Russia may be regarded as the granary of Europe. Moreover, the crops of Russia are subject to great fluctuations, and bad years recur, as in India, at intervals of from ten to twelve years. The year 1891 was a time of extreme famine in many provinces.

During the average years 1883-87, 161,930,000 acres were under the various corn crops in European Russia (excluding Poland and Finland), and 3,712,000 acres under potatoes. The total yield reached on an average 81,100,000 quarters of rye, 27,014,400 of wheat, 64,255,000 of oats, 16,269,000 of barley, 12,150,000 of various other cereals, and 33,935,000 of potatoes; in 1889, however, all the crops were fully 25 per cent. below these figures. Flax and hemp are extensively cultivated in the west, the sugar-beet is grown in the south and south-west, and tobacco is produced in the south. The vine is widely cultivated on the Black Sea littoral and in Caucasia, but less than 360,000 acres are under proper culture, and the wine-production is still in its infancy. Cotton is beginning to be widely planted in Turkestan.

Mining.—The empire is very rich in all kinds of minerals; and its mining industry, which gives employment to nearly 400,000 hands, has of late years begun to advance with rapid strides. Gold is obtained in Siberia and the Ural Mountains, in quantities varying between 871,000 and 1,702,800 ounces every year. Silver (264,000 to 396,000 oz.) and lead are obtained in Siberia, the Kirghiz Steppes, the Caucasus, and Finland; platinum (4840 to 9460 lb.) in the Urals. Iron ores are found in profusion both in the Asiatic dominions and in European Russia (Olonez, central Russia, south Russia), and the raising of iron has increased from 448,000 tons in 1880 to 1,022,000 tons in 1895 (steel, 565,000 tons). Zinc is mined in Poland, tin in Finland, and cobalt and manganese ore in Caucasia. Salt is obtained from the salt-lakes of Asia and south Russia. Russia has excellent coal-basins, especially in the Don region, but, owing to the immense forests and the facilities for shipping firewood on the rivers, the raising of coal, notwithstanding high protective tariffs, develops rather slowly; the total output in both Poland (which has good coal-mines in Kielce) and Russia reaches only $3\frac{1}{2}$ to $4\frac{1}{2}$ million tons. The exceedingly rich oil-wells of Baku supply Russia with both petroleum and fuel; the latter is largely used on the steamers of the Volga, on some railways, and in various manufactures. The total output of crude petroleum averages about 3,300,000 tons.

Manufactures and Petty Trades.—The manufacturing industry of Russia has grown up since the abolition of serfdom. Although handicapped by the protective duties upon foreign imports (e.g. machinery) it nevertheless has attained an average yearly production of £142 for each workman employed; in 1887 the aggregate production of the

23,500 manufacturing establishments of the empire, which gave employment to 1,450,000 workers, was valued at £125,000,000. The mining industry and the industries which pay excise duties (tobacco, sugar, spirits, beer, petroleum, and matches) are not included in the above. The chief industrial centres are Moscow and the surrounding governments, St Petersburg and Poland. The woollen trade is taking firm root in the south, chiefly through English capital and enterprise. The production of alcohol (chiefly *vodka*, the national spirit) averages 80 to 95 million gallons of pure alcohol every year. There are over 200 sugar-mills and nearly 400 tallow-factories in Russia.

The domestic industries, which are carried on by the peasants of central Russia contemporaneously with agriculture, are of much greater importance in Russia comparatively than they are in western Europe. It is estimated that no less than 7,500,000 peasants are engaged in these domestic trades, and that their yearly produce (£180,000,000) exceeds in value that of the aggregate produce of the manufactures. The greatest conceivable variety of products are thus manufactured in the villages, from the roughest article used by the millions of peasants to the finest articles of luxury. Co-operation, which enters into the essence of Russian peasant life—the *artel*, or co-operative productive or consuming association being constituted by Russian peasants and factory-workers for every possible purpose—finds a wide field for application among the domestic trades, and would spread much more rapidly were it not for the extreme poverty of the producers, who are entirely in the hands of the 'sweaters.'

Commerce.—The exports of Russia to foreign countries consist principally of corn and flour (55 per cent. of the total exports), various articles of food (butter, eggs, &c.), flax, timber, oleaginous grain (chiefly linseed), raw wool, naphtha, and illuminating oils. These commodities and others not named reach an annual value of £54,000,000 to £79,000,000; but the total depends entirely upon the yield of the crops. The imports (about £40,000,000 every year) consist chiefly of raw cotton (£7,000,000 to £10,000,000), tea, raw metals, machinery, raw wool, colours, iron and steel goods, and coal. Tea and coffee, wines, and fruits are also considerable items; but the aggregate value of the imported manufactured goods hardly reaches £4,500,000. The character of the imports into Russia has totally changed during recent years, partly in consequence of the nearly prohibitive tariffs, but especially on account of the development of industries in Russia. The cotton, sugar, and iron goods—all formerly imported from abroad, but now made and prepared at home—are not dearer in Russia than they are in western Europe.—The inland trade of Russia is characterised by many interesting peculiarities, chiefly connected with its great fairs (at Nijni-Novgorod, Kharkoff, Irbit, &c.), which are still of immense importance.

Navigation.—The ports of Russia are entered every year by about 12,500 vessels of 7½ million tons, of which only 1100 to 1200 (chiefly belonging to Finns or Greeks) sail under the Russian flag. Many vessels come in ballast to take cargoes of grain. In the coasting trade the ports were entered by 37,500 vessels of 8,500,000 tons in 1895.

Communications.—The importance of the Russian rivers for traffic has already been mentioned. It may be added that over 1500 steamers ply on the rivers of European Russia, and that every year some 67,000 boats and barges and 90,000 rafts are unloaded at the river ports, the total amount of goods shipped exceeding 9 million tons, as against 55 million tons carried by rail. About 1860 Russia had less than 1000 miles of railways; but in 1891

she had a network measuring 20,115 miles, out of which 1166 miles are in Finland and 890 in the Transcaspien region. This extensive system (exclusive of the Finnish and Transcaspien railways) has cost more than £300,000,000, nine-tenths of which has been supplied by the state by means of loans. Besides paying a high interest for these loans, the state has also bound itself to guarantee to most railway companies a revenue of five per cent. upon the capital employed, which capital, as a rule, very greatly exceeded the real expenses. Thus the state pays every year to the railway companies sums varying from £700,000 to £6,500,000. Several lines of railway have recently been bought by the state, which now owns, in Russia proper and Poland, 5426 miles. A little over 40 million passengers are transported every year by rail. Corn is the chief item in the nearly 55 million tons of goods carried every year. A long series of railways now being laid is to reach right across Siberia (q. v.), from the Urals to the Pacific.

Post and Telegraph.—An extensive organisation of nearly 4220 stations and 38,400 post-horses is maintained by the state between all the towns of the empire not yet connected by rail, for the conveyance of the post and passengers. The total length of this post system is over 100,000 miles. The 5881 post-offices of the empire transmitted in 1892 no less than 260,000,000 letters and post-cards; and in the same year 4200 telegraph-offices transmitted 12,785,000 telegrams. The length of the state telegraph lines attained at the same time 88,280 miles.

Architecture.—Russian architecture is directly descended from the Byzantine (q. v.), but modified by native and Asiatic influences. The first church-building tears, such as Vladimir (981-1015), employed Greek architects; but their churches were mainly of wood and have disappeared. The usual Russian church has a central dome, surrounded by four (or more) smaller cupolas, whose form has been, under Tartar influence, changed to the onion-shape that appears in Mongol-Indian mosques on the Ganges. In the famous cathedral of St Basil, of which an illustration is given at Moscow, the central tower is surrounded by eight smaller ones, crowned by various bizarre cupolas, and painted with the most brilliant colours. This church was built by Ivan the Terrible about 1554. After the time of Peter the Great the native type gave way to reproductions—often bad—of various classical models; the architecture of St Petersburg is characterised at RENAISSANCE, Vol. VIII. p. 644.

History.—The Slavs were not the primitive inhabitants of the plains of eastern Europe; in the first centuries of our era their abodes were on the Danube, the Elbe, and the south shore of the Baltic Sea, and they entered what is now Russia from the west. The southern Slavonians took possession of the upper Bug, Dniester, and Dnieper, while the northern Slavs occupied the lake-region of Pskov and Novgorod. The date of that immigration is not known, but it is certain that in the 9th century their small tribes occupied—besides part of what is now Poland—a territory stretching north and south from lakes Peipus and Ilmen to the mouth of the Dniester. Various Finnish tribes were then living in Finland, and the basins of the Dwina, Petchora, and upper Volga; the space between the Dwina and the Vistula was inhabited by the Lithuanians; while several Finno-Turkish tribes, mostly nomads, had taken possession of the southern slopes of the central plateau: the Bulgars were at Kazan; the Mordvins, the Mescheryaks, the Tchuvashes, and the Tcheremisses on the middle Volga; and the Khazars in the southern Steppes. Finally, the Turkish stems of the Polovtays, the Petchenegs, and the Turks camped

in the Caspian Steppes to the east of the Volga. Already at that time the Slavs were agriculturists, and their country was dotted with numerous small forts. Like all primitive inhabitants of Europe, they were organised in 'gentes'—the family once having been matriarchal. The land was held in common by each clan and tribe, and the common affairs were decided at folk-motes, or assemblies of the clan, the tribe, or the 'land.' Caesar and Tacitus found the same organisation among the ancient Germans.

The territory of the eastern Slavs was the great highway from Scandinavia to Greece; and caravans of Scandinavian merchants followed the route from Novgorod to Kieff on their frequent journeys to Constantinople. The same route was followed by the Norman warriors (Väringiar, Varyagues, Varangians), who, reinforced by Slav adventurers, used to engage in the service of the Greek emperors. The Greeks used to call them Rosses or Russes, but it remains uncertain whether the name was borrowed from some locality in Scandinavia (Ros, Roslagen; Ruotsi = Swedes), or, what seems more probable if Arab testimony is taken into account, from a territory on the Dnieper. It is more than probable that from a remote antiquity the Slavs used to apply to leaders of such military bands for protection, and the oldest Russian chronicle, known as Nestor's (it was probably compiled from older chronicles and epic traditions about 1115, by the Kieff monk Sylvester), says that the folk-motes of the northern Slavs, after having sent away in 859 the Varangians to whom they paid a tribute, summoned again the Varangian rulers in 862 'from beyond the sea,' to command and judge them according to law.' The first historians of Russia, who used to interpret facts of a remote past according to modern conceptions, were disposed to regard the Varangian dukes as a sort of modern kings, and spared no effort in tracing a 'Rurik dynasty' down to our own times. But it has now been proved by careful research (by Professors Kostomaroff, Solovieff, Sergueévitch, Byelyaëff, Bestuzhef-Riumin, and many others) that the supposed kings were simply military chiefs, to whom the military defence of the cities was entrusted, like the *podesta* of the Italian cities in the 15th century.

Three brothers, Rurik, Sineus, and Truvor, were thus invited, according to tradition, and they settled respectively in Ladoga, By-lozersk, and Izborsk—i. e. on the borders of a territory which had to be defended against the Finns and the Lithuanians. They and their successors built new forts, and took part in wars, the description of which in Nestor's chronicle has all the characters of an epic poem. Rurik's brother, Oleg, is said to have imposed his authority upon Kieff and Smolensk; he, as well as Rurik's son Igor, made campaigns against Constantinople; and Oleg's widow, Olga, who ruled after his death, was baptised in the Greek capital. Wars were waged, under Svyatoslav's leadership, against the Khazars and the Greeks. The Russians conquered Bulgaria, took possession of all its fortresses, and nearly captured Constantinople. The campaign (fully described by Byzantine historians) ended, however, in a disaster. The times of the 'Sunny Vladimir' (980-1015) are the 'heroic' epoch of early Russian history, and the feasts and feasts of Vladimir and his *drujina* ('war companions') have been handed down through ages in legend and song; while his conversion to Christianity made him the hero of the annals written by monks. He and his *drujina* were baptised at Kieff in 988, and the people of Kieff soon followed him. The first half of the 11th century, during which Yaroslav the Wise was grand prince at Kieff, while his brothers and nephews ruled at Novgorod, Polotsk, Murom, Vladimir in

dit
6
c.

dit
10

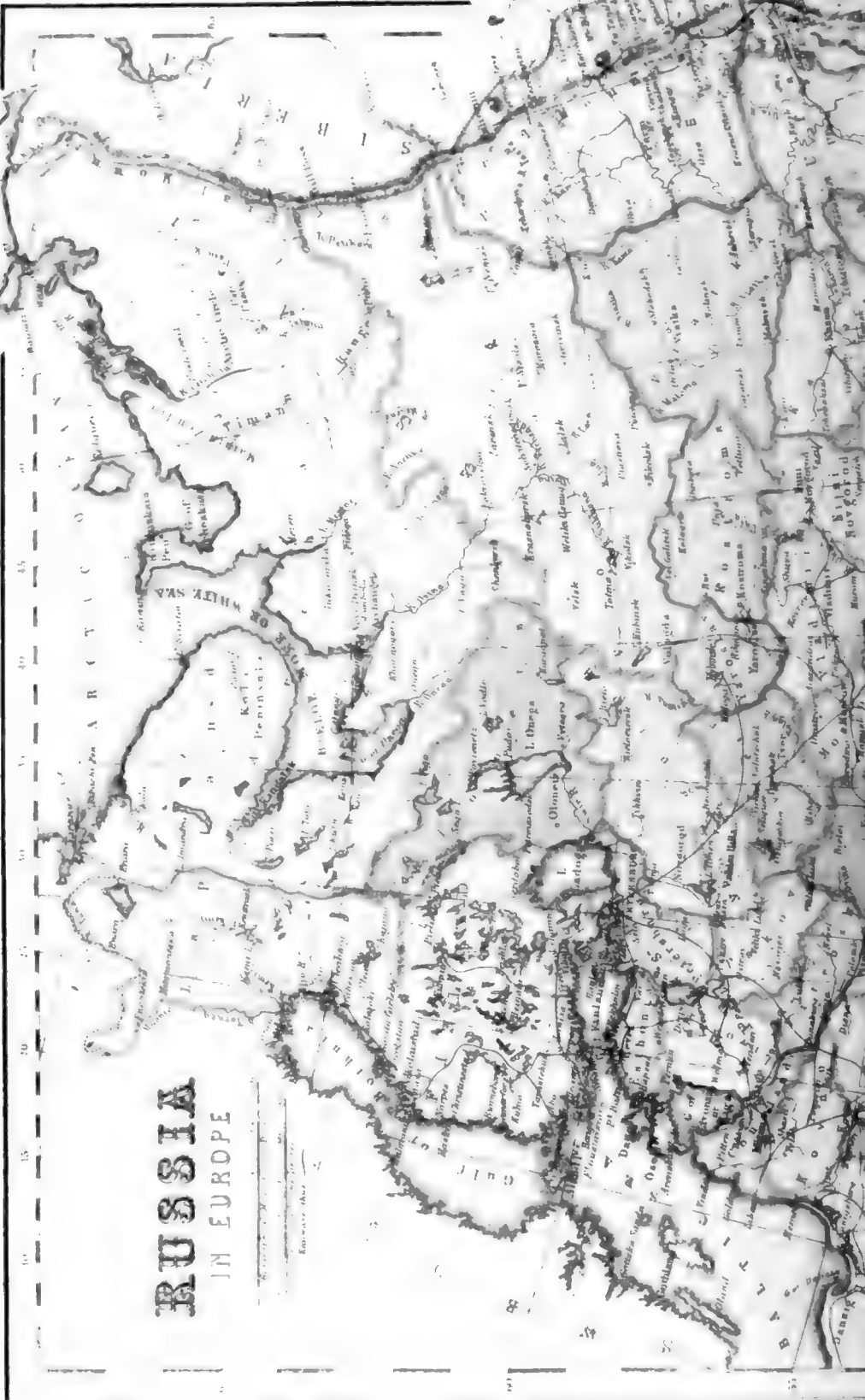

RUSSIA IN EUROPE

10 15 20 25 30 35 40 45 50 55 60 65 70 75 80 85 90 95 100

RUSSIA

RUSSIA

RUSSIA

RUSSIA

RUSSIA

RUSSIA

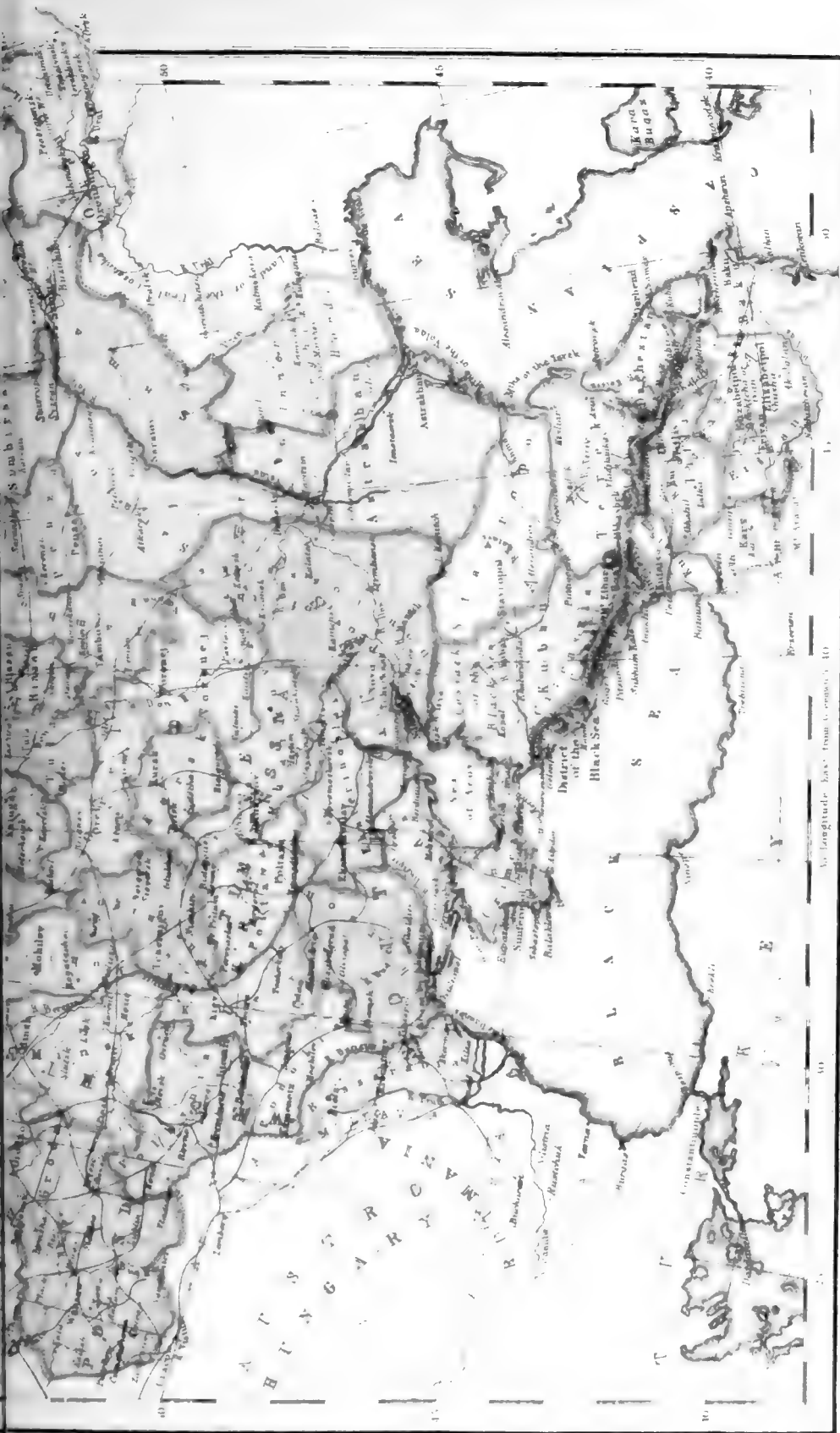

W. & A. CHAMBERS, LIMITED LONDON & EDINBURGH.

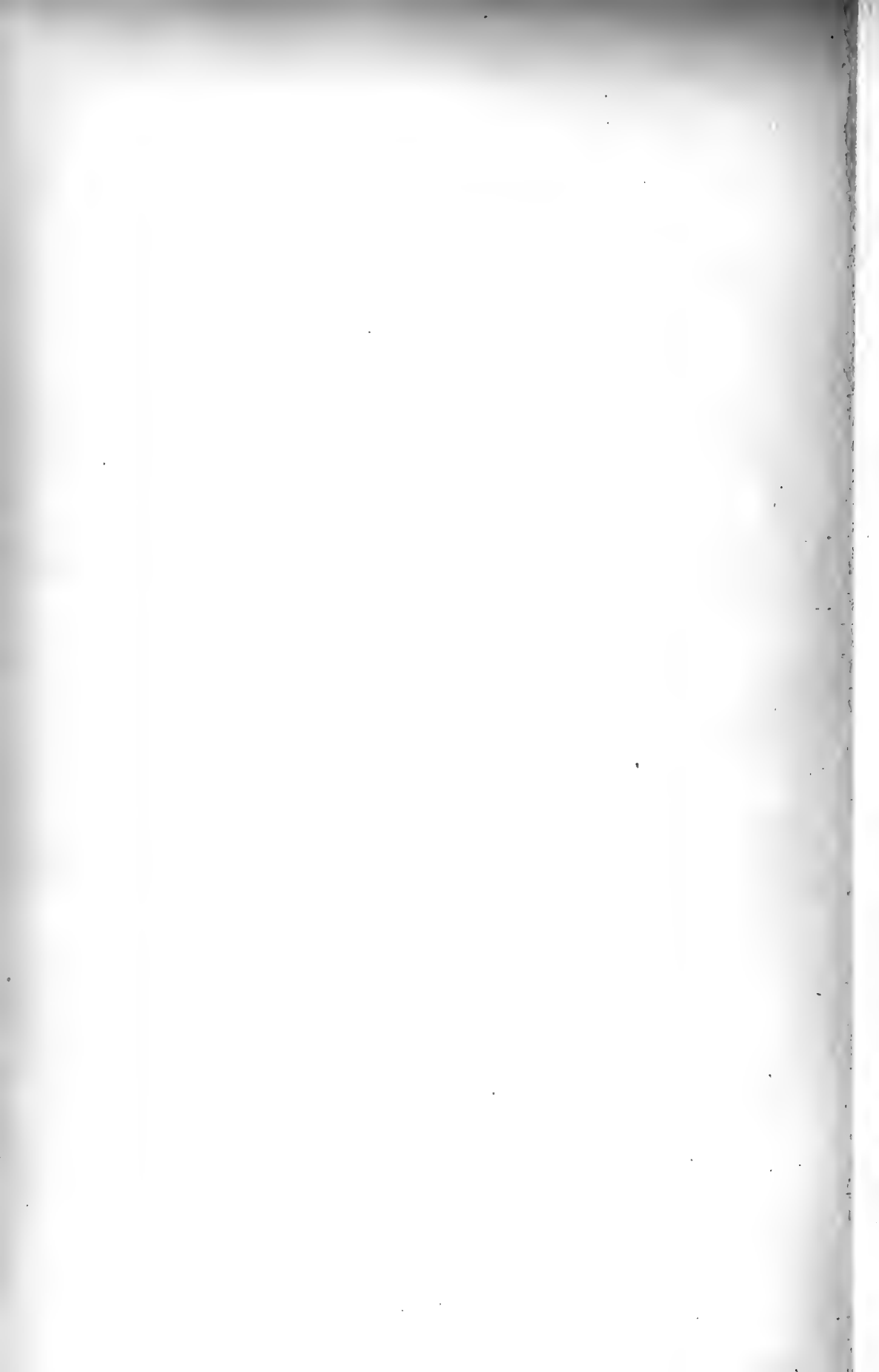

Volhynia, and even Tmutorakañ in north Caucasia, was the most brilliant time for Kieff. The 'mother of the Russian towns' grew to be a populous city, visited by numerous caravans of merchants, and Adam of Bremen described it as 'a rival to the supremacy of Constantinople.' The great cathedral of St Sophia was built at that time; as also many other churches. Schools were opened, and the first written Russian law—the 'Russkaya Pravda,' or, at least, its essential parts—was compiled. It cor-

responds to the *leges barbarorum* of the ancient Germans and Scandinavians. By the end of his life Yaroslav was ruling over most of the Russian towns, and his daughters were married, one to the king of Poland, another to Harold in Norway, a third to Henry I. in France, and a fourth to the king of Hungary. He died in 1054.

The next two centuries of Russian history correspond to the feudal period of western Europe. In the annals they appear as an uninterrupted

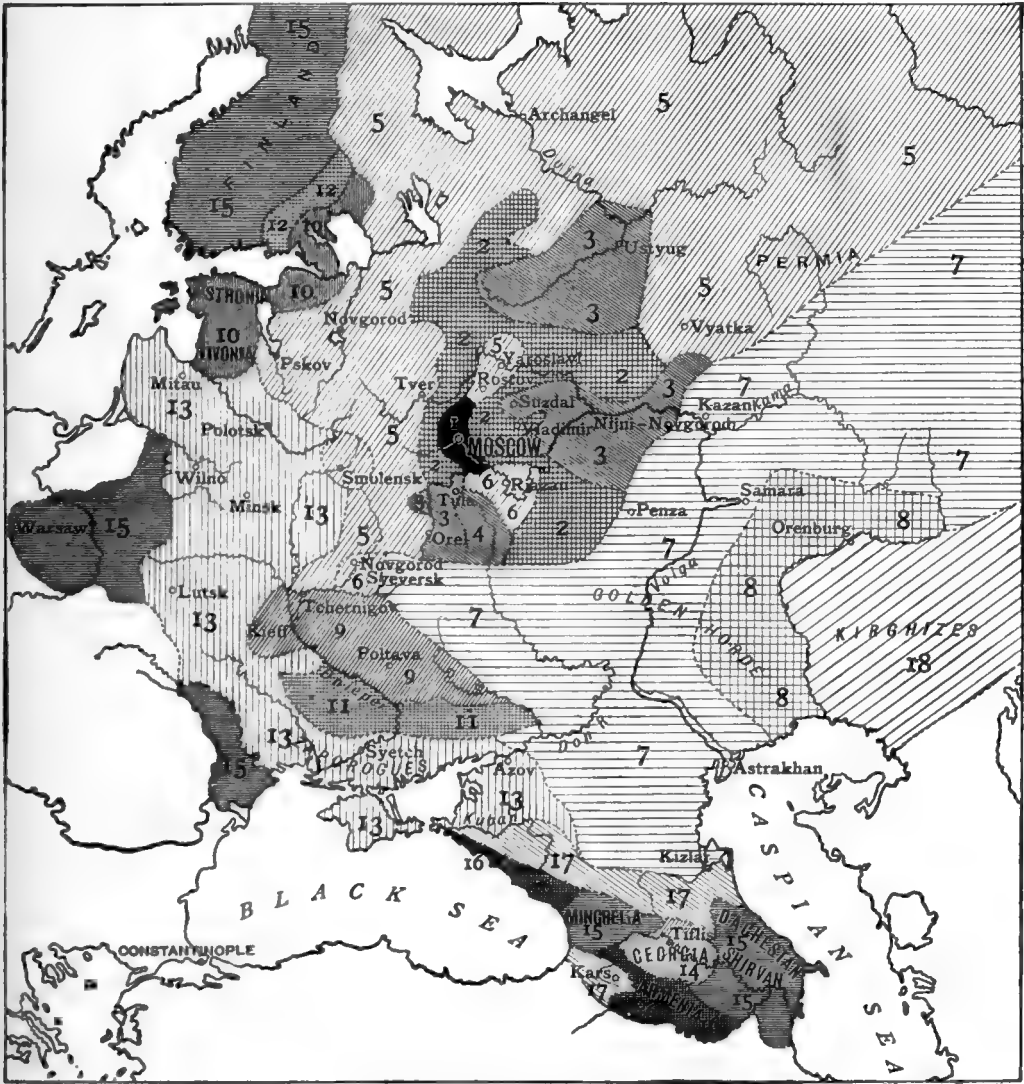

Historical Map of Russia :

1. Principality of Moscow under Daniel, 1308.
2. Acquisitions of Yuri, Ivan Kalita, and Dmitri Donskoi, 1389.
- 3, 4. " the two Vassil, 1465.
- 5, 6. " Ivan III. and Vassil Ivanovitch, 1583.
7. " Ivan IV. the Terrible, 1584.
8. " Mikhail Romanoff, 1645.
9. " Alexei Mikhailovitch, 1676.

10. Acquisitions of Peter I., 1725.
- 11, 12. " Anna and Elizabeth, 1762.
13. " Catharine II., 1796.
14. " Paul I., 1801.
15. " Alexander I., 1825.
16. " Nicholas I., 1855.
17. " Alexander II., 1881.
18. " the period 1780-1845.

succession of petty wars between the descendants of Yaroslav for the right of ruling in this or that city, or for the supremacy at Kieff. But modern research has disclosed the real characters of the epoch. The Russians at that time were steadily

extending their territory towards the east; they colonised the Oka, the Don, and the Finnish territories in the north-east. Between the numerous clans and territories into which they were divided there were no exterior bonds of unity save the

unity of language and religion, and the common idea that no prince must be taken by any Russian territory except from among the descendants of Yaroslav. The natural centres of the territory were its fortified towns, which offered a refuge to the population in case of need. In each town the folk-mote remained supreme; it decided upon war and peace; it invited a prince to defend the territory, and the prince, before being recognised as such, had to sign a covenant (*ryad*), and to take the engagement to rule according to law. He was bound to keep a band of warriors (*drujina*) to protect the territory, and was entitled to levy for that purpose a tribute as well as the usual judicial fines: the disputes among the citizens being settled by twelve jurors (six for the defendant and six for the plaintiff), the prince or his deputy had to pronounce the sentence and to levy the fine when the parties applied before the prince's court instead of the folk-mote. The cities usually were divided into sections and 'streets,' corresponding to the trade and artisans' guilds, and each of them had its own self-government; it elected its priests and functionaries, while the folk-mote of the whole city elected the *posadnik* or mayor, the *tysiatskiy* (*millenarium*) or commander of the militia, and the bishop. The fortifications of the cities were mostly built out of the wealth accumulated by the cathedral church, which was the exchequer of the city. The guilds of the merchants in larger trading cities, like Novgorod and Pskov, used to carry on trade in the name, and, at the outset, for the benefit of the whole city. The city—not the individual—sent out its caravans and boats, and it also used to send out parties of young men into the lands of the Finnish tribes to carry on trade, to levy tribute, and to colonise them. In this way Novgorod conquered the north-east of Russia, and founded there its daughter-republics of Vyatka, Dwina, and Vologda; and later on its men crossed the Urals to trade with Siberia. Kieff was recognised as the eldest of the cities, and the eldest of the kin of the princes had to rule at Kieff. But this unwritten agreement was not always obeyed, and consequently numberless petty wars took place between the princes. The country, however, took no part in these wars, with the exception of a few isolated cases always specified in the annals. In each territory there was the chief city (*gorod*), and the subordinate ones (*prigorod*), but no traces of submission of the latter to the former can be discovered in the documents of the times, the annals simply mentioning that the *prigorods* take the same decisions as the *gorod*. The soil belonged to the freemen who cultivated it; but slavery existed, and there was some trade in slaves, chiefly prisoners of war. A free man who entered into any one's service without agreement and remained in a servant's position for more than one year was also considered *kholop* or slave, as well as he who sold himself into slavery under the pressure of necessity. Trade prospered at that time, especially at Kieff, which was the great storehouse for trade with Greece and Asia, and Novgorod (which later on joined the Hanseatic League) for the trade with Germany and Scandinavia. Pskov, Smolensk, and Polotsk also were important centres of commerce.

During the 10th, 11th, and 12th centuries Russia was thus covered with a number of free democratic republics. But the Greek Church already worked hard at introducing into Russian life the conception of the state and the authority of the monarch. Instead of the common-law view of justice as amends made by the offender for the wrongs he has done to the individual or the community, the church introduced the Roman conception of justice as established by the state, and with it the idea of cruel corporal and capital punishments. At the

same time it spread education and developed the taste for reading, and its monasteries were centres of further colonisation. But it also introduced the Byzantine ideas of asceticism and submission, and subsequently its influence, reinforced by that of the Mongols and the Tartars, contributed to give to woman a subordinate position quite contrary to the spirit of the Slav laws. And finally a new power grew up during the same centuries—viz. that of the *boyars* or *bolars*. Formerly they simply were the chief warriors and counsellors of the *drujina*; but later on, as some of them grew wealthier through trade and war, they acquired more and more importance in the cities as well as in the country. Thither they attracted peasants to settle on the free lands, and gradually reduced them to the condition of tenants. Such was the state of Russian society during the *udyelnyi* or feudal period before the Mongol invasion. Of all the princes who ruled at Kieff during that period Vladimir Monomachus (1113–25) deserves special mention as a ruler whose paternal authority was recognised by most Russian princes, whom he succeeded in bringing together for the defence of the territory against the Polovtays. With him really ended the supremacy of Kieff, south-west Russia becoming more and more the prey of its nomad neighbours, as well as of its western neighbours, the princes of Volhynia and Galicia.

Owing to the gradual colonisation of the basin of the Oka and the upper Volga, a new Russian territory had grown in importance in the meantime. Suzdal and Rostov were its chief centres. It differed from south-west Russia in many respects: its inhabitants were Great Russians—a hard-working race, less poetical and less gifted, but more active than their southern brethren. Besides, a good many of its inhabitants were peasants settled on the lands of the boyars—country-people, not accustomed to the folk-motes of old; and the cities themselves, being of recent creation—like Vladimir and, later on, Moscow—had not those traditions of independence which characterised Kieff or Novgorod. It was therefore easier for the authority of the prince to develop in the north-east, under the guidance of the church and the boyars, without being interfered with by the *vetche*. The Suzdal prince, Andrei Bogolubskiy (1157–74), was the first representative of that policy. He and his churchly advisers founded a new town, Vladimir, on the Klazma, a tributary of the Oka, and sanctified it by transporting thither from Kieff an icon of the Virgin, which had come from Constantinople, and was reputed to have been painted by St Luke. He invited many Kieff boyars to settle in the land of Suzdal, and finally he undertook to strike the last blow at the supremacy of Kieff. He induced the land of Suzdal to levy an army, which took Kieff in 1169, plundered and burned it, massacred numbers of its inhabitants, and carried others away into slavery. The supremacy of Kieff was thus destroyed, and the land of Suzdal became the *Île-de-France* of Russia—the nucleus of the future Russian state. Andrei was killed by his own boyars; but the Suzdal land continued to grow and to enjoy prosperity during the next fifty years; economical, educational, and literary progress were marked, and the Russian territory extended farther eastwards. A rival was given to Novgorod in Nijni-Novgorod, at the junction of the Oka with the Volga. But in the 13th century a great calamity visited Russia; a Mongol invasion suddenly put a stop to the development of the country and threw it into a totally new direction.

For several centuries past the rapid desiccation of central Asia (see ASIA) had been compelling the inhabitants of the high plateau to migrate into the lowlands, and thence westwards towards Europe.

Under this pressure of Asia upon Europe the Ugrians, who inhabited the Urals, moved over the south Russian steppes to Hungary; and the Polovtsy, the Petchenegs, and other tribes were making in succession their raids upon south-west Russia. Now it was the turn of the nomads, who inhabited the very heart of Asia, and whom Genghis Khan (q.v.) had united into a great confederation, to enter Europe. They already had conquered Manchuria, part of north China, Turk-estan, and Bokhara, and devastated the encampments of the Polovtsy. The Polovtsy applied for aid to the Russians, and their united forces met the invaders on the Kalka River (a tributary of the Don) in 1224. The Mongols and Tartars were completely victorious, but retreated and did not return to Russia till after thirteen years. In 1238 the hordes of Batu-khan invaded the whole of east and central Russia. Ryazan, Rostov, Yaroslav, Tver, and Torjok were burned; only the marshes of Novgorod protected the north-western republic from the same fate. In 1239-40 they ravaged the south-west, destroying Tchernigov, Galicia, and Kieff, and entered Poland and Hungary. But, being checked in Moravia, and receiving at the same time the news of the Khan's death, Batu-khan returned to Asia, and built his palace at Sarai on the lower Volga. Thither the Russian princes had to go to pay tribute and receive their investiture by kissing the stirrup of the khan.

After having ravaged Russia the Mongols did not interfere much with her internal organisation. They respected the church; they left the peasants in possession of their lands, and the princes in possession of their authority; but every prince had to receive his investiture from the khan, and it was at the khan's court, sometimes on the banks of a tributary of the Amur, that intrigues for supremacy between the Russian princes were settled—sometimes through the assassination of the prince who was not rich enough to buy the support of the advisers of the khan. It was especially with Mongol aid, and often with Mongol armies, that the wealthy princes of Moscow succeeded in destroying the autonomy of the surrounding principalities, and imposed upon them their own yoke.

The taxes of Russia were originally farmed out by the khan to oriental merchants; but, to avoid popular revolts, the princes undertook to collect them with the aid of the Tartars. The courts of the Russian princes, who surrounded themselves with Tartar and Mongol advisers, took an oriental character. The industrial, artistic, and literary development of Russia was totally arrested. On the whole, Mongol rule threw the country more than 200 years behind the other states of Europe. The principalities of Kieff and Tchernigov never recovered afterwards. Their decline, however, made room for the rise of Galitch to pre-eminence in western Russia, and, amidst wars against Hungary and the Tartars, it preserved greater independence than any of the Russian principalities till, in the later half of the 13th century, it was taken possession of by Casimir III. of Poland. About the same time Volhynia was joined to Lithuania. The rise of this latter state was much favoured by the prostration into which Russia had fallen; and after an existence of several centuries, during which it extended its power so as to include Livonia proper, the Russian provinces of White Russia, Volhynia, Podolia, and the Ukraine, it was joined in 1569 to Poland (q.v.). On the north of Lithuania arose in the beginning of the 13th century another power, the Livonian Knights Sword-bearers, who took possession of Livonia, Courland, and Esthonia, as well as some portions of the territory of Novgorod and Pskov; while the Scandinavians, blessed by Pope Gregory

IX., undertook a crusade against Novgorod. They were, however, defeated by Alexander Nevski (q.v.; 1252-63).

In the beginning of the 14th century eastern Russia consisted of the principalities of Suzdal, Nijni-Novgorod, Ryazan, Tver, and Moscow, and long contests took place between them, especially between the latter two. At last Moscow—a small village fortified by Yuri Dolgorouki (1147)—took the upper hand. It was entirely free of municipal traditions, and the powers of the prince could freely develop there, unchecked by the *vetche*. It occupied an advantageous position at the junction of several main routes, and on a then navigable river, amidst a territory thickly peopled by boyars' peasants, who enriched the prince and the boyars. The church, always prosecuting its aim of creating a monarchy in Russia, soon perceived the importance of Moscow as a centre of a future state, and its head, the metropolitan, removed thither from Vladimir in 1325. The church, the boyars, and the princes thus created at Moscow the power which was necessary at that moment to oppose the encroachments of Catholic Lithuania, Poland, and Livonia. Ivan Kalita (1328-40), Simeon the Proud (1340-53), and the regency of boyars which administered the affairs under his weak-minded son Ivan II. (1353-59), as also during the minority of Ivan's son Dmitri Donskoi (1359-89), all pursued the same policy of increasing the powers of Moscow by weakening the neighbouring principalities—Nijni-Novgorod, Tver, and Ryazan. Taking advantage of the weakness of the Mongol khanate, now divided into the hordes of Nogai, Crimea, Kazan, and Astrakhan, the east Russians made in 1380 the first attempt at throwing off the yoke; their armies federated under Dmitri, and they ventured for the first time to meet the Mongol armies in a battle on the field of Kulikovo, on the banks of the Don. The battle was not decisive, but the church ascribed the victory to the holy icons of the Moscow monasteries and to Dmitri. True, next year the Khan Tokhtamysh advanced suddenly on Moscow, burned it, killed no less than 24,000 people, and exacted a heavy tribute. But this was the last time that Moscow fell into the hands of the Tartars. Its Kreml (citadel), which had resisted in 1368 and 1371 the assaults of the Lithuanians under Olgerd, was more strongly fortified, and when Khan Edighei besieged it in 1408 he could only ravage the suburbs.

The gradual increase of the Moscow principality continued under Vassili I. (1389-1425)—who bought from the khan the right of ruling at Nijni-Novgorod, and conquered Rostov and Murom—and Vassili II. the Blind (1425-62). Still the prince, though assuming the title of Great Prince, was merely recognised as the eldest by other princes, and the cities maintained their independence, simply paying to his delegates a tribute in exchange for military protection, while Moscow was ruled in reality by the *duma* (council) of the boyars, especially after Vassili II. became blind. It was under Ivan III. (1462-1505), named 'the Great' by some historians, that the prince of Moscow, after having for forty years seized every opportunity for abolishing the autonomy of other principalities, and having married Sophia, a niece of Constantine Palæologus (who came to Moscow with a numerous following of Greeks imbued with ideas of Roman autocracy), assumed the title of 'Ruler of all Russia' (*Hospodar Vseya Rossii*), and adopted the arms of the Byzantine empire. He took advantage of the divisions at Novgorod between the oligarchy of merchants, who were appealing for assistance to the Poles, and the people, and, supported by Tartar cavalry, marched against the republic (1471). Novgorod was defeated and sub-

mitted; but new difficulties arose, and, after having preached a national war 'against the pope and his allies the Novgorodians,' Ivan took possession of the city (1481), decapitated numbers of boyars and rich people, and transported 8000 Novgorodians into the cities of eastern Russia. The colonies of Novgorod (Vyatka, Dvina) were conquered next, and in 1495 the Hanseatic market of Novgorod was pillaged by Ivan's men, and all the goods taken to Moscow. Novgorod thus lost both its independence and its trade.

The Tartar-Mongols being divided at this time, the Russians took advantage of the fact to refuse tribute; and when thereupon the khan of the Golden Horde, stimulated by Casimir's promises of support, marched against Moscow, an army of 150,000 men was sent to meet him on the Oka. Both armies stood there for months inactive, till, finally, the Tartars, seeing no support from Lithuania, and probably learning that Sarai had been plundered by a straggling band of Russians, suddenly retreated to ravage Lithuanian territory. This retreat is considered as the liberation of Russia from the Tartar-Mongol yoke (1480).

Russia's chief enemy, however, was Lithuania, united at that time with Poland. It stood at the very gates of Moscow, keeping garrisons in towns 150 miles distant from the Russian capital, and always ready to employ the Tartars against the Russians. A protracted war ensued, with the result that several princes on the upper Oka and Desna (tributary to the Dnieper) surrendered to Ivan. Smolensk, however, remained under the Lithuanians. Vassili III. (1505-33) followed his father's policy. He continued the war with Lithuania, and retook Smolensk. He annexed Ryazan and Novgorod-Syever'sk, and conquered, by taking advantage of its internal dissensions, the last north-western republic, Pskov. The *vetche* was abolished, its bell taken to Moscow, and 300 wealthy families transported to east Russia.

Vassili's son, Ivan IV. (1533-84), was proclaimed Great Prince when he was only three years old. His reign is still the subject of the most contradictory estimates by historians. The fact is that by that time the boyars of Moscow, reinforced by all the dethroned princes and their descendants, had grown all-powerful. Not only the laws were issued by the boyar *duma* (council) in the name of 'the Great Prince and the boyars,' but their authority within the palace overshadowed that of the prince. In his childhood Ivan IV., though surrounded with adulation at official receptions, was kept in neglect and almost hunger. Russia was like to become another Poland ruled by the rival parties of nobles. During the first years of his reign Ivan ruled with their support and under the influence of the priest Sylvester and the minor noble Adashev. The states-general were convoked twice (1549 and 1550), the code (*Sudebnik*) of his grandfather was revised, and church matters were settled in 'The Hundred Articles' (*Stoglav*) by a council. Kazan was conquered in 1552, and Astrakhan two years later. But within the palace affairs stood at their worst. Ivan's two advisers, grown very powerful, were gained over to a party hostile to Ivan and favourable to his cousin, and when Ivan fell ill (1553) he witnessed during his sufferings the intrigues of his advisers. Once recovered, he exiled them. At the same time a mighty feudal prince, Andrei Kurbski, openly went over to the service of Lithuania, while other boyars maintained a secret understanding with Poland to place on the throne a ruler who might be their tool. Ivan IV. began most cruelly to persecute the boyars, and his cruelty soon attained the pitch of real madness. No less than

3470 victims, out of whom 986 are mentioned by name, were inscribed by Ivan IV. himself in his prayer-book, and among them are whole families 'with sons and daughters,' as well as 1505 Novgorodians, 'whose names, Almighty, Thou knowest.' Ivan's historical position appears very much like that of Louis XI.; it was the royal power struggling against the feudal oligarchy; but the struggle took a truly Asiatic character of refined cruelty, mingled with orgies and acts of monastic devotion. In order to carry on the struggle more successfully Ivan gave liberties to the towns and later on divided all Russia into two parts—the country as a whole and, on the other hand, what he claimed as his own part of the country (*opritchnina*)—the latter having the right of oppressing the former, peasants and boyars alike. Ivan IV. was the first autocrat in Russia, and he assumed the title of *tsar* (erroneously spelt *Czar*, q.v.), which is the name given in the Russian translations of the Bible to the kings of Judea and the Roman emperors. Contrary to the advice of his boyars, but with the approval of the states-general, he carried on a long and protracted war against Livonia, successful at the beginning, but most disastrous when Livonia was supported by the newly-elected king of Poland, Stephen Bathory. At the same time the khan Devlet Ghirei, crossing the Oka with 120,000 men, appeared before Moscow, and burned its suburbs. The Kremlin only resisted, and the khan retreated ravaging the country and carrying away countless prisoners. By the end of Ivan's reign Siberia (q.v.) was conquered by bands of Cossacks under Yermak, and the English opened the trade by sea with Archangel.

Ivan IV., who had himself killed his eldest son in a fit of rage, left but a feeble-minded son, Feodor (1584-98), during whose reign the boyars recovered their former power. Feodor's brother-in-law, Boris Godunoff, was nominated regent, and the old struggles between rival parties began afresh. Godunoff, though an able administrator, was generally hated by both the boyars and the people of Moscow, and he endeavoured to gain popularity among the minor nobility, in the interests of whom he promulgated (1597) a law which ultimately, especially after the law of 1648, developed into serfdom. Until that time the peasants remained free—nominally, at least. They were free to settle wherever they were offered the most advantageous conditions, and once a year (on St George's day) they were entitled to abandon their farms and to remove elsewhere if they had succeeded in finding better terms, and had contracted no debts with the landowner. Boris Godunoff abolished that right of free removal, thus attaching the peasants to the land, and the institution, developing into full serfdom, became the curse of Russia for the next 270 years. To secure the throne for himself and his dynasty, Godunoff first exiled Feodor and his mother to Uglich, and later on sent assassins to murder the seven years' old child Dmitri in 1591. After Feodor's death the *duma* of boyars proclaimed Boris Godunoff (1598-1605) tsar of Russia, but he reigned six years only.

The most extraordinary thing then happened in Russia. A young man, supposed to be Grigoriy Otrepieff—a runaway monk from a Moscow monastery who had afterwards spent several years among the Zaporogian Cossacks—appeared in Poland under the name of the assassinated Dmitri. The Jesuits and some of the Polish nobility at once supported him; also King Sigismund; and when he appeared, with an army of Polish volunteers, under the walls of a Russian frontier fortress, he was received as the very son of Ivan IV. All over Russia the people rose to support the pretender. The mother of the murdered Dmitri recognised

him as her son, and when Boris Godunoff suddenly died at this juncture, Dmitri was proclaimed tsar; he was received as such at Moscow, and crowned (1605). He returned to the peasants the freedom they had lost under Godunoff; but the people of Russia did not find in him the Russian tsar they expected to find. He was a mere instrument in the hands of the Poles, he married a Pole, and his Polish garrison exasperated the people of Moscow. A revolt headed by Prince Vassili Shouisky (1606-10) broke out. The impostor was murdered, and Shouisky proclaimed tsar by the boyars. But Russia did not recognise him. New impostors appeared and were supported by the revolted peasants, while bands of runaway peasants who had gathered during the preceding decades on the banks of the Don and Dnieper under the name of Cossacks ('free men'), invaded Russia, devastating the provinces, and robbing the nobles, the towns, and the wealthier peasants. Sigismund of Poland, taking advantage of the confusion, invaded Russia, and with the consent of the Moscow boyars proclaimed his son Vladislav tsar; but he preferred to have Russia for himself, and took possession of Moscow (1610). Shouisky was taken to Poland, where he died in a prison.

All this would appear difficult to explain, unless the following be taken into account. Russia by that time was receiving western civilisation from Poland, and the boyars were the first to accept it in appearance, imitating the extravagant life of the Polish nobles, ruining the peasantry, and aiming at an oligarchy of nobles such as they saw in Poland. The great rising of the people of Russia, which began in 1601 under the banner of the false Dmitri, and continued during the next eleven years, was a rising of the toiling masses and small traders against the boyars. But this rising had, at the same time, opened Russia to Polish invasion, and left the whole territory—landlords and peasants alike—at the mercy of predatory gangs of Cossack and Polish robbers. A reaction was inevitable, and it came from the cities supported by the church. A cattle-trader of Nijni-Novgorod, Minin, aroused his fellow-citizens to march for the delivery of Moscow, which was held by the Poles and besieged by the Cossacks. The same movement took place in all Russian cities, and their folk-motes (*vetche*) entered into agreements to levy militias and unite them into one army, and convoked a 'General Council of the Land,' composed of representatives of all classes, at Yaroslavl. Under the leadership of Prince Pojarskiy and Lapunoff they retook Moscow, drove the Poles out of Russia, and the council (*Sobor*), now moving to Moscow, was urged to elect a tsar. The boyars were inclined to elect a Swedish or Polish prince, but the lower orders and the clergy opposed this, and the *Sobor* elected Mikhael Romanoff (1612-45). The boyars finally acquiesced in the hope of maintaining the power under a sixteen years' old tsar; but the *Sobor* remained quasi-permanent at Moscow during the first ten years of Mikhael's reign, and all decisions were issued conjointly in the name of the tsar and of the *Sobor*. Mikhael Romanoff belonged to a family (the ancestors of which had emigrated in olden times from Prussia) which was very popular now in Russia. His father, the Rostoff metropolitan Philarete, who had been sent as an envoy to Poland, was kept imprisoned by the Poles; his uncle had died in prisons under Boris Godunoff; and his grandmother, who was the first wife of Ivan IV., had left a very good memory behind her.

The first years of the reign of Mikhael Romanoff were characterised by a general movement on the part of the Russian towns to crush the peasants'

insurrection and to extirpate the bands of robbers. Peace was obtained from Gustavus Adolphus of Sweden by abandoning Schlüsselburg; but the war against Poland continued, notwithstanding a short armistice. The states-general convoked again (1632 and 1642), freely voted fresh subsidies, but no success was obtained, and the very existence of Russia was menaced when the revolts of the Cossacks of the Dnieper against the Polish nobles changed the face of affairs in favour of Russia.

Under Mikhael's son Alexei (1645-76) the work of modelling Russia into a state continued, and the local administration was entirely reformed. But the revolts of the people began anew, especially since serfdom was enforced by the law elaborated by the states-general of 1648, and the first half of Alexei's reign was marked by a series of popular revolts at Moscow, Nijni, Pskov, and finally in south-east Russia, under Stenko-Razin, when the runaway serfs and the free Cossacks of the Volga rose fiercely against Russia, hanging the landlords, and aiming at 'settling their accounts with the boyars in the Kreml itself.' At the same time came the great disruption (*raskol*) in the church. The patriarch Nikon was striving to acquire in the East the same supremacy as the pope had in the West. Being himself one of the richest serf-owners in Russia, he made a display of extravagant luxury in his life; he surrounded himself with a kind of ecclesiastical court which plundered the lower clergy; he built under Moscow a 'New Jerusalem,' and in processions went preceded by a 'Latin cross' (with one cross-bar only) like the pope. In short, he was considered 'Latin' (i.e. Polish) in all his arrogant behaviour. His attempt at completing the already undertaken revision of the sacred books, into which many errors had crept through illiterate copyists, became the signal of a revolt of the bulk of the nation against the state's 'Latin' Church. A popular church, having priests elected by the parishioners, and taking the 'old faith' for its watchword, was opposed by the people to 'Nikon's Church,' although its followers were pitilessly tortured and exterminated by the state. All great subsequent risings of the peasants (Razin's, Pougatchev's, and many smaller ones) were therefore made under the cross with eight ends (three cross-bars) of the 'old faith.'

Nikon's attempts at subduing the tsar to his arrogant supremacy ended in his deposition and exile, and later on Peter I. abolished even the dignity of patriarch, substituting for it the Holy Synod. Alexei frequently convoked the states-general, first to confirm his accession to the throne (1645), then to revise the existing laws and to compile (1648) a new code (*Sobornoe Ulojenie*), and next (1651 and 1653) to pronounce upon the annexation of Little Russia. Under Alexei Russia finally gained the mastery over Poland, and reconquered Smolensk; but her success was chiefly due to the revolt, under Bogdan Hmelnitsky, of the Orthodox Cossacks of Little Russia, who were terribly oppressed by their Catholic landlords. After seeing the impossibility of resisting Poland single-handed, the Cossacks appealed for protection to Russia, and recognised her supremacy. This event decidedly turned the scales in favour of Russia in the long struggle between the two chief Slav powers. But in order to maintain her rights on the Dnieper Russia had now to sustain a war with Turkey, which continued till after the accession of Feodor (1678-82), when it was terminated (1681) by the treaty of Bakhtchisarai, by which Turkey gave up all claims upon Little Russia. After Feodor's death the states-general chose his half-brother Peter as tsar, but his half-sister Sophia, an able and ambitious princess (see PETER THE GREAT), succeeded in obtaining the

reins of power as princess-regent. She concluded peace with Poland in 1686, made two unsuccessful campaigns against the Tartars of the Crimea; and after an attempt to deprive Peter of his right to the throne, and, this failing, to assassinate him and his mother, she was forced to resign all power and retire to a convent. Nearly a thousand of her accomplices were executed; and Peter (1689-1725) ascended the throne as sole ruler, his half-brother Ivan being allowed to retain the title of tsar conjointly, and to appear as such at public ceremonies, but without any real authority.

The history of Peter I.'s reign is almost entirely his own biography, and it is given under his name, the following remarks being only intended to give a general view of the importance of his reforms.

The powers of the *tsar*, the *duma* of boyars, and the church have already been mentioned above; but since Ivan IV.'s time, and especially since the 'troubled times' of 1601-12, a new power had come into existence—viz. the *Sobor*, or states-general. The *Sobors* consisted of representatives of either 'the whole land' or special classes—merchants or military—or the inhabitants of Moscow only, and they exercised a decided influence upon legislation. But even in Alexei's reign steps were taken towards centralising all powers in the hands of various boards (*prikazy*) corresponding to modern ministries, under the guidance of the *tsar*, and the *Sobors* were convoked less and less frequently. Peter I. totally destroyed the powers of the boyars and the church, and convoked the states-general but once, to condemn his sister Sophia. He proclaimed himself emperor, abolished the rank of patriarch, and introduced, instead of the *duma* and the *Sobor*, a senate, whose members he nominated himself. By transporting his capital to St Petersburg, a city of his own creation, he entirely freed himself from the interference of the boyars, the church, and the people of Moscow, which often made its voice heard by means of rebellions. He ruled with absolute power, supported by men of his own choice. All Russians became in an equal degree his own subjects, though class-distinctions continued to prevail in their mutual relations, and serfdom grew worse and worse, taking all the characters of slavery. Of a standing army under Peter's predecessors only the *Stryeltsy* (military settlements in the suburbs of the cities) and the Cossacks deserved the name. The former were abolished after their revolts in favour of Sophia, and the privileges of the latter were curtailed. A standing army, completed by recruiting, was introduced. The whole administration was reorganised upon German models, or on strongly hierarchical and centralised principles. A secret state police, endowed with extensive powers of imprisonment, torture, and exile, was introduced, and among its victims was Peter's only son, Alexei, convicted of having plotted with the old party against his father. He died under torture. The old taxes by household were superseded by capitation taxes, and formidably increased. Written procedure was introduced in the justice courts, stamp-duties were imposed. Faith was made a state affair, and attendance at church on Sundays and communion once a year was rendered obligatory.

Agriculture and industry were at a low ebb in the tsardom of Moscow. Civilisation and learning, which had been introduced during the federative period, had never recovered the shock they had received from the Mongol invasion. The education even of the higher classes was confined to reading and writing, and the first school for classics and theology only made its appearance during Feodor's reign. Fine arts were limited to architecture and painting (of sacred subjects) after

the Byzantine school. The first newspaper appeared (in Moscow), and the first theatre was established, during the reign of Alexei. The influence of the Mongols left deep traces on the domestic manners and habits of the Russians, among which was the low position of women in domestic life; those of higher rank were completely excluded from social intercourse with the other sex, and were condemned to pass a dull and dreary existence in their 'terems.' Peter I. did his best to improve the state of affairs in all these directions. He organised the army, created mining and manufactures, chiefly for state purposes, imported improved races of cattle, traced and caused to be dug the canals which now are so important for Russia, created schools, chiefly technical, and introduced more social intercourse between the different classes of society, in which women were allotted a share. It must, however, be noted, that in the carrying out of his well-meant schemes he forgot the people for the state, and imposed upon the former the most terrible burdens. Thousands and thousands of his subjects perished in erecting St Petersburg and its fortress and in digging canals, not to say a word of the wars they had to maintain, and the revolts crushed with Asiatic cruelty.

In accordance with the terms of his will, his second wife, Catharine I. (1725-27) succeeded him; but the old or anti-reform party of the nobility supported the claims of the only son of the unfortunate Alexei, Peter II. (1727-30), who soon after obtained the imperial throne. The reigns of both of these sovereigns were occupied with court quarrels and intrigues, Menschikoff (q.v.) during the former, and Dolgorouki during the latter, being the real rulers. On the death of Peter II. the privy-council, setting aside the other descendants of Peter I., conferred the crown on Anna, Duchess of Courland, the daughter of Ivan. Her reign (1730-40) was marked by the predominance of the German party at court, who, unchecked by the weak sovereign, treated Russia as a great emporium of plunder (see *BIRON*). Under their influence Russia restored to Persia her lost Caspian provinces, and was led into a most ruinous war with Turkey. Anna's successor was Ivan (1740-41), the son of her niece, the Duchess of Brunswick, Anna Carlovna; but he was speedily dethroned by Elizabeth (1741-62), the daughter of Peter I., who deprived the German party of the influence it had so shamefully abused, restored the senate to the power with which it had been entrusted by Peter the Great, established a regular system of recruiting, abolished tolls, and increased the duties on imports. Russia gained by the treaty of Abo (1743) a portion of Finland, and took part in the Seven Years' War (q.v.).

Elizabeth's nephew and successor, Peter III. (q.v.; 1762), was a devoted admirer of Frederick the Great of Prussia. His first act on his accession to the throne was to order the Russian army which supported the Austrians against Prussia to join Frederick against the Austrians. Prussia, reduced to the last extremity, was thus saved from dismemberment. At home he abolished the prescriptions of Peter I. which imposed upon each noble the duty of entering the state's service; he abolished the secret state police, gave full liberty to the *raskolniks*, proclaimed an amnesty to the serfs who had revolted against their owners, and proposed to seize the estates of the convents—a measure which Peter I. did not dare to take, and which was partially accomplished subsequently under Catharine II. But he was disliked at the court, and his wife, Catharine II. (1762-96), easily dethroned him. He was arrested and murdered by Catharine's associates.

Under Catharine II. (q.v.) successful wars were carried on against Turkey, Persia, Sweden, and Poland, which largely extended the limits of the empire. The acquisition of the Crimea, which gave Russia a firm footing on the Black Sea, and the first partition of Poland, were two most important steps towards the consolidation of the empire. In home affairs the work of further centralisation was prosecuted. But, notwithstanding Catharine's friendship with the 'Encyclopedists' of France and the excellent ideas expressed both in her correspondence and in various 'Instructions' (*nakazy*), her reign was exceedingly oppressive for the peasants. The rights of the landlords over their serfs were extended; no less than 800,000 free peasants were distributed as serfs among Catharine's favourites; serfdom, abolished in Little Russia by Bogdan Hmelnitsky, was reintroduced there as well as among the Don Cossacks; and once again the whole state was shaken by the impostor Pugatchev, who, supported by the *raskolnik* Ural Cossacks, pitilessly hanged the landlords and officials in east Russia, ravaging the country under the assumed name of Peter III.

Catharine's son and successor, Paul I. (1796-1801), at first, through apprehension of the revolution in France, joined the Austrians and British against France, but soon after capriciously withdrew, and was about to commence war with Britain when his assassination took place. He gave freedom of worship to the 'Old Ritualists,' but recklessly turned free crown peasants into serfs for his favourites. He established a severe censorship of the press, prohibited the introduction of foreign publications, reorganised the secret police, and altogether treated his subjects in the most contemptuous way. A palace conspiracy put an end to his reign and life. His eldest son, Alexander I. (1801-25), was at the outset desirous of peace, but was soon drawn into the vortex of the great struggle with France, in which he played a prominent part. The character of his rule is sketched under his name, and an outline of the warlike operations—the great French invasion of 1812, the burning of Moscow, and the disastrous retreat—is given in the article NAPOLEON. The Holy Alliance (q.v.) and the example of conservative policy set by Austria exercised a pernicious influence on the later part of his reign; and the higher classes, who had looked for the introduction of at least a portion of the liberal institutions they had seen and admired in western Europe, became so dissatisfied that, when his youngest brother, Nicholas I. (1825-55), from whom they had nothing to hope, succeeded, they broke out into open rebellion, which was speedily crushed. A full stop was now put to the intellectual development of Russia. Wars were declared with Persia and Turkey; and a long and deadly struggle commenced with the Caucasian mountaineers. The cession of Erivan and Nahitchevan by Persia, of the plain of the Kuban, of the protectorate of the Danubian principalities, and of the free right of navigation of the Black Sea, the Dardanelles, and the Danube by Turkey only induced him to further prosecute his aim of conquering for Russia a free issue from the Black Sea in the Dardanelles. In 1830 he converted Poland (q.v.) into a Russian province: in 1849 he aided Austria in quelling the insurrection of the Magyars; and in 1853 he began a war with Turkey which became the Crimean War (q.v.), and in which, though the allies, Britain, France, and Sardinia, did not obtain any decided success, Russia suffered immense loss.

The accession of Nicholas's son, Alexander II. (1855-81)—one of whose first acts was the conclusion of the peace of Paris (1856), by which Russia lost the right of navigation on the Danube, a

strip of territory to the north of that river, and the right of keeping a navy in the Black Sea—the signal for a general revival of intellectual life in Russia. Public opinion broke the bonds of censorship and constrained the well-meaning but weak emperor to carry through the long-expected abolition of serfdom. It was abolished in 1861 after many hesitations. Corporal punishment was abolished and the judicial organisation was completely revised (1864). Unhappily the insurrection of Poland (1863-64) put an end to the reform period. The old serf-owners' party took again upper hand, and the last great reform, by which self-government (*zemstvo*) was granted to the provinces (1866), did not receive the importance which it formerly was proposed to give to it, as a preparatory step to constitutional government. Obligatory military service for all Russians was introduced in 1874.

The insurrection in Poland was suppressed with extreme severity; and in 1868 the last relics of Polish independence disappeared in the thorough incorporation of the kingdom with the Russian empire. The subjugation of the Caucasus was completed in 1859. Russian supremacy was established over all the states of Turkestan. In 1876 the administration of the Baltic Provinces was merged in that of the central government; but the autonomy of Finland was respected and even extended. In 1870, during the Franco-German war, Russia declared that she considered herself bound no more to the obligation of keeping no navy in the Black Sea, and in a conference at London in 1871 her claims were recognised. The misgovernment of her Christian subjects by Turkey, and her cruel suppression of incipient rebellion in 1876, led to a conference of the European Powers at Constantinople. Turkey rejected the proposals made by the conference with a view to the better administration of the subject provinces; and Russia, to enforce these concessions on Turkey, declared war in April 1877. At first the Russian progress was rapid; but the energy displayed by the Turks during the summer, and the resolute defence of Plevna by Osman Pasha from July till December, checked the progress of the Russian army. During the winter, however, she crossed the Balkans, and her vanguard reaching the Sea of Marmora, stood in view of Constantinople. The armistice signed in January 1878 was followed in March by the treaty of San Stefano; and after diplomatic difficulties that seemed for a time not unlikely to issue in war between Russia and England, a Congress of the Great Powers met at Berlin in June 1878, sanctioned the re-arrangement of the Ottoman empire explained under the article TURKEY, and the cession to Russia of the part of Bessarabia given to Moldavia in 1856, as also of the port of Batoum, of Kars, and of Ardahan. The growth of revolutionary discontent (see NIHILISM), leading to severe repressive measures, has been marked by several murders of high officials; and on March 13, 1881, Alexander II. was killed by the revolutionists. Panslavism (q.v.) has influenced Russian thought and policy to some extent.

The reign of Alexander III. (1881-94) was in the main characterised, in contrast to the liberal reforms of the last reign, by reactionary steps; though strenuous efforts were made to put an end to the colossal plundering of state money and appropriation of state lands common in the last half of the reign of Alexander II. The self-government of the *zemstvo* has been limited and put under the authority of the nobility: the justices of peace were abolished, and an attempt at reintroducing manorial rights has been made. The redemption taxes imposed upon the liberated serfs were slightly

reduced. Oppressive measures led to wholesale and compulsory emigration of Jews, and the autonomy of Finland was curtailed. Under Nicholas II., who succeeded in 1894, the administration has been somewhat more liberal. The French alliance has been cherished, the Concert of Europe adhered to not without hesitation, and effective intervention brought to bear on China; and in 1898 Manchuria (q.v.) became mainly a Russian province, intersected by a branch of the great Siberian railway, and Talienwan and Port Arthur Russian ports. The Emperor summoned a conference of the powers in 1899, with the view of checking the increase of armaments.

See works on Russia, the land and people, by Sir D. M. Wallace (1877; new ed. 1888), Sutherland Edwards (1879), Geddie (1881), Morfill (1882), A. J. C. Hare (1888), Stepiak (Nihilist, 1885-88), Tikhomirov (1887), and Leroy-Beaulieu (trans. 1893-4). For history, see the articles on the principal Russian sovereigns, notably those on Peter I., Catharine I. and II., Paul, Alexander I. and II., and Nicholas; also the articles on Bagration, Barclay de Tolly, Gortschakoff, Kutusoff, Orloff, Potemkin, Suvarof, &c.; on Charles XII. of Sweden; and those on Nihilism, Panslavism, and Poland. And consult besides the Russian historians Karamzin, Soloviev, Kostomarov, Bestuzhef-Riumin, &c.; Rambaud, *History of Russia* (1878; Eng. trans. 1879; 2d ed. 1887); the shorter history by Morfill (1890); Sutherland Edwards, *The Romanoffs* (1890); and Howorth's *History of the Mongols* (1876-88).

Language and Literature.—The Russian language belongs to the eastern branch of the Slavonic family. It is extremely copious, and resembles ancient Greek in being both synthetical and analytical; thus it has seven cases, and yet in no language are the prepositions used with more delicate precision. It has lost the imperfect and aorist, which are to be found in old Slavonic, but has preserved the great Slavonic feature of the *aspects* of the verbs. Although Russia was under Mongolian rule for upwards of two centuries, yet the Tartar words are few, and are employed only for articles of dress and some other things of everyday use. A few Latin and French words have been incorporated, but the tendency at the present time is to eject foreignisms as much as possible. The language has great capabilities for forming compounds and derivatives. There are many dialects, but the predominant literary language is that of Moscow. The first Russian grammar was published at Oxford in 1696 by Henry Ludolf; in Russian may be mentioned those of Vostokov (10th ed. 1859) and Buslaev, *Historical Grammar of the Russian Language* (1875). For understanding the principles of Russian philology we must betake ourselves to the great work of Miklosich, *Vergleichende Grammatik der Slavischen Sprachen* (4 vols. 1879). The best dictionaries are those of the Russian Academy (Russe-Français, Makarov, 1874; new ed. 1892; Russian-English, Alexandrov, 1879). In English there are Russian grammars by Morfill (1889) and Riola (new ed. 1890).

The earliest Russian literature consists of the *bilini*, or legendary poems, which were orally communicated till they were committed to writing in modern times. These are divided into cycles—e.g. those of Vladimir, the prince of Kieff, of Novgorod, and of Moscow. There are large collections of them, and also of the *skazki*, or popular tales. The earliest manuscript which has been preserved of anything which can be said to be distinctly Russian is the codex of the Ostromir Gospels, written at Novgorod in the years 1056-57 by the deacon Gregory, for Ostromir the *posadnik* of Novgorod. After this we get *sborniki*, or collections of miscellaneous works, such as those compiled for the Grand-duke Sviatoslav, and some sermons by Luke, bishop of Novgorod, and others. With the

so-called chronicle of Nestor begins the series of Russian annalists. Nestor is supposed to have died about 1114. We have also chronicles of separate parts of Russia, such as Novgorod, Kieff, Pskov, and Volhynia. There is also the *Pouchenie*, or book of instruction, of Vladimir Monomakh, and the prose-poem called 'The Story of the Expedition of Igor' (*Stvo o Polku Igoreve*). The original manuscript of this production was burned in the fire at Moscow in 1812. Important are the Russian legal codes, the *Ruskaya Pravda* of Yaroslav in the 12th century, and the *sudebniki* of Ivan III. and IV. In 1504 the first Russian book was printed at Moscow. To the reign of Ivan IV. (the Terrible) belongs the 'Book of Household Management,' assigned to the priest Sylvester. We also have the *Stoglav*, or book of church regulations, issued by Ivan in 1551. At the beginning of the 17th century we have the chronicle of Sergius Kubasov, and towards the close of the same century the interesting work of Kotishikhin on Russia, which was discovered in manuscript in 1840. To the same period belong the writings of Ivan Krizhanich, who is generally reputed to be the father of Panslavism, and the poems and plays of Simeon Polotski (1628-90), who was the tutor to the children of the Emperor Alexei. In the reign of the latter monarch the Russians got back Kieff, which had long been in the hands of the Poles, and thus the culture of the West became accessible to them. With Polotski may be said to terminate the first period of Russian literature with its Byzantine influence.

The second period was to be commenced by the reforming measures of Peter the Great; and Russia now began to look to the West for her models. He established schools, and founded the celebrated Academy of St Petersburg. The first Russian poet of the new era was Antioch Kantemir (1708-44), who wrote some good satires in the style of Pope and Boileau. But the writer that exercised the greatest influence on Russian literature was Michael Lomonosov, who established the supremacy of the dialect of Great Russia. He was an indefatigable worker in many branches of learning, and earned his chief laurels in natural science. Trediakovski (1683-1769) did something for Russian versification, but was hardly more than a poetaster. Basil Tatistchev (1686-1750) laid the foundations of historical writing, as opposed to the mere chronicler, and Sumarokov (1718-77) those of the drama. A real national comedy was created by Denis Von Visin (1745-92) and Kniazhin also wrote plays with ability. Michael Kheraskov (1733-1801) composed two large epics, the *Rossiada* in twelve books, and *Vladimir* in eighteen, but they have now almost sunk into oblivion. The *Dushenka* of Bogdanovich (1743-1803) was at one time very popular. With Khemnitser begins the series of Russian fabulists. Gabriel Derzhavin (q.v.; 1743-1816) was the great poet of the age of Catharine. He celebrated her glories in many spirited odes. Prose literature was more slow in developing itself. An elegant style can hardly be said to have existed before the time of Nicholas Karamzin (q.v.; 1766-1826), renowned for his history of Russia. On the accession of Alexander I. literature advanced rapidly. The founder of the romantic school of poetry was Basil Zhukovski, who, although he wrote but few original pieces, was beneficial to his countrymen by his translations from English and German. Other poets of the period were Dmitriev and Batiushkov. The most brilliant author, however, of the new school was Alexander Pushkin (q.v.), the greatest poet whom Russia has yet produced, who has left some charming narratives in verse, and other works. The fables of Ivan

Krilof (1768-1844) have always enjoyed considerable reputation among the Russians. A clever writer of comedy was Gribojedov, killed at Teheran in 1829. Since the death of Pushkin the Russians have had Michael Lermontoff (q.v.; 1814-41), author of the *Demon* and some graceful lyrics, and Nicholas Nekrasov, who died in 1877. There are many minor poets; thus Koltsov (1809-42) wrote some of the most national lyrics which have appeared in Russia. Among novelists, the Russians have produced Zagoskin and Lazhechnikov, who imitated Scott; but the foundation of the realistic school among them was begun by Nicholas Gogol (q.v.), one of the most powerful writers of his country. Dostoieffsky (q.v.) and Pisemski, who died in 1881, were also celebrated as novelists; but the first to gain a European fame was Ivan Turgenief (q.v.), who died in 1883. Count Leo Tolstoi (q.v.), though two months older than Turgenief, survived him; he is the author of 'War and Peace' (*Voyna i Mir*) and other well-known works. It is in romantic fiction that the Russians have gained their greatest laurels. A celebrated political writer was Alexander Herzen (q.v.), who died at Paris in 1870. Great attention has been paid in Russia to the collection of the national songs (*bilins*), tales, folklore, and proverbs; and among them the works of Sakharov, Ribnikov, and Afanasiev are especially to be mentioned. In history the Russians have produced some eminent names: Karamzin was followed by Ustrialov and Pogodin; and later we have the great work on Russian history in upwards of 28 volumes by Sergius Solovieff, which he did not live to complete, and the still unfinished production of Professor Bestuzhef-Riumin. The Russians have produced few writers on philosophy. In philology we have the names of Vostokov, Sreznevski, and Buslaev.

See Reinhold, *Geschichte der Russischen Literatur* (1886); P. Polevoi, *Istoria Russkoi Literaturi v ocherkakh i biographiakh* ('History of Russian Literature in Sketches and Biographies,' 1872); Talvi, *View of Literature of the Slavonic Nations* (1850); Courrière, *Histoire de la Littérature Contemporaine en Russie* (Paris, 1875); and Morfill, *Russia* (1890).

Russia Leather. See LEATHER, p. 551.

Russniaks. See RUTHENIANS.

Rust. Neither malleable iron, nor steel, nor cast-iron can be exposed to a moist atmosphere for more than a brief time without becoming rusted. But malleable or wrought iron, being nearly pure iron, rusts rather more readily than either of the others, which essentially contain a certain proportion of carbon (see IRON and STEEL). In a paper read before the Iron and Steel Institute in 1888 Professor Crum Brown explains the chemical processes involved in the rusting of iron. He says that, when a drop of rain falls on a clean bright surface of iron, for a short time the drop remains clear, showing the bright surface of the iron through it. But soon a greenish precipitate forms in the drop, and this rapidly becomes reddish brown. The brown precipitate (peroxide of iron or rust) does not adhere to the iron, but is suspended in the water, and becomes a loosely adherent coating only when the water has evaporated. He further states that iron remains quite free from rust in an atmosphere containing oxygen, carbonic acid, and water vapour (all present in a normal atmosphere except water vapour, which is rarely absent) as long as the water vapour does not condense as liquid water on the surface of the iron. Owing to the hygroscopic character of rust, when it once forms on iron the rusting process will continue in an atmosphere not saturated with water vapour. In other words, the iron in this case will continue rusting in an atmosphere in which a piece

of clean iron will not rust, because liquid water will condense on rust when it will not on bright iron. The fact that under ordinary atmospheric conditions the rusting process, when once begun, continues, has been long known. It follows that it is much easier to prevent the first formation of rust than to stop the process.

It is customary to coat with oil paint all kinds of ironwork which are to be exposed to the weather, and this is usually a sufficient protection. But paint is liable to scale off, so that it is necessary to recoat the iron at longer or shorter intervals. A light iron fence, for example, would not long escape destruction by rusting if it were not frequently painted. It is, however, usual to 'galvanise' wire-work and thin sheets of iron, as the zinc coating retards oxidation. A coating of tin also protects the surface of iron from rusting, but it would appear that for this purpose it cannot be so much relied upon as zinc. Japanning (q.v.) is another way of preserving iron. The iron and steel plates forming the sides of ships receive four or five coats of a paint composed of red lead and boiled linseed-oil to protect them from the corrosive action of seawater, and the sides of these ships are generally repainted after a long voyage. Some of our light-houses have water-tanks constructed of iron which is not only galvanised, but is also painted with three coats of this red lead paint above the zinc coating. The patent paints depend for their efficiency on the red lead and boiled oil in them. Unlike the peroxide, the magnetic oxide of iron forms an adherent coating to the metal, and only when it is detached can water gain access to the iron beneath it. In 1878 a patent (No. 1280) was taken out by G. & A. Bower for a process of producing a thin film of magnetic oxide on iron articles to protect them from rusting, but the colour of this oxide, which somewhat resembles that of the metal itself, is not attractive. In the comparatively dry atmosphere of occupied rooms the bright surface of iron or steel objects will often keep many years without rusting. Where such objects are care should be taken to keep away from them all volatile corrosive acids, such as nitric, hydrochloric, or acetic acid, or bleaching powder (chloride of lime). Polished surfaces of iron are often coated with tallow mixed with a little white lead for their temporary protection while they are being conveyed from place to place, but this sometimes fails to keep away rust. A more recent and better plan is to coat the bright iron with some varnish soluble in naphtha or paraffin-oil—Brunswick black, for example. A mixture of common rosin with a little pure olive-oil and spirits of turpentine has also been found to be a good preservative in such cases. Iron immersed in an alkaline solution does not rust unless it is very dilute. Very delicate steel instruments are often protected from the action of moist air by placing them in drawers or cases along with chloride of calcium or lime hydrate, but as these substances absorb moisture and swell they require to be occasionally looked at. When bright iron or steel objects are already partially rusted, the rust, if not very deep into the metal, may be rubbed off with paraffin-oil, which contains no oxygen. Should this fail, a rub with fine emery will be necessary. Iron rust stains on linen or cotton are usually removed either with oxalic acid or binoxalate of potash (salt of sorrel). The fabric should be well washed after treatment with any of these substances.

Rust, the common name of *Trichobasis rubigo vera*, a parasitic fungus of the natural order Pucciniae, which preys upon the leaves, glumes, and stalks of cereals and other grasses. It has been supposed to be a mere condition or stage of

Puccinia graminis, but this is not fully borne out by closer inquiry. Rust does not appear to be very injurious so long as its attack is confined to the leaves only, but it becomes a formidable pest when it attacks the inflorescence or ear; the more so because no effectual remedy can be suggested for it. Every *protospore* is shed before the grain is ripe, therefore steeping the seed is of no avail. The application of any dressing to the soil appears to be equally useless. White wheat is more subject to be attacked by it than red, and some varieties are hardly ever entirely free from it. The use of rank manures is said to induce or aggravate the disease.

Rustam. See FIRDAUSI.

Rustchuk, a town of Bulgaria, stands on the south bank of the Danube, opposite Giurgevo, 140 miles by rail NW. of Varna (on the Black Sea) and 40 S. by W. of Bucharest. It has numerous churches and mosques, and manufactures cloth, shoes, pottery, gold and silver ornaments, and furniture. Owing to its situation it possessed, until its fortifications were dismantled after 1877, considerable strategic importance. It was captured by the Russians in 1810 and 1877, and played a prominent part in the Russo-Turkish wars of 1773-90 and 1853-54. Pop. (1893) 28,121.

Rustic Work is the name of that kind of masonry in which the various stones or courses are marked at the joints by splays or recesses. The surface of the stone is sometimes left rough, and sometimes polished or otherwise dressed. Rustication is chiefly used in classical or Italian architecture, although rustic Quoins (q.v.) are often used in rough Gothic work. In the figure *a* and *b* show

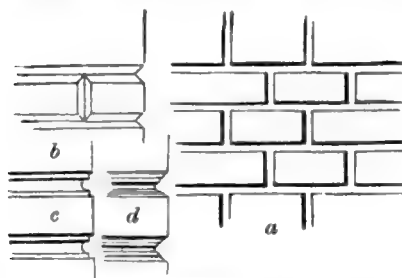

Rustication.

forms of rustication usually applied to surfaces, *c* and *d* show rustic quoins with mouldings on the angles.

Rutaceae, a natural order of exogenous plants, consisting mostly of perennial or suffruticose species rarely herbaceous. They are all found in the temperate regions of the northern hemisphere, and are abundant along the shores of the Mediterranean. A bitter taste and powerful odour are general characteristics. Rue (q.v.) is a familiar example of the order.

Rutebeuf, or RUSTEBEUF, a great 13th-century trouvère, of whose life we know but little, the dates of his birth and death being both unknown. His earliest extant poems are anterior to the final crusade of St Louis; his latest belong to the close of the reign of Philippe le Hardi. He lived a Bohemian life in Paris, amid poverty, debt, and constant distress, his miseries the fruit of an easy temper, lavish habits, a passion for gambling, and an unhappy marriage. His poems include *chansons*, satiric and religious, but not amatory; *complaintes* of death, in the name of contemporary great men; animal and moral allegories; dramatic monologues, among them the *Miracle de Théophile*, a clever

drama of a compact concluded with the devil, from the consequences of which the victim is saved by the Virgin; metrical lives of St Mary of Egypt and St Elizabeth of Hungary; and fabliaux, full of honest gaiety. Rutebeuf was inspired by the crusading fever, and took part in the great quarrel between the Dominicans and the regular clergy in the university of Paris, some of his best work being his satires against the religious orders, the mendicant friars, Dominicans and Minorites, and indeed all clerics, students alone excepted. His most striking qualities are strength, spirit, and colour, and some of his satires reveal a touching note of personality that reminds the reader of Villon.

His poems were edited by A. Kressner (Wolfenbüttel, 1885). See the study by Léon Clédat (1891) in *Les Grands Ecrivains Français*.

Ruten, a Palestinian people, Aramæan or at least Semitic, with whom the Egyptians waged war under the 18th and 19th dynasties. See EGYPT, Vol. IV. p. 240.

Ruth, BOOK OF. The four chapters of this canonical book tell how Ruth, a young Moabitess, after the early death of her Hebrew husband Mahlon, for the sake of her mother-in-law Naomi came to settle in Bethlehem, and there became the wife of a 'near kinsman' (*gôêl*), Boaz, and the mother of Obed, grandfather of king David. The story is placed 'in the days when the judges judged' (i. 1), about a century before the time of David; but on its own showing it was not written till long after the events it describes (iv. 7). How long afterwards is a question on which critics are not agreed; most of them consider it to be exilic (Ewald) or post-exilic (Bertheau, Wellhausen, Kuenen), mainly on the linguistic and genealogical evidence; but Driver (*Introd. to Old Testament*, 1891) thinks that the general beauty and purity of the style, which stand on a level with the best parts of Samuel, point rather to a date, which he does not seek to fix more definitely, before the exile. That the book was not received into the canon till a very long time after the captivity is shown by its place in the original Hebrew, where it occurs as one of the Hagiographa or 'writings' (see BIBLE), standing second among the five Megilloth or Festal Rolls, between Canticles and Lamentations, a position which proves that it did not become canonical till after the series of 'former prophets,' extending from Joshua to 2 Kings, had been finally closed. In the Septuagint, however, which gives it the place it claims in the historical order, it comes between Judges and Samuel, and the same order is observed in the Vulgate and in the English Authorised Version. That Josephus also must have reckoned it as an appendix to Judges is shown by his enumeration of the books of the Old Testament as numbering only twenty-two. The purpose of the book has been variously explained. Some think that it was intended to inculcate the duty of Levirate marriage (Deut. xxv. 5-10, and see MARRIAGE); to this theory it is perhaps enough to reply that Boaz was not Mahlon's brother, and that David was never reckoned as the descendant of Mahlon. But the story undoubtedly has a bearing on the rights, duties, and privileges of *gôêl*im or 'near kinsmen,' if these be taken in a somewhat wider sense. Others will have it that with the framers of the canon the interest of the book was chiefly genealogical. It certainly supplements the genealogy of David as given in the older books; in 1 Samuel, though relations with Moab are alluded to (xxii. 3), his ancestry is not traced beyond Jesse, and that the tendency of later ages was to greater amplification is shown incidentally by Matt. i. 5. But perhaps this little idyll of upright happy life

in the good old God-fearing times, set forth with a simplicity and directness the charm of which no one can fail to feel, does not need any special vindication of its claim to rank with the narratives of Genesis, Judges, or Kings.

See the Old Testament introductions, especially those of Reuss, De Wette-Schrader, Bleek-Welhausen, and Driver; also the commentaries on Judges and Ruth by Bertheaux and by Keil, that in the *Speaker's Commentary*, and others.

Ruthenians, a branch of the Little Russian division of the Slav race, dwell on both sides of the Carpathians, in Galicia and north-eastern Hungary, about 2,800,000 in the former and some 360,000 in the latter region. They are of medium stature, but somewhat slim in build. Nevertheless they make hardy farmers, herdsmen, wood-cutters, and charcoal-burners—their favourite occupations. For various reasons—great subdivision of the soil, years of subjection to the Polish nobles, the extortion of the Jews, addiction to drink, and the lack of industries, though the house industries flourish—they are sunk in great poverty. The clergy of the Greek United Church, to which they are greatly devoted, are their intellectual and political leaders. The people cling to traditional usages and customs, and have a leaning to fatalism and melancholy. Since 1848 the native language has begun to take vigorous root again, and to blossom out into a literature. See the article SLAVS; Szuski, *Die Polen und Ruthenen in Galicien* (1882); and Kupczanko, *Die Schicksale der Ruthenen* (1887).

Ruthenium (sym. Ru; atom. wt. 103·5; sp. gr. 12·3) is a metal discovered in 1843 by Claus in the ore of platinum. It forms no fewer than four different oxides. Of these the tetroxide, RuO₄, is remarkable for its volatility, boiling at a little above 100° C. For details regarding the metal, which is of no practical importance, the reader may consult Deville and Debray's *Memoir on Platinum and its Ores*.

Rutherford, SAMUEL, Scottish preacher and divine, was born at the hamlet of Nisbet, near Jedburgh, about 1600. He attended school at Jedburgh, and entered Edinburgh College in 1617, obtained a town bursary in 1618, and took his M.A. degree in 1621. Two years afterwards his extraordinary talent led to his appointment as regent or professor of Humanity, but an antenatal irregularity with his wife caused his resignation in 1626, when he turned his attention to theological study. Through the influence of Gordon of Kenmure, afterwards Viscount Kenmure, he settled as minister of Anwoth in 1627. Here it was his habit to rise at three A.M. for study and prayer, and of his ministry it has been said that he was always praying, always preaching, always visiting the sick, always catechising, and always writing and studying. Though he had a kind of *skreigh* in his voice, Wodrow says he was 'one of the most moving and affectionate preachers in his time, or perhaps in any age of the church.' Here he began that correspondence with his godly friends, chiefly in Galloway and Ayrshire, which made him beloved, useful, and famous, and which earned the title when published of being 'the most seraphic book in our literature.' 'Hold off the Bible,' said Baxter, 'such a book the world never saw the like;' while Mr Spurgeon has pronounced it 'the nearest thing to inspiration which can be found in all the writings of mere man.' In 1636 his *Exercitationes de Gratia* came out at Amsterdam, a book directed against the Arminians; a second edition appeared in the same year, and he was invited to fill a Divinity chair in Holland. Because of this work and non-compliance with

Episcopal ceremonies, he was summoned before the High Commission Court at Wigtown on July 27, 1636, deprived of his ministerial office, and banished to Aberdeen. Here he remained from September 1636 to February 1638, writing letters, disputing with Episcopalians, and bewailing his 'dumb Sabbaths.' He was restored to Anwoth, but was appointed by the Assembly professor of Divinity at St Andrews in 1639, became colleague to Robert Blair in the church of St Andrews, and afterwards principal of the New College (1647). Here he was as industrious as ever, performing the duties of both preacher and professor. In 1643 he was sent to the Westminster Assembly as a commissioner from the Church of Scotland, and there is a draft of a *Shorter Catechism* in his handwriting in Edinburgh University Library. During his four years' attendance he seems to have been prominent enough to be singled out for mention by Milton. His *Due Right of Presbyteries* (1644), *Lex Rex* (1644), *Trial and Triumph of Faith* (1645), *Christ Dying and Drawing Sinners to Himself* (1647) belong to this period. Rutherford's *Lex Rex* was conceived in too bold a spirit of freedom for the government of Charles II.; it was burned by the hangman in Edinburgh and by Sharpe at St Andrews in 1661. Its author was deposed from all his offices, and summoned to answer a charge of high-treason at next parliament. Rutherford received the citation on his death-bed, and sent answer, 'I beehove to obey my first summons,' and went to a higher tribunal on 29th March 1661 (not 20th March, as his tombstone states); he was buried at St Andrews. There is a monument to his memory at Anwoth. No portrait of Rutherford exists, but he has been described as a 'little fair man' with 'two quick eyes;' when he walked he held his face upward. He was extremely charitable in private, and was much looked up to and consulted in matters of personal religion. Livingston, who knew him well, said 'he had most sharp piercing wit and fruitful invention and solid judgment.' He was twice married, and of seven children by his second wife, one daughter alone survived him. No divine in the first half of the 17th century has left a greater reputation for sanctity. He was twice offered a professor's chair in Holland. Freedom and breadth theologically, along with hardness and narrowness ecclesiastically, meet in Rutherford's published works.

Rutherford's religious genius is seen at its highest in his *Letters*, which, to the number of 284, were collected and published under the title of *Joshua Redivivus* by his secretary M'Ward (Rotterdam, 1664). A third edition in 1675 had 68 additional letters. Over twenty-five different editions have since appeared, the best being that by Andrew A. Bonar, D.D., with biographical sketch of his life and notes regarding his correspondents (Edin. 1891). Sixteen works, controversial or theological, were issued in his lifetime; his *Lex Rex*, dealing with the prerogative of king and people, is as keenly logical and controversial as his letters are unworldly and full of sweetness, fancy, and spiritual life. Among his posthumous works are *Twelve Communion Sermons* (1876), and *Quaint Sermons*, edited by Bonar (1885).

See Taylor Innes in the *Evangelical Succession Lectures*; M'Adam Muir in the *St Giles' Lectures*; Dr Whyte's *Lectures* (1894); Livingston's *Characteristics*; and Lives by Murray (1828) and Thomson (1884). For the scandal of his youth, see the Edinburgh Town Council Records of date 3d February 1626.

Rutherglen (popularly *Ruglen*), a town in Lanarkshire, on the Clyde, 3 miles SE. of Glasgow, with whose eastern extremity it is connected by a bridge, built in 1890-91 at a cost of £29,000. It consists of one long wide street, with several narrow streets branching off at right angles; and its principal building is a handsome town-hall (1862). In ancient times Rutherglen was a place

of much importance, carrying on a large traffic on the river, and embracing great part of Glasgow within its municipal boundaries. It was the seat of a royal castle, which was captured by Edward Bruce about 1313, burned by Moray in 1568, and finally demolished in the 18th century. At Rutherglen, on 29th May 1679, the Covenanters published a 'Declaration and Testimony of the true Presbyterian Party in Scotland'—the prelude to Drumclog and Bothwell Bridge. The trade is now mainly dependent upon that of Glasgow, and its inhabitants are employed in the mills, print, chemical, and dye-works, and collieries of the burgh and vicinity. A royal burgh since 1126, it unites with Kilmarnock, &c. to return one member to parliament. Pop. (1831) 4741; (1861) 8062; (1891) 13,061. See Ure's *History of Rutherglen* (1793).

Ruthin, a town of Denbighshire, North Wales, on the Clwyd, 8 miles SSE. of Denbigh by rail. The 13th-century castle which gave it name (Cym. *rhyd-din*, 'red fortress') surrendered in 1646 to the Roundheads, and was afterwards dismantled, part of its site being now occupied by a castellated mansion. A grammar-school, founded by Dean Goodman of Westminster in 1594, was reconstituted in 1881; and there are also an interesting collegiate church, a county hall, a corn exchange, &c. Chartered by Henry VII. in 1507, Ruthin unites with Denbigh, &c. to return one member. Pop. (1851) 3373; (1891) 2760. See Newcome's *Castle and Town of Ruthin* (2d ed. 1836).

Ruthven, RAID OF, a Scottish conspiracy contrived and executed in 1582 by William, first Earl of Gowrie, father of the chief actor in the Gowrie Conspiracy (q.v.), in conjunction with Lord Lyndsay of the Byres, the Earl of Mar, and the Master of Glamis. The boy-king James VI., then under the influence of Lennox and Arran, was invited to Gowrie's seat, Castle Ruthven (pron. *Riven*) or Huntingtower, 3 miles WNW. of Perth, to hunt; but the next morning (23d August) he found himself a prisoner in the midst of a thousand armed men. He tried to get out, but the Master of Glamis detained him, and said when he wept, 'Better bairns greet than bearded men.' Arran was thrown into prison, and Lennox retired to France, where he died broken-hearted. The Presbyterian clergy warmly espoused the cause of the Ruthven lords, who received the thanks of the General Assembly, and full indemnity from a Convention of Estates. Nearly a year elapsed before the king regained his freedom. His feigned acquiescence in his position led the confederates so to relax their vigilance that, on 20th May 1583, he was enabled to escape from Falkland to the castle of St Andrews. Gowrie and the other lords made their submission, and were pardoned; but soon afterwards a royal proclamation branded their enterprise as treason. Gowrie was commanded to leave Scotland; but in April 1584, while waiting for a vessel at Dundee, he was drawn into a conspiracy to surprise Stirling Castle, for which he was tried and executed.

Ruthwell, a Dumfriesshire coast parish, 9 miles ESE. of Dumfries. Its famous sandstone cross, 17½ feet high, bears carvings in front and behind of the Crucifixion, Annunciation, &c., with corresponding Latin inscriptions in the Roman character, and on the sides of scroll-work, with runic verses from 'The Dream of the Holy Rood' (see *Cædmon*). Dating possibly from about 680 A.D., the cross was cast down and broken in 1642 as a monument of idolatry; but in 1802 was re-erected in the manse garden by the Rev. Henry Duncan (q.v.), and in 1887 removed to an apse adjoining the church. See Dr J. Anderson's *Scotland in Early Christian Times* (2d series, 1881).

Rutile (Lat. *rutilus*, 'reddish'), a mineral, which is essentially *Oxide of Titanium* or *Titanic Acid*, although generally containing a little peroxide of iron. It crystallises in tetragonal forms, generally as slender four-sided or six-sided prisms and needles. Now and again it occurs massive. It varies in colour from yellow to brown and red. Sometimes it presents a curious interlaced character, known as *Sagenite*. It not infrequently occurs as an endomorph in rock-crystal. As a rock-forming mineral it is not of much importance, but occurs generally as minute granules and aggregates or prismatic crystals in schistose rocks, gabbro, and other rocks. Massive rutile is used to give a yellow colour to porcelain.

Rutlam, a small Indian native state in the Western Malwa agency (see CENTRAL INDIA), with a pop. of 100,000. The capital, Rutlam, is a great opium mart, and has a college; pop. 31,000.

Rutland, the smallest county in England, bounded by Leicester, Lincoln, and Northampton shires. It measures 18 by 15 miles, and has an area of 150 sq. m. or 95,805 acres. The Guash or Wash, flowing to the Welland (which traces the south-east boundary), divides it into two portions—the northern a somewhat elevated tableland, while the southern consists of a number of valleys running east and west, and separated by low hills. Limestone is plentiful; and the soil is mostly a deep clay. Half the whole area is permanent pasture, and woods occupy some 3000 acres. Towns are Oakham and Uppingham, and there are fifty-one parishes. Rutland gives the title of duke to the family of Manners (q.v.). Its representation was reduced to one in 1885. Pop. (1801) 16,380; (1861) 21,861; (1891) 20,659. See Murray's *Northamptonshire and Rutland* (1878).

Rutland, capital of Rutland county, Vermont, is on Otter Creek, close to the Green Mountains, and 67 miles by rail SSE. of Burlington. The chief industry is the quarrying and working of marble; the place has also several foundries and railroad shops, and contains the state work-house. From 1784 to 1804 Rutland was one of the capitals of Vermont. Pop. (1880) 7502; (1890) 8239; of township (1880) 12,149; (1890) 11,760.

Rütli, or GRÜTLI, a meadow on the west side of the southern arm of Lake Lucerne, the traditional cradle of Swiss independence: here the representatives of the three cantons, Uri, Schwyz, and Unterwalden, took the oath (1307) to drive out the Austrians. It is national property, having been purchased with the pence of Swiss school-children, and is adorned with a monument (1860) to Schiller, the author of *Wilhelm Tell*, and with another (1884) in commemoration of the oath.

Ruvo in Apulia, a cathedral city of Southern Italy, 22 miles W. of Bari. Here, on the site of the Roman Rubi, numerous ancient vases and sepulchral treasures have been dug up. Pop. 17,728.

Ruwenzori, a mountain in the centre of Africa, just north of the Equator, between Lakes Albert Nyanza and Albert Edward Nyanza. It was seen by Baker in 1871 and passed by Stanley in 1888, and reaches 19,000 feet in altitude. Its summit is covered with perpetual snow. Stanley identifies this peak and some neighbouring ones (Mount Gordon Bennett, Mackinnon Peak) with the Mountains of the Moon of ancient geographers.

Ruysbroek, JOHANNES, Flemish mystic, born at Ruysbroek near Brussels in 1293, was vicar of S. Gudule in Brussels, but in 1353 withdrew to the Augustinian monastery of Groenendael near Waterloo, and died its prior in 1381. His mysticism, mainly derived from Eckhart (q.v.),

but directed in the channels of practical charity, gained for him the title of *Doctor ecstasticus*. Gerhard Groot (q.v.) was his friend. Ruysbroek wrote in Latin and in Flemish; his works were published in Latin in 1552, and in German in 1701. See Lives by Engelhardt (Erlangen, 1838), Ch. Schmidt (Strasburg, 1859), Otterloo (Amsterdam, 1874), and Maeterlinck (trans. 1894).

Ruysdael, or **RUÏSDAEL**, **JAKOB**, the greatest landscape-painter of the Dutch school, was born at Haarlem about 1628. In 1648 he was enrolled a member of the guild of St Luke at Haarlem, and in 1659 was granted the freedom of the city of Amsterdam. He died in the almshouse of Haarlem on 14th March 1682. He loved to paint forest glades with oak-trees; sleeping pools beneath clusters of trees, with an old picturesque building, a mill or a ruined temple, or a glimpse of a distant town; a waterfall with rugged rocks, and coast scenes, where sea and earth meet. The scenes were mainly taken from the neighbourhood of Haarlem, partly from the districts of Germany that border on Holland. His work shows that he had a fine feeling for the poetic spirit of nature, which he embodies with great skill. His pictures exist in Dresden, Berlin (probably the two best collections), the Louvre, the London National Gallery, Amsterdam, and the Hague. See E. Michel, *Ruysdael et les Paysagistes d'Harlem* (Paris, 1890).

Ruysselede, a town in the Belgian province of West Flanders, 14 miles SE. of Bruges, has a large reformatory for boys (1849). Pop. 6793.

Ruyter, **MICHAEL ADRIANSZON** (afterwards De Ruyter), Dutch admiral, was born at Flushing on 24th March 1607 of poor parents, who sent him to sea as a cabin-boy when only eleven. He changed into the navy, and by 1635 had risen to the rank of captain. From 1643 to 1652 he was again in the merchant service, and fought against the pirates of Barbary. When war broke out between England and Holland in 1652, a fleet was given to Ruyter; with it he beat off an attack made upon him (26th August) by Sir G. Ayscove off the Lizard, but in conjunction with De Witt was compelled to retire after vainly attacking Blake off the mouth of the Thames (28th September). They had their revenge, however, two months later, when they defeated Blake off Dover. In the following year Ruyter took part in the running fight in the English Channel of 18th-20th February against Blake; in that of Solebay or Southwold (24-3d June) against Monk and Deane and Blake; in the indecisive battle off Katwyk; and in that off the Texel (29th July), in which his superior, Tromp, was killed and the Dutch fleet defeated. After this Ruyter was made vice-admiral of Holland. In 1654 peace was concluded between the two countries. In the years immediately following Ruyter was sent to blockade the coasts of Portugal, and then those of Sweden (on behalf of Denmark); he compelled the Swedes to surrender Nyborg in Fünen in 1659. On the conclusion of the Dano-Swedish war (1660) the king of Denmark ennobled him. The years 1661-63 were principally occupied with checking in the Mediterranean the piracy of the Turkish states of North Africa. In 1664 war broke out again between England and Holland, and De Ruyter steered his fleet to the west coast of Africa, and took from the English Gorée and some forts on the Guinea coast; in 1665 he preyed upon English merchant-vessels in the West Indies, made his way home round Scotland, and was chosen admiral-in-chief of the Dutch fleet; in 1666 he fought for four days (June 1-4) against Monk and Prince Rupert off Dunkirk, neither side gaining the victory, though the English were the first to retire; nevertheless in July he was beaten by Monk, and

driven back to Holland. In 1667 he caused great consternation in London by sailing up the Medway as far as Rochester, and burning some of the English ships, and entering the Thames a second time as high as Gravesend, besides attacking Harwich. Then came peace again; and in 1672 war once more, this time against England and France combined. De Ruyter's principal achievements in this war were to attack the English and French fleets under the Duke of York, the Earl of Sandwich, and Count d'Estrées in Solebay (28th May 1672), after which he retired to Holland; to defeat Prince Rupert and D'Estrées off Schooneveldt in June 1673, and again off Kijkduin and Helder in August. Peace was then made with England; but the war with France still went on. In the end of 1675 De Ruyter set sail for the Mediterranean, to go and help the Spaniards against the French. He encountered the French fleet under Duquesne near the Lipari Islands a few days before the New Year, and again in April in the Bay of Catania, on the east of Sicily. After the first encounter the Dutch-Spanish fleet drew off towards Palermo; in the second they were routed, and De Ruyter was seriously wounded in the right leg, the first serious wound in his life of battles. He died exactly a week later, on 29th April, in Syracuse. His body was buried in the New Church at Amsterdam. De Ruyter was a man of unaffected piety, simple in his manners, and of unflinching courage; as a seaman he deserves to take rank along with Blake and Nelson.

See Life (anon. Amsterdam, 1677), by Brandt (Amst. 1698), and by Richer (1783), all in French.

Ryan, **LOCH**, an arm of the sea, extending in a south-easterly direction into Wigtonshire from the southern entrance of the Firth of Clyde, fully 8 miles in length, with a breadth of from $1\frac{1}{2}$ to almost 3 miles. From about the middle of its western side a broad sandbank called the Scar projects diagonally across it for about $2\frac{1}{2}$ miles; opposite is Cairn Point with a lighthouse (1847). At its south-western corner stands the port of Stranraer, with daily steamers plying to and from Larne; two miles west of its northern extremity is Corsewall Point, a bold headland with a fine lighthouse (1816). Loch Ryan affords safe and commodious anchorage, being very deep close to its eastern shores, which are sheltered by the high hills of Finnart and Craigeaffie, as its western are by the beautifully wooded heights of Kirkcolm and Leswalt. The *Kerigonus Sinus* of Ptolemy, Loch Ryan has been rendered classic, in name at least, by the pathetic traditional ballad, 'Fair Annie of Lochryan'—the question of its localisation is quite another matter. Hew Ainslie's spirited song, 'The Rover o' Lochryan,' deserves mention also.

Rybinsk, a town of Russia, stands on the right bank of the Volga, at the termination of a branch-line (174 miles) of the Moscow and St Petersburg Railway, and 48 miles NW. of Yaroslav. It has a very large trade in transshipping and forwarding to the capital by canal the goods brought hither by large vessels up the Volga. Those goods are corn, flour, tallow, spirits, metals, timber, potash, salt, &c. Boat-building, rope-making, brewing, and distilling are the chief industries. Pop. 19,571, increased to 100,000 in the busy summer season.

Rydale Mount. See LAKE DISTRICT.

Ryde, a flourishing and fashionable watering-place on the north-east coast of the Isle of Wight, $4\frac{1}{2}$ miles SSW. of Portsmouth, from which it is separated by the roadstead of Spithead. It consists of Upper and Lower Ryde, the former occupying the site of an ancient village, *La Rye* or *La Riche*, destroyed by the French in 1377, and the

latter of quite modern construction. Fielding in 1753 described Ryde as 'a pleasant village, separated at low-water from the sea by an impassable gulf of mud;' but now there are excellent sands, and the appearance of the town with its streets and villas interspersed with trees is pleasing and picturesque. The longer of the two piers (768 feet) was constructed in 1813-61; of the buildings may be noticed the town-hall (1831); All Saints' Church (1870), by Scott, with a spire 173 feet high; St Mary's Roman Catholic Church (1846), by Hansom; and the Royal Victoria Yacht Club-house (1847). Ryde was made a municipal borough in 1868. Pop. (1811) 1601; (1851) 7147; (1881) 11,461; (1891) 10,932.

Rye, a decayed seaport of Sussex, 11 miles NE. of Hastings, and 2 miles inland now owing to the retirement of the sea. It stands on an eminence bounded east by the Rother, south and west by the Tillingham, and presents a quaint, old-world aspect. On a rock overlooking the confluence of the streams is the 12th-century Ypres Tower (now a police station), built in Stephen's reign by William de Ypres; the church, mainly Norman and Early English in style, and one of the largest in the kingdom, was restored in 1883. Then there are the old Land Gate, a former Carmelite chapel, and a grammar-school (1638). The *Novus Portus* of Ptolemy, Rye was granted by the Confessor to Fécamp Abbey, and by Henry III. was made a Cinque Port (q.v.). It became a Huguenot asylum after 1562 and 1685 (Thackeray's *Denis Duval* is laid here); and it returned two members till 1832, and then one till 1885. Fletcher the dramatist was a native. Pop. (1841) 4071; (1881) 4224; (1891) 3871. See Holloway's *History of Rye* (1847).

Rye (*Secale*), a genus of grasses, allied to Wheat and Barley, and having spikes which generally consist of two-flowered, rarely of three-flowered, spikelets; the florets furnished with terminal awns, only the upper floret stalked. One species (*S. cereale*) is a well-known grain. It has, when in fruit, a roundish-quadrangular spike, with a tough rachis. Its native country, as in the case of the other most important cereals, is somewhat doubtful; but it is said to be found wild in the desert regions near the Caspian Sea, and on the highest mountains of the Crimea. It has long been cultivated as a cereal plant; although the supposed mention of it in Exodus, ix. 32, is doubtful, spelt being perhaps intended. It is much cultivated in the north of Europe and in some parts of Asia. Its cultivation does not extend so far north as that of barley; but it grows in regions too cold for wheat, and on soils too poor and sandy for any other grain. Its ripening can also be more confidently reckoned upon in cold regions than that of any other grain. But rye succeeds best, and is most productive, in a climate where wheat still ripens. It delights in sandy soils. The varieties of rye are numerous, although much less so than those of other important cereals. Some are best fitted for sowing in autumn, others for sowing in spring. The former kinds (Winter Rye) are most extensively cultivated, being generally the most productive. In some places on the continent of Europe rye is sown at mid-summer, mowed for green fodder in autumn, and left to shoot in spring, which it does at the same time with autumn-sown rye, producing a good crop of small but very mealy grain. In Britain rye is not a common grain-crop, and is cultivated to a smaller extent than it formerly was; the sandy soils, to which it is best adapted, being improved and fitted for other kinds of corn. It is, however, sometimes sown to be used as a green

crop, for feeding sheep and oxen in winter, and is found particularly good for milch cows. It is sometimes also mown for horses and other animals. Bread made of rye is much used in the north of Europe; it is the familiar 'black-bread' of Germany, and the main sustenance of the Russian peasant throughout large regions. It is of a dark colour, more laxative than that made of wheat-flour, and, perhaps, rather less nutritious. Rye is much used for fermentation and distillation, particularly for the making of *Hollands*. The Russian beer called *kvass* is made from rye-meal. Rye affected with Ergot (q.v.) is a very dangerous article of food. The straw of rye is tougher than that of any other corn-plant, and is much valued for straw-plait. Perennial Rye (*S. perenne*) differs from common rye in having a very hard, red-like culm; ears, 3 to 5 inches long, flatly compressed, with a brittle rachis, and fifty to sixty closely imbricated spikelets. It endures for many years, but is not much cultivated, as its grain is slender, and does not yield an easily separable flour.

Rye-grass (*Lolium*), a genus of grasses, having a two-rowed, flatly-compressed spike, the spikelets appressed edgewise to the rachis. Perennial Rye (*L. perenne*), the *Ray-grass* of the older English authors, is frequent on waysides, and in meadows and pastures, in Britain and on the continent of Europe. The leaf is highly glazed, narrow tipped, has an obtuse ligule, surrounded by an auricle or collar-like portion of blade; whilst



Fig. 1.—Perennial Rye-grass (*Lolium perenne*) in flower, showing united root tufts: a, a spikelet in flower.

the younger leaves are folded throughout their length on the midrib when emerging from the purple sheath. The spikelets are much longer than their solitary external glume, six to eight flowered; the florets awnless or nearly so; the culm flattened, from 1 foot to 2 feet high; the root producing leafy barren shoots, which add much to the agricultural value of the grass. This grass is highly valued for forage and hay, and is more extensively sown for these uses than any other grass, not only in Britain, but also on the continent of Europe and in North America. It grows well even on very poor soils. The Perennial Rye is the kind most generally cultivated. Between 1882 and 1890 there was much discussion in England as to whether or not rye-grass is really

perennial. It is admitted to be of short duration on poor, dry soils, or in soils soaked with stagnant water, but its claim to be ranked as a lasting plant where the circumstances are even moderately favourable has been incontestably established. A kind called Common or Annual Rye (*L. vulgare*, *L. annuum*), not really an annual plant, although



Fig. 2.—Italian Rye-grass (*Lolium italicum*) in flower:
a, spikelet in flower.

useful only for one year, is sometimes cultivated, but is, in almost every respect, inferior. Italian Rye (*L. italicum*, or *L. multiflorum*, or *L. bouchianum*), a native of the south of Europe, is much esteemed as a forage and hay grass, and is preferred by cattle to the perennial rye-grass. In many soils and situations in Britain it succeeds extremely well, and is remarkable for its verdure and luxuriance in early spring. There are many varieties of rye-grass. It is nowhere so much valued or cultivated as in Britain, and was grown as a crop in England before the end of the 17th century. Rye, along with other grass seeds and the seeds of clovers, is generally sown along with some kind of corn, and, vegetating for the first year amongst the corn, appears in the second year with the other grasses and clovers as the proper crop of the field. See Stebler and Schröter, *The Best Forage Plants* (Eng. trans. by M'Alpine, 1889), from which our illustrations are copied.

Rye-house Plot. In 1682-83, whilst a scheme was formed among the leading Whigs to raise the nation in arms against Charles II., a subordinate scheme was planned by a few fiercer spirits of the party—including Colonel Rumsey and Lieut.-colonel Walcot, two military adventurers; Goodenough, under-sheriff of London; Ferguson, 'the Plotter'; and several attorneys, merchants, and tradesmen of London—the object of which was to waylay and assassinate the king on his return from Newmarket. The deed was to be perpetrated at a farm near Hertford, belonging to Rumbold, one of the conspirators, called Rye-house, whence the plot got its name. The Rye-house Plot is supposed to have been kept concealed from Monmouth, Russell, Shaftesbury, and the rest of those who took the lead in the greater conspiracy. It owed its defeat to the circumstance that the house which the king occupied at Newmarket took fire accidentally, and Charles was thus obliged to leave that place eight days sooner than 22d March. Both the greater and lesser conspiracy were discovered before long, and from the connection subsisting between the two it was difficult altogether to dis sever them. The indignation excited by the Rye-house Plot was extended to the whole Whig party; Russell, Algernon Sidney, and Walcot were brought to the block for treason; John Hampden, grandson of the patriot, was fined £40,000; and scarcely one

escaped who had been concerned in either plot. See *Ferguson the Plotter*, by J. Ferguson (1887).

Ryle, JOHN CHARLES, Bishop of Liverpool, was born at Macclesfield, May 10, 1816, studied at Christ Church, Oxford, carried off the Craven Scholarship, and graduated with a classical first-class in 1837. He took orders, and was successively curate at Exbury, Hants; rector of St Thomas', Winchester (1843), of Helmingham, Suffolk (1844); vicar of Stradbroke, Suffolk (1861); rural dean (1870), honorary canon of Norwich (1872); select preacher at Cambridge (1873-74), and at Oxford (1874-76). In 1880 he was nominated by Beaconsfield Dean of Salisbury, and before he had taken possession was raised to the newly-formed see of Liverpool. A prominent member of the Evangelical party, Bishop Ryle has written countless tracts of vast popularity, and the following books: *Coming Events and Present Duties* (1867); *Bishops and Clergy of Other Days* (1868); *The Christian Leaders of the Last Century* (1869); and *Expository Thoughts on the Gospels* (7 vols. 1856-69).

Rymer, THOMAS, compiler of the *Fœdera*, was born at Northallerton in 1639, studied at Sidney Sussex College, Cambridge, and entered at Gray's Inn in 1666. He published translations, critical discussions on poetry, dramas of his own, and works on history, and was appointed historiographer royal; but he died in poverty, 14th December 1714. Pope considered him 'one of the best critics we ever had'; Macaulay 'the worst critic that ever lived'—both rather overstating the case. His principal critical work is *The Tragedies of the Last Age Considered* (1678); but he is chiefly remembered as the compiler of the invaluable collection of historical materials called *Fœdera, Conventiones, Literæ et cujuscumque generis Acta Publica inter Reges Angliæ et alios quosvis Imperatores, Reges, Pontifices, Principes vel Communitates*, extending from the 11th century to his own time; vols. i.-xv. were published before Rymer's death; vols. xvi.-xx. by his assistant, Sanderson, in 1715-35; Tonson's reprint of the first 17 vols. in 1727-29; the Hague edition in 1737-45; that (incomplete, 4 vols.) of the Record Commission in 1816-69; and Sir Thomas Hardy's *Syllabus* of the whole, in 2 vols., in 1869-73.

Rymour. See THOMAS THE RHYMER.

Ryot. See INDIA, Vol. VI. p. 115.

Rysbrach, MICHAEL, sculptor, born at Antwerp on 24th June 1693, settled in London in 1720, and executed numerous works, in particular the monument to Sir Isaac Newton in Westminster Abbey (1731), that to the Duke and Duchess of Marlborough at Blenheim, a bronze equestrian statue of William III. for Bristol (1733), a colossal statue of George II. for the parade at Greenwich Hospital (1735), a Hercules at Stourhead, a statue of Queen Anne at Blenheim, one of Locke in Christ Church, Oxford (1757), and busts of Admiral Vernon, Earl Stanhope, Kneller, Gay, Rowe, Milton, Ben Jonson, Palladio, Inigo Jones, the Dukes of Somerset, Beaufort, and Argyll, Sir Hans Sloane, Pope, Sir R. Walpole, Bolingbroke, &c. He died 8th January 1770.

Ryswick, PEACE OF, was signed at Ryswick, a Dutch village, 2 miles S. of the Hague, by France, England, the Netherlands, and Spain, on September 20, and by Germany on October 30, 1697. It wound up the sanguinary contest in which England and her allies had been engaged with France, by putting an effectual check upon the power and overweening ambition of France.

Rytina. See RHYTINA.

S



the nineteenth letter in our own and most western alphabets, is descended through the Greek *sigma* from *shin*, the twenty-first Semitic letter. The Phœnician symbol, **W**, arose out of the hieratic form of the hieroglyphic picture of plants growing in an inundated garden

(see ALPHABET). The Semites called the letter *shin*, the 'teeth,' a name explained by the hieratic form, which resembles a row of teeth in the lower jaw. Though the form of the Greek letter *sigma* was derived from that of *shin*, the name was obtained from that of the Semitic sibilant *samech*. This must be attributed to the fact that, while the Semitic languages require four sibilants, Greek needs only three. One of the four was consequently disused, but, the usage differing in different dialects, a confusion arose, so that in the final or classical Greek alphabet it came to pass that the name used in one dialect was applied to the symbol adopted in another. The form of the Phœnician letter resembled our **w**. This, in the early Greek alphabets, became **Ξ** or **Σ**. In the Latin alphabet this was rounded, giving **S**. Our long *s* was derived from the old Roman cursive, the tick on the left of *f* being a surviving vestige of the lower curve of *s*. The sound of *s* is that of the hard open sibilant—a hiss formed by bringing the blade of the tongue near the front of the palate—the sound of *z* being the corresponding soft open sibilant. In Latin the sound of *z* did not exist, consequently the letter disappeared, and its place in the alphabet was taken by the new letter *g*. In the time of Cicero it was reintroduced for the transliteration of Greek words. Anglo-Saxon, also, had no *z*, the letter being introduced for the representation of Greek or French words, such as *zone*, *zest*, or *zeal*. But, although we now possess the letter, we are chary of its use, and its sound is constantly represented by *s*, as in *reason*, *rose*, *rise*. We use *s* both in *hiss* and *his*, in *hearse* and *hers*, in *curse* and *curs*, in *loose* and *lose*, though in one case the sound is that of *s* and in the other of *z*. Few genuine English words have *z*, though in some cases, such as *freeze* and *dizzy*, owing to Norman influence, a *z* has replaced an Old English *s*. Sometimes, as in *sugar* and *sure*, *s* has the sound of *sh* or *zh*, a sound which usually arises from the softening of the Anglo-Saxon *sc*, as in 'shall' from *sceal*, 'shame' from *scamu*, 'fish' from *fisc*, 'shade' from *scadu*, or 'sheep' from *sceap*. This change is characteristic of the southern dialects, the northern *Skipton* (sheep-tun) answering to the southern *Skipton*. So *skipper* and *shipper* are doublets, obtained from northern and southern forms of the same word. Occasionally the Anglo-Saxon form is preserved, as in *scar* and *score*, or is replaced by *sk*, as in *skin*. Owing to French influence *c* acquired a sibilant sound before *e* and *i*, and hence in a few words an Anglo-Saxon *s* has been replaced by *c*, as in 'nice,' from A.S. *mys*, or 'once' from *ones*. A final *s* sometimes disappears owing to its having been mistaken for the sign of the plural, as in 'pea,' from the O.F. *pis* (Lat. *pisum*), 'peas' or 'pease'

being regarded as a plural, of which 'pea' was erroneously supposed to be the singular. In the same way the French *cerise* and *relais* have given us 'cherry' and 'relay,' the final *s* in 'cherries' and 'relays' being regarded as the plural sign.

Occasionally *s* is intrusive, as in 'island,' from A.S. *ea-land*, an error due to the false analogy of 'isle' which comes from *insula*; or in 'aisle,' from the French *aile*, or in 'splash' for *plash*, where the *s* seems to be an intensitive. In Greek and Welsh *s* weakens to *h*, as is seen by comparing the Greek *hepta* with the Latin *septem*, or the Welsh *hen* with the Irish *sen*. A German *s* may represent an English *t*, as in *wasser* for 'water,' or *heiss* for 'hot.' In Latin an *s* changed a preceding *b* to *p* and *m* to *n*, as in *scripsi* from *scribo*, and *consul* from *comsul*; and it assimilated a preceding *t* or *d*, as in *cessum* for *cedsum*, and *mons* for *monts*. Before *m*, *n*, *d*, *l*, *r* a medial *s* disappears, as in *judex* for *justdex*, or *idem* for *isdem*. A final *s* sometimes disappears, as in *ipse* for *ipsus*; and between two vowels it becomes *r*, as in *aurum* for *ausum*, or *aurora* for *ausosa*.

SS, COLLAR OF, a collar composed of a series of the letter **S** in gold, either linked together or set in close order. Such collars have been much worn in England by persons holding great offices in the state.

Saadi. See **SÁDI**.

Saale, a river of Germany, distinguished from smaller rivers of the same name as the Saxon or Thuringian Saale, rises on the western slope of the Fichtelgebirge (Bavaria), and, flowing northward through several minor states, finally across Prussian Saxony, past the towns of Hof, Rudolstadt, Jena, Naumburg, Weissenfels, Merseburg, and Halle, falls into the Elbe, about 18 miles above Magdeburg, after a course of 226 miles. It is navigable from Naumburg to its confluence with the Elbe, a distance of 99 miles, for vessels up to 200 tons.

Saalfeld, a town of Saxe-Meiningen, on the Saale, 31 miles by rail SSW. of Jena, has ruins of a castle built by Charlemagne against the Sorbs, and possesses graphite, machinery, and other works. Pop. (1890) 9801.

Saarbrück, a town of Rhenish Prussia, on the Saar, 40 miles SE. of Treves, is the centre of a large coalfield, and of iron and glass works, with manufactures of tobacco, chemicals, metal utensils, &c. Pop. (1890) 13,812. Here, on 2d August 1870, the first engagement took place between the French and Germans, the latter retreating.

Saardam. See **ZAANDAM**.

Saargemünd (Fr. *Sarreguemines*), a town in the German province of Alsace-Lorraine, 41 miles E. of Metz. It is famous for its pottery; silk plush and velvet are also made. Pop. (1890) 13,076.

SaarLouis, a fortified town of Rhenish Prussia, 31 miles S. of Treves, on the left bank of the Saar. Fortified (1681-85) by Vauban, it was in the possession of France until 1815, when the Congress of Vienna gave it to Prussia. Here Marshal Ney was born. Pop. 6788.

Saaz, a town of Bohemia, on the Eger, 66 miles by rail NW. of Prague. Pop. 10,425, principally engaged in growing and trading in hops, and in manufacturing sugar, leather, &c.

Saba, a Dutch West Indian island, in the Leeward group, 40 miles NW. of St Kitts. A volcanic cone, 1500 feet high, it is known from its shape as 'Napoleon's cocked hat.' Area, 5 sq. m.; pop. 2421.

Sabadell, a town of Spain, 14 miles by railway NW. of Barcelona. It has risen into importance only within recent years, and is the Manchester of Catalonia. Woollen and cotton fabrics are the staple manufactures. Pop. 18,121.

Sabadilla, **CEBADILLA**, or **CEVADILLA** (*Schœnocaulon officinale*), a Mexican plant of the natural order Melanthaceæ, the seeds of which are employed in medicine. In the British Pharmacopœia the dried ripe seeds receive the name of Sabadilla. They contain an alkaloid, veratrine, which is official, and probably other closely allied substances. When applied externally the powdered sabadilla or veratrine is first irritant and then anaesthetic; both forms are used in rheumatic and neuralgic pains. Snuffed into the nostrils they cause violent sneezing and irritation. Taken by the mouth they are also irritant, if in too large a dose, and induce pain, vomiting, and diarrhœa. After absorption into the blood in medicinal doses they act chiefly on the muscles, and depress the heart and circulation and the body temperature. They are employed chiefly in acute febrile diseases in strong, healthy persons, but must be used with great caution on account of their marked depressant effects. The dose of veratrine is $\frac{1}{10}$ to $\frac{1}{8}$ grain.

Sabeans, or **SABA'**, were the ancient inhabitants of Yemen in southern Arabia. They are the people called Sheba in Gen. x. 28, xxv. 3; Job, vi. 19; and other passages in the prophets; and it was probably the sovereign of this people who paid the celebrated visit to Solomon. The Sabeans were a powerful and wealthy people, who from long before the days of Solomon down to the beginning of the Christian era controlled the sea and caravan traffic in gold, sweet spices, ivory, ebony, and valuable tissues, that came from India and Africa, and were despatched northwards to Syria. To protect and watch over this trade they had stations or colonies in northern Arabia and in Ethiopia. The capital of their country was Mariaba (Marib), the ruins of which, including vast dams, lie north-east of Sanaa (q. v.). Their religion included the worship of the sun and moon, and a number of other deities. Their language is intermediate between Arabic and Ethiopian, but nearer akin to the former. In the 8th century B.C. the people of Saba' paid tribute to the kings of Assyria (Tiglath-Pileser and Sargon). The Roman governor of Egypt in 24 B.C., tempted by the fame of the great wealth of the Sabeans, sent an expedition under command of Ælius Gallus to invade their country; but it met with little success. Not long after this event, however, the trade upon which the Sabeans relied began to take a sea-route and go up the Red Sea, and from that cause their prosperity and power seem to have declined. Soon afterwards they appear to have been subject to the sovereignty of the king of the Himyarites. Then, in the 2d century, and again in the 4th, and yet again in the 6th, we read that kings of Ethiopia were lords over the Sabeans. See **MANDEANS**, **ZABISM**; and various works, published since 1877, by D. H. Müller.

Sabah, a name for British North Borneo. See **BORNEO**, and **SANDAKAN**.

Sabbatai Zevi (also spelt *Sabbathais Zevi* and *Sabtai Zefi*), a false messiah, the founder of a wide-spread sect of semi-Christians and semi-

Jews throughout Europe, Asia, and Africa, was born at Smyrna in 1641. By his personal magnetism, his character, his extraordinary learning, and his brilliant abilities, he led thousands of followers, mainly in Smyrna, Salonica, Alexandria, and Jerusalem, where he successively laboured, to believe in him as the Messiah (see **MAHDI**). In 1664 no fewer than about 80,000 people belonged to the new empire; and in the following year the beginning of the Messianic reign within a few months and the rebuilding of the Temple in the next year were proclaimed aloud in the streets of Alexandria by Sabbatai and six disciples, all clad in white raiments, with garlands on their heads. Somewhat later he returned to Jerusalem; and the general resurrection, to take place within six years, and the deposition of the sultan, whose crown would be placed upon Sabbatai's head, were proclaimed far and near. But three years later, having provoked serious alarm at Constantinople, he was apprehended at Smyrna, and terrified into something like a recantation of his mission. He was said to have declared that his sole object had been all along to embrace Islam, and to carry over all the Jews with him. The sultan declared himself satisfied, and honoured him with the title of an effendi, giving him an honorary post at the same time. But the movement was far from having reached its end. A fictitious man was supposed by some to have embraced Islam, while the real Messiah had ascended heavenwards. Finally the grand vizier was persuaded to imprison Sabbatai once more, and to send him to Albania or Servia, where he died in prison—according to some, in consequence of poison, while according to others he was executed in 1677, ten years after his conversion.

Sabbath (Heb. *shabbath*, from *shabath*, 'to rest, cease, or leave off'; Gr. *sabbaton*), the seventh day of the week, set aside, in the Old Testament, as a period of cessation from work. When it was instituted is not known. Many have contended that from its moral and religious importance it must have been instituted at the Creation, and made binding on Adam in paradise and all his posterity. There is certainly no evidence in the Pentateuch of its having been kept in patriarchal times. The celebration of the seventh day is first mentioned after the Exodus from Egypt; though the circumstances connected with the gathering of quails recorded in Ex. xvi. 23 is sometimes held to presuppose the solemnisation of the Sabbath before the Sinaitic legislation (Ex. xx.); and the formula 'Remember' with which the commandment begins has been interpreted as implying that it was known before, and only required to be emphatically recalled to memory. The reason given for the observance in Ex. xx. 11 cannot be taken as deciding the point; for the reason appended to the fourth commandment in Deut. v. 15 is wholly different.

The weekly division of time was of course in no way peculiar to the Jews, nor was the religious solemnisation of the seventh day. As we learn from Sayce (*Ancient Empires of the East*), 'in Babylonia and Assyria the week of seven days was an Accadian or Babylonian invention, the days of the week being dedicated to the moon, sun, and five planets. The 7th, 14th, 21st, and 28th days of the lunar month were kept like the Jewish Sabbath, and were actually so named in Assyrian. They were termed *dies nefasti* in Accadian, rendered "days of completion (of labour)" in Assyrian; the Assyrian *Sabattu* or "Sabbath" itself being further defined as meaning "completion of work" and "a day of rest for the soul." In those days it was forbidden, at all events in the Accadian period, to cook food, to change one's dress or wear white robes, to offer sacrifice, to ride in a chariot, to legislate, to practise augury, or even to use medicine.'

But it was the Jewish Sabbath that left its mark on the religious history of the world. Even on the traditional view of the date and origin of the several parts of the Pentateuch and the Old Testament, it seems obvious that, whatever may have been the date of its institution, the laws and customs regulating its observance grew greatly in detail and in strictness. But if the Deuteronomic and priestly legislation (see BIBLE, PENTATEUCH) be regarded as much later than the Jehovist documents, the gradual development in stringency of the Sabbath ordinances becomes still more patent. Wellhausen and his school hold that new moon and Sabbaths were originally lunar festivals, regulated by the phases of the moon; and that, although there is little about the new moon in the Pentateuch, it originally stood on a somewhat similar footing with the Sabbaths, and was celebrated in the same manner (see Amos, viii. 5; 2 Kings, iv. 22, 23)—viz. with such rest from labour as was the natural accompaniment of a festival, a festival, too, originally marked even by mirth (Hosea, ii. 13). The new-moon feast was probably allowed to fall into desuetude as being so constantly associated with idolatrous and unholy rites by the heathen. The Jehovist and the Deuteronomist in dealing with the Sabbath have chiefly agricultural labour in their eye: the masters who can rest when they will are not commanded to rest themselves, but to let their servants and cattle rest. But in the priestly legislation the Sabbath is less of a festival and more of an ascetic observance, rest being inculcated in and for itself, not as relief and refreshment from toil, but as a kind of offering to God; a pious duty of self-restraint and self-repression as incumbent on master as on man. To go out of the camp to gather manna or wood is a transgression: it is Sabbath-breaking to kindle a fire or cook food (Ex. xxxv. 2, 3; xvi. 23). Jeremiah is the earliest of the prophets to insist on stricter Sabbath-keeping, followed by Ezekiel and the Deutero-Isaiah. During the Captivity the Sabbath was wholly separated from the sacrificial service of the festival, and increased in significance as a holy rest-day, becoming along with circumcision the mark of the Jew as distinguished from the Gentile. The builders of the second temple had a severe struggle to secure the strict sanctification of the seventh day; but as the pharisaical party increased in power the day became more and more burdensome—the rest of the week was but a preparation for the Sabbath, so that man seemed to be made for the Sabbath. When Jerusalem was stormed by Ptolemy I. the inhabitants would not stir in self-defence; those who had fled to escape the persecution of Antiochus Epiphanes allowed themselves to be butchered wholesale rather than resist on the holy day. Both Pompey and Titus seem to have made arrangements for attacking Jerusalem, relying on the strict observance of the day by the Jews. There are, however, cases during the Maccabee period of Jewish armies not merely defending themselves, but making fierce attacks. The Mishna enumerates thirty-nine principal works which are forbidden on Sabbath; and to each of them are attached several minor ones which might lead to Sabbath-breaking. The 'Sabbath-day's journey'—the prohibition of walking more than the 2000 yards supposed to represent the distance between the ark and the end of the camp—seems to belong to Roman times. The Essenes were specially strict in their Sabbath-keeping.

On Sabbath the faithful assembled in the synagogue in every town and hamlet within and without Palestine, especially after the exile. Parts of the Pentateuch and of the Prophets were read, translated into the vernacular, and expounded. Special prayers were said and sung, and the rest

of the day was devoted to pious meditation, study of the law, and serene joyfulness. For even in the later Jewish period the Sabbath was still distinctly a festival, 'a day of joy and delight.' Certain bodily indulgences were inculcated: fasting, mourning, and self-mortification were expressly prohibited. The day was to be honoured by wearing of finer garments, by taking of three meals of the best cheer available (though not of warm viands), accompanied with wine. The Karaites alone abstained from all fire and light for twenty-four hours. It should be added that by the Jews the Sabbath is reckoned from Friday evening to Saturday evening.

The analogy of the weekly Sabbath helped doubtless to mould the observance of a *Sabbatical Year*, which was apparently kept with strictness after the exile, though unknown to the early legislation. It was indeed enjoined that Hebrew slaves should be set free in the seventh year (Ex. xxi. 2-6), and that the seventh-year's crop should be left for the poor (Ex. xxiii. 10). But there is no hint that the seventh years coincided for any two persons or places: still less, that one Sabbath-year was held by the whole nation at the same time once in seven years. But after the Exile a periodic time was fairly established, the fields were left absolutely fallow, and no crops sown or harvested, to the severe suffering of many in evil times.

Christ and the apostles nowhere enjoin the observance of the Sabbath, but did themselves observe it, though acting on the principle that the 'Sabbath was made for man, and not man for the Sabbath,' and that 'the Son of man was lord also of the Sabbath.' Christ came into collision with the Pharisaic worshippers of the letter, and was more than once in danger of His life as a Sabbath-breaker. Even after the death of Christ there is no formal abrogation of the Sabbath: the apostles seem still themselves to have kept it in the Jewish manner. But its observance was not merely not enjoined on Christian proselytes: Paul most energetically insists that Gentile Christians should hold themselves absolutely free to observe it or not as seemed best. There were, however, Judaisers in the Christian church, whom Paul resisted; and the Ebionites (q.v.) insisted on the keeping of the Sabbath.

Nor is there anywhere in the New Testament any express statement that the first day of the week was to be kept in place of the seventh, or that the Lord's day represented or was in any way the Sabbath; though at a very early date Christians met for worship on the day on which Christ rose from the dead. The only mention of a Christian Sabbath in the New Testament is Heb. iv. 9: 'There remaineth therefore a Sabbath rest for the people of God' (New Translation), where obviously the reference is not to any one day of seven. A large body of Christians maintain that with the death of Christ the seventh-day Sabbath ceased for Christians, and that (apart from what Jewish Christians might have felt it their duty to do in the way of keeping the seventh day) the first day or Christian Sabbath naturally and inevitably took its place. Without citing any explicit authority for the substitution, they insist that the fourth commandment was a perpetual obligation as regards keeping holy one day in seven, and that the early Christian church could have no difficulty or hesitation in accepting at once the guidance of Providence in transferring the religious significance of the Sabbath of the law to the Sabbath of the new covenant; and that the Christian Sabbath has ever since continued, and to the end of the world will continue, obligatory on all Christians, all that was essentially moral and religious in the Jewish observances being applicable to the first day.

It must certainly be admitted that the earliest Christian writers do not identify the Sabbath and the Lord's day; none of the Fathers before the 4th century ground the duty of observing Sunday on the fourth commandment, or on the precept or example of Jesus or the apostles, or on an ante-Mosaic law promulgated at the Creation. Justin Martyr speaks of the regular assemblies of Christians on Sunday, 'because it is the first day in which God changed darkness and matter and made the world. On the same day also Jesus Christ our Saviour rose from the dead.' He makes no mention of abstinence from labour as part of the observance of the day. But whatever may have been the opinion and practice of these early Christians in regard to cessation from labour on the Sunday, unquestionably the first law, either ecclesiastical or civil, by which the sabbatical observance of that day is known to have been ordained, is the edict of Constantine, 321 A.D., of which the following is a translation: 'Let all judges, inhabitants of the cities, and artificers rest on the venerable day of the sun. But in the country husbandmen may freely and lawfully apply to the business of agriculture; since it often happens that the sowing of corn and planting of vines cannot be so advantageously performed on any other day; lest, by neglecting the opportunity, they should lose the benefits which the divine bounty bestows on us.' Before this time, such of the Christian writers as had endeavoured, by a mystical style of interpretation, to turn the Mosaic ceremonies to account as sources of moral and religious instruction had, probably in imitation of Philo, spiritualised the law of the Sabbath to the effect of representing it as a mystical prohibition to the Christian of evil works during all the days of his life, and a prefiguration of the spiritual repose and enjoyment which is his portion both in this world and in the next. But, in addition to this significance, there now began to be discovered in the Old Testament foreshadowings of the new Sunday-Sabbath; and the decrees of synods became more stringent. The Emperor Theodosius forbade business and public spectacles; Leo III. forbade legal processes and all labour. The Frank kings enforced Sunday observance by severe statutes. In England Ina of Essex forbade all servile work, and Alfred all labour, traffic, and legal processes. Canute was a supporter of Sunday observance; and some of the Norman kings were more strenuous, statutes of Edward III., Richard II., and Edward IV. specially dealing with the subject.

In Scotland the first record of effort by the authorities for the sanctification of the Lord's day is in the life of St Margaret. That saintly and most influential promoter of the stricter Roman usages had in Scotland to contend with great regardlessness of the Sunday, the Culdees (whom strangely enough Presbyterians were wont to claim as their spiritual ancestors) championing a lax Sunday keeping. 'It was another custom of theirs to neglect the reverence due to the Lord's day, by devoting themselves to every kind of business upon it just as they do on other days. That this was contrary to the law she proved to them by reason as well as by authority. Let us venerate the Lord's day because of the resurrection of the Lord, which happened that day, and let us no longer do servile works upon it.' She further quoted St Gregory's arguments in favour of keeping holy the day, and proved so unanswerable that thenceforward no one ventured to carry burdens or compel another to do so. How long the influence of St Margaret continued we do not know. Her descendant, James IV., seems to have paid more attention to the fourth commandment than to some of the others; Pedro de Ayala records of him that he

'fears God and observes all the precepts of the church. He does not eat meat on Wednesdays or Fridays. He would not ride on Sundays for any consideration, not even to mass.' But in Scotland, as a rule, the pre-reformation Sunday was in no sense strict; markets and fairs were commonly held on that day. Courts of law sat; archery was practised even in the kirk-yard; and Robin Hood and Little John plays were special Sunday spectacles.

The continental Reformers, while insisting on the value of the Sunday as a day of rest and worship, favoured the 'Dominical' as distinguished from the 'Puritan' view of the Sunday. Luther denied that Sunday should be kept because Moses commanded it; Zwingli is even more explicit; the second Helvetic Confession (1566) denies that keeping one day in seven is a moral duty, or that the observance of Sunday is founded on the fourth commandment, or that the Christian people might not choose any other day than the first; Calvin supports the freer view; and Beza expressly says that 'a Judaical rest from all kinds of work is not to be observed.' Nowhere except in English-speaking countries is the name Sabbath connected with the Sunday; when the word is regularly used for the name of a day of the week, as in Italian (*Sabato*), it simply means Saturday; the word for Sunday being with the Romance-speaking peoples derived from the Latin *dies dominica* ('Lord's day')—*Domenica*, *Dimanche*, &c. Orthodox German pastors take their households to miscellaneous concerts on Sunday evenings, and would consider hesitation to do so as a remnant of mere Jewish prejudice.

The English reformers—Cranmer, Hooper, Frith, Tyndale—it may generally be said, took a view distinctly unlike that of the Puritans. In Scotland also the less strict opinion at first prevailed. Knox's *Confession* and the Geneva Catechism, in use till the Westminster Confession was adopted, do not insist even on Sunday observances, and the word Sabbath is not used. Knox wrote letters and entertained guests to dinner on Sunday; plays (religious subjects) were performed on Sundays with the sanction of kirk-sessions as late as 1574. Church acts were immediately passed against holding markets on Sunday (a custom which obtained, in some places at least, as late as 1581), or producing the play of Robin Hood, and drinking in taverns in time of sermon. The Sunday is called Saboth-day soon after the Reformation; and the national legislation against all working or trading on Sunday dates from the Act of 1579. But it is contended, on good grounds, that the stricter view of Sabbath observance is of Puritan origin, and was introduced into Scotland from England. Some Puritans called the Lord's day 'the Sabbath' long before the end of the 16th century; but the first full statement of the 'high' doctrine of the Christian Sabbath was the *Sabbathum Veteris et Novi Testamenti: or the True Doctrine of the Sabbath*, by Dr Nicolas Bownde or Bound (1st ed. 1593; enlarged ed. 1606). The observance of the Sunday now became a keenly debated point between Puritans and High Churchmen—the first question of doctrine on which they directly differed. The Book of Sports (see SPORTS, BOOK OF) was long an apple of discord between Puritans and the other party; in the Long Parliament the Puritans triumphed, and the Westminster Assembly incorporated the Puritan view. It is certainly after the date of Bownde that the kirk-session records of Scotland are filled with proceedings against Sabbath-breakers for all manner of work, indoor and outdoor (shaving being especially noted), walking or 'vaging' in the streets and fields, being absent from public worship, &c., as well as for drinking

or really disorderly and disquieting conduct. Sabbath-breaking was one of the charges on which the bishops were deposed by the Covenanting General Assembly of 1638. Scotland has since then been specially the classical land of Sabbath observance, though the early legislation of Massachusetts and Connecticut (where it was ordained that Sunday should be counted from sunset on Saturday) was even more puritanically rigorous. But in Scotland, as in England and America, the tendency is towards giving greater freedom to the individual conscience. Still, great numbers of devout Christians regret this tendency, and press for greater strictness of observance, and seek legislative support. In Scotland public-houses have been strictly kept closed since 1853; in Ireland, with exception of the great towns, since 1878; and in Wales since 1881; but English Sunday Closing Acts have always been negatived. In Scotland especially there is frequent agitation against Sunday trains, Sunday postal deliveries, the opening of museums, libraries, or botanic gardens, and Sunday cycling: and disasters such as that of the Tay Bridge (1879) have by some been treated publicly as God's judgment on Sabbath-breaking. The Sabbath Alliance was founded in 1847 for promoting the stricter observance of Sunday. On the other hand, the Sunday Society was founded in 1875, under the auspices of Dean Stanley and others, to secure the opening of museums and galleries on Sunday. The Grosvenor Gallery was opened on Sunday in 1878; the same year the Manchester and some others were opened on Sunday for the first time. The question as to Sunday trains, long fiercely debated in America, was compromised by allowing the running of the through mails, while, as in England, local trains do not usually run.

The law of England on Sunday observance begins with acts of Charles I. (1625 and 1627), but is mainly based on the Act 29 Car. II. chap. 7, dating from 1676, which forbids all labour, business, or work done in the course of a man's calling on the Lord's day, works of necessity and mercy being excepted. It does not apply to coach-hirers, or drivers, or farmers. A baker baking bread transgresses the statute, but not one who bakes his customers' Sunday dinners. Contracts entered into on Sunday are not void if they are not within the regular business of the contracting parties; a tradesman may draw or accept a bill of exchange on Sunday, and a professional man may sell his horse. By an act of Geo. III. any house of amusement to which persons are admitted on a Sunday on paying money, or by tickets already paid for, is a disorderly house—the test being whether the thing is done for gain. In some respects English Sunday laws are more explicit than those of Scotland. Special licensing laws regulate hotels and public-houses. There are also laws against killing game, using dogs or nets for sporting purposes, or fishing for salmon otherwise than with rod or line; the Factory Acts and Pawnbroking Acts exclude Sunday labour (Jews being excepted). Local regulations deal with theatres, museums, galleries, &c.

In Scotland a law of 1579 prohibits hand-labouring, working, gaming and playing; there was another act in 1661. And these statutes, often confirmed, have recently been held to be still valid. In some respects the law of Scotland is stricter; all salmon-fishing is forbidden. But in the main the legislation is the same. Diligence cannot be executed on Sunday, save in case of persons in *meditatione fugæ*; contracts signed on that day are not necessarily void.

In America the law generally follows that of England, though some states have special regulations about Sunday travelling. There are rules in force for preserving order and quiet on that day;

by municipal regulations or general statute places of amusement and houses for the sale of intoxicants are usually kept shut.

In sharp opposition to the bulk of Puritan testimony is the contention of the devout people formerly known as 'Sabbatarians,' still represented by the Seventh-day Baptists in America, and a section of the Tunkers there. The English Sabbatarians of the 17th century (represented by Theophilus Brabourne) strenuously contended that the Sabbath was divinely instituted at the close of the work of creation, and remains binding on all mankind till the end of the world; the seventh day of the week alone is the Scriptural Sabbath: as there is absolutely no warrant in Scripture for changing from the seventh day of the week to the first, this change is mere will-worship, and a most unjustifiable encroachment of man's imagination on God's law. From the time of the Apostles, they hold, there never wanted down to the Reformation sincere Christians who, in the face of obloquy and persecution, continued to observe the fourth commandment. In the Abyssinian Church the Sabbath has not been supplanted by the Sunday, both days being kept; support is also claimed from the practice of the Armenians and Nestorians. Immediately after the Protestant Reformation were founded small societies testifying to the truth. In the later part of the 16th century and earlier part of the 17th there were at least eleven churches of Seventh-day Baptists in England, now dwindled to one or two. In America there are some flourishing churches of Seventh-day Baptists in sixteen states of the Union, with a membership of 10,000, two colleges, and an extensive literary propaganda.

The literature of the Sabbath controversy is exceedingly voluminous, as may best be seen by consulting Robert Cox, *The Literature of the Sabbath Question* (2 vols. 1865). See also, on the Puritan side, Holden's *Christian Sabbath* (1825); Gilfillan's *Sabbath* (1861); *Four Prize Essays* (Sabbath Alliance, 1886); and on the Dominical side, Hengstenberg's *The Lord's Day* (Eng. trans. 1853); Hesse's *Sunday* (Bampton Lectures for 1860); Zahn, *Geschichte des Sabbaths* (1878); Gairdner and Spedding, *Studies in English History* (1881); Crafts, *The Sabbath for Man* (New York, 1885). For the Seventh-day Baptists, see Lewis, *Sabbath and Sunday* (new ed. 1886); Andrews, *History of the Sabbath* (1873); and Bailey's *History of the Seventh-Day Baptist General Conference*.

Sabbatia (named from Sabbati, an Italian botanist), a genus of plants, of the natural order Gentianacæ, natives of North America. They are small herbaceous plants, some with simple, and some with branched stems. They all contain, like many others of the same order, a pure bitter principle, useful in fevers and as a tonic.

Sabellianism, a heresy about the distinction of Persons in God, the name of which is due to Sabellius, of whom but little is known, save that he was most probably a native of Libya, came to Rome under Zephyrinus, and was banished by Callistus, whereupon he took refuge in the Libyan Pentapolis. The Adoptionists and Modalists up to this time were the chief divisions of the Monarchians, the former making Christ the chosen of God, His divinity the effect of a complete oneness of will with Him, the latter making Him merely a manifestation of God. Modalism prevailed in Rome under the patronage of Calixtus, but was denounced by Hippolytus, who was himself accused of *ditheism*. Sabellius led the more extreme Modalists, and offered strong opposition to Calixtus, but his influence was far more important in the East than in the West, where the phrase of Athanasius that the Son and the Father are one and the same in substance (*ὁμοούσιος*) was at once accepted, though rejected at Antioch in 268.

The earlier form of Sabellianism was almost

identical with Patripassianism, the chief teachers of which were Praxeas, Noetus, Epigonus, and Cleomenes. But it developed into a complete resolution of the Trinity into a mere threefold manifestation of God to man. Father, Son, and Holy Spirit are not distinct subsistences (*hypostases*), but merely one and the same person in different aspects, just as the sun is at once a spherical body, a fountain of light, and a source of heat. The single absolute Divine Essence—the *monas* or pure Deity—unfolds itself in creation and the history of man as a Trinity. The *energy* by which God called into being and sustains the universe is the *Logos*, after whose image men were created; but when they had fallen from perfection it became necessary for the *Logos*, or Divine Energy, to hypostatise itself in a human body, in order to raise and redeem them; hence in the man Christ Jesus dwelt the fullness of the Godhead *bodily*; while the same Divine Energy, operating spiritually and impersonally in the hearts of believers, is the Holy Ghost. Sabellius held further that these Divine manifestations are merely temporary, and that after the *Logos* and the Holy Ghost had done their work they would be reabsorbed in the absolute Deity—the *trias* would again resolve itself into the *monas*; or, in the language of St Paul, that 'God would be all in all.' Epiphanius alleges that Sabellius derived his system from an apocryphal Gospel to the Egyptians; and there are, as Neander points out, so many points of resemblance in Sabellianism to the Alexandrian Jewish theology in general that the statement may be regarded as at least indicating the direction from which proceeded the influences that determined the theosophy of the unknown Pentapolitan. The 4th-century heresy associated with the name of Marcellus of Ancyra was closely allied to Sabellianism, which indeed becomes a term employed somewhat loosely. The followers of Sabellius were formally suppressed by the Catholic Church in the 4th century; but his doctrine, which, divested of its Gnostic and Neoplatonic phraseology about *emanation* and *re-absorption*, &c., is substantially Unitarian, has seldom wanted eminent advocates in any subsequent age of Christianity.

See the Church History of Neander; discussions by Schleiermacher and Lange; Döllinger's *Hippolytus u. Kallistus* (1853); Eng. trans. by Plummer, 1876; and Zahn's *Marcell. v. Ancyra* (1867).

Sabians. See SABÆANS, MANDÆANS, ZABISM.

Sabine, a river of Texas, rises near the northern boundary of Texas, and flows south-east to the border of Louisiana, and then south, forming the boundary between the two states. It empties through Sabine Lake (18 miles long by 9 miles wide) into the Gulf of Mexico. The Sabine is 500 miles long, and though shallow is mostly navigable for small steamboats.

Sabine. See SAVINE.

Sabine, SIR EDWARD, physicist, was born in Dublin, on the 14th October 1788. He obtained a commission in the artillery in his sixteenth year, and accompanied Ross and Parry as astronomer in the expeditions of 1818-20 in search of a north-west passage. Between 1821 and 1827 he undertook a series of voyages to places between the equator and the north pole, making at each point pendulum and magnetic experiments of great value. Elected a Fellow of the Royal Society in 1818, he was from 1861 to 1879 its president. He was for many years secretary of the British Association, and filled the office of president in 1853. In 1856 he was raised to the rank of major-general, in 1869 he was created K.C.B., retiring as general in 1877; and in 1875 he was elected a corresponding member of the French

Academy. He died at Richmond, June 26, 1883, aged ninety-five. His scientific reputation rests chiefly upon his labours in terrestrial magnetism, his various memoirs in the *Philosophical Transactions* and Reports to the British Association being to this day invaluable collections of magnetic facts. By his personal influence he did more than any other single man in inducing the government to establish magnetic observatories in different parts of the world, and in initiating the valuable magnetic work now carried out by the Admiralty.

Sabines, an ancient Italian people whose original headquarters were amongst the central Apennines, but ultimately occupying an area which extended down into the western plains, even to Rome itself. They had for neighbours Umbrians, Etruscans and Latins, and Samnites (see map of Italia Antiqua). They and their near kinsmen, the Samnites, constituted a group sometimes called *Sabellian*; and the two or more Sabellian peoples, together with the (less nearly) related Umbrians, spoke Aryan Italic dialects, to which the name of Umbro-Sabellian has been given. According to the legend, a colony of Sabines occupied the Quirinal Hill in Rome, but were ultimately incorporated with the Latin followers of Romulus upon the Palatine, and so helped to constitute the Roman people (see ROME). The *Rape of the Sabines* belongs to this period of legendary history. Romulus, having difficulty in finding wives for his followers (credited with a dubious reputation as runaways and malefactors), invited the Sabines to a feast and games; and while the games were going on the garrison of the Palatine seized the unsuspecting and unprotected Sabine women, whom they carried off to be their wives. After several wars the Sabines outside of Rome were ultimately subjected (241 B.C.).

Sable (*Martes zibellina*), a species of Marten (q.v.), so nearly allied to the Common Marten and Pine Marten that it is difficult to state satisfactory specific distinctions. The feet are covered with fur, even on the soles, and the tail is perhaps more bushy than in the British martens. The



Sable (*Martes zibellina*).

length, exclusive of the tail, is about 18 inches. The fur is brown, grayish yellow on the throat, and small grayish-yellow spots are scattered on the sides of the neck. The whole fur is extremely lustrous, and hence of the very highest value, an ordinary sable skin being worth £2 to £4, 10s., and one of the finest quality £28. The fur attains its highest perfection in the beginning of winter, and the pursuit of the sable at that season is one of the most difficult and adventurous of enterprises (see FURS). The sable is a native of Siberia, widely distributed over that country, and found in its coldest regions, at least wherever forests extend. The progress of geographical discovery in the

eastern parts of Siberia has been much indebted to the expeditions of the hardy and daring sable-hunters, exploring new regions at the worst seasons of the year, and spending dreary months at a great distance from all human abodes. The sable is taken by traps, which are a kind of pitfall, it being necessary to avoid injury to the fur; or by tracking it through the snow to its hole, and placing a net over the mouth of the hole. It is a very wary animal, and not easily captured. It makes its nest in a hollow tree, or sometimes, it is said, by burrowing in the ground, and lines it with moss, leaves, and grass. From this it issues to prey on hares and smaller animals of almost any kind, its agility enabling it even to catch birds among the branches of trees. It is ready, when food is scarce, to eat the remains of an animal on which a larger beast of prey has feasted, and is said even to satisfy its hunger with berries in winter, when animal food is not to be had. The sable, although it inhabits high northern latitudes, does not, as so many arctic animals do, change to white in the winter. This is accounted for by its habit of hunting among the branches of trees, against the dark colour of which white would be conspicuous, and therefore disadvantageous.

Sable Island, a low-lying island in the Atlantic, in 44° N. lat. and 60° W. long., 110 miles E. of the central part of Nova Scotia (and not near Cape Sable, at the south-east corner of Nova Scotia, where there is also a Sable Island). It consists of two parallel sand ridges, with a lagoon between them. Scrubby grass, cranberries, &c. grow on the island, which is so dangerous to navigation, and has so frequently been the scene of wrecks, as to be called 'the sailor's grave.' The Canadian government has since 1873 built three lighthouses on it, with an establishment of some 30 persons, of which two have been swept away and the third undermined, as the island is gradually sinking. Early in the 19th century it was 40 miles long; in 1890 it was reduced to 20 miles: it is to be hoped it may soon utterly vanish. Near it there are sandbanks.

Sables D'Olonne, LES, a seaport of France (dept. Vendée), on the Atlantic coast, 50 miles S. by W. of Nantes, owes its early importance to Louis XI., who excavated (1472) the port and erected the fortifications. There is a trade in grain, wine, salt, cattle, timber, and tar. Salt-making, ship-building, and fishing (sardines and oysters) are the chief occupations. The town is visited for its sea-bathing. Pop. (1891) 11,169.

Sabots, a species of wooden shoes made out of one block, and largely used by the French and Belgian peasantry, especially by those who inhabit moist and marshy districts. They are made of fir, birch, beech, alder, walnut, and other wood, and are manufactured principally in the Cevennes districts of France, the more ornamental varieties especially at Mende, Villefort, and Marvejols, all in the department of Lozère. For greater comfort and convenience, straw is stuffed between the foot and the wooden sides, or, with the most luxurious, a low woollen sock, made to fit the hollow of the shoe. The name is sometimes extended to a kind of Clogs (q.v.), with wooden soles and leather apers.

Sabre. See SWORD.

Sabretache (Fr.), the leather case for carrying letters, &c. which is attached to the sword-belt of hussars and of most mounted officers. In the latter case it is often highly ornamented.

Sabrina Land, a stretch of coast-land discovered in the Antarctic Ocean (1839) by Balleny; it is crossed by 120° E. long. and the Antarctic Circle.—*Sabrina* is the Latin form of SEVERN.

Saccharic Acid, $H_2C_6H_8O_6$, is a product of the action of nitric acid, under certain conditions, on grape and cane sugar, or on starch, gum, and lignine. It occurs as a colourless, inodorous, deliquescent, gummy, uncrystallisable mass, which is freely soluble in alcohol. It is sufficiently powerful to dissolve iron and zinc, with extrication of hydrogen. It has a tendency to form double salts. It is dibasic, and forms an acid and a normal salt with potassium.

Saccharimeter, or SACCHAROMETER, an instrument for determining the quantity of sugar in liquids, especially brewers' and distillers' worts. In principle it resembles the hydrometer (see SPECIFIC DENSITY), used for ascertaining the strength of alcoholic liquids. It consists of a hollow sphere or oval of thin brass, with a graduated stem and a hook so placed opposite each other that when placed in water it floats, and the graduated stem stands upright on the top, and the hook is below, for the purpose of appending weights. The degree to which the stem sinks gives the means of calculating, by tables prepared on purpose, the proportion of saccharine matter present in the liquid.

Saccharin, or GLUCIDE, $C_6H_7COSO_2NH$, is a sweet substance prepared by complex processes from coal-tar. It is a white, semi-crystalline powder, with a faint odour and intensely sweet taste. So sweet is it that it requires to be very much diluted before its sweetness can be appreciated, from $\frac{1}{2}$ to 1 grain sufficing for a cupful of tea. It is not a pure substance as found in commerce, but contains a variable proportion (40 to 60 per cent.) of a less sweet compound. On this account opinions differ as to its sweetening power compared with that of sugar, it being estimated to be from 200 to 300 times stronger than the natural product. It was at first thought likely that it would prove a serious rival to sugar, but its price offers no great inducement, and conflicting opinions as to its safety have rather militated against its use. At present it is employed for sweetening the food of diabetic patients, and for disguising the taste of drugs. Some aerated-water makers also employ it as a substitute for sugar, and it may be used to give an extra sweetness to glucose in the manufacture of artificial jams, &c. Saccharin is but slightly soluble in water, but dissolves readily if mixed with baking-soda, carbonic acid gas being liberated during solution.

Saccharissa. See WALLER.

Saccharum. See (under SUGAR) SUGAR-CANE.

Sacchetti, FRANCO (c. 1330-99), an Italian novelist, a follower of Boccaccio, was a native of Florence, who held several diplomatic offices. Of his 258 *Novelle*, first printed in 1724, ten are translated in Thomas Roscoe's *Italian Novelists* (1825).

Saccopharynx. See PELICAN-FISH.

Sacheverell, HENRY, D.D., was born in 1672 at Marlborough, the son of the High Church rector of St Peter's, and from the grammar-school there was sent by charity in 1689 to Magdalen College, Oxford. He shared rooms with Addison, who dedicated to his 'dearest Henry' *An Account of the Greatest English Poets* (1694); and, gaining successively a demyship and a fellowship, he took the degrees of B.A. (1693), M.A. (1696), B.D. (1707), and D.D. (1708). He had held the small Staffordshire vicarage of Cannock, when in 1705 he became preacher of St Saviour's, Southwark, and soon made his mark as a pulpit orator. In 1709 he delivered the two sermons—one at Derby assizes, the other on the 5th of November at St Paul's—which have given him a place in history. The rancour with which he assailed the principles of

the Revolution Settlement and the Act of Toleration, whilst glancing at Godolphin as 'Volpone,' and asserting the doctrine of non-resistance, roused the wrath of the Whig government of the hour, and led to his impeachment before the House of Lords of high crimes and misdemeanours (1710). Ardent crowds, shouting 'High Church and Sacheverell!' and now and then wrecking a meeting-house, attended him to Westminster; he defended himself ably (Burnet ascribes the defence to Atterbury), but by a majority of seventeen he was found guilty, and suspended for three years from preaching, his two sermons also being burned by the common hangman. The ministry fell that same summer, and in 1713, on the expiry of his suspension, Sacheverell was selected by the House of Commons to preach the Restoration sermon before them, and specially thanked on the occasion. A more substantial token of favour was his presentation to the rectory of St Andrew's, Holborn, after which little more is heard of him save that he squabbled with his parishioners, and was suspected of complicity in a Jacobite plot. He died at the Grove, Highgate, 5th June 1724, and was buried in St Andrew's, Holborn, whence his lead coffin was stolen in 1747.

See vol. ii. of Hill Burton's *History of the Reign of Queen Anne* (Edin. 1880); and F. Madan's 'Bibliography of Dr Sacheverell' in the *Bibliographer* for 1883-84.

Sachs, HANS, the most prolific and at the same time the most important German poet of his time, was born on 5th November 1494, at Nuremberg, where his father was a tailor. While at school he learned the rudiments of Latin, but was never a scholar in the academic sense of the term, although he was a very well- and widely-informed man. About the age of fifteen he began to learn the craft of shoemaking; his love of verse also led him to learn the art, almost mechanical, of verse-making from Leonhard Nunnenbeck, a weaver and *meistersinger* in his native town. On finishing his apprenticeship, Sachs, as was the custom of craftsmen in those days, made a tour through Germany, practising his calling in various cities, and frequenting assiduously the schools or corporations organised by the *meistersinger*, who, since the disappearance of the older *minnesinger*, or minstrels of chivalry, had become the chief representatives of German poetry. On his return to Nuremberg Sachs commenced business as a shoemaker, and prospered in his calling; and, after a long, cheerful, and happy life, died on 19th (or 25th) January 1576, and was buried in St John's churchyard, Nuremberg.

Sachs's career as an author is divided into two periods. In the first he shows an interest mainly in the occurrences that were then agitating Germany. It was the epoch of the Reformation of Luther, whose praises he celebrated (1523) in an allegorical tale entitled *Die Wittenbergische Nachtigal*, while his poetical fly-sheets (of which about 200 are known) furthered in no small measure the Protestant cause. In the second period his poetical activity was turned more to the delineation of common life and manners. His poetry is distinguished by its heartiness, good sense, homely morality, and fresh humour. It is, however, deficient in high imagination and brilliant fancy, and contains much prosaic and insipid verse. It was his chief pride to be an honourable citizen of Nuremberg, and his mind and his interest seldom travel beyond the narrow limits of its encircling walls. There is not one of his productions but what was meant to serve some didactic purpose. His best works are *Schwänke*, or Merry Tales, the humour of which is sometimes unsurpassable, serious tales, allegorical and spiritual songs, and Lenten dramas. His *meistersgesänge*, the

pieces he wrote according to the precepts of the verse-makers' guild, are now of little or no value, though in his own day they raised him to the first place amongst all his contemporaries. By the 52d year of his career (1567) as a poet he had written 34 vols., containing upwards of 6300 pieces, among which were more than 4000 *meistersgesänge*, 200 comedies and tragedies, about 1700 merry tales, secular and religious dialogues, proverbs, and fables, 7 prose dialogues, and 70 songs, secular and devotional. The first edition of his works was published at Augsburg in 1558-61, but that of Willer (5 vols. 1570-79) is better. After the middle of the 17th century Hans Sachs fell into neglect and was forgotten; and he remained so until his memory was revived by Goethe in 1776. His *Complete Works* were published by Götze and Von Keller (Stuttg. 15 vols. 1886). The selections of Merry Tales and Proverbs in Verse by Goedeke and Tittmann (3 vols. 1883-85) and by Engelbrecht (1879) can be recommended, as well as Tittmann's edition of the Lenten Dramas.

Besides Drescher's *Studien zu Hans Sachs* (Marburg, 1891), there are biographies by Ranisch (1765), Gené (1887), Stein (Halle, 1889), Kawerau (Halle, 1889), and Schweitzer (in French; Nancy, 1889). English readers may consult MacCallum, *Studies in German Literature* (1884).

Sachs, JULIUS, botanist, born at Breslau 2d October 1832, studied at Prague and began to teach botany there. After lecturing at the agricultural colleges of Tharandt in Saxony and Poppelsdorf near Bonn from 1859 to 1867, he was in the last year appointed professor of Botany at Freiburg, but removed to Würzburg in the following year. There he carried on, in a laboratory built under his own direction, important experiments in plant physiology, especially in determining the influence of light and heat upon plants, and in investigating the movements and other organic activities of vegetable growth. His *Lehrbuch der Botanik* (4th ed. 1874; Eng. trans. 1875) and *Handbuch der Experimentalphysiologie der Pflanzen* (1866) are useful and instructive text-books. Besides these he wrote *Geschichte der Botanik vom 16 Jahrhundert bis 1860* (1875; trans. 1890), *Grundzüge der Pflanzenphysiologie* (1873), and *Vorlesungen über Pflanzenphysiologie* (trans. 1887). Died in 1897.

Sack, a name in common use in the time of Shakespeare, and occurring down to the middle of the 18th century as denoting a kind of wine. The exact nature of this famous wine, the favourite beverage of Falstaff, and the origin of the name have been much discussed. Sack or seck seems to be simply an English disguise of the Spanish *seco* (Fr. *sec*), applied to wines of the sherry genus, as distinguished from the sweet wines; a term which we now translate by 'dry.' Canary was often the wine meant by sack. In old churchwardens' accounts sack is frequently mentioned as a communion-wine. It seems to have been mixed with port; and this mixture of white and red wines survived at Douglas in the Isle of Man till at least 1887 (*Notes and Queries*, 1887-88).

Sackbut (Fr. *saquebute*), a name used for two totally different instruments—the one a kind of trumpet, the predecessor of the Trombone (q.v.); the other, the sackbut of Scripture, a stringed instrument somewhat of the nature of a guitar.

Sacketts Harbor, a village of New York, on a bay of Lake Ontario, at the mouth of Black River, 12 miles by rail W. of Watertown. In the war of 1812 it was an important naval station; but it has now only some 800 inhabitants, although it is becoming a popular summer-resort.

Sackville, THOMAS, Earl of Dorset, poet and statesman, was born about 1536 at Buckhurst in

Sussex, the only son of Sir Richard Sackville, Chancellor of the Exchequer. He is supposed to have studied at Hart Hall, Oxford, and St John's College, Oxford, and then to have entered the Inner Temple; in 1554 he married, and in 1558 was returned to parliament. With Thomas Norton he produced the blank-verse tragedy of *Ferrex and Porrex* (afterwards called *Gorboduc*), which in January 1562 was acted before Queen Elizabeth (who was Sackville's second cousin) at Whitehall by the gentlemen of the Inner Temple. This work, whose plot is founded on a British legend, and which is after the style of Seneca, the incidents being moralised at intervals by a chorus, claims particular notice as the earliest tragedy in the English language. Dramatic energy it has none, but the style is pure and stately, evincing eloquence and power of thought (see DRAMA, Vol. IV. p. 85). Sackville's other chief production was the *Induction to a Myrrovr for Magistrates* (1563), a noble poem, 'uniting,' as Hallam says, 'the school of Chaucer and Lydgate to the *Faery Queen*,' and almost rivalling the latter in the magnificence and dignity of its allegoric personifications. The influence of Dante is very perceptible. His prodigality brought Sackville into disgrace with the queen, and he travelled awhile in France and Italy, but on his father's death in 1566 returned to England, and next year was knighted and created Lord Buckhurst. He was now employed much as a diplomatist in France and the Low Countries; in 1586 announced her death-sentence to Mary Queen of Scots; in 1589 was installed a Knight of the Garter; in 1599 succeeded Burghley as lord high treasurer; and in 1604 was created Earl of Dorset. He died suddenly at Whitehall at the council table, 19th April 1608.

See the Life prefixed to the edition of his Works by the Hon. and Rev. W. Sackville-West (1859), and a long article in vol. ii. of Cooper's *Athenæ Cantab.* (1861).

CHARLES SACKVILLE, sixth Earl of Dorset, was born January 24, 1637, and succeeded to the title in 1677. He travelled in Italy, was returned by East Grinstead to the first parliament of Charles II., and soon became an especial favourite of the king, and notorious, like too many of the courtiers, for his boisterous and indecorous frolics. He served under the Duke of York at sea, was employed on various missions, but could not endure the tyranny of James II., and was one of the most ardent in the cause of the Prince of Orange. His later years were honoured by a generous patronage of men of letters like Prior, Wycherley, and Dryden. He died at Bath, January 19, 1706. He was himself the author of a few occasional lyrical and satirical pieces, but is only remembered for one short poem, the bright and delightful song, 'To all you Ladies now on Land.'

Saco, a city and port of entry of Maine, on the left bank of the Saco River, here crossed by a bridge to Biddeford, and with falls of 50 feet supplying water-power, 16 miles by rail WSW. of Portland. It contains cotton and shoe factories, sawmills, machine-shops, &c. Pop. (1880) 6389; (1890) 6075.—The *Saco River* rises in the White Mountains of New Hampshire, and runs south-east through Maine to the Atlantic. It is 170 miles long.

Sacrament (Lat. *sacramentum*, *mysterium*, Gr. *mysterion*), the name given by theological writers to certain religious rites, the number as well as effects of which are the subject of much controversy between various bodies of Christians. The word *sacramentum*, in primitive classical usage, meant either the oath taken by soldiers on their first enrolment, or the sum of money deposited by suitors on entering upon a cause, and forfeited

'to sacred uses' by the unsuccessful party; and the corresponding classical Greek word *mysterion* meant not merely the secret religious ceremonies practised in the worship of certain gods, but also any revealed secret. It is certain, nevertheless, that at a very early period of the Christian church both the Latin word and its Greek equivalent came to be applied specially to certain rites of the Christian ceremonial, and chiefly (or as is commonly held by Protestants, exclusively) to those of Baptism and the Eucharist. Of the catechetical lectures of St Cyril of Jerusalem the lectures devoted to the subject of Baptism and the Eucharist are called 'mystagogic lectures.' Here it will be enough to state concisely what are the views of the several religious communities on this much controverted subject, which formed one of the main grounds of division between the Roman Church and the Reformers of the 16th century.

In the Roman Church it is held that there are seven sacraments—viz. Baptism, Confirmation, the Eucharist, Penance, Extreme Unction, Holy Orders, and Matrimony. The special teaching of Catholics on each of these rites will be found under the several heads; but there are certain general principles regarding them all on which the Roman Catholic doctrine differs widely from that of the Reformed communities. Catholics define a sacrament to be a visible or sensible sign permanently instituted by God, and conveying real interior grace to the recipient, and they teach that all sacraments contain within themselves, as instruments, and, when they are received with proper dispositions, produce, such grace by the virtue imparted to them by God, and not merely through the faith of the recipient; although they hold that proper dispositions on the part of the recipient, as sorrow for sin, love of God, pious resolves, &c., are conditions indispensable for the efficacy of the sacramental rite (see OPUS OPERATUM). They divide the sacraments into two classes, 'sacraments of the living' and 'sacraments of the dead.' The first class comprises the Eucharist, Confirmation, Holy Orders, and Matrimony—all which sacraments can only be received fruitfully by persons in a state of grace or justification. The second includes Baptism, Penance, and Extreme Unction, the special purpose of which is to remit sin, and which therefore can be received by persons in a state of sin, but penitent for that sin, and resolved to amend their lives. Of three of the sacraments—viz. Baptism, Confirmation, and Holy Orders—it is held that they imprint a 'character,' and therefore that they can only be received once. The others may be repeatedly received, but under conditions which will be learned under each separate head. Two things are held to enter into the constitution of the sacrament—viz. the 'matter' and the 'form.' By the former is meant the material element or the physical action whereby that element is applied to the recipient of the sacrament; as water in baptism, oil in extreme unction, and in both the act of washing or of anointing. By the latter is understood the form of words employed by the minister in communicating to the recipient the external rite in which the sacramental act consists. The minister of a sacrament is the person who is supposed to be divinely authorised to impart it. The Council of Trent anathematises those who teach that there are more or less than seven sacraments. The Greek Church also recognises the seven sacraments.

The Reformed Churches have for the most part rejected these views. By the majority of them the sacraments are held to be merely ceremonial observances, partly designed as a solemn act, by which each individual is admitted to membership,

or desires to make solemn profession thereof; partly intended to stimulate the faith and excite the fervour and the pious dispositions of the recipient, to which dispositions alone all the interior effects are to be ascribed. As to the number of rites called by the name, almost all Protestants agree in restricting it to two—viz. Baptism and the Lord's Supper; although some of the rites which Catholics regard as sacramental are retained by some of the Protestant communities as religious observances. Calvin defends the ceremony of ordination by imposition of hands, once even calling it a sacrament, though evidently not in the strictest sense of the word. In the English Church, however, there has always been a school in which opinion tending towards the Catholic view has prevailed. Not only have English Churchmen ascribed to the two rites of Baptism and the Eucharist or Lord's Supper (q.v.) the power of producing an interior grace (which in the former is called Regeneration, q.v.), but since the Tractarian movement many of them have been willing to call the other rites, especially Confirmation, Penance, and Holy Orders, by the name of sacrament, although of a secondary character, and not 'generally necessary to salvation.'

See the separate articles on the sacraments, especially BAPTISM, and LORD'S SUPPER, and works there cited; also ROMAN CATHOLIC CHURCH; and for the sacraments as recognised by the Orthodox Eastern Communion, see GREEK CHURCH, Vol. V. p. 396.

Sacramentarians, a term used in more senses than one. (1) Ordinarily in England it means one who holds a 'high' or extreme doctrine of the efficacy of the sacraments, especially of the Eucharist (see LORD'S SUPPER). (2) Technically, however, the word is used in church history in an almost diametrically opposite sense for persons holding a 'low' doctrine on the subject of the sacraments—for the party among the Reformers who separated from Luther on the doctrine of the Eucharist. Luther taught the doctrine of the real presence of the body and blood of Christ along with the bread and wine (see LORD'S SUPPER). Carlstadt, Capito, and Bucer were the leaders of those who called this doctrine in question. This sacramentarian party became so considerable that in the diet of Augsburg they claimed to present a special confession known in history by the name of the Tetrapolitan Confession—so called from the four cities, Strasburg, Constance, Lindau, and Memmingen. The Tetrapolitan Confession rejects the doctrine of a corporeal presence, and although it admits a spiritual presence of Christ which the devout soul can feel and enjoy, it excludes all idea of a physical presence of Christ's body. Simultaneously with this German movement, yet independent of it, was that of the Swiss reformer Zwingli, whose doctrine on the Eucharist was identical with that of Carlstadt, and who himself presented a private confession of faith to the Augsburg diet in which this doctrine is embodied. The four cities named above continued for many years to adhere to this confession presented to the diet of Augsburg in their name; but eventually they accepted the so-called Confession of Augsburg, and were merged in the general body of Lutherans. On the contrary, the article of Zwingli upon the Eucharist was in substance embodied in the confession of the Helvetic Church.

Sacramento, the largest river of California, rises in the north-eastern part of the state, its head-stream, Pitt River, draining Goose Lake, and flows south-west through the Sierra Nevada to Shasta, south to Sacramento, and thence south-south-west into Suisun Bay, through which its waters pass into San Pablo Bay and so to the Pacific Ocean. Its length is about 500 miles, and

it is navigable for small vessels to Red Bluff, nearly 250 miles. A few miles above its mouth it receives the San Joaquin; and with this and other tributaries it drains the great central valley of the state.

Sacramento, the capital of California, is on the east bank of the Sacramento River, at the mouth of the American River, 120 miles by water and 90 by rail N.E. of San Francisco. The streets are laid down at right angles on a level plain. The business portion is built of brick, the dwellings of wood, with shade-trees and gardens. The principal public buildings are the state capitol (which cost about \$2,000,000), the county court-house (formerly the capitol) and hospital, the post-office, a Roman Catholic cathedral, the Crocker Art Gallery, and the Masonic and Oddfellows' halls. The manufacturing industry includes a number of flour and planing mills, carriage, box, and broom factories, foundries, potteries, spice-mills, and a cannery; and here are the shops of the Southern Pacific Railroad, covering 25 acres. Sacramento was settled in 1839 by a Swiss named Sutter, who built a fort here in 1841; but it was not till 1848, after the discovery of gold, that the city—at first as a canvas town—was laid out; it became the state capital in 1854. Inundations led to the building of a levee in 1862. Pop. (1880) 21,420; (1890) 26,386; (1900) 29,282.

Sacrarium (Lat., 'a place where sacred objects are deposited'), the part of a church where the altar is.

Sacred Heart of Jesus, FEAST OF, a modern festival of the Roman Catholic Church. Its origin is traced to a vision which is recorded of a French Visitation nun named Marguerite Marie Alacoque (1647-90), who lived at Paray-le-Monial (q.v.). This devotion was gradually propagated in France, approved by Clement XIII. in 1765, and extended to the whole church in 1856, Sister Marguerite Marie being beatified in 1864. The festival is held on the Friday (in England on the Sunday) after the octave of Corpus Christi. Of many churches dedicated to the Sacred Heart by far the most splendid is that erected on Montmartre, the highest point of Paris, in 1874-91, at a cost of nearly a million sterling. The faithful worship the heart of Jesus, considered 'not as mere flesh, but as united to the divinity;' and the heart is chosen because it is a symbol of charity and of the inner life. The heart of the Blessed Virgin, on the same principle, is venerated by the Roman Church.—There is a cloistered order of nuns of the Sacré Cœur, which was founded at Paris in 1800 by Fr. Varin and Mme. Barat, approved in 1826, and has very numerous houses in Europe, America, and Australasia. The chief of these in England is at Roehampton, in Ireland at Roscrea. Its members teach the higher branches of girls' education.

See Bongaud, *Histoire de la bienheureuse Marguerite Marie* (5th ed. 1880); and Nilles, *De Rationibus Festorum Sacratissimi Cordis* (1875).

Sacred Music. See MUSIC, ANTHEM, CHANT, CHOIR, CHORALE, HYMN, INTONING, MASS (MUSIC OF), ORATORIO, PLAIN-SONG, SERVICE (MUSICAL).

Sacred Wars. See AMPHICTYONIC COUNCIL, PHILIP OF MACEDON.

Sacrifice has been the fundamental institution of all natural religions. It is found at one time or another with the same general features in nearly all parts of the world. The same human wants have everywhere found the same embodiment. As a general rule its historical development among different peoples keeps pace with the progress of their thoughts regarding the nature of the divinities they worship. Sacrifice is primarily a sacramental meal at which the communicants are a deity and

his worshippers, and the elements the flesh and blood of a sacred victim. Primitive tribes everywhere seem to regard themselves as related to their gods by the bond of kinship, and every tribe has certain sacred animals which it regards as related to the tribal god by precisely the same bond. These sacred animals are probably a survival of the totem-stage through which all civilised races seem to have passed. In any case they play a most important part in primitive religion. They are regarded with reverence as sources or media of supernatural influences. Their lives are protected like those of kinsmen. To slaughter one of them for private use is an act of sacrilege or murder. Sacrifice is a rare and solemn public function. The significant part of it is not the slaying of the victim, but the sacrificial meal which follows. During this meal the life of the sacrosanct animal with its mysterious virtues is supposed to pass physically into the communicants, whereby the natural bond of union between the god and his clients is sacramentally confirmed and sealed.

While this sacrificial meal occurs with the same general features in all natural religions, there is infinite diversity in detail. (1) There are differences as to the portions assigned to the divine and human communicants. As a rule one or more parts which are regarded as either peculiarly sacred or peculiarly choice—the blood, the fat, the head, the shoulders, the viscera—are given to the deity, and the rest is eaten by the worshippers. Sometimes a whole victim is given to the deity, while another is eaten by his commensals. Sometimes the portion of the god, sometimes that of the worshippers, is eaten by priests—but that is a late refinement. (2) There are differences as to the minor offerings which usually accompany the great sacrifice and help to furnish forth the feast. Fruit, cakes, honey, wine, milk, butter, and oil are the most common of the secondary oblations. What is prescribed in one country is forbidden in another. Each people naturally offers the choicest produce of its own land. (3) There are differences as to the times and seasons of sacrifice. Among pastoral tribes the great sacrifices occur at the time of yearning, among agricultural peoples during vintage and harvest. (4) Finally there are important differences as to the way in which the portion of the deity is conveyed to him. At first men believe that he actually eats the flesh of sacrifice. He is supposed to dwell in certain hallowed spots in his dominions—in stones, trees, fountains, caves. At these natural shrines his worshippers meet and sacrifice, and there they lay out his portion and leave it. At this stage sacrifice is literally the food of the gods. After a time men rise above this crude conception. The deity comes to be regarded as an ethereal being whose home is the upper air, and he can no longer be supposed to partake of solid food. The difficulty that now arises is overcome partly by the use of fire, which etherealises the sacrifice and sends it up to the deity in savoury clouds of smoke and vapour, partly by the multiplication of liquid offerings, especially blood and wine, which sink into the ground and may readily be supposed to be drunk up by the god.

These are the details and non-essentials of primitive sacrifice. The essentials are the public assembly, the shrine, the sacred victim, the banquet, and the supposed presence of the god as a guest-friend. The object is always to renew and strengthen the ties of kinship and friendship between the god and his worshippers, and so to secure the continuance of material prosperity. This primitive sacrificial system is not without religious value. If it is not lofty, it is genuine. It is no mere imposing or touching ceremony.

The ideas which it embodies are to every worshipper realities. Religion and ritual are still one. The system has also considerable ethical value. It binds the worshippers not merely to their god but to one another. The goods it seeks are material, but they are always public and social, never selfish goods. It gives the individual no place except as a member of the commune or tribe.

A new and radically different conception of sacrifice is formed when the tribal system begins to break up. Primitive ideas of the consanguinity of gods, men, and beasts become obsolete. Sacred animals become private property, their flesh begins to be used as common food, and they lose their sanctity. Before a sacrifice can now take place an animal has first to be surrendered by its owner and consecrated. Dedication takes the place of natural sanctity. It is this new and important element that changes the character of sacrifice. The act of surrender, which is at first a mere preliminary, comes to be regarded as the essential feature. A sacrifice begins to be spoken of as a gift or tribute from the worshipper to the deity, and the original sacramental idea is gradually lost sight of. Is this a forward or a backward movement of thought? It may be the one or the other, according to the meaning attached to the gift. Two interpretations are possible. Gifts have either a symbolical or an intrinsic value. If the sacrificial gift is simply an expression of the truth that all private property is a trust from God and ought to be devoted to His service, the new conception is an advance and can do nothing but good. But if it be supposed that God stands in need of gifts, and that the more numerous and costly the oblations the greater their efficacy, the tribute-idea is a backward movement. Sacrifice then becomes nothing but a method of conjuring. Unfortunately the latter view is the common one. The historical outcome of the gift or tribute theory is holocausts, hecatombs, and human sacrifices. These last are a strange instance of reversion to barbaric practice. Human sacrifice is natural among cannibals: the food that is most grateful to man is always presented to the gods. Its revival among civilised peoples is the result of a very different train of thought. Those who begin to measure the atoning power of a sacrifice by its magnitude, splendour, or cost cannot forget that they have possessions more precious than flocks and herds. Hence in times of great distress they begin to conjure the displeasure of their gods with offerings of their own flesh and blood.

As the breaking up of the tribal system leads to a radically new conception of the nature of sacrifice, so the downfall of a nation may always be expected to produce great changes in the sacrificial system. Adversity always puts a great strain on a nation's faith in the efficacy of sacrificial gifts. Repeated calamity shatters its faith. How can it escape from religious negation? Not by any new sacrificial theory. Sacrifice is either a sacramental rite or a tribute. No other conception is possible. The history of Israel, however, proves that two courses are still open to a people whose minds have been purged of the superstition that mere gifts can secure the divine favour. Some few great minds rise above the sacrificial idea to a purely spiritual religion. The majority return to the sacramental idea. Of the latter some revive the sacramental rite in its most primitive form, using as the sacramental elements the flesh and blood of various animals still tabooed or sacred. A greater number adopt the most complex and refined sacramental ritual. Taking it up at the stage where its historical development has been arrested, elaborating it at certain points and recasting it

at others so as to make it more fitly express the religious wants of the new time, they begin to practise the whole with a fresh zeal.

In primitive Israel the central feature of sacrifice (*shelem, zebah*) is always the common meal, provided for by the slaughter of the sacred animal and by various kinds of cereal oblation (*mincha*). Time gradually robs the meal of its sacred character, and then the holocaust (*'ola*) becomes common. After the Exile the great sacrifice is the sin-offering (*asham*), which culminates in the solemn ritual of the day of atonement. It is generally supposed that the central idea of the sin-offering is that of substitution—Jehovah accepting the life of the victim for that of the sinner. That is probably a mistake. Just as in the earlier sacrificial meal, so here, the significant part of the rite is not the shedding, but the application of the life-blood, followed by the burning of certain portions of the flesh and eating of others. Some of the details may readily lend themselves to a new interpretation, but the origin and primary significance of the ritual can be understood only when its distinctive features are compared with those of the sacrificial feast.

The thinkers of Greece and the prophets of Israel wage a constant polemic against the popular superstitions connected with the sacrificial system. Some of the latter seem to break away entirely from ritual, others do much to give it an ethical and spiritual meaning. Christianity embraces whatever is true both in the sacramental and in the dedicatory idea of sacrifice. The former idea receives its perfect expression in the first Christian rite, the latter in the first rule of Christian ethics, which transfigures sacrifice into self-sacrifice. But the followers of Christ are slow to rise to the height of His teaching. Material sacrifice is always easier than spiritual. Many of the errors connected with the old sacrificial systems survive as well in crude unethical conceptions of the Christian atonement as in the mass of the Church of Rome.

See A. Lang's *Myth, Ritual, and Religion* (2 vols. 1887); Tylor's *Primitive Culture* (2 vols. 1871); J. G. Frazer's *Totemism* (1887); Wellhausen's *Rechte arabischen Heidenthumes* (1887); and especially Robertson Smith's *Religion of the Semites* (1889).

Sacrilege is not now a legal, but is a popular term used to denote the breaking into a place of worship and stealing therefrom. In England whoever breaks and enters any church, chapel, meeting-house, or other place of divine worship and commits any felony therein, or whoever, being in such places, shall commit any felony therein, and break out of the same, is guilty of felony and liable to penal servitude for life, or for not less than three years, or to imprisonment for a term not exceeding two years, with hard labour. The legal offence of breaking and entering a place of worship with intent to steal comes under the head of burglary or housebreaking. In Scotland there is no increase of severity in the punishment by reason of the sacred character of the things stolen.

Sacristan, an official attached to a church who is charged with the care of it, and in particular of the sacred vestments and utensils. These are kept in the *sacristy*, or vestry, which in continental churches is often a spacious building.—The English name *sexton* is an early corruption of this word.

Sacrobosco, JOANNES DE (or JOHN HOLYWOOD), an English mathematician of whom little is known, except that he seems to have been a native of Halifax, to have studied at Oxford, and taught at Paris as professor of Mathematics, where he died in 1244 or 1250. He was one of the first doctors of the middle ages who made use of

the astronomical writings of the Arabians. His treatise, *De Sphæra Mundi*, a paraphrase of a portion of Ptolemy's *Almagest*, enjoyed great renown as a manual among the scholastics. First published in 1472, it passed by 1647 through forty editions, besides translations and commentaries. See an article by C. L. Kingsford in vol. xxvii. of the *Dict. Nat. Biog.* (1891).

Sacrum, or OS SACRUM, is a triangular bone situated at the lower part of the vertebral column (of which it is a natural continuation), and wedged between the two innominate bones so as to form the keystone to the pelvic arch. It is readily seen to consist of five vertebrae with their bodies and processes, all consolidated into a single bone. Its anterior surface (see illustrations at PELVIS) is concave, not only from above downwards, but also from side to side. The posterior surface is convex, and presents in the middle vertical line a crest, formed by the fusion of the spines of the vertebrae, of which the bone is composed. The last sacral vertebra has, however, no spine, and the termination of the vertebral canal is here very slightly protected. The sacrum of man differs from that of the lower animals by its greater breadth in comparison with its length. This proportion is expressed in the

following way: $\frac{100 \times \text{breadth}}{\text{length}} = \text{sacral index}$. In

the male European the average sacral index is 112, in the negro 106, in the Australian aboriginal 99, in the orang 87, in the gorilla 72. In the female the sacrum is broader than in the male, the sacral index of the European female being about 116 (Turner, *Challenger Reports, Zoology*, xvi.). The sacrum and its connections are illustrated at PELVIS.

Various reasons have been assigned for the name given from of old to this bone; Littre accepts the view that it was because it was a part that had special significance with the ancients in sacrifices. Another reason is based on the view maintained by the Jewish rabbins, who held that this part of the skeleton, which they called 'Inz,' resisted decay, and became the germ from which the body would be raised.

Sacy, ANTOINE ISAAC, BARON SILVESTRE DE, the founder of the modern school of scientific Arabists, was born at Paris on 21st September 1758. He was trained for the civil service, and whilst labouring in the Mint he made himself master of the chief Semitic languages, as well as Persian, and to some extent of Turkish. He had already gained the reputation of a sound Oriental scholar through papers contributed to Eichhorn's *Repertorium* and other learned journals, when the excesses of the republicans caused him to retire from government service, and devote himself wholly to his favourite pursuits. He published in 1793 his first ambitious work, a translation of the Persian *Annales de Mirkhond* along with *Mémoires sur Diverses Antiquités de la Perse*. Two years later he was called to fill the chair of Arabic in the newly-founded Institute of Oriental Languages; and to this he added in 1806 the duties appertaining to the professorship of Persian. He held besides several public appointments, nearly all simultaneously with his professorships, such as that of a member of the Corps Législatif (1808), rector of the university of Paris (1815), perpetual secretary of the Academy of Inscriptions, founder and member of the Asiatic Society, and member of the Chamber of Peers. As a teacher he was held in the very highest esteem; he wrote valuable text-books—*Grammaire Arabe* (2 vols. 1810), the fruits of fifteen years' labour; *Chrestomathie Arabe* (3 vols. 1806), and its supplement, *Anthologie Grammaticale* (1829)—which

helped to train many of the best Arabic scholars of the 19th century; and he himself had for his pupils several of the best teachers of that language who laboured in both France and Germany in succeeding years. He died in Paris on 21st February 1838. Besides the works quoted and alluded to he also published Abd-Allatif's *Relation de l'Égypte* (1810), an edition of the tales of Bidpai (*Calila et Dimna*, 1816), Farid ed-Din Attar's *Pendnameh* (1819), Hariri's *Makamat* (1822), *Exposé de la Religion des Druses* (1838), &c. See Reinaud, *Notice . . . de Baron Silvestre de Sacy* (1838).

His son, SAMUEL USTAZADE SILVESTRE DE SACY (1801-79), a journalist, was long one of the leading writers on the staff of the *Journal des Débats*, and in 1864 was appointed a member of the Council of Public Instruction. In 1855 he was elected a member of the Academy, and in 1867 of the senate. In 1858 he published a collection of his literary articles as *Variétés Littéraires, Morales, et Historiques* (2 vols.); and he edited in 1861-64 the *Letters of Madame de Sévigné* in 11 volumes.

Saddleback, or BLENCATHARA, a Cumberland mountain (2847 feet) of the Skiddaw group, 4½ miles N.E. of Keswick.

Sadducees, a Jewish school or party in New Testament times, the name most probably derived from one Zadok, founder of an aristocratic party, or from the race of the Zadokites, a family of priests at Jerusalem since the time of Solomon. The chief characteristics of the Sadducees were that they were an aristocratic party, and further that they acknowledged only the written *Torah* as binding, rejecting the entire traditionary interpretation and further development of the law during the course of centuries by the scribes. They thus rejected the whole body of Pharisaic tradition, representing at once an older *legal*, and an older *religious*, standpoint. Accordingly they refused to believe in a resurrection of the body, or any personal continuity of the individual, or retribution in a future life—a survival of original Old Testament theology; they denied angels and spirits; and they held that man enjoys freedom of will to do good or evil, and that his happiness or unhappiness is the work of his own hands alone. They obviously lacked the religious energy of the Pharisees, whose interests were centred in another world, and, partly also from their superior social position, became marked by superior culture, by worldliness, and by merely political aims. Thus Sadduceism is denounced by Jesus as 'the heaven of Herod,' while he only inveighs, as does the Talmud, against the hypocrites amongst the Pharisees. The Sadducees disappear with the fall of the Jewish state. We still find mention of them in the Mishna, but the notices in the Talmud are far from being clear.

See Schürer's *History of the Jewish People in the Time of Jesus Christ* (Eng. trans. div. ii. vol. ii. 1890); Wellhausen, *Die Pharisäer und die Sadducäer* (1874); Montet, *Essai sur les origines des partis Saducéen et Pharisién* (1884); and the articles JEW and PHARISEES.

Sade, DONATIE ALPHONSE FRANÇOIS, MARQUIS DE, a notorious French romancer, was born at Paris, June 2, 1740, fought in the Seven Years' War, and was in 1772 condemned to death at Aix for his nameless vices. He made his escape, but was afterwards imprisoned at Vincennes and in the Bastille, where he wrote his fantastically scandalous romances, *Justine* (1791), *La Philosophie dans le Boudoir* (1793), *Juliette* (1798), and *Les Crimes de l'Amour* (1800). Afterwards he went mad, and died at Charenton, 2d December 1814. His name has supplied to his language the useful term *Sadisme*. See the study by Janin.

Sádi (also spelt *Sa'di*, *Saadi*, and *Sa'adi*), the assumed name of the SHEIKH MUSLÍH ADDIN, one of the most celebrated of Persian poets, who was born at Shiraz about the year 1184. Little is known of the circumstances of his life. His father's name was Abdallah, and he was a descendant of Ali, Mohammed's son-in-law; notwithstanding his noble lineage, however, he held but an insignificant position. Sádi was early left fatherless. He received his education in science and theology at Bagdad, and from here he undertook, together with his master, his first pilgrimage to Mecca, a pilgrimage which he subsequently repeated no less than fourteen times. He travelled for a great number of years, and is said to have visited parts of Europe, Barbary, Abyssinia, Egypt, Syria, Palestine, Armenia, Asia Minor, Arabia, Persia, Tartary, Afghanistan, and India. Near Jerusalem he was taken prisoner by the Crusaders, not while fighting against them, but while practising religious austerities in the desert. He was ransomed for ten dinars by a merchant of Aleppo, who recognised him, and gave him his daughter in marriage; this union, however, did not prove happy. He married a second time, but lost his only son. The later part of his life Sádi spent in retirement near his native town, and he died at a very old age in 690 A.H., or 1263 A.D.; according to others, however, he did not die until 1291 or 1292 A.D. In person he is described as having been of rather insignificant appearance, short, slim, and spare. His was a contemplative, pious, and philosophical disposition. The years of his retirement he occupied in composing those numerous works which have made him justly famous through East and West. Although European critics would hardly be inclined to endorse to the full the judgment passed upon him by his countrymen, that he was 'the most eloquent of writers, the wittiest author of either modern or ancient times, and one of the four monarchs of eloquence and style,' yet there is no doubt that this 'nightingale of thousand songs' fully merited the honours showered upon him by princes and nobles, both during his lifetime and after his death. A mausoleum, with a mosque and college attached to it, was erected in his honour at the foot of the hills about 2 miles to the north-east of Shiraz, and the people, who soon wound a halo of legend around his life, flocked thither in pilgrimage.

The catalogue of his works comprises twenty-two different kinds of writings in prose and verse, in Arabic and in Persian, of which *ghazels* and *kassidas* ('odes,' 'dirges') form the predominant part. The most celebrated and finished of his works, however, is the *Gulistan*, or Flower-garden, a kind of moral work in prose and verse, consisting of eight chapters on Kings, Dervishes, Contentment, Taciturnity, Love and Youth, Decrepitude and Old Age, Education, and the Duties of Society, the whole intermixed with a number of stories, maxims, philosophical sentences, puns, and the like. Next to this stands the *Bostan*, or Tree-garden, a work somewhat similar to the *Gulistan*, but in verse, and of a more religious nature. Third in rank stands the *Pend-Nameh*, or Book of Instructions. Elegance and simplicity of style and diction form the chief charm of Sádi's writings. For wit he has been likened to Horace, with whose writings he may not have been unacquainted, since he is said to have known Latin.

The first complete printed edition of his works, called the *Salt-cellar of Poets*, by Harrington, was published in Calcutta (1791-95), and has been reprinted since by native presses in India. The *Gulistan*, first edited with a Latin translation by Gentius (Amsterdam, 1651), has been reprinted very frequently, and has been translated

into a number of European tongues, into English by Gladwin, Ross, Eastwick, and Platts; and see Robinson's *Persian Poetry for English Readers* (1883). The *Bostan* was first published complete in Calcutta in 1828 (Vienna, 1858), and has likewise been translated into other languages; *With Sa'di in the Garden*, by Sir Edwin Arnold (1889), is a translation of part of the *Bostan*. Many manuscript copies of Sâdi's works exist. A carefully collated MS. of the *Bûstân of Shaikh Muslih-ud-Din Sa'adi*, prepared by Platts, was photographed and published in London, with annotations by Rogers, in 1891.

Sadler, SIR RALPH, was born in 1507, and was employed by Cromwell, Henry, and Elizabeth in diplomacy with Scotland. He was left one of the twelve councillors of Edward VI.'s minority, fought at Pinkie, sat in the commission on Queen Mary at York, and was her gaoler at Tutbury. He was sent to carry the news of her execution to her son, and died himself soon after in 1587.

His *Papers*, of great value for Border and Scottish history generally, were edited by Sir Walter Scott, with a Memoir (1809).

Sadoletto, JACOPO, was born at Modena in 1577. His father, a distinguished jurist in Ferrara, was in a position to give his son every advantage of a liberal education. Sent by his father to Rome in 1592, he there found a patron in Olivero Caraffa (under whose roof he lived for some years), and eventually entered the church. On the accession of Leo X. the polished Latin style of Sadoletto gained him the position of apostolical secretary, an appointment he held under two other popes, Clement VII. and Paul III. By Leo he was also made bishop of Carpentras in 1617, though he did not leave Rome till four years later. Settled in his charge, he performed its duties with a devotion that commanded the respect even of those who had broken with the Church of Rome. Both by Clement VII. and Paul III. he was successively summoned to Rome to give his aid in the councils of the church. By the latter of these popes he was in 1536 made cardinal, greatly, he affirms, against his own will, as his chief desire was the pursuit of his favourite studies and the faithful performance of the duties of his charge. In 1544 he acted as legate to Francis I. on a fruitless mission to effect peace with Charles V. He died at Rome in 1547.

By his high character and his literary gifts and accomplishments Sadoletto ranks as one of the most distinguished churchmen of his age. While he cultivated classical studies with all the enthusiasm of the dissolute Bembo, he still preserved his Christian feeling and the sense of the responsibilities of his profession. He had sincerely at heart the reform at least of the discipline of the church, and had his counsels and example been followed Rome would have played a worthier part in the religious revolution of the 16th century. He corresponded with many of the Protestant leaders, and did his utmost to find a common basis on which reunion might be possible. His works mainly consist of his personal and official letters, and of commentaries on the Psalms and on the Epistles of St Paul. On these last Erasmus passes the curious criticism 'that their very polish of expression will with some take off the edge of their pious suggestion.' Sadoletto's complete works were published at Rome in 1759, with an annotated life prefixed. See Joly's *Étude sur Sadoletto* (Caen, 1856).

Sadowa. See KÖNIGGRÄTZ.

Safe-conduct. See PASSPORT.

Safed, one of the four holy cities of the modern Jews in Palestine, spreads in horseshoe shape round a hill 2700 feet above the Mediterranean, 6 miles NW. of the Sea of Galilee. Here dwell some 12,000 Jews, 5000 Moslems, and 200 Christians. The town was overthrown by earthquakes in 1759 and 1837. A castle of the Christians, built

during the Crusades, was destroyed by the sultan of Damascus in 1220, and, having been rebuilt by the Templars, was again taken and destroyed by Beybars of Egypt in 1266. The Jewish colony has been settled here since the 16th century, and embraces many immigrants from Poland.

Safes. The manufacture of iron safes for the preservation of money and valuable papers has become one of great importance. The foundation of the plan on which fireproof safes are still constructed was laid by a Mr Richard Scott in 1801. Mr Thomas Milner in 1840 patented a fireproof safe embodying the same principle, but with some improvements. In 1843 letters-patent were granted to Messrs Tann for the use of a mixture of pounded alum and gypsum, previously heated and cooled, as a fire-resisting medium placed between two plates of iron, from 3 to 6 inches apart, which together form the wall of the safe. Milner's plan was to fill the jacket formed by the double-plated sides with sawdust, in which were packed a number of small tubes filled with an alkaline salt. These tubes burst when exposed to heat, and the sawdust becomes pervaded with moisture. When alum or sulphate of alumina is used there can be no charring till the large quantity of water these salts contain is expelled; and this is a slow process, as the heat causes a protecting crust of the anhydrous salt to form on the inside of the outer plate. Fireproof safes are still made on the same principle.

Safes are made to resist the efforts of burglars by making the outer wall of three plates, the centre one being of very hard and the other two of mild steel. All three are screwed together from the inside. By this arrangement the wall is made very difficult to drill. To prevent the door being wrenched off by wedges or other means, Messrs Chubb make the bolts of the lock, which emerge from the four edges of the rectangular door, to shoot diagonally, and so dovetail the door at the top, bottom, and sides to the frame of the safe (see LOCK).

Public safe-deposits for the safe-keeping of important documents, cash, gold and silver plate, and other valuables, have been constructed in recent years in many American cities, as well as in London and other large towns in Great Britain. Some of these contain a large number of safes, the building of the National Safe Deposit Company, Queen Victoria Street, London, having room for as many as 20,000. The brick walls of this company's great safe-vault are 3 feet thick, faced externally with firebrick and lined internally with cast-iron plates, 4½ inches thick, strengthened by imbedded wrought-iron bars. The separate compartments of the vault have doors, 12 inches thick, formed of metal plates of different degrees of hardness. These weigh 4 tons each, and are raised and lowered, portcullis-like, by hydraulic power. Chancery Lane Safe Deposit was opened in 1885. Its chief portion consists of four strong rooms 'armour-plated' and built on iron columns in vaults, but completely isolated from the external walls, so that armed patrols (armed watchmen guard the above safe-vault also) can, during the night, walk round, over, and under them. These rooms contain about 5000 separate safes and have doors weighing 2 tons each, which by a clockwork arrangement can only be opened at certain hours. The lock of a single safe cannot be opened unless both renter and custodian are present as each has a different key for the same safe. In the case of the Safe Deposit, opened in 1891, in St James Street, London, the walls, roof, and floor are formed of a triple thickness of Siemens-Martin steel together having a minimum thickness of 1½ inch. The middle plate is of hard and the two outer plates are of soft steel, and

these three plates were riveted together by hydraulic pressure in such a way that the rivets swell out into the wider holes of the centre plate and therefore cannot be punched. As the rivets are made with a strand of hard steel, neither can they be drilled. See *Protection from Fire and Thieves*, by G. H. Chubb (1875). Various kinds of fireproof chambers are built with vaulted roofs and sides of strong masonry.

Safety-fuze. See BLASTING, and FUZE.

Safety-lamp. It has been long known that when methane, marsh-gas, or light carburetted hydrogen, which is frequently disengaged in large quantities from coal-seams, is mixed with ten times its volume of atmospheric air, it becomes highly explosive. Moreover, this gas—the *fire-damp* of miners—in exploding renders ten times its bulk of atmospheric air unfit for respiration, and the *choke-damp* thus produced is often as fatal to miners as the primary explosion. With the view of discovering some means of preventing these dangerous results, Davy instituted those important observations on flame which led him to the invention of the safety-lamp. He found that when two vessels filled with a gaseous explosive mixture are connected by a narrow tube, and the contents of one fired, the flame is not communicated to the other, provided the diameter of the tube, its length, and the conducting power for heat of its material bear certain proportions to each other; the flame being extinguished by cooling, and its transmission rendered impossible. In this experiment high conducting power and diminished diameter compensate for diminution in length; and to such an extent may this shortening of length be carried that metallic gauze, which may be looked upon as a series of very short square tubes arranged side by side, completely arrests the passage of flame in explosive mixtures. The following are Davy's directions regarding the structure of his lamp: 'The apertures in the gauze should not be more than $\frac{1}{8}$ of an inch square. As the fire-damp is not influenced by ignited wire, the thickness of the wire is not of importance; but wire from $\frac{1}{16}$ th to $\frac{1}{8}$ th of an inch in diameter is the most convenient. Iron-wire and brass-wire gauze of the required degree of fineness are made for sieves by all wire-workers, but iron-wire gauze is to be preferred: when of the proper degree of thickness, it can neither melt nor burn; and the coat of black rust which soon forms upon it superficially defends the interior from the action of the air. The cage or cylinder should be made of double joinings, the gauze being folded over so as to leave no apertures. When it is cylindrical, it should not be more than two inches in diameter; for in larger cylinders the combustion of the fire-damp renders the top inconveniently hot, and a double top is always a proper precaution, fixed at the distance of half or three-quarters of an inch above the first top. The gauze cylinder should be fastened to the lamp by a screw of four or five turns, and fitted to the screw by a tight ring. All joinings should be made with hard solder; and the security depends upon the circumstance that no aperture exists in the apparatus larger than in the wire gauze.' The oil is supplied to the interior by the pipe projecting from the right side of the figure, and the wick is trimmed by a wire bent at the upper end, and passed through the bottom of the lamp, so that the gauze need not be removed for



Fig. 1.
Davy Lamp.

this process. (The wire is here shown in the figure.) When a lighted lamp of this kind is introduced into an explosive mixture of air and fire-damp the flame is seen gradually to enlarge as the proportion of fire-damp increases, until at length it fills the entire gauze cylinder. Whenever this pale enlarged flame is seen the miners should depart to a place of safety, for although no explosion can occur while the gauze is sound, yet at that high temperature the metal becomes rapidly oxidised, and might easily break; and a single aperture of sufficient size would then occasion a destructive explosion. In a strong current of air the heated gas may be blown through the apertures of the gauze before its temperature is sufficiently reduced to prevent an explosion; but such a contingency may be guarded against by placing a screen between the draught and the lamp.

The first lamp which would safely burn in an explosive mixture of gas and air was contrived in 1813 by Dr W. Reid Clanny of Sunderland. Into this lamp fresh air was blown through water, and heated air escaped through water by means of a recurved tube. Such a lamp was unfit for ordinary use. George Stephenson invented a safety-lamp which was tried at the Killingworth pits in 1815, and the reader will find its merits discussed in Smiles's *Life of George Stephenson*. Both Clanny and Stephenson applied wire gauze cylinders to their lamps after Davy's came into use, or at least after a communication about it had been made to the Royal Society in 1815. Stephenson's lamp, or as it is called the 'Geordie,' has a glass cylinder inside the wire gauze, the former having a cap of perforated copper. Small orifices below the glass admit the necessary air, and when the air becomes highly explosive the light goes out, so that the lamp does not get overheated. To enable it to burn well this lamp requires to be either held or suspended. What has long been known as Clanny's lamp (not his original lamp) consists of a cylinder of thick glass round the light, and on the top of it resting on a metal ring is a narrower cylinder of wire gauze through which the feed air enters. In the first or earlier form of this lamp there is imperfect combustion and it is not very safe, but when the gauze is protected by a metal jacket or *bonnet* it appears to be secure in currents having a velocity of 25 feet per second. The Mueseler lamp resembles the Clanny in having a glass cylinder below and wire gauze above, but within the gauze top there is a central chimney opening just above the flame. The peculiar construction of this presents an obstruction of two gauzes to the inlet air, while the heated outgoing air only passes through one. Consequently the strong upward draught tends to draw the fresh air briskly through the gauze to the wick, thus keeping the two currents separate and ensuring a good combustion.

For many years after the Davy, the Stephenson, and the Clanny lamp were introduced, the air-currents in coal-mines seldom reached a speed of 5 feet per second. Nowadays, owing to improved ventilation, this speed sometimes exceeds 20 feet per second in the main airways, while in some mines it is not greatly less at the faces where the men are hewing the coal. The old forms of these lamps, though safe under former conditions, are consequently no longer secure. But the Davy lamp can be rendered safe by enclosing it in a lantern, and when so protected against strong currents it is called the 'tin-can Davy.' Nevertheless, this lamp is falling out of use on account of the miserable light which it gives. In the Final Report of the Commissioners on Accidents in Mines, published in 1886, the subject of safety-lamps is very carefully gone into. After describing a considerable number of these which had been

experimented with, they say: 'Many of the more secure lamps are, however, rendered unsuitable for regular use by one or more of the following circumstances; either they yield a very poor light, or they require most careful handling to prevent the light from being extinguished, or they are exceedingly sensitive to oblique currents, or they are so complicated as to present great difficulties in putting them together and lighting them.' The Commissioners add: 'But there are four lamps in which the quality of safety, in a pre-eminent degree, is combined with simplicity of construction and with illuminating power at least fully equal to that of any of the lamps hitherto in general use. These are Gray's lamp, Marsaut's lamp, the lamp of the latest pattern proposed by Evan Thomas (No. 7), and the bonneted Mueseler lamp. With the last care must be taken to avoid a considerable inclination to the vertical direction.'

Of these four lamps the one by M. Marsaut, of the Besseges Collieries, Gard, France, seems to have become the favourite; at least it is now very largely used. Like some other forms it is in principle a bonneted Clanny, but it is made with

either two or three wire-gauze covers, *c, c, c*, fig. 2. In common with the other three lamps mentioned above as exceptionally safe, the lower portion *g* consists of a glass cylinder surrounding the light on the top of which the gauzes are fixed. The curved arrows show how the air enters to support combustion, and the straight arrows how the products of combustion escape at the top; *w* is the wire for trimming the wick. This lamp made with three gauzes will not cause an explosion in so strong a current as 50 feet per second, or even when the inner gauze is at a bright red heat, unless it is kept in the fire-damp till the glass cracks; it may be said to be safe for three or four minutes. With two gauzes the light is two-thirds and with three gauzes it is one-half that of a standard candle, the light of the two-gauze kind being three and a half times greater than that of a Davy lamp.

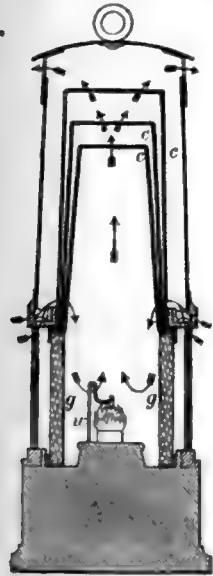

Fig. 2.—Marsaut Lamp.

To prevent safety-lamps being surreptitiously opened in a mine it is necessary that they should be locked. One of the best ways of doing this is to fasten the oil-vessel to the other part of the lamp by a riveted lead-plug, and impress it at each end with a mark which should be varied from day to day. Lamps have also been constructed which go out when opened, and one kind can be opened only by help of a powerful magnet.

As respects the illuminants for a safety-lamp seal-oil and refined rape-oil are the two staples, but the former is superior to the latter in burning qualities. Both are improved in this respect by the admixture of two parts of either with one part of petroleum or paraffin-oil of a flashing-point not lower than 80° F. This is considered a safe mixture. A patent was granted on February 16, 1889 (No. 2779) to J. Thorne for what is called the Thornebury miners' safety-lamp. The peculiarity of this lamp is that it is adapted to burn a heavy petroleum oil with a high flashing-point, and gives

a light from one to one and a half candle-power, which is much greater than that of other modern safety-lamps. It has been tested by Sir F. Abel and Professor Dewar, who report that the lamp fulfils the conditions essential to safety as laid down by the recent Commission on Accidents in Mines.

Electric glow-lamps are used for lighting up pit-bottoms and roadways, though hardly as yet for illuminating the working faces of mines. But portable, self-contained electric lamps that are perfectly safe have been devised which will furnish for several hours a considerably better light than that of the best safety-lamp in use. As air is completely excluded from these lamps they give no indication of the condition of the atmosphere of a mine, so that their employment would require the use of fire-damp detectors, and also of some ordinary safety-lamps.

Safety-valve, an apparatus the duty of which is to allow the steam to escape from a boiler when it reaches a certain pressure, and thus to prevent undue strain on the boiler-plates. The figure shows in outline the principle of this valve: *a, a* is a dome on the top of the boiler-shell; *b* is a conical brass valve resting on a seat, which has been smoothly bored for its reception; *e* is the fulcrum of a long lever *e, f*, from which at *d* there is a projection resting on the top of the valve. The end, *f*, of the lever is held down against the steam-pressure by the spring *h*. The pull exerted by this spring can be adjusted by a nut at *f*, and it is fitted with a brass case, and an index so arranged as always to point to a figure which indicates at what pressure per square inch the steam in the boiler will be able to lift the valve. For most stationary boilers a weight which can be moved along the lever to any desired position is used instead of the spring. In marine boilers the lever is frequently dispensed with altogether, and weights act directly on the valve. It is also usual,

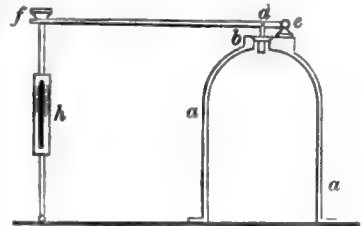

and in steamers compulsory by law, to put two safety-valves on each boiler, one adjustable at will by the engineer, and the other (called the 'government valve') enclosed in a case to which access can only be obtained by means of a key in the possession of the captain. The danger of explosion through overloading the valves is thus obviated. See also STEAM-ENGINE.

Safi, or ASFI, a seaport of Morocco, stands on a little bay on the Mediterranean coast, 120 miles WNW. of the city of Morocco. It is a compactly built place, dominated by a fine ruined castle of the sultans of Morocco dating from the 16th century. The place was held by the Portuguese for several years; they abandoned it in 1648. The fortifications they built still stand in part. The shrine of the Seven Sleepers here is visited by both Moslems and Jews. Safi was at one time the chief seat of the trade of Morocco with Europe, and, though it has declined since the rise of Mogador, it still exports beans, maize, pease, wool, olive-oil, &c. to the annual value of £151,600 (84 per cent. to Great Britain), and imports cottons, sugar, &c. to the average annual value of £65,900, more than one-half from Great Britain. Pop. 9000.

Safflower (*Carthamus tinctorius*), an annual herbaceous plant with large orange-red flowerheads,

belonging to the natural order Compositæ. It is believed to be indigenous to India and adjoining countries, but it may have had a wide distribution in the wild state, as safflower seeds have been found in ancient tombs in Egypt. Safflower is cultivated all over India, and to some extent also in Persia and Egypt, for the dye obtained from its flowers. It has likewise been cultivated in southern France and other countries. Formerly it was largely exported from India, but its importance in western Europe as a dyestuff has greatly diminished since the introduction of the coal-tar colours. Only 190 cwt. (value £830) was imported into Great Britain in 1889. The flowers yield both a red and a yellow dye, but the latter is of little value. A peculiar treatment of the flowers with an alkaline solution is required to obtain the red dye, which is called Carthamine. This substance dyes silk and also cotton of a beautiful red colour, but it is not permanent. It is used as a colouring matter of toilet Rouge (q.v.). The seeds of the safflower plant yield a useful lamp-oil, and they are given to fatten poultry. See DYEING, Vol. IV. p. 138.

Saffron consists of the dried stigmas of the flowers of the Saffron Crocus (*Crocus sativus*). It is used as a colouring material for some articles of food and medicinal tinctures. Formerly it was employed for dyeing fabrics yellow, and, to a slight extent, is so still in some countries. In Persia it is much consumed as a condiment, and for this purpose it is also used in Spain; whilst, according to Giraldus Cambrensis, it forms with milk the diet of the fairies. Saffron is cultivated in various districts in the south of Europe; and in England, where it is said to have been introduced from the East in 1339, it was much grown till about 1768 in Essex (round Saffron-Walden) and Cambridgeshire. It is also cultivated in Persia, Afghanistan, and Cashmere. The gathered stigmas of the plant are pressed under a weight, and heat applied till the cake-shaped mass is quite dry. From so small a portion of the plant being useful, a vast number of flowers are required to make a small quantity of saffron. There is accordingly a strong temptation to adulterate it,



Crocus sativus.

the flowers of Carthamus (safflower) being much used for this purpose, for which reason they are sometimes called bastard saffron. The strong tinctorial power of saffron is owing to the presence of a body called *polychroite* or *saffranin*.

Saffron was of much greater importance centuries ago than it is now. It was in favour with the ancient Greeks as a dye, and with both them and the Romans as a perfume. In the middle ages it was employed in cookery and as a drug. It is on record that as late as the 15th century persons were burned alive in Nuremberg for adulterating saffron. The yellow colour of this dyeing substance seems to have been applied to the dress of royal persons at an early time in Greece and in Ireland, and to the shirts of persons of rank in the Western Islands of Scotland down to a comparatively late period.

Saffron-Walden, a municipal borough of Essex, 15 miles S. of Cambridge, 27 NNW. of

Chelmsford, and 45 by a branch-line (1865) NNE. of London. The Saffron Crocus (see SAFFRON) was formerly cultivated here, and the name of the town is said to be derived from 'Saffron Woods.' The parish church, crowning a hill, is a stately Perpendicular structure, with a spire 108 feet high, and brasses and monuments—one to Lord Chancellor Audley (1488-1544). There are also remains of a Norman castle, a corn exchange (1848), a town-hall (1879), a cattle-market (1834), and a grammar-school, founded in 1423. Audley End, 1½ mile SW., the seat of Lord Braybrooke, was built in 1603 by Thomas Howard, Earl of Suffolk, and is still a magnificent mansion, though partly demolished since 1701. Pop. (1851) 5911; (1891) 6104. See works by Lord Braybrooke (1836) and John Player (1845).

Saga. See ICELAND, where the more important are enumerated, also the books of *The Saga Library*, by W. Morris and E. Magnusson (Lond. 1891 *et seq.*).

Sagaing, a decayed town of Burma, extends for a mile and a half along the right bank of the Irawadi, opposite to Ava. Its houses, mean and few, are embosomed in orchards and gardens, and embrace amongst them a great number of ruined temples. Sagaing preceded Ava as the capital, for a time, of Burma.

Sagan, a town of Prussian Silesia, the chief place (since 1397) in the principality of Sagan, on the Bober, 33 miles by rail W. by S. of Glogau. It has manufactures of cotton and woollen cloths, beer, &c. At the castle Wallenstein was visited (1629-30) by Kepler. Pop. 12,010.

Sagar, or SAUGOR, a well-built town in the Central Provinces of India, is situated in a hilly tract, on a feeder of the Jumna. There are here a Mahratta fort, now converted into British stores, barracks, and a magazine, as well as a gaol (1846) and a park (1862); and there were formerly a college (removed to Jabalpar) and a mint (removed to Calcutta). Sagar has a trade in salt, sugar, and cloth. Pop. (1891) 44,674.—The district has an area of 4005 sq. m. and a pop. (1891) of 591,743.

Sagar, a low, swampy island at the mouth of the Hugli, the holiest branch of the Ganges; it is particularly sacred in the estimation of the Hindus. Multitudes of pilgrims annually resort to it in January, and after the three days' festival of purification is over a great fair is held. The island has an area of 225 sq. m., but is very thinly inhabited, the greater part being jungle, the haunt of tigers and other wild animals. A lighthouse (1808), a meteorological observatory, and a telegraph station are the chief buildings.

Sagasta, PRAXEDES MATEO, statesman, born at Torrecilla, 21st July 1827, became an engineer, but taking part in insurrections in 1856 and 1866 had twice to flee for a time to France. He had a place in Prim's cabinet (1868), supported Amadeus, held office under Serrano, and under the new monarchy became leader of the Liberals, being minister in 1881-83, 1885-90, 1892-95, and again in 1898-99, during the disastrous war with the United States and the peace negotiations. His subsequent programme of internal reforms was hampered by ill-health and political difficulties.

Sage (*Salvia*), a genus of Labiatae, containing many species, herbaceous and half-shrubby. There are only two perfect stamens, the filaments of which bear at their summit a cross thread fastened by a joint. Common Sage, or Garden Sage (*S. officinalis*), so much grown in gardens as an aromatic herb for flavouring purposes in cookery, is a native of the south of Europe. It is possessed of active properties, as its powerfully aromatic

odour and bitter taste indicate. The leaves and flowering parts of the plant, infused as tea, are considered tonic and astringent. The tea, along with vinegar or alum and honey, is a valuable gargle in cases of inflammation of the throat and relaxation of the uvula. The plant contains an essential oil (*Oil of Sage*), which has been used in liniments against rheumatism; but its reputation for this purpose is not now so high as formerly. The oil contains much stearoptine. Sage grows



Sage (*Salvia officinalis*):
a, a flower.

best in a dry soil, and is easily propagated by slips or cuttings. Clary (q.v.) is a species of sage. Meadow Clary, or Meadow Sage (*S. pratensis*), is a common ornament of meadows and borders of fields in most parts of the continent of Europe and in the south of England. It has bluish-purple flowers. The Apple-bearing Sage (*S. pomifera*) is a native of the south of Europe and of the East, remarkable for its very large reddish or purple bracts, and for the large gall-nuts which grow on its branches, as on the leaves of the oak. The peasantry of Crete collect these nuts and sell them in the towns for the purpose of making sweetmeats; they have an aromatic sweet taste. Some of the species of *Salvia* have very beautiful flowers, and are prized ornaments of gardens and greenhouses.

Sage Cock. See GROUSE.

Saghalien, or SAKHALIN (though the proper name is Karafu), is a long (670 miles) and narrow (20 to 150 miles) island, running north and south, and lying close off the east coast of the Maritime Province of Siberia. The Strait (or Gulf) of Mami Rinso (or Tartary) separates it from the mainland; the Strait of La Pérouse parts its southern extremity from the Japanese island of Yezo; and the misty, chilly sea of Okhotsk washes its eastern and northern shores. Owing to the vicinity of this sea, to the presence of ice-floes off the east coast, and to the dense forests, chiefly of coniferous trees, which clothe the mountains (5000 feet) that run from end to end of the island, the rainfall is heavy and mists very prevalent, so that the climate is on the whole extremely raw and cold. The rivers are navigable only for very short distances; but they, as well as the adjoining seas, teem with fish, the rivers especially with salmon. Petroleum and naphtha exist in the island, and coal is mined by Russian convicts. Soon after the Russians became masters of the whole island (1875) they made an attempt to colonise it by means of convicts; but the scheme proved a failure, as neither the climate nor the soil are adapted for agriculture. Some 4000 to 5000 convicts are, however, employed to work the coal-mines. Area of island, 24,550 sq. m.; pop. 19,000, of whom one-half are Russians; the remainder belong to the Ainos (q.v.) and a couple of Mongolic races, with some Japanese.

Bears, sables, wild reindeer, tigers, and other wild animals occur. The vegetation is chiefly Siberian in character. Saghalien has been inhabited since the stone age, of which, as well as of the bronze age, many relics, such as dwellings, bones, implements, &c., have been discovered. It belonged to China until the beginning of the 19th century. The Japanese then considered themselves masters of the southern part down to 1875, when they ceded it to Russia, certain of the Kurile islands being granted in return. The Russians had begun to settle in the northern part about 1857, and now are masters of the whole island.

Saginaw, a city of Michigan, the third in population in the state, and the capital of Saginaw county, is situated on an elevated plateau on the banks of the navigable Saginaw River, 108 miles by rail NNW. of Detroit. It has some handsome public buildings, and is a flourishing city. It contains extensive manufactories of flour, salt, lumber, and barrels, and of sash, doors, blinds, &c. Pop. (1880) 10,525; of East Saginaw (with which it was incorporated in 1890), 19,016; together, 29,541; (1890) 46,322.—SAGINAW BAY, an arm of Lake Huron, the largest indentation of the southern peninsula of Michigan, is 60 miles long by 30 wide, and has several fine harbours. The river Saginaw (30 miles) falls into it.

Sagitta, or ARROW-WORM, a genus of small pelagic worms, included along with one other genus—*Spadella*—in the class *Chaetognatha*. The arrow-worms occur in all seas; they often measure about an inch in length, and are quite translucent. The animal is divided by two partitions into three regions, head, body, and tail. In the mouth there are sickle-shaped bristles or 'jaws,' to which the term *Chaetognatha* refers. There are two pairs of thin lateral 'fins,' and the tail is similarly fringed. The animals are hermaphrodite, the paired ovaries and testes developing from two cells which appear at a very early stage in the history of the embryo. Each cell divides into two—an ovarian and a testicular rudiment. The development is very regular; the anatomy of the adult is in many ways unique and of much zoological interest.

See *Chaetognathi* (1883), by Grassi, in the monographs on the Fauna of the Gulf of Naples; 'Die Chaetognathen' by P. Hertwig, in *Jenaische Zeitschft. f. Naturwiss.* xiv. (1880).

Sago, a nutritive, farinaceous substance obtained from the pith of several species of palms, principally, however, from *Sagus* (*Metrozylon*) *Rumphii*, the spiny, and *S. laevis*, which is spineless. For the natives of the Eastern Archipelago this palm is a source of vegetable food naturally more abundant and less variable in its yield than rice. The stem consists of a thin hard wall, about 2 inches thick, and of an enormous volume of a spongy medullary substance, which is edible. Each tree yields about 600 lb. of pith. There are three well-marked varieties of this palm. The tree grows in Java, Sumatra, Celebes, Borneo, Malacca, and Siam. The only countries, however, where it is found growing in large forests are New Guinea, the Moluccas, Celebes, Mindanao, Borneo, and Sumatra, being widely spread over the Moluccas, but confined to particular parts of the others. There is no regular fixed season for extracting the farinaceous pith, which is taken as occasion requires, and as the individual tree becomes mature, which is at about fifteen years.

These palms propagate themselves by lateral shoots as well as by seed, and they die after producing fruit, so that a sago-plantation once formed is perpetual. Sago-meal is eaten by the natives in

the form of pottage, and also partially baked in earthenware moulds into small square biscuits.



Sago Palm (*Metroxylon Rumphii*):
a, inflorescence; b, fruit.

cocoa-manufacturers for grinding up and giving thickness or consistence to the dietetic beverage made with it. Of sago about 15,000 tons are used in Britain, and of sago-flour 10,000 tons yearly. The imports of sago and sago-flour in 1890 were 557,018 cwt., valued at £273,000.

The stem, about 15 to 20 feet, is cut into lengths, split open, and the pith dug out and placed in a vessel with a sieve bottom. Water is applied to separate the flour and carry it into a second vessel, where it is soon deposited. The water is then run off, and the flour dried and put into little baskets made of sago-leaves. The produce of a tree ranges from 600 to 750 lb. Pearl-sago (which the Chinese of Malacca prepare and send to Singapore) is in small white spherical grains, varying in size from that of a poppy-seed to a grain of millet. There are several varieties which differ much in colour, some being white and others reddish brown like radish-seed. One kind of granulated sago from India has been introduced under the name of tapioca—the real Tapioca (q.v.) being a totally different substance. Sago is not entirely soluble in hot water like ordinary starch, and can therefore be employed in making puddings, &c., and in this way forms a valuable article of food, being cheap, light, nutritious, and easy of digestion.

Saguenay, a large river of Canada, falling into the estuary of the St Lawrence on the north side, about 115 miles below Quebec. It drains Lake St John, and flows in an almost straight line about 100 miles east-south-east. In its upper part, amid a wilderness of hills, it has numerous cataracts; but in the lower course, from the village of Chicoutimi down, it flows between precipitous cliffs, often from 500 to 1500 feet high, and is in many places 2 or 3 miles broad, while the depth varies from 17 to 170, and even, near the mouth, to 600 fathoms. The largest vessels can ascend to Ha Ha Bay, 10 miles S. of Chicoutimi; and during the summer great numbers of tourists visit the river, attracted by its magnificent scenery.

Saguntum, a wealthy and warlike town of ancient Spain, in Hispania Tarraconensis, stood on an eminence near the mouth of the Pallantias, its site occupied by the modern town of Murviedro. Founded, according to Strabo, by Greeks from

Zacynthus, it became at an early period celebrated for its commerce, and attained to great wealth. But the one event in its history was its siege and destruction by the Carthaginians, under Hannibal, in 219 B.C. Having held out the greater part of a year against an army of 150,000 and a consummate general, the famished Saguntines concluded their resistance with an act of heroic self-sacrifice. Heaping their valuables into one vast pile, and placing their women and children around it, the men made their last rally against the enemy, and the women fired the pile they had prepared, cast themselves upon it with their children, and so found in the flames the fate their husbands met in battle. The destruction of Saguntum directly led to the second Punic war.

Sahara (Arab. *Sah'ra*), the vast desert region of North Africa, stretching from the Atlantic to the Nile, and from the southern confines of Morocco, Algeria, Tunis, and Tripoli southwards to the vicinity of the Niger and Lake Tsad. It is usual to regard the Libyan Desert, lying between Egypt, the central Soudan, and Tripoli, as a separate division. Both are, however, links in the chain of great deserts that girdle the Old World from the Atlantic coast across Africa, Arabia, Persia, Turkestan, and Mongolia to the Pacific. It was long customary to assert that the Sahara was the bed of an ancient inland sea, and that it consisted of a vast, uniform expanse of sand, swept up here and there into ridges by the wind. But this idea is utterly erroneous. Since the French became masters of Algeria, and more especially in recent years, they have completely revolutionised our knowledge of the Sahara, at all events of the country immediately to the south of Algeria and Tunis. The surface, instead of being uniform and depressed below sea-level, is highly diversified, and attains in one place an altitude of fully 8000 feet. But, in spite of our knowledge of this part of the world having been so greatly increased of late, there are several extensive tracts as to which we have next to no information. The present article will therefore only touch upon the more outstanding features.

From the neighbourhood of Cape Blanco in the west a vast bow or semicircle of sand-dunes stretches right round the northern side of the Sahara to Fezzan, skirting the Atlas Mountains and the mountains of Algeria. This long belt of sand-hills varies in width from 50 to 300 miles, and is known by the names Igidi and Erg, both meaning 'sand-hills.' The hills rise to 300 feet (in one place, it is said, to more than 1000 feet), though the average elevation is about 70 feet. They are composed of pure quartz sand, reddish brown in colour; are stationary in character, though constantly changing their outward form and configuration; and lie as a rule in parallel chains, whose outward slopes are fairly gentle, but their inward slopes steep. Water is nearly always to be found below the surface in the hollows between the different chains of these sand-hills, and there a few dry plants struggle to maintain a miserable existence. South of Algeria, on the other side of the Erg, the country rises into the lofty plateau of Ahaggar (4000 feet), which fills all the middle parts of the Sahara. Its surface runs up into veritable mountains 6500 feet high, which, incredible as it may seem, are covered with snow for three months in the year. On the south it apparently falls again towards the basins of the Niger and Lake Tsad; nevertheless there are mountain-ranges along the eastern side reaching 8000 feet in Mount Tusidde in the Tibbu country, and a mountain-knot in the oasis of Air (or Asben) which reaches up to 6500 feet. Mountainous tracts occur also in the west, between Morocco and Timbuctoo, but of inferior elevation (2000 feet). These

mountainous parts embrace many deep valleys, most of them seamed with the dry beds of ancient rivers, as the Igharghar and the Mya, both going some hundreds of miles northwards towards the 'shotts' (see below) of Algeria and Tunis. These valleys always yield an abundance of water, if not on the surface in the watercourses, then a short distance below it, and are mostly inhabited, and grazed by the cattle and sheep and camels of the natives. Another characteristic type of Saharan landscape is a low plateau strewn with rough blocks of granite and other rocks, and perfectly barren. These elevated stone-fields, called 'hammada'—the best known is the Hammada el-Homra, south-east of Ghadames and on the border of Tripoli—alternate with tracts of bare flat sand, with broad marshes, where water has stood and evaporated, leaving salt behind it, and with extensive tracts of small, polished, smoothly-rounded stones. In very many parts of the Sahara, especially in the valleys of the mountainous parts, in the recesses or bays at the foot of the hills, alongside the watercourses, and in the hollows of the sand-dunes, in all which localities water is wont to exist, there are oases—habitable, cultivable spots, islands of verdure in the midst of the ocean of desert. These oases occur in greatest number along the southern face of the Atlas and the Algerian mountains, on the northern side of the Abaggar plateau, and along certain definite lines, the chief of which extend between Murzuk in Tripoli and Lake Tsad, the Igharghar and Sokoto by way of Air, the Igharghar and the bend of the Niger by way of Timissao, Morocco and Cairo by way of Tafilet, Tuat (Ainsalah), and Ghadames, and Morocco and Timbuctoo by way of Tenduf and Taudeni. These lines of oases mark the great caravan-routes between the central Soudan states and the Mediterranean.

A large portion of the Sahara, though not the whole, was undoubtedly under water at one time, probably in the Cretaceous period and earlier. Then the surface seems to have been in great part elevated, so that the water remained only in some lakes and in gulfs near the Mediterranean coast. The physical features that at present characterise the Sahara are undoubtedly due in their broad essentials to atmospheric, chemical, and even mechanical causes, and only in a very small degree to the action of water. Water has exercised scarcely any influence on a large scale here since the Tertiary period; and there can be no doubt that a process of desiccation, similar to that which is now going on in the Turkestan deserts, has been in operation throughout the whole of this region from the earliest historic time. The Romans had colonies or military posts a long way southwards, in what are now desert regions; and both Herodotus and Pliny tell us that the elephant, the rhinoceros, and the crocodile, all animals that only live near abundant supplies of water, were common throughout North Africa in their day. None of the Egyptian inscriptions or animal-sculptures represent the camel, nor do the Greek and Roman historians mention it either as being a denizen of North Africa. The camel is now the principal carrier across the Sahara, and must have been introduced since the beginning of the Christian era. The inference from these and other facts is that the process of desiccation has gone on more rapidly during the last 2000 years. The position of the sand-dunes is determined by the unchangeable configuration of the surface; the wind and chemical action do all the rest. The sand itself is simply the Saharan rocks (granite, gneiss, mica-schists, and cretaceous rocks) ground to dust. The great heat by day causes the rocks to expand; the great fall of the temperature at night, combined with the enormous evaporation that then

takes place, makes them split and crack, and break into pieces; and the strong, often violent, winds use these fragments like files, or even sand-blasts, with which to grind to pieces other rocky fragments. The terrors of the desert sand-storm have been often described (see DESERT). Thick deposits of Saharan quartz sand-dust were discovered by the *Challenger* on the floor of the Atlantic a long way west of the African coast. The sand in the dunes is so dry that in several places the tread of a camel or a man will make the hill hum, or even thunder, as a vast quantity of it slips down to a lower level. The range of temperature is exceedingly great: often the thermometer falls from considerably more than 100° F. during the day to just below freezing-point at night. In the west of the Sahara the daily average is 85° in the shade in the month of May. Rain does fall in certain parts of the Sahara with more or less frequency; but in most districts on the average after intervals of two to five years. After a fall of rain it is not unusual to see the riverbeds in the mountainous regions filled with foaming torrents. But the atmosphere is so dry and clear that objects can be seen and sounds heard at a vast distance. The Mirage (q.v.) is no uncommon feature. Owing to this extreme dryness of the air, the Sahara, especially where it is reached by the prevailing west and north-west winds, is very healthy.

The plant-life is very rich in the oases, the date-palm, which has its home in these regions, being the principal ornament as well as the most valuable possession of these fertile spots. But fruit trees, as oranges, lemons, peaches, figs, pomegranates, &c., are also grown, with cereals, rice, durra, millet, and such-like food crops. In the desert regions the plant-life is confined principally to tamarisks, prickly acacias and similar thorny shrubs and trees, salsolaceae, and coarse grasses. The animals most commonly met with include the giraffe, two or three kinds of antelope, wild cattle, the wild ass, desert fox, jackal, hare, lion (only on the borders of the desert), ostrich, desert lark, crow, viper, python, locusts, flies. The people keep as domestic animals the camel, horse, ox, sheep, and goat.

The human inhabitants, who are estimated altogether at between 1,400,000 and 2,500,000, consist of Moors, Tuareg, Tibbu, Negroes, Arabs, and Jews. The Moors and Tuareg are both Berbers (q.v.); the former live between Morocco and Senegal, the latter in the middle, south of Algeria and Tunis. The Tuareg are great traders, and control the principal caravan-routes. The Tibbu, who number about 200,000, and are regarded as being ethnically intermediate between the Berbers and the Negroes, occupy the oases between Fezzan and Lake Tsad. The Arabs of pure stock are very few; they have become mixed with the Berbers and the Negroes. The most valuable products of the Sahara are dates and salt, the latter collected on the salt pans, and made from the rock-salt of Taudeni in the west, and of Kawar (Bilma) in the east; the remaining products are horses, soda, and a little saltpetre. But for many long years there has been a very active trade carried on by caravans, between the central Soudan and Niger countries and the Mediterranean states, the ivory, ostrich-feathers, gums, spices, musk, hides, gold dust, indigo, cotton, palm-oil, shea-butter, kola-nuts, ground-nuts, silver, dates, salt, and alum of the interior lands being exchanged for the manufactured wares (textiles, weapons, gunpowder, &c.) of European countries. The French desire to get this trade into their own hands, and are proposing to construct a trans-Saharan railway, light and of narrow gauge, from the coast to the shores of Lake Tsad and the Niger.

They also entertain the grandly ambitious idea of uniting their possessions on the Senegal and on the Niger with Algeria and Tunis. This union has, indeed, been theoretically accomplished already by the agreement of 1890 between Great Britain and France, by which the whole of the Sahara, except the west coast (which is claimed by Morocco and Spain and Great Britain) and the extreme east (beyond a line drawn from Murzuk in Fezzan to Lake Tsad), was acknowledged 'to be within the French sphere of influence.' The proposed trans-Saharan railway would make this union more practical, especially if the railway line were taken from Algeria to near Timbuctoo, a distance of 1750 miles, as one scheme proposes. Alternative routes are to connect the Algerian system with Kuka on Lake Tsad (2250 miles), to build a line from near Cape Nun on the Atlantic to Timbuctoo (1100 miles), and to connect the Senegambian coast by a line over Futa-Jallon with the upper Niger.

Within recent years scientific men have eagerly discussed the possibility of reclaiming the Sahara from the arid desolation to which such a vast proportion of its surface is now abandoned. That no amelioration can be effected in the great bulk of its area is pretty well agreed; and if the desiccation is principally due, as has been maintained, to continental changes of elevation, it is pretty certain that nothing can be done. But the destruction of forests on the northern mountain-slopes is believed to be a co-operating cause. If so—for the fact is doubtful—this could be remedied. Two other schemes have, however, been proposed, and one of them has been carried out with admirable success. Westward from the Gulf of Cabes stretches for 250 miles a chain of salt lakes (*shotts*) right along the south of Tunis and Algeria, to the meridian of Biskra. Into these Captain Roudaire proposed (1874) to let the waters of the Gulf of Cabes by cutting through a ridge, 13 miles wide and 150 feet high, and so making an inland sea of some 3100 sq. m. in area with an average depth of close upon 80 feet. The scheme is, in point of engineering, practicable; but it is questionable whether it would accomplish the desired effect of modifying the climate and soil of the surrounding regions any more than the Sea of Aral or the Caspian does. At all events the proposal has been allowed to drop. In 1877 Mr Donald Mackenzie propounded the idea of flooding the western Sahara, the district called El Juf, by letting in the waters of the Atlantic; but the German traveller Lenz ascertained that El Juf was not a vast depression, but only a small valley. The other measure is the boring of Artesian Wells (q.v.), and with the water so obtained irrigating the soil in the vicinity. This method of reclaiming the desert, which was apparently known to the ancients, has been prosecuted by the French with great energy since 1856. By 1890 they had made a string of these wells from the cultivated districts of Algeria as far as Tugurt, on the edge of the desert, south of Biskra. Water is generally found at depths varying from 10 to 300 feet, and in great abundance. Wherever these wells have been bored the date-palm groves and the orchards have increased greatly in extent, and the population has become much denser.

In 1890 Cardinal Lavigerie, Archbishop of Carthage (Tunis), founded at Biskra a lay order called the Armed Brothers of the Sahara; their duties are to convert the native inhabitants, to protect and assist escaped slaves, and to tend the sick and wounded.

There is no single work treating of the Sahara as a whole. The best sources are the reports of French explorers, to be found in the *Proceedings of the Paris Geographical Society*, and Zittel, *Die Sahara*, three

physische und geologische Beschaffenheit (Kamel, 1884); *Nochtigal, Sahara und Sudan* (3 vols. 1879-89); Barth, *Travels in North and Central Africa* (5 vols. 1857-58); Lenz, *Timbuctoo* (1884); Rohls, *Quer durch Afrika* (1874), &c.; Duveyrier, *Les Touaregs du Nord* (1864); Tchihatchef, *The Deserts of Africa and Asia* (Brit. Assoc. Reports, 1882); Rolland, *Géologie du Sahara* (1891); French books of travel by Soleillet (1876), Choisy (1881), Largeau (1882), and Douls (1888). For the railway schemes, see *Comptes Rendus* of Paris Geog. Soc. (1890); and Donald Mackenzie, *Flooding of the Sahara* (1877).

Saharanpur, a town of British India, North-west Provinces, is situated 125 miles by rail N. of Delhi, and is the station for the hill sanatorium of Masuri (Mussoorie). It has an old Rohilla fort, a handsome new mosque, St Thomas' Church (1858), numerous administrative offices, and government botanical gardens (1817). It was formerly notorious for its malaria, but has vastly improved in this respect since a marsh to the east of the town has been drained. Pop. (1872) 43,844; (1881) 59,194; (1891) 63,194.—The district has an area of 2221 sq. m. and a pop. of 979,544.

Sahib (Arab, 'master', 'lord'), the usual title in India and Persia of a respectable European, equivalent to Mr, Sir, &c. Hence *Sahib* is the term for Lady, Madam.

Saida. See SIDON.

Sa'id Pasha. See EGYPT, Vol. IV. p. 242.

Saiga. See ANTELOPES.

Saigon, capital of French Cochinchina, stands on the river Saigon, a branch of the delta of the Mekhong, about 60 miles from the sea by river. The present town has grown up under French influences since 1861, and with its fine streets and squares, and boulevards, is one of the handsomest cities of the East. It has a magnificent governor's palace, a cathedral (1877), two higher colleges, an arsenal, a floating-dock and a dry-dock, administrative offices, and a botanical and zoological garden. Its population, consisting principally of Chinese, Annamese, and French, amounted to (1881) 13,481, and (1890) 16,213. But the business suburb of Cholon, 4 miles to the south-west, had (1885) 27,589, and (1890) 39,925 inhabitants, more than half Chinese. Saigon (properly *Gia-dinh*) is the most important port between Singapore and Hong-kong. It exports every year rice, chiefly to China, the Philippines, Japan, and the Straits Settlements, to the value of £1,440,000 to £1,720,000. The remaining exports include fish, salt, cotton, wood, beans, and hides. The port is entered by 400 to 500 vessels of 460,000 to 560,000 tons annually, of which nearly one-fourth are British; then come German and French. Previous to the French occupation (1861) Saigon, although only a collection of common Siamese huts, was the capital of the province of Lower Cochinchina.

Sail, a sheet of canvas or other suitable material which is spread to the wind to cause a boat or ship to move through the water. In Britain flax and hemp are the materials of which sail-cloth is usually made; jute, cotton, and linen, and mixtures of these are also used by civilised peoples. Amongst savages matting and tissues of various vegetable fibres are used. Sails are extended by means of masts, yards, booms (at lower edge of fore-and-aft sails), gaffs (at upper edge), ropes, and combinations of these. Sails may be of various shapes, and of any size, according to the carrying power of the vessel. A vessel of shallow draught or of narrow beam can bear comparatively little sail; while a vessel of proportionately deep draught, and heavily ballasted—as a yacht—or a vessel of great breadth of beam, can carry sail of great area. A sail acts with the greatest power when the wind is directly astern, as in fig. 1; but it can be applied, though with

less strength, when on either beam. The action of the wind on an oblique sail is a good example of what is known in mechanics as 'the composition

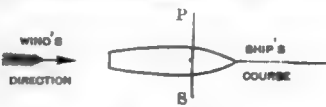

Fig. 1.

and resolution of forces.' Let TD, fig. 2, be a ship, PAS its sail, WA the direction of the wind, and let the length of WA represent the pressure of the wind on the sail. WA can be resolved into AB perpendicular to the sail, and BW parallel to it, the latter of which has no effect in pressing on the sail; therefore AB is the effective pressure on the sail. Were the vessel round, it would move in the direction BA. Let BA be resolved into CA



Fig. 2.

and BC, the former, CA, acting in the direction of the keel or length of the vessel, or in the direction CAD, and the latter perpendicular to it, or in the direction of the breadth. The former pressure, CA, is the only pressure that moves the vessel forward, the other, BC, makes it move sideways. From the form of the vessel, however, this latter force, BC,

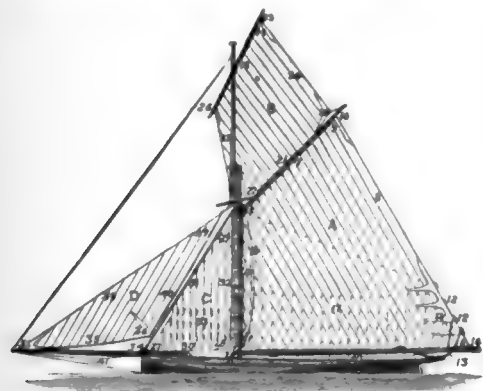

Fig. 3.—Sails of a Cutter Yacht, with the names of the different parts:

MAINSAIL, A.—1, main-tack; 2, main-tack tackle; 3, main-tack tricing-line; 4, neck or throat; 5, peak; 6, clew; 7, head; 8, leach; 9, luff; 10, foot; 11, strengthening piece; 12, cringles; 13, reef pennants rove; 14, main clew lashing; 15, mast hoops and seizings; 16, peak earing; 17, reef knittles or points.

GAFF-TOPSAIL, B.—18, head; 19, peak; 20, clew; 21, foot; 22, tack; 23, luff; 24, leach; 25, peak earing; 26, head earing.

FORESAIL, C.—27, fore-tack; 28, clew; 29, head; 30, foot; 31, luff; 32, leach; 33, reef knittles or points; 34, fore-tack tackle rove through a sheave in stem-head.

JIB, D.—35, tack, hooked on to the traveller; 36, clew; 37, head; 38, foot; 39, luff; 40, leach; 41, inhaul of the traveller.

produces comparatively little lateral motion; any that it does occasion is called *leeway*. It results, therefore, that with the wind exerting an oblique pressure, the actual progress will be to the power of the wind only as CA is to WA.

Sails may practically be divided by their shape into the approximately triangular and approximately square; and according as they are set parallel to the keel of the ship or across the ship, they are *fore-and-aft* sails or *square* sails. The sails which are set square across the ship are not exactly, but nearly, square in shape. But many

fore-and-aft sails are also nearly square, or at least four-sided; the chief exception to this being *stay-sails*, which are purely triangular, and are suspended on the ropes which stay the masts upon the foresides—from the jib-boom, bowsprit, and deck in the case of the foremast, and from the deck in the case of the mainmast. Two of these staysails, the fore-staysail and the jib, are common to most types of boats referred to in this article.

The larger sailing-vessels are usually propelled by a combination of fore-and-aft and square sails in varying number; the name and position of these are illustrated at the article SHIPBUILDING. The Schooner (q.v.) has mainly fore-and-aft sails on both masts, though the square-topsail schooner carries square topsails. The two-masted Brig (q.v.) is mainly square-rigged; and the brigantine is a cross between brig and schooner. The Cutter (q.v.) is the typical fore-and-aft one-masted. The names of the several sails, and the technical terms for the parts of the sails, will be gathered from the accompanying illustration (fig. 3). A *sloop*

is supposed to have a fixed bowsprit, whereas that of the cutter is a running one. A *yawl* has a foremast rigged exactly like a cutter, but has a small mizzenmast carrying a *spanker* or *driver*. See YACHT.

Some other types of sail not shown in the figures in the articles referred to may be noted here. The *lug-sail*, a four-sided sail hung from a yard fastened obliquely to the mast, about one-third of its length from the one end. Luggers may be one, two, or three masted, and may accordingly vary much in size. The typical *shoulder-of-mutton sail* is a triangular sail set on a boat's mast; the tip is sometimes made into a separate gaff-topsail. The *sprit-sail* is a quadrangular sail stretched from the mast by help, not of a gaff along its top, but by a sprit extending from the foot of the mast diagonally to the upper aft-most corner of the sail. The London barge has its heavy mainsail partly supported by a sprit, and there is a spanker on a small mast behind (see Vol. VI. p. 702). The spinnaker is a jib-like racing sail carried by yachts, and extended to catch the wind on the side opposite the mainsail. Many American centre-board boats carry one large quadrangular fore-and-aft sail only, the mast rising out of the bow of the boat.

The *lateen* sail, much used in the Mediterranean, is a triangular sail stretched from a long yard attached to a short mast, as shown in fig. 6. The *felucca* is a two-masted lateen-sailed boat; the sails of the Egyptian *dahabeeah* and of the Arab *dhow* are of the same type. A *vebec* carries a combination of lateen and square sails.



Fig. 4.—Lug-sail.



Fig. 5.—Sprit-sail.

The South Sea *proa*, the Chinese *junk*, and other local rigs have many peculiarities in their sails. Naval rigs are illustrated at NAVY. See also

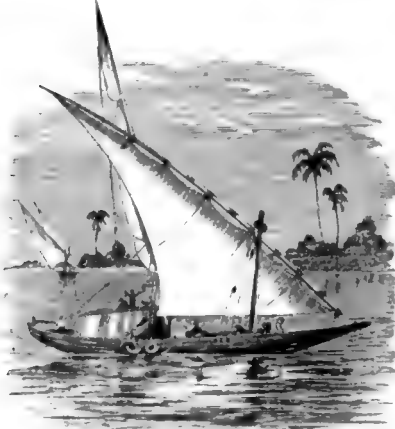

Fig. 6.—Dahabeeah.

the articles SHIPBUILDING and YACHT; and for Sailing or Navigation, see GREAT CIRCLE SAILING, LATITUDE AND LONGITUDE, MERIDIAN, SEXTANT, STEERING, &c.

Saima, LAKE. See FINLAND.

Sainfoin, or SAINTFOIN (*Onobrychis sativa*), a plant of the natural order Leguminosæ, sub-order



Sainfoin (*Onobrychis sativa*).
(Stebler and Schröter, Best Forage Plants.)

Papilionaceæ, of a genus nearly allied to *Hedysarum* (see FRENCH HONEY-SUCKLE), but having one-seeded pods, which are marked with wrinkles or pits, and are more or less prickly toothed at the margin. It is a spreading perennial, about two or three feet high, with leaves of nine to fifteen smooth acute leaflets, and spikes of beautiful flesh-coloured flowers, striated with rose-red, on long stalks. It is a native of the continent of Europe and of the south of England, and is much cultivated as

a fodder-plant in dry, and particularly in calcareous soils, to which it is admirably adapted. Its cultivation was introduced into England in 1651; and before the introduction of turnip-husbandry the sheep-farmers of the chalk districts depended almost entirely upon it, as they still do to a large degree. It is, however, a very local crop, being scarcely cultivated on any but the most calcareous soils, where scarcely anything else is equal to it, although it has been found to succeed well on any soil sufficiently dry. There is no more nutritious fodder than sainfoin, whether for sheep, oxen, or horses. Even the dry stems of a crop which has produced seed are readily consumed by cattle, if cut into small pieces. Sainfoin is a deep-rooted plant and sometimes endures for ten, or even

fifteen years on the same land—more generally only for four to seven years; and in the eastern counties of England it is often sown instead of clover on light and somewhat calcareous sands and sandy loams, and the ground is ploughed again in two or three years.—The name *sain-foin* probably means 'wholesome hay' (from Lat. *sanus*), and not, as is often assumed, a shortened form for *saint-foin* ('holy hay').

Saint, a name applied in the New Testament to the members of the Christian community generally, but restricted by ecclesiastical usage from very early times to those who have been specially remarkable for their personal virtues and their eminent services to the cause of religion. In the ages of persecution the quality which most of all challenged the admiration and reverence of the faithful was naturally constancy in the profession and the defence of the Christian faith; and the honours of the martyrs, even before the age of persecution had passed, were extended to confessors, and eventually to all who died in the odour of sanctity, and especially to those who also obtained the reputation of performing miracles. In general, however, the saints of the Catholic Church are distributed into several classes, chiefly in relation to the special character of the ecclesiastical offices appropriated to their honour. Thus we find enumerated (1) Apostles and Evangelists; (2) Martyrs; (3) Confessors, a name applied primitively to those who had courageously undergone imprisonment or pains for the faith without gaining the final crown of martyrdom, but in later times understood of all who, not being martyrs, were eminent for sanctity of life; (4) Doctors or saints eminent for sacred learning; (5) Virgins; (6) Matrons and Widows. Anciently the title of Saint was bestowed upon an individual by the members of the particular Christian community to which he belonged, or to which his merits were most familiar. In the earliest times, however, the letters of St Cyprian show that caution was observed by the bishops to guard against the recognition of undeserving persons. It was not, however, till the 12th century that the pope reserved to himself the exclusive right to add to the roll of saints, or that a regular form of procedure was established in the Roman courts for the purpose of testing and of solemnly pronouncing upon the title of persons, who had died with a reputation for sanctity, to the public *cultus* of the church. A saint, according to the received interpretation, is one who has exercised the three theological virtues of faith, hope, and charity, and the cardinal virtues, prudence, justice, fortitude, in a heroic degree, and has persevered in this exercise until death. Sanctity may exist without miracles, as, according to the commonly alleged instance, there is no record of John the Baptist having wrought miracles; and, on the other hand, miracles may be performed by heretics or sinners. Nevertheless, by the existing discipline of the Roman Church, before a decree of Canonisation (q.v.) can be obtained, the rule requires evidence of such miracles as an expected fruit of heroic faith and as a confirmatory sign of sanctity after proof has been given of the heroic virtues.

It is difficult to estimate with anything approaching to exactness the number of saints who have received *cultus* as such in the various churches of Christendom from the earliest times. Of many almost all record has perished, except their names commemorated in some ancient calendar or preserved in the dedication of some church or sacred locality. The fullest list is that to be found in the index or general table in the sixty-first volume of the colossal work of the Bollandists (see ACTA SANCTORUM). From these tables it appears that

biographies or notices have been given of about 17,000 saints in the preceding sixty volumes—that is, up to the end of October; and further, there are added the names of some 3500 for whom biographies were being prepared for the concluding volumes of the work not yet finished. But the authority, however great, which is due to these researches is no more than the authority of learned men. The catalogue which possesses the highest ecclesiastical authority, and which has the character of a liturgical or church service-book, is that of the *Martyrologium Romanum*, revised by order of Gregory XIII in 1586 by Baronius (q.v.), and frequently supplemented since. The breviary prescribes that the 'Martyrology' be read as part of the office of Prime wherever the office is solemnly sung in choir; and it is the custom, moreover, in religious communities to read the 'Martyrology' for the day publicly in the refectory. The 'Martyrology' is not, as its name might suggest, confined to the commemoration of martyrs only. It comprises the saints of every class to whom the Roman Church gives authentic recognition, and names some 2700 in all, including about twenty saints of the Old Testament, arranged as in a calendar according to the days of their celebration; while the recital for each day terminates with the clause, 'And in other places of very many other holy martyrs, confessors, and holy virgins.' It is plain that of this multitude only a select few can have festivals assigned to them in the ecclesiastical year, or proper offices in the breviary or missal.

About two-thirds of every month in the Roman calendar is occupied with special saints' days, though, on some of these, minor saints are commemorated by a collect or prayer. But the Roman calendar is modified or supplemented in a greater or less measure in every national church, every diocese, and every religious order or community. Thus to the Roman breviary in England is added a supplement containing the offices of the English saints who sometimes displace or transfer to another day the saints of the Roman calendar. The fixed calendar of saints' days in use in various Catholic countries or communities thus varies considerably. At the end of the useful handbook by Canon Husenbeth, entitled *The Emblems of Saints*, will be found printed in parallel columns for purposes of convenient comparison eight such calendars—the Roman calendar, two old English calendars, the Scottish, the French, the Spanish, the German, and the Greek. It should further be noted that the actual calendar of saints' days in use in any given year can never quite correspond with the fixed calendar of this or that diocese or community. The great movable feasts determined by the annually varying date of Easter constantly disturb the order of the calendar, and lead to transferring the observance of a saint's day to some proximate *feria* or vacant day, and in some cases to extinguishing it altogether. The complicated rules which regulate these changes are based upon the different ranks accorded to the feasts—doubles of the first class, doubles of the second class, greater doubles, doubles, semi-doubles, and simples—in their relations to one another and to the Sundays and movable feasts which also have their various ranks.

Thus, to take an example of these variations at random, the 26th of May is the festival of St Philip Neri in the Roman calendar, but in England his place is taken by St Augustine of Canterbury, while St Philip is regularly transferred to the following day. On the other hand, in the churches of the Congregation of the Oratory the feast of their founder keeps his own day even in England, and St Augustine is postponed to 6th September. Again, the 26th of May is specially liable to be

invaded by the occurrence of movable festivals. Thus, in 1877 the English churches had to transfer St Augustine to the 30th of the month, and St Philip Neri to the 23d of June. The result is that a special local 'ordo' is annually printed for the use of the clergy, and the annual *Catholic Directory* for England gives separately the fixed calendar and the ecclesiastical calendar corresponding to the clerical 'ordo' for the year.

In Christian art representations of the saints are often marked by the nimbus, aureole, or glory (see NIMBUS), and many of the saints are pictured as accompanied by emblems, by which they could readily be recognised. Apart from symbols which only typified the person indicated (as a shepherd for Christ, a gourd or a whale for Jonah), the figure of the saint is given with an added emblem. Thus the four evangelists were symbolised by four rivers, the four rivers of paradise. The adoption of the four living creatures (Rev. iv. 6) for the same purpose does not appear to have taken place till the 5th century; but soon it became a constant practice to represent St Matthew by or with the man, Mark with the lion, Luke with the ox, John with the eagle. The twelve apostles are depicted as twelve men, twelve sheep, or twelve doves. St Peter, for obvious reasons, is represented with the keys or with a fish; many of the saints with the instruments by which they were martyred—St Paul with a sword; St Andrew with a Cross (q.v.); St Simon with a saw; St James the Less with a club; St Matthew with a lance; St Catharine with a wheel; St Lawrence with a grid-iron; others with objects connected with their history or in some other way—St George with a dragon; St Matthew with a purse. St James the Elder is figured as a pilgrim. Many hundreds of such emblems are given in Canon Husenbeth's work already mentioned, together with a list of patron saints of trades, professions, countries, and cities. A martyr who had a special interest in a place was called its patron (see PATRON) as early as the 4th century; the possession of a relic was enough to constitute the saint a patron of its possessors. His being born in a place or having died there was a good reason for choosing the patron saint. The angels Michael, Gabriel, and Raphael were chosen patrons of churches as early as the 6th century. Trades and professions had their patrons, and every disease a saint gifted for its cure. The patron saint defended his votary, heard his prayer, helped him in difficulty, and even protected him at the day of judgment from the consequences of his sin. Among well-known patron saints were St George of England, St Andrew of Scotland, St Patrick of Ireland, St David of Wales, St Denis of France, St James of Spain, St Nicholas of Russia, St Stephen of Hungary, St Mark of Venice. There are curious instances, especially in the 15th century, of armorial bearings assigned to certain English and other saints. The Catholic doctrine of invocation of the saints is treated at PRAYER; at RELICS the honour paid to relics of saints and martyrs is dealt with. See also ROMAN CATHOLIC CHURCH, and SYMBOL.

Besides the *Acta Sanctorum* of the Bollandists, see Mrs Jameson's *Sacred and Legendary Art*; Alban-Butler, *Lives of the Fathers, Martyrs, and other Saints* (12 vols., new ed. 1866); Baring-Gould, *Lives of the Saints* (17 vols. 1872-92), the last volume of which treats of the emblems of saints; *Lives of the English Saints* (1844-45), edited by Cardinal Newman; C. A. Jones, *Saints of the Prayer-book* (1885); R. Owen, *Sanctorale Catholicum* (1880); R. M. Stanton, *A Menology of England and Wales* (1888), which includes the English martyrs of the 16th and 17th centuries recently beatified by Pope Leo X.; for Irish saints, O'Hanlan (1877) and Whitley Stokes (1888); for Scottish, Forbes (1872) and Pinkerton (new ed. 1892); for Welsh, Rees (1853).

St Affrique, a town of the French dept. of Aveyron, 56 miles NW. of Montpellier, stands in a beautiful valley in the midst of meadows, orchards, and vineyards. There is a considerable trade in wool and in the celebrated Roquefort cheese (see ROQUEFORT). Pop. 5081.

St Albans, a city of Hertfordshire, 20 miles NNW. of London, on the top and northern slope of an eminence washed by the Ver, one of the chief feeders of the Colne, across which stood Verulamium. That important Roman station is perhaps identical with the fortress of Cassivellaunus, destroyed in 54 B.C. by Cæsar, and was taken by Boadicea in 61 A.D. In honour of the protomartyr Alban, said to have been beheaded here about 303 for sheltering the Christian priest Amphibalus, Offa, king of Mercia, in 793 founded a great Benedictine abbey, which from Pope Adrian IV. (q.v., born at Bedmond, 3 miles SW.) obtained precedence over all other abbeys in England. Rebuilt after 1077 with flat Roman tiles from Verulam by Abbot Paul of Caen, and dedicated in 1115 in the presence of Henry I., the abbey church, in spite of successive alterations (Early English, Decorated, Perpendicular), is still 'the vastest and sternest' of early Norman structures, its exterior length (548 feet) being second only to Winchester's, whilst the transepts measure 189 feet across, and the massive central tower is 144 feet high. It was made the cathedral of a new diocese in 1877, and since 1871 has been very thoroughly restored by Sir G. G. Scott and Sir Edmund Beckett, the nave being reopened on 21st October 1885. Special features of interest are the substructure of the shrine of St Alban (its 2000 shattered fragments pieced together), the tombs of Duke Humphrey of Gloucester and 'Sir John Mandeville,' the superb presbytery reredos, and Abbot Ramryge's chantry. Of the forty abbots down to the Dissolution in 1539 the greatest was Cardinal Wolsey; and among the monks were Matthew Paris, Roger Wendover, Rishanger, and the other compilers of the *Chronica Monasterii S. Albani*, which, like the *Treatise* of Dame Juliana Berners (q.v.), was printed here at Abbot Wallingford's press, and which has been edited for the Rolls series (25 vols. 1863-91). The abbey gatehouse was in 1869 converted from a gaol to the purposes of King Edward VI.'s grammar-school, which till then had occupied the Lady Chapel; else, nothing remains of the monastic buildings. In St Michael's Church is Lord Bacon's monument; the 15th-century clock-tower was restored in 1864; and a drinking-fountain marks the site of an Eleanor's cross, demolished in 1702. There are almshouses founded by the famous Duchess of Marlborough, a town-hall (1832), a corn exchange (1857), and a free library (1880). The industries include straw-plaiting, brewing, boot and brush making, and silk-manufacture. St Albans, which was disfranchised for bribery in 1852, was incorporated by Edward VI. in 1553, and had its municipal boundary extended in 1879. It was the scene of two battles in the Wars of the Roses (q.v.)—the first, on 22d May 1455, a victory for the Yorkists; the second, on 17th February 1461, for the Lancastrians. Pop. (1851) 7000; (1891) 12,898.

See F. L. Williams' *History of Verulam* (1822); C. H. Ashdown, *St Albans, Historical and Picturesque* (1894); and works on the cathedral by Peter Newcome (1793), J. W. Comyns Carr (1877), James Neale (1878).

St Amand, a town of France, dept. Cher, on the river Cher, 25 miles SSE. of Bourges, with ironworks and porcelain-factories. Pop. 7722.

St Amand-les-Eaux, a town of France, dept. Nord, 8 miles NW. of Valenciennes, with hot sulphur-springs and a ruined abbey. Pop. 8722

St Andrews, one of the smaller towns of Scotland, but no mean city in age, importance, or historical interest, stands on a rocky plateau at the edge of St Andrews Bay, and is 42 miles NNE. of Edinburgh. From the number and nature of the remains of ancient burial found in and around the city there can be little doubt that there was a settlement here in early prehistoric times. The monkish legend, long discredited, assigned its ecclesiastical origin to St Regulus (q.v.) or Rule, who, warned in a dream, brought certain bones of St Andrew from Patras in the 4th century, and, like too many foreigners in the present day, was wrecked at Muckros, afterwards called Kilmont, now St Andrews. There is, however, reason for believing not only that those relics were brought in the 8th century, but that, before the end of the 6th, Cainech or Kenneth, the patron saint of Kilkenny, had founded a monastery at Rig-Monadh, the Royal Mount, and that thus arose the name of Kilmont. Early in the 10th century it seemingly became the seat of the 'Ardepscop Albain,' the high bishop of the Scots; and in Queen Margaret's time he began to be called the Bishop of St Andrews. The Augustinian Priory, founded in 1144, was the richest and greatest of all the religious houses of Scotland. The Cathedral, founded in or about 1160 in presence of Malcolm IV., and consecrated in 1318 in presence of Robert the Bruce, was stripped of its images and ornaments in 1559, and afterwards fell into ruin. The extreme length inside is 355 feet, but at one time it had been several bays longer. The Bishop's Palace or Castle, first built in 1200, was frequently demolished and rebuilt, and is now a ruin. George Wishart and other martyrs were confined in its 'bottle-dungeon,' and Cardinal Beaton was slain within its massive walls. None of the ruins is less imposing or more interesting than the foundations on the Kirkhill—the site of the Celtic church. St Rule's Tower has probably occasioned more discussion and perplexed more archaeologists than any other building in Scotland. Its arches, as well as that of its roofless chapel, approach the horseshoe in form. The parish church, which was almost entirely rebuilt in 1798, was founded in 1412. Its predecessor, which stood near the cathedral, was built three centuries earlier. Of the Black Friars Monastery a portion of the chapel remains; but of the Grey Friars almost nothing. The schools of St Andrews were noted in 1120; but the University, the first in Scotland, only dates from 1411. St Salvator's College was founded in 1455, St Leonard's in 1512, and St Mary's in 1537. St Salvator's and St Leonard's were united in 1747. The average attendance of students is about 200; but much is also being done for the higher education of women. The library contains over 100,000 volumes, and there is a good museum. The parish church of St Leonard's is roofless, and the congregation worships in the beautiful chapel of St Salvator's. The Madras College, founded and endowed by Dr Bell, has been recently remodelled and placed under a new governing body. The town was erected into a free burgh between 1144 and 1153. In those days the inhabitants were described as Scotch, French, Flemish, and English. In 1526 it was reckoned one of the six 'principale townis of merchandice of this realm;' but it has now almost no trade. The small harbour suffices for the few coasting vessels which frequent it. For a number of years the fishers were increasing rapidly, but the steam-tractors are proving too much for them. There is a small brewery, and a smaller foundry. The manufacture of golf-clubs and balls is naturally a thriving industry, St Andrews being known all over the world as the headquarters of golf. It is a popular watering-

place and summer-resort. For the St Andrews group of burghs, see the article **PARLIAMENT**, p. 778. Pop. (1801) 3263; (1891) 6853.

See, besides the *Registrum Prioratus Sancti Andree* (Bann. Club, 1841), the *Register of the Kirk Session* (Scot. Hist. Soc., 1889-90), and *Martyrs and Confessors of St Andrews* (1887), works by Martine (*Reliquiae*, 1797), Grierson (1807), Lyon (1843), Rogers (1849), J. M. Anderson (1878), and A. Lang (1894).

Saint Arnaud, JACQUES LEROY DE, a French marshal, was born at Bordeaux, 20th August 1796, and became a soldier. He fought for the Greeks in 1822-26, but made his reputation in Algeria. In 1847 he was made a general of brigade; and in the early part of 1851 he carried on a bloody but successful warfare with the Kabyles. Louis Napoleon, plotting the overthrow of the republic, was at this time on the lookout for resolute and unscrupulous accomplices; and he recalled General Saint Arnaud and appointed him to the command of the second division of the city forces. On 26th October Saint Arnaud became war minister, and took an active part in the arrangements for the *coup d'état* of 2d December, and in the subsequent massacres at the barricades. For these services he was rewarded with the marshal's baton. On the breaking out of the Crimean war in 1854 he was entrusted with the command of the French forces, and co-operated with Lord Raglan in the battle of the Alma, 20th September. But nine days afterwards he died on board ship, on his way home to France. See his *Lettres* (ed. by his brother, 2 vols. 1864).

St Asaph, a little cathedral city of Flintshire, North Wales, on an eminence between the rivers Elwy and Clwyd, 6 miles SSE. of Rhyl. The cathedral, 182 feet long, is the smallest in the kingdom, and, rebuilt after 1284, is a plain, cruciform, red sandstone structure, mainly decorated in style, with a massive central tower 93 feet high, fine oak stalls, and a tablet to Mrs Hemans, who lived here 1809-28. It was restored by Scott in 1867-75. St Kentigern (q.v.) is said to have founded about 560 a bishopric at Llanelwy, renamed St Asaph after his favourite disciple. Among sixty-five bishops since 1143 have been Reginald Pecock; W. Morgan, the first translator of the Bible into Welsh; Isaac Barrow the elder, on whose monument is a request for prayers for his soul; W. Lloyd, one of the Seven Bishops; Thomas Tanner; and S. Horsley. St Asaph has a grammar-school, founded about 1600, and rebuilt in 1882. It is one of the eight Flint parliamentary boroughs. Pop. 1901.

See works by Browne Willis (1719), E. A. Freeman (1850), R. J. King (*Murray's Welsh Cathedrals*, 1873), and D. R. Thomas ('Diocesan Histories' series, 1888).

St Augustine, an ancient Spanish town on the east coast of Florida, now the capital of St John's county, stands on Matanzas Sound, 2 miles from the Atlantic and 37 miles by rail SSE. of Jacksonville. It was founded in 1565, and is the oldest town in the United States. Its mild and equable climate renders it a favourite winter-resort for invalids. It is a Roman Catholic bishop's see, and contains a cathedral and convent; and it has also a Peabody Institute. Pop. 2300.

St Austell, a town of Cornwall, 14 miles NE. of Truro and 1½ NW. of the head of St Austell Bay. It has some woollen and iron manufactures, but owes its importance to the china-clay, tin, and copper that are worked in the vicinity (see **POTTERY**, Vol. VIII. p. 360). The interesting church (13th to 16th century) was restored in 1870. Pop. (1861) 3825; (1891) 3477.

St Bartholomew, or **ST BARTHÉLEMY**, a French West Indian island, 190 miles E. of Porto

Rico. Area, 8 sq. m.; pop. 2835. The treeless surface rises to 1003 feet; the climate is very dry. French from 1648 till 1784, the island then was Swedish till 1877, when it was bought back by France for £16,000.

St Bees, a coast village of Cumberland, 4½ miles S. of Whitehaven by rail and 3 SE. of St Bees Head (300 feet). A nunnery founded here about 656 A.D. by an Irish princess, St Begha, appears to have been destroyed by the Danes, and to have been reconstituted as a Benedictine priory in the reign of Henry I. St Bees College was established in 1816 by Dr Law, then Bishop of Chester, to supply a systematic training in divinity to candidates for ordination whose means were inadequate to defray the expenses of a university. The bishops of the province of York had previously been compelled to ordain a number of such men as literates, the poverty of many of the northern benefices not securing a sufficient supply of graduates. A portion of the ruined priory church of St Bees was fitted up by the Earl of Lonsdale as lecture-rooms, library, &c. On the recommendation of the bishop, an incumbent was selected for the perpetual curacy of St Bees by the patron, the Earl of Lonsdale, with a view to his holding the position of principal of the college. The expenses were defrayed from the fees paid by the students—£10 each term; and the college course extended over two years. Standard English divinity works, with the Greek Testament, were chiefly studied. The average number of students was long about 60, but had for many years been diminishing, when in 1896 the college was closed. Near the church is a grammar-school founded by Archbishop Grindall in 1587, and reconstituted in 1881. St Bees is in some repute as a sea-bathing place.

St Benoit, a town on the east coast of the island of Réunion; pop. 10,000.

St Benoit-du-Sault, a town in the French dep. of Indre, 40 miles NE. of Limoges; pop. 1800.

St Berain-sur-Dheune, a coal-mining town in the French dep. of Saône-et-Loire, 20 miles SE. of Autun; pop. 1200.

St Bernard, the name of two mountain-passes in the Alps. (1) **GREAT ST BERNARD** is on the road between Aosta in Piedmont and Martigny in the Swiss canton of Valais, and is 8120 feet above sea-level. Almost on its crest stands the celebrated hospice founded in 962 by Bernard de Menthon, a neighbouring nobleman, for the benefit of pilgrims journeying to Rome. It now affords sleeping-accommodation for eighty travellers, and can give shelter to about 300 in all. The hospice is connected with a station in the valley below, from which the monks above are warned by telephone when travellers are on their way up the mountain. The keepers of the hospice are a dozen or so of Augustinian monks, all young and strong; their work is, with the aid of large dogs, to rescue travellers who are in danger of perishing from the snow and cold. The dogs used are the short-coated variety of the 'St Bernard dog' (see next article). The rigorous cold and the difficulty of breathing the rarefied air frequently do permanent injury to the health of the monks in charge. In 1889 a botanical garden, chiefly for Alpine plants, was laid out in the Entremontthal, on the northern slope of the pass. Diggings in 1890 revealed the foundation of a small Roman temple of imperial times near the summit of the pass, with a few bronzes and other antiques. (2) **LITTLE ST BERNARD**, SW. of the above in the Graian Alps, connects the valley of Aosta with that of Tarantaise in Savoy. By this pass Hannibal is believed to have led his forces into Italy. It too has a hospice, 7143 feet above the sea.

St Bernard, a breed of dogs which derives its name from the hospice of St Bernard, where it was first introduced for the purpose of finding the pass across the mountain in snow. Every morning during the winter two dogs, one old and one young, accompanied by one or more of the monks or attendants, started from the monastery for the shelter at the foot of the mountain on the Italian side; a similar party of men and dogs also descended to the shelter at the Swiss end of the pass. If any travellers were found there they were helped on their way to the hospice, the dogs going on before to show the road. Possibly, on rare occasions, the dogs were allowed to go down to the valley by themselves, but as a rule they only acted as guides to the monks. Pictures and stories of the dogs laden with food and clothes, and sometimes actually carrying a benumbed traveller, are plainly due to the exaggeration of their admirers.

The St Bernard, according to the traditions of the monastery, is the result of a cross between a Danish bull-bitch and a mastiff, a native hill dog, though at what time effected it is impossible to say. After the breed was once established it was kept pure until 1812, when owing to the severity of the winter the monks were obliged, contrary to their usual custom, to send out the brood bitches as well as the dogs, with the result that all the females succumbed to the cold, and the monks found themselves without the means of continuing the true breed. In this extremity a cross with the Newfoundland was tried, but at first failed, owing to the excessive coat of the Newfoundland, which hampered the dogs in snow; however, by breeding back to their own short-coated dogs, the monks obtained the desired shortness of coat, though occasional specimens were born with the rough coats. These rough-coated specimens were sold or given away to the inhabitants of the surrounding valleys, who continued to breed them, so that St Bernard dogs soon became general in Switzerland. About 1860 these dogs first attracted the attention of English travellers, who imported them to Britain, where they were exhibited and at once excited much notice on account of their size and



St Bernard Dog, 'Scottish Prince.'

beauty. Others were introduced, and the St Bernard was soon established as the most popular big dog, a popularity which has gone on increasing. The St Bernard, as bred to modern English ideas, is an immense red or orange coloured dog, marked with white on muzzle, neck, chest, feet, and tip of tail. The head should be massive and imposing, with a strong square muzzle, a point of great importance. Legs should be straight, with large feet, and double or, at least, single dew claws.

Hind-feet should turn out, though not sufficiently to hinder the dog's movements. The coat of the rough variety is of medium length; it should not be too curly. In the smooth variety the coat should be short and wiry. Many of the finest St Bernards measure over 30 inches high at the shoulder, and weigh over 150 lb. On account of his great size and weight the St Bernard often moves in an awkward manner, a defect which should be avoided. St Bernards, though occupying a great deal of space, are so handsome that they are kept as companions in great numbers; as a rule they are good tempered, though many are not to be trusted.

See Hugh Dalziel's *The St Bernard* (1888), and his *St Bernard Stud-book* (1891).

St Brieuc, a town of Brittany, the capital of the department of Côtes du Nord, on the Gouet, 2 miles from its mouth in the English Channel, and 93 E. of Brest. It has a port, Le Légue, at the river's mouth; a cathedral, dating from the 13th century; the ruined Tour de Cesson (1395, blown up 1598); and a lyceum, with a library of 27,000 volumes. Pop. (1891) 16,461.

St Catherine's, a city of Ontario, chief town of Lincoln county, on the Welland Canal, by rail 32 miles E. by S. of Hamilton and 5 S. of Port Dalhousie on Lake Ontario. It has large manufactures of machinery and agricultural implements, and some shipbuilding. Its mineral springs are noted. Pop. (1881) 9631; (1891) 9170.

St Chamond, a town of France, dept. Loire, 7 miles NE. of St Etienne by rail, has manufactures of ribbons, stay-laces, silk, and iron, with large coal-mines in the vicinity. Pop. (1872) 12,585; (1886) 14,383; (1891) 14,599.

St Charles, capital of St Charles county, Missouri, on the high north bank of the Missouri River, 23 miles by rail (44 by river) NW. of St Louis. It has flour-mills, a railroad-car factory, and large bridge-building works. Pop. 6500.

St Christopher, popularly ST KITTS, one of the Leeward group of the West India Islands, belonging to Great Britain, lies 45 miles NW. of Guadeloupe. It is long (23 miles) and narrow (5 miles), and is traversed by a chain of rugged mountains (Mount Misery, 4100 feet); area, 68 sq. m. The capital is Basse-terre (q.v.), with a population of about 7000. Principal products are sugar, molasses, rum, and salt, with some coffee, cocoa, tobacco, and cattle. Administratively St Kitts is united with Nevis (q.v.) and the little island of Anguilla; the government rests with a governor, an executive council appointed by the crown, and a legislative council of ten official and ten unofficial nominated members, three of the latter from Nevis. The imports for the three islands together average about £175,500 annually, not quite one-half from Great Britain; the exports vary between £159,970 (1886) and £119,361 (1896). Pop. of all three islands (1891) 47,662; of St Kitts (1891) 30,876. This island, whose native Carib name meant the 'fertile island,' was discovered in 1493 by Christopher Columbus, who named it from a fanciful resemblance of its outline to statues of his patron saint, St Christopher. Colonised by French and British settlers simultaneously in 1625, it passed wholly into the possession of England in 1713, though the French both before and after that date seized it and held it for short periods.

St Clair, a navigable river of North America, in the line of the Great Lakes, and carrying (225,000 cubic feet per second) into Lake St Clair the waters of Lake Huron. It is over 40 miles long, and half a mile broad. In 1891 a railway tunnel under its bed was completed between Port Huron, Michigan, and Sarnia, Ontario, 20 feet in diameter, and 6026 (including excavated approaches, 11,553) feet long. Lake St Clair is 26 miles long and 25 wide, has an area of 410 sq. m., and from its south-west end passes the volume of water it has received into Lake Erie by means of the Detroit.

St Clair, a borough of Pennsylvania, 5 miles by a branch-line N. of Pottsville, with rich mines of anthracite coal, and a pop. (1890) of 6950.

St Claude, a town in a valley surrounded by hills, in the French department of Jura, with a pop. of 8116, largely occupied with turner's work, cabinet-making, and a trade in cheese. The monastery here dates from 430 A.D.

St Cloud, a town of France, dept. Seine-et-Oise, situated on an eminence near the Seine, 10 miles by rail W. of Paris. Henry III. was assassinated here in 1589 by the fanatical monk Jacques Clément. St Cloud was long famous on account of its magnificent château, built by Louis XIV.'s brother, the Duke of Orleans. Napoleon planned and carried out here the *coup* of 18th Brumaire, and after he became emperor made this château his favourite place of residence. It was destroyed, and its magnificent park (in which stands the Sèvres porcelain-factory) greatly injured, during the siege of Paris in 1870. Pop. 5316.

St Croix, an American river, called also the Passamaquoddy and the Schoodic, which, flowing out of Grand Lake, on the eastern border of Maine, runs south-east 75 miles to Passamaquoddy Bay, and forms a portion of the boundary between the United States and New Brunswick. See also SANTA CRUZ.

St Cyr, a village of France, dept. Seine-et-Oise, about 2 miles by rail W. of Versailles. It owes its origin to an educational institution for poor girls of good birth, founded by Louis XIV., at the suggestion of Madame de Maintenon. It was for its 250 pupils that Racine wrote his tragedies of *Esther* and *Athalie*. Madame de Maintenon died here, and was buried in the choir of the church. The institution was suppressed at the Revolution; and in 1806 the buildings were converted by Napoleon into a military school, which still exists. Pop. 3296.

St Davids, a 'city' of Pembrokeshire, South Wales, in the westernmost corner of the Principality, on the rivulet Alan, within 1½ mile of St Brides Bay and 16 miles WNW. of Haverfordwest station. The ancient *Menevia*, it is now a mere village; but in the middle ages its cathedral, with the shrine of its founder, St David (q.v.), the patron saint of Wales, attracted many pilgrims, among them the Conqueror, Henry II., and Edward I. and Queen Eleanor. Rebuilt between 1180 and 1522, that cathedral still is mainly Transition Norman in character, a cruciform pile, measuring 298 feet by 120 across the transepts, with a central tower 116 feet high. Special features are the reddish-hued stone, the richly ornamented nave with fretted timber roof, the rood screen (c. 1338), the base of St David's shrine, the tomb of Edmund Tudor, Henry VII.'s father, and the mosaics by Salviati. The west front was rebuilt by Nash in 1793; and the whole was restored by Scott in 1862-78. Little is known of the British bishops after St David's death in 601; of the seventy-two since 1115 may be mentioned Archbishops Thoresby and Chichely, Barlow, Ferrar the Marian martyr,

Middleton the forger, Archbishop Laud, Mainwaring, Bull, Lowth, Horsley, and Thirlwall. North of the cathedral is the ruined college of St Mary (1377), with a slender tower 70 feet high; and across the Alan are the stately remains of Bishop Gower's palace (1342), which Bishop Jones and Mr Freeman considered to be 'altogether unsurpassed by any existing edifice of the kind.' A restored cross, the shattered Close wall, and the imposing Tower Gate deserve notice, and also St Davids Head, rising 100 feet above the sea. Pop. of the parish, 2053.

See works by Browne Willis (1717), Manby (1801), Bishop Jones and E. A. Freeman (1856), Sir G. G. Scott (1869), and the Rev. W. L. Bevan (1888).

St Denis, a town in the French department of Seine, 4 miles N. of Paris, is situated within the line of forts forming the outer defences of the city, and was itself formerly fortified. It has manufactures of printed calicoes, flour, chemicals, machinery, white-lead, and other commodities. A famous sheep and parchment fair has been held here since 1552. The town is supposed to date from the foundation of a chapel raised above the tomb of St Denis (q.v.). This chapel was replaced in the 7th century by an abbey, built by Dagobert I., who was buried in its church, which thereafter became the mausoleum of the kings of France. The existing abbey church was begun by Abbot Suger in 1137, and skilfully restored by Viollet-le-Duc from 1848 onwards, though it suffered again in the bombardment of the town by the Germans in 1871. Monuments were erected above each of the royal tombs by St Louis, and the series was continued in after ages. The most magnificent of these memorials are the tombs of Louis XII. and his queen, Anne of Brittany, of Francis I. and Claude, and of Henry II. and Catharine de' Medici. The abbey was plundered by the English in 1430. Napoleon converted it into a school for the daughters of officers of the legion of honour. During the Revolution, in 1793, the royal tombs were sacrilegiously rifled and demolished, and the bodies cast indiscriminately into ditches prepared for them. Pop. (1872) 31,850; (1891) 50,992. See D'Azac *Histoire de l'Abbaye de Saint-Denis* (1861).

St Denis, the capital of Réunion (q.v.).

St-Dié, a town of the French department of Vosges, stands on the Meurthe, 50 miles by rail SE. of Nancy, possesses a Romanesque-Gothic cathedral, a large seminary, and a museum, and carries on energetically the weaving of cotton, the making of hosiery, paper, machinery, and iron goods. It is a convenient point from which to make excursions into the Vosges Mountains. Pop. (1872) 9748; (1886) 14,047; (1891) 17,082.

St Dizier, a town of France (dept. Haute-Marne), 38 miles by rail SE. of Châlons, is situated on the Marne, which here begins to be navigable. In 1544 it resisted for some weeks the army of Charles V., and in 1814 the French twice defeated here the invading army of the allies. There are iron forges and foundries, boat-building yards, and cotton-factories. Pop. (1881) 9863; (1891) 12,577.

St Domingo. See HAYTI, SAN DOMINGO.—St Domingo Bark is one of the names for Caribbean Bark (q.v.).

Sainte-Beuve, CHARLES-AUGUSTIN, the greatest literary critic of modern times, was born at Boulogne-sur-Mer in 1804. His father was commissioner of taxes in the town, and was a man of literary tastes. He died three months before the birth of his son, but it was from him that Sainte-Beuve deduced the leading bent of his own character and talent. His mother, *née* Augustine

Coillot, was the daughter of an Englishwoman who had married a Boulogne sailor. This connection of his mother with England partly explains that interest in English literature, and especially in English poetry, which Sainte-Beuve showed from first to last of his literary career. She was a woman of character and practical sense, but with so little regard for any ideal interests of life that she was never reconciled to her son's choice of a literary career till his election as a member of the Academy in his forty-first year. Her husband had left her in straitened circumstances, and it was only by considerable sacrifice on her part that her son received the advantage of a liberal education. Incessant toil and a modest return was to be Sainte-Beuve's own fortune throughout life, and this early acquaintance with a simple economy schooled him to a subsequent scale of living in which many would have forfeited their independence and self-respect.

Till his fourteenth year Sainte-Beuve attended the school of a M. Blériot in Boulogne, where he received a thorough grounding in Latin, and where he gave unmistakable proofs of unusual gifts. By his own desire he was then sent to Paris, where, boarding with a freethinking professor, M. Landry, he attended the Collège Charlemagne. At this school also he gave further promise of future distinction. Though he had thus shown such special aptitudes in the direction of literature, for the next three years (1824-27) he followed a course of medical study, and for another year even walked the hospitals—apparently out of deference to his mother's wishes.

It was in 1824, when Sainte-Beuve was in his twentieth year, and while he was still a medical student, that he began that career as a man of letters which he was to follow with such assiduity and devotion to the end. In that year M. Dubois, who had been one of his teachers at the Collège Charlemagne, founded a literary and political paper called the *Globe*. Supported by such writers as Jouffroy, Rémusat, Ampère, and Mérimée, the *Globe* became one of the leading organs of the day, and was hailed by Goethe as heralding a new departure in the intellectual life of France. On the invitation of Dubois, who had recognised the promise of his pupil, Sainte-Beuve took his place on the regular staff of contributors. For three years he wrote short articles on various subjects, which were collected after his death, and published under the title of *Premiers Lundis*. With the doctrinaire attitude of the chief contributors of the *Globe* Sainte-Beuve was never in complete sympathy, and in 1827 he came under a new influence, which forms one of the turning-points in his life. In that year he wrote a eulogistic review of the *Odes et Ballades* of Victor Hugo, which led to the closest relations between the poet and his critic. Supreme as he is in his own department, Sainte-Beuve was not of those who dominate other minds by the fervour of their own convictions, or the fury of their own creative impulse. Before he attained his full powers, therefore, and while his susceptibility was stronger than his judgment, he came under a succession of influences of the most diverse character and tendency. Under the influence of Hugo Sainte-Beuve became for a time the zealous advocate of that romantic movement of which Hugo was the acknowledged leader, and of which Sainte-Beuve himself was eventually the most judicious critic. As a member of the romantic *clan* which counted in its number Hugo, Lamartine, De Musset, and Alfred de Vigny, Sainte-Beuve embodied his new ideals and his new experiences both in poetry and prose. In 1828 he published his *Tableau de la Poésie Française au Seizième Siècle*, with the double object of justifying the romantic movement and of

directing attention to what was of real value in the French poetry of the 16th century. In 1829 and 1830 successively appeared *Vie et Poésies de Joseph Delorme* and *Les Consolations*, poems which, while they show intellectual subtlety and ingenious fancy, are fraught with morbid feeling strangely dissonant from the buoyancy and serenity of the writer's later years. In 1829, also, in the pages of the *Revue de Paris*, the predecessor of the *Revue des Deux Mondes*, he began the first of those longer critical articles on French literature which, under the name of *Causeries*, he was afterwards to carry to such perfection.

The revolution of July 1830 brought Sainte-Beuve under a new set of influences. The *Globe* now passed into the hands of the Saint-Simoniens, and for a year he became one of its contributors under the new direction. All his life Sainte-Beuve had a keen interest in questions relating to the well-being of the people; but his new colleagues soon passed the limits of his sympathy, and we find him for the next three years on the staff of the *National*, then edited by Armand Carrel. An article by Sainte-Beuve in that journal, which was the organ of extreme republicanism, led to a rupture with the editor, and he discontinued his contributions. It was during this period (1830-36), also, that Sainte-Beuve became a sympathetic listener of one of the most interesting men of the century, the famous Lamennais. In his later years Sainte-Beuve insisted that the foundation of his intellectual life was the French materialism of the 18th century; yet both his relations with Lamennais and his private correspondence prove that at this period of his life, at least, religious questions seriously engaged his attention. With the extreme democratic opinions of Lamennais after his breach with Rome Sainte-Beuve could have no sympathy, and by 1836 their intimate relations ceased. Later in life he expressed himself very frankly regarding Lamennais' career, but his final judgment is virtually that of all judicious critics. His solitary novel, *Volupté* (1834), also belongs to this period of his life, a period apparently of mental and spiritual unrest, of which this novel is the somewhat morbid expression. In 1837 he proceeded to Lausanne, where he delivered a series of lectures on the history of Port-Royal. Subsequently, as the result of the intermittent labour of twenty years, these lectures took the shape of a book of five volumes, which contain some of Sainte-Beuve's finest work. Whereas in the first two volumes, however, he is to a certain extent in sympathy with Jansenism, in the last three his point of view is that of the purely disinterested critic. At Lausanne Sainte-Beuve was deeply impressed by the character and views of Alexandre Vinet, and, though he eventually diverged far from Vinet's teaching, he treasured his memory as one of the noblest hearts and minds it had been his fortune to know. During his stay at Lausanne Sainte-Beuve produced his last volume of poetry, *Pensées d'Abat*, in which with but moderate success he attempted, as a departure from the usual rhetorical character of French verse, a simpler form of expression and more familiar turns of thought. From Lausanne he made a journey into Italy, visiting Rome, Naples, and other cities; and with this journey closes the first period of his life, during which he was still groping his way to his true function.

From 1840, according to Sainte-Beuve himself, dates a new departure in his criticism. Thenceforward he claims to have been master of himself, and in his own words to be the disinterested 'naturalist of minds.' In that year he was again in Paris, where an appointment as keeper of the Mazarin Library brought him a modest competence,

which saved him from the necessity of hasty production. During the next eight years he wrote mainly for the *Revue des Deux Mondes*, to which he had been an intermittent contributor since its foundation in 1831. As one of the most distinguished literary workers of the day, he was in 1845 elected member of the French Academy, his eulogium being pronounced by Victor Hugo. The political confusions of 1848 led Sainte-Beuve to accept the professorship of French literature at Liège, where he delivered a course of lectures afterwards published under the title of *Chateaubriand et son Groupe Littéraire sous l'Empire*. In 1849 he returned to Paris, when he entered on an engagement which was to afford him the precise sphere he needed for the adequate display of his powers and attainments as a literary critic. This was to write for the *Constitutionnel* an article on some literary subject to appear on the Monday of every week. For the next twenty years Sainte-Beuve, with little intermission, carried on this task. On Monday he settled down to his task, and on five successive days worked for twelve hours at the preparation of his materials and the composition of his article. Saturday he devoted to a careful revision of proofs, and on Sunday he allowed himself a holiday. In 1861 these *Causeries du Lundi*, as they were called, were transferred to the *Moniteur*, an official organ of Napoleon III.; in 1867 back to the *Constitutionnel*, and finally in 1869 to the *Temps*. The papers thus written make up in all twenty-eight volumes, of which the first fifteen are entitled *Causeries du Lundi*, and the succeeding volumes *Nouveaux Lundis*.

By his acceptance of the government of Napoleon III. Sainte-Beuve gave offence to many of his former friends; but his justification was that forms of government were indifferent to him provided he might pursue his own objects in peace. In 1854, on the occasion of his appointment as professor of Latin Poetry at the Collège de France, the students refused to listen to his lectures, and he was forced to demit both the office and its emoluments. The lectures he intended to deliver, a critical estimate of Virgil, were subsequently published as a separate volume. Nominated a senator in 1865, he regained popularity by his spirited speeches in favour of that liberty of thought which the government was doing its utmost to suppress. In his last years Sainte-Beuve lived the life of a hermit in his modest house in the Rue Mont-Parnasse, though he counted among his friends and admirers the first men of letters in France. He died on 13th October 1869 of a malady from which he had long suffered. It was his special instruction that he should be buried without religious ceremony and without the customary eulogium. His funeral, however, was attended by a multitude estimated at ten thousand, but the only words pronounced at his grave were—'Adieu, Sainte-Beuve; adieu, our friend.'

It is by the amount and variety of his work, and the range of qualities it displays, that Sainte-Beuve holds the first place among literary critics. Others have equalled or surpassed him in individual effects; where he is unapproachable is in his faculty of educing the interest and significance of the most various types of human character, and the most various forms of creative effort. To his marvellous insight, range of sympathy, and knowledge of detail he added an experience of men and things exceptionally rich and varied for one whose main function was literary criticism. But, besides their value as criticism, the works of Sainte-Beuve are an inexhaustible mine of facts and reflections bearing on every interest of human life. Regarded in its totality, his work is in its essential tendency

identical with that of Montaigne. In both we have the point of view of the uncommitted observer, the same many-sided presentment of life, the same inconclusive philosophy; and in both a personal character equally void of every heroic element. Supreme as he is in his own department, however, Sainte-Beuve is not a European man of letters like Erasmus, or Voltaire, or Renan. The subjects he treated were not of universal interest, and his literary methods are as far as possible from the simplicity and directness which are the crowning qualities of these three writers. Nevertheless, the work of Sainte-Beuve marks an epoch in the intellectual history of Europe. By its delicacy, subtlety, and precision it extended the limits of the study of human character and of the products of human intelligence.

The chief authority for the life of Sainte-Beuve is the strongly prejudiced book of the Vicomte d'Haussonville, *C. A. Sainte-Beuve, sa Vie et ses Œuvres* (1875). See also Sainte-Beuve's own 'Ma Biographie' in *Nouveaux Lundis*, vol. xiii. Amongst numerous works, one of the most read is *Souvenirs* by his last secretary, M. Troubat (1890). The works of Sainte-Beuve are as follow: *Tableau Historique et Critique de la Poésie Française et du Théâtre Français au XVI^e Siècle*; *Poésies Complètes* (2 vols.); *Volupté*; *Port-Royal* (7 vols. 1860); *Chateaubriand et son Groupe Littéraire sous l'Empire* (2 vols. 1860); *Critiques et Portraits Littéraires* (5 vols.); *Portraits Contemporains* (5 vols.); *Portraits de Femmes*; *Causeries du Lundi* (15 vols.); *Nouveaux Lundis* (13 vols.); *Souvenirs et Indiscrétions*; *Premiers Lundis* (3 vols.); *Les Cahiers de M. Sainte-Beuve*; *Chroniques Parisiennes*; *Lettres à la Princesse*; *Étude sur Virgile*; *Le Général Jomini*; *Monsieur de Talleyrand*; *P. J. Proudhon*, *sa Vie et sa Correspondance*; *Correspondance de C. A. Sainte-Beuve* (2 vols.).

Sainte-Claire Deville, HENRI ÉTIENNE, French chemist, was born on 11th March 1818, in St Thomas, West Indies, and was educated in Paris. In 1844 he was commissioned to organise the Faculty of Sciences at Besançon, and in 1851 obtained the chair of Chemistry in the Normal School at Paris, and shortly afterwards the similar chair to the Sorbonne. He died in Paris on 1st July 1881. He began his work as a chemical investigator by inquiring into the composition of certain resins, but soon transferred his energies to the investigation of metallurgic substances. It was Sainte-Claire Deville who first produced aluminium (1855) and platinum in commercial quantities, and demonstrated the general theory of the dissociation of chemical compounds at a high temperature. Amongst other results that were due to his skill and ingenuity, he discovered (1849) anhydrous nitric acid; examined the forms of boron and silicon; devised methods for fusing platinum, iridium, cobalt, &c.; determined the density of metallic vapours at exceedingly high temperatures; produced artificially sapphire, aluminium, and similar substances; and invented a way of getting crystallised oxides. His labours for producing globules of aluminium, which he exhibited at the Paris Exhibition of 1855, were in continuation of Wöhler's, dating from 1827. The platinum metals he studied along with Debray. His papers were published in *Comptes Rendus* of the Academy of Sciences, and in *Annales de Chimie*. He also published *De l'Aluminium* (Paris, 1859), and *Métallurgie du Platine* (2 vols. 1863).

Sainte Croix. See SANTA CRUZ.

St Elias, MOUNT, a great volcanic mountain just inside the Canadian frontier of Alaska, long believed to be the highest mountain on the American continent, 19,500 feet high. Again it has been reduced to 13,500; but in 1892 it was found by triangulation to be 18,010 feet—lower than Orizaba (18,340 ft.). It stands in a wild, inaccessible region, and is clothed almost from base to summit with eternal snow.

There are huge glaciers and utterly impassable precipices and yawning chasms; but in 1886 a party comprising Schwatka, Wood, and Seton Carr reached a height of 7200 feet on the mount, nearly all above the snow-level.

Sainte Marie-Aux-Mines. See MARKIRCH.

Saintes, an old town of France, dept. Charente-Inférieure, on the left bank of the Charente, 28 miles by rail SE. of Rochefort, has manufactures of iron and copper goods, machinery, and leather. In ancient times this town, under the name of *Mediolanum*, was the capital of the Santones, from whom the subsequent province derived the name of Saintonge (see ROLAND, Vol. VIII. p. 766). Its interesting Roman remains include a triumphal arch and the ruins of an amphitheatre. It was a bishop's seat down to 1790; the cathedral still stands. Palissy's home was at Saintes during the first fifty years or so of his life. Pop. (1881) 14,558; (1891) 16,229.

St Étienne, one of the most important industrial towns in France, stands (dept. Loire) on a tributary of the Loire, 36 miles by rail SW. of Lyons and 312 SSE. of Paris. It is built in the midst of the second largest coalfield of France (the largest is that of Valenciennes in the north), in which some 17,000 men are employed, and from which 3,000,000 tons of coal are extracted annually. The town, which looks thoroughly grimy, has few buildings of interest; but a school of mines (1816), a national small-arms factory (1764), a gallery of art, an artillery and a commercial museum may be mentioned. The chief industries are in iron and steel and in ribbons. Its hardware workshops employ more than 20,000 workpeople, and turn out steel and iron plates, gun-armour, iron masts, large castings for machinery, firearms, locks, cutlery, files, nails, tools, &c. The government small-arms factory (4000 men) has since the period of the Revolution supplied nearly all the muskets and rifles and revolvers for the army. Some 40,000 persons, mostly hand-workers in their own homes, are engaged in the town and its vicinity in making ribbons, laces, fringes, and similar ornamental work. The production of ribbons is valued at £3,760,000 for a single year, and of this some £2,740,000 worth is exported. Besides these branches of industry, hats, pottery, and hemp cables are made. Pop. (1800) 16,000; (1855) 53,741; (1876) 126,019; (1891) 128,136. The coal-mines began to be worked in the 14th century, but only on an extensive scale in the end of the 18th. The town was twice captured by the Huguenots, in 1563 and 1570, and between this last date and 1629 it suffered terribly on three occasions from the plague. The first railways in France were built from St Étienne, one in 1828 to Andrieux, the other in 1831 to Lyons.

St Eustatius, a Dutch West Indian island, 10 miles NW. of St Christopher. Area, 8 sq. m.; pop. 2286.

Saint-Évremond, CHARLES MARGUETEL DE SAINT-DENIS, SEIGNEUR DE, a famous French writer and wit, was born at St Denis near Coutances in Normandy, 1st April 1613. He was educated by the Jesuits at Clermont, at Caen, and at the Collège d'Harcourt in Paris, next entered the service, and fought with distinction at Rocroi, Freiburg, and Nordlingen. He gave steady support to the throne throughout the Fronde, but in 1661 had to flee first to Holland, finally to England, on the discovery of his witty and sarcastic Letter to Créqui on the Peace of the Pyrenees. He was warmly received by Charles II., and here he spent the rest of his days, delighting the world with his wit, a fast friend of the beautiful Hortense, Duchesse de Mazarin, whose strange

death sorely troubled his old age. Here he died, 29th September 1703, and was buried in Westminster. His writings were famous long before they were made public, and in his own day he enjoyed an equal reputation on either side of the Channel for polished satire, Attic irony, and brilliant style. Distinctively a man of fashion, a complete Epicurean in philosophy and life, a brilliant conversationalist in an age when conversation ranked among the fine arts, he has written his name high amongst the masters of French prose, although he lacked enthusiasm, ambition, motive, illusions, to produce anything adequate to his gifts. Still, it is a sovereign distinction to have created a style so delicate, yet so effective and so individual. His one mannerism is antithesis, yet the art is so exquisite as never to offend. His influence was great—it is praise enough to say that he helped to form the Chevalier de Grammont. His satire, *La Comédie des Académistes* (1644), is a masterpiece in its kind, and his dissertation on Racine's *Alexandre* reveals the true critic's insight. But so little was his curiosity that though he lived nearly forty years in England he never learned English and never knew Shakespeare. The letters betwixt him and his dear friend Ninon de Lenclos are charming beyond most. His writings, including essays, comedies, &c., were first collected by Des Maizeaux with a Life (Lond. 1705). There are good volumes of selections by C. Giraud (1865) and Lescure (1881).

See the studies by Gilbert and Gidel (1866), Merlet (1870), Pastorello (Trieste, 1875); also Sainte-Beuve's *Nouveaux Lundis*, vol. xiii., and *Causeries du Lundi*, vol. iv.

St Flour, a town in the French department of Cantal, finely situated on a steep basaltic plateau (3000 feet) 50 miles S. of Clermont-Ferrand, has a cathedral (Gothic; 1375-1466), and manufactures pottery, cloth, &c. Pop. 5300.

St Gall, a Swiss canton lying between the Lake of Constance on the N. and the Grisons on the S., with Zurich on the W. The country is for the most part mountainous, rising to 10,660 feet in Ringelspitz, and to 8216 in Säntis, and consists of a series of valleys radiating outwards from the high canton of Appenzell, which St Gall entirely surrounds. The Rhine flows along the eastern border. Portions of the lakes of Constance, Zurich, and Wallen lie within its boundaries. Sandstone and slates are quarried. The mineral springs of Pfäfers and Ragatz are well known. But the chief source of wealth is the embroidery of cottons, muslins, and jaconets, carried on principally at St Gall and Wattwil. Rorschach, on Lake Constance, is a port of some trade. Area of canton, 779 sq. m.; pop. (1888) 229,441, of whom three-fifths are Roman Catholics, the rest Protestants of the Reformed Church. They speak German. The canton is governed by a Great Council, chosen by the communes for three years (see SWITZERLAND).

ST GALL, the capital of the above canton, stands on the Steinach, 2196 feet above sea-level (the highest town in Europe), 53 miles by rail E. of Zurich, and 9 from Rorschach on the Lake of Constance. The buildings of its famous Benedictine monastery are now used as government offices and schools, and for housing the monastic library, founded in 830, of 41,700 volumes and 1800 MSS., several of these last of great antiquity and value. Other buildings are the old abbey church, thoroughly restored in 1756-66, and made a cathedral in 1846; the Protestant church of St Lawrence (restored 1851-53); the town library, founded in 1536, and containing 60,400 volumes and 500 MSS.; and the museum with collections

of natural history, works of art, and antiquities. The city carries on a large trade in its staple commodity, embroidered textiles (cotton, muslin, &c.), and in agricultural products. Pop. (1888) 27,910. The original nucleus of the place was the cell of St Gall (c. 550-645), an Irish follower of St Columban, who settled here in 614. Around this soon grew up a monastery of the Benedictine order, which was promoted by Charles Martel to the dignity of an abbey. The abbey gradually became one of the masterpieces of mediæval architecture; whilst the monks were indefatigable in the collection and transcription of MSS.—biblical, patristic, historical (sacred and profane), classical, liturgical, and legendary. Several of the classics, especially Quintilian, Silius Italicus, and Ammianus Marcellinus, have been preserved solely through the MSS. of St Gall. Its monastic schools enjoyed the greatest reputation for learning from the 9th to the 12th century. Amongst its more distinguished pupils were Notker and Ekkehard. They were noted also for the cultivation of music (Notker Labeo being the chief ornament), and its MSS., preserved in the library, have been extensively made use of by the restorers of ancient ecclesiastical music. By the 10th century a walled town had grown up around the monastery. After long struggles the townsmen succeeded, in the 13th century, in throwing off the supremacy of the abbey, though shortly before this the abbots were elevated to the rank of princes of the empire. In 1454 the town was admitted to the Swiss confederation, and in 1528, through the influence of the reformer Vadianus, it embraced the new doctrines. At the close, however, of the religious war in 1531 the Catholic religion was re-established, and the abbot reinstated. At the French Revolution the abbey was secularised (1798), and its revenues were soon afterwards sequestered (1805). By a later arrangement (1836) St Gall was erected into a bishopric. The French republicans created the canton of Sântis out of the town and abbey lands, with others, in 1799; and in 1803 the existing canton of St Gall was formed.

See historical works by Von Arx (4 vols. St Gall, 1830), Baumgartner (3 vols. Zurich and Einsiedeln, 1868-90), Henne-Am Rhyn (1863), and Näf (1867).

St George's. See BERMUDAS.

St-Germain-en-Laye, a town of France, dept. Seine-et-Oise, stands on an eminence above the Seine, with a royal forest (10,000 acres) behind it and the river before it, Paris in the distance, 13 miles to the E. by rail. Above the river runs the famous terrace (2625 yards long by 115 feet wide), made by Lenôtre in 1672. The historic associations cluster round the old royal castle, which, until Louis XIV. removed the court to Versailles, was the favourite residence of the kings of France. Here were born Henry II., Charles IX., Louis XIII., and Louis XIV., and here died Louis XIII. King James II. of England lived in this castle from 1689 to his death in 1701. After that it was turned into barracks, then into a military prison, and finally by Napoleon III. into a museum of Gallo-Roman antiquities. Peace was signed within its walls between Charles IX. and the Huguenots in 1570, and the peace between France and Brandenburg in 1679. The Fête des Loges, one of the most popular of popular festivals, is held annually at a chapel in the forest. The people (12,484 in 1891) manufacture woollens and cottons. See Lacombe, *Le Château de St-Germain* (4th ed. 1874).—*St Germain-des-Prés*, named like the other from Germanus (q.v.), was a famous Benedictine monastery near Paris (see MAURISTS). Its church (1001-1163) ranks as the oldest in Paris.

St Germans, formerly the seat of the ancient diocese of Cornwall, now a small village, stands on the slope of a hill, on a branch of the river Lynher, 9½ miles W. by N. of Plymouth. It is notable only for its fine parish church, which has an excellent Norman west front. Pop. of parish (1881) 2869; (1891) 2877.

St Gilles, a town of France, dept. Gard, is situated on the Canal de Beaucaire, 12 miles SSE. of Nîmes. Its abbey church, the west front of which is a masterpiece of Romanesque architecture, and is covered with the richest decoration, dates from 1116. Pope Clement IV. was born here. Pop. 4876.

St Gotthard, a mountain-knot of the Alps, that has its feet planted in the Swiss cantons of Uri, Grisons, Ticino, and Valais, and lifts its head, 9850 feet high, to the eternal snows. In its arms it holds the sources of the rivers Rhine and Rhone, Ticino and Reuss, and so sends the water from its melted snows to the German Ocean, the Mediterranean, and the Adriatic. On its shoulder it bears one of the most celebrated of the Alpine passes from Switzerland to Italy. The road that crosses this pass (6936 feet) leads from the shores of Lake Lucerne to the shores of Lago Maggiore. This route was first used by the Longobardi in the 6th century. In the days of Charlemagne the path was made practicable for pack-animals; but down to 1820 it was not wider than 13 feet. In 1820-24 it was widened to 18 feet and smoothed for carriages. Near the summit of the pass stand two hotels and a hospice, the latter for poor wayfarers, of whom some 12,000 used to travel this way every year. Since 1882, however, a railway has climbed up the lower slopes of the St Gotthard, and then burrowed through it in a tunnel. The making of this tunnel was begun in 1872 and finished in 1880; it extends from Göschenen (at a height of 3639 feet) in Uri to Airolo (3757 feet) in Ticino, measures 9½ miles in length, is 26 feet wide and 21 high, rises with a gradient that reaches on an average 26 in 100 feet, and cost £2,270,000 to make. The total cost of the St Gotthard railway was £9,080,000, of which Switzerland contributed £1,120,000 as a subvention, Italy £2,200,000, and Germany £1,200,000; whilst £1,840,000 was raised by shares, and £2,720,000 by mortgage. The line has proved very successful financially, the shareholders' dividends rising annually. See *Nature*, vol. xxi.

St Helena (generally called St Heléna, not St Heléna), a lonely island in the Atlantic, 1200 miles from the west coast of Africa, 1695 from Capetown, and 4477 from Southampton, measures 10 miles by 8, and has an area of 47 sq. m. It is part of an old volcano, and reaches 2823 feet in High Hill. Its shores face the ocean as perpendicular cliffs 600 to 2000 feet high, and are in many places cleft by deep, narrow valleys. The climate is pretty constant and generally healthy. Whale-fishing and the growing of potatoes are the principal occupations of the inhabitants, 6444 in 1871, 5059 in 1881, 4116 in 1891. Previous to the cutting of the Suez Canal St Helena was a favourite port of call for vessels bound to and from India by the Cape of Good Hope, and the inhabitants did a large trade in furnishing these vessels with provisions and other supplies. But the shorter route afforded by the Canal and the Red Sea has greatly lessened its importance. The imports were, in 1884, in value, £41,816; in 1896, £30,950. The exports of the island's produce in 1884 were £1436, and in 1896 £746. The revenue, which in 1884 was £12,186, was in 1896 £9161, the expenditure for the same years being £11,209 and £8872. The public debt, which in 1890 was £2250, was in 1896 nil. The value of the whale-fishery varies from £13,000 to

£30,000 per annum. Jamestown, the capital, is a second-class imperial coaling-station, and is strongly fortified. St Helena is largely used as a recruiting station for the West Indian Squadron. The garrison consists of a battery of royal artillery and a company of infantry. The educational system is very complete, four of its schools receiving government grants. St Helena was discovered by the Portuguese in 1502, and taken possession of by the British East India Company in 1651. They remained masters of the island down to 1834; since that time it has been administered by a governor and an executive council of five members. The island is chiefly celebrated as the place of Napoleon Bonaparte's imprisonment from 1815 to his death in 1821. His home was the farmhouse of Longwood, 3 miles inland from Jamestown; and the spot where he was first buried lies about 1 mile to the south-west. There is an Anglican bishop of St Helena. See Melliss, *St Helena* (Lond. 1875); Brooke, *History of St Helena* (1808-24); and books quoted under NAPOLEON.

St Helens, (1) a town of Lancashire, on the Sankey brook, flowing to the Mersey, 12 miles ENE. of Liverpool and 21 W. by S. of Manchester. Thanks to its railway and canal facilities, and to the immediate neighbourhood of coal, it has grown within recent years from quite a small village to an important industrial centre, and now is the great seat of the manufacture of crown, plate, and sheet glass, and also possesses extensive alkali, copper-smelting, and iron works. It was constituted a municipal borough in 1868; a parliamentary borough, returning one member, in 1885; and a county borough by the Local Government Act, 1888. The handsome town-hall, with a public library, was opened in 1876. Pop. (1871) 45,134; (1881) 57,403; (1891) 71,288.—(2) A small town in the Isle of Wight, 4 miles SE. of Ryde. Pop. of parish (1851) 1948; (1891) 4469.

St Heller, the capital of Jersey, is situated on the south shore of the island, and the east side of St Aubin Bay. It is defended by Elizabeth Castle (1551-86), on a rocky island off the shore, approached by a causeway at low-water; and by Fort Regent, on the south-east side of the town, built in 1806-15 on a scarped granite rock, at a cost of £1,000,000. Victoria College (1852) is a handsome edifice; and one may also notice the courthouse (1647), the public library (1736), a gilt statue of George II. (1751), and the harbour, forming an outer and inner basin. An active trade is carried on with England, France, and India. Pop. (1851) 29,153; (1871) 30,756; (1891) 29,100. See JERSEY, and CHANNEL ISLANDS.

St-Hilaire. See BARTHELEMY, GEOFFROY.

St Ignatius' Beans. See IGNATIUS' BEANS.

Saintine, or BONIFACE, JOSEPH XAVIER (1798-1865), a Frenchman, the author of plays, poems, and tales without number, of which one only is famous now—*Picciola, the Story of a Prison Flower* (1863).

St Ives, (1) a fishing-town of Cornwall, beautifully situated on the west shore of St Ives Bay, 8 miles NNE. of Penzance. It has a branch-line (1865); a harbour, with a pier by Smeaton (1770) and a breakwater (1864); a 15th-century granite church, with an ancient cross; and a town-hall (1832); whilst on a hill, 545 feet high, is a pyramid (1782). St Ives is the chief seat of the Pilchard (q.v.) fishery, and from its mild climate and good bathing is a favourite resort. It is said to take name from St Ia, an Irish princess, martyred here in 450 A.D. Incorporated by Charles I. in 1639, it returned two members till 1832, and then one till 1885. Pop. (1861) 7027; (1891) 6094. See Lach-Szyrna's *History of Penzance, St Ives, &c.* (1878),

and J. H. Matthews' *History of St Ives* (1892).—(2) A picturesque old monastic town of Huntingdonshire, on the left bank of the Ouse, 5 miles E. of Huntingdon. It has a curious likeness to Stratford-on-Avon; and, surrounded on one side by low clay hills, it stands on the border of the fen country, but not in the fens, having a gravel sub-soil, with an unusually rich alluvial soil above. Almost destroyed by fire (1689), and inundated by the river (1823), it has a 15th-century parish church, a corn exchange (1864), and a six-arch stone bridge of singular beauty, built by the abbots of Ramsey, with an old chapel or lighthouse in the middle. Cromwell lived at Slepe Hall, now built over, in 1631-36, and Theodore Watts was born here. This place is said to be named after Ivo, a Persian bishop, who died here about 590, and it became in 1017 the seat of a Benedictine priory. A large weekly cattle-market was chartered in 1290, and the town was incorporated in 1874. Pop. (1851) 3522; (1891) 3037.

St James's Palace, a large inelegant brick structure, fronting towards Pall Mall. Originally a hospital dedicated to St James, it was reconstructed and made a manor by Henry VIII., who also annexed to it a park, which he enclosed with a brick wall, to connect St James's with Whitehall. The gateway and clock-tower are from designs by Holbein. Here Queen Mary died (1558); Charles I. slept here the night before his execution; and here Charles II., the Old Pretender, and George IV. were born. When Whitehall was burned in 1697, St James's became the regular London residence of the British sovereigns, and it continued to be so till Queen Victoria's time. Additions and improvements, gradually made, totally changed the original palace, so that at the present time little, if any, of the old structure remains. In 1837 the royal household was transferred to Buckingham Palace, whither the drawing-rooms were also removed at the death of the Prince Consort, and St James's is now used only for levees.—*The Court of St James's* is a frequent designation of the British Court.—St James's Park lies southward from the Palace, and extends over 58 acres.

St-Jean-D'Angély, a small town of France, dept. of Charente-Inferieure, 15 miles NNE. of Saintes. Pop. 6494.

St John, the largest river of New Brunswick, rises in the highlands in the north of Maine, flows north-east and then south-east 450 miles (the last 225 within British territory), and falls into the Bay of Fundy by an estuary 5 miles in width. Near the sea it is navigable for large vessels; while for craft of 120 tons it is practicable as far as Fredericton (80 miles), and for small steamers to Woodstock, 75 farther up. For great part of its middle course the stream separates Maine from Canada.

St John, the commercial capital and largest city, and the railway centre, of New Brunswick, stands on the north or left bank of the estuary of the St John River, by rail 277 miles NW. of Halifax and 481 from Montreal. Steamers connect it with Boston. The harbour is good, and accessible to the largest vessels at all seasons of the year. Shipbuilding and the timber-trade are the chief industries, together with fishing and the West India trade; but the manufactures also are important and numerous, and include engines and locomotives, machinery and farming implements, nails, axes, leather, boots and shoes, paper, cotton and woollen goods, clothing, furniture, carriages, soap, wrought stone, &c. On June 21, 1877, a fire destroyed the greater part of the town; but a new St John speedily arose, with wide, clean streets and handsome buildings. These include a custom-

house, post-office, city building, provincial lunatic asylum, hospital, and a Roman Catholic cathedral. St John returns three members to the House of Commons (two of them for the city and county together), and six to the Provincial Legislature (four for city and county). Adjoining St John, and practically forming with it one city, is the town of Portland. Pop. (1881) 26,127 (with Portland, 41,353); (1891) 39,179.

St John. See ANTIGUA.

St John, HENRY. See BOLINGBROKE.

St John, KNIGHTS OF. See HOSPITALLERS.

St John's, (1) the capital of Newfoundland, stands on the extreme east coast of the island, on Avalon Peninsula, 1076 miles ENE. of Montreal and 1730 W. by S. of Cork in Ireland. It is thus the nearest port in America to Europe; and it possesses a small but excellent harbour, which is well fortified. Railways run to Harbour Grace (84 miles) and Placentia (25 miles). The city, a great part of which was burnt, 10th July 1892, has oil-refineries, tanneries, shoe-factories, cabinet-works, &c. Pop. (1891) 39,179.—(2) Chief town of a county in Quebec, on the Richelieu, opposite the town of St Athanase, with which it is connected by a bridge, and 27 miles by rail SE. of Montreal. It contains a lunatic asylum, barracks, potteries, foundries, sawmills, &c., and carries on a considerable trade in lumber and grain. Pop. 4314.

St John's Bread. See CAROB.

St Johnsbury, capital of Caledonia county, Vermont, on the Passumpsic River, and about 34 miles ENE. of Montpelier, with which it is connected by rail. It manufactures agricultural implements, and scales and balances. Pop. (1890) 3857.

St Johnstoun. See PERTH.

St John's Wort (*Hypericum*), the typical genus of plants of the natural order Hypericaceae. It is a numerous genus of herbs and shrubs widely distributed, both in the New and the Old World,

particularly abundant in western Asia, southern Europe, and in North America; it occurs also within the tropics. The leaves are opposite entire, without stipules, often marked with glandular dots of two kinds, pellucid ones which are very apparent when the leaves are held against the light, and black ones which are usually on the under side of the leaves round the edge, or sometimes on the flowers. The flowers are regular, with five sepals, and five petals, usually yellow. They abound



Large-flowered St John's Wort
(*Hypericum calycinum*).

in a yellow resinous juice which is more or less purgative and anthelmintic. The common St John's Wort, an abundant native of Britain, even when slightly bruised yields copiously a yellow resinous juice, which, when rubbed between the fingers, emits a scent like lemons, and stains the skin dark purple. The plant has long been credited with powerful medicinal properties, but finds no place in the pharma-

copœias, nor is it recognised by regular practitioners. It has been used as a vulnerary, both externally and internally, in chest complaints, dysentery, hæmorrhages, and jaundice. In France and Germany the plant is ceremoniously gathered on St John's Day by the common people as a charm for evil spirits, storms, and thunder; in North Wales a similar custom still exists, and in Scotland it was formerly worn as a charm on the person against all malignant influences. The leaves of *H. androsaemum* are called by the French *toute saine*, hence the English name *Tutsan*; in both countries they were formerly used to dress fresh wounds. Other species of *Hypericum* have similar properties. There are several species, such as *H. calycinum* (also called Aaron's Beard), frequently cultivated in British gardens.

St Joseph, a city of Missouri, capital of Buchanan county, is on the left bank of the Missouri River, 110 miles (68 by rail) above Kansas City. Eight lines of railway centre here, and the river is crossed by an iron railway and foot bridge (1873), which has five spans, one a pivot-draw span of 365 feet, and cost \$1,500,000. Here are the state asylum for the insane and St Joseph College and other Roman Catholic institutions; the city was formerly a bishop's see. St Joseph has large pork-packing establishments and manufactories of stoves, ornamental and other ironwork, guns, carriages and wagons, clothing, furniture, brooms, beer, syrups, &c. Its wholesale trade considerably exceeds \$100,000,000 annually. The first settler, an Indian trader, laid out the town in 1843, and by 1851, when incorporated as a city, it was famous as the starting-point for the long journey across the plains. Pop. (1870) 19,565; (1880) 32,431; (1890) 52,324; (1900) 102,979. It suffered from a great fire in September 1893.

Saint-Just, LOUIS ANTOINE LÉON FLORELLE DE, French Revolutionist, was born at Decize near Nevers, 25th August 1767, and was educated by the Oratorians at Soissons. He began the study of law at Rheims, but early gave himself to letters, and found his gospel in the writings of Rousseau. At nineteen he set off for Paris, perhaps to avoid taking orders, with some of his mother's plate and other valuables, and was, at her request, imprisoned for six months for selling these. Like most young men of his age he was fired by the revolutionary fever, which, added to the native enthusiasm of his temperament, was yet to carry him far. He published in 1789 a poor poem, *L'Organt*, a mere boyish imitation of Voltaire's *Pucelle*, and in 1791 an essay of a different promise, *L'Esprit de la Révolution*. Next year he was returned fifth deputy for Aisne to the Convention. He first attracted notice by his fierce tirades against the king, and he opened the memorable debate on the verdict in his trial. 'Royalty,' said he, 'is in itself a crime. Every king is a rebel and an usurper. We must judge Louis, not as a citizen, but as an enemy; that is to say, put him to death without forms of process.' He soon became a devoted follower of Robespierre, and by his influence was sent on missions to the armies of the Rhine and the Moselle, which his energy and enthusiasm, as well as administrative ability, urged on to victory. He made bombastic rhetorical speeches before the Convention, but his slight youthful figure, mild voice, large blue eyes, long black hair, and singular beauty gave no promise of the intensity and relentlessness of the fire that burned within him. 'He carries his head like a Saint Sacrament,' said Camille Desmoulins. 'And I,' retorted Saint-Just, 'will make him carry his like a Saint Denis'—a ferocious prophecy soon to be fulfilled. Saint-Just began the attacks on Hébert which

sent him to his doom, quickly followed by the fall of Danton and his friends. Early in 1794 he laid before the Convention a comprehensive report on the police, and soon after proposed Robespierre's famous civil institutions—a ludicrous scheme for a new organisation of society. Boys were to be taken from their parents at seven and brought up for the state, not the family; marriages were not to be proclaimed till after the birth of the first child; friendship was to be no longer a domestic tie, but a public obligation, every citizen being required on reaching twenty-one to declare in the temple who were his friends, he that had none to be banished. Until the citizens were sufficiently educated for this splendid programme a strong dictatorship was necessary, and the faithful follower and his chief alike saw the one man in Robespierre. Saint-Just fell with Robespierre, but unlike him carried his head high on the tumbrel, and died without a word, 28th July 1794.

See S. Fleury, *Saint-Just et la Terreur* (1851), and the *Life* by Ernest Hamel (1859), the latter as eulogistic as the former is the opposite; also vol. ii. of Aulard's work, *Les Orateurs de la Législative et de la Convention*.

St Kilda, a lonely island in the Atlantic, belonging to Harris in Inverness-shire, and 40 miles W. of North Uist. With an extreme length and breadth of $3\frac{1}{2}$ and $1\frac{1}{4}$ miles, it is only 1.9 sq. m. in area; has lofty precipitous cliffs almost everywhere, except at the south-eastern landing-place;



The Town and Bay, St Kilda.

and attains a maximum altitude of 1220 feet. The rocks are igneous, incumbent on sandstone; the climate is mild; and the soil is black loam, with very fine pasture, but only some 40 arable acres. The live-stock includes nearly a thousand sheep (which graze also on four neighbouring islets), about forty West Highland cattle, and as many mongrel collies; but a principal source of wealth is the sea-birds—fulmar petrels, solan geese, puffins, &c.—which supply feathers, oil, and meat. The fisheries, though productive, are neglected; coarse tweed and blanketing are the only manufactures. The crofter inhabitants, all Gaelic-speaking, and all Free Churchmen since 1844, enjoy Home Rule and are practical Communists; but these advantages are well-nigh counterbalanced by the destructive tempests and consequent famines, by poverty, and by an absolute lack of amusements—eight hours' worship on Sunday the only break in the week. Crime is unknown; but the percentage of illegitimate births during 1851-86 was 6.25. The 'boat-cold' is still communicated by

strange boats that touch at the island; but the 'eight days' sickness' seems dying out—that terrible infantile lockjaw which carried off fifty-two children during 1856-86. The island was the property of the MacLeods from time immemorial, was sold in 1779 by General Normand MacLeod XX., chief of MacLeod, and was repurchased in 1871 for £3000 by his grandson, Normand XXII., chief of MacLeod of MacLeod. Its native name is Hirta (Gael. *h-Iar-tir*, 'the western land'); and the name St Kilda is probably of Columban origin. Events in its 'history' have been the reduction of the population by smallpox to four adults and twenty-six children (1724); the imprisonment of Lady Grange here by her husband (1734-42); the emigration of thirty-six islanders to Australia (1856); the drowning of six (1864); and the establishment of a regular school (1884). Pop. (1851, the maximum) 110; (1891) 71.

See works by Dean Munro of the Isles (1585), Martin (1698-1703), Kenneth Macaulay (1764), L. MacLean (1838), J. Sands (1877), G. Seton (1878), and B. Connell (1887).

St Kilda, a coast suburb of Melbourne (q.v.), on the east side of Hobson's Bay.

St Kitts. See ST CHRISTOPHER.

St Lawrence, a great river of North America, which, issuing from Lake Ontario, flows north-east for some 750 miles—part of the way forming the

boundary between Canada and the United States—and falls into the Gulf of St Lawrence by a broad estuary. But in its widest acceptance the name includes the whole system of the Great Lakes and their connecting streams, with a total length from source to mouth of 2200 miles, and a drainage basin of 297,600 sq. m. (These lakes, which are of comparatively modern date, are nothing more than a great system of river-valleys, whose old outlets have been blocked, but many of whose former channels have been traced within late years: see Wright, *The Ice Age in North America*.) The area of water-surface in the five lakes alone is 94,650 sq. m., and their aggregate basin 259,950 sq. m. The St Lawrence system, or that of which the great river is the outlet, thus constitutes by far the largest body of fresh water in the world. This mighty artery

of North-east America rises, under the name of the St Louis, on the spacious plateau which sends forth also the Mississippi towards the Gulf of Mexico, and the Red River of the North towards Hudson Bay. Lake Superior (602 feet above sea-level), the next link in the chain, finds its way to Lake Huron through St Mary's River, whose rapids have a fall of 20½ feet. Below Lake Huron, which receives Lake Michigan from the south, St Clair River, Lake St Clair, Detroit River, and Lake Erie maintain pretty nearly the same level (there is a fall of some 8 feet, however, in Detroit River) till the river Niagara descends 326 feet to Lake Ontario, which is itself still 247 feet above the sea-level. The St Lawrence proper, with a number of lake-like expansions (such as the Lake of the Thousand Isles, of St Francis, St Peter, &c.), presents the character first of a river, and then of an estuary, down to the gulf. Prior to 1858 only vessels drawing not more than 11 feet of water could pass up the river above Quebec; but since then a channel has been made

in the shallow parts of the river, 300 feet wide and 27½ deep, which permits the passage up to Montreal of vessels of 4000 tons burden. Between Lake Ontario and Montreal there are several rapids, which, however, may be all avoided by means of canals that have been constructed at a very great expense. At about two-thirds of the distance from Lake Ontario to the city of Montreal the intersection of the parallel of 45° determines the point where the St Lawrence, after having been an international boundary from the head, or nearly so, of Lake Superior, becomes exclusively Canadian. Immediately above the island of Montreal the St Lawrence is joined by its principal auxiliary, the Ottawa (800 miles), from the north-west; and a little more than half-way between this confluence and Three Rivers, the highest point of tidal influence, the Richelieu from the south brings in the tribute of Lake Champlain. Other principal tributaries are the St Maurice (400 miles), the Saguenay (100), and the Batiscan (50). The width of the St Lawrence varies from less than 1 to 4 miles; the estuary at its mouth is above 100 miles across. During winter the river is frozen over and navigation closed. For map, see CANADA.

The GULF OF ST LAWRENCE, a western inlet of the North Atlantic, washes Newfoundland, Quebec, New Brunswick, and Nova Scotia. It has three communications with the ocean—the Strait of Belleisle, between Newfoundland and Labrador; the Gut of Canso, between the island of Cape Breton and the peninsula of Nova Scotia; and a far wider passage than either, with the island of St Paul in the middle, between Cape Breton and Newfoundland; while in the opposite direction it narrows, at the west end of Anticosti, into the estuary of the St Lawrence River. Besides Anticosti, St Paul's, and Prince Edward's, already mentioned, this arm of the sea contains very many clusters of islands, which are rendered more dangerous to shipping by the thickness of the fogs and the uncertainty of the currents. Both the Gulf and River of St Lawrence are celebrated for the productiveness of their fisheries. See QUEBEC.

St Leonards. See HASTINGS.

St Lô, a town of Normandy, dept. Manche, is built on a rocky elevation on the right bank of the Vire, 60 miles by rail SE. of Cherbourg. A St Lô, Bishop of Coutances, built a church here in the 6th century; but the place was destroyed by the Normans in 888, and, having been rebuilt, taken by the English in 1346 and 1417. Noteworthy are the beautiful churches of Sainte-Croix, founded in 805, and Notre Dame (15th century). Cloth, ribbons, and laces are manufactured, and wool is spun. The astronomer Leverrier was born here in 1811. Pop. 10,327.

St Louis, fourth city of the United States in population, the commercial metropolis of the Mississippi valley, and principal city of the state of Missouri, is situated on the west bank of the Mississippi River, 21 miles S. of the mouth of the Missouri, and by rail 1108 WSW. of New York, 2434 E. of San Francisco, and 696 N. of New Orleans. On February 15, 1764, Pierre Laclède Liguest, head of the Louisiana Fur Company, established a trading-post on the present site of St Louis, giving it the name which it still bears in honour of Louis IX. of France. In 1768 the Spaniards took formal possession of Upper Louisiana, but the settlement was governed by a French captain, St Ange de Bellerive, until 1770, when Don Pedro Piernas was made lieutenant-governor and military commandant, with headquarters at St Louis. In 1800 the village again became a part of the French possessions, and in 1803 passed into

the hands of the United States. The population of the settlement in 1799 was 795; in 1810, one year after the town was incorporated, it had increased to 1400, in 1820 to 4928, and in 1840 to 16,469, while by 1844 it had grown to 34,140. Pop. (1850) 74,439; (1870) 310,864; (1890) 451,770; (1900) 575,238.

St Louis is built upon three gently sloping terraces, the summit of the third being 200 feet above and 4 miles W. of the river. Beyond this point for miles the country is almost perfectly level. The city has a river frontage of 19 miles; its greatest width is 6.62 miles, and its area 62½ sq. m. The streets in the old part of the city are narrow, but all those west of Third street, three blocks from the river, are broad and straight. St Louis has (1897) 483 miles of paved streets and alleys. The sewerage system is excellent, the length of the public and private sewers being 416 miles. The streets are sprinkled by the city government, 10,000,000 gallons of water being used each day for this purpose. The water-supply is taken from the Mississippi River by works which cost \$8,000,000, to which an extension costing \$4,000,000, and doubling the capacity, is (1897) nearly completed. St Louis has seventeen parks containing 2268 acres, the largest and most noted of them being Forest Park (1372 acres) and Tower Grove Park (267 acres), the latter, with the botanical garden, being a gift to the city by Henry Shaw the philanthropist, and claimed to be one of the most beautiful in the world.

The chief public buildings and institutions are the Four Courts, court-house, city hospital, insane asylum, women's hospital, the custom-house and post-office (which cost over \$5,000,000), the Merchants' Exchange, the Exposition Building (which covers two blocks and cost \$900,000), Mercantile Library (68,000 vols.), and new Public School Library (102,114 vols.). The Exposition, which is one of the features of St Louis, is open for forty days each autumn.

The city owns 124 school buildings and 69 kindergarten structures, and the school property is valued at \$4,239,394. The number of pupils in 1890 was 70,428, and teachers 1465. The schools are governed by a president and board of directors elected by the people. The expenditures for the public schools average \$1,500,000 annually. There are 95 parochial schools, 65 of them Roman Catholic, 27 Lutheran, and 3 Hebrew. The Washington and St Louis universities, and the Christian Brothers and Concordia colleges are the leading advanced educational institutions; but there are numerous academies and colleges of lower grade, besides two law schools, nine medical colleges, a school for nurses, a school of midwifery, and a college of pharmacy. St Louis contains 314 churches, representing almost every Christian denomination, and the value of church property is appraised at \$6,700,000. There are published in the city five English and four German daily newspapers.

Twenty railroads enter St Louis, the terminus of all being the new Union Station (1895), one of the largest and finest railway stations in the world. The Mississippi at St Louis is spanned by two bridges. The older of these, the Eads, was opened for traffic 4th July 1874, and cost \$6,536,730. It consists of three spans, the central being 520 feet in the clear, and the two side spans 502 feet each. It is a railroad, foot, and wagon bridge, and connects with the Union Dépôt by a tunnel one mile long under the city. The Merchants' Bridge, a railroad bridge, was commenced January 24, 1889, and was completed and opened for traffic May 3, 1890. It is constructed of steel, and is 2420 feet long, including approaches.

During 1896, 11,434,881 tons of freight were received in St Louis by rail and river, and 5,973,138

tons shipped. The total bank clearings of the same year were \$1,158,602,359. The receipts of grain aggregated 51,134,544 bushels, and of cotton 565,683 bales. St Louis is an important manufacturing city. In tobacco it leads the world, the product in 1896 amounting to 53,000,000 pounds. The beer production was 68,007,358 gallons, and the value of boots and shoes manufactured was \$10,000,000. Its dry-goods trade in 1896 amounted to \$35,000,000, hardware \$14,000,000, groceries \$75,000,000, furniture \$15,000,000, drugs and chemicals \$20,000,000, and boots and shoes \$31,000,000.

In 1875 St Louis was separated from the county of St Louis and given an independent government

of its own. The mayor and municipal assembly constitute the governing power. The bonded debt of the city at the close of the fiscal year ending April 13, 1896, was \$20,647,711. The payment of this debt is provided for by a sinking fund. The receipts for the same fiscal year were \$12,041,401; expenditures \$9,578,326. The total assessed value of real estate in 1896 was \$296,419,690. On May 27, 1896, St Louis was visited by one of the most destructive tornadoes on record. Property valued at over \$10,000,000 was destroyed and 140 people killed, while over 300 were more or less seriously injured. Yet by 1897 the damaged portion of the city had been entirely rebuilt and no trace was left

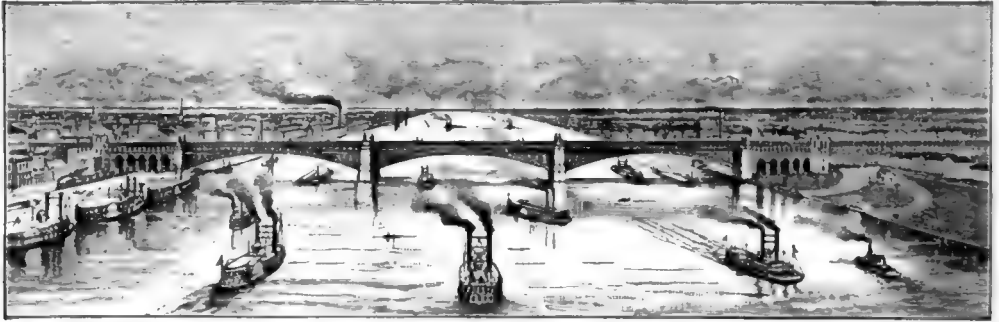

The Eads Bridge across the Mississippi, St Louis.

of the great storm. See Billon, *Annals of St Louis in its Early Days* (1887); Scharf, *History of St Louis* (1885); also EAST ST LOUIS.

St Louis, the capital of the French colony of Senegal in West Africa, is situated on a small low island near the mouth of the Senegal River. Bridges connect it with N'dar Toute, a summer watering-place, on the right bank, and with the suburb of Bouetville, the terminus of the railway, on the left bank. The mouth of the river is rendered dangerous by a shifting bar of sand. The great ocean steamers land goods and passengers at Dakar, on Cape Verde, 100 miles to the south-west, and thence they are conveyed by rail. Nevertheless, the place has a trade worth £1,000,000 a year, gums and earthnuts being exported. The climate is not healthy; water is supplied by an aqueduct $7\frac{1}{2}$ miles long. There are a cathedral, governor's palace, &c., and a public garden. Pop. 16,682.

St Louis. See MAURITIUS.

St Lucia, the largest of the Windward Islands, in the West Indies, 42 miles long and 15 to 20 wide, with an area of 233 sq. m. Pop. (1896) 46,671—1200 whites and 2600 East Indian coolies. The exports (sugar, cocoa, logwood, &c.) vary from £197,452 (1890) to £93,720 (1896); the imports from £206,693 (1890) to £190,534 (1896). Much of the island is high and rocky land, covered with well-nigh impenetrable forest, and it contains extensive deposits of sulphur. The climate is in the main healthy, a fresh trade-wind blowing almost continually. The island, discovered in 1502, was colonised by the French in 1563; but between that date and 1803, when it definitively became an English possession, it five or six times changed hands between France and England, by capture or treaty. The capital is Castries (pop. 7000). St Lucia suffered severely from the great hurricane, with deluge of rain, of 1898.

St Lucia Bay, a lagoon at the mouth of the Umfulosi River in Zululand, surrounded by uninhabitable swamps. Cape St Lucia is a promontory to the south of the channel which connects the lagoon with the sea.

St Malo, a fortified seaport of Brittany, dept. Ille-et-Vilaine, stands 51 miles NNW. of Rennes by rail, on the estuary of the Rance. The old town clusters all over a rocky islet that is surrounded with walls and connected with the mainland by a single narrow causeway (*Sillon*). Forts and batteries crown several rocks lying off the town, and the defences are completed by an old castle next the causeway. The harbour is safe, but difficult of approach; the tides sometimes rise 50 feet, and storms dash over the top of the battlements. About the end of the 17th century the people of this town reaped large fortunes by piracy in the English Channel, and the port was the headquarters of the French East India Company. Although its trade has fallen off somewhat of late, its harbour, which lies between St Malo and St Servan, and is common to both places, is still entered by 1286 vessels of 222,700 tons (average for four years ending 1890), of which 650 of 180,800 tons are British and 600 of 36,300 tons French. St Malo exports potatoes, buckwheat, barley, butter, eggs, and fruit, and imports coal (173,200 tons annually), timber, pitch, and iron. The people, 10,225 in 1886, are principally engaged in shipping pursuits. The most noteworthy features of the town are the cathedral (which has had no bishop since 1790) and the museum. This town has been the birthplace of several distinguished sons, including Chateaubriand, Maupertuis, Lamennais, Lamettrie, and the sailors Duguay-Trouin, Cartier, and Labourdonnais. The English bombarded the town in 1693 and 1695, and in 1758 an expedition led by the second Duke of Marlborough burned several vessels lying in the harbour.

Saint-Marc Girardin. See GIRARDIN.

St Martin, one of the Lesser Antilles, West India Islands, has since 1648 been divided between France and the Netherlands. It exports sugar, cotton, tobacco, maize, &c., and large quantities of salt. The French portion, a dependency of Guadeloupe, has an area of 20 sq. m. and a pop. of 3500. The Dutch portion, a dependency of Curaçao, has an area of 18 sq. m. and a pop. of 4500.

Saint-Martin, LOUIS CLAUDE, a French philosopher, born at Amboise, 18th January 1743, and died at Aurai near Chatillon, 14th October 1803. Influenced by Böhme and Mystrasin, he was a vigorous opponent of sensationalism and materialism. Of his numerous works amongst the best known are *Des Erreurs et de la Vérité* (1775); *De l'Esprit des Choses* (1800); and *L'Homme de Désir* (1790). See the *Essai* on him by Caro (1852).

St Mary Church, a town of South Devon, overlooking Babbicombe Bay, $\frac{1}{2}$ mile N. by E. of Torquay, of which it is practically a suburb. Pop. (1851) 2293; (1891) 6653.

St Mary's Loch. See YARROW.

St Mary's River, the strait connecting Lakes Huron and Superior, with a 'sault' or rapids falling 20½ feet.

St Maur. See MAURISTS.

St Mawes, a village of Cornwall, on an offshoot of Falmouth Harbour, 3 miles E. of Falmouth. It has a castle (1542), and from 1562 to 1832 returned two members.

St Michael's, or SÃO MIGUEL, the largest and most important of the Azores (q.v.).

St Michael's Mount, a conical and isolated granite rock in Mount's Bay, Cornwall, 3 miles E. of Penzance. It communicates with the shore by a causeway 560 yards long, which, however, is covered with water eight hours out of the twelve, and sometimes is impassable for two or three days together. The Mount is 195 feet high, is 5 furlongs in circumference, and is crowned by an old and picturesque castle—now used as a manorial residence—surmounted by a tower, on one angle of which there is a projecting stone lantern, popularly called 'St Michael's Chair.' At the base of the north or landward side of the Mount is a fishing-village. The 'guarded mount' is said to have received its name from an apparition of St Michael to some hermits; and Edward the Confessor founded upon it a Benedictine priory, which in 1088 was annexed to the abbey of Mont St Michel in Normandy. After the Dissolution it became the residence of five families in turn, until it was sold in 1660 to its present proprietors, the St Aubyns. For a demolition of the notion that the mount within Cornish-speaking times has been converted from a wooded promontory to an island, see vol. iii. of Max-Müller's *Chips* (1870).

St Michel, MONT, an extraordinary rocky islet of the Norman department of Manche, in the bay of St Michel, 18 miles WSW. of Avranches. It is a solitary cone of granite, a thousand yards in circumference and 242 feet high. It rises sheer out of a level expanse of sand, and, though its elevation is not great, the perfectly flat environment and its pointed crest render it a most striking feature in the landscape. Till 1880-81 it was only accessible by crossing the sands at low-water, there being a firm track across them, with quicksands to right and left; but a good road was then formed along a causeway a mile in length. A Druid stronghold once, the islet, as the scene of an apparition of St Michael in 708, became the seat of a great Benedictine monastery, which, 'half church of God, half fortress,' has memories of Henry I., II., and V. of England, resisting the last successfully in two sieges. The Revolution transformed this celebrated place of pilgrimage into a prison, and such it remained until 1863; in 1874 it was declared a 'monument historique,' and large sums have been spent on its restoration by Viollet-le-Duc and his successor. The buildings include the church (c. 1140-1521), with Norman nave and Flamboyant choir; the exquisite cloisters (1228); the Halle des Chevaliers, where Louis XI. in 1469

founded the order of St Michael; and 'La Merveille,' the monastery proper, so called from its huge north wall of the 13th century, 246 feet long and 108 high. Beneath is a little fortified town with 200 inhabitants. See Luce, *Chronique de Mont St Michel* (2 vols. 1879-86).

St Moritz, a favourite watering-place in the upper Engadine (q.v.), with chalybeate, sulphurous, and other mineral waters, and a pop. of 500.

St Nazaire, a seaport of France, dept. Loire-Inférieure, is situated on the north side of the estuary of the Loire, 40 miles by rail W. by N. of Nantes. Between 1831 and 1887 £1,450,000 was spent on harbour improvements, extensive docks (82 acres) having been built in 1845-57 and 1864-81 to accommodate the larger vessels that were unable to get up the Loire to Nantes (q.v.). Since these began to be used the shipping of the place has increased at a very rapid rate. In 1887 there entered 755 vessels, with a total tonnage of 504,286 tons; in 1890, 1621 vessels of 860,625 tons (637 of 443,714 tons being British and 911 of 381,746 French). The most important of the imports are wine ($\frac{1}{2}$ to $1\frac{1}{2}$ million gals.), coal (533,000 to 780,500 tons), tar, iron and lead, wheat and flour, timber, and manure; the exports embrace chiefly brandy (11,600 to 109,600 gals.), wine, coal, wheat and flour—these four in transit—eggs and poultry, sardines, butter, bone-dust, vegetables, dyes, glass, and toys. The respective values are not returned; but in 1886 the total trade was valued at £5,124,000. Pop. (1851) 2400; (1881) 16,314; (1891) 26,461.

St Neots, a market-town of Huntingdonshire, on the Ouse, 8 miles SSW. of Huntingdon. It takes name from Alfred the Great's eldest brother, whose relics were translated from St Neot in Cornwall to a Benedictine monastery founded at Eynesbury, close by, in 974; and it has a fine parish church, with a tower 156 feet high, a corn exchange (1863), and manufactures of iron, paper, &c. Pop. (1851) 2949; (1891) 4077. See Gorham's *History of Eynesbury and St Neots* (2 vols. 1824).

St Nicolas, a town of Belgium, in East Flanders, 12 miles by rail W. by S. of Antwerp, stands in the midst of the district of Waes, a densely-peopled and productive agricultural region. It has a large flax-market, and manufactures cotton and woollen stuffs, lace, needles, bricks, and pottery. A flourishing trade is carried on in linens, flax, corn, &c. Pop. 29,921.

St Omer, a town of France, and second-class fortress, dept. Pas-de-Calais, stands in a marshy site, on the Aa, 26 miles SE. of Calais by rail. The chief objects of interest are the Gothic cathedral (13th-15th century), with remarkable sculptures, the ruined tower and arches of the Benedictine abbey church of St Bertin, an arsenal, a museum, and a library. A college for the education of English and Irish Catholics was opened at St Omer in 1592. It was closed, however, during the Revolution, but still exists as a seminary. Alban Butler was a president, and O'Connell a student. The people carry on active manufactures of tobaccopipes, tulle, cambric, cloth, and muslin, and a brisk trade in provisions (eggs, vegetables, &c.), sugar, and spirits. Pop. (1872) 21,007; (1891) 20,829.

Saintonge, a former French maritime province, now forming mainly the department of Charente-Inférieure. The capital was Saintes (q.v.).

St Paul, a city of Minnesota, the capital of the state, occupies a commanding situation on both banks of the Mississippi near the mouth of the Minnesota, one of its principal tributaries. It is the outgrowth of a small hamlet of voyageurs, chiefly Canadian, employed in the fur trade, and

in selling whisky to the soldiers at Fort Snelling in the vicinity. The first log-huts were erected on the site of the city in 1840, and in 1841, at the suggestion of a Roman Catholic priest who made occasional visits, a small log-chapel was erected and dedicated to St Paul, which has given the name to the city. In 1842 the first family of American ancestry arrived, and in 1846 the hamlet had become of sufficient importance to have a post-office. In the act of the United States congress passed in 1849 authorising the organisation of Minnesota Territory, St Paul was designated as the capital, and from that time has occupied an important position. Then a town of about 500 inhabitants, without a brick or stone building, in 1854 it was incorporated as a city; and in 1891 the population was nearly 150,000. Upon the lower plateau of limestone rock are the capitol, post-office, court-house, and large stores; the best private residences are on the upper plateau, overlooking the Mississippi. The Summit Avenue is noted for its width and the beauty and costliness of the houses. The sanitation of the city is excellent. Ample provision is made for education. In 1851 there were two small wooden school-houses; in 1891 there were 45 school buildings, 468 teachers, 18,000 pupils, all under the supervision of a board of education and superintendent. Besides these schools supported by the public are numerous private schools. There are several colleges, not under the control of the city or state: Macalester College, the oldest of these, was chartered in 1853, and that year opened its preparatory department, known as the Baldwin School; Hamline University, chartered in 1854, is under the control of the Methodist Church; and St Thomas College is a Roman Catholic institution. The water-works furnish a daily supply of eight million gallons. All parts of the city are reached by electric street-railways. The free City Library contains 30,000 volumes. There are 138 churches, of which 19 are Baptist, 10 Congregational, 22 Lutheran, 23 Methodist, 14 Presbyterian, 12 Protestant Episcopal, and 19 Roman Catholic. In a central depot ten railways receive and deliver passengers. St Paul is the centre of the wholesale grocery and dry-goods business in Minnesota. Pop. (1860) 10,701; (1870) 20,030; (1880) 41,473; (1890) 133,156; (1900) 163,632.

St Paul, a bare volcanic islet, 860 feet high, in the Indian Ocean, midway between Africa and Australia, in 38° 42' S. lat. and 77° 32' E. long.; area, 3 sq. m. Both it and the densely vegetated New Amsterdam (26 sq. m.), 50 miles to the north, were taken possession of by France in 1843. For the beaching here of H. M. S. *Megara* (June 1871), and the eleven weeks' detention of her crew, see *Blackwood's Magazine* for January 1872.—St Paul's Rocks, a group of small islets 1° N. of the equator and 540 miles from the South American coast.

St Paul de Loanda. See LOANDA.

St Paul's School was founded in 1509–12 by John Colet (q.v.), dean of St Paul's, for 153 children 'of every nation, country, and class.' He endowed it with lands, whose yearly value has risen from £122, 4s. 7d. to £10,000; and he dedicated it to the Child Jesus, but 'the saint,' in Strype's words, 'has robbed his Master of the title.' The original schoolhouse in St Paul's Churchyard was burned in the Great Fire of 1666; the second by Wren (1674) gave place in 1824 to a third; and a fourth, on a site of sixteen acres at West Kensington, near Addison Road station, was opened by Lord Selborne on 23d April 1884. This removal was effected under a scheme of the Charity Commissioners (1879), which provided for a classical school for 500 boys, a modern school for a like

number, and a high school for 400 girls. The boys either are day-scholars or live in one of eight boarding-houses. The governing board consists of thirteen members chosen by the Mercers' Company (to whose oversight Colet committed his foundation) and nine nominated by the universities. There are seven Oxford and Cambridge exhibitions of from £80 to £40 tenable for four years, and a Woolwich one of £50 for two years, besides six other exhibitions and thirteen prizes. The first high-master, from 1512 to 1523, was William Lilye; and among his successors have been Richard Mulcaster (1596–1608), Alexander Gill (1608–35), his son and namesake (1635–40), Thomas Gale (1672–97), and Herbert Kynaston (1838–76). Famous Paulines have been Major André, the Hon. C. Boyle, Camden, Roger Cotes, Sir P. Francis, Halley, Leland, the Duke of Marlborough, Milton, Robert Nelson, Pepys, and Strype; and one has been infamous—Judge Jeffreys. See R. B. Gardiner's *Admission Registers of St Paul's School* (1884).

St Peter Port, the town of Guernsey (q.v.).

St Petersburg, the capital of the Russian empire, stands at the head of the Gulf of Finland, in 59° 56' N. lat. and 39° 19' E. long., at the mouth of the Neva. The flat and low marshy ground upon which the city is built only recently emerged from the sea, and even in historical times the hills of Pulkova and Duderhof, which are now at a distance of 9 miles from the shore, stood close by the sea. Before entering the sea the mighty Neva, which flows 36 miles from Lake Ladoga, subdivides into many branches, thus giving origin to no less than 100 islands of various sizes, the surfaces of which rapidly increase. Nearly 600 acres of land have thus been added to the area of St Petersburg during the last 150 years. When a strong wind is blowing from the sea its level rises by several feet, and the poorer parts of St Petersburg are inundated every year; but when the overflow exceeds 10 feet nearly the whole of the city is inundated too. Such was the case in 1777 and 1824, when the Neva rose 13·8 feet above its average level. In August 1891 it rose again for a few hours full 10 feet above the average. The country round St Petersburg being covered with morainic deposits, peat bog, and marshes, is of a poor aspect and so thinly peopled that the government of St Petersburg has only thirty-three inhabitants per square mile. The almost uninhabited wildernesses of Karelia, Olonetz, and Vologda, beginning at the very gates of the capital, stretch towards the north and east, while the lake-depression (see RUSSIA) and the very thinly peopled tracts of the Valdai plateau separate St Petersburg from the Russian cities of Tver, Yaroslav, and Moscow (400 miles). Within a radius of 120 miles there is not one single town worth naming, the towns nearest to the Russian capital being the now decaying Novgorod, the Finnish cities of Viborg and Helsingfors (263 miles), and the Baltic cities of Revel and Riga (449 miles). Nevertheless the mouth of the Neva was from an early period coveted by the Novgorod merchants. In the 15th century they already had their factories at the head of the delta of the Neva; so that Peter I. only followed the tradition of the Novgorodians when he took possession of the Swedish forts at the head and at the mouth of the Neva, laid the first foundations of his capital (in 1702) on one of the islands of the delta, and dreamed to make of it a new Amsterdam. His dream was realised to some extent, but St Petersburg still remains isolated from the rest of the empire. One single line of railway connects it with the head of the Volga and Moscow; another with Poland and western Europe; a third with the Baltic provinces; and a fourth with Finland. The

real connection between Russia and its capital was established through the Neva, which since it was connected by canals with the upper Volga, became the real mouth of the immense basin of the chief river of Russia and its numberless tributaries. Owing to this connection St Petersburg became, and has remained for more than 150 years, the chief port of Russia for the export of raw produce and the import of manufactured goods. Foreign trade and the centralisation of all administration in the residence of the emperor have made of St Petersburg a populous city with more than a million inhabitants and covering 42 sq. m., on the banks of the Neva and the islands formed by its branches—the Great Neva, the Little Neva, the Great Nevka, the Little Nevka, and scores of others.

The Great Neva, the chief branch, which has within the city itself a width of from 400 to 700 yards, and carries every second 1,750,000 cubic feet of very pure water, is a most beautiful river. It is so deep that large ships can lie alongside its granite embankments. But it is rather shallow at the mouth, with a narrow and sinuous channel across the bar, so that Cronstadt, built on an island 16 miles to the west of St Petersburg, remains both the fortress and the port of the capital. Since 1885 a ship-canal, 22 feet deep, admits ships to the Galernaya Harbour in the south-west corner of St Petersburg, and two-thirds of the foreign vessels unload within the city itself. The main body of the city, containing more than one-half of its inhabitants as well as all the chief streets, stands on the mainland, on the left bank of the Neva; and a beautiful granite quay, with a long series of palaces and mansions, stretches for 2½ miles from the timber-yards in the east to the New Admiralty in the west. Only two permanent bridges cross the Neva; the other two, built on boats, are removed in autumn and spring, as well as when the ice of Lake Ladoga comes down the Neva in the beginning of May. The island Vasilievsky, between the Great and Little Nevas, has at its head the Stock Exchange, surrounded by spacious storehouses, and a row of scientific institutions, all facing the Neva—the Academy of Sciences, the University, the Philological Institute, the Academy of Arts, and various schools and colleges. On the Peterburgskiy Island, between the Little Neva and the Great Nevka, stands the old fortress of St Peter and St Paul, facing the Winter Palace, and containing the Mint and the cathedral wherein the members of the imperial family are buried; its old-fashioned casemates are used as political prisons. It has behind it the arsenal, and a series of wide streets bordered by small, mostly wooden houses, chiefly occupied by the poorer civil service functionaries. Farther up the mainland on the right bank of the Neva is covered by the poorer parts of the city, but contains some public buildings and a great number of factories. Numerous islands, separated from each other by the small branches into which both Nevas subdivide, and connected together by a great number of wooden bridges, are covered with beautiful parks and summer-houses, to which most of the wealthier and middle-class population repair in the summer. The main part of St Petersburg has for its centre the Old Admiralty; its lofty gilded spire and the gilded dome of St Isaac's Cathedral are among the first sights caught on approaching St Petersburg by sea. Three streets radiate from it, east-south-east, south-east, and south; the first of them the famous Nevskiy Prospect; while four canals describe irregular half-circles which intersect these three streets at right angles. The street architecture, with its huge brick houses covered with stucco and mostly painted gray, is rigid and

military in aspect. But the canals and the bridges which span them, the width of the chief streets, and an occasional glimpse of the Neva or of some broad square break the monotony.

A spacious square, planted with trees, encloses the Old Admiralty on three sides. To the east of it rise the huge and magnificent mass of the Winter Palace, the Hermitage Gallery of Art, and the semicircular buildings of the general staff, which surround a square facing the palace, and adorned by the Alexandra column, a shaft of red granite 84 feet high. To the west of the Admiralty is the Petrovskiy Square, where prances the well-known statue of Peter I.—the work of Falconet—on an immense block of granite brought from Finland. The cathedral of St Isaac of Dalmatia, in the south of it, is an almost cubic building (330 feet long, 290 broad, and 310 high), surmounted by one large and lofty and four small gilded domes. This church, erected by Nicholas I., is devoid of architectural beauty, but its peristyles of immense red granite monoliths give it a character of rude majesty. Its interior decorations are very rich, and it contains pictures painted by the best representatives of Russian art during the last half century. A somewhat stiff monument to Nicholas I. by Baron Clodt stands on a large square to the south of the cathedral.

The Nevskiy Prospect is one of the finest streets of the world, not so much for its houses—they are of a very mixed and mostly vulgar architecture—as for its immense width and length, the crowds which overflow its broad *trottoirs*, and the vehicles which glide over its wooden pavement. It runs for 3200 yards, with a width of 130 feet, from the Admiralty to the Moscow railway station, and thence with a slow bend towards the south for another 1650 yards, to reach again the Neva near the Smolnyi convent. About midway in its first part it passes by the Kazan cathedral, the Gostinnoi Dvor—a two-storied building containing numerous shops—the public library, the square of Catharine II. adorned with a gorgeous but tasteless statue of the empress, and the Anitchkoff Palace. It crosses the Fontanka on a broad bridge adorned by four groups in bronze of wild horses with their tamers.

The climate is less severe than might be expected, but it is unhealthy and very changeable on the whole. The average temperatures are 15·4° F. in January, 64° in July, and 38·6° for the year. Still, the Neva remains frozen for an average of 147 days every year. A short but hot summer is followed by a damp autumn and very changeable winter, severe frosts being followed by rainy days in the midst of winter, and returning in April and May after the first warm days of the spring.

The population has rapidly increased during the 19th century, and attained, with the suburbs, 1,267,023 in December 1897, as against 918,016 in 1881. But it decreases very much during the summer (849,315 in July 1889), chiefly because masses of peasants who come to work in the factories in winter time return to their villages in summer. Thus in July 1889 the population of the city proper was 724,102; in December, 924,466; in July 1890, 731,336; in December 1890, 956,226. The sanitary arrangements being very imperfect, typhoid fever and European cholera are endemic, and their attacks are especially severe upon newcomers. The mortality is high: from 31 to 39 per thousand before 1885, but since only 28. The birth-rate has for many years been 31·2 to 31·6 per thousand. Before 1885 the deaths exceeded the births. The great majority of the population belong to the orthodox Greek Church; about 10 per cent. are Protestant, chiefly Germans and Finns; 3 per cent. Roman Catholics; and 2 per cent. Jews.

As a manufacturing centre St Petersburg has not the importance of Moscow, the total yearly production of its factories (cottons, various textiles, metals, leather, sugar, guns, porcelain goods, &c.) not exceeding £20,000,000. There are many large factories in the surrounding country, but the industrial establishments of the capital itself are chiefly small, with an average of ten workers each. In addition to the four main lines of railway already mentioned, St Petersburg has three local lines which connect it with Lake Ladoga and suburban towns. The opening of the new deep-water dock in 1895 adds considerably to its facilities as a port for ships of large tonnage. The trade of St Petersburg is very considerable. Every year no less than 12,000 to 13,000 boats and nearly as many rafts, loaded with corn, hemp, flax, linseed, leather, fuel-wood, and building materials, representing a total of nearly 3,000,000 tons, reach St Petersburg *viâ* the Neva. At the same time about 1,260,000 tons of various goods, including 500,000 tons of corn, come in by rail, chiefly from the upper Volga. The exports of corn alone from St Petersburg attained 862,000 tons in 1888, that is, one-third of the total export of corn from the Baltic ports, and one-fifth of the total export from Russia. Large quantities of hemp, flax, linseed, leather, crude petroleum, &c. must be added to the above—the total value of the exports being from £8,000,000 to £10,000,000; the imports, chiefly of coal, machinery, groceries, and manufactured goods, reach about the same value. The port is visited every year by about 1800 ships.

The great number and variety of scientific, literary, artistic, and technical institutions, and of institutions for higher education, which are concentrated in the capital, as well as the development of the press, render life at St Petersburg especially attractive, the more so as the provincial towns of Russia decidedly suffer from a lack of such. Even Moscow, which down to 1848 was the intellectual centre of Russia, has largely fallen from that position. The St Petersburg University, and the numerous academies, medical, technological, engineering, naval, military, &c., as well as the Ladies' University, number several thousands of students, both male and female. The scientific societies are very numerous: the Academy of Sciences and its branches are well known to European scientists. Great facilities for work in all branches of art are afforded by the Academy of Arts; and St Petersburg is on the whole a very musical city, with an excellent conservatoire. The public libraries are numerous. Besides the Imperial Public Library (1,200,000 volumes and 40,000 MSS.), there are the libraries of the Academy of Sciences, the University, the Council of State, as well as those of the scientific societies, some of which are very rich in their special branches. There are besides rich museums of art in the Hermitage (Flemish, Russian, and early Italian schools well represented, and priceless collections of Greek and Scythian antiquities), in the Academy of Arts, and in several private collections; while the scientific museums of the Academy of Sciences, the Mining Institute, the Asiatic Museum, &c. enjoy a high repute in the scientific world. The press is represented by nearly 120 periodicals, and the greatest part of the Russian publishing trade is concentrated at St Petersburg.

St Pierre, the largest town, though not the capital, of the island of Martinique (q.v.), in the West Indies, has a good harbour (defended by a fort), a cathedral, a college, a botanical garden, and 28,000 inhabitants. It was founded in 1665, and was the birthplace of Josephine, consort of Napoleon I.

St Pierre. See RÉUNION, and MIQUELON.

Saint-Pierre, JACQUES-HENRI BERNARDIN DE, the author of *Paul and Virginia*, was born at Havre, 19th January 1737. His parents were amiable but foolish people with absurd pretensions to family, and the education of the abnormally imaginative boy was ill regulated from the beginning. He found his ideals in the Lives of the Saints and *Robinson Crusoe*, made a voyage to Martinique in one of his uncle's ships, and returned to pursue irregular studies at Caen and Rouen. He dreamed of a missionary's life, but was sent to Paris to become an engineer, and found himself at twenty-three on his father's second marriage compelled to shift for himself. He served some time in the Engineers, but quarrelled with his chiefs and was dismissed, and next year was sent to Malta only to suffer the same experience. His head was turned by the writings of Rousseau, and he made public employment impossible for him by the innumerable utopian memoirs and criticisms on matters of administration with which he deluged the bureaux of the ministers. Buoyed up by dreams of a new state to be founded on the shores of the Sea of Aral, he travelled on nothing to Russia, and returned in dejection to Warsaw, where in his three months' stay occurred the romance which grew into that legend of the love of a princess which he ended by believing in himself. Next followed further wanderings to Vienna, Dresden, and Berlin, and a government expedition to Madagascar, which he abandoned at the Ile de France, to spend there almost three years of melancholy and observation. In June 1771 he returned to Paris, his head full of ideas, yet he hesitated awhile before he recognised his true vocation. His *Voyage à l'Île de France* appeared early in 1773, and at first attracted little attention. Yet it gave a distinctly new element to literature in that close portraiture of nature—that apprehension of the mysterious correspondence between the spectacle and the spectator, which nowadays adds the personal accent to descriptions of landscape. As he himself said of the contemporary descriptions, 'la physionomie n'y est pas,' and indeed even Rousseau's *Confessions* and *Réveries* (both later) give us sensations rather than images.

A close friend of Rousseau in his last years, Saint-Pierre became misanthropic and half-crazy through poverty and lack of sympathy, and wearied out his few friends with his importunities. His *Études de la Nature* (3 vols. 1784) showed the strong influence of Rousseau in its sentimentalism, its inspired folly, and the ridiculous length to which it carries the use of final causes. He proves the existence of God from poetic reasons; everything in nature points to Him, for God made nature for man, and man for Himself. Nature makes men good; society corrupts them—'plus la société est policée, plus les maux y sont multipliés et cruels.' Hence the value of ignorance—the mother of all mystery—especially to women. In his Elysium are no capitalists nor nobles, but monuments to the inventors of useful arts, and such especial benefactors of the race as Nicot, who introduced tobacco into Europe. Not to speak of more essential faults, the book contains much wild physical science, as his theories of the tides and elongation of the poles. The new work was received with immense applause, and a fourth volume followed in 1788, containing the immortal *Paul et Virginie*, its author's one work of genius. Humboldt owns the wonderful truth with which it realises the splendours of tropical vegetation, but it is as an exquisite idyll of love growing up unconsciously in two natural hearts that the book possesses a perennial charm even for such critics as Sainte-Beuve and Gautier. *Daphnis and Chloe* suggested

the idea of the change from friendship into love, but individual genius alone wrought the peculiar spell which carried *Paul and Virginia* quickly across Europe in English, Italian, Dutch, Russian, Polish, and Spanish translations, and which made Napoleon take it with him in his Italian campaign, and re-read it at St Helena. Yet the story has many faults besides its overstrained sentimentality—it is sadly marred by its didactic passages, and indeed the whole is but an object-lesson to the *Études*. His next works were *Vœux d'un Solitaire* (1789) and the weaker novel, *La Chamrière Indienne* (1791).

At fifty-five Saint-Pierre married the daughter of his printer, a girl of twenty, and at sixty-three he married another young girl, who after his death became the wife of Aimé Martin, his enthusiastic biographer and editor. A member of the Institute from its foundation in 1795, he was admitted to the Academy on its revival in 1803, but he made himself ridiculous by childish quarrels with his fellow-members. Napoleon heaped favours upon him, and he lived comfortably amid his flowers till his death in his country-house at Eragny, near Pontoise, 21st January 1814.

Saint-Pierre wrote down to the last, yet did not succeed in destroying his reputation. His *Harmonies de la Nature* (3 vols. 1796) was but a pale repetition of the *Études*. Besides these the *Le Café de Surate*, and the *Essai sur J.-J. Rousseau* alone deserve to be named. His name survives only in his one masterpiece, but his influence remains entire in the greater Chateaubriand and Lamartine.

His *Œuvres Complètes* by Aimé Martin fill 12 volumes (1813-20); the *Correspondance*, 4 volumes (1826). His great Biography by the same editor appeared in 1820; its extravagance may be corrected by Arvéde Barine's clever study (1891) in *Les Grands Écrivains Français*. There are also books by Fleury (1844) and Prévost-Paradol (1852).

St Pol de Léon, a decayed town in the Breton department of Finistère, near the English Channel, 13 miles NNW. of Morlaix. It has a 13th-century cathedral, dedicated to St Pol, who came hither from Cornwall in the 6th century, and also the Kreizker church, with a beautiful spire 263 feet high. Pop. 3914.

St Quentin, a town in the French dept. of Aisne, stands on the Somme, by rail 95 miles NE. of Paris and 33 S. of Cambrai. The church of St Quentin is a remarkably fine Gothic structure, dating from the 12th to the 15th century, and containing a much more ancient crypt. The town-hall (15th and 16th centuries) is also a fine specimen of Gothic. The town is a centre of the cotton industries, which give employment to 130,000 hands in the making of calicoes, tulle, cretonnes, jaconets, muslin, merino, cambric, gauze, and so forth. Further, vast quantities of embroidery are prepared, and machinery, hats, paper, sugar, soap, and beer are manufactured. The French historian Martin was born here in 1810. Pop. (1856) 26,887; (1896) 48,868. St Quentin and its vicinity have been the scene of two memorable battles. The Spaniards under the Duke of Savoy and Ferdinand Gonzaga, assisted by an English contingent under the Earl of Pembroke and Egmont in command of the Flemings, inflicted a crushing defeat upon the French under Constable Montmorency, on 10th August 1557 (St Lawrence's Day), a victory which Philip II. commemorated in the *Escorial* (q.v.). Shortly afterwards the town, after a brilliant defence by Coligny, capitulated to the Spanish army. On 19th January 1871 the Germans under Von Goeben put to rout the army of Faidherbe, capturing nearly 10,000 prisoners.

St Raphael, a popular health resort near Fréjus (q.v.).

Saint-Réal, CÉSAR VICHARD, ABBÉ DE, who has been, and not undeservedly, styled the French Sallust, was born in 1631 at Chambéry, and died there also in 1692. He went early to Paris, visited London and there lived awhile under the shelter of St Evremont and the Duchesse de Mazarin, but in 1679 settled at Chambéry as historiographer to the Duke of Savoy. He had been long a student of history when in 1674 he covered himself with distinction by his brilliant *Histoire de la Conjuraction que les Espagnols formèrent en 1618 contre la République de Venise*, which to this day is counted among French classics. His style is vivid and vigorous, simple and pure, yet picturesque; and the story is unfolded with a skilful mastery of dramatic sense. It has been objected that the facts are not always reliable, the conclusions frequently unsound, but it should be remembered that Saint-Réal wrote history before the modern conception of history awoke, and that his aim was to produce a good literary narrative, not a chronicle. A work of art should be estimated according as it corresponds to the ideal of the writer, rather than to the prepossessions of the individual reader, and, this test applied, the *Conjuraction contre Venise* remains an exquisite masterpiece of historical painting in miniature.

Saints. See SAINT.

Saint-Saëns, CHARLES CAMILLE, an eminent French musician, was born in Paris, October 9, 1835. At the age, it is said, of two and a half years he was taught the pianoforte by his great-uncle, and at seven he had further instruction from Stamaty, and subsequently learned harmony under Maleden. In 1847 he studied the organ under Benoist. At the age of sixteen he wrote his first symphony, which was performed with success, and was followed by numerous other instrumental works. He became organist, first of the church of St Méry, and in 1858 of the Madeleine, where he continued till 1877. His first opera, *La Princesse Jaune*, was given in 1872, and *Le Timbre d'Argent* in 1877; but neither was successful. *Samson et Dalila*, a sacred drama, was produced at Weimar, also in 1877, and was subsequently successfully revived at Ronen. More important operas are *Henri VIII.*, brought out in 1883 at the Grand Opéra with success, not however extending to its subsequent revivals; *Proserpine*, given in 1887, but received with disapprobation; and *Ascanio*, produced at the Grand Opéra, March 21, 1890, and well received, though not with unmixed praise. He is one of the greatest living exccutants on the pianoforte and organ, and has remarkable powers of improvisation. He has appeared as a performer in various countries, and several times in England. His reputation as a composer is high, but he holds a somewhat peculiar position in his own country, where the great criterion of ability is the opera, in which he has not attained the highest rank; while many of his instrumental works, which include three symphonies, four symphonic poems (in which he follows the lead of Liszt), two orchestral suites, several concertos for piano and orchestra, and violin and orchestra, and, above all, a considerable quantity of chamber music, show the most consummate mastery, if not genius. The faults laid at his door are inequality, incongruity, and occasional eccentricity. He is a distinguished musical critic; and his selected papers, *Harmonie et Mélodie* (1885), show a lucid style and temperate judgment.

Saintsbury, GEORGE EDWARD BATEMAN, was born at Southampton, October 23, 1845, and was educated at King's College School, London, and Merton College, Oxford. From 1868 till 1876 he filled scholastic appointments at Manchester,

Guernsey, and Elgin, but soon after established himself firmly in the literary world of London as one of the most active and influential critics of the day. All his work is characterised by clearness of thought, fullness of knowledge, and force, if not always grace of style; and he has been invaluable to his generation as a guide to French literature old and new. He has been an active contributor to the greater magazines (of *Macmillan's* he was for some time editor) and to encyclopædias, including the present work. Among his books are a *Primer* (1880) and a *Short History* (1882) of French literature; *Dryden* in 'English Men of Letters' (1881), and *Marlborough* in 'English Worthies' (1885); a *History of Elizabethan Literature* (1887); a short history of *Manchester* (1887); *Essays in English Literature, 1780-1860* (1891); *Essays on French Novelists* (1891), a life of Lord Derby (1892), *Miscellaneous Essays* (1892), *Corrected Impressions* (1893) and *English Literature in the 19th Century* (1896). Mr Saintsbury, who in 1895 was appointed professor of English Literature in Edinburgh University, has edited Scott's *Dryden*, *Specimens of French Literature* (1883), *Specimens of English Prose Style* (1885), and several French classics for schools; and given us a translation of Scherer's *Critical Essays on English Subjects* (1891). Later works are *The Flourishing of Romance and Rise of Allegory* (1897), a book on Scott (1897), and a *Short History of English Literature* (1898).

St Servan, a French seaport, department Ille-et-Vilaine, on the estuary of the Rance, and separated from St Malo (q.v.) by a creek a mile wide. See SISTERHOODS. Pop. 10,179.

Saint-Simon. CLAUDE HENRI, COMTE DE, the founder of French socialism, was born at Paris, October 17, 1760. He belonged to a branch of the same ancient and noble family as the duke whose memoirs are so celebrated. The young count had D'Alembert for tutor, and from his earliest years was inspired by an ambition which was not un-mixed with vanity. He ordered his valet to rouse him every morning with the words, 'Rise, *Monsieur le Comte*, you have great things to do.' Like other French nobles, he showed his youthful enthusiasm for liberty by serving as a volunteer in the American war of independence against England. He did not, however, take any prominent part in the Revolution in his own country; his birth as an aristocrat brought him into suspicion with the extreme party, and he was imprisoned for a time. But he made a little fortune by speculating in confiscated lands; not from love of money, as we are assured, but that he might have leisure to promote the grand projects which he was now contemplating.

His ancestor Charlemagne had appeared to him in a dream, and encouraged him to devote his life to philosophy, by promising that his successes as philosopher would equal those of the emperor as warrior and statesman. Accordingly Saint-Simon now went through a long course of study and experiment to fit himself for his new career. Pleasure and science were alike welcome to him, provided they enlarged the circle of his knowledge and experience. One of his experiments was matrimony (1801); it proved a failure, and was soon terminated by a divorce. The lavish expenditure incurred during his experiments also reduced him to utter poverty, in which he passed the rest of his life. It was at this time that he made his characteristic proposal of marriage to Madame de Staël: 'Madame, vous êtes la femme la plus extraordinaire du monde, comme j'en suis l'homme le plus extraordinaire; à nous deux nous aurions, sans doute, un enfant plus extraordinaire encore.' Madame de Staël, however, declined to humour the philosopher, and

Saint-Simon, now beginning to be in straits, published his first work, *Lettres d'un Habitant de Genève à ses Contemporains* (1803). His early writings were scientific and speculative. The first distinct approach to an enunciation of socialism occurred in a work *L'Industrie*, which appeared in 1817, and similar views were set forth in *L'Organisateur* (1819), *Du Système Industriel* (1821), *Catéchisme des Industriels* (1823). The last, and by far the most important, work of Saint-Simon was the *Nouveau Christianisme*, published in 1825. While writing these works the philosopher lived in utter penury, being often destitute of decent food and clothing, and hardly able to scrape together the means of publishing them. But for the kindness of friends and a small pension allowed him by his family in 1812 he would have died of starvation. In 1823 he had so exhausted his funds that he tried to shoot himself with a pistol, and lost an eye in the attempt. He died May 19, 1825.

It will be seen that the most prominent feature of Saint-Simon's life was the originality with which he ordered it for himself. The heroic fortitude which he showed in enduring extreme poverty and neglect cannot be too highly commended. That his originality degenerated into eccentricity and vanity is evident enough. The like qualities and defects are found in his works. They are wanting in sober-mindedness, judgment, and system; they are loose, diffuse, and full of repetitions. Yet there must have been a great charm both in the personality and in the theories that attracted so many of the brightest and ablest young men of France, including Comte and Augustine Thierry. Notwithstanding all his vagaries and eccentricities, the man who originated Comtism and French socialism must be regarded as a seminal thinker of high rank. He sowed the seed which afterwards grew into important systems. In opposition to the destructive spirit of the Revolution, he sought after a positive reorganisation of society. He desired that the feudal and military system should be superseded by an industrial order controlled by industrial chiefs, and that the spiritual direction of society should pass from the church to the men of science. In the *Nouveau Christianisme* the cause of the poor is laid down as the groundwork of religion. Proceeding from the grand precept, 'Love one another,' Saint-Simon thus enunciated the fundamental principle of the new Christianity: 'The whole of society ought to strive towards the amelioration of the moral and physical existence of the poorest class; society ought to organise itself in the way best adapted for attaining this end.' According to Saint-Simon, the essence of religion and the transforming principle of the new society are alike contained in these words.

After his death the vague ideas of Saint-Simon were developed by his disciples into an elaborate system of socialism. During the excitement produced by the revolution of 1830 the school attracted great attention both in France and Europe. The *Globe* became its organ, and many of the most promising youth of France joined it. An association living out of a common purse was established. But dissensions connected with the marriage question arose between the two leaders, Bazard and Enfantin. Bazard, with many important members, seceded, and Enfantin, who had advocated lax ideas on the relations of the sexes, led the association into the lower depths of extravagance and absurdity till the courts of law interfered, and the society was broken up in 1832. Many members of the school afterwards played a leading part in various departments of French life. The first systematic presentation of socialism may be regarded as due to the Saint-Simon school, and it

is deemed most convenient to give an account of their views under the article SOCIALISM.

An admirable edition of the works of Saint-Simon and *l'Infant* was issued by survivors of the school (36 vols. Paris, 1865-74). See also Reybaud, *Études sur les Réformateurs Modernes*; Paul Janet, *Saint-Simon et le Saint-Simonisme*; A. J. Booth, *Saint-Simon and Simonism*.

Saint-Simon, LOUIS DE ROUVROY, DUC DE, a great French writer, was born at Paris, January 16, 1675. His father, who was sixty-eight at his birth, had been a page and favourite of Louis XIII., and had risen rapidly at court, becoming First Equerry in 1627, and finally duke and peer in 1636, but soon after fell into disgrace, and passed much of his time thereafter at the castle of Blaye on the Gironde, which as governor he kept for the crown throughout the Fronde. The boy was given the title of Vidame of Chartres, as those of marquis and count had become too common. He received a careful education at home and at the academy of Rochefort, entered the service in the king's household troops in 1691, and behaved with spirit at Neerwinden (1693) under the eye of Luxembourg. He succeeded his father in the title, as well as in all his appointments, in 1693, married in 1695, and served in the army of the Rhine under his father-in-law, the Marshal de Lorges, from 1694 till the peace of Ryswick, having offended Luxembourg by championing the action of the dukes in Parliament against his claim in a question of privilege. Dissatisfied with his promotion, he left the service in 1702, and repaired to Versailles, where he studied the 'insects of the court,' and conformed to all the tedious etiquette of Louis XIV., without for some years enjoying any measure of the royal favour. He embroiled himself in an endless series of disputes with members of the peerage about points of precedence and privilege, such as the carrying round the alms-plate in the chapel, which the ladies of the ducal family of Lorraine had refused to do. He made bitter enemies of the powerful Marquis d'Antin, as well as the Duc de Maine, the eldest of the king's bastards by Madame de Montespan, who had been, to his great displeasure, given in 1694 a special rank below the princes but above the other peers; and he was disliked by the Dauphin and the whole 'cabal of Meudon' which surrounded him. Indeed he left Versailles for a time, and passed most of the year 1709 in the country at La Ferté. But he recovered the king's favour by his efforts to bring his friend Orleans to a more reputable life, and by his successful intriguing in the project to marry the Dauphin's favourite son, the Duc de Berry, to the daughter of Orleans. The marriage took place in July 1710, and the Duchess de Saint-Simon was, to his great regret, made lady-in-waiting to the young Duchess de Berry, and passed nine uncomfortable years of attendance upon her half-maniac mistress. The death of the Dauphin (April 1711) relieved him of all anxiety for the future, for his son, the Duke of Burgundy, Fénelon's pupil, was his warm friend. But his joy was short-lived, for the virtuous young Dauphin and Dauphiness were both carried off by fever in February 1712. Another mortification was the elevation of the two bastards in 1714 to be princes of the blood. The king's death on 1st September 1714 opened up a bitter struggle between Orleans and Maine, in which Saint-Simon supported his friend with equal warmth and boldness. It ended in the complete triumph of Orleans; but, though Saint-Simon had a seat on the council of the regency, he found Orleans indifferent to his schemes of financial reform, and the restoration to the peers of a paramount position in the work of government; and he failed to prevail upon him even to decide the momentous 'Affaire du Bonnet,' as to whether the

president should keep his cap on his head or before him on the table when addressing the peers in Parliament. But he had at least the gratification of seeing 'the bastards' degraded from the princely rank, and the proudest day of his life was that of the Bed of Justice (August 26, 1718), in which his hated enemies, the members of the Parlement, were called in to hear the decree and witness the fall of their patron Maine—to this day alone he devotes seventy-seven pages of his *Mémoires*. His influence decreased as that of Dubois rose; but he was sent to Spain in 1721 on a splendid special embassy to demand the hand of the Infanta for the young king, Louis XV. The death of Orleans in December 1723 closed his public career, and he spent the next thirty years in calm retirement at his château of La Ferté Vidame near Chartres, 77 miles distant from Paris. He lost his much-loved wife in 1743; three years later, his eldest son, who left only a daughter behind him. His second son died childless in 1754; his only remaining child, a daughter, was ugly and deformed, yet married the Prince of Chimay in 1722, although she never left her father's house. Saint-Simon died in his house at Paris, 2d March 1755. He had struggled all his days with colossal debts, and he sank at last into sheer insolvency.

Saint-Simon amused himself, between the years 1734 and 1738, in making notes in an interleaved copy of Dangeau's dry and servile *Journal* (written 1684-1720); but he seems to have begun his own journal before 1699. Finally, about 1739, he began to prepare the *Mémoires* in their final form, and this task he completed about 1752. This precious MS. was claimed by his cousin, the Bishop of Metz, but it was finally impounded in 1761 by the Duc de Choiseul for the Foreign Office. It was read to furnish amusement for Madame de Pompadour; Madame du Deffand speaks of it in a letter to Horace Walpole; and it had undoubtedly been seen by Duclos, Marmontel, and Voltaire. A volume of garbled extracts appeared at Brussels in 1780, but it was not till 1830 that the first authentic edition appeared, the MS. having been given to General de Saint-Simon by Louis XVIII. The first adequate edition was that in 20 volumes, edited by Chéruel in 1856, which at once attained an extraordinary popularity. But the final edition of the inimitable *Mémoires* is that in *Les Grands Écrivains*, by M. de Boislisle (30 vols.—vol. i. 1871; vol. viii. 1891). There is an abridged English translation by Boyle St John (4 vols. 1857). The additions to Dangeau had been published along with the *Journal* in 19 volumes, 1854. The rest of Saint-Simon's voluminous MSS. were locked up till 1880, when M. de Freycinet opened them up. M. Prosper Faugère published the *Écrits Inédits* (8 vols. 1880-92). The *Lettres et Dépêches* of the Spanish embassy were edited by M. E. Drumont (1880); the *Projets de Gouvernement du Duc de Bourgogne* in 1860.

Saint-Simon's Memorials on Precedent and Privilege are not interesting, nor yet his Letters, but his *Mémoires* remains a consummate masterpiece of literary art, in its kind absolutely alone. His knowledge of military affairs was inadequate; his fondness for a striking story was a standing snare to him; and other inaccuracies are plentiful enough; while his narrative is constantly marred by defective information and by prejudice, never by deliberate falsehood. In the introduction he claims himself, and with justice, as 'straight-forward, truthful, candid, and inspired with honour and integrity.' He was an honest hater—'all my life,' he says, 'I have known only too well how to love and how to hate'—but if he heaps his hatred upon Vendôme, Villars, Madame de Maintenon, Maine, Noailles, and Dubois, he has no less intense a love for Beauvilliers, for his spiritual adviser the Abbot Rançé of La Trappe, and for his young hero the Duke of Burgundy. His life was pure in an impure age; he had an un-French dislike to all such frivolities as cards and frequenting play-houses; there is but one instance even of his

taking part in a hunt. He describes with pity the horrors of hunger among the peasantry during the winter of 1709; and his heart was hot within him at the inhuman persecutions of the Jansenists and the Huguenots, which he ascribes directly to Madame de Maintenon, herself 'the dupe of her own hypocrisy'—a mere tool in the hands of the Jesuits. He loved the old Gallicanism of the French Church, and abhorred the infamy of the Revocation, and he describes the military disasters and humiliation of the king's later years with a remorseless truth that does not impair his patriotism, although it has cost him the favour of Chauvinist editors, and even of M. Chéruel. 'A reign of blood and brigandage and perpetual wars against all Europe continually allied against him and armed by the necessity of defending itself'—so he described the epoch of the Grand Monarque. He does ample justice to the dignity and kingly deportment of Louis, who 'never considered that any one but himself had been king of France.' He was an admirable observer, and he has left us an inimitable gallery of the portraits of a whole court, all distinct and individual, vivid and real, snatched securely from forgetfulness and the night of time. He usually sketches the physical aspect first, with a few firm graphic strokes, and he gives colour, fire, life, to everything he touches, for he possesses that magical power of vision which enables the reader to divine and resuscitate a vanished past. His aim was to make his reader think 'not that he is reading a history or memoirs, but rather that he is himself in the secret of all that is represented to him, and spectator of all that is related,' and in his aim he succeeded as no other has done before or since. Yet his style is unstudied, slap-dash, full of confusions of construction—'il écrit à la diable pour l'immortalité,' said Chateaubriand. Villemain and Marmontel placed him above all contemporary writers; Taine ranks him with Pascal and La Fontaine, Sainte-Beuve with Molière and Bossuet. The last and greatest critic with these words sums up his judgment: 'Thanks to him—un Tacite au naturel et à bride abattue—we have nothing to envy in the earlier writer. And what is more, the vein of comedy, which he has so boldly scattered through his Memoirs, has given us in him truly a Tacitus à la Shakespeare.'

See Sainte-Beuve, *Causeries du Lundi* (vols. iii. and xv.), and *Nouveaux Lundis* (vol. x.); Taine, in *Essais de Critique et d'Histoire*; Chéruel, *Saint-Simon considéré comme Historien de Louis XIV.* (1865); Clifton W. Collins, in 'Foreign Classics' (1880); Henry Reeve, *Royal and Republican France* (vol. i. 1872); and the admirable study by Edwin Cannan—the Lothian prize essay for 1885.

St Stephen's. See WESTMINSTER.

St Sulpice, the famous diocesan seminary for priests in Paris, close by the large and wealthy church of St Sulpice, on the south side of the Seine, near the Luxembourg.

St Thomas, a volcanic island of Africa belonging to Portugal, lies in the Gulf of Guinea 170 miles W. of the mouth of the river Gaboon. Its southern extremity almost touches the equator. Measuring 32 miles by 21, it has an area of 360 sq. m.; pop. nearly 20,000, including 1000 whites. Although it rises to the altitude of 6000 feet, it has the reputation of being very unhealthy. Coffee and cocoa, with some pepper, cinnamon, maize, indigo, &c., are the principal products. Chief town, St Thomas (pop. 3000), on the north-east coast, the seat of a bishop. The island was discovered in 1470, and colonised in 1493 by the Portuguese, to whom it reverted after a Dutch occupation from 1641 to 1844. See Crouch, *Glimpses of Fevcrland* (1889).

St Thomas, one of the Virgin Islands in the West Indies, belongs to Denmark, and lies 36 miles E. of Puerto Rico. Area, 33 sq. m.; pop. 14,389, 8632 of them women, and nearly 600 Jews. English is the language of the educated classes. The surface is hilly (1555 feet) and the soil poor. The cultivation of vegetables, guinea grass, and a small quantity of cotton employs the scanty rural population. The port, Charlotte Amalie or St Thomas (pop. 12,000), was formerly a busy emporium for the European trade with the West Indies, the harbour in which the merchant fleets assembled to wait for their convoys, and later the principal port of call in the West Indies. All these advantages have now passed from it. Before the abolition of slavery it was covered with prosperous sugar-plantations. The island is often visited by earthquakes, but they are not, as a rule, so destructive as the cyclones. It was first colonised by the Dutch in 1657. The British held it in 1667-71, 1801, 1807-15.

St Thomas, a town of Ontario, 15 miles S. of London by rail, 112 ENE. of Detroit, and 9 miles N. of Port Stanley on Lake Erie, with sawmills, foundries, and railway works. The town, which has a ladies' college, is an important railway centre, and has grown rapidly. Pop. (1891) 10,370.

St Thomas's, one of the great London hospitals, dates from 1553, and is now housed in seven four-storied red-brick pavilions, a spacious but ugly building standing opposite the Houses of Parliament, on the south side of the Thames. The present edifice cost £500,000. The revenue of the hospital is about £40,000. It treats annually 6000 in-patients and over 60,000 out-patients.

St Victor, HUGO OF, a mediæval theologian, a Fleming, born near Ypres in 1097, died in 1141 as prior of the Augustinian monastery of St Victor at Paris, was a man of the school of Bernard of Clairvaux, and a mystic, his favourite teaching being that the intellect or its exercise, reasoning, will never enable man to discover the 'uncorrupted truth of things.' His writings were very popular in the monastic schools and in pietistic circles during the middle ages. His pupil, RICHARD OF ST VICTOR, prior of his monastery from 1162 to 1173, and a Scot by birth, went even further than Hugo in that he proclaimed mystic contemplation to be above reason.

Saint-Victor, PAUL DE, a superfine French writer, was born at Paris in 1827, the son of a poet who translated Anacreon and became a fine connoisseur in painting. He had his education at Freiburg in Switzerland and at the Collegio Romano at Rome, and made his début in 1851 as a dramatic critic in the *Pays*, under the protection of Lamartine, whom he had already served as secretary. In 1855 he carried his pen to the *Presse*, later to *La Liberté*, and last to the *Moniteur Universel*. He quickly made himself famous by his knowledge and insight, and by a brilliant style, marred only by its affectedness and over-elaboration. Sense of colour, imagination, a quick eye for the picturesque in everything, and the sovereign gift of the artist—the intuition of individuality—made him a word-painter of the first rank, while his severity of taste and his sense of form saved him from extravagance. Yet his style is splendid, Oriental or at least Italian rather than French—even in his appearance he was a Venetian who had stepped out of his canvas. 'When I read Saint-Victor, I put on blue spectacles,' said Lamartine, and Victor Hugo wrote to him, after reading his review of the *Travailleurs de la Mer*, 'One would write a book merely to make you write a page.' His first book was *Hommes et Dieux* (1867), a series of historico-aesthetic studies on the Venus of Milo, Diana, Ceres,

Helen, Nero, Marcus Aurelius, Caesar Borgia, and Henry III. Later books were *Les Deux Masques, tragédie-comédie* (3 vols. 1879-83); *Anciens et Modernes* (1886); *Les Femmes de Goethe* (1869); *Victor Hugo* (1885); and *Barbares et Bandits*. Saint-Victor was reserved in temperament, and indeed, to speak truly, was something of a coxcomb. He lived an uneventful life, was for some years General Inspector of Fine Arts, and died at Paris, 9th July 1881. See the study by Alidor Delzant (1887), which reveals to us the strangely mechanical method in which he wrote. His first selected certain words, spread them about his page like colours on a palette, next grouped round them other euphonious terms, and lastly strung the whole together in a proposition.

St Vincent, one of the British islands in the West Indies, Windward Group, 105 miles W. of Barbadoes. Area, 132 sq. m.; pop. (1881) 40,548; (1891) 41,054, of whom over 3000 were whites and Hindu coolies, the rest being negroes and people of mixed blood. The island is traversed from north to south by a chain of volcanic mountains, which rise in the volcano called the Soufrière (a violent eruption in 1812) to 3000 feet. Many of the valleys are fertile, and the shores are rich and productive. Only one-seventh of the entire area is under cultivation. The climate is healthy. Sugar, rum, cocoa, spices, and arrowroot are the principal products. The exports fell from £124,587 in 1889 to £67,392 in 1896. The imports were £98,212 in 1889, and £71,490 in 1896. The chief town is Kingstown (pop. 4547), at the head of a bay on the south-west coast. The island is ruled by a governor and a nominated legislative council of eight members. St Vincent was discovered by Columbus in 1498, and was then inhabited by Caribs. These people were left in possession down to 1783, although Charles I. gave the island to the Earl of Carlisle in 1627. In 1797 the Caribs, rebelling with French aid, were transferred to the island of Rattan in the Bay of Honduras. St Vincent, with the other Windward Islands, suffered greatly from a hurricane of almost unparalleled violence in 1898. The home government voted a free grant to St Vincent of £25,000, with a loan of £50,000, to relieve the sufferers, who also shared in the fund of £43,000 raised by the Lord Mayor of London.

St Vincent, CAPE, a promontory forming the south-western corner of Portugal, off which several important naval battles have taken place. On June 16, 1693, Admiral Rooke was here attacked by a superior French fleet, and defeated with the loss of twelve men-of-war and eighty merchantmen which were sailing under his convoy; on January 16, 1780, Admiral Rodney destroyed here several Spanish ships of Langara's fleet; on February 14, 1797, the great battle of Cape St Vincent (see following article) resulted in the total defeat of the Spaniards and capture of some of their largest ships. This victory frustrated the formidable Spanish-French scheme of invading England. The fourth naval fight off Cape St Vincent took place between the fleet of Queen Maria of Portugal, commanded by Sir Charles Napier (q.v.), and that of Dom Miguel, in which a portion of the latter was destroyed and the rest captured, 5th July 1833.

St Vincent, EARL, Admiral. John Jervis was born at Meaford Hall, Staffordshire, January 9, 1735. Running away to sea as a boy, he rose to be a naval lieutenant in 1755, and so distinguished himself in the Quebec expedition in 1759 as to receive the rank of commander. As captain of the *Foudroyant* in 1778 he fought in the action off Brest, and in 1782 captured the *Pégase* of 74 guns, whereupon he was made K.C.B. In 1793 he commanded the

naval part of the successful expedition against the French West India Islands. In 1795, now a full admiral, he received the command of the Mediterranean fleet. On the 14th February 1797, with only fifteen sail of the line and seven frigates, he fell in, off Cape St Vincent, with the Spanish fleet of twenty-seven sail. Jervis determined to engage the enemy, and the battle of St Vincent was fought; but it should be remembered that the genius of Nelson contributed greatly to the success of the day (see NELSON, Vol. VII. p. 432). For this victory the king created Jervis Earl St Vincent, and parliament settled upon him a pension of £3000 a year. After having, by great firmness, repressed a mutiny off Cadiz, which threatened the loss of the whole fleet, he was compelled by ill-health to return home. He was soon applied to by government to subdue the spirit of sedition which had openly manifested itself in the Channel fleet; and his endeavours were eminently successful. He held the appointment of First Lord of the Admiralty for the three years 1801-4, and reformed innumerable crying abuses; and having for a second time commanded the Channel fleet, he retired into private life, and died 13th March 1823. He was buried in St Paul's Cathedral.

See his *Life and Correspondence*, by Captain E. P. Brenton (2 vols. 1838); the *Memoirs of the Earl of St Vincent*, by J. S. Tucker (2 vols. 1844); James's *Naval History* (new ed. 1878).

St Vitus' Dance. See CHOREA.

Sais, an ancient Egyptian city, called in the hieroglyphs *Sa*, was situated on the right bank of the Canopic branch of the Nile. It gave its name to two Egyptian dynasties, the 24th and 26th, founded by natives of the city. Sais was important as a religious capital, and had a famous temple of the goddess Neith and the tomb of Osiris. Towards the decline of the monarchy it rose to great splendour. The 26th dynasty transferred hither the capital of the kingdom. It was also a renowned seat of learning, and was frequently visited by the sages of Greece. The legend of the mysterious veiled statue in the temple at Sais (which formed the subject of Schiller's ballad and of Novalis' romance) is the issue of Greek invention.

Saith. See COAL-FISH.

Salvas is the name of one of the three great divisions of Hindu sects. See INDIA, Vol. VI. p. 106. The word designates the votaries of Siva, and comprises different special sects, which varied in number at different periods of mediæval Hinduism. See SIVA.

Sakai, a town of Japan, situated on the south-west of the island of Nippon, 7 miles S. of Osaka. Before the rise of this town Sakai was the chief commercial port of Japan; its trade is now absorbed in that of Osaka. Pop. 47,631.

Sakhalin. See SAGHALIEN.

Saki (*Pithecia*), a genus of long-tailed American monkeys of the family Cebidae. Some species (e.g. *P. hirsuta*) are covered with long hair, and are sometimes called Fur-tailed Monkeys. The Black Saki (*P. satanas*), from the Amazons, is the best-known species.

Saki, a kind of beer which the Japanese make from rice. It is the common alcoholic liquor of Japan. It is clear, and has a peculiar taste, which Europeans generally reckon unpleasant. The Japanese usually heat it before drinking, and pour it into flat cups or saucers of lacquered wood. It produces a very speedy and transient intoxication.

Sakkara, a village 10 miles S. of Cairo, near the ruins of Memphis (q.v.), and famous for its eleven pyramids. See PYRAMID.

Sáktas is the name of one of the great divisions of Hindu sects. See INDIA, Vol. VI. p. 106.

Sakuntala is one of the most pleasing female characters of Hindu mythology. She is mentioned as a water-nymph in the *Yagurveda* (see VEDA); she is the subject of a beautiful episode of the *Mahábhárata* (q. v.), and is spoken of in the *Puránas*; but her name has become especially familiar in Europe through the celebrated drama of Kálidása (q. v.), which, introduced to us by Sir William Jones in 1789, became the starting-point of Sanskrit philology in Europe.

Sákyamuni, or the 'Saint Sákyá,' is a name of the founder of the Buddhist religion; see BUDDHISM, Vol. II. p. 516.

Sál (*Shoren robusta*), a tree of Northern India, of which the wood—hard, dark brown, rather coarse grained, but very durable—is next in value to teak. It is carefully cherished by government.

Sala, GEORGE AUGUSTUS HENRY, journalist and novelist, and a man of much out-of-the-way learning, was born in London, the son of an Italian and an Englishwoman, in 1828, and, forsaking art for literature, became a contributor to *Household Words*, the *Welcome Guest*, *Temple Bar* (which he founded and edited), the *Illustrated London News* (to which he for many years contributed the 'Echoes of the Week'), and *Cornhill*. As special correspondent of the *Daily Telegraph* he was in the United States during the civil war, in France during the war of 1870-71, in Russia in 1876, and in Australia in 1885. *Twice Round the Clock* was published in 1859. Among his best-known novels are *The Baddington Peccage* (1860), *Captain Dangerous* (1863), *Quite Alone* (1864). *Wat Tyler*, M.P. is a burlesque; and among the popular books of travel are *A Journey due North* (1859), *Dutch Pictures* (1861), *A Trip to Barbary* (1865), *From Waterloo to the Peninsula* (1866), *Rome and Venice* (1869), *Under the Sun* (1872), *Paris Herself Again* (1881), *America Revisited* (1882), *A Journey due South* (1885), *Things I have Seen* (1894), and his autobiographical *Life and Adventures* (1895). His last book was on cookery. He died 8th December 1895 in embarrassed circumstances.

Salaam (*Selám*, Arab. = Heb. *Shalom*, 'peace'), the general term of salutation among the Mohammedans; 'Es-selámu aleikum' ('Peace be with you'), (addressed only to the faithful) being answered by 'With you be peace, and the mercy of God, and His blessings!'

Salad, the term given to a preparation of raw herbs for food. It derives its name from the fact that salt is one of the chief ingredients used in dressing a salad. The principal salad herbs are lettuce, endive, chicory, celery, mustard and cress, water-cress, onions, radishes, tomatoes, chervil, and a few savoury herbs used to give flavour. They are usually cut up, and mixed with salt, vinegar, oil, and other condiments, according to taste. Sugar is also frequently added. Cresses, seed-leaves of mustard, &c. are often eaten without any addition. Salad has always been a favourite food with civilised nations, and has varied very little in its composition. The great value of salads is in the fact that they are uncooked, and consequently contain a larger quantity of mineral matter, such as potash, soda, &c., than if boiled. Potato salad is made in Germany with potatoes that have been boiled. Salads are sometimes prepared with animal food, such as boiled lobsters, crabs, eggs, &c. For some kinds of salad tarragon vinegar is best. See MAYONNAISE.

Saládin, the name given by western writers to SALAH-ED-DIN YUSSUF IBN AYUB, the sultan of

Egypt and Syria, and the founder of the Ayubite dynasty in those countries. He lives in the works of historians as the Moslem hero of the third crusade and the beau-ideal of Moslem chivalry. He was born in 1137 at the castle of Tekrit, on the Tigris, of which his father Ayub, a Kurd, was governor under the Seljuks. Following the example of his father and uncle, he entered the service of Nur ed-Din (q. v.), emir of Syria, and accompanied his uncle Shirkoh in his expeditions to Egypt (1167-68) in command of Nur ed-Din's army. On the death of Shirkoh Saládin was made grand-vizier of the Fatimite calif, and in 1171 he overthrew that monarch and constituted himself sole sovereign of Egypt. The growing power of the young prince not only aroused the alarm of the Christians, but provoked the more dangerous jealousy of Nur ed-Din. But on Nur ed-Din's death (1174) Saládin proclaimed himself sultan of Egypt and Syria, and the title was confirmed to him by the calif of Bagdad. He next reduced Mesopotamia to his rule, and received the homage of the Seljuk princes of Asia Minor. The remaining years of his life were occupied in wars with the Christians and in the consolidation of his extensive dominions. On 4th July 1187 the Christian army suffered a terrible defeat near Tiberias, the king of Jerusalem, the two grand-masters, and many other warriors of high rank being taken captive; then Jerusalem was stormed (3d October), and almost every other fortified place on the Syrian coast (Acre, Saida, Beyrout, &c., though not Tyre) was taken by the victorious Saládin. The news of this great success being brought to western Europe aroused the religious enthusiasm of the Christians to its highest pitch, and a powerful army of crusaders, headed by the kings of France and England, speedily made their appearance on the scene of strife. They captured Acre in 1191, and Richard Cœur-de-Lion defeated Saládin, took Cæsarea and Jaffa, and finally obtained a treaty for three years (August 1192), by which the coast from Jaffa to Tyre was yielded to the Christians. In the following year Saládin died at Damascus on 3d March. Saládin was not a mere soldier; his wise administration left traces which endured for centuries, in the citadel of Cairo, and in sundry canals, dikes, and roads. His opponents frankly attribute to him the noble qualities of chivalry, invincible courage, inviolable fidelity to treaties, greatness of soul, piety, justice, and moderation. The chivalrous side of his character has been well caught by Scott in *The Talisman*. The Ayubite dynasty ruled over Syria till 1259, when it was dispossessed by the Perso-Mongols, and over Egypt till the rise of the first Mameluke kingdom in 1250. See Reinaud's *Notice sur la Vie de Saládin* (1874).

Salamanca, a city of Spain, stands on and between four low hills beside the river Tormes, 110 miles NW. of Madrid. From the middle of the 13th to the close of the 17th century it was the seat of one of the most celebrated universities in Europe. Founded in 1243, this great school won renown at first for the teaching of civil and canon law; later theology became an important faculty. In the 16th century there were here from 6000 to 8000 students, amongst them the members of an Irish College; at the present day there are not more than 400. The university buildings date chiefly from the 15th century, and are Gothic in style. In Salamanca's palmy days her population reached 50,000, and the university counted more than a score of colleges. The library, founded in 1254, contains 70,500 vols. and 870 MSS. The city is still surrounded with walls, pierced by ten gates, and preserves very much of its mediæval appearance, its houses, convents, and churches, its streets and squares having altered but little since the

university began to decline. The river is crossed by a bridge of twenty-seven arches, in part of Roman construction. The great square is the largest perhaps in Spain; it is surrounded by an arcade, and has on one side the municipal buildings. It was used for bull-fights, and can hold 20,000 spectators. The city possesses two cathedrals; the old cathedral, cruciform in shape, late Romanesque in style, and dating from the 12th century, is richly decorated with paintings and monuments; the new cathedral (1513-1734) is a florid Gothic pile, also richly decorated. Amongst the remaining noteworthy buildings are the Jesuit College (1614), Renaissance in style; the Old College, now the governor's palace; the convents of the Dominicans and the Augustinians, the churches of which are both elaborately ornamented. In the middle ages Salamanca was famous for its leather-work; at the present day it has not much industry, save a little manufacture of cloth, linen, leather, and pottery. Pop. (1886) 17,155. The town was captured by Hannibal in 222 B.C. The Moors were expelled from its walls in 1055. During the Peninsular war it was taken by the French (1812), who committed great destruction in one of its quarters, and in the vicinity Wellington defeated Marmont on 22d July 1812.—The *province*, which produces a good deal of wool, has an area of 4940 sq. m. and a pop (1887) of 314,424.

Salamander (*Salamandra*), a genus of tailed Amphibians, nearly related to the newts (Molge, &c.). The salamanders are born in the water, but in adult life mostly live on land. In early life they breathe by gills, but these disappear, the adults breathing entirely by lungs. They feed on worms, slugs, snails, insects, and other small animals. In habit they are somewhat sluggish, shy, and stupid. The Spotted Land Salamander (*S. maculosa*) is very common in Europe and in North Africa. It is six to eight inches in length, and is conspicuous with bright yellow patches on a blackish background. Its skin is very glandular, and is usually covered with a moist secretion. The Black Salamander (*S. atra*) lives on the Alps, and is viviparous. There are no British species. The four genera included in the family Salamandridæ—



The Spotted Salamander (*Salamandra maculosa*).

of which the salamander is type—are confined to the Old World. Though the salamanders are quite harmless, they have long had, and still retain, a popular reputation of extreme venomousness, and are therefore much dreaded. Strange fables have been current concerning them from remote ages, particularly concerning the icy cold (a reference perhaps to the moist secretion) which envelops their body, and enables them not only to endure fire without burning, but to extinguish fire. Pliny refers to this belief, but very dubiously (*Nat. Hist.* x. 86 and xxix. 23); and so recently as 1716 the *Philosophical Transactions* recorded how a salamander, being cast 'into the fire, thereupon swelled presently, and then vomited store of thick slimy matter, which did put out the neighbouring coals.' Cellini, it will be remembered, was beaten as a boy by his father to make him remember he had seen a salamander in the fire.

Salamis (now *Koluri*), an irregularly-shaped, mountainous island of Greece, off the coast of Attica, and forming with it the Bay of Eleusis. Close to the southern promontory lies the long narrow island of Psyttalia. Its area is about 35 sq. m., and it has a population of over 4500, the chief town being the port of Koluri, on the west coast, itself with more than 3500 inhabitants. In ancient times its two principal towns, Old and New Salamis, lay, the former on the south, the latter on the north-east coast. Salamis was an independent state till about 620 B.C., when it fell, first to Megara, next to Athens through the policy of Solon. Its name is ever memorable from the great naval battle between the Greeks and Persians, fought (480 B.C.) a few days after the battle of Thermopylæ, in the narrow strait between the east coast of Salamis and the west coast of Attica. The Greek fleet of 366 triremes was drawn up at the entrance of the bay forming the harbour of New Salamis, the Athenian contingent under Themistocles, the Corinthian under Adimantus, while the Spartan Eurybiades commanded the whole. Great dissensions prevailed among the Greek leaders, which would probably have led to a general break-up had not Themistocles by a stratagem induced Xerxes, king of the Persians, to bring up his fleet, and give immediate battle to the Greeks. Xerxes drew up his ships, numbering 1200 triremes and 3000 smaller vessels, during the night previous to the battle, opposite the Greek fleet, along the coast of Attica, almost completely blocking up both entrances to the straits; and confident of victory he took his seat on a throne erected on a lofty height on the Attic coast, almost opposite New Salamis. Both Greeks and Persians fought with great bravery, but the latter were entirely defeated, their unwieldy fleet losing all advantage of numbers in the narrow space. Both the order and incidents of the battle are obscure, but the issue is clear enough. The loss of the Greeks is said to have been 40, and that of the Persians 200 ships, exclusive of those which were captured.

Sal Ammoniac, known also as Chloride of Ammonium, and sometimes as Hydrochlorate of Ammonia, is used in medicine and in chemistry to a considerable extent. It is obtained from the ammoniacal liquor of the gas-works by adding hydrochloric acid and then subliming it in iron pots, or by adding sulphuric acid and then subliming the ammonium sulphate with sodium chloride in the same way; on a small scale it may be made by adding hydrochloric acid to solution of ammonia. It occurs in colourless, odourless, translucent fibrous masses, with an acrid saline taste, and soluble in water. It is used as an expectorant in chronic bronchitis and pneumonia, as a diuretic, diaphoretic, and alterative in rheumatism; and as an alterative in neuralgia; it is also given in catarrhal conditions of the gastro-intestinal tract and in various hepatic diseases. While being dissolved in water it greatly lowers the temperature, and hence in solution can be used as a refrigerant. The dose is 5 to 20 grains given in solution. In chemistry it is largely used as a test. See AMMONIA.

Salangane. See EDIBLE BIRDS'-NEST.

Salar Jung. See JUNG.

Salband, name given by miners to the band of altered rock or other material which often separates the contents of a mineral vein or lode from the rock-mass which the vein traverses. *Selvage* and *Flucan* are terms used in the same sense.

Saldanha Bay. See CAPE COLONY.

Saldanha Oliveira e Daun, JOÃO CARLOS, DUKE OF, Portuguese statesman and marshal, was

born on 17th November 1790, a grandson of the 'Great Marquis,' Pombal, and great-grandson of the Austrian Marshal Daun. He was educated at Lisbon and entered the army. When the French invaded Portugal he took the patriotic side, and fought with distinction at Busaco, San Sebastian, Nive, &c. From 1817 to 1822 he was in South America, and took a leading part in the struggle between Brazil and Montevideo, after the capture of which last town he was nominated viceroy of the province. When, however, Brazil declared herself independent of Portugal, Saldanha returned to Lisbon, and in 1825 was appointed governor of Oporto. A moderate constitutionalist, he took the part of Dom Pedro against Dom Miguel (see PORTUGAL), helping to defend Oporto in 1833, beating off repeated attacks upon Lisbon (for which he was created marshal), gaining the victories of Pernes and Almoester, taking Leiria and Santarem, and finally forcing Miguel to sign the convention of Evora Monte (26th May 1834) and leave Portugal. During 1836-46 the extreme democratic party were in power and Saldanha lived partly in exile, partly in retirement, partly employed on diplomatic and other public business abroad. Meanwhile Portugal was in a most unsettled and disorderly state. Saldanha returned home in 1846; and from that time down to 1856 was alternately at the head of the government (1847-49, 1851-56), being supported chiefly by England, and in armed opposition to his political opponents. During the reign of Pedro II. he held no great office of state, and under King Louis was kept abroad as ambassador at Rome and London, except that he was prime-minister for some months in 1870. He died in London, 28th November 1876. He had been created a duke in 1846. The highly eulogistic *Memoirs*, by Count da Carnota (Lond. 1880), must be read with caution.

Sale is an exchange of land or goods for money. *Sale of Land*.—The 3d section of the Statute of Frauds (29 Car. II. chap. 2) requires contracts for the sale of land to be in writing, signed by the party to be charged therewith. Such a contract, even when those conditions are not complied with, will be specifically enforced, when it has been part performed by the party seeking relief. Such part performance, according to the phrase, takes the case out of the statute. Certain conditions of sale are usually put forth on the part of the vendor, and under them the sale is conducted. The purchaser is supplied with an abstract of title going back for forty years. Then the deeds conveying the estate are prepared and signed, the money is handed over, and the purchase completed. Before this, however, the purchaser is entitled to the estate and the vendor to the purchase-money, but the vendor has a lien for the unpaid price. The Real Property Limitation Act, 1874, gives, in the absence of fraud, a person who has held real property undisturbed for twelve years an indefeasible title thereto. The method of sale is somewhat different according as the land is freehold, leasehold, or copyhold—i.e. forming part of a manor. In the last case the copyholder surrenders the land into the hands of his lord, who thereupon admits the alienee. If the property is in Middlesex, or Yorkshire, or Kingston-upon-Hull, the conveyance is registered, and instruments dealing with the same subjects rank according to date of registration. Recent acts give power to limited owners (as tenants for life, &c.) to sell the land they occupy; but they must act under the sanction of the court, and apply the purchase-money as directed. In Scotland no contract for the sale of land is binding without writing. There is no copyhold, and leasehold is rare. There is a very perfect system of registration.

Sale of Goods.—By the 17th section of the Statute of Frauds no contract for sale of goods of the price of £10 or upward is valid unless the buyer receive and accept part of the goods sold, or pay part of the price, or the agreement be reduced to writing and signed by the parties. The title of buyer is no better than that of a seller, so that, e.g., if you purchase a watch from a man not its owner, the true owner can make you deliver it up without compensation. But there are some exceptions: thus, an agent under the Factors Acts, who may sometimes give a buyer a better title than he has himself; also goods bought in market overt become the absolute property of the purchaser, with the undernoted exception. In London every shop on a week-day is a market overt; elsewhere, only a market held at a regular time and place. The sale of horses is regulated by certain special provisions, chiefly contained in a statute of Philip and Mary. Even if goods be sold in market overt, on the subsequent conviction of the thief the property will revert to the true owner. On sale the duty of the seller is to deliver the goods, but not to send or convey them. The buyer is bound to accept and pay for what he has ordered. *Caveat emptor*, by which words is meant that the buyer takes an article at his own risk, is the rule, but a good many exceptions are admitted. The seller has a lien on the goods as long as the purchase-money is unpaid, and in case of the buyer's insolvency he may stop them in transit. In Scotland the chief theoretical point of difference is that, whilst in England the completion of the contract of sale vests the property of the goods in the buyer, in Scotland he has only a right to demand their delivery; but owing to various statutory provisions the difference is not of much practical importance. Also, the contract may be entirely verbal, and the doctrine of sales in market overt is not recognised. Among many books on the subject of sale that of Benjamin (4th ed. 1888) is the most complete. See also BILL OF SALE, CONTRACT, WARRANTY.

In the United States the sale of land is simplified by registration, but the law is based on that of England. So also with the sale of goods; only the law as to market overt is not recognised in the States, nor is warranty of title carried so far as in England.

Sale, GEORGE, an eminent oriental scholar, was born in Kent about 1690, educated at the King's School, Canterbury, and bred to the law. He assisted in getting up the *Universal History*—together with Swinton, Shelvoeke, Campbell, George Psalmanazar, and A. Bower—for which he wrote the cosmogony and several portions of oriental history. He was also one of the authors of the *General Dictionary*; but he is best known by his unrivalled translation of the Koran, 'with explanatory notes taken from the most approved commentators, to which is prefixed a preliminary discourse' (1734). This translation, with its learned preliminary discourse, formed a new epoch in the study of Islam and its literature (see KORAN; and Wherry's *Comprehensive Commentary on the Qur'an, comprising Sale's Translation, 1882-86*). That his contemporaries fastened the charge of heresy upon one who spoke philosophically and humanely of other creeds is not to be wondered at. He died 14th November 1736. After his death a catalogue of his oriental MSS. was published, and they are now in the Bodleian Library, Oxford.

Sale, SIR ROBERT HENRY, British soldier, was born in 1782, the son of an officer in the army of the East India Company, and himself in 1795 joined the colours as ensign. He saw a great deal of fighting; he was present at the storming of Seringapatam (1799) and of Travancore (1809), assisted

at the capture of Mauritius (1810), and fought throughout the Burmese war of 1824-25. In this war he took part in the capture of Rangoon and in the storming of Bassein, and distinguished himself in the assault on the lines of Prome, where he was wounded. When war was declared against Afghanistan in 1838 'Fighting Bob,' as Sale was called, was given the command of the first brigade in the Bengal division of the invading army. He greatly distinguished himself at the assault and capture of Ghazni, being again wounded. In the autumn of 1840 he was despatched to punish certain hostile chiefs in Kohistan and to keep a close watch upon the restless movements of the usurper Dost Mohammed, who was looking for an opportunity to strike a blow at Kabul. When the evacuation of Afghanistan was decided upon Sale's was the first brigade to set off back to India; but it had to fight its way through all the passes—the Coord Kabul, Tezen, Jagdalak—that lie between Kabul and Jellalabad. In this last fortress he was closely invested from 12th November 1841 to 7th April 1842; but in numerous sorties, and even in a general engagement (Tezen), he defeated the forces of Akhbar Khan (son of Dost Mohammed). He was at length relieved by General Pollock, who commanded the army sent to punish the Afghans for their treacherous slaughter of General Elphinstone's force in the defiles, and with him took part in the recapture of Kabul and the events that followed it. Sale was killed, his thigh being shattered by grape-shot, at the battle of Mudki, fighting against the Sikhs, on 18th December 1845. See Gleig, *Sale's Brigade in Afghanistan* (1846). His wife, Lady Sale, who was captured by the Afghans during Elphinstone's retreat, and kept prisoner by them until the arrival of Pollock's army, wrote a *Journal of the Disasters in Afghanistan* (1843).

Salem, a town in the south of India, 120 miles by rail SW. of Madras, stands in a pretty position in a valley backed by hills, and is a clean though straggling place, with extensive cotton manufactures and much general trade. Pop. (1881) 50,867; (1891) 67,750.

Salem, (1) a city and port of entry of Massachusetts, on a peninsula in Massachusetts Bay, 16 miles by rail N. by E. of Boston. It has a good harbour, from which was formerly carried on a large trade with China, the East Indies, Africa, and South America; but now only a coast trade in ice and coal remains. Principal institutions of Salem are the East India Marine Society, its collections now united with those of the Peabody Academy of Science (which possesses a noble collection of Japanese pottery), the Essex Institute, and the Salem Athenæum, the last two housed in Plummer Hall. The manufactures include cottons, jute, leather, shoes, iron castings, lead pipes, &c. Salem was settled in 1626. In 1692 the great witchcraft delusion broke out, during which nineteen persons were hanged (including one clergyman) and one pressed to death. Nathaniel Hawthorne and Prescott the historian were born here. Pop. (1890) 30,801; (1900) 35,956.—(2) Capital of Salem county, New Jersey, on Salem Creek, 3½ miles from its entrance into the Delaware and 36 miles by rail SSW. of Camden. It has manufactures of glass, flour, oil-cloth, carriages, besides a foundry, planing-mills, and a number of fruit-canneries. It was founded in 1675. Pop. (1890) 5512.—(3) Capital of Oregon, on the east bank of the Willamette River (here crossed by a wagon-bridge), 52 miles by rail S. by W. of Portland and 720 N. of San Francisco. Settled in 1834 and incorporated in 1853, it became state capital in 1860. The streets are wide and regular.

Here are the state capitol, prison, and insane asylum, and schools for the blind and deaf and dumb, besides the Willamette University (Methodist Episcopal, 1851), and several manufactories. Pop. (1880) 2538; (1890) 4515.

Salemi, a town in the west of Sicily, 39 miles SW. of Palermo. Pop. 11,512.

Salep. See ORCHIDS, Vol. VII. p. 627.

Salerno (anc. *Salernum*), a city of Southern Italy, on the gulf of the same name, 33 miles by rail SE. of Naples, with a pop. of 22,328. A hill behind the town is crowned by an old Norman castle. The beautiful Gothic cathedral of St Matthew (whose bones were brought from Pæstum in 954) was erected by the Normans (1076-84), and has in front of it a quadrangle of porphyry and granite pillars and inside it monuments of Gregory VII. and Margaret of Durazzo. One of its doors is of bronze, Byzantine work. The city was celebrated in the middle ages for its university (founded in 1150, closed in 1817), but especially for its school of medicine (*Schola Salernitana*), which was long the first in Europe (see Vol. VII. p. 117). In the neighbourhood are the ruins of Pæstum (q.v.). There are a couple of small harbours. Cotton is spun. Originally a Roman colony (194 B.C.), Salerno figures little in history until after it was taken by Robert Guiscard, who made it his capital. But the removal of the Norman court to Palermo and the sack of the city by the Emperor Henry VI. struck serious blows at its prosperity, and a third came from the decay of the medical school in the 14th century.

The *Gulf of Salerno* is a nearly semicircular indentation, separated from the Bay of Naples by the promontory ending in Point Campanella. On its shores stand Amalfi and Salerno.

Sales, FRANCIS DE. See FRANCIS OF SALES.

Salette, LA, an Alpine village of France, dept. Isère, 28 miles SSE. of Grenoble. Here on 19th September 1846 the Virgin is alleged to have appeared to two peasant children; from that time the spot was visited annually by thousands of pilgrims. In 1852-61 a pilgrimage church was built, in the Romanesque style, at an elevation of 5920 feet. The alleged appearance of the Virgin was, however, discredited by Pope Leo XIII. in 1879. Pop. 607.

Saley, a group of islands lying off the south-west extremity of Celebes, in the East Indies, consists of the principal island (area, 170 sq. m.; pop. 20,000) and several small ones (their united area 130 sq. m. and pop. 10,000), and is governed by native chiefs who pay tribute to the Netherlands East India government. Principal exports, cotton, trepang, cocoa-nuts, tortoiseshell, salt, and tobacco. The people, of mixed Malay race, are professedly Mohammedans.

Salford. See MANCHESTER.

Salicin, $C_{13}H_{16}O_7$, is a crystalline glucoside obtained from the bark of the *Salix alba* and other species of *Salix* (Willows), and also from the bark of several species of *Populus* (Poplars). It occurs in small white crystals, without smell, but having a very bitter taste; is soluble in 28 parts of cold water, in 1 part of boiling water, and in 60 parts of rectified spirit. When treated with strong sulphuric acid it dissolves with a bright red colour; being a glucoside it is readily decomposed by suitable chemical agencies into glucose (grape-sugar) and saligenin. Saligenin can be easily oxidised to form salicylic acid. It is used to a considerable extent in medicine. Its action and uses when given internally are much the same as those of Salicylic Acid (q.v.), but it is less powerful, is not so depressant, and does not disturb digestion so much.

Being a bitter, it promotes appetite and digestion, and therefore has a certain amount of tonic effect. Its dose is 5 to 30 grains.

Salic Law, a collection of the popular laws of the Salic or Salian Franks (see FRANKS), purporting to have been committed to writing in the 5th century, while the people were yet heathens. There exists several Latin texts of this code, and considerable obscurity rests over its history. It relates principally to the compensation and punishment of crimes, and there is a chapter containing provisions regarding the succession to what are called Salic Lands, which seems to have been inserted at a later date. Although the Frankish law did not in general exclude females, the succession to these salic lands, whatever they were, was confined to males, probably from the importance of securing the military service of the chief proprietors. It was but a doubtful analogy that led the rule of succession to Salic lands to be extended to the succession to the French crown, and it seems to have been only in the 14th century that the exclusion of females from the throne became an established principle. The accession of Philip the Long was probably the first occasion on which it received public sanction, and the fact that Edward III. rested his claim on female succession doubtless led to that instance being regarded as an unquestionable precedent. See *Lex Salica, the Ten Texts with the Glosses*, edited by Hessels (1880).

Salicylic Acid, $C_7H_6O_3$, was originally obtained from Salicin (q.v.), but is now made on a large scale from carbolic acid, to which it is very closely allied chemically. It may also be obtained from oil of wintergreen or oil of sweet birch, which consist mainly of salicylate of methyl. It occurs in small white crystals, slightly soluble in cold water; it has no smell, but is very irritating to the nostrils, and causes sneezing; its taste is sweetish and acid. Salicylic acid is used externally as an antiseptic, and as an application in some skin diseases.

For internal use the SALICYLATE OF SODIUM is preferred, as it is much less irritating to the stomach. It occurs in small white crystals, has a sweetish taste, and is very soluble in water. It is used very largely in acute rheumatism, and controls this disease much more speedily and thoroughly than any other drug. It is of less value in chronic rheumatism. It is also employed as an antipyretic, and has been given with some advantage in gout and in diabetes. It is depressant to the heart, and if given in too large doses may induce marked disturbance of the central nervous system, characterised by buzzing in the ears, deafness, and disturbances of vision. More severe results have been noted, but they are very rare. The dose is 10 to 30 grains.

Salina, capital of Saline county, Kansas, on the Smoky Hill River, 186 miles by rail W. by S. of Kansas City. Salt and gypsum are obtained near by, and the city has flour-mills and grain-elevators. Pop. (1870) 918; (1890) 6149.

Salina Formation, name given in North America to one of the subdivisions of the Silurian system, which appears to be equivalent to the lower portion of the Ludlow rocks of the British series. See SILURIAN SYSTEM.

Saline is a term applied to a very popular effervescent powder used as a gentle aperient. It is sold under all kinds of fancy titles, but essentially consists of a mixture of bicarbonate of soda, sugar, and tartaric acid, with a minute trace of Epsom salts or chlorate of potash.

Saline Plants. Those plants which grow on or near the seashore, in the water of the sea or of salt lakes, or on the beds of dried-up lakes, and which

are therefore used to a supply of salt which is above the average in amount, and which therefore become to a certain extent modified in form and function, may if we choose be called saline plants, but the term is of no particular value. Few of them are strictly aquatic plants, except the marine Algae, or Seaweeds, which grow immersed in salt water, either always or in certain states of the tide, and derive their nourishment from it through their fronds, and not by roots from the rock to which they are attached. Grasswrack (q.v.), however, is an instance of a phanerogamous plant living entirely and always immersed in salt water. Other phanerogamous plants grow chiefly or only on the seashore and in salt marshes. Some of these, however, as the sea-kale, may be cultivated in gardens remote from the sea, but they succeed best when liberally supplied with salt. Asparagus is another well-known garden-plant which derives much benefit from similar treatment. Some of the Saltworts (q.v.) and other saline plants yield much soda when collected and burned, and the produce was at one time largely imported into Britain from Spain and other countries under the name of Barilla (q.v.). The dry steppes of Russia and Tartary, having in many places a strongly saline soil, are covered with a very peculiar vegetation. Among the ornaments of these steppes is *Halimodendron argenteum*, a shrub of the natural order Leguminosæ, often cultivated in gardens for its beautiful rose-coloured flowers and silvery gray leaves. Saline plants have their whole tissues impregnated with salt.

Salins (anc. *Salinæ*), a town of the French dept. of Jura, 22 miles S. by W. of Besançon, has valuable salt-springs, which supply baths for visitors and yield salt. Pop. 5252.

Salisbury (New Sarum) and **Old Sarum**. Old Sarum (*Sorbiodunum*) stood about a mile north of the present city of Salisbury. It now consists of a bare conical hill encircled with entrenchments, with a central mound—from Roman times a castle and a place of much importance. Here Canute died, and here William the Conqueror assembled the barons to renew their oath of fealty. In 1075 Bishop Herman removed the bishopric of the united sees of Ramsbury and Sherborne to Old Sarum, and began a cathedral, which was finished by his successor St Osmund, who established a chapter of secular canons and compiled the *Use of Sarum*, which was adopted throughout the greater part of England. The foundations of Old Sarum Cathedral are still to be traced in very dry seasons. It was in the form of a cross, 270 feet long by 70 feet wide, with a transept of 150 feet. Old Sarum returned two members to parliament until the passing of the Reform Bill, although at that time there had for many years been no inhabitants. Service was daily performed in a chapel until the Reformation, after which the place was entirely deserted. The desertion of Old Sarum and the foundation of Salisbury or New Sarum were due to the removal of the cathedral from the former place to the latter. The reasons for the change were the frequent disputes and collisions between the authorities of the castle and the cathedral, the exposed position of Old Sarum (the noise of the winds often drowning the voices of the officiating priests), and the want of water.

Salisbury or New Sarum is a cathedral city, the capital of Wiltshire, and a parliamentary and municipal borough. It stands in a valley near the confluence of the rivers Avon, Bourne, Wilty, and Nadder, 84 miles WSW. of London. The plan of the city is very regular, it having been laid out as a whole at its foundation in rectangular plots. Water originally ran through most of the streets,

but the streams were covered over after the visitation of the cholera in 1849. The removal from Old Sarum took place in 1220, when the foundations of the new cathedral (B.V.M.) were laid. The Lady Chapel was consecrated in 1225, and the whole building, after being rehallowed in 1258, finally dedicated in 1260. The cathedral consists of a nave of ten bays, choir, and Lady Chapel, with two aisles, and two transepts, each having a single aisle towards the east, the ground-plan being in the form of a double cross. The whole building is a perfect example of pure Early English style. The cloisters and the chapter-house were built about 1270, and the tower (Decorated) and the spire added about 1330. The spire is the highest in England (400 feet). It formed no part of the original design, and the effect of the addition became apparent in a dangerous settlement which took place within 100 years of its erection. Owing to this the spire leans $27\frac{1}{2}$ inches towards the south. The cathedral suffered from a disastrous 'restoration' at the hands of James Wyatt (1782-91), when two 15th-century chapels, built by Bishop Beauchamp and Lord Hungerford, and two porches were destroyed, much painted glass removed, the tombs rearranged, and a lofty campanile standing apart from the cathedral pulled down. Much of the damage then done has been repaired in the restoration begun in 1863 under Sir Gilbert Scott,

and continued under Mr Street and Sir Arthur Blomfield. There is a curious muniment-room over the vestry containing a copy of the Magna Charta of King John, said to be that handed to Longespée, Earl of Salisbury, who was one of his witnesses. The library, built about 1450, is over the east side of the cloisters, and contains about 5000 volumes and many valuable MSS. The outside measurements of the cathedral are: length 473 feet, width 111 feet; the height of the nave and choir inside is 81 feet. The cathedral stands apart from any other building in the midst of a beautiful Close of about half a square mile in extent, encircled by a wall, within which stand the Bishop's Palace, an irregular building begun by Bishop Richard Poore (circa 1220) and added to by many of his successors, the deanery and canons' houses, and many other picturesque buildings.

The parish churches are St Martin's, St Thomas of Canterbury, a handsome Perpendicular building of the 15th century, and St Edmund of Canterbury, formerly a collegiate church of secular canons.

The other most notable buildings are the council-house, where the assizes are held; the county hall; the infirmary; the 'Hall of John Hall' and Audley House, now the church-house of the diocese, two fine examples of 15th-century domestic architecture; the old George Inn (now a shop), where Pepys stayed; St Nicholas' Hospital; the market-house; the poultry-cross; and the Blackmore Museum, which contains one of the finest collections of prehistoric antiquities in England, the collection from America being probably unrivalled anywhere.

The market-place is spacious and planted with trees, and contains statues of the late Lord Herbert of Lea (Sidney Herbert) and Professor Fawcett, who was a native of the city. Here the Duke

of Buckingham was beheaded in 1483 when Salisbury was the headquarters of Richard III. There are many charities and almshouses, and an endowed school for the choristers of the cathedral. The city chiefly depends upon its agricultural trade, the former manufactures of cutlery and woollens



Salisbury Cathedral, from the north-east.

being extinct. Salisbury returns one member to parliament. Pop. (1851) 11,657; (1881) 14,792; (1891) 17,362.

John of Salisbury was the confidential adviser of Becket, and, sharing his exile, became (1176) bishop of Chartres. He wrote a *Life of Becket*, and a work, *Polycraticus*, in which he lashes the vices of the court. He died 1180.—Margaret, Countess of Salisbury, was the mother of Cardinal Pole (q.v.).—The most notable bishops of Old Sarum were St Osmund and Bishop Roger; of New Sarum, Hallam (whose death at the Council of Constance, 1417, is regarded by Dean Milman as fatal to many really effective reforms in the church), Cardinal Campeggio, Jewell, Seth Ward (a founder of the Royal Society), Burnet, Hoadley, Sherlock, Douglas, Burgess, Denison, Hamilton, and Moberly. Fox the martyrologist, Hooker, Fuller, Pearson, Isaac Barrow, Joseph Butler, and Liddon have been canons of the cathedral, where George Herbert was a frequent worshipper. Among distinguished natives and residents have been Massinger, William and Henry Lawes, Chiffinch (the chief agent in the intrigues of Charles II.), Harris the philologist, Chubb 'the Deist', and Henry Fawcett. Fielding resided at one time in the Close, and Joseph Addison was educated at the grammar-school.

See Hatcher's *History of Old and New Sarum*, Britton's *Salisbury Cathedral*, Price's *Salisbury Cathedral*, Dods-worth's *Salisbury Cathedral*, Jones's *Fasti Ecclesie Saris-buriensis*, Gleeson White's *Cathedral Church of Salisbury* (1897). For plan of Cathedral, see Vol. V. p. 318.

SALISBURY PLAIN is an undulating tract of chalky down affording splendid pasture for sheep, with rich and well-timbered valleys. The high-lying land is too poor to repay cultivation. Of its many ancient moands and barrows, the most notable is Stonehenge (q.v.). Salisbury Plain is one of the

few places in England where the ancient sport of hawking is still pursued.

Salisbury, MARQUIS OF. Robert Arthur Talbot Gascoyne-Cecil, third Marquis of Salisbury, was born at Hatfield House on the 13th of February 1830. The famous name Cecil is said to have been Sitsilt originally; a certain Robert Sitsilt, who served in the Welsh wars of Rufus' time, is believed by the family to have been its founder. It is more distinctly traceable to David Cyswell, of Stamford, who was sheriff of Northamptonshire in the reign of Henry VII. David's eldest son found a place at court as one of Henry VIII.'s pages, and after returning to private life became sheriff of Rutland. His dwelling was at Burghley, near Stamford (q.v.); and here his son was born (his eldest son) who served England and Elizabeth so wisely for forty years. This statesman, Lord Burghley (q.v.), had two sons, one by his first wife, a daughter of Sir John Cheke, the other by his marriage with a daughter of Sir Anthony Cooke. The eldest was made Earl of Exeter, and from him the present Marquis of Exeter descends. The younger son was the famous Robert Cecil, whose great services to James I., and to the state, were rewarded within two years by three steps in the peerage. In 1603 he became Lord Cecil of Essendine, in 1604 Viscount Cranborne, and in 1605 Earl of Salisbury. The marquis is directly descended from the first Earl of Salisbury, and inherits Hatfield (q.v.) from him. As Lord Robert Cecil he proceeded from Eton to Christ Church, Oxford, in 1847. Two years afterwards he took the B.A. degree with an honorary fourth-class in mathematics. He shared in the Union Society's debates, always as distinctly Conservative, and yet more distinctly as a churchman. He was treasurer of the Union Society in his time, and gave great satisfaction in that office. His Oxford life over, Lord Robert Cecil went forth on a round of travel, extending to Australasia. On his return he was elected a Fellow of All Souls College, Oxford, and very soon afterwards entered the House of Commons, at the age of twenty-three being returned for Stamford. His address to the electors declared him a Conservative, warmly attached to the Church of England, eager to associate religion with education, and anxious for social and sanitary improvements — for the good of the poor particularly. He took his seat in the House of Commons when that assembly met in February 1854; and his first speech therein (on university reform) was delivered in the April following. A year afterwards he made his first foreign-affairs speech — on the terms of peace that should be imposed on Russia (Crimean war). He came further into notice when, on a motion condemning the conduct of the Aberdeen administration as 'the first and chief cause of the calamities that befell' our soldiery in the Crimea, he seconded General Peel in moving 'the previous question.' He took a busy part in the domestic reforms of 1856.

In 1857 Lord Robert Cecil launched his first legislative proposal, which was that parliamentary electors should be enabled to record their votes by means of voting papers, filled in before a justice of the peace; a proposal of particular service at county and university elections. In 1858 he opposed the abolition of church-rates in a speech which further advanced him in the estimation of his party; and he again distinguished himself in supporting a motion of Mr Gladstone's backing up the plan of uniting Moldavia and Wallachia. The Conservatives were now in office, and their leaders resolved to take up the question of Parliamentary Reform. In 1859 Mr Disraeli introduced his Reform Bill of 'fancy franchises,' Lord Robert Cecil supporting it by arguments which he had set

forth in the 'Oxford Essays' for 1858. The bill upset the government. When, in the time of its successors, the paper-duties question threw the two Houses into conflict, and when Mr Gladstone paralysed the opposition of the House of Lords by including the abolition of the duties in one single Budget Bill, Lord Robert Cecil opposed the novel device with extraordinary vigour and acerbity. It was now seen that he had all the gifts that carry a man from the back seats of the House of Commons to the most honourable positions on 'the front bench.' From this time forth Lord Robert Cecil became a frequent speaker; facile on many subjects, studious of all that he dealt with, pugnacious, vigorous, often brilliant, and remarkable for a rather unfortunate kind of sarcasm. In debates on pauperism, on army organisation, on civil service reform, on finance he was heard to considerable effect in those years; but he never spoke more warmly, or with more obvious personal interest, than in defence of the church or when popular education was discussed. Foreign affairs engaged his attention hardly less, as was seen, for example, when the German attack on Denmark, and the conduct of Lord Palmerston's government in relation thereto, was brought before the House of Commons by Mr Disraeli.

The years 1865 and 1866 were important in the history of Lord Salisbury. On the 14th of June in the first-named year he became Viscount Cranborne and heir to the marquise by the death of his elder brother; in July of the following year he was admitted to the cabinet under Lord Derby's administration as Secretary of State for India. In 1865 parliament had been dissolved, and Lord Palmerston had been confirmed in office by the constituencies; but within three months afterwards (October 18) Palmerston was dead. Thereupon Mr Gladstone took the leadership of the House of Commons and virtually of the cabinet; the Reform question was revived, and a bill brought in of which Lord Cranborne was one of the most effective opponents. One of his speeches (on an amendment by Earl Grosvenor) is an epitome of some of the strongest objections of Conservatism to such an extension of the franchise as was soon afterwards carried by Mr Disraeli. Mr Gladstone's Reform Bill was defeated; and when on the resignation of the government Lord Derby took office, Lord Cranborne was made Secretary for India. It is asserted by many and denied by none that to this office Lord Cranborne brought good business habits and a remarkably prompt apprehension of detail. But he was not to hold it long. The Reform agitation continued, and Lord Derby and Mr Disraeli resolved upon one of those measures called 'dishing.' The first business of the new Tory government was to concoct a Reform Bill. Discontent with its provisions compelled Lord Cranborne, Lord Carnarvon, and General Peel to resign their offices. The bill was proceeded with when, quitting his place on the Treasury bench for a seat below the gangway, Lord Cranborne fought against the measure with extreme pertinacity and vigour; we should add, with honourable consistency. His unsparing invective on this occasion did not improve his relations with Mr Disraeli, which were never rooted in personal friendship at any time.

When, in the spring of 1868, Mr Gladstone moved for the disestablishment and disendowment of the Irish Church his strongest opponent was Lord Cranborne. The last speech he ever made in the House of Commons was addressed to this subject. On the 12th of April 1868 he became Marquis of Salisbury, and his first work in the House of Lords was still to defend the church. After speaking against anti-ritual legislation, he had again to deal with the disestablishment question.

This he did with his accustomed vigour, prophesying that the disestablishment of the Irish Church would have no such effect in dispelling Fenianism as Mr Gladstone anticipated. In 1868, the first year of Mr Gladstone's first administration, Lord Salisbury proposed to abolish the rule whereby bills are dropped when both Houses have not time to pass them in the same session; this proposal fell through. He supported Earl Russell's Life Peers Bill (1868), which was rejected. Next year he was elected Chancellor of the University of Oxford. Meanwhile disaffection and outrage in Ireland went on, and when in 1870 the government framed a strong Peace Preservation Bill, Lord Salisbury (who was now recognised as the leading Conservative in the House of Lords) supported it in a sub-sarcastic speech, the graver argument of which was conveyed in the following sentence: 'In this country you have long been content only to guide; in Ireland it is essential that you should govern.' The Irish Land Act of 1870 was less to his taste, but it passed without violent opposition. In the following year Mr Gladstone's action in abolishing the army purchase-system by royal warrant, when legislation for that purpose appeared difficult and tedious, called Lord Salisbury to the front. The bill for abolishing religious tests in the universities gave him more arduous employment in criticism and amendment, chiefly addressed to the maintenance of religious instruction.

An important speech made at the time of the Franco-German war, recalling the obligations of Great Britain to maintain the independence of (exactly) half-a-dozen states, enhanced Lord Salisbury's reputation as a student of foreign affairs. As to home affairs this period of his career may be epitomised in the remark that he took an active part in expounding the errors of the government, which were gradually preparing for the defeat inflicted on it with the rejection of the Irish University Bill. Resignation ensued (March 1873); the Conservatives declined office; in January 1874 parliament was dissolved, and the Conservatives came in with a great majority.

Whether Lord Salisbury would consent to serve with Mr Disraeli, whether Mr Disraeli would invite Lord Salisbury to join him, now became a question of the day. There was no love between them; but the one wished for a footing in the cabinet, and the other felt that his omission would be a danger; and so Lord Salisbury became Secretary for India a second time. It must suffice to say that in this post he gave unflinching proof of great administrative ability. Before the end of the year Lord Salisbury had again come into collision with his chief. He hotly opposed the Public Worship Regulation Act (a government measure); and Mr Disraeli replied to him very tartly in a speech remembered by the words, 'He is not a man who measures his phrases; he is a great master of gibes, and flouts, and jeers.' But the rupture which neither man could afford was avoided. Lord Salisbury now took a very active interest in university reform, but he was soon called to more bustling employments. The Eastern Question was reopened; Turkey was at war with Servia and Montenegro; the Bulgarian atrocities were made known; and to stay the mischief a conference of the European Powers was held at Constantinople. Lord Salisbury was chosen as envoy from Great Britain, and the choice was presently repented of in Downing Street. His conduct at Constantinople surprised not only the uninformed public, but his colleagues. Indeed he did not scruple to act against the whole spirit of his instructions, nor did he heed the remonstrances sent out to him from the Foreign Office. Thus did he come into direct collision with Lord Derby

(then Foreign Secretary). But once placed in the position of envoy Lord Salisbury was practically beyond control: to recall him was of course impossible. Later, when the Turks were beaten down, and the treaty of San Stefano became known, there was so much disagreement in Lord Beaconsfield's cabinet that his own policies (wise or unwise) were paralysed. When Lord Derby's secession followed Lord Carnarvon's, Lord Salisbury became Foreign Secretary. Without the loss of a day he signalled the change by publishing a circular despatch so powerfully assertive of the British objections to the San Stefano Treaty that it electrified the public mind; but its glory was sadly dimmed when a famous secret agreement with Russia crept into the newspapers a little while afterwards. Russia being compelled (mainly by the resistance of the British government) to submit her peace treaty with Turkey to a congress of European Powers (held at Berlin), Lord Beaconsfield resolved to act for Great Britain himself, Lord Salisbury accompanying him to the German capital. This arrangement is not improbably explained by Lord Salisbury's too wilful conduct as envoy at Constantinople. The government had a troublous time in Afghanistan and South Africa after these events, Lord Salisbury taking an energetic part in repelling the opposition attacks that arose therefrom.

The 'Midlothian campaign,' in the winter of 1879, was followed by a dissolution of parliament in March of the following year, and that by a heavy defeat for the Conservatives. The worsening state of Ireland and the action and inaction of the Gladstone government in relation thereto, the abandonment of Kandahar, and the peace after Majuba Hill kept Lord Salisbury busy even before he succeeded to the leadership of the Conservative party on the death of Lord Beaconsfield. The Irish Land Act and its complete failure as a pacifying measure, the troubles with the Boers, the disturbances in Egypt, a new Reform Bill, the Redistribution of Seats Bill, the Soudan, Gordon's mission and his abandonment gave Lord Salisbury a busy time as opposition leader till the resignation of the government in June 1885. Lord Salisbury now became prime-minister and Secretary of State for Foreign Affairs. Mr Gladstone soon returned to power, was wrecked in 1886 by his Home Rule Bill, and after a general election in that year Lord Salisbury again took office, the government being now known as Unionist. The ministry resigned soon after the (unfavourable) general election of 1892; and the main work of the Unionist party was successful opposition to the Home Rule Bill of 1893. Lord Salisbury's third administration, formed in 1895 on the resignation of Lord Rosebery, included the Duke of Devonshire and Mr Chamberlain. It has had to deal with embarrassing situations in Armenia and Crete, in South Africa, in Venezuela, and in China. The conduct of British interests in China in the face of Russian encroachments provoked much criticism, some of it unreasonable. The reconquest of the Soudan in 1898 was emphasised by the withdrawal of the French expedition from Fashoda and the Upper Nile, after a period of very strained relations between France and Britain, and the display of not a little 'firmness' by Lord Salisbury. The fleet has been greatly strengthened; an amicable understanding with Germany has been arrived at; there has been an extraordinary growth of friendly feeling between Britain and the United States; and Ireland, more contented and prosperous than heretofore, began in 1899 to work its new system of local government.

President of the British Association in 1894, Lord Salisbury is by temperament a student; a man

of robust thought, of high and scornful intellect; a recluse, to be relieved of the torment of association with inferior minds. A masterly and most impressive orator, he yet neglects the art of persuasion; and in speeches of which every word seems to have been well weighed and carefully chosen some startlingly injudicious sentence almost invariably breaks loose. His will is commonly believed to be as firm and well-knit as his speech. It must always be remembered that the difficulties of his task as Foreign Secretary are enormous, though they would probably be much lighter had he gained what no minister of his known intellectual capacity ever lacked so much in this country—popular liking. Lord Salisbury was married in 1857 to Georgiana, daughter of Sir Edward Alderson (a Baron of the Exchequer), and has had issue five sons and three daughters.

See F. S. Pulling, *Life and Speeches of the Marquis of Salisbury* (2 vols. 1885); the short *Life* by Traill (1891); and the *Life and Times* by Jeyes (4 vols. 1894-95).

Saliva, one of the digestive fluids, mainly the product of the SALIVARY GLANDS, of which there are three pairs—the parotid, the submaxillary, and the sublingual, with efferent ducts which convey the glandular secretions into the mouth. These, when mixed with the mucus secreted by the follicles of the mucous membrane lining the mouth, constitute the ordinary or mixed saliva. The *Parotid Gland*, so called from the Greek

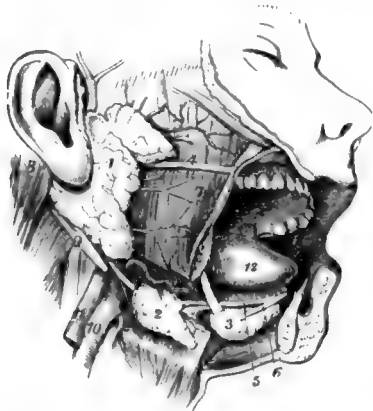

The Salivary Glands:

- 1, the parotid gland; 2, the submaxillary gland; 3, the sublingual gland; 4, Steno's duct; 5, Wharton's duct; 6, Bartholin's duct; 7, masseter muscle; 8, mastoid process; 9, digastric muscle; 10, internal jugular vein; 11, external carotid artery; 12, the tongue.

words *para*, 'near,' and *ous*, 'the ear,' is the largest of the three glands occurring on each side. It lies upon the side of the face immediately in front of the external ear, and weighs from half an ounce to an ounce. Its duct is about two inches and a half in length, and opens into the mouth by a small orifice opposite the second molar tooth of the upper jaw. The walls of the duct are dense and somewhat thick, and the calibre is about that of a crow-quill.

The *Submaxillary Gland* is situated, as its name implies, below the jawbone (part of which is cut away in the figure), and is placed at nearly equal distances from the parotid and sublingual glands. Its duct is about two inches in length, and opens by a narrow orifice on the top of a papilla, at the side of the *frænum* of the tongue. The *Sublingual Gland* is situated, as its name implies, under the tongue, each gland forming a ridge on the floor of the mouth, between the tongue and the lower gums.

It has a number of excretory ducts, which open separately into the mouth. The salivary glands are racemose, or of the compound acinous type (see GLANDS). The recesses which open into the fine terminal branches of the ducts are 'lined and almost filled' by the epithelial cells which secrete the saliva. True salivary glands exist in all mammals, except the cetacea, in birds, and reptiles (including amphibians), but not in fishes; and glands discharging a similar function occur in insects, many molluscs, &c. Saliva contains about one-half per cent. of solids, chiefly salts and mucin. The proportion of its active constituent, ptyalin, is extremely small; and it has never been satisfactorily isolated (see DIGESTION).

The most common disease of the parotid gland is a specific inflammation, which has been already described in the article MUMPS. Tumours of various kinds sometimes occur in front of the ear and over the parotid gland. Their removal is often difficult. Calculi are occasionally formed in connection with the ducts of the salivary glands. *Deficient Secretion* is indicated by clamminess or dryness of the mouth, and is common in low forms of fever. It is important as indicating the condition of the system, and seldom requires treatment. If it should occur as an original affection it must be treated by local Sialogogues (q.v.), such as liquorice, horse-radish, pellitory, &c. *Alteration of the Saliva* is not unfrequent in disease. For example, it sometimes loses its alkaline character, and becomes acid, as in acute rheumatism, diabetes, &c.; whilst in other cases it becomes so fetid as to be a source of annoyance both to the patient and his friends, as, for example, in scurvy, various forms of dyspepsia, salivation, &c. The undue acidity may be corrected by the administration of carbonate or bicarbonate of soda, while the fætor may be relieved by attention to diet, by antiseptic mouth-washes, and by the use, both local and general, of creasote, nitromuriatic acid, charcoal, chlorate of potash, &c. *Ordinary Inflammation* of these glands (distinct from mumps) may proceed from cold or local injury, but it is often produced by decayed teeth.

SALIVATION, or PTYALISM (from the Gr. *ptyalon*, 'the saliva'), is the term employed to designate an abnormally abundant flow of saliva. It most commonly arises from a specific form of inflammation of the parotid glands, induced by the action of mercury, in which case it is termed mercurial salivation; but it occasionally appears under the action of other drugs, especially iodide of potassium; and sometimes it occurs without any apparent cause, in which case it is said to be *idiopathic* or *spontaneous*. When mercury is given in such a way as to excite salivation a metallic taste in the mouth is soon recognised by the patient, and a remarkable but indescribable smell, known as the mercurial fætor, may be detected in his breath; the gums become swollen and spongy at their edges, and usually present a few slight ulcers; and an increased flow of saliva takes place, accompanied by pain in the teeth on pressure. If these symptoms be not checked (and *a fortiori* if more mercury be given) the tongue, cheeks, and throat swell and ulcerate, and the saliva that flows away amounts to several pints in the course of the day. Until a comparatively recent period profuse salivation was deemed the only certain indication that the system was duly under the influence of mercury (and, indeed, it was believed that the cause of the disease was carried out of the body with the saliva); but it is now recognised that salivation is harmful, and in administering mercury the object aimed at is not to allow its effect at farthest to go beyond the production of slight tenderness of the gums, and slight mercurial fætor. Mercurial salivation

is therefore very rarely to be seen at the present day. It is worthy of notice that in the confluent form of smallpox there is almost always more or less abundant salivation, which lasts for several days; and if it cease abruptly the peril is usually great. Moreover, there is a more or less marked tendency to salivation in scurvy, hysteria, hydrophobia, some forms of mania, and not unfrequently in pregnancy.

Salle, DE LA. See SCHOOLS (BROTHERS OF CHRISTIAN).

Sallee, SALÉ, or SLA, a seaport of Morocco, stands on the Atlantic, at the mouth of the Bu-Ragreb, on the northern side of the river, opposite to Rabat (q.v.). It was for centuries notorious as a haunt of pirates, and gave its name to the Sallee Rovers, who carried the terror of their name into the English Channel, and who are known to every reader of *Robinson Crusoe*. It is only within the 19th century that Britain ceased to pay an annual subsidy to the sultan of Morocco to secure safety from their attacks. The people, 10,000 in number, are still fanatical, and suffer no European to dwell within their walls. The streets are mean and poor, and the houses small. A wall surrounds the town, the chief features of which are forts and the prison. Excellent carpets are made, as well as shoes.

Sallow (*Salix*). See WILLOW.

Sallow-thorn. See SEA-BUCKTHORN.

Sallust. CAIUS SALLUSTIUS CRISPUS, a Roman historian, was born of plebeian family at Amiternum in the Sabine country, 86 B.C. He had risen to be tribune of the people in 52, when he helped to avenge the murder of Clodius upon Milo and his party. His own intrigue with Milo's wife may have given a spur to his love of justice, for his morality was far from high; indeed such was the scandal of his licentious life that he was expelled in 50 from the senate. It is true, however, that his attachment to Cæsar's party may well suggest a plausible reason for his expulsion. In 47, when Cæsar's fortune was in the ascendant, he was made prætor, and was consequently restored to his forfeited senatorial rank. Soon after this he nearly lost his life in Campania, in a mutiny of some of Cæsar's troops about to be shipped to Africa. Next year he carried off the enemy's stores from the island of Cercina, and at the close of the African campaign he was left as governor of the annexed kingdom of Numidia, formed into the province of Nova Africa. His administration was sullied by oppression and extortion, but the charges brought against him by the provincials failed before the partial tribunal of Cæsar. With the fruit of his extortion he laid out those famous gardens on the Quirinal which bore his name for centuries, and the splendid mansion in which became an imperial residence of Nerva, Vespasian, and Aurelian. Here he lived apart from public cares, devoted to literary labours, and here he died, 34 B.C. In this retirement he wrote his famous histories, the *Catilina*, or *Bellum Catilinarium*, a brief account of Catiline's conspiracy in 63, during the consulship of Cicero; the *Jugurtha*, or *Bellum Jugurthinum*, a history just twice as long of the five years' war between the Romans and Jugurtha, the king of Numidia; and the *Historiarum Libri Quinque*, commencing with the year of Sulla's death (78 B.C.) and coming down to 67 B.C., of which, unhappily, but a few fragments have come down to us. The two letters *Ad Cæsarem senem de Republica* and the *Invectiva Sallusti in Ciceronem* are not authentic.

As a historian Sallust is not accurate in details of fact and chronological sequence—a defect caused, no doubt, by his love for broad effects and unity of treatment. He was one of the first Roman

writers to treat a subject rather than a period of time, and to look directly for a model to Greek literature. He brought to his task strong prepossessions and a fatal readiness to sacrifice anything to his antithesis or epigram; but we need not suppose with Mommsen that his main object was to discredit the old regime and vindicate the memory of Cæsar. He loves to explore in philosophic fashion into the tone of the age and the hidden motives of men, and he falls a victim to his own subtlety and confidently presents his inferences as facts. The high morality which he inculcates harmonises but ill with the facts of his past life, although it may be it was a legitimate enough fruit of after reflection and repentance which supplied its characteristic tinge of pessimism to his tone. In his labour to be brief and concise like his great model Thucydides he is not seldom merely obscure and involved, and his historical style is overlaid too thickly with rhetorical ornament, the narrative overloaded with general reflections that are often little better than pretentious commonplaces. The speeches are dramatically effective though not authentic, the structure of the sentences simple, the repetition of favourite words and rapid changes of construction to secure vivacity being characteristic marks. The Grecisms are mostly close echoes of Thucydides, and even his favourite arrangement of short contrasted phrases is imitated from the same master. Moreover, he makes use of many words and phrases in an archaic sense, and is supposed especially to have drawn much from the elder Cato; while in other ancient critics, again, we read of the innovations of his style. The influence of Sallust is plainly marked on the greater Tacitus, who styles him (*Ann.* iii. 30) 'rerum Romanarum florentissimus auctor.' Martial also places him first in Roman history, and Quintilian does not fear to match him with Thucydides and sets him above Livy, although admitting that the latter is a safer model for boys. His diction and rhetorical colour found him many imitators from the time of Fronto down to the Christian writers of the 5th century.

Editions are by Gerlach (Basel, 1832), Kritz (3 vols. 1828, 1856), R. Dietach (2 vols. 1859, 1864), and H. Jordan (new ed. 1887). Excellent annotated editions of the two complete works are those by C. Merivale (1852), G. Long (1860; new ed. by J. G. Frazer, 1890), and W. W. Capes (1884); and there is a good translation by A. W. Pollard (1882). See L. Constans, *De Sermone Sallustiano* (Paris, 1880), the special Wörterbuch by O. Eichert (Han. 1864; 3d ed. 1885), and Mollweide, *Glossce Sall.* (Strasb. 1887); also the studies by Th. Vogel (Mayence, 1857), M. Jaeger (Salzb. 1879, 1884), and Th. Rambeau (Burg, 1879).

Sally-port, a gate or passage by which the garrison of a fortress may make a sally or sudden attack on the besiegers.

Salmagundi, a word of uncertain origin, unless it be derived from the Countess Salmagondi, lady of honour to Marie de' Medici and the inventor of the dish; for salmagundi is a dish of minced meat, seasoned with pickled cabbage, eggs, anchovies, olive-oil, vinegar, pepper, and similar ingredients. In an applied sense the word means a pot-pourri, a medley, a miscellany.

Salmasius, CLAUDIUS, the Latinised name of a celebrated French scholar, CLAUDE DE SAUMAISE, who was born at Semur in Burgundy, 15th April 1588. His father, Benigne de Saumaise, a man of superior erudition, was his first teacher. At the age of ten young Salmasius translated Pindar and composed Greek and Latin verses. He studied philosophy at Paris, under the superintendence of Casaubon. From Paris he proceeded to Heidelberg (1606), where he devoted himself to the science of jurisprudence, and publicly professed Protestantism, to which form of the Chris-

tian religion he had been secretly attached. So insatiable at this time was his thirst for knowledge—book-knowledge, at least—that he was wont to devote two whole nights out of three to hard reading, in consequence of which he brought himself to within an inch of the grave. In 1608 he published from MSS. two treatises of the sectary, Nilus, Archbishop of Thessalonica, and a work of the monk Barlaam on the primacy of the pope. In 1629 appeared his chief work, *Plinianæ Exercitationes in Casi Julii Solimi Polyhistora* (2 vols. Paris, 1629); after the publication of which he set himself vigorously, and without the help of a master, to acquire a knowledge of Hebrew, Arabic, Coptic, and other oriental tongues. In 1631 he was called to Leyden, to occupy the chair that Joseph Scaliger had held there, and it is from this period that his European reputation as a scholar and critic dates. Various efforts were made (1635-40) to induce Salmasius to return to France, but he declined them on the ground that his spirit was too 'liberal' for his native land. Queen Christina of Sweden, however, managed to bring him to Stockholm, and fix him there for a year (1650-51), after which he returned to Holland. He died of a fever caught by imprudently drinking the waters at Spa, 6th September 1658.

In the scholastic world Salmasius was probably the most famous personage of his day in Europe. 'A man not in my opinion only, but by the common consent of scholars, the most learned of all who are now living;' 'the miracle of the world, the most learned of mortals.' Such were the expressions of his contemporaries regarding him. The most exalted personages courted his friendship. Christina of Sweden declared that 'she could not live without him.' When Mazarin failed to induce him to return to France he nevertheless sent him the order of knighthood, as a proof of Louis XIV.'s desire to honour him as a Frenchman. Though his attainments were prodigious, Salmasius does not rank with scholars like Casaubon or the younger Scaliger. He had neither Casaubon's balanced judgment nor Scaliger's grasp or insight. Hence, though his industry and learning could not have been inferior to theirs, his work has no distinctive value in the history of scholarship. In England Salmasius is best known in connection with his controversy with Milton regarding the execution of Charles I. At the request of Charles II., Salmasius, as the highest scholastic authority in Europe, published (1649) his *Defensio Regia pro Carolo I.*, which was answered in 1651 by Milton in his *Pro Populo Anglicano Defensio*. The preparation of his pamphlet cost Milton his eyesight, but, as Salmasius died shortly after writing a rejoinder, the English poet boasted that his adversary had the worst of the encounter. The brutal coarseness of both disputants alone gives a certain significance to their controversy at the present day. Yet it must be remembered that the standard of taste in public controversy in the 16th and 17th centuries only corresponded to the license of everyday talk in the most refined society.

For the life of Salmasius, see *De Laudibus et Vita Cl. Salmasii*, prefixed to the collection of his letters published at Leyden in 1656. For his controversy with Milton, see Masson, *Life of Milton*, vol. iv.

Salmon (*Salmo*), a genus of fishes of the family Salmonidæ (q.v.), which, as characterised by Cuvier, has teeth on the vomer, both palatine bones, and all the maxillary bones; and includes numerous species more recently divided by Valenciennes into three genera, *Salmo*, *Fario*, and *Salar*: the first characterised by a few teeth at the end of the vomer; the second by a single line of teeth running down the vomer; the third by two rows of teeth on the vomer, without any remarkable group

at its upper end. To many naturalists, however, this division seems too artificial; and the characters, although excellent for distinguishing species, not such as ought to divide genera; an opinion confirmed by the fact that the teeth are numerous along the vomer in the young of the species (as the Common Salmon) which finally retain only a group of them at the end. The division made by Valenciennes separates the Salmon, the Salmon-trout, and the Gray or Bull Trout, the only British species which ascend rivers from the sea, into the two genera *Salmo* and *Fario*. A much more natural division, having regard to characters really conspicuous and important, and to the habits of the species, is the simple one of Pennell, which is really nothing more than a formal recognition of groups practically recognised by every one acquainted with the fishes that compose them: '(1) The Silver, or Migratory species (i.e. those migrating to and from the sea); (2) the Yellow, or Non-migratory species; (3) the Charrs, or Orange and Red-coloured species.' The present article is devoted to the first of these groups. The second is noticed in the article TROUT; the third, in the article CHARR.

By far the most important of the Salmonidæ which ascend the rivers of Britain from the sea is the Salmon (*Salmo salar*), in commercial importance far superior to any other fresh-water fish, both on account of the abundance in which it is procured in the northern parts of the world and of its rich and delicious flavour. From ancient times it has furnished important supplies of food; and the salmon-fisheries of Britain have long been a subject of anxious attention to the legislature. Even the rivers of Iceland now yield a rent, and are regularly netted for the supply of the British market, to which the salmon are brought, as from other



Fig. 1.—Salmon (*Salmo salar*).

northern regions, fresh, in ice. Many rivers and streams, also, are rendered valuable by the salmon which periodically visit them, as affording sport to anglers; and those of Norway, as well as those of Britain itself, are now frequented by British anglers.

The salmon is one of the largest species of the genus, having been known to attain the weight of 80 lb., whilst salmon of 40 or 50 lb., and even upwards, are occasionally brought to market. Very large salmon, however, are not common, owing to the eagerness with which the fishery is prosecuted. No fish is more symmetrical or beautiful than the salmon; and its form is admirably adapted to rapid motion even against powerful currents. The head

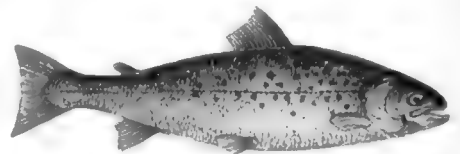
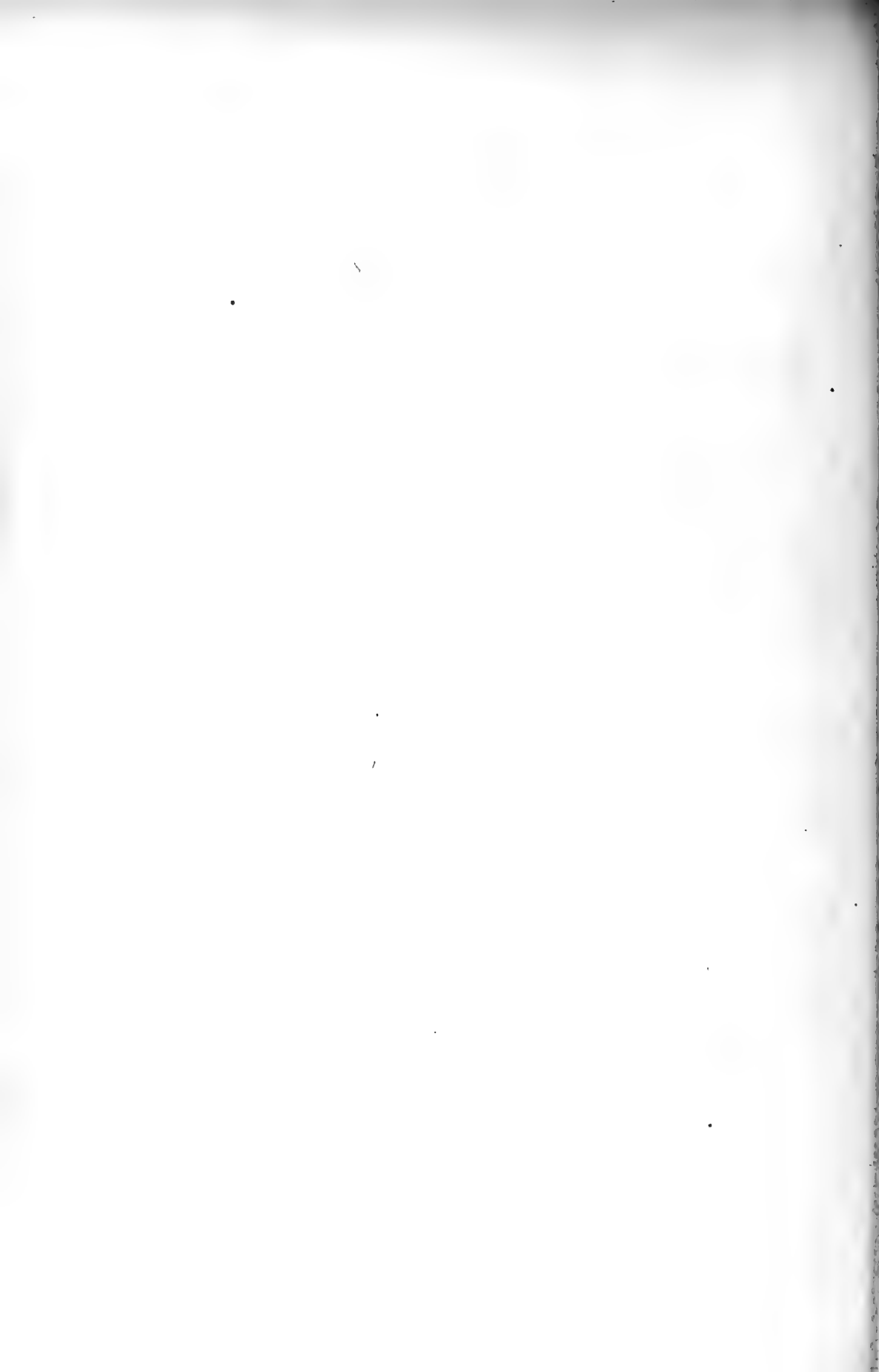

Fig. 2.—Salmon-trout (*Salmo trutta*).

is about one-fifth of the whole length of the fish. The under jaw of the male becomes hooked during the breeding season with a kind of cartilaginous excrescence, which is used as a weapon in the combats

SIWASH INDIANS CURING SALMON, FRASER RIVER, B. C.





then frequent, wounds so severe being inflicted with it that death sometimes ensues. The lateral line is nearly straight. The scales are small, and the colour a rich bluish or greenish gray above, changing to silvery-white beneath, sprinkled above the lateral line with rather large black spots. The opercular bones show a rounded outline at the hinder edge of the gill-covers, which at once distinguishes this species from the only other British species that can be confounded with it, the Salmon-trout and the Gray or Bull Trout, in both of which the posterior edge of the gill-cover is angular. The



Fig. 3.—Gray or Bull Trout (*Salmo eriox*).

tail is forked in the young salmon, but becomes nearly square in the adult. The mouth of the salmon is well furnished with teeth—a line of teeth on each side of the upper jaw, an inner line on the palatine bone, two or three in the adult state at the end of the vomer, two rows on the tongue, and one row along the outer edge of each lower jawbone. This array of teeth indicates voracity, and the salmon seems to prey readily on almost any animal which it is capable of capturing, though it is a somewhat singular fact that the stomach when opened is rarely found to contain the remains of food of any kind. Two or three herrings of full size have, however, been found in its stomach; the sand-lance and other small fishes seem to constitute part of its food, and when in fresh water the minnow, trout-fry, or the fry of its own species, worms, flies, &c., though there can be little doubt that the salmon feeds chiefly in the sea. Some hold that it does not feed in the fresh water. The angler catches salmon with the artificial fly, or with the minnow or the worm or the prawn; and no bait is more deadly than the roe of the salmon itself, the use of which is indeed prohibited in British acts of parliament intended for the protection of the salmon-fisheries. The eggs of crustaceans have also been found in the stomach of the salmon in such quantities as to show that they form a very considerable part of its food.

The salmon is found on the coasts of all the northern parts of the Atlantic, and in the rivers which fall into that ocean, as far south, at least, as the Loire on the European side and the Hudson on the American. Slight differences can be noted between the salmon on the Atlantic coasts of America and the European salmon, but they are not generally thought sufficient to distinguish them as species. The salmon frequenting one river are, indeed, often characteristically different from those of another river of the same vicinity. The Pacific Salmon (see p. 116) differs in several respects from the *Salmo salar*, particularly in its power of standing a higher temperature; so that the French government have recently made the experiment of introducing it into some of the rivers falling into the Mediterranean. Salmon is in perfection for the table only when recently taken from the water; whilst the fatty 'curd' remains between the flakes of its flesh, which, however, begins to disappear within twelve hours, although otherwise the fish is quite fresh.

The salmon, after its first migration to the sea, passes a great part of its life in it, although under the necessity of periodically ascending rivers, in which the salmon that ascend to spawn or for other

causes in autumn often remain during most of the winter. Salmon return, in preference, to the same rivers in which they have passed the earliest part of their existence; as appears both from records of marked salmon, and from the characteristic differences already alluded to. Salmon ascend rivers to a great distance from the sea, as the Rhine to the Falls of Schaffhausen, the Elbe to Bohemia, and the Yukon, the great Alaskan river, which they ascend for more than 1500 miles. Salmon move chiefly during the night. As a rule they do not run when rivers are low, but when they are beginning to fall and clear after a flood. In autumn, however, the sexual instinct urges them to ascend to the heads of rivers where there is good spawning-ground and to the smallest tributaries. The perpendicular height which the salmon can pass

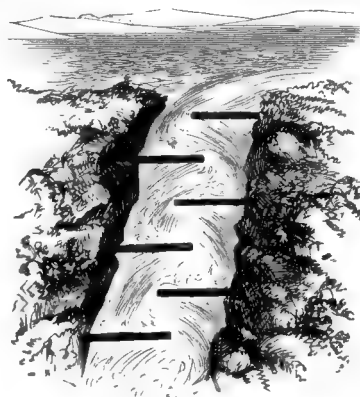

Fig. 4.—Salmon-ladder.

over by leaping, when there is abundance of water in the river and sufficient depth in the pool below the fall, seems to be not more than 6 or, at the utmost, 8 feet; they attempt higher leaps, but often fall back exhausted, or fall on adjacent rocks, where they die or are captured. They do, however, rush up steep and broken rapids of much greater height. The ascent of many rivers by salmon has been stopped by high weirs and other obstructions; but means have been devised for preventing this by *fish-stairs* or *fish-ladders*, which are often very conveniently formed by partitioning off a portion of the fall, and intersecting it from alternate sides, two-thirds of its width, by transverse steps of wood or stone, so as partially to divide it into a succession of falls. The salmon soon find out the ladder, and leap up from one step to another. There are, however, very few good salmon-ladders on the numerous obstructions connected with mills and manufactories which have been erected on salmon-rivers. The best of these are the ladder at Deanston dam on the Teith, at Morphie dam on the North Esk, and at Bridge-mill dam on the Girvan.

But mill-dams without fish-passes, or with inefficient passes, are not the only causes which prevent the full utilisation of salmon-rivers. There are, besides, natural obstructions, in the shape of waterfalls, which at present bar 500 miles of rivers in Scotland and many thousand acres of lochs against the ascent of salmon. The principal of these waterfalls are the Falls of Tummel, which shut out salmon from 50 miles of rivers and 20,000 acres of lochs. They might easily be made passable at a moderate cost; but the proprietors of the falls refuse their consent to have them touched; and, as the law at present stands, nothing can be done without the consent of the proprietors of the

obstruction, even if they are offered most ample pecuniary compensation for loss of amenity or injury to a fine fishing pool below the falls. A pretty exhaustive account of all the natural obstructions, in the shape of waterfalls, on the salmon-rivers of Scotland will be found in the 6th Annual Report by the Inspector of Salmon-fisheries, pp. 30-58.

As the time of spawning approaches salmon undergo considerable changes of colour, besides the change of form already noticed in the snout of the male. The former brilliancy of the hues gives place to a general duskiness, approaching to blackness in the females, much tinged with red in the males; and the cheeks of the males become marked with orange stripes. Salmon in this state are 'foul fish,' being considered unfit for the table, and the killing of them is prohibited by British laws, notwithstanding which, however, multitudes are killed by poachers in some of the rivers, nor do those who eat them either fresh or 'kippered' (i.e. dried) seem to suffer from any unwholesomeness. Salmon which have completed their spawning continue for some time, at least in fresh water, very unfit for the table. Their capture is prohibited by British laws. They are called 'foul fish,' or more distinctively, 'spent fish,' or *Kelts*; the males are also called *Kippers*, *kip* being a name for the cartilaginous hook of the under jaw, whilst the females are known as *Shedders* or *Baggits*. When they remain for a considerable time in fresh water after spawning kelts recover very much, and increase in weight.

The time of spawning is from the end of autumn to the beginning of spring, or even the beginning of summer; differing considerably in different rivers, whilst in each river it is prolonged throughout months, the elder and stronger fish of the former year probably ascending to spawn first. The difference of season in different rivers is probably to be accounted for by the temperature of the water, as affected by latitude, and by the relations of the river to lakes, to low warm plains, and to snow-covered mountains.

Salmon spawn on beds of fine gravel, in shallow parts of rivers, such as are used for the same purpose by trout. Some beds of this kind, in salmon-frequented rivers, have been notable from time immemorial as favourite spawning-places; and large numbers of fish, both the salmon and its congeners, deposit their spawn in them every year. The spawning female approaches the bed, attended by at least one male fish, sometimes by more than one, in which case fierce combats ensue; she makes a furrow in the gravel with her tail, and deposits her spawn in it, on which the male afterwards pours the vivifying milt. It was formerly believed, but erroneously, that the furrow was in part made by the snout of the fish. The eggs, when deposited and vivified, are covered by the action



Fig. 5.

Old Male Fish, or Kipper, during the spawning season.

of the tail of the female; the male doing nothing but depositing his milt, and fighting with any other of his sex that may attempt to dispute his place. The time occupied by a female salmon in spawning is from three to twelve days. After spawning the salmon generally soon descends to the sea.

The descending *kelts* are very ravenous, and therefore a great annoyance to anglers who desire to take none but *clean* fish, and must return the *kelts* to the water.

The eggs deposited in the spawning beds are liable to be devoured by trouts and other fishes, and by insect larvae of many kinds; ducks and other waterfowl also search in the gravel for their food; and sometimes a flood changes the bed so much as either to sweep away the eggs or to overlay them with gravel to a depth where they are never hatched, or from which the young can never emerge. The number of eggs hatched in ordinary circumstances must be small in proportion to the number deposited, and by far the greater part of the fry perish before the time of descent to the sea.

In from thirty to sixty days after the deposition of the eggs in the spawning bed they begin to show signs of life, and the eyes appear as small

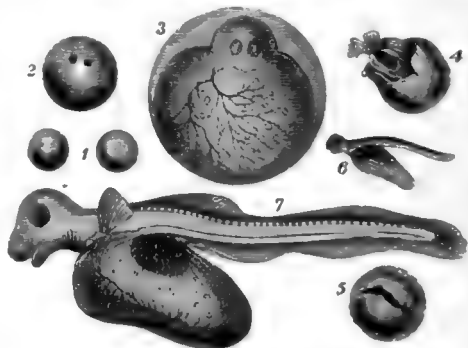

Fig. 6.—Salmon Ova, and newly-hatched Fish :

1, egg of salmon, natural size, just taken from the parent fish; 2, same with eyes of young fish just becoming apparent (80th-85th day); 3, young fish just ready to be hatched; 4, young fish emerging from the shell; 5, empty egg-shell; 6, young salmon about two days old, natural size; 7, same magnified, showing the umbilical vesicle.

specks. The time which elapses before the egg is hatched varies according to the temperature of the water, and therefore is generally shorter in England than in Scotland, 140 days being sometimes requisite in cold climates and late springs; but from 90 to 120 days is the usual term. A temperature above 70° F. is, however, fatal to the *Salmo salar*, though the Pacific salmon can stand a higher temperature. Salmon eggs are easily hatched in an aquarium in which proper care is taken to prevent stagnation of the water. Frank Buckland describes the methods in his *Fish-hatching* (1863).

The young fish lies coiled up in the egg, which it finally bursts in its struggles to be free, and it issues with a conical bag (umbilical vesicle) suspended under the belly, containing the red yolk of the egg and oil globules, which afford it nourishment during the first five or six weeks. The mouth is at first very imperfectly developed, as are the fins, and the whole body has a shape very different from what it is soon to assume, and is very delicate and almost transparent. The slightest injury is fatal. The length, at first, is about five-eighths of an inch. About the seventh or eighth week the young salmon has changed into a well-formed little fish about an inch long, with forked tail, the colour light brown, with nine or ten transverse dusky bars, which are also more or less distinctly visible in the young of other species of this genus, just as the young of many feline animals exhibit stripes or spots which disappear in their mature state. The fry, previously inactive, now begin to swim

about, and to seek food with great activity. They are known as *Parr*, or as *Samlet*, and also in some places by the names *Pink*, *Brandling*, and *Fingerling*. The Parr was formerly supposed to be a distinct species (*S. salmulus*), an opinion to which many anglers have clung tenaciously, even after it has been shown to the satisfaction of all naturalists—by Mr Shaw of Drumlanrig in 1834-36, confirmed by experiments at the salmon-breeding ponds at Stormontfield, near Perth, on the Tay—that the parr in reality is nothing else than the young salmon.

It was long urged that the male parr is very often found with the milt perfect; to which, however, it was replied that the female parr is almost never found with perfect roe. But it is now abundantly proved that the male parr is capable of impregnating the roe of the female salmon; and, indeed, ridiculous little parrs seem to be always ready at hand to perform this service during the combats of the great fish, or in their absence. Another remarkable fact has been discovered, that some parrs become smolts and descend to the sea in their first year, whilst others remain in the fresh water, and in the parr state, without much increase of size for another year, and a few even to the third year. A parr will die in the salt water. But when he assumes the silver mail of the smolt, his instinct imperatively urges him to seek the sea, where he thrives and grows apace—the smolt which has taken one, two, or three years to become six inches in length returning to the river, at the end of two months in the sea, as a grilse of several pounds weight. It has been proved in the United States that, though a considerable number of the smolts which descend to the sea return the same season to the river as grilse, a proportion of them do not return that season, but spend their grilsehood in the sea, returning the next season to the river as young spring salmon. This has not been proved with regard to the salmon of the United Kingdom. But many of the best authorities believe it to be the case. At Stormontfield it has been found that about one-half of the parrs migrate when a year old. No reason can be assigned for these things; the facts alone are known to us, and have but recently been established.

Grilse are captured in great numbers in the later part of summer and in autumn, but very few are seen in the earlier part of the fishing season. The grilse usually spawns on its first return to the fresh water—often remaining there for the winter, and on again descending to the sea assumes the perfect character of the mature salmon. Little increase of size ever takes place in fresh water; but the growth of the salmon in the sea is marvellously rapid, not only on its first migration, but afterwards. A kelt caught by the Duke of Athole on 31st March weighed exactly ten pounds. It was marked, and returned to the Tay, in the lower part of which it was again caught, after five weeks and two days, when it was found to weigh twenty pounds and a quarter.

The statistics of salmon-fisheries are very imperfect. It is impossible accurately to ascertain the total annual value of the salmon-fisheries even of Great Britain and Ireland. But if we take the most recent estimates of the English, Irish, and Scottish inspectors, we find the annual value of the English salmon-fisheries to be about £140,000 annually; of the Scotch, £300,000; and of the Irish, £500,000—or together £940,000 annually. That the salmon-fishery is very fluctuating and uncertain the following table of the boxes of Scotch salmon sent to Billingsgate Market from 1834-89, both years inclusive, will conclusively show:

Year.	Boxes of Scotch Salmon.	Year.	Boxes of Scotch Salmon.
1834	30,650	1862	22,796
1835	42,330	1863	24,297
1836	24,570	1864	22,608
1837	32,300	1865	19,009
1838	21,400	1866	21,725
1839	16,840	1867	23,006
1840	15,160	1868	23,020
1841	23,500	1869	20,474
1842	39,417	1870	20,648
1843	30,300	1871	23,390
1844	28,178	1872	24,404
1845	31,062	1873	30,181
1846	25,510	1874	32,180
1847	20,112	1875	20,375
1848	22,525	1876	34,055
1849	23,690	1877	23,189
1850	13,940	1878	26,465
1851	11,593	1879	13,929
1852	13,044	1880	17,457
1853	19,485	1881	23,905
1854	23,194	1882	22,968
1855	18,197	1883	35,506
1856	15,438	1884	27,219
1857	18,654	1885	30,362
1858	21,564	1886	23,407
1859	15,823	1887	26,907
1860	15,870	1888	22,857
1861	12,337	1889	21,101

During the first seven years in the above table the average number of boxes of Scotch salmon sent from Scotland to Billingsgate was 26,107; during the second septennial period, 29,011; during the third period, ending in 1854, 18,210; in 1855-61, 16,840; in 1862-68, 23,065; in 1869-75, 24,521; in 1876-82, 23,938; and during the last septennial period, 1883-89, 26,765 boxes. The best year in the table was 1835, and the worst was 1851. In 1895 the number of boxes sent was 25,364; no account being taken of single fish sent by rail, or of the large numbers of fish consumed in the district where they were caught.

The salmon-fisheries of the British rivers have in general much decreased in productiveness since the beginning of the 19th century. This is ascribed by many to the introduction of fixed or standing nets along the coast, by which salmon are taken in great numbers before they reach the mouths of the rivers to which they are proceeding, and in which alone they were formerly caught; it having been discovered that salmon feel their way, as it were, close along the shore for many miles towards the mouth of a river, feeding, meanwhile, on sand-lances, sand-hoppers, and other such prey. It is also partly owing to the destruction of spawning fish by poachers, and in no small measure to the pollution of rivers consequent on the increase of population and industry, and to the more thorough drainage of land, the result of which has been that rivers are for a comparatively small number of days in the year in that half-flooded condition in which salmon are most ready to ascend them. The last of these causes is the most irremediable; but the abatement of the others would of itself be sufficient to secure a productiveness of the rivers much greater than at present. The efforts which have begun to be made by breeding-ponds (see PISCICULTURE) to preserve eggs and fry from destruction, and so to multiply far beyond the natural amount the young salmon ready to descend to the sea, promise also such results as may yet probably make the supply of salmon far more abundant than it has ever been. There is reason to think that the productiveness of the waters may be increased as much as that of the land.

The stake-net is the most deadly of all means employed for taking salmon; and its use is prohibited in rivers and estuaries. It consists of two rows of net-covered stakes so placed between high and low water marks that salmon coming up to them, and proceeding along them, are conducted through narrow openings into what is called the

court of the net, from which they cannot find the way of escape. In deep water, where stake-nets cannot fish, another species of fixed engine termed a bag-net is employed, which is equally deadly in its operations; and sometimes stake and bag nets are combined in the same fixed engine, the stake-net occupying the foreshore, or space between high and low water mark, and the bag-net extending into the deep water beyond.

Cruives are the only fixed engines which can be legally used in rivers by those who have special titles to cruive-fishings. There is what is termed the cruive-box in the cruive dam or dike into which salmon are guided by a peculiar sort of grating called the *inscales*, and from which they cannot escape. In Scotland cruives are regulated by a bylaw forming part of the Salmon-fishery Acts of 1862 and 1868. In Ireland there must be what is termed a 'free gap' in every cruive-dike extending down to the bed of the river, the width of the gap being regulated by the width of the river.

In rivers only movable nets can be used for the capture of salmon. Of these, the most common and universal is that form of fishing known as *net and coble*. In this a small boat, or *salmon coble*, is used to carry out a seine-net from the shore, setting (*shooting*) it with a circular sweep, the concavity of which is towards the stream or tide, and men stationed on shore pull ropes so as to bring it in by both ends at once with whatever it may have enclosed. Coracles (q.v.) are used in salmon-fishing in the Severn and other Welsh rivers. Nets which a single man can carry and work are also used in many rivers and estuaries, as those called *halve-nets* on the Solway, which may be described as a bag attached to a pole.

Those rivers of Britain where the fishing is strictly preserved still afford good sport, the Aberdeenshire Dee having yielded 5000 salmon and grise to the rod in a single year; but many anglers betake themselves to Norway or even Canada for their favourite sport. Recently the salmon and other fish of the rivers of Britain have suffered terribly from the so-called *Salmon Disease* (see below). Much labour has been spent on the successful acclimatisation of salmon in New Zealand and Tasmania.

The SALMON-TROUT (*S. trutta*, or *Fario argentus*), also commonly called the Sea-trout, is rather thicker in proportion to its length than a salmon of the same size, and has the hinder free margin of the gill-cover less rounded. The jaws are nearly equal; the teeth strong, sharp, and curved, a single row running down the vomer, and pointing alternately in opposite directions. The colours are very similar to those of the salmon; the sides, chiefly above the lateral line, are marked with numerous X-shaped dusky spots, and there are several round dusky spots on the gill-covers. The salmon-trout does not attain so large a size as the salmon, but has been known to reach 24½ lb. The flesh is pink, richly flavoured, and much esteemed, although not equal to that of the salmon. Great quantities of salmon-trout are brought to market in London and other British towns; this fish being found from the south of England to the north of Scotland, in Orkney and Shetland, and in the Outer and Inner Hebrides. Its habits are generally similar to those of the salmon. Large shoals sometimes congregate near the mouth of a river which they are about to enter, and sometimes afford excellent sport to the angler in a bay or estuary, rising readily to the fly. The young are not easily to be distinguished from parr. *Finnocks*, *Herling*, and *Whitling* are local names of the salmon-trout on its first return from the sea to fresh water, when it has its most silvery appearance, in which state it has sometimes been described as a distinct species (*S. albus*).

The Gray Trout or Bull-trout (*S. eriox*), the only other migratory British species, is already noticed in the article BULL-TROUT. The gill-cover in this species is more elongated backwards at the lower angle than in the other two. On the banks of the Tweed and some other rivers it is often called the sea-trout, a name quite as appropriate to it as to the salmon-trout. The seasons at which the gray trout ascends rivers are partly the same with those of the salmon and salmon-trout, and partly different. The laws relative to the fishing of salmon apply equally to the bull-trout.

The most conspicuous addition which has recently been made to the salmon-producing countries of the world is the vast territory of Alaska in north-western America. When it was bought from Russia its chief commercial importance arose from the value of the furs which it produced. Now, since the American occupation, the value of the salmon-fisheries is far greater than that of the furs—the former yielding 3 millions of dollars annually, and the latter only 1 million. And, as yet, this great salmon industry is but partially and imperfectly developed, for Mr Bean, ichthyologist to the United States Fish Commission, assures us that it is capable, under judicious management, of being doubled in value. The largest and finest of the Alaskan salmon is the King or Chowichee Salmon, also known as Takou, Chinnook, Quinnot, and Columbia River Salmon (*S. quinnot*); in the American reports, *Oncorhynchus chowicha*. This valuable fish is found in the larger rivers as a rule, but runs also into some of the smaller streams. The Yukon and the Nushagak are the principal king salmon rivers. The average weight of this salmon is about 20 lb., and individuals weighing upwards of 100 lb. are on record. The flesh of the king salmon is superior in flavour to that of all the other species of Alaskan salmon. The king salmon is a great traveller, ascending the Yukon more than 1500 miles from its mouth, travelling at the rate of from 20 to 40 miles a day. Another Alaskan salmon is the Dog Salmon (*O. keta*), so called from the size of the teeth and the way in which the jaws become enlarged and distorted during the breeding season; it is the most important species to the natives, but is not used by the Americans. The Humpback Salmon (*O. gorbuscha*), so called because of the enormous hump developed on the back of the male during the breeding season, is the most abundant salmon of Alaska, and comes in enormous shoals, so that when they enter a stream in force they fill the water from shore to shore, and from top to bottom. It is the smallest of the Pacific salmon, ranging from 5 to 10 lb. The next most abundant salmon, and commercially the most important, is the Red Salmon (*O. nerka*), averaging from 7 to 15 lb. In 1889 there were thirty-six canneries in operation in Alaska, situated principally in the southern part of the territory. Nearly one-third were established on the Kadiak group of islands, and covered about one-half of the Alaskan catch. Sixty-six large vessels were engaged in carrying the equipment and workmen for these canneries and the product of their industry. Hundreds of boats are employed in the business of fishing, which is principally carried on by huge seine-nets. The seining is done chiefly by white men, and the work inside the canneries by Chinese. It is estimated that 4000 men are engaged in the salmon-fishing. In 1889 the capital invested was nearly 4 millions of dollars, and the value of the pack, at an average price of 5 dollars per case, was 3 millions of dollars. Eight millions and a half of salmon were captured, or about one-half of the whole yield of salmon in the United States. The

Schoodic or Landlocked Salmon of the United States, found in lakes, is a variety of *S. salar*; the California Salmon (*S. quinnat*) and the Rainbow Trout (*S. irideus*) are also mentioned in the article PISCICULTURE.

SALMON DISEASE.—This disease is caused by a fungus always present in running water, called *Saprolegnia ferax*, which assumes fatal activity in certain years and in certain rivers, and attacks fish, first assailing those that have sustained injuries, and kelts, and afterwards clean fish also. It attacks the poll, the fins, the sides, and gills of the fish, and from the outside eats inwards, causing ulcers and ultimately death. It is a fresh-water disease, and cannot exist or originate in the sea; and salt applied to the diseased places has in certain cases been found to act as a cure. A mysterious thing about the disease is that for many years the *Saprolegnia ferax* may remain innocuous in a river, and then develop into fatal activity and attack the fish in the river; and we are at present quite ignorant as to what are the causes, climatic or otherwise, to which this is owing, although many things have been stated to be the causes of the salmon disease by the numerous witnesses examined during the various special inquiries to which it has given rise. Overstocking, pollutions, impassable weirs, a series of dry seasons, &c. have been assigned as the causes of the disease. But in their Report of 1880 on the salmon disease Messrs Buckland, Walpole, and Young write as follows upon this subject: 'All the different circumstances and conditions which were stated by different witnesses to be the causes of the disease are to be found existing in rivers where the disease has never been heard of. We have found the disease existing in polluted and in pure rivers, in rivers obstructed by weirs and in rivers where there are no obstructions, in under-stocked and in fully stocked rivers, in rivers flowing from or through lakes and in rivers with no lakes belonging to their catchment basins; in short, in rivers with the most opposite physical features; and we have been unable to detect in the Tweed, Nith, Annan, Doon, Esk, Eden, and other rivers attacked by the disease any special conditions to which the disease can be attributed which are not likewise to be found in some of the rivers which have escaped its ravages. Those who are acquainted with only one or two salmon rivers are rather apt to imagine that in the pollution, obstruction, or overstocking of the rivers with which they are familiar they have discovered the true cause of the disease. But to those who have an extensive acquaintance with the salmon rivers of Great Britain the most perplexing thing connected with the present inquiry is that every cause, without exception, which has been assigned as the true origin of the salmon disease in infected rivers is to be found in rivers where no disease exists, or has ever been known to exist.' The salmon disease is occasionally coincident with an excellent fishing season, as has been proved on the Deveron, Don, and Tweed. The last-named river has probably suffered more from the salmon disease than any other river in the United Kingdom, as the Report of the Tweed Commissioners for 1891 shows. There were taken out of the river and buried during the year 6,429 fish; while during the ten previous years, 1881-90, the number of fish so dealt with was 74,930, making a total of 81,359, composed of 58,386 salmon, 9,214 grilse, and 13,759 sea-trout. In the same Report it is stated that the total weight of diseased salmon, grilse, and sea-trout taken out of the Tweed and buried was 29 tons 7 cwt. and 9 lb. in 1889-90, and 31 tons 3 cwt. and 80 lb. in 1890-91.

SALMON-FISHERY LAWS.—The salmon is protected by special laws in the United Kingdom.

(1) As to England.—The right to fish salmon in the sea and navigable rivers belongs to the public as a general rule; and the right to fish salmon in rivers not navigable belongs to the riparian owner on each bank, the right of each extending up to the centre line of the stream. But though the public have, as a rule, the right to fish in the sea and navigable rivers, there are various exceptions, which arose in this way. Previously to Magna Charta the crown, whether rightly or wrongly, assumed power to make grants to individuals—generally the large proprietors of lands adjacent—whereby an exclusive right was given to such individuals to fish for the salmon within certain limits. This right, when conferred, often applied to the shores of the sea, but more generally applied to navigable rivers and the mouths of such rivers. The frequency of such grants was one of the grievances redressed by Magna Charta, which prohibited the crown thenceforth from making such grants. But the then existing grants were saved, and hence every person who at the present day claims a several or exclusive fishery in navigable rivers must show that his grant is from the crown, and is as old as Magna Charta. It is not, however, necessary that he be able to produce a grant or chain of grants of such antiquity; for if he has been in undisturbed possession for a long time—say sixty years and upwards—it is presumed that such title is as old as Magna Charta, and had a legal origin. When a person is entitled to a salmon-fishery (and if he is entitled to a salmon-fishery he is entitled also to the trout and other fish frequenting the same place) he is nevertheless subjected to certain restrictions as to the mode of fishing salmon. These restrictions are imposed by the Salmon-fishery Acts of 1861, 1865, and 1873, which repealed prior acts of parliament. No person is now entitled to use lights, spears, gaffs, strokehalls, or anatches, or other like instruments for catching salmon; nor can fish roe be used for the purpose of fishing. All nets used for fishing salmon must have a mesh not less than 2 inches in extension from knot to knot, or 8 inches measured round each mesh when wet. No new fixed engine of any description is to be used. A penalty is incurred for violating these enactments, and also for taking unseasonable salmon, or for taking, destroying, or obstructing the passage of young salmon, or disturbing spawning salmon. During close time no salmon can be legally sold or be in the possession of any person for sale; and such fixed engines as are still legal must be removed or put out of gear during close time. By the Salmon-fishery Act, 1873, a great change has been made in the law regulating the annual close time. By bylaw, boards of conservators can vary the close season, and the sale of fish in the extended open time is made legal. The doctrine of a uniform close season for every river in England and Wales is abolished, and each river can now fix its own close time within the following rules: (1) For every salmon river in England and Wales there must be at least 154 days close time for every kind of fishing but for rod and line; (2) such close time if it does not begin before must do so on the 1st November for all kinds of fishing but with rod and line; (3) for 92 days in each year there must be no fishing for salmon whatever; (4) if the 92 days do not begin before, they must begin on the 1st December of each year; (5) no salmon can be sold after the 3d day of November in any case; (6) if no bylaw has been made on the subject of annual close time the times remain as at present, and no person can fish for, catch, or attempt to catch salmon between the 1st of September and the 1st of February, both inclusive, except with rod and line; (7) if the board of conservators have altered

the time for the capture of salmon, then the salmon may be sold during such extended open time, provided its capture was lawful by other means than by rod and line at the time and place where it was caught. There is also a weekly close time—that is to say, no person can, except with rod and line, lawfully fish for salmon between 12 A.M. (noon) of Saturday and 6 A.M. of Monday following; but boards of conservators have power under the Act of 1873, by bylaw, to extend the weekly close time up to forty-eight hours. Owners of dams in existence in August 1851, need not put in a fish-pass; but in dams built after that date they are bound to provide a fish-pass. Fishing weirs must have free gaps of such size as the Act of 1861 prescribes. For the purpose of supervising the enforcement of the acts, fishery inspectors are appointed for England.

(2) In Scotland there are various important differences from the law of England as regards salmon-fisheries. In Scotland the general rule is that all salmon-fisheries in rivers, estuaries, and in the narrow or territorial seas are vested in the crown, and hence no person is entitled to fish for salmon except he can show a grant or charter from the crown. If he can only show a general grant of fishings without specifying salmon, then it is necessary not only to produce such grant, but to show that he or his predecessor has been in the habit of fishing for salmon for forty years. Moreover, while this right to catch salmon is vested in the crown, or in some grantee of the crown, the right to angle for salmon is now held to be included, and does not belong to the riparian owner. The public have no right anywhere in Scotland to fish for salmon either with net or rod. By virtue of many old statutes all fixed engines for catching salmon in rivers and estuaries are illegal, and it is settled that everything is in the nature of a fixed engine except what is held in the hand of the fisherman and is in motion while he is fishing; but a mechanical contrivance, which enables the fisherman to go a little farther into the river with his coble or boat, which is to drag the net, is not illegal. Stake and bag nets, moreover, are not illegal if they are not in a river or the estuary of a river. In 1862 and 1863 statutes were passed for regulating the Scotch salmon-fisheries. By these acts fishery districts are authorised to be managed by boards. These boards consist of the large proprietors of fisheries. The boards appoint constables, water-bailiffs, and watchers, forming a kind of river-police. The board has power to assess the various proprietors so as to raise funds for paying the expenses of working the acts—similar funds being raised in England only by license-duties. The annual close time for salmon-fishing is fixed by bylaws drawn up formerly by the Commissioners of Scotch Salmon-fisheries, and approved by the Home Secretary; but now, when any alteration is petitioned for by a District Board, it is submitted to the Secretary for Scotland, and, if he approves of the prayer of the petition, a new bylaw is drawn up and published in the *Edinburgh Gazette*, after which it becomes law. There are three groups of Scotch salmon rivers as regards annual close time. The close time of the earliest and much the largest group is from 27th August to 10th February; of the second group from 1st September to 15th February; and of the third group from 10th September to 24th February; the extension of time for rod-fishing, after the nets are off, varies from 10th October to 30th November. The Scotch acts prohibit fishing with lights or with salmon-roe, with nets having meshes less than 1½ inch from knot to knot, or 7 inches round the mesh when wet. And there is a weekly close time from 6 P.M. on Saturday to 6 A.M. on Monday following. In 1882 the Fishery

Board (Scotland) Act was passed. This act conferred upon the new board the powers and duties of Commissioners of Scotch Salmon-fisheries, and the general superintendence of the salmon-fisheries of Scotland, but without prejudice to or interference with the rights of district boards. It also appointed an Inspector of Salmon-fisheries, who has since published annual reports on the Salmon-fisheries of Scotland, which have been presented to the Fishery Board and to parliament.

(3) Ireland.—The Irish salmon-fishery laws are very similar to those of England, but are regulated by district statutes, the principal of which are the Salmon-fishery (Ireland) Act, 1863, and the Salmon-fishery (Ireland) Act, 1869. Fishery districts are there established, and the fisheries are subject to rates and license-duties for the purpose of raising funds. There is an annual and weekly close time, and fixed engines are prohibited, and free gaps enforced in all fishing weirs.

See Dr F. Day's *British and Irish Salmonidæ* (1887); J. W. Willis Bund, *Salmon Problems* (1896); Buckland, *Fish-hatching* (1863); Nicols, *Acclimatization of the Salmonidæ at the Antipodes* (1882); Major J. P. Traherne, *The Habits of the Salmon* (1859); H. P. Wells, *The American Salmon Fisherman* (1886); and C. Hallock, *Salmon Fisher* (New York, 1890); besides the articles ANGLING, POACHING, and PISCICULTURE, with other works cited there.

Salmon, GEORGE, mathematician and divine, was born in Dublin, September 25, 1819, and had his education at Cork, and at Trinity College, Dublin, where he graduated as senior moderator in mathematics in 1839. He was appointed to a fellowship in 1841, took orders in 1844, and became regius professor of Divinity in 1866, provost of the college in 1888, being also a Fellow of the Royal Society, a D.D. of Dublin and Edinburgh, D.C.L. of Oxford, and LL.D. of Cambridge. His contributions to mathematical learning include many papers in the special journals, and admirable treatises on *Analytic Geometry*, *The Modern Higher Geometry*, *Conic Sections*, *The Higher Plane Curves*, and *Geometry of Three Dimensions*. In the department of theology his writings comprise four volumes of strong and thoughtful sermons, *College Sermons* (1861), *The Reign of Law* (1873), *Non-Miraculous Christianity* (1881), *Gnosticism and Agnosticism* (1887), and two collections of his lectures, the first forming an excellent *Introduction to the New Testament* (4th ed. 1890), the other on the *Infallibility of the Church* (1888), a vigorous and unusually readable controversial work.

Salmonidæ, a large and important family of Teleostean fishes in the order Physostomi. The family includes salmon and trout (*Salmo*), smelt (*Osmerus*), grayling (*Thymallus*), vendace, pollan, and 'white-fish' (*Coregonus*), and four or five other genera—about a hundred species in all. They inhabit both salt and fresh water, and many migrate from the one to the other. With one exception (in New Zealand), the fresh-water forms are restricted to the temperate and arctic zones of the northern hemisphere. The body is generally covered with cycloid scales, the head is naked, there are no barbules, there is an adipose or fatty fin behind the dorsal, the pelvic fins are situated about the middle of the ventral surface, the outline of the belly is rounded, the air-bladder is large and open, and with the stomach numerous pyloric cæca are associated. The eggs are large and are shed into the abdominal cavity before they are spawned. In beauty, activity, and also in palatability, the Salmonidæ rank high among fishes.

See SALMON, SMELT, TROUT, &c.; Day's *British and Irish Salmonidæ* (1887); and for the acclimatization of Salmonidæ since 1864 at the antipodes, works by Sir S. Wilson (1879) and Nicols (1882).

Salomon, JOHANN PETER, violin-player and musical composer, born at Bonn in 1745. When young he was attached to the service of Prince Henry of Prussia, for whom he composed several operas. He settled in London, and his series of Philharmonic Concerts there in 1790, for the first of which he arranged to have Haydn present, form an era in the history of music, in that they led to the production of Haydn's twelve grandest symphonies. In 1800 Salomon retired from public life, but continued to compose songs, glees, and violin solos and concertos. He died on 25th November 1815, and was interred in Westminster Abbey.

Salona, an ancient and now ruined city of Dalmatia, stood at the head of a gulf of the Adriatic, about 3 miles N.E. of the spot on which Diocletian afterwards built his gigantic palace of Spalato (q.v.). It was made a Roman colony in 78 B.C., and later became the capital of Dalmatia and one of the most important cities and seaports of provincial Rome. But it was frequently captured by the Goths and other barbarians, and in 639 was completely destroyed by the Avars. The inhabitants who escaped took refuge in Hadrian's palace. The ruins have been excavated during the 19th century; there are now to be seen remains of the former walls, the shell of the ancient Christian cathedral, traces of an amphitheatre, and other structures. The city was early made the seat of a bishop, who was soon advanced to the dignity of archbishop of all Dalmatia. After the destruction of the city the archbishop converted the temple of Jupiter at Spalato into his cathedral.

Saloni'ca, or SALONIKI (Turk. *Selanik*), the second commercial city of European Turkey, next after Constantinople, stands at the head of the Gulf of Salonica, and since 1889 has been connected by rail with Belgrade *via* Usküb and Nisch, and so has direct railway communication with Vienna (820 miles distant). The city climbs up the rocky heights that stretch back from the shore, and is overlooked by a citadel, the ancient acropolis. From the sea it has a fine appearance, being surrounded with white walls, 5 miles in circumference, and having its houses and mosques embowered in trees of dark foliage. The streets previous to 1889 were narrow, rough, and dirty; since that year they have been widened and excellently paved and drained. The principal buildings of interest are the mosques, which were, most of them, Christian churches, and preserve on their walls many valuable evidences of Byzantine art. St Sophia, modelled after its namesake at Constantinople, built in Justinian's reign, and a mosque since 1389, is shaped like a Greek cross and surmounted by a dome covered with mosaics. In the great fire of September 3-4, 1890, which did £800,000 worth of damage to the town, it was a good deal injured, but not irreparably, though the archives were burned. St George, dating probably from the time of Constantine, is circular in form; its dome too is covered with fine mosaics, which were spoilt greatly when the church (mosque) was 'restored' in 1889. St Demetrius (7th century) is decorated internally with slabs of different coloured marble. The Old Mosque was anciently a temple of Venus. Here is the propylæum of the hippodrome in which Theodosius in 390 ordered the massacre of 7000 of the citizens of Salonica. The Via Equatia, the great high-road from the Adriatic coast (i.e. from Rome) to Byzantium, passes through this city. Its entrance and exit were marked by handsome Roman arches, of which that at the west end was taken down in 1867; the other, the arch of Constantine, at the east end, still stands, but in a ruinous condition. The commerce of the port is

steadily increasing, especially since the opening of the railway to Servia. The imports, consisting chiefly of metal wares, textiles, coffee, petroleum, salt, sugar, rice, and soap, reach an annual average of £1,377,000. The exports—corn, cotton, opium, wool, tobacco, skins, silk cocoons, &c.—average £1,400,000. One-third of the total maritime trade (1,500,000 tons in and out) is in the hands of Great Britain. The native industries include the manufacture of cotton, flour, soap, bricks, leather, silk, and carpets. Pop. (1890) estimated at 121,600, of whom nearly 61,000 were Jews of Spanish descent, 25,000 Turks, and 14,000 Greeks.

Salonica is the ancient *Thessalonica*, to whose Christian community St Paul addressed the two Epistles to the Thessalonians. At this city too Cicero dwelt when he withdrew from Rome after the suppression of the Catiline conspiracy. Thessalonica was built by Cassander about 315 B.C. on the site of an older city named Therme, and was called after his wife, sister of Alexander the Great. It soon became a place of importance as the principal harbour of Macedonia, and later was the chief station on the Via Equatia. Under the Byzantine emperors it successfully withstood the Goths and the Slavs, but was captured by Moslems from Africa in 904, when they carried away 22,000 of its people into slavery, and by the Normans of South Italy in 1185. After several changes the city passed into the hands of the Venetians, and from them the Turks took it in 1430.

Saloop. See SASSAFRAS.

Salop. See SHROPSHIRE.

Salpa, a remarkable genus of free-swimming Tunicates, included along with *Doliolum* and *Anchinia* in the order Thaliacea. Several species occur in the warmer seas, transparent pelagic animals, complex in structure and in life-history. The body is somewhat barrel-shaped, open at both ends, ringed round by several distinct but incomplete hoops of muscle, controlled by a complex nervous system, possessed of eyes and other less definite sense-organs, with compressed lateral viscera. In the life-history there is an alternation of generations. There are asexual forms or 'nurses,' from which there grows out a long ventral 'stolon.' This stolon is segmented into a chain of sexual buds, and the whole chain is set free. As the individuals become mature they separate from one another, the chain breaks into its links. Each of these produces an ovum, which after fertilisation develops into an embryo and into the asexual 'nurse' form with which we began. The sexual forms are hermaphrodite, like all Tunicata, but cross-fertilisation seems to occur.

Sal Prunelle, purified nitre in mass, or fused and rolled into small balls. See NITRE.

Salses. See VOLCANOES.

Salsette, an island lying N. of Bombay, with which it is connected by a bridge and a causeway. It is a beautiful island, diversified by mountain and hill, studded with the ruins of Portuguese churches, convents, and villas, and rich in extensive rice-fields, cocoa-nut groves, and palm-trees. Area, 240 sq. m.; population, 111,000; chief town, Thana (q.v.). Nearly one hundred caves and cave-temples exist at Kánhari or Keneri, in the middle of the island, five miles west of Thana. They are excavated in the face of a single hill, and contain elaborate carving, chiefly representations of Buddha, many of colossal size. There are caves in other localities besides those at Kánhari—e.g. at Montpezir, Kanduti, Amboli, &c. It was occupied by the Portuguese early in the 16th century, and was captured by the Mahrattas in 1739 and by the British in 1774.

Salsify, or **SALSIFY** (*Tragopogon porrifolium*), a biennial plant growing in meadows throughout



Salsify (*Tragopogon porrifolium*).

Europe, locally indigenous in the south-eastern counties of England, cultivated in gardens for the sake of its root, which is used in the same manner as the carrot, and is very delicate and pleasant, with a flavour resembling asparagus or scorzonera. Cooked in a certain way it somewhat resembles the oyster in flavour, hence the popular name *Oyster Plant*. The root is long and tapering, and in cultivation white and fleshy, with much white milky juice; the stem 3 to 4 feet high, with smooth and glaucous leaves, which resemble those of the leek; the flowers are of a dull purple colour. The seed is sown in spring, and the root is ready for use in winter. Next spring, when the flower-stalks are thrown up, they are used like asparagus. The genus *Tragopogon* belongs to the natural order Composite, sub-order Cichoraceae. The Yellow

Goat's Beard (*T. pratensis*), a native of Britain, was formerly cultivated in England for its roots, which are similar in quality to salsify. Scorzonera is sometimes called Black Salsify.

Salt, or **CHLORIDE OF SODIUM** (sym. NaCl; sp. gr. 2.15). This substance is called by chemists common salt to distinguish it from a great number of other bodies termed Salts (q.v.) in scientific language. Rock-salt or halite crystallises in cubes, colourless and usually transparent when pure, and sometimes measuring an inch on the side. It is, however, generally coloured by the presence of some foreign body, and occurs of yellow, red, blue, and purple tints. When decidedly impure it is often of a dull-gray colour. Salt is one of the few substances which are nearly as soluble in cold as in hot water. A saturated solution has a specific gravity of 1.205. Sea-water, which contains salt to the extent of from 2.5 to 2.7 per cent., has a mean specific gravity of 1.027. Salt has a saline but not a bitter taste, and is inodorous. Some of the physical properties of rock-salt are remarkable (see HEAT, Vol. V. p. 610). Salt is of great importance as a condiment and antiseptic, and equally so in some chemical manufactures. As rock-salt it is found in most countries, and in some extensively; but salt from any source is scarce and costly in some places—certain parts of the interior of Africa, for example. It can, of course, be obtained by evaporating sea-water. Some beds or deposits of rock-salt have no doubt been formed by the slow evaporation of large bodies of salt water, which by one means or another—by a sandbank, for example—have been cut off from communication with the sea. This process would sometimes be repeated by sea-water again getting in through a breach in the bank, and this again being filled up. There are instances where it has certainly been formed in this way on a limited scale. But geologists seem to be of opinion that beds of rock-salt have more generally arisen from the long-continued evaporation of large inland lakes without outlets; these had long been fed by rivers or streams which dissolved salt out of the soil or strata over which they flowed. The Dead Sea and the Great Salt Lake of Utah are examples of lakes without outlets at the bottoms of which rock-salt is forming. All salt,

wherever found, has probably come originally in some way or other from the sea. Rock-salt beds are usually associated with deposits of sulphate of lime (calcium sulphate), and are more common in the Trias than in other geological formations.

Valuable beds of rock-salt, usually accompanied with brine, occur in England. The Cheshire deposits, which are in the basin of the river Weaver, have been long worked and are still productive. At Northwich in that county rock-salt is found at from 200 to 250 feet below the surface. There are four beds of an aggregate thickness of 240 feet, but the two lower ones are mixed with marls. The two upper beds each average about 90 feet in thickness, with some brine just above the top bed. At Winsford and Wheelock in the same county thick beds of rock-salt also occur at moderate depths. In Worcestershire, at Stoke Prior and at Droitwich, rock-salt occurs, 154 feet thick including marls in the former locality, and brine is likewise found at both places. At Stafford Common in Staffordshire the salt is 78 feet thick; and in these two counties the deposits are not far below the surface. In Cheshire some rock-salt is still mined at Northwich, but here, as in other places in the west of England, most of the salt is obtained from brine naturally overlying the rock-salt or from inundated salt-mines. In 1889 an important discovery of rock-salt was made at Walney Island and at Fleetwood (Preesall), in Lancashire, where the deposits are roundly from 100 to 500 feet in thickness, and at the former place from 270 to 360 feet below the surface. This Lancashire salt was first worked (as Preesall brine) in 1890. On the east side of England, between Middlesbrough and Hartlepool, there is an extensive deposit of rock-salt, which was accidentally discovered in boring for water in 1862. Its proved area is between 30 and 40 sq. m., the salt is from 50 to 115 feet thick, and its depth below the surface varies from 800 to 1600 feet. This is greatly deeper than the beds in the west of England. Hitherto in this district the rock-salt has not been mined. A bore-hole is made, into which a double iron pipe—one within the other—is inserted, and in the jacket or annulus thus formed fresh water is let down to form brine, which is pumped up through the inner tube by a steam-engine. In 1890 the rock-salt mined in England (Cheshire) amounted to 159,000 tons, while the salt obtained from brine was as much as 1,958,000 tons, Cheshire producing more than two-thirds of the latter. Some rock-salt is mined at Carrickfergus in Ireland.

Rock-salt is found in Galicia, the mines at Wieliczka, which have been worked since the 13th century, being the most famous in the world. The system of mines extends over an area of about 6 miles from east to west, and 2 miles from north to south, with underground streets, squares, &c., and over 30 miles of tramway; the greatest depth reached being about 12,000 feet. In Wallachia, Transylvania, Hungary, Upper Austria, Styria, Salzburg, and Tyrol many important salt-mines are worked. Rock-salt is also found in Russia, Italy, and largely at Stassfurth in Germany and Cordova in Spain. Of eastern countries Persia is perhaps the best supplied with salt; India has productive mines in the Salt Range (q.v.), but salt is also largely imported; and both rock-salt and salt lakes occur in Asiatic Russia. The Wieliczka rock-salt is of Tertiary age; that of Cheshire, Bavaria, and the Austrian Alps Triassic; in Permian deposits near Berlin borings have gone down in rock-salt for nearly 4000 feet. Deposits of the same age occur also in Holstein, and in eastern Russia. Brine-springs rise from many other geological systems: thus, in Northumberland and Leicestershire they issue from Carboniferous strata,

while in some parts of the Alps they come from rocks of Jurassic age. Similarly in North America saliferous formations occur on several geological horizons. Thus, the salt-works at Syracuse, New York, and in the neighbourhood of Goderich on the Canadian side of Lake Huron, are in the well-named 'Salina group' of the Upper Silurian. Brine-springs also rise from the Carboniferous strata of Michigan, Ohio, and Virginia, while a thick bed of rock-salt of apparently Cretaceous age occurs in southern Louisiana.

Not infrequently rock-salt occurs in considerable abundance at the surface; some of these accumulations are of quite recent formation, while others are of great geological age. Thus, at Cardona (Montserrat) in Spain rock-salt forms hills some 400 and 500 feet in height—the deposits being probably of Cretaceous age; and similar masses occur near Orenburg in Russia, and in the Punjab. Superficial saline deposits are met with covering extensive areas in many more or less desert regions, where they evidently indicate the sites of dried-up lakes and inland seas of comparatively recent age. As examples may be cited the rock-salt deposits of the Kirghiz Steppes, those near Lake Urumiah, and in various parts of South America. Salt lakes from the bottoms and shores of which rock-salt is obtained are met with in many regions, both in the Old and New Worlds. Thus, it is collected in Cyprus, Melos, the Crimen, and the Aral-Caspian area; and many saline lakes, pools, and marshes occur in the great western region of North America. Even in dry warm regions where no salinas may happen to exist, an efflorescence of salt not infrequently covers the ground after rains—the salt having doubtless been derived by capillary attraction from the underlying subsoils and rocks. Rock-salt also occurs as a product of sublimation in volcanic regions, from which it has been inferred that much of the steam emitted by volcanoes has come from water introduced by underground fissures from the sea.

When brine is pumped up to the surface it is run into cisterns or reservoirs situated at a higher level than the evaporating pans, into which it descends through pipes. These pans are large shallow iron vessels, heated either by coal-fires placed beneath them or by other means, such as waste steam. With a high heat and a short time in the pan a fine salt is produced; with a comparatively low heat and a longer time in the pan a coarse salt forms. Agitation of the brine tends also to produce a fine salt. Brine boils at 226° F., and it is at this temperature that ordinary table-salt, called also 'lump' or 'lumped' salt, is produced. At about 165° F. what is called 'common' salt is obtained; large-grained salt forms at between 130° and 140° F.; and fishery-salt, also large grained, at from 100° to 110° F. The salt crystallises on the surface of the brine in the pan, floats about a little, and then falls to the bottom, leaving the surface free for a fresh crop of crystals. Twice or thrice in twenty-four hours fine salt is drawn from the pans, which are kept nearly full of brine, by raking it to the side and lifting it out with perforated scoops. It is then put into moulds called 'tubs,' and left for about half an hour to let the water drain off, after which the shaped lumps are put into a stove, where they remain till they are quite dry. Sometimes even fine salt is not stoved, and it is then called butter salt or cheese salt. To make salt of the largest grain the brine is left for nearly a fortnight before removing the crystals. In this process the 'bittern' or magnesium chloride remains in solution after the common salt separates.

At different places around the British coasts salt was formerly obtained by evaporating sea-water, and to such salt the name bay-salt (often

used for coarse salt) properly belongs. In Spain, Italy, and southern France the manufacture of salt in this way is practised on a large scale. Besides common salt sea-water contains much smaller quantities of potassium chloride, magnesium chloride and sulphate, calcium sulphate, and more minute quantities of other bodies. The water of the Mediterranean, which is slightly more salt than the open ocean, contains 2.72 per cent. of sodium chloride. As the evaporation goes on calcium carbonate separates first and then calcium sulphate. When the water reaches the density of between 1.22 and 1.31 sodium chloride separates along with small quantities of other salts; and when the specific gravity becomes 1.33 very little of anything but magnesium chloride remains. A series of shallow rectangular basins are usually so arranged that the water can flow from basin to basin, and when it has reached the lowest the partially concentrated sea-water is collected in a well. From this it is raised to the first of another series of basins, and finally into the series where the salt crystallises. The salt is then stacked in heaps, which are protected from rain and left for months to drain. This to a large extent gets rid of deliquescent and bitter impurities. It then contains about 95 per cent. of chloride of sodium, in which state much of it is sent into the market.

In some northern countries sea-water, suitably placed for the purpose, is frozen over in winter in order to increase the proportion of salt in what remains liquid, since the ice so formed is fresh. The water is then evaporated by artificial heat till the salt is obtained. The chief markets abroad for British salt are India and the United States. To the former country about 300,000 tons are now annually exported, and to the latter 120,000 tons were sent in 1889, or only about one-half the average quantity exported to that country a few years before. It is estimated that London consumes daily 11 tons of salt.

Besides its universal use as a condiment, salt is an all-important substance in the manufacture of soda, hydrochloric acid being obtained from it in large quantities in the process as a by-product. It is also employed in the manufacture of soap and for producing what is called a salt-glaze on stoneware. Agriculturists destroy slugs and grubs with salt, and it appears to improve the fertility of soils when mixed with certain manures. Brine is used in the pipes of freezing-machines. Rock-salt is carved into cups and vases in the Punjab, and it is said that houses are built of it in certain very dry regions, as in the Desert of Caramania, where this material is abundant.

The salt-tax was or is in some countries an important source of revenue, though it is recognised by economists as one that presses unfairly on the poor. The salt-tax of the ancient regime in France is referred to at GABELLE. In modern Italy tobacco and salt are government monopolies. In British India the revenue from the salt duty comes next in value to that from land and opium. In Burma it is now 1 rupee per maund of 82½ lb.; elsewhere (since 1888) it is 2½ rupees. In Britain salt duties were first exacted in 1702; the rate was 5s. per bushel in 1798, during the great French war, but was ultimately increased to 15s. per bushel, thirty or forty times the cost of the article! The duty was finally remitted in 1825. Salt makers or salters used in some parts of Britain to be, like colliers, serfs (see SERF). For the value of salt in preserving food, see ANTISEPTICS and PRESERVED PROVISIONS. For the varying saltiness of the sea at various depths, see ATLANTIC, PACIFIC, SEA, &c.

See J. J. L. Rutton's *Common Salt* (1879); E. M. Boddy's *History of Salt* (1881); C. G. Gümpel, *Common Salt* (1898).

Salt, SPIRITS OF, the old name for muriatic or hydrochloric acid.

Salt, SIR TITUS, a public-spirited English manufacturer, was born at Morley, near Leeds, 20th September 1803. He began business as a wool-stapler at Bradford, and being successful started wool-spinning in 1834, and was the first to introduce the manufacture of alpaca fabrics into England. His utilisation of the alpaca, which first came under his notice during a business visit to Liverpool, is one of the romances of British commerce. As business increased he concentrated his factories in a pleasant valley, 3 miles from Bradford, on the Aire (1853), and round these factories, which cover 12 acres, rose the model village of Saltaire (q.v.). Titus Salt was mayor of Bradford in 1848, was returned as member of parliament in 1859, and was created a baronet in 1869. He died 29th December 1876. There is a statue of him in Bradford. See *Life by Balgarnie* (1877).

Salta, a northern province of the Argentine Republic, touching Chili and Bolivia, and nearly enclosing the province of Jujuy. Minerals are abundant, but have been neglected for agriculture and cattle-raising. Salta is watered by the Salado, San Francisco, and Bermejo. Area, 45,000 sq. m.; pop. 118,015.—SALTA, the capital, on the Rio Arias, 535 miles by rail N. by W. of Córdoba, was founded in 1582, is the seat of an archbishop, and has a seminary for priests, a national college, and a normal school for girls. Pop. (1895) 16,600.

Saltaire, a model village on the Aire, 3 miles from Bradford and 11½ miles by rail from Leeds, founded and built by Sir Titus Salt (q.v.), who opened his worsted and alpaca factory here in 1853. This factory covers 12 acres, and is six stories high. The place possesses a church of Byzantine architecture, hospital, school, a park of 14 acres, workmen's club and institute which cost £30,000, &c. New Technical Schools were opened in 1887. Pop. about 5000.

Saltash, a picturesque ancient municipal borough and seaport of Cornwall, on the west side of the estuary of the Tamar, and 4½ miles NW. of Plymouth by a railway that crosses the Tamar by Brunel's iron Royal Albert Viaduct (1857-59), 2240 feet long and 240 high (the roadway 102 feet above high-water mark), constructed at a cost of £230,000. The church of St Nicholas dates from 1225. The town, which was frequently taken and retaken during the great Civil War, was disfranchised in 1832. Pop. (1851) 1621; (1891) 2541.

Saltburn, a picturesque Yorkshire watering-place, 4 miles SE. of Redcar. It dates only from the opening of the railway in 1861; but, built on lofty cliffs facing the sea, and possessing numerous attractions, it has prospered greatly. Pop. (1881) 1646; (1891) 2232.

Saltcoats, a watering-place of Ayrshire, on the Firth of Clyde, 1 mile ESE. of Ardrossan and 30 miles SW. of Glasgow. It was an important seat of salt manufacture from 1686 to 1827. Pop. (1841) 4238; (1891) 5895.

Saltillo, capital of the Mexican state of Coahuila, by rail 237 miles SW. of Laredo, Texas, and 603 N. by W. of Mexico city. It contains several convents, a small fort, a bull-ring, a number of cotton-factories and pulque-distilleries. Pop. 25,000. See Mrs Gooch, *Face to Face with the Mexicans* (1890).—Near it is Buena Vista (q.v.).

Saltire. See HERALDRY, Vol. V. p. 662.

Salt Lake City, the political and ecclesiastical capital of Utah, is situated on the river Jordan, 11 miles from its mouth in Great Salt Lake (q.v.), and 4285 feet above the level of the sea. By rail it is 36 miles S. of Ogden, on the Union Pacific Rail-

road (833 miles from San Francisco and 1031 from Omaha). It was settled by the Mormons (q.v.) in 1847, and incorporated in 1851; it is divided into five municipal and twenty-three ecclesiastical wards; has an area of 12 sq. m., with corporate limits embracing 50 sq. m.; and its shaded streets, 132 feet wide, many of them freshened by streams of running water from the neighbouring mountains, are traversed by tram-cars (1872), and lit by gas (1873) and the electric light (1877). Brick and timber are the common building materials, and wooden 'shanties' still keep their place even in the principal streets. The chief public buildings are the Mormon temple (1853-1893, 186 by 99 feet, and having cost about \$4,000,000), with walls of dressed granite, 10 feet thick at base, and tapering to 5 feet thick at the top; the Tabernacle, an immense elliptical building, with a dome-shaped roof resting on sandstone pillars, and seated for 10,000; the assembly hall (120 by 68 feet), of rough-hewn granite, with seats for 2400; the endowment-house, &c. But, though the Mormon influence is still strong, other religious bodies also are represented, and there are Roman Catholic, Episcopalian, Presbyterian, Congregationalist, and Methodist churches: St Mark's Cathedral is a handsome building. Other noteworthy edifices are those of the museum, the Mining Institute, St Mary's Hospital, the university of Deseret (1850; buildings finished, 1887), and the theatres and opera-house. The mud-wall erected in 1853 has now disappeared. Something more than a beginning has been made of manufactures—bricks, paper, timber, blinds, window-glass, &c. Pop. (1870) 12,854; (1880) 20,768; (1890) 44,843; (1900) 53,531. See Burton, *The City of the Saints* (1861), H. H. Bancroft's *History of Utah* (San Francisco, 1889), and the works cited in the latter.

Salto, a north-western department of Uruguay, on the Uruguay River, is a picturesque hill-country, watered by the Arepey and its many tributaries, and devoted to cattle-rearing. Area, 4863 sq. m.; pop. (1895) 35,600.—The chief town, Salto, stands on three hills almost at the head of navigation on the Uruguay, 306 miles from Buenos Ayres, and 86 by rail N. of Paysandú. It carries on an active frontier trade with Brazil, exporting goods valued at \$1,500,000 yearly, and has a granite pier, and a foundry and shipbuilding establishment. Pop. 12,000.

Salt of Saturn, a name for acetate of lead.

Salt of Sorrel, the common name for binodate of potash. See OXALIC ACID.

Salt of Tartar, a commercial name for carbonate of potash in a very crude form.

Saltpetre. See NITRE.

Salt Range, a mountain-system in the Punjab, India, consists of two main chains running east and west, and embracing between them an elevated tableland. It begins on the south side of the Jhelum, runs west to the Indus, and varies from 3200 to 5000 feet in height. Its appearance is exceedingly bleak and barren, but not without much savage grandeur. The system gets its name from the inexhaustible beds of rock-salt that occur on the edges of the plateau. Some 60,000 tons are extracted annually, four-fifths from the Mayo mines, a few miles north-east of Pind Dadan Khan. Coal and other minerals also occur.

Salts constitute an extremely important class of substances in chemistry, of which common or sea salt (sodium chloride) may be mentioned as the most familiar example. Epsom salt (magnesium sulphate), Glauber's salt (sodium sulphate), saltpetre (potassium nitrate), Rochelle salt (sodium potassium tartrate) are other well-known

salts. Common salt appears to have been known from the earliest times, and the fact that the same Greek word *hals* is used in the feminine, signifying the ocean, and in the masculine, signifying salt, would seem to indicate the sea as the source from which common salt was obtained in the first instance. The application of the name salt to substances other than common salt would follow from the more or less general similarity of these to common salt in appearance, and in the more easily observed properties, such as solubility, taste, &c.

By the term salt chemists now ordinarily understand a substance which may be looked upon as derived from an acid by the replacement of part or the whole of the hydrogen of the acid by means of a metal or of a Radical (q.v.) capable of playing the part of a metal; such as, for instance, the radical NH_4 , which is called ammonium. The acids themselves are even looked upon as constituting the hydrogen terms in the various series of salts, and are sometimes called hydrogen salts.

There are several general modes of formation of salts. One of the most important of these depends upon the mutual action upon each other of an acid and a Base (q.v.), when the typical characters of each of these substances disappear and a salt is produced, usually with the simultaneous production of water. For example, when nitric acid and the basic oxide of lead act upon each other, lead nitrate and water are produced, thus: $2\text{HNO}_3 + \text{PbO} = \text{Pb}(\text{NO}_3)_2 + \text{H}_2\text{O}$. Salts are also frequently produced when metals are dissolved in acids, the hydrogen of the acid being displaced by the metal. Thus, iron dissolves in dilute hydrochloric or sulphuric acid with the evolution of hydrogen and the formation of a ferrous salt: $\text{Fe} + \text{H}_2\text{SO}_4 = \text{H}_2 + \text{FeSO}_4$. Strictly analogous to the displacement of hydrogen from sulphuric acid by means of iron is the displacement of copper from cupric sulphate by the same metal—this action also giving rise to ferrous sulphate while copper is precipitated: $\text{Fe} + \text{CuSO}_4 = \text{Cu} + \text{FeSO}_4$. In the process called double decomposition (see CHEMISTRY, Vol. III. p. 152) two new salts are frequently produced when the solutions of two salts are mixed together, as, for instance, when sodium chloride and silver nitrate act mutually upon each other, yielding silver chloride and sodium nitrate: $\text{NaCl} + \text{AgNO}_3 = \text{AgCl} + \text{NaNO}_3$. There are other modes of salt formation which are of minor importance.

Salts are frequently considered as consisting of metal and salt radical, the latter comprising all that portion of a salt which is not metal, as explained in the article RADICAL. In the cases of the so-called haloid salts (fluorides, chlorides, bromides, iodides) the salt radical consists of one element only, while in other salts the salt radical contains two or more different elements. The names given to certain classes of salts may be shortly explained. Normal salts are those resulting from the displacement of the whole of the displaceable hydrogen of an acid by means of a metal. Neutral salts are such as do not exhibit either the acid or the alkaline reaction when dissolved. Basic salts and acid salts, as contrasted with the normal salts, are respectively intermediate in composition between the normal salt and the base and between the normal salt and the acid. These salts still possess the respective characters of a base and of an acid. Double salts may contain two or more metals in combination with the same salt radical, or two or more salt radicals in combination with the same metal, or they may contain more than one metal and more than one salt radical.

SMELLING-SALTS are a preparation of carbonate of ammonia with some of the sweet-scented volatile oils, used as a restorative by persons suffering from

faintness. The pungency of the ammonia is all that is useful, and the oils are added to make it more agreeable. Oils of lavender, lemon, cloves, and bergamot are those chiefly used. The celebrated Preston smelling-salts are scented with oils of cloves and pimento. The manufacture of ornamental bottles to contain this preparation is an important branch of the glass and silversmith's trades.

Saltus, EDGAR, an American author, born in New York City, 8th June 1858, studied at Paris and in Germany, and in 1880 graduated at Columbia College law-school. His writings include a good biography of Balzac (1884); a history of Pessimistic philosophy—*The Philosophy of Disenchantment* (1885), and *The Anatomy of Negation*—both treated with a curious whimsical briskness and humour; and a series of striking stories, full of an odd passionate materialism and biting cynicism, painful, but original and clever, though disfigured by a fantastic style and eccentric vocabulary—*Mr Incoul's Misadventure* (1887), *The Truth about Tristrem Varick* (1888)—these two the best—*Eden* (1888), *A Transaction in Hearts* (1889), and *The Pace that Kills* (1889).

Saltwort (*Salsola*), a genus of plants of the natural order Chenopodiaceae, having hermaphrodite flowers, with 5-parted perianth and a transverse appendage at the base of each of its segments, five stamens and two styles, the seed with a simple integument. The species are numerous, mostly natives of salt marshes and seashores, widely diffused. One only, the Prickly Saltwort (*S. kali*), is found in Britain. The plant is annual, with prostrate much-branched



Prickly Saltwort (*Salsola kali*).

stems, awl-shaped spine-pointed leaves, and axillary solitary greenish flowers. It was formerly collected in considerable quantities on the western shores of Britain, to be burned for the sake of the soda which it thus yields. *S. sativa* is the chief Barilla (q.v.) plant of the south of Spain.

Salutations are customary forms of address at meeting or at parting, or of ceremonial on religious or state occasions, including both forms of speech and gestures. Through the influence of heredity and habit many of these have become reflex irrepensible actions, their observance fortified with all the sanctity of moral or religious obligation. For although it is true that etiquette is entirely a matter of relative, and not absolute, obligation, and that such a feeling as modesty itself is mainly a question of latitude, yet the average modern European dreads the unfavourable judgment of society upon a solecism more than the condemnation of his own conscience on some breach of the weightier matters of the law. And it seems to be a general rule among races of men, not to speak of individuals, that extremes of ceremonious salutation stand in inverse ratio to their moral

value. The ceremonious politeness of modern Europe has descended in great measure from the unworthy regime of the Lower Roman Empire, and its traditions, now as well as then, are incapable of being taken literally, its metaphors translated into fact. It is a complete mistake to suppose that savages are at all informal or extemporary in their salutations and ceremonies. Salutations tend to become less elaborate in progressive civilisation, the tendency being toward the preservation only of those which help to soften the asperities of social intercourse. Savages are much more given to gesticulation than civilised men. Yet it is unsafe to say that this depends solely upon degrees of culture, for there is a wide difference at the present day between the Neapolitan or Tarasconese and the German or Scotchman. No race has neglected the use of gesture more than the English—only among our deaf-mutes do we see what the capability of gesture is, and of what a wealth of expression we have deprived ourselves. Many of the natural gesture-signs, used as occasion arises, do not fall under the head of salutations, as involving nothing ceremonial, such as beckoning with the hand, thrusting out the tongue, snapping the fingers, or such vulgarisms as 'taking a sight'—itself a mark of respect among the Todas—and the like; nor yet such natural but significant outward expressions of inward emotion as weeping or trembling for fear, grief or joy, or yet blushing, which Darwin calls 'the most peculiar and the most human of all expressions.'

One of the most ancient and wide-spread, as well as natural, forms of salutation by gesture is the embrace in testimony of affection, as we find it in the Old Testament and in Homer. The kiss was at no time universal, being unknown among Fuegians, New Zealanders, Papuans, Australians, and Eskimos. It was used by the ancient Hebrews, Greeks, and Romans, and among the early Christians was adopted as a sign of fellowship, survivals of which are the Eastern kiss of peace at the Eucharist and the Western modified use of the *osculatorium* or *pax*. In England it was formerly the custom to kiss at the beginning and end of a dance, as well as on meeting a lady or taking leave of her; and the favourite game among the lower orders of 'kiss-in-the-ring' is the last survivor among many similar old English pastimes. As a general form of salutation, however, it appears to have been a custom peculiarly English; Æneas Sylvius describes the Scottish women of his day as 'giving their kisses more readily than Italian women their hands'; Erasmus, in a letter to a friend, describes it as a custom never sufficiently to be praised, and Bulstrode Whitelocke describes his satisfaction in teaching the English mode to Queen Christina's ladies at the court of Sweden. The Puritans objected strongly to it, but its disuse was really the result of the French airs that came in with Charles II., and it lingered among honest country-folk till the times of the *Spectator*. It is still used ceremoniously between royal personages, and still on the Continent even between men at parting or meeting again after an absence, as well as in the more servile forms of kissing the hand of a royal personage or the foot of the pope. The custom of grasping or shaking hands is now widely spread over the world, either in the English method, with its many gradations of heartiness, or the Moslem variety of pressing the thumbs against one another as well; but it is not really a primitive custom everywhere, and is by no means, as Dr Tylor has shown, to be explained with Herbert Spencer as a compromise between a simultaneous effort of two persons to kiss each others' hands in token of submission.

Its real origin lies deeper in the universal gesture-language of mankind, the essential act being a joining of hands to express compact, union, peace, or friendship. The Roman *dextrarum junctio*, in making a contract of marriage, preserved by ourselves, and the early Christian 'right hand of fellowship,' point to the real origin of what has become a mere salutation with us as with the Romans themselves. Other forms of salutation that recall the civilities observed among dogs, cats, and other animals are forms of bodily contact, as the rubbing of noses of the Laplanders and New Zealanders; the patting of each other's arms, breasts, or stomachs, by North American Indians; the Polynesian stroking of one's own face with another's hand or foot; the clapping of hands and leaping backwards and forwards in Loango; the snapping the fingers in Dahomey; the Batongan rolling on the back along the ground, slapping the thighs the while; the blowing with the breath upon another, described by Du Chaillu, in Africa; or Sir Samuel Baker's description of the Abyssinian custom of holding another's hand and pretending to spit upon it. The Polynesians and Malays always sit down when speaking to a superior; a Chinaman puts on his hat instead of taking it off; on the Congo and elsewhere in Central Africa it shows respect to turn the back upon a superior in addressing him. The Tongans reserve the use of certain words for the king alone, and they employ the third person in token of respect. Still more marked is the difference between ceremonial and common speech in Samoa, and here also they use the plural in speaking to a superior. In Fiji if a great man slips or falls every one of inferior rank must at once do the same.

Other groups of ceremonial salutations are the prostrations before a superior of ancient Egypt and Assyria, as well as of modern Dahomey, and of regular Moslem divine worship; the lying with the face in the dust of China and Siam; the ancient Malagasy custom of a wife crawling on all fours before a husband and licking his feet; the Arab refinement of putting the hand upon the ground and then lifting it to the lips and forehead; the kneeling on one knee to express homage to a European sovereign, as on both in divine worship; the turning toward the east, the genuflection before the host, or bowing at the pronouncing of the name of Jesus in Christian churches. These are all originally signs of submission or of inability to resist, meant to deprecate the majesty or the wrath of superior power. We find falling on the face before a potentate in the Old Testament, and in China at the present time among the eight kinds of obeisances, increasing in humility, the first is putting the hands together and raising them before the breast; the second, bowing low with the hands joined; the third, bending the knee; the fourth, actual kneeling; the fifth is kneeling and striking the head on the ground; the sixth, kneeling and thrice knocking the head, which again doubled makes the seventh, and trebled, the eighth—the famous *kotow* which Lord Amherst refused in 1816: this last being due to the emperor and to heaven. Among the Hebrews repetition had a kindred meaning—'Jacob bowed himself to the ground seven times, until he came near to his brother.' Survivals amongst ourselves of ancient more abject forms are the *curtsy* in the one sex, and in the other the *scrape* till lately accompanying the bow, made by a backward sweep of the right foot. From the profound bow, expressive of great respect, our usage shades away to the modern curt nod, in which respect has degenerated into mere recognition.

Uncovering, again, is a characteristic symbol of submission in presence of a superior (Isa. xx. 2-4),

whether to the waist, as in Tahiti, or of the entire clothes, as in the case of the female attendants upon the king of Uganda. In Europe we only uncover the head, and this in many cases is minimised to a mere touching of the hat. In the Coptic and Abyssinian churches the Semitic custom of uncovering not the head but the feet is still preserved. We find the same ceremonial uncovering of the feet in ancient Peru and Mexico; and in Burma it was long a point of dispute whether foreigners should comply with the native custom on approaching the king.

Again, as for the words and phrases which accompany the gestures of salutation, we find the widest variety in form and nature. The oriental forms, both scriptural and modern, are full of grave dignity and religious character. Mohammed took advantage of this characteristic, and made the use of certain forms rigorous as religious passwords; exactly like the once common Spanish form, 'Ave Maria purissima,' which had to be answered by 'Sin pecado concebida.' The Eastern phrases, 'The Lord be with thee,' 'Be under the guard of God,' 'Blessed be thou of the Lord,' have degenerated into the Spanish 'Vaya con Dios, Señor,' the French 'Adieu,' and our own 'Good-bye,' abridged from 'God be with ye.' The Basque verb has distinct inflectional forms for use in addressing a man, a woman, a superior, or an equal. Our familiar abridged forms, 'Bless you,' 'Mercy me,' 'Save you, sir,' show an English reticence in a light and familiar use of sacred names which is not seen in the familiar French 'Mon Dieu,' the German 'Mein Gott' or 'Herr Je.' The *citoyen* and *citoyenne* of the French revolution was but one of a hundred childish attempts to obliterate the natural growth of ages, and it is not a little striking that 'Merci, *mon-sieur*,' was the phrase that came to the lips of the wretched Robespierre a moment before his end. The familiar *sir*, *signor*, *señor*, *mon-sieur* are of course ultimately referable to the Latin *senior* expressive of the reverence due to age; *madame*, *mademoiselle* lead up to Latin *dominus*, 'the master of a house.' The use of 'sir' may convey a sense of scorn, just as the archaic *sirrah* always implied anger or contempt. And even 'madam' and 'mistress' are not without an odious sense. The Greek phrase, both at meeting and parting, was χαίρει ('be joyful'); the Romans usually said 'Salve' at the one and 'Vale' at the other. These words express wishes for cheerfulness, peace, health; specialised forms of the same are the Pauline χάρις καὶ εἰρήνη ('grace and peace') and the ecclesiastical 'Pax vobiscum' and 'Benedicite.' Such ceremonial forms as 'Let the king live for ever,' 'Long live the king,' by their hyperbole betray an oriental origin; 'good-day,' 'good-night' are obviously natural salutations everywhere, as are also the Italian 'Felicità,' the German 'Gesundheit,' the Roman 'Sit fanstum ac felix.' Such phrases as 'Serene Highness,' 'Grace,' 'Lordship,' 'Excellency,' 'Eminence,' 'Transparency,' 'Right Honourable,' 'Most Noble,' 'Honourable,' 'Right Reverend,' 'Very Reverend,' 'Venerable,' 'Father,' 'Reverend,' like 'my learned brother' between counsel, and 'the gallant officer' of a soldier across the floor of the House of Commons, are conventional terms that must on no account be omitted, as omission could mean nothing but intentional disrespect. Quakers alone possess an immunity, the ground of their objection being recognised as a difficulty of conscience. A special salutation is due, as everybody knows, to any one who has just sneezed, perhaps as a tribute of respect to a sign of mortality. The English 'How do you do?' the French 'Comment vous portez-vous?' the German 'Wie geht's?' are mere

forms that one uses without waiting for or thinking of the answer, just as the Spanish custom of offering to a visitor anything he happens to admire in one's house is expected to be answered by a ceremonious form of refusal. Many phrases are used which may have once expressed inferiority, but are now mere forms without meaning. The Chinese in particular have an elaborate vocabulary of complimentary epithets for the person addressed, and depreciatory terms for themselves. A wife calls herself 'a mean concubine;' the speaker's opinion is 'the stupid opinion,' his house 'the tattered shed;' your father is 'the honourable grey-beard,' 'the honourable severity;' your mother, 'the good gentleness.' Even a simple question takes a ceremonious and complimentary form, as, for example, 'To what sublime religion do you in your wisdom belong?'

An interesting chapter in the study of salutations is the history of the pronouns of address in the modern European languages. In English the use of the plural for the singular form was established as early as the beginning of the 14th century. In old English *ye* was always used as a nominative, and *you* as a dative or accusative—a distinction carefully observed in the Authorised Version of 1611. In Shakespeare's time, as Abbott points out, *thou* was proper from superiors to inferiors, and as expressing companionship, affection, permission, or of contempt and anger towards strangers; *ye* and *you*, again, are proper from a servant to a master, and as expressing compliment, submission, or entreaty. Thus, says Schmidt, the constant address of Venus to Adonis is *thou*, of Adonis to Venus *you*. Tarquin and Lucrece, being both in a state of extreme emotion, constantly address each other with *thou*. The swaggering host in *Merry Wives* uses *thou* to everybody, as long as he is in his pride, but *you* when he is crestfallen. In a solemn style even princes are addressed with *thou*, whereas Falstaff uses *you* even to Jove. But already *thou* had fallen somewhat into disuse, and being archaic was naturally adopted in the elevated language of poetry and prayer.

Similarly in German usage *du* ('thou') is no longer used in address, save in domestic or familiar intercourse, or sometimes to convey the deliberate familiarity of insult or contempt; *ih*r ('ye') in modern usage is only employed in addressing more than one of such persons as may singly be addressed by *du*. The singular pronouns of the third person, *er* ('he'), *sie* ('she'), once used in customary address, are now proper only from a superior to an inferior. At present the pronoun of the third person plural, *sie* ('they'), and its possessive *ih*r ('their') are alone allowable in the sense of 'you,' 'your,' whether in addressing one person or more. When thus used they are written with capital letters, and the verb with *Sie* is always in the third person plural, whether one person or more is intended, although a succeeding adjective is singular or plural according to the sense.

In Italian the personal pronoun *Tu* is used only in poetry, or in addressing persons of the lowest rank. To inferiors or to equals it is proper to use *voi*; but when respect is to be implied, *vossignoria*, or the feminine pronoun *ella*, which is always referred to it either expressed or understood.

In Roumanian conversation it is usual, instead of using the direct personal pronouns *tu* ('thou') and *voi* ('you'), to use the compound words *dumneata*, *dumneavostred*, derived from *domnia ta* ('thy lordship'), *domnia vostra* ('your lordship'). These words have thus become personal pronouns, and the latter is also used for the singular.

In Spanish *tú* is used only to the nearest relatives, dear friends, little children, and menials. *Vos*, once generally used, is now confined to persons of high

rank or office, addressing their inferiors. Public speakers use the form *Vosotros*; and where the audience is entitled to it, *Usias* ('your Lordships'). *Usted* (contr. from *Vuestra Merced*, 'your Honour', or 'your Worship') is the only word used in common polite intercourse. *Usted* and its plural *Ustedes* are common to both genders, and agree with the verb in the third person singular or plural, according to the number. At present *Usted* in writing is represented by *V.*, *Ustedes* by *VV.* or *Vs.*

See the articles ADDRESS (FORMS OF), KISS, KOTOW, TOAST, &c.; also the chapters on 'Gesture-language' in Tylor's *Early History of Mankind* (1865); Herbert Spencer's *Ceremonial Institutions* (1879); the *Cornhill Magazine* for November 1879; and E. B. Tylor in *Macmillan's Magazine* for May 1882; and generally such books as Waitz's *Anthropologie der Naturvölker*.

Salute is a compliment paid in the Navy and Army when a royal or other distinguished personage presents himself, when squadrons or armed bodies meet, when officers are buried, and on many other ceremonial occasions. There are several modes of saluting: firing great guns and small arms, dipping colours, flags, and topsails, presenting arms, manning yards, bugle sounds, &c. A royal salute consists in the firing of twenty-one great guns, in the lowering by officers of their sword-points, and the dipping of the colours. A form of salute of more frequent occurrence is when a soldier 'presents arms' or touches his cap to an officer.

Saluzzo, a city of Northern Italy, at the foot of the Alps, 42 miles by rail S. by W. of Turin. It contains a semi-Gothic cathedral, built in 1480, with the tombs of the old marquises of Saluzzo, their old castle (now a prison), and the ruined abbey of Staffarda (1131-1737). Silvio Pellico was born here. It manufactures silk fabrics, leather, and hats. Pop. 9716.

Salvador, the smallest but by far the most thickly populated of the Central American Republics, consists of a strip of territory stretching along between Honduras and the Pacific, and bounded on the W. by Guatemala, and on the E. by Fonseca Bay, which separates it from Nicaragua. It is 140 miles in length by about 60 in average breadth, and has an area estimated at 7225 sq. m., with a population (1895) of 803,550, or 111 to the square mile. The formation of the country is easily described. Except for a rich, narrow seaboard of low alluvial plains, Salvador consists of a level plateau, some 2000 feet above the sea, furrowed by river valleys and broken by numerous volcanic cones, and bounded along the northern frontier by a portion of the Central American Cordillera. Of the volcanoes, which rise from 4900 to 6900 feet, many are extinct, but others break into eruptions at intervals, and Izalco, at least, near Sonsonate, has been in constant eruption for more than a century. Earthquakes, of course, are of frequent occurrence (see SAN SALVADOR). Of the rivers, all of them flowing towards the Pacific, the most important are the Lempa (140 miles), which receives the surplus waters of the Laguna de Cuija—a large lake on the borders of Salvador and Guatemala—and the San Miguel, which drains the south-east portion of the republic. The former, though a rapid stream, might be made navigable for steamers for a great part of its course. The climate is equable, very healthy in the interior, and even along the coast less unwholesome than on the Atlantic side of Central America. The land is well watered, and the soil exceedingly fertile: in the neighbourhood of the capital four crops of maize are grown in the year. Agriculture is extensively carried on (largely by small proprietors), to the

almost total exclusion of pastoral pursuits—though fine cattle are raised near Sonsonate. The principal products are coffee, indigo, and balsam; less important are tobacco, sugar, maize, rice, and beans. The balsam, known as the Balsam of Peru (see BALSAM), grows only in the part of the seaboard near La Libertad, known as the Balsam Coast. India-rubber, vanilla, ornamental woods, and other products of the forest are also exported. The forests present a less dense vegetation than on the Atlantic side, and beasts of prey, such as jaguars and pumas, are seldom seen. As a mining country Salvador is not of importance, although both gold and silver are mined near La Union, and coal and iron have been found and to some extent worked. Manufactures of any consequence have not yet been introduced. An active trade is carried on, and many foreign houses are represented or settled in Salvador. In 1888 the imports amounted to £604,673, in 1896 to £1,925,925; the exports in 1888 were £993,634, and in 1896 £1,481,431. Of the imports in 1896, £386,107 (cotton goods, iron, and woollens) were from, and of the exports £160,408 (coffee and dye-stuffs) went to, Great Britain. The remainder of the trade is principally with the United States, France, and Germany. In 1896, 338 vessels entered and cleared at the ports of the republic.

The bulk of the population is composed of Indians and mixed races: the whites number scarcely 20,000. The Indians are of the Aztec (Pipil) race, and all speak the Spanish language and profess the Roman Catholic religion (the one established by statute), except on the Balsam Coast, where alone they retain their old habits and language. The government is carried on by a president (four years) and four ministers. The legislature consists of a congress of seventy deputies (forty-two of them proprietors), elected by universal suffrage for one year. Education is free and compulsory, and in 1895 there were 600 primary schools (with 30,000 pupils) and 15 secondary and 2 normal schools in the state, besides a university and a polytechnic institute in the capital, San Salvador. Justice is administered by a supreme court and several subordinate courts. The revenue in 1888 was £562,179, and in 1896, £1,507,259; the expenditure in 1888, £420,013, and in 1896, £1,185,000. The internal debt was returned in 1896 as £1,185,185, and the external debt at £254,000. There is a standing army of 4000 men and 18,000 militia. Railways connect Acajutla (the chief port) with the inland towns of Santa Anna and Ateos, and Ateos with Santa Tecla. Other railway lines are in course of construction. There are over 2000 miles of good roads, 1724 miles of telegraph, and 597 miles of telephone wires. Salvador joined the postal union in 1879.

Salvador, originally called *Cuscatlan*, was conquered after a long and obstinate contest by Pedro de Alvarado in 1525-26. In 1821 it threw off the Spanish yoke, and from 1823 to 1839 it belonged to the Central American confederacy. Since 1853 it has been an independent republic, and from 1864 till 1890 it had freedom from foreign wars, though *pronunciamientos* too often signalled presidential elections. A brief war with Guatemala arose in 1890, on a proposed treaty of union between the five Central American States; and in 1894-96 Salvador, Guatemala, Nicaragua, and Honduras had provisionally united into a Central American Republic (without Costa Rica), afterwards dissolved.

See Scherzer, *Wanderungen durch die mittelamerikanischen Freistaaten* (Brunn, 1857); Bates, *Central America* (1879); Guzman, *Apuntamientos sobre la geografia física de la rep. del Salvador* (San Salv. 1883); Reyes, *Nociones de historia del Salvador* (San Salv. 1886).

Salvage is the compensation made by the owner of a ship or cargo in respect of services rendered by persons, other than the ship's company, in preserving the ship or cargo from shipwreck, fire, or capture—the perils to which property at sea is peculiarly exposed. By statute, salvage is now also due for the saving of the lives of persons on board British ships. In the earliest maritime codes, such as the laws of Rhodes, Oleron, and Wisby, salvage was recognised; and it is similarly allowed by all modern maritime states. At common law the person who saves goods from loss or imminent peril has a lien upon them, and may retain them till the salvage is paid. Further, if the salvage is performed at sea, or within high and low water mark, the Admiralty Division of the High Court has jurisdiction, and the salvors may enforce their claim by the institution of an action *in rem*. The Court of Admiralty also takes care of the property pending the issue of the suit, appraises the ship or goods, fixes the sum to be paid in name of salvage, apportions the sum among the salvors or sets of salvors, and, if necessary, may direct a sale of the goods and a division of the proceeds between the salvors and the proprietors. In the case of recapture from an enemy, the rate of salvage is fixed by statute at one-eighth for the royal navy and king's armed ships, and one-sixth for private ships; in other cases, however, the rate is either fixed by agreement between the parties or is left entirely to the discretion of the judge, and varies with such special circumstances as the labour and peril of the salvors, &c. It is provided by statute that all goods saved from shipwreck in the United Kingdom are to be delivered to the Receiver of Wrecks appointed by the Board of Trade; and it is within the power of this official to detain them till satisfaction is made of the salvage, or till security is given for its payment. The crew of a ship are not entitled to salvage or unusual remuneration for any extraordinary efforts they have made in saving her; but when their duty as seamen is over—as by capture—any successful effort thereafter made by them to rescue the ship entitles them to salvage. *Salvage Loss*, in marine insurance, is a method of adjusting the loss by deducting the proceeds of the sale of the damaged goods from the original value of these goods, as represented by the invoice price. See **WRECKS, DERELICT**; and H. Newson's *Laws of Salvage, Tonnage, and Pilotage* (1886).

Salvatierra, a town of Guanajuato, in Mexico, on the Rio Lerma, 197 miles by rail N.W. of Mexico city. It has two cotton-factories, and a population of 10,300.

Salvation Army, a new religious organisation, which took its rise in England in 1865, its founder being the Rev. William Booth (q.v.). Being in some sense a rebound from the less vigorous forms of Christianity, this movement has from the first been of a very aggressive and practical character. In theory and creed, save on some minor points, the Salvationist is at one with all the orthodox churches, but in method and organisation the army differs largely from every existing denomination. The neglected spiritual condition of the lower part of the population of London first appealed to the heart of Mr Booth; and after various efforts at conciliating the sympathy of other Christians had been rejected, and tentative lines of an old-fashioned sort had been found abortive, Mr Booth determined to strike out a new method and to adopt a quasi-military organisation, of which he himself would be the general. 'Groping,' he writes, 'our way out of the conventionalism in which we had been trained, we tried committees, conferences, and all sorts of governments,

showing how far we were wrong, until the military idea was revealed to us.' Mr Booth was powerfully reinforced by the co-operation of his wife, who eloquently denounced the cold Laodiceanism of the churches. At Hastings, Margate, and Brighton, and in St James's Hall in London, crowds of the upper and middle classes became her auditors and presently her ardent supporters, to help on the movement, which was called the 'Christian Mission.'

In the spring of 1878 the entire mission was re-organised on the model of a military force with the title of 'The Salvation Army,' and as its head Mr Booth was henceforth designated 'general.' The novelty of the new designation at once attracted the notice of the press, some to approve and others to oppose; but the object was gained—viz. to attract and compel public attention to the grand question of salvation. The mission at once rose from comparative obscurity to a position of strength and public support. Since that time the advance has been almost like the rise of a city in the Arabian tales. No doubt can be felt but that the army's attitude and object answered real and wide-spread needs of men's hearts. From eighty positions or 'corps' in the first year (1878), and 127 labourers or 'officers,' the organisation in 1897 numbered over 6700 corps and outposts, and above 12,000 officers. In 1891 the officers were distributed as follows:

	Officers.
Canada and Newfoundland.....	1,072
United States, California, and South America.....	1,331
Australia and New Zealand.....	1,364
India and Ceylon.....	497
South Africa and St Helena.....	201
France, Switzerland, and Italy.....	441
Scandinavia.....	865
Holland, Germany, and Belgium.....	307
Great Britain.....	4,539
Total.....	10,617

So mightily grew this movement, spreading itself over the whole world, that at the present time it has struck its roots and become naturalised in thirty-five countries in every quarter of the globe. Indeed, it seems to be a native of no particular race or colour or clime, but to adapt itself and make itself at home almost universally. A country is geographically mapped out into 'districts' or dioceses, each under the care of an experienced officer generally called a 'major.' Every large town and even large village in that district is occupied by one or more corps commanded by a captain, assisted by one or more lieutenants, all of these being supported and entirely employed by the army, their duty being to conduct everyday services indoors and out-of-doors, to visit those enlisted, and to plan, to advertise, and push on the attention of all around the salvation of their souls. Open-air services are held daily in the streets or market-places, and processions, accompanied by banners and bands of music; multiplied indoor services keep the attention of the public and employ the zeal of all the members; these are enlivened with bright and animated choruses, short addresses, and pointed appeals. Marriage between members is solemnised 'under the Flag,' when each pledges the other to be faithful to the War, and never to hinder the spouse from fighting and even suffering for Christ's sake. The officers can marry the parties in Scotland and America, but in England the registrar must be present. Children of members are in their infancy dedicated to become future soldiers in the War for God and souls before the whole congregation. While strict acquiescence with superior orders is expected on the part of officers and soldiers alike, the greatest freedom is conceded in spiritual matters, and the Salva-

tionist boasts of a freedom which is the offspring of order and method. Solidarity of principles and of government once secured, the largest variety can be fully used as to details. Thus the uniform in one land differs from that adopted in another. The blue dress and bonnet of Great Britain is replaced in India by the white sheree. The unity of the spirit is maintained by diversity of operation. Every Salvationist, man, woman, and child, is taught and expected to propagate salvation; to speak for God privately and in public, to sing, to pray, to march, whenever required; to testify and to exhibit conversion to Christ in their lives, and to bring every one around them to deliverance from sin. The officers, however, are set apart and entirely maintained so as to devote themselves wholly to the work of souls. These are drawn from all ranks, with no distinction save of spiritual qualifications; the training given them is not in secular but in spiritual knowledge—viz. in the word of God, in fervour, in devotion, and in the best ways to reach souls. They are solemnly set apart with prayer when commissioned to their first appointments.

In regard to doctrine and teaching the army is very much in agreement with the Christian churches generally; emphasising the work of Jesus Christ as the sole and sufficient atonement from sin, and the application of that atonement to the heart by faith; offering at the same time the most drastic opposition to every form of Antinomian teaching; inculcating the universal obligation of believers to receive full and entire sanctification by the Holy Ghost. They believe the Bible to be God's written word, and repudiate in the strongest manner modern theories and criticisms which diminish or degrade its divine authority. Salvation from sin is with them a solid experimental reality effected by God's grace in the consciousness and in the conduct. Vigorous and untiring war is proclaimed against all Satan's strongholds; denouncing unsparingly the liquor traffic (all are bound to be abstainers), racing, theatre-going, gambling, Sabbath-breaking, and the living a life of ease and pleasure. They regard it as a sacred duty binding on Christians not to eat their crust of salvation by themselves, but to force the claims of God on the attention of all, to assail, warn, and awaken to repentance the unsaved. Woman takes her rightful place, and parity of privilege, position, and dignity is firmly asserted and maintained for the weaker sex. For this service the poorest brother who can hardly read is as eligible as the cultured, and woman is as eligible as man. Indeed, it is a maxim in the army that there is no position filled by man which may not be equally filled by woman. The ability and piety of the individual will alone determine his or her position. The administration of the sacraments is not provided for officially, but the observance is left optional to the members.

All the property of the army is conveyed to, and held by the general for the time being, for the benefit of the army exclusively, he being constituted a trustee of the property, in the disposal of which, and in the appointment of his successor, he is placed under the government of a deed poll enrolled in Chancery on the 13th August 1878. The finances of the army are derived partly from the voluntary offerings in their places of worship, from gifts of friends, and from the profits of the periodicals, of which the *War Cry* is the best known issued by the army press. At home and abroad the army publishes and distributes, mainly by the agency of its own members, forty illustrated papers and magazines (in the several vernaculars as well as in English), and with other books, pamphlets, and song-books, the annual sales are

about sixty million copies! A system of accounts of a very strict character is pursued throughout the army, and the yearly accounts are published, after being in detail examined and audited by a firm of London accountants.

The master purpose of these Christians is the converting men to God and saving them from sin. The master policy adopted by them in this cause is self-sacrifice. The adherents of the army, 'rank and file,' display hardihood and endurance, a defiance of difficulties, indifference to ease or reputation, self-abandonment and joy in tribulation. Persecuted by authorities, mobbed, bruised, imprisoned, men, and even delicate women, make light of their sufferings for Christ's sake, and if disabled their places are immediately filled by fresh volunteers. One week in every year is set apart for acts of special self-denial, when every member and friend of the Salvation Army is expected to deny himself or herself some comfort or item of unnecessary expenditure, and to give the value of the same to the funds of the army. In the year 1890 the sum so saved and contributed was £33,000, of which the members, poor as they are, gave nearly £30,000 (in 1891 £40,000).

During the year 1890 a large development took place in the *benevolent and philanthropic* work of the army. A scheme for uplifting the out-of-work and homeless multitudes contained in the book entitled *In Darkest England and the Way Out*, from the pen of General Booth, attracted wide public attention, and large sums were contributed, enabling him to put it into operation. A threefold or three-storied system of help was therein proposed for this class, whereby the outcast is first of all to be received into a city colony, found shelter and food, and offered work of some kind; if found really willing to do work and to do right he is then sent to the 'farm colony'; and, if worthy and suitable, is finally shipped to the 'colony over the seas' as an emigrant. In pursuance of this scheme, in 1896 the army had already in operation at home and abroad 27 Homes of Rest, 67 Rescue Homes (for fallen women), 87 Slum Posts, 17 Prison-gate Homes, 77 Shelters and Cheap Food Depôts for the Homeless, 30 workshops and factories, 31 labour bureaux, 7 farms (the principal at Hadleigh in Essex), besides salvage, emigration, bank, and law departments, and laundries and other women's factories. The cheap meals supplied during twelve months numbered nearly 3 million. The organisation has found a footing in many provincial towns at home, has a strong position in Scotland, and extends into 45 countries and employs 35 languages. As promotion, a step upward socially, there is added to the shelter the Poor Man's Hotel or 'Metropole,' a superior kind of accommodation for which a charge of 6d. is made. Applicants at the shelters having no money can work for their food in the adjacent workshop. For the purposes of this salvage work extensive premises known as the Bridge Wharf, Battersea, have been acquired; and there is to be a thorough and systematic collection of old clothes, rags, bones, broken meat, bottles, tins, &c., all of which it is said can be profitably utilised. Incomplete as has been this brief description of the Salvation Army and summary of its chief activities, it will contain evidence enough to satisfy any reader that it is a most remarkable religious movement.

For further information see Booth, *Aggressive Christianity* (1882; 5th ed. 1890), and *In Darkest England and the Way Out* (1890); Mrs Booth, *Popular Christianity* (1888); Railton, *Twenty-one Years' Salvation Army*, and *Heathen England and the Salvation Army*; Josephine E. Butler, *The Salvation Army in Switzerland* (1884); and numerous pamphlets published by the army. See also the article BOOTH (WILLIAM).

Salvator Rosa. See ROSA.

Salve Regina, the first words of the antiphon, addressed to the Blessed Virgin Mary, said after Lauds and Compline, in the Roman Catholic Church, from Trinity to Advent. It dates from the 11th century, but first found a place in the Breviary of Cardinal Quignon (1536), and thence was adopted into that of Pope Pius V. (1568).

Salviati, ANTONIO. See MURANO.

Salvini, TOMMASO, tragedian, was born at Milan, 1st January 1830, his father and mother both being actors. The boy, who showed early aptitude, was trained under Modena, a distinguished player, and became well known as a member of Ristori's company. In 1849 he fought with distinction in the revolutionary war; and returning to the stage played with eminent success as *Edipus* in a play written for Salvini by Nicolini, and as *Saul* in Alfieri's drama. In Paris he played in these, in Racine's plays, and as Shakespeare's *Othello*—the part with which he is identified in the minds of English playgoers. He scored successes in Brussels and Madrid, and visited the United States in 1874, England in 1875, with as great *éclat*. But after another visit to the United States in 1881, and to Britain in 1884, he retired from the stage to enjoy a life of learned leisure in his villa near Florence. Amongst his most striking parts were—besides *Othello*—*Hamlet*, *Macbeth*, and *Lear*. See *Leaves from the Autobiography of Tommaso Salvini* (1893).—His son Alexander adopted his father's career, and inherited much of his talent.

Salvinia, a genus of the order of plants formerly called Rhizocarpeæ or Pepperworts, now known as the Heterosporous Ferns. They are 'ferns' because, amongst other reasons, the development of the embryo is similar to that process in the common ferns, and 'Heterosporous' because the sporophyte bears two kinds of spores instead of one. To understand these plants it is necessary to know the structure of Ferns (q.v.). The order includes two families, the Salviniaceæ and the Marsiliaceæ. The former consists of two genera, *Salvinia* and *Azolla*, the latter also of two genera, *Marsilia* and *Pilularia*. The spore-bearing generation of *Salvinia* is a plant that floats on the surface of water. The stem bears on its upper

form small berry-like objects. In *Marsilia* the sori are borne upon fertile leaves which branch from infertile leaves just above their insertion. The fertile leaves are folded in like pea-pods, and each of them encloses several sori. The sori of *Pilularia* are similar, but globular. The sori of *Salvinia* and of *Azolla* are of two kinds. Some contain numerous long-stalked microsporangia with male spores; others contain fewer (in *Azolla* only one) short-stalked female macrosporangia with female spores. In *Marsilia* and *Pilularia* the macrosporangia and microsporangia occur within the same sori. The microspores develop into rudimentary filamentous male prothallia. The antherozoids are formed in two cells at the apex of the filament,

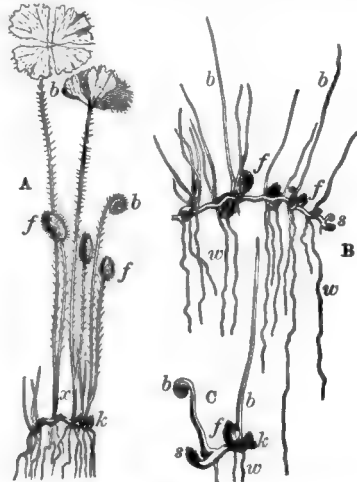

Fig. 2.

A, *Marsilia salvatrix*, anterior portion of stem with leaves; k, terminal bud; b, leaves; f, f, sporocarps springing from leaf-stalks at z. B, *Pilularia globulifera*; s, terminal bud of stem; b, leaves; w, roots; f, sporocarps. C, the extremity magnified; k, the lateral bud. (After Goebel.)

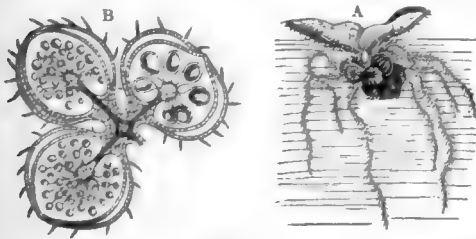

Fig. 1.

A, transverse section of the stem of *Salvinia natans*, showing aerial leaves and submerged leaf, with sporocarps. B, longitudinal section through three fertile teeth of a submerged leaf, one sporocarp with macrosporangia, two with microsporangia. (After Goebel.)

surface four rows of aerial leaves, and on its under surface two rows of submerged aquatic leaves, which have the outward form and functions of roots; there are no true roots at all. The stem of *Marsilia* creeps along the surface of marshy land, or on the bottom below the water. The upper surface of the stem bears two rows of leaves with long stalks, the under surface bears roots. *Pilularia* has peculiar narrow leaves. In *Salvinia* the sori or groups of sporangia are placed upon the aquatic leaves near the insertion, whence the old name Rhizocarpeæ. The coverings or indusia

which represent the antheridium. The macrospores develop into female prothallia which never grow more than to project a little from the spores; they bear archegonia. The oosphere within an archegonium is fertilised by an antherozoid, and produces an embryo. The Heterosporous Ferns are interesting as showing a stage in that reduction of the prothallium as an independent plant which reaches its climax in the Seed Plants. See FERNS, OVULE, and PHANEROGAMIA.

Sal Volatile, a well-known remedy for faintness, consists essentially of a solution of carbonate of ammonia in alcohol. It contains in addition free ammonia and the volatile oils of lemon and nutmeg. As it is a strongly caustic liquid, it should never be taken unless well diluted with water. See SALTS (SMELLING), and AMMONIA.

Salween, a river of Asia that flows south through the Shan country, then between Siam and British Burma, and flows into the Gulf of Martaban a little below Maulmain. It is navigable for only about 80 miles up from its mouth; its bed is then interrupted by rapids and the dangerous ravines through which it passes. The Chinese call it the Lukiang; they also give the same name to the Tibetan Giama Nu-chu. It is, however, uncertain whether this last, which has a course of some 700 miles through Tibet, and whose course is known down to 27° 45' N. lat., is the upper part of the Salween or the upper part of the Irawadi (q.v.). The course of the Salween (also spelt *Salwen*, *Salwin*, and *Salouain*) is known only

as high as 25° N. lat. The question can only be settled when the gap of 2½ degrees has been explored. See the discussion in *Proc. Roy. Geog. Soc.* (1887).

Salzbrunn, a group of three villages (New, Lower, and Upper Salzbrunn) in Prussian Silesia, 40 miles by rail SW. of Breslau; they have eight mineral springs, which attract nearly 4000 visitors in the season. The water is alkalo-saline; some 1,100,000 bottles are exported every year. There are glass and porcelain factories, yarn-spinning works, brick-works, and coal-mines. Pop. 6459.

Salzburg, a crown-land of Austria, bounded on the W. by Bavaria and Tyrol, on the S. by Carinthia, and on the E. by Styria. Area, 2762 sq. m.; pop. (1880) 163,570; (1890) 173,510. It lies on the northern face of the eastern Alps, and is a mountainous region, reaching altitudes of 12,000 feet in the Hohe Tauern. Snow-fields and glaciers cover 115 sq. m. in the more elevated regions. The river Salzach (190 miles), a tributary of the Inn, flows east and then north through one of the most picturesque of the Alpine valleys, and drains the greater part of the crown-land. The climate is variable but healthy. Two-fifths of the surface are covered with forests, and two-fifths consist of Alpine meadows. The rearing of cattle and horses is an important branch of industry. Salt is obtained in large quantities, especially at Hallein (q.v.). Iron, copper, gypsum, and marble are mined. The hot springs of Gastein (q.v.) are widely celebrated.

SALZBURG, the capital, occupies a charming situation on the Salzach, by rail 195 miles W. by S. of Vienna and 80 miles E. by S. of Munich. At this point the river passes between two extensive but isolated masses of rock (1716 and 2133 feet), one of which, the Mönchsberg (Monk's Hill), is crowned by the old citadel, dating originally from Roman times, but frequently rebuilt. These hills and those that close in the valley are picturesquely wooded. The river divides the city into two parts; on the west is the old city, with many dark, winding streets, getting access to the valley and plain on the north through a gallery (440 feet long, 39 feet high, and 23 feet wide), hewn (1767) in the solid rock of the Mönchsberg. This portion of the city contains the fine cathedral, with a white marble façade, and built (1614-34) in imitation of St Peter's at Rome; the Romanesque abbey church of St Peter (1127), in the graveyard of which are old monastic cells and a couple of chapels hewn out of the Mönchsberg, besides the chapel of St Margaret (1485); the palace of the Grand-duke of Tuscany, in the Italian style (1592-1725); and the former grand stables (now barracks) of the archbishops, partly constructed of marble (1607); the Benedictine monastery, with a valuable library of some 65,000 vols. and 900 MSS.; and the archbishop's palace. On the opposite bank—both banks are laid out as tree-shaded drives and promenades—lies the modern town, with Italian-looking, flat-roofed houses; here the most prominent buildings are Castle Mirabell (1607), the former summer-residence of the archbishops; the Capuchin monastery (1599), and St Sebastian's Church (1505-12), with the monument of Paracelsus. The city possesses also a theological faculty, all that remains of the former university (1623-1810); a public library (1617) of 82,000 vols. and 1400 MSS.; a museum of Celtic and Roman antiquities, &c.; a bronze monument (1842) to Mozart, a native of the place; a new park on the east bank; the government buildings (1588); the town-house (1407), &c. Industry is not much developed, being confined chiefly to the manufacture of musical instruments, marble ornaments, &c. Pop. (1890) 27,741. The

city stands on the site of the Roman settlement *Juvavum*, which was ruined by the Goths and Huns. The nucleus of a new city was made by St Rupert of Worms, who established a monastery here in the 6th century. Boniface made it a bishop's seat in the 8th century, and in 798 it was elevated to an archbishopric. The archbishops had a seat and vote in the German diet, and were perpetual legates of the pope, primates of Germany, and princes of the empire. They were generally noted for their ecclesiastical severity; in 1498 the Jews were expelled from the archbishopric; in 1525 the peasantry rose in revolt; in 1732, after five years' bitter persecution (in spite of all friendly efforts on the part of the Protestant princes of Germany), 30,000 Protestants left their homes (as illustrated in Goethe's *Hermann und Dorothea*) and settled, on the invitation of Frederick-William I., in Prussia, mainly in Lithuanian districts that had been desolated by plague. The archbishopric was secularised in 1803, and given to the Grand-duke of Tuscany, he being made an electoral prince. The archbishopric was re-erected in 1824. Except for a short interval (1810-14), it has belonged to Austria since 1805. Since 1849 it has formed a separate crown-land of the Austrian empire.

See Zauner and Gärtner, *Chronik von Salzburg* (11 vols. 1797-1827), and Zillner, *Geschichte der Stadt Salzburg* (1885).

Salzkammergut, called the *Austrian Switzerland*, one of the most picturesque districts of Europe, lies wedged between the Austrian crown-land of Salzburg on the west and Styria on the east. Area, about 230 sq. m.; pop. 17,500. The scenery combines in rare beauty the features of valley, mountain, and lake. The highest peak, the Dachstein, reaches an altitude of 9830 feet. But the district derives its principal attraction from its lakes, the most famous of which are Hallstatt, Traun or Gmunden, Atter, St Wolfgang, Aber, Mond, and Zell. It derives its name of 'Salt-exchequer Property' from its salt springs and mines, which yield some 80,000 tons of salt annually. The chief seats of the salt-works are Ischl (q.v.), Hallstatt, and Ebensee. Cattle-breeding and the timber trade are almost the only other industries.

Salzwedel, an old town of Prussian Saxony, 72 miles by rail NW. of Magdeburg, with manufactures of sugar, linen and woollen fabrics, needles, chemicals, &c. Pop. 8883.

Samar, an irregular island of the Philippines, SE. of Luzon. Area, 5000 sq. m. It has lofty and rugged mountains, is thickly wooded, and yields coconuts, rice, abaca, &c. Capital, Catbogan, on the west coast. Pop. about 200,000.

Samara, a town of European Russia, on the left bank of the Volga (of which it is a chief river port), 656 miles by rail ESE. of Moscow. It has a large trade in corn, salt, tallow, timber, &c., manufactures of tobacco, soap, and tiles, and a Koumiss (q.v.) establishment, to which several hundred consumptive patients each year resort. It is the seat of a bishop. Pop. (1869) 34,500; (1880) 51,947; (1897) 91,672.—The government has an area of 58,302 sq. m. and a pop. of 2,763,478, including 100,000 Germans living in agricultural colonies.

Samara, a dry indehiscent, usually one-sided fruit, with a wing—as in Ash (q.v.), Elm (q.v.), and Maple (q.v.)—the last a *double samara*.

Samarang, a seaport on the north of Java, 255 miles E. of Batavia, is the principal port for the trade of Middle Java. Since 1873 it has been connected with Jokjokarta and Surabaya by railway. The European quarters have all the appearance of a typical Dutch town. The more important buildings are a military hospital (550 beds), the town-house (1854-64), and Christian churches and

schools. A fort and a coast-battery provide defence for the town. The river is silted up at its mouth; but a canal, constructed in 1879, serves as a harbour. The roadstead is exposed during the west monsoon. Pop. 69,894.—The *residency* has an area of 1998 sq. m. and a pop. of 1,376,806, and produces rice, coffee, sugar, tobacco, and timber.

Samarcan, a city of western Turkestan, stands in the valley of the Zerafshan, about 4 miles S. of that river, and amongst the western spurs of the Tian-Shan Mountains, 130 miles E. by S. of Bokhara and 150 miles N. by E. of Balkh in Afghanistan. It is the ancient *Marcanda*, the capital of Sogdiana, which was taken and destroyed by Alexander the Great. It was again captured in 712 A.D. by the Arabs, who supplanted the Græco-Bactrian civilisation, of which it was the centre, by the creed and customs of Islam. Ever since that time it has been a sacred city in the eyes of the Moslems, especially after the conqueror Timur made it the capital of his kingdom in the 14th century. It had, however, suffered terribly from Genghis Khan, who took it (1219) and destroyed three-fourths of its half a million inhabitants. In Timur's time it had a population of 150,000. Its best and handsomest buildings, as the Ulug-beg *madrasa* or College, the tomb of Timur, the tombs of his wives, the gigantic stone he used as a throne from which to dispense justice, and his audience-hall, date from the reign of the great conqueror or his immediate successors. The Ulug-beg, the graves of Timur and his wives, as well as the tomb of one of the Prophet's companions, and two other colleges, the Tilla-Kari and Shir-dar, both dating from the beginning of the 17th century, are magnificent structures, grandly decorated with arabesques, enamelled tiles of different colours, marble pavements, inscriptions in gold, and similar rich ornamentation. In the 15th century Samarcan was renowned as a school of astronomy and mathematics. After the decay of Timur's empire the city had a chequered history, figuring in most of the wars that raged in that region, until at last it fell into the hands of the emirs of Bokhara, from whom it was taken by the Russians in 1868. They have established themselves in the citadel, built on a steep hill 4 miles in circuit, and have laid out a new town, with broad and handsome streets, to the west of it. On the other side of the citadel is the old city, walled, with dark and narrow streets, and dirty houses. The ruins of still more ancient Samaricans extend for 3 miles or more to the west and north of both the Russian and the native town. Since 1888 Samarcan has been connected by rail with Merv and the Caspian Sea, and by telegraph with Bokhara. Pop. of the city (1897) 54,900, mostly Tajiks and Uzbegs (Sarts), with a strong garrison of Russians. The people carry on gardening, their gardens being irrigated by water drawn off from the Zerafshan, and the manufacture of textiles, harness, gold and silver wares, leather, pottery, boots, &c., and conduct a brisk trade in cotton, silk, fruits, wheat, rice, salt, and horses.

Samaria, the capital of the northern kingdom of Israel, after Israel (the ten tribes) and Judah became two independent states. It was founded by Omri, on a commanding site, about 5 miles N.W. of Shechem, and near the middle of Palestine. It stood on the long flat summit of an isolated hill (1450 feet), that was reached by a succession of terraces, and itself commanded a magnificent view on all sides. Consequently it was easy to make it a place of considerable strength; the Syrians indeed laid siege to it unsuccessfully more than once during the following reigns. But about 721 B.C. it fell before the three years' persistency of

the Assyrian monarchs, Shalmaneser and Sargon. These potentates carried away nearly all the Hebrew inhabitants of Samaria and the country of the Israelites, to which it had by then given its own name, captive into Babylonia. In their place they sent Assyrian colonists, from Babylon, Hamath, Sepharvaim, and Cuthah; hence the Jews call the Samaritans 'Cuthæans.' The new settlers, whilst retaining a good deal of their heathen forms of worship, adopted many of the characteristic religious practices and beliefs of the remnant of the Israelites amongst whom they dwelt. When the Jews returned from the Captivity and set about the rebuilding of the temple under the leadership of Ezra, the Samaritans came desiring to participate in the work. But the Jews rejected their assistance, and would not permit them to have any part or share in the revival of the worship of Jehovah, on the ground that they were unorthodox and condoners of idolatry. This of course caused an estrangement between the two sections of the nation, and the Samaritans tried to prevent the Jews from fortifying their new city. The breach seems to have grown suddenly wider after the expulsion in 432 B.C. from Jerusalem of a member of the high priest's family and a son-in-law of Sanballat, the civil governor of the Jews. Not many years later the Samaritans, augmented from time to time by numbers of renegade Jews, built (409 B.C.) on Mount Gerizim beyond Shechem a sanctuary to Jehovah intended as a rival to the temple at Jerusalem. This converted them into bitter enemies, so that henceforward, at all events for very many years, the 'Jews had no dealings with the Samaritans,' and the Samaritans none with the Jews. At some time during the growth of this enmity between the two peoples, the Samaritans introduced the revised Pentateuch of Ezra as their religious code-book, and became extremely strict and puritanical in the observance of its laws. Of the prophets and other historical books of the Old Testament they had no knowledge. Thus they began a separate religious development from that of the Jews. In contrast to the Jews, they had no belief in the resurrection or in a Messiah, and gave no tithes to their priests; but in common with the Jews, especially the Talmudic sects, they practised circumcision, observed the Sabbath, kept up synagogues, and entertained beliefs as to the existence of demons and other superstitions. Yet they never made much real headway; and at the present day there do not survive more than 150 of them, collected at Nablus, the ancient Shechem. The Samaritan language is an archaic Hebrew, or rather Hebrew-Aramaic, dialect; and in it are written a very ancient version of the Pentateuch (see below), certain chronicles, hymns, and books of religious devotion (see Schürer's *Jewish People*).

Samaria was taken by Alexander the Great, and colonised by Macedonians and Hellenised. They fortified it, and it grew and prospered. Twice it was besieged and taken by the successors of Alexander—viz. by Ptolemy I. (312), and by Demetrius Poliorcetes (circa 296). The Jewish captain John Hyrcanus laid siege to it (circa 110 B.C.), and at the end of a year destroyed it utterly. Nevertheless the Samaritans joined the Jews in offering fierce resistance to the Romans: they entrenched themselves on Mount Gerizim, and only submitted after a desperate and bloody siege. Their city was again destroyed; but the consul Gabinius ordered it to be rebuilt. Augustus gave it to Herod the Great, who refounded it under the name of Sebaste. The Samaritans seem to have been involved in the 'dispersal' of the Jews, as they were well known at Byzantium, at Rome, in Egypt, and elsewhere. Yet some of them remained in the old city, and in

529 revolted against the rulers of the eastern empire. On the ruined site of the ancient place, now called Sebastiya, there still exist parts of a colonnade of the age of Herod, remains of a temple to Augustus, and an old crusading church (now a mosque) built over the tomb of John the Baptist. The tombs of six or eight (Omri, Ahab, Jehu, &c.) of the kings of Israel and those of the prophets Obadiah and Elisha were also at Samaria. See *Memoirs of Palestine Survey*.

Samaritan Pentateuch, a recension of the Hebrew text of the Pentateuch, in use with the Samaritans, and accepted by them as canonical to the exclusion of the other Old Testament writings. That such a recension had once existed had always been known from certain allusions in Origen, Jerome, and Eusebius, and also in the Talmud; but Julius Scaliger was the first modern scholar to suggest that it might still be recoverable, and to point out its possible importance if obtained. Early in the 17th century the famous traveller Pietro della Valle succeeded after much inquiry in procuring at Damascus a copy not only of the original of this Pentateuch of the Samaritans, but also of the ancient translation, or Targum, of this in the Samaritan dialect; both documents passed in 1623 into the hands of the Oratorians in Paris, and were published in 1631 in the Paris Polyglott by J. Morinus. In his *Exercitationes Ecclesiasticæ*, with which Morinus accompanied the Pentateuch of the Samaritans, he placed it far above the received Hebrew text, a view which had a polemical bearing on current theological discussions between Protestants and Catholics about the 'rule of faith,' and led accordingly to prolonged controversy, the principal disputant on the Protestant side being the Zurich theologian, J. H. Hottinger. Both the Samaritan Pentateuch and the Samaritan Targum of Morinus were afterwards printed by Brian Walton in the London Polyglott (1657), with a collation of the various readings of the Massoretic and Samaritan Hebrew texts. Through Ussher and others a number of additional Samaritan codices were brought to Europe in the course of the 17th century, so that Kennicott was able to use for his Hebrew Bible sixteen MSS. more or less complete. The first to arrange the variants in a systematic way, and to determine with any scientific accuracy the kind and amount of authority that can be claimed for the Samaritan recension of the Pentateuch was Gesenius (*De Pent. Sam. origine, indole, et autoritate*, 1815). Its various readings are most of them of a quite trifling nature and do not at all affect the sense, representing merely a different fashion in spelling or grammatical expression; and perhaps the only one that would seem to indicate an essentially different point of view from that of the Massoretic text is the substitution of Gerizim for Ebal in Deut. xxvii. 4. As is well known, the Samaritan Pentateuch varies from the received text in the figures it gives in Gen. v. and xi. and also in Exod. xii. 40, thus presenting a scheme of chronology materially different both from the Massoretic and from that of the LXX. Of the MSS. that have reached Europe none are older than the 10th century. All are written in a peculiar modification of the old Semitic character which used to be spoken of as Samaritan or Phœnician (see ALPHABET), but is now known to have been at one time common to the entire Semitic domain, and also to have constituted the basis of the Greek alphabet. There is no ground, either external or internal, for assigning to the Samaritan Pentateuch an age earlier than the 4th century B.C., though, from its use in northern Palestine, it was formerly argued that it must have originated before the fall of the northern kingdom, or even before the revolt of

Jeroboam. The Samaritan Targum, a translation of the Hebrew Samaritan Pentateuch into Samaritan Aramaic, is hardly older than the 4th Christian century. It was printed in a very corrupt form in the Paris and London Polyglotts, and there is a critical edition by Petermann and Vollers (*Pentateuchus Samaritanus, ad fidem librorum Manuscriptorum apud Nablusianos repertorum*, 1872-91); see also Nutt, *Fragments of a Samaritan Targum* (1874). The Samaritan Targum of Genesis, in Hebrew characters, is given in Heidenheim's *Bibliotheca Samaritana* (1884). There is also an Arabic translation of the Samaritan Pentateuch, made in the 11th or 12th century by Abu Said, based on the work of Saadia. The Samaritan Pentateuch itself can be read in the Paris and London Polyglotts, or in the separate edition, in square Hebrew characters, by Blayney (Oxford, 1790).

Sāmaveda. See VEDA.

Sambhal, an Indian town in the N. W. Provinces, 23 miles SW. of Moradabad; pop. 37,000.

Sambor, a town in Austrian Galicia, on the Dniester, 41 miles SW. of Lemberg. Pop. 13,586.

Sambourne, EDWARD LINLEY, cartoonist, born in London, 4th January 1845, at sixteen was apprenticed to marine engineer works at Greenwich, but in April 1867 began his connection with *Punch*. He has also illustrated Kingsley's *Water-babies*, Andersen's *Fairy Tales*, &c.

Sambre, a tributary of the Meuse or Maas, rises in the French dept. of Aisne, flows 112 miles in a north-easterly direction, and at Namur in Belgium joins the Meuse from the left. It is navigable up to Landrecies, 90 miles, and is connected with the Oise by a canal 40 miles long. Valuable prehistoric remains have been discovered in caves in the Sambre valley, and are now preserved in the neighbouring museums of Charleroi, Floreffe, and Namur.

Sambul. See MUSK-PLANTS.

Sambur (*Cervus aristotelis*), a species of stag abundant in the forest-land of some parts of India, Burma, and China. It stands about five feet high, is a powerful animal, and is much hunted. The colour is dark brown; the antlers are rounded, and belong to a type known as Rusine.

Samland, a district of the province of East Prussia, stretching between the Frisches Haff and the Kurisches Haff. Its western coast is known as the Amber (*Bernstein*) coast. This district gave title to a bishopric from 1249 to 1525.

Samnites, an ancient Italian people of Sabine origin, who occupied an extensive and mountainous region in the interior of Southern Italy. They were surrounded on the north by the Peligni, Marsi, and Marrucini; on the west and south-west by the Latins, Volscians, Sidicini, and Campanians; on the south by the Lucanians; and on the east by the Apulians and Frentani. It was not till after a long series of wars (of which the first began in 343 B.C., and the third did not conclude till 272 B.C.) that the Romans conquered the Samnites, ultimately making them allies; see ROME, Vol. VIII. p. 788. It was in the second Samnite war that the Romans endured the humiliation of the *Caudine Forks* (q.v.).

Samoa. The Samoa or Navigators' Islands are a group of islands in the Western Pacific, lying in 13½° to 14½° S. lat. and 168° to 173° W. long. They are some 350 miles N. of Tonga, and between 400 and 500 miles N.E. of Fiji. From Auckland in New Zealand their sailing distance is 1580 miles, and from Sydney in New South Wales 2570. The group consists of nine islands, in addition to rocks and islets. They are all, with the exception of Rose Island, of volcanic formation,

and are for the most part surrounded with coral-reefs. They are very mountainous, but at the same time well wooded, for the decomposition of the volcanic rock has resulted in a very rich soil, which produces a most luxuriant vegetation. Four islands alone are of any size, Savaii, Upolu, Tutuila, and Manua (Manua really consisting of three islands, the largest of which bears the name of Tau Island). These four lie in order of size from west and north-west to east and south-east. Savaii, the westernmost and largest, is about 40 miles in length by 20 in breadth, and has an estimated area of 700 sq. m. Its centre is filled up with rocky mountains, one peak of which, the highest in the group, is said to rise to a height of from 4500 to 5000 feet. Upolu, about 8 miles SE. of Savaii, is a rich and fertile though mountainous island, with an area of between 550 and 600 sq. m. On its northern side is the bay and harbour of Apia, entered between coral-reefs; and along the shore of the bay is built the town of Apia, which is 'the centre of political and commercial life in the Samoan group.' In 1889 R. L. Stevenson settled at Vailima near Apia, and here in 1894 he was buried. Thirty-six miles SE. of Upolu is Tutuila, only 55 sq. m. in area, but thickly wooded and very fertile. It has the only safe harbours in the group, including Pango Pango, a deep indentation on the south coast. The climate of Samoa is very moist and variable; the pleasantest time of the year is from May to November, when the south-east trade-winds prevails; during the rest of the year heavy gales and rains are frequent, and occasionally, especially from January to the middle of April, the most disastrous hurricanes occur. One of these storms, on the 16th of March 1889, was signalled by a memorable feat of British seamanship, H.M.S. *Calliope*, which was lying in Apia harbour, side by side with American and German men-of-war, having been taken safely out to sea by Captain Kane and his crew, while all the other ships were lost or stranded. The products of Samoa are almost entirely vegetable, consisting of tropical trees and plants. Cocoa-nut trees take the first place in importance, copra, the dried kernel of the cocoa-nut, being the chief article of export; cotton and coffee are grown and exported to a small extent, tobacco is cultivated, and the sugar-cane grows wild throughout the islands. Fruit is plentiful, and bananas and citrons are exported to New Zealand and Australia. There are rich pastures, upon which imported live-stock thrive; almost the only indigenous mammal being a kind of bat. Among birds there is or was to be found on the island of Upolu a very rare species of ground pigeon, the *didunculus* or little dodo (a near relation of the dodo), which, nearly extinct, changed its habits to be out of the way of pigs, took to nesting in trees, and is now increasing. The exports and imports in 1883 were respectively £52,074 and £93,607, fell to £20,509 and £43,629, and by 1895 had risen again to £51,351 and £83,768 (£53,196 from Britain and British colonies). Nearly half of the shipping is British, the American coming next in tonnage; trade is mainly in the hands of German and British firms, German imports having a greater value than British. There is regular steam communication with San Francisco, Auckland, and Sydney.

The Samoans belong to the brown Polynesian race, and are therefore akin to the New Zealand Maoris. Samoa is by tradition the birthplace of the race, and the Samoans are perhaps the lightest in colour of all the Pacific islanders. They are a well-formed and prepossessing race, but decreasing in numbers, the population being, it is said, about 35,000. The islands were visited by Bougainville in 1768, and from him they received the name of

Îles des Navigateurs, as a tribute to the skill of the native boatmen. In 1787 some members of a French exploring expedition under La Pérouse were killed in a quarrel with the natives at Massacre Bay in Tutuila. The Christian religion was first introduced in 1830, and the result of over sixty years of missionary enterprise is that the Samoans are now nearly all Christians. Of late years Samoa, like other groups of Pacific islands, has suffered from the want of a stable government, able to control at once the native inhabitants and the European settlers, and even under the *tridominium* arranged in 1889 between Great Britain, Germany, and the United States, guaranteeing the neutrality and independence of the kingdom, civil war broke out in 1892 and following years, terminated only by the intervention of German, British, and American war-vessels. A contest over the kingship in 1899 culminated in civil war, and the three powers were forced to intervene. Later they appointed commissioners, who abolished the kingly office and set up a provisional government, but recommended the partition of the group, which was accomplished late in 1899. Great Britain withdrew, Germany received Upolu (with Apia) and Savaii, and the United States, Tutuila and Manua (with neighbouring islets). Pango Pango, on Tutuila, previously ceded (1872) to the United States for a coaling station, has since attracted much commerce from Apia.

See Miss Fraser, *Stevenson's Samoa* (1895); R. L. Stevenson, *A Footnote to History: Eight Years of Trouble in Samoa* (1892); G. Turner, *Samoa a Hundred Years Ago* (1884); Findlay's *South Pacific Ocean Directory* W. B. Churchward, *My Consulate in Samoa* (1887); O. Finsch, *Samoa-fahrten* (1888); Von Werner, *Ein Deutsches Kriegsschiff in der Südsee* (1889); the Rev. Charles Phillips, *Samoa, Past and Present* (1890); and a paper by Dr G. A. Turner in *Scot. Geog. Mag.* for 1889.

Samogitia, a district in the Russian government of Kovno, inhabited by pure Lithuanians.

Samos (Turk. *Susam Adasi*), an island in the Aegean Sea, lying close to the coast of Asia Minor, about 45 miles SSW. of Smyrna. Its length is 30 miles, its mean breadth about 8, and its area 180 sq. m. A range of mountains, which may be regarded as a continuation of Mount Mycale on the mainland, runs through the island, whence its name—'Samos' being an old word for 'a height.' The highest peak, Mount Kerki (anc. *Cerceteus*), reaches 4725 feet. Between its eastern extremity and the mainland is the narrow channel of Mycale (called by the Turks the Little Bosphorus), scarcely a mile wide, where in 479 B.C. the Persians were totally defeated by the Greeks under the Spartan Leotychides. Between Samos and Nicaria (anc. *Icaria*) on the west is the Great Bosphorus, from 3 to 8 miles broad, the passage traversed by vessels sailing from the Dardanelles to Syria and Egypt. Samos is well watered and very fertile. Its principal product is wine, which, though little esteemed in ancient times, is now largely exported to France, Germany, Italy, and Austria. Besides wine, the exports embrace olive-oil, carob beans, raisins, and hides, and in 1897 were in value £166,928. The imports, principally manufactured goods, corn and flour, tobacco, spirits, groceries, hides, were (1897) £173,178. The chief industry is tanning. The capital of the island is Vathy (pop. 6000), on the north coast. Previous to 1832 the capital was Chora, near the south coast. The site of the ancient city of Samos is occupied by Tigani. This ancient city was renowned for three architectural works of great magnitude, an aqueduct cut through the heart of a mountain nearly one mile long, a gigantic mole to protect the harbour, and a large temple to Hera, a rival to that of Diana of the Ephesians. All that now stands of this last is a solitary pillar; the mole exists below the level of the water, and is being built up again

by the people of Tigani; the aqueduct was rediscovered in 1882. The island was in Greek times celebrated for its red glossy pottery, which was imitated by the Romans in their so-called Samian ware (see POTTERY, Vol. VIII. p. 365). Pop. of island (1898) 51,745, all Greeks.

Anciently Samos was one of the most famous isles of the Ægean. At a very remote period it was a powerful member of the Ionic Confederacy, and (according to Thucydides) its inhabitants were the first, after the Corinthians, who turned their attention to naval affairs; Colaüs the Samian was the first Greek who sailed through the Pillars of Hercules into the Atlantic. The Samians founded numerous colonies in Thrace, Cilicia, Crete, Italy, and Sicily. But the celebrity of the island reached its acme under Polycrates (q.v., 532-522 B.C.), in whose time it was mistress of the archipelago. Subsequently it passed under the power of the Persians, became free again after the battle of Mycale, stood by Athens during the Peloponnesian war, and after several vicissitudes became a portion of the Roman province of Asia (84 B.C.). Being a Byzantine possession, it was conquered by the Turks. When the war of independence broke out in 1821 no Greeks were more ardent and devoted patriots than the Samians; and deep was their disappointment when, at the close of the struggle, European policy assigned them to their former masters. They are, however, governed (since 1833) by a Greek, who bears the title of Prince of Samos, and by a native council, and pay tribute to the Porte.

See Guérin, *Patmos et Samos* (Paris, 1856), and Tozer, *Islands of the Ægean* (1890).

Samosata (mod. *Samisat*), the capital till 73 A.D. of the Syrian kingdom of Commagene, on the Euphrates, 130 miles NNE. of Aleppo. It was the birthplace of Lucian and of Paul of Samosata (q.v.).

Samothrace, an island of the Ægean Sea, lies in the north-east corner, nearly opposite the mouth of the river Maritza and 40 miles NW. of the Dardanelles. Next to Mount Athos it is the most conspicuous object in the northern Ægean, rising to 5248 feet in Mount Saoce (Phengari), which occupies nearly the whole of its surface (68 sq. m.). It was from this peak that Poseidon watched the fights on Troy plain (*Il.* xiii.). Bare and repellent, the island possesses no harbour and only one village, Chora, of 2000 inhabitants, and is the meeting-place of the Ægean storms. In ancient times it was celebrated for the worship of the Cabeiri (q.v.), mysterious divinities of (probably) Pelasgo-Phœnician origin, and was one of the most sacred sites in the Ægean. The temples and subsidiary buildings forming the sanctuary of these deities were excavated in 1873-75 by Professor Couze (see his *Archäologische Untersuchungen auf Samothrake* (1875 and 1880)). Parts of the cyclopean walls of the ancient city still remain. For several centuries the island belonged to the Byzantine empire; but in 1355 it was given to the princely merchant family of the Gatilusi. They kept it until it was conquered in 1457 by the Turks, who then, and again in 1821, nearly exterminated the population. See Tozer, *Islands of the Ægean* (1890).

Samoyedes, the name of a Ural-Altaic race widely spread over the extreme north of Europe and Asia, especially along the middle course of the Obi River and on the Arctic coast west of the Yenisei. They seem formerly to have possessed nearly all the vast regions between the Altai Mountains and the Arctic Ocean. Numerous grave-mounds of the bronze period that have been found in western Siberia are attributed to a semi-civilised

nation of Ugro-Samoyedes. The Samoyedes were gradually driven northwards by the Turko-Tartar races (Huns, Ugrians, &c.), and are now rapidly disappearing under the combined influence of spirits and smallpox. They number about 20,000 in all probability, dress in skins, use bone and stone implements, keep reindeer, live by hunting and fishing, and are Shamans in religion (mixed with fetishism). See Fred. G. Jackson, *The Great Frozen Land* (1895).

Samphire (*Crithmum*), a genus of plants of the natural order Umbelliferae; having compound umbels, and an oblong fruit, rather flattened at the back, with five winged ridges, and many *vitta* spread all over the seed. Common Samphire (*C. maritimum*) is a perennial, native of Europe, growing chiefly on rocky cliffs near the sea. It is rare in Scotland, but common in the south of England, and so late at least as March 1886 was still gathered on Dover cliffs, as it was in Shakespeare's day (*King Lear*, IV. vi. 15). Its radical leaves are triternate; those of the stem have lanceolate and fleshy leaflets. The stem is about 1½ feet high, the flowers yellow. Samphire makes one of the best of pickles, and is also used in salads. It has a piquant, aromatic taste, and is considered very diuretic. It is generally gathered where it grows wild, but is sometimes very successfully cultivated in beds of sand, rich earth, and rubbish, occasionally supplied with a little salt. *Inula Crithmoides*, a perennial plant, allied to Elecampane (q.v.), and of the natural order Compositæ, a native of the sea-coasts of England, is used in the same way as samphire, and is often called Golden Samphire. The young shoots of *Salicornia herbacea* (see GLASSWORT) are also substituted for it as a pickle, and sold under the name of Marsh Samphire.



Common Samphire
(*Crithmum maritimum*).

Samsö, an island belonging to Denmark, lies in the entrance to the Great Belt, between Zealand and Jutland. Area, 42 sq. m. The people, 6600 in number, are engaged in cultivating the fertile soil and in shipping.

Samson (Heb. *Shimshon*, LXX. and Heb. Judges, xi. 32 *Sampson*, Vulg. *Samson*); the name is derived from *Shemesh*, 'sun'—cf. 'Shimshai the scribe,' Ezra, iv. 8, 17—and the Greek transliteration represents an older pronunciation than that of the present Hebrew text ('judged Israel twenty years' (Judges, xv. 20, xvi. 31), being the last of the series of twelve in the Book of Judges. The narrative of his adventures, however (Judges, xiii.-xvi.), does not represent him in the capacity of ruler of Israel, or even as leader of his own tribe, either in war or in peace; his action is always that of a private individual and for his own hand, without co-operation. He was a native of Zorah, one of the ancient stations of the Danites before they removed to Laish at the roots of Mount Hermon; and the name of his father, Manoah, reappears in that of the Manahethites (1 Chron. ii. 52, 54; cf. Gen. xxxvi. 23). The circumstances of his birth were similar to those of Gideon's, with the addition

that he came under the Nazarite vow, or something equivalent to it (for the unshorn head and abstinence from wine used to be observed by the Arabs also when they were engaged in war or pursuing revenge). His numerous exploits, variously reckoned as seven, or eight, or twelve, have suggested to such modern interpreters as Goldziher (*Hebrew Mythology*, Eng. trans. 1877) the idea that possibly elements of solar mythology may have come into his story, and it is in any case obvious that it owes much to popular legend (e.g. in the etymology of *Lehi*); but there is no reason to doubt that there underlies it an authentic tradition of a strong, childlike, patriotic hero who on various occasions in the days of Israel's oppression had wrought havoc among the Philistines. The narrative, which is a unity, and shows comparatively few editorial touches, is one of the relatively early portions of the Book of Judges (see JUDGES).

Samuel (Heb. *Shemû'el*, i.e., most probably, 'name of God'), the last of the judges (Acts, xiii. 20), the first of the prophets (Acts, iii. 24), and next to Moses the greatest personality in the early history of Israel as a nation (Jer. xv. 1; Ps. xcix. 6), was, according to the narrative in 1 Sam. i-iii., an Ephraimite, native of Ramathaim or Ramah in Mount Ephraim (probably the Arimathea of the New Testament, the modern Er-Ram, about five miles north of Jerusalem). As a child he was dedicated by his mother to the priesthood (not to the Nazirite, Num. vi. 1-21, as is sometimes supposed), and, clothed in priestly ephod and robe (1 Sam. ii. 18, 19), he became a temple attendant under Eli the high-priest at Shiloh, having his sleeping-place within the sacred building 'where the ark of God was.' Later tradition represented him as a Levite (1 Chron. vi. 27, 28, 33, 34). While still a child he received the prophetic gift and foretold the fall of Eli and his house, a prediction soon fulfilled in the national disaster at Ebenezer. The story of Samuel contained in 1 Sam. vii-xvi. combines two widely different accounts of the rest of his career. According to one of these, Israel lay for twenty years under the Philistine yoke; at the end of this period a national convocation was summoned to Mizpah by Samuel, who, for a still longer time, had been known and recognised from Dan to Beersheba as a prophet of the Lord. While prophet and people were engaged in religious exercises the Philistines came upon them, but only to sustain a decisive repulse which drove them within their own borders, where they remained during all the days of Samuel. The prophet thenceforward enjoyed a profoundly peaceful and prosperous rule as judge over all Israel, till his advancing years compelled him to associate his sons with him in the government. Dissatisfaction with their ways gave the elders of Israel a pretext for coming to Samuel and asking him to give them a king such as every other nation had. Although clearly seeing the folly of this and well aware that it was equivalent to a rejection of Jehovah, he, after some remonstrance, granted their prayer (1 Sam. viii.) and held a national convocation at Mizpah (x. 17-27), at which Saul, son of Kish, was chosen by lot to the sovereignty over Israel. Saul's exploit against the Ammonites shortly afterwards led to another convocation at Gilgal, where the kingdom was 'renewed' (xi. 14) in what was, presumably, one of the last acts of the public life of Samuel. The other account, which is also the older, gives a wholly different impression of the prophet's career. He comes before us as a 'man of God,' a man 'held in honour,' and a seer whose every word 'cometh surely to pass,' but occupying a position hardly so prominent as that of judge of all Israel. Saul is divinely made known to him as

the instrument chosen by God in His mercy to deliver Israel out of the hands of the Philistines, under whose oppression they are (and long have been) groaning. The seer secretly anoints the young Benjaminite and gives him certain signs, with the injunction, 'let it be, when these signs are come unto thee, that thou do as occasion serve thee, for God is with thee' (ix. 1-x. 16). The 'occasion' arose about a month afterwards (x. 27; R. V. marg.), when the 'spirit of God came mightily upon Saul,' and his magnificent relief of Jabesh-Gilead resulted in his being immediately afterwards chosen and recognised as king. The accounts of Samuel's conduct during Saul's reign are also discrepant, and neither version of Saul's rejection by Samuel appears in the oldest narrative, which is also silent about the anointing of David.

Samuel, BOOKS OF. The Book of Samuel (for it is in reality but one) forms the third in the series of the four 'former prophets,' being preceded by Joshua and Judges, and followed by the (also undivided) Book of Kings. In the LXX. it appears as two books, entitled respectively A and B 'of kings,' or rather 'of kingdoms' (*basileion*); this, through the Vulgate (Jerome preferred 'Regum' to 'Regnorum'), is the source of the corresponding division in the authorised version, and of the alternative titles, 'otherwise called the first (or second) Book of Kings.' In Coverdale's version the title of 1 Sam. runs: 'the first boke of kynges, otherwise called the first boke of Samuel.' In the Revised Version the alternative title is dropped. In printed editions of the Hebrew Bible since Bomberg's time the Hebrew text has also shown the division of Samuel into two books, the first covering the period of Samuel and Saul, the second that of David. A more natural division would have been into three, the partitions being marked by 1 Sam. xiv. 52, 2 Sam. viii. 18, and 2 Sam. xxiv. 25, or rather by 1 Kings, ii. 46, respectively. Of the sections thus indicated the third presents fewest difficulties to the critic. It is held to extend from 2 Sam. ix. 1 to 1 Kings, ii. 46, and—apart from 2 Sam. xxi.-xxiv, which constitutes an appendix to the main narrative, of miscellaneous contents—it is a quite continuous piece of history, showing in a singularly vivid way how it was that Amnon, Absalom, and Adonijah, failing in turn to secure the succession, cleared the way for Solomon. It was, obviously and admittedly, written at a date comparatively near the events to which it relates. Thénius attributes it to a quite contemporary writer, and Klostermann even names Ahimaaz, the son of Zadok, as the probable author. The second section (1 Sam. xv. 1—2 Sam. viii. 18), containing the history of David from the time when he was first brought to court down to that of his elevation to the throne of all Israel, and his victory over all external foes, is somewhat more complex in its structure. A clue to its analysis is sought by most recent critics in the twofold account of the manner in which David was first brought into close personal relations with Saul. The first and earlier (xvi. 14-23) represents him as already of mature age, a mighty man of valour, and practised in affairs, as well as a gifted musician, when, on account of his skill with the harp, he is introduced into Saul's service after his malady had begun to show itself; here he soon becomes the king's armour-bearer. In the second and later account (xvii. 1-xviii. 5), which appears in a considerably shorter form in the LXX. (see R. V. marg.), he is a shepherd lad, inexperienced either in war or in affairs, who first attracts the king's attention by his heroic encounter with Goliath. The earlier of the two narratives—of Saul's growing fear and jealousy of David, the flight of the latter, his wanderings to Adullam.

Keilah, the Negeb, and the Wilderness of Judah, Saul's last struggle with the Philistines, David's elevation to the throne, first of Judah and then of all Israel, the transference of his capital to Jerusalem, his victories over the Philistines, Moabites, Arameans, Ammonites, and Edomites—finds its continuation (approximately) in xviii. 6-8, 12 α , 16, 20-29 α , xix. 8-10, 11-17, xxi. 2-7, xxii., xxiii. 1-18, xxv., xxvii. 1-6, xxviii. 1-2, xxix., xxx.; 2 Sam. ii.-v., viii. The analysis of the first section (1 Sam. i. 1-xiv. 52) begins with the narration (again twofold) of the steps which led to Saul's elevation to the throne (see SAMUEL). The earlier account is contained in ix. 1-x. 16, x. 27 b (LXX.), xi. 1-11, 15, xiii. 2-xiv. 51; the later (substantially) in 1 Sam. vii. 2-viii. 22, x. 17-27 α , xi. 12-14, xii. 1-25. Closely related to the former (and in any case earlier than the latter) are 1 Sam. i.-iii. (with the exception of ii. 27-36 and Hannah's song) and 1 Sam. iv. 1-vii. 2.

According to the Talmud, 'Samuel wrote his own book;' Abrabanel attributes it to Jeremiah; but the Christian church has no definite tradition on the subject. The attempt systematically to analyse the composition of Samuel was first made by Gramberg (1830), who saw in it two parallel narratives editorially combined. Similar essays were afterwards made by Stähelin, Schrader, and Bruston. The criticism, both 'lower' or textual, and 'higher' or literary-historical, of the Book of Samuel was raised to a new level of scientific precision and accuracy by Wellhausen (in his *Text der Bücher Samuelis*, 1871, in his analysis of the 'former prophets' in Bleek's *Einleitung*, 1878, and in *Die Composition des Hexateuchs u. der histor. Bücher*, 1889). He pointed out the literary unity of the narratives in 2 Sam. ix.—1 Kings ii. (apart from 2 Sam. xxi.-xxiv.) and its early date, and also disentangled the main thread of 1 Sam. xiv. 52—2 Sam. viii. 18, which represents a form of the tradition that must have been committed to writing comparatively soon. The older narrative in the first section he also regarded as early. In some early form, which almost certainly included some matters which have since been dropped, but of course did not contain the additions of a later age, these three sections were brought together into one great continuous historical work, corresponding to the present series, Judges, Samuel, Kings, before the reign of Josiah. The whole work afterwards underwent a Deuteronomistic redaction, which, however, from the nature of the material, was not so systematic and thorough in the case of Samuel as it was in those of Judges and Kings. The division into these three books was made by the Deuteronomist; and it was not till after this had taken place that the miscellaneous collection of passages (some of them very ancient) which now forms the last four chapters of Samuel, and breaks the original continuity, was introduced. Among the passages that help to fix the date of the final redaction of Samuel are 1 Sam. ii. 27-36, which Wellhausen considers to be pre exilic, but not earlier than Josiah's reign, and the whole of the later form of the history of Saul's elevation to the throne (see SAMUEL), which in his opinion cannot have been written before the fall of the Judean monarchy. Budde's work on the structure and sources of Judges and Samuel (1890) is in substantial agreement with the conclusions of Wellhausen; Budde, however, is inclined to assign an earlier date for the 'Mizpah' passages (1 Sam. vii. 2 *et seq.*, &c.), and to put them on a level with the E of the Pentateuch.

For the exposition of Samuel, see the commentaries of Thénius (1842; 2d ed. 1864), Keil (1864; Eng. trans.), Klostermann (1887), Kirkpatrick (in *Cambridge Bible for Schools and Colleges*, 1881, and in *Smaller Cam-*

bridge Bible for Schools, 1889); and especially for textual criticism, the very excellent work of Driver, *Notes on the Hebrew Text of the Books of Samuel* (1890).

San el Hager. See TANIS.

Sanaa', the former capital of the Imáms of Yemen, is situated 200 miles N. by W. of Aden, in a broad grassy valley, sheltered by hills 1200 and 1500 feet high, and is itself 4000 feet above the sea. The population of the city was estimated at 40,000, and of the valley at about 70,000, in 1836; the former is now probably about 20,000. The city and its suburbs are surrounded by walls, and overlooked by a couple of ruined fortresses. Few of the buildings are older than the 16th century, although the city has been in existence from the remotest ages. It was long the capital of the independent Imáms of Yemen, and during that period was noted for its handsome buildings, and gardens, its palaces, mosques, baths, &c. In 1872 it submitted to Turkish rule, and has since then declined in commercial importance, and been allowed to fall into decay.

San Antonio, capital of Bexar county, Texas, and after Dallas the largest city in the state, is on the San Antonio River, 210 miles by rail W. of Houston. It carries on a large trade in the produce of the fertile country around, and has flour-mills, breweries, tanneries, &c. It contains a Roman Catholic cathedral and seminary, an arsenal and a United States government building, court-house, and large park, and still retains some picturesque traces of its Spanish origin. At Fort Alamo, just across the river, occurred in 1836 the ruthless slaughter, by Santa Anna, of the American garrison of 188 men, including Crockett and Bowie. Pop. (1880) 20,550; (1890) 37,673; (1900) 53,321.

Sanbenito. See AUTO DA FÉ.

San Carlos, a well-built town in the Venezuelan state of Zamora, 125 miles SW. of Carácas. The town lies in a fertile plain, given up to agriculture and the rearing of cattle. Pop. 10,741.

San Cataldo, a town of Sicily, 10 miles W. of Caltanissetta. Pop. 15,105.

Sanchez, THOMAS, a Jesuit moralist and casuist, was born at Cordova in 1550, and became director of the school at Granada, where he died 19th May 1610. His best-known work, in virtue of which he ranks as an *Auctor Classicus*, is the treatise *De Sacramento Matrimonii* (3 vols. Genoa, 1592). In this notorious work, parts of which Pascal and Voltaire treated with scathing sarcasm, the legal, moral, and religious questions that arise out of the sacrament of marriage, and the relations, regular and irregular, of the sexes, are treated in portentous detail. Yet the author was throughout his life esteemed a devout, pure-minded man.

Sanchi, a town of India, near Bhilsa, remarkable for its great group of topes. See TOPE.

Sanchuniathon (SANCHUNIATHON, SOUNI-AITHON), the supposed author of a Phœnician history of Phœnicia and Egypt, called *Phoinikika*. He is supposed to have been a native of Berytus; and the accounts which speak of him as born at Sidon or Tyre probably take these cities in their wider sense for Phœnicia itself. Our principal information about him is derived from Philo of Byblus, a Greek writer of the beginning of the 2d century A.D., who translated Sanchuniathon's history into his own tongue; but both the original and the translation are lost, save a few small portions of the latter, preserved by Eusebius, who uses them as arguments in a theological dispute against Porphyry. According to Philo, Sanchuniathon lived during the reign of Semiramis, queen of Assyria, and dedicated his book to Abibalus, king of Berytus. Athenæus, Porphyry, and Suidas

speak of him as an ancient Phœnician, who lived 'before the Trojan war.' There is also a discrepancy between the various ancient writers respecting the number of books contained in the *Phœnikika*. Orelli (1826), and after him C. Müller (1849), published the remaining fragments of Sanchuniathon, and the discussion raised on their genuineness and value can hardly be said to be yet at rest. Several critics went so far as to deny the fact of the existence of a Sanchuniathon point blank. According to some (Lobeck, *Aglaophamus*, &c.) it was Eusebius, according to others (Movers, &c.) Philo, who fathered his own speculations upon an ancient authority. The latter was actuated, Movers thinks, partly by the desire of proving that the whole Hellenistic worship and religion was simply a faint imitation of the Phœnician; partly by the desire of lowering the value of the Old Testament, by showing the higher authority of the Phœnician writer; and partly, as was the fashion among the unbelieving philosophers of his age, to bring the popular creed into a bad reputation, by proclaiming his own views under the guise of an ancient sage. Yet even those who deny the authenticity of Sanchuniathon agree in allowing the fragments current under his name a certain intrinsic value, they being founded on real ancient myths. This, in fact, is now, with more or less modification on the part of the different investigators, Ewald, Bunsen, Renan, &c., the prevalent opinion. Ewald contends for the real existence of a Sanchuniathon, in which he is supported by Renan. Even if there never was a Sanchuniathon it was not Philo who forged him. There seems no doubt that we have but a very dim and confused reproduction of what, after many modifications, misunderstandings, and corruptions, finally passed the hands of Philo and Eusebius, and was by the Church Father, as has been said, quoted in a theological disputation. Yet, even assuming the person of a Sanchuniathon, his age—and Eusebius insists upon a very remote one indeed—must be placed much lower: into the last centuries before Christ, at the earliest. He would then, it seems, have endeavoured to stem the tide of Greek superiority in all things, by collecting, grouping, and remodelling the ancient and important traditions of his own country, and thus proving to both his countrymen and the Greeks their high importance, in comparison with the Greek productions, in the field of religion and philosophy.

The *Phœnikika* was not only a cosmogony, it would appear, but a history of his own and the surrounding nations; and, like similar ancient histories, it probably began with the creation of the world, and contained an account of the Jews. All the historical parts, however, are lost, and nothing remains but a fragmentary cosmogony, or rather two or three different systems of cosmogony, or, according to Movers, merely an Egyptian and Phœnician patchwork. One of the chief difficulties for us consists in the Phœnician words of Sanchuniathon, which Philo either translated too freely or merely transcribed so faultily in Greek characters as to leave them a puzzle.

Eusebius further contains a fragment of a treatise by Sanchuniathon, *Peri Ioudaion*, but it is doubtful whether this is the work of Philo of Byblus or of Sanchuniathon; and if it be that of the latter, whether it is a separate work, or merely a separate chapter out of his larger work. A forgery, said to contain the whole nine books of Sanchuniathon, and to have been found by a Portuguese, Colonel Pereira, at the convent of St Maria de Merinhão, and to have been by him entrusted to a German corporal in Portuguese service, named Christoph Meyer, was published by Wagenfeld (Bremen, 1837), and translated into German (Lübeck, 1837), but was very soon consigned to disgrace and

oblivion by Movers, K. O. Müller, and Grotefend, the last of whom at first believed and even wrote a preface to the *editio princeps*. There never was such a convent, nor such a colonel; but the facsimile taken by 'Pereira' in the convent in Portugal was found to have been written on paper showing the water marks of an Osnabrück paper-mill.

See Ewald, *Abhandlungen d. Göttinger Gesellschaft der Wissenschaften* (vol. v. 1851); Renan, *Mémoire sur Sanchuniathon* (1858); and Baudissin, *Studien zur Semitischen Religionsgeschichte* (vol. i. 1876); also chap. 6, vol. i. (1877) of Abbott's trans. of Duncker's *History of Antiquity*.

San Cristóbal, (1) capital of Chiapas state in Mexico, has a handsome capitol, a cathedral, a secondary school, and 8500 inhabitants.—(2) A town of Venezuela, in the state of Los Andes, with streets straight, but much cut up by small ravines; an important trade (especially in coffee), mainly in the hands of Germans and Danes; deposits of coal beside the town, and near by copper-mines and petroleum wells. Pop. 5000.

Sancroft, WILLIAM, Archbishop of Canterbury, was born at Fressingfield in Suffolk on 30th January 1616–17, and from Bury St Edmunds grammar-school passed in 1634 to Emmanuel College, Cambridge, of which in 1642 he was elected a Fellow. In 1651 he was expelled from his fellowship for refusing to take the 'Engagement;' and in 1657 he crossed over to Holland, whence, after a year and a half at Utrecht, he visited Geneva, Venice, and Rome. In 1660, the Restoration accomplished, his friend Bishop Cosin of Durham appointed him his chaplain, and his subsequent advancement was rapid, to be a king's chaplain and rector of Houghton-le-Spring (1661); prebendary of Durham and master of Emmanuel (1662); Dean first of York and next of St Paul's (1664), as such having a principal hand in the rebuilding of the burnt cathedral; Archdeacon of Canterbury (1668); and Archbishop (1678). A Tory and High Churchman, he is of course belittled by Burnet and Macaulay; but the manner in which he discharged his high duties deserves the warmest commendation—the one flaw, perhaps, in his conduct that he employed an Italian spy in Holland who dared propose to him the assassination of Sir William Waller. Sancroft attended Charles II. on his deathbed, and used great freedom of speech to him on the nature of his past life. He refused to sit in James II.'s Ecclesiastical Commission (1686); and in 1688 was sent to the Tower for presenting the petition of the Seven Bishops (q.v.) against the reading of the second Declaration of Indulgence, but on their trial in Westminster Hall he and his six brethren were acquitted. In the events that immediately preceded and attended the Revolution he preserved on the whole a position of non-intervention; still, having taken the oath of allegiance to James, he would not take it to William and Mary. Accordingly, he was suspended by act of parliament (1st August 1689), though he did not quit Lambeth until his ejection on 23d June 1691. He then retired to his native village, where he died on 24th November 1693. Of eight works ascribed to him one only retains much interest—*Fur Prædestinatus* (1651), a dialogue between a Calvinist minister and a thief condemned to the gallows; and this seems to be really a translation from a Dutch pamphlet.

See NONJUREORS, with works there cited; the *Life of Archbishop Sancroft*, by George D'Oyly, D.D. (2 vols. 1821); and Miss Strickland's *Lives of the Seven Bishops* (1866).

Sanctuary, a consecrated place which gives protection to a criminal taking refuge there; or the privilege of taking refuge in such a consecrated

place. Among the Jews there were cities of refuge to which one might flee who killed a man unawares (see CITY OF REFUGE), and something analogous to a right of sanctuary may be traced in pagan communities. In the ancient Greek states certain temples afforded protection to criminals, whom it was unlawful to drag from them, although the supply of food might be intercepted. As early as the 7th century the protection of sanctuary was afforded to persons fleeing to a church or certain boundaries surrounding it. The canon law recognises this protection to criminals as continuing for a limited period, sufficient to admit of a composition for the offence; or, at all events, to give time for the first heat of resentment to pass before the injured party could seek redress. In several English churches there was a stone seat beside the altar where those fleeing to the peace of the church were held to be guarded by its sanctity. One of these *frith-stools* ('peace-stools') still remains at Beverley and another at Hexham; while the sanctuary knocker is still visible at Durham. The privilege of sanctuary did not extend to persons accused either of the crime of sacrilege or of the crime of treason. Connected in England with the privilege of sanctuary was the practice of *abjuration of the realm*. By the ancient common law, if a person guilty of felony took the benefit of sanctuary, he might within forty days afterwards go clothed in sackcloth before the coroner, confess his guilt, and take an oath to quit the realm and not return without the king's license. On confessing and taking the oath he became attainted of the felony, but had forty days allowed him to prepare for his departure. All privileges of sanctuary and abjuration were entirely abolished by statute 21 Jac. I. chap. 28. Yet as regards the execution of civil process, sanctuaries continued in defiance of the law for another century. This is shown by the statutes 8 and 9 Will. III. chap. 27, which makes it penal in sheriffs not to execute process in certain 'pretended privileged places,' such as Whitefriars or Alsatia and the Savoy; and 9 Geo. I. chap. 28, which contains provisions against resistance to process in the Mint and Stepney.

By the ancient canons of the Scottish councils, excommunication was incurred by the offence of open taking of thieves out of the protection of the church. The most celebrated ecclesiastical sanctuaries in Scotland were the church of Wedale, now Stow, near Galashiels, where was an image of the Virgin, believed to have been brought by King Arthur from Jerusalem; and the church of Lesmahagow, near Lanark, fugitives to which had the benefit of the 'King's Peace,' granted by David I., in addition to the protection of the church. The institution of sanctuary, though probably useful in early times in enabling innocent persons to escape oppression or private enmity pursuing them under the name of law, tended after the rise of settled government to become highly mischievous by enabling criminals to bid defiance to the civil power. Consequently for a century before the Reformation we find a continuous struggle going on between the legislature and the church, caused by attempts on the part of the former to check the evils arising out of the privileges of sanctuary and to maintain the authority of the law. The Reformation finally abolished all religious sanctuaries in Scotland.

Of the places which owe their privilege of giving sanctuary to the respect due to the person of the sovereign the most famous is the Abbey of Holyrood House and its precincts. The precincts of the palace, to which the privilege belongs, are extensive, including Arthur's Seat and the Queen's Park; and the whole are placed under the protection of a

baillie appointed by the Duke of Hamilton, the heritable keeper of Holyrood House. This time-honoured sanctuary afforded protection against imprisonment for debt only; to a criminal it gave no protection. For twenty-four hours after passing the confines the debtor was protected against personal diligence; but in order to enjoy protection for a longer period he must enter his name in the books kept by the baillie of the abbey. Neither crown debtors nor fraudulent bankrupts nor persons under an obligation to perform an act within their power could claim protection; while within the precincts there was a prison for debtors against whom diligence had been brought for debts contracted within the sanctuary. To retire to the abbey is by 1696, chap. 5, made one of the circumstances which, combined with insolvency, constitute legal bankruptcy. The Castle of Edinburgh, the Mint or 'cunzie-house,' and several other places seem to have enjoyed the privilege of giving sanctuary; but Holyrood is now the only sanctuary which the law of Scotland recognises, and the abolition of imprisonment for debt in 1880 has rendered it practically obsolete.

By the *privilege of Clan Macduff*, alleged to have been granted by Malcolm Canmore, any person related within the ninth degree to the chief of Clan Macduff who should have committed homicide without premeditation was entitled, on fleeing to Macduff's Cross in Fife, to have his punishment remitted for a fine, or at least to be pledged from any other jurisdiction by the Earl of Fife. See Mazzinghi, *Sanctuaries* (Stafford, 1888).

Sanctus. See LITURGY, BELL.

Sand, one of the products of the disintegration of rocks, is composed mainly of grains of quartz—some sands being more purely quartzose than others. Speaking broadly, we may say that all rocks undergoing disintegration are eventually resolved into two kinds of sediment—viz. sand and clay or silt—the former representing the practically insoluble quartz of the original rock, the latter the insoluble constituents of the other minerals. Sand is formed in various ways. It is, as every one knows, one of the most common sediments of rivers, lakes, and seas. Sea-sand exactly resembles river-sand—one cannot be distinguished from the other except by means of included organic remains. As a rule the grains of aqueous sands are angular and subangular in form, especially in the case of fine-grained deposits. When the grains are large they may be more or less well rounded. These last have been rolled over each other and pushed forward in the bed of stream or sea, while the smaller particles, carried in suspension, have in some measure escaped trituration. Aqueous sands are very widely distributed. They are commonly met with forming terraces along the courses of streams and rivers—not infrequently they occupy the sites of ancient lakes and estuaries—and now and again they form what are known as raised beaches in maritime districts. Most of these sands are of recent geological age; others, however, such as the sands of the Tertiary basins of England, France, Belgium, Austria, &c., represent the sea-floors of much more remote times. Sands of wind-blown origin occur frequently in maritime regions and in dry desiccated desert countries. In coastlands the material of the dunes is obviously washed up by the sea; while in certain inland tracts, as in Poland, the sand which is there blown about by the wind is derived from wide-spread fluvio-glacial deposits—relics of the ice age. But in other countries, as in the Libyan Desert, the sand has resulted from the subaerial degradation of granites, schists, sandstones, and other rocks. As the rock-ingredients are swept forward over the ground they

are subjected to much attrition, so that eventually even the smallest grains become well rounded, and when seen under a magnifying glass resemble little pebbles. Sand-deposits are also the result of volcanic action. These consist of the very finely comminuted debris of volcanic rocks, and are readily distinguished from sedimentary and æolian sands. Now and again, however, volcanic sands are sifted by the winds and heaped up into dunes.

Sand varies in texture from extremely fine-grained, almost dust-like material, up to coarse granular grit. Indeed all gradations occur from sand through coarse grit into fine gravel. Pure white sands are not uncommon, but shades of yellow, brown, and red predominate, especially in the case of æolian and aqueous sands. The colour is generally due to the presence of iron. Gray, dark-brown, green, and black sands are also met with. The latter are often largely composed of magnetite, and have been derived from the disintegration of certain igneous rocks such as basalt. Green sands usually owe their colour to glauconite. Volcanic sands are generally dingy—chiefly dull gray or black. Some sands are rich in gold, others in precious stones and gems. These are alluvial deposits which have been derived from the disintegration of crystalline igneous rocks, schists, &c. Pure white sands are in demand for the manufacture of glass, while others are employed as abrasives in sawing marble, &c., and in smoothing the surfaces of that and other ornamental stones. Sharp sand, again, is largely used for mixing with mortar. See DRIFT, GRAVEL, PLEISTOCENE SYSTEM, QUICKSAND, SAHARA, SANDSTONE.

MUSICAL SAND.—Some kinds of sand, which consist of well-rounded and polished grains of tolerably uniform size, and which are clear or free from dust and small particles, exhibit remarkable sonorous qualities when struck or subjected to friction. The well-known 'musical sand' of the island of Egge (Inner Hebrides) is a good example, and was at one time believed to be almost unique; but, as Professor Bolton of Hartford, Connecticut, and Dr A. Julien of New York have shown, sonorous sands are widely distributed in Europe and America. The sounds emitted are often decidedly musical, and distinct notes can be produced, high or low, according to the nature of the friction and the quantity of sand operated upon. When one walks over a bed of strongly sonorous sand a tingling sensation is perceived even through the boots. After being subjected to friction for some little time musical sand gradually loses its peculiar qualities, and the same result is produced when the sand is wetted. There is nothing in the appearance of musical sand to distinguish it from mute sand—sonorous and non-sonorous sand of precisely similar aspect lying side by side on the same beach. No satisfactory explanation of the phenomenon has been given.

SANDBANKS.—These are met with in the beds of rivers and estuaries and shallow seas. In rivers the banks are usually elongated in the direction of the current, and are liable to constant changes as the force and direction of the current become modified. Opposite the mouths of rivers sandbanks tend to accumulate. Much of the material of which these bars are composed is brought down by the rivers, but a large proportion is also swept up by the sea itself. Such banks are constantly changing their form, and oscillating to and fro, according as the sea or the river is the more active. The sea also tends to form sandbanks across the mouths of shallow inlets and other indentations of a coast-line, so that eventually a secondary coast-line may come to be formed in this way—shallow lagoons separating the new from the old coast-line. Islands are in like manner converted into peninsulas by the heaping up of sandbanks by tidal

currents between them and the mainland. The Eye peninsula in the Island of Lewis is an example, and there are many islets off British coasts which in time will be converted into similar peninsulas by the growth of sandbanks, which in some cases has proceeded so far that the islets become peninsulas at low tide. In the shallow seas that surround the British Islands sandbanks are of common occurrence. Some of these are doubtless due to tidal action, as is the case with the sandbanks of similar shallow seas all the world over. Others again probably mark the sites of undulating land-surfaces submerged during a recent geological period. It is thought by some that the Dogger Banks of the North Sea may consist largely of the moraine debris laid down by the great Scandinavian ice-sheet of the glacial period, now more or less modified by current-action.

Sand, GEORGE, the *nom de guerre* of Armandine (or Amantine) Lucile Aurore Dupin, 'Baronne' Dudevant, was born in Paris on the 5th July 1804, and died at Nohant in Berri on the 7th June 1876. Her father Maurice Dupin was the son of M. Dupin de Francueil (well known in the writings of Rousseau and his circle) by a natural daughter of the Marshal de Saxe and of Mlle. Vèrièrre, also well known in the 18th century. Aurore's own mother was a Parisian milliner. Her father died when she was very young, and she was the subject of continual disputes between her mother and her grandmother, Madame Dupin (by her first marriage Comtesse de Horn). Aurore lived with both in turn, but principally at Nohant with her grandmother, on whose death the property descended to her. She was educated partly at home, partly at the English convent in Paris, and represents herself in her voluminous *Histoire de ma Vie* (which contains little fact and much fancy) as a child full of reverie of all kinds. An heiress as has been said, though in no great way, and with no near relations except her mother, she was married at the age of eighteen to a certain M. Dudevant, the natural son of a colonel and baron of the empire, who also had some small fortune. The marriage was quite of the ordinary French kind, with no love, but also no particular dislike, between the parties. Two children were born of it—a boy, Maurice (1825–89), who afterwards took his mother's assumed surname and became a man of letters of some little accomplishment, and a girl, Solange, who married the sculptor Clésinger. Very little is known of M. Dudevant, who seems, however, to have been by no means especially tyrannical or offensive, but merely an ordinary squireen, devoted to sport, not actively sympathising with, but also not violently opposing his wife's bookish tastes, and probably, as her letters show, a good deal tried by the increasing number of her doubtless Platonic friendships. After nine years of married life, towards the end of which the situation became very much strained, she 'threw her cap over the mills,' and at first resigning her property to her husband as the price of an amicable separation, went to Paris to make her living by literature, to associate (often in men's clothes) with the Bohemian society of the time (1831), and in short to 'see life' generally in a very full sense. Nevertheless after some years the local tribunals found sufficient cause in her husband's behaviour to turn the amicable into a legal separation, and to give her the complete enjoyment of her own property. For the best part of twenty years her life (apart from its literary features, to which we shall come presently) was spent in the company and partly under the influence of divers more or less distinguished men, with some of whom she certainly, and with others probably, was on the terms which might be

expected in such circumstances. But George Sand's was a very peculiar temperament, and it is not safe to take too much for granted in respect to her. During the first few years her interests were chiefly directed towards poets and artists, the most famous being Alfred de Musset and Chopin, with the former of whom she took a journey to Italy notable in the lives of both; while the second was more or less her companion for several years, including a dismal winter which they spent together at Majorca, and which she has recorded in a noteworthy book. In the second decade her attention shifted to the wider sort of philosophers and politicians, such as Lamennais, Pierre Leroux, and Michel (de Bourges). But the advance of years and the revolution of 1848 with its consequences put an unexpected end to her rather protracted *Sturm-und-Drang* period. By a revolution not by any means universal among men and almost unexampled among women, she settled down as the quiet 'châtelaine of Nohant,' and spent her life for more than a quarter of a century thus, occupying it with wonderful literary activity, varied only by foreign travel now and then, and by occasional visits to Paris. She was exceedingly hospitable: almost all French and many foreign men of letters of eminence visited at Nohant, which was an unostentatious but pleasant Liberty Hall, the especial diversion being a marionette theatre. No private event of any importance disturbed this long and quiet period, which only closed by her death with the words '*Laissez la verdure*' on or almost on her lips.

We must now pass from this curious existence—a youth of dream, a womanhood of racket and license, an old age of laborious calm—to her work. In this some have marked three, others four periods, the last two of which do not seem to be separated by any very real gap. The threefold division corresponds almost exactly to her life experiences as above sketched. When she first went to Paris, and with her companion Jules Sandeau, from the first half of whose name her pseudonym was taken, settled, partly under the guidance of Henri de Latouche, to novel-writing, her books partook of the Romantic extravagance of the time, specially informed and directed by a polemic against marriage and by the invention and glorification of the *femme incomprise*. *Indiana*, *Valentine*, *Lélia* (the most remarkable of all), and *Jacques* are the chief works of this period. In the next her philosophical, political, and (if they can be so called) religious teachers got the upper hand, and in a fashion fathered the rhapsodies of *Spiridion*, *Consuelo* (one of her best books, however), and the *Comtesse de Rudolstadt*. Between the two groups should be placed in time the fine novel of *Mauprat*. Towards the middle of the century appeared the extraordinary study called *Lucrezia Floriani*, the chief characters of which are undoubtedly in part drawn from herself and Chopin; while she also now began to turn towards the studies of rustic life, of which *La Petite Fadette*, *François le Champi*, and *La Mare au Diable* are the chief, and which some of her admirers regard as her greatest works. Some critics (the chief of whom is M. Caro) would make these rustic novels a third division by themselves, and construct a fourth for the miscellaneous and less spontaneous works of the last twenty years of her life. Some of those last, such as *Les Beaux Messieurs de Bois Doré*, *Le Marquis de Villemer*, *Mlle. la Quintinie* (a duel with Feuillet), and others, are of high merit. Not a tithe of her enormous list of novels can be mentioned here, while there has to be added to it a considerable *Théâtre*, the bulky *Histoire de ma Vie* already referred to, some nondescript work, such

as the *Hiver à Majorque* referred to above, and *Elle et Lui* (a sort of vindication of her relations with Musset (q.v.), written after his death), and a delightful and extensive collection of letters published posthumously. One division of this last—those to Flaubert—is of the very first literary and personal interest, and the whole exhibits the personal and literary character of the writer in such a light as to have conciliated to her the affection of some who had previously been rather recalcitrant.

The popularity of George Sand, like that of most very voluminous authors, has sunk considerably since her death. Nor have critical estimates invariably agreed about her. The one thing which both friends and foes accord her is the possession of a most remarkable style, somewhat too fluent and facile, but never slipshod or commonplace, if never exquisite or distinguished. To this gift may be added the still more important one of a faculty of imagination which always idealised the subject and treatment to the point necessary to fix the work as literature. A third, though a more disputable gift, was a singular faculty of receptivity which enabled her to catch and render not merely the aspects of scenery and the outline of personages, but the fleeting ideas of the day on all manner of subjects. She had no great or deep originality; despite her fertility, she scarcely ever (the sole great exception is the wonderful study of insatiable jealousy and outworn love in *Lucrezia Floriani*) achieved the analysis which results in synthesis and fixes a character for ever. She wrote with something like the business-like regularity of Mr Anthony Trollope in England; and her work cost her so little that in a very few years she as regularly forgot all about it, and read her own novels as if they were those of others. It is scarcely paradoxical to doubt whether—though her books are unceasingly occupied with love, and a good portion of her life was at least not closed to it—she ever felt in her own person a passionate affection. In conversation, it is said, she was awkward and dull, and there is hardly any wit or humour even in her books. They are also notoriously destitute of plot or composition. It seems to have been her portion to produce or reproduce with a certain passivity, but in never-failing yield, novels as the earth produces crops. All this sounds like unfavourable criticism, and so to a certain extent it is and must be. It is a commonplace of criticism on her to say that George Sand's novels are seldom read a second time. Story they have as a rule not much to tell, and their characters, though never exactly unreal, are too slightly provided with life to exercise an absorbing fascination. Yet after all exceptions are made, and after allowing the utmost that criticism can demand, it is difficult to speak with anything but admiration of this enormous work, the very bulk of which perhaps does it harm, because the same defects recurring almost throughout become more obvious than they would be in a smaller total. The charm—not strange or deep, but constant—of the style, the vast variety and volume of the creations, the constant faithfulness to the one law of art, 'idealise, always idealise,' stand in lieu of many ornaments which are not there. If George Sand had written nothing but *Lucrezia Floriani* and the Letters to Flaubert men would have gone about saying what a marvellous novelist, what an acute critic of life and letters had given but glimpses of herself. As it is we have a whole Sandian panorama, and we find fault with it.

The *Œuvres Complètes* of George Sand, which amount to about a hundred and twenty volumes in their compact form, were and are all published by Messrs Lévy of Paris. Critical and biographical writings on her (these latter rather meagre, but supplemented by the

Letters) are numerous. The best is the volume in the *Grands Ecrivains* series (Paris, Hachette), by the late M. Caro, which, under a style at first appearing rather desultory and affected, will be found to contain excellent criticism, and has been translated by M. Masson. But the subject is so huge that no book in a small compass can be really complete. There is an English monograph by Miss Bertha Thomas in the series of 'Eminent Women.'

Sand, KARL LUDWIG, the Jena theological student and member of the Burschenschaft (q.v.), who assassinated Kotzebue (q.v.) as a traitor to his country. Born in 1795, he was executed by the sword, 20th May 1820.

Sandakan, the capital of the territory of the British North Borneo Company. Founded about 1880, it had a pop. (1891) of over 7000, one-half being Chinese, 131 Europeans, and the rest Sulus, Malays, and Javanese.

Sandal Magna, a small town in the West Riding of Yorkshire, 2 miles SE. of Wakefield. Near it are the remains of the old castle of the Earls of Warren, ruined during the great Civil War. Pop. (1851) 1546; (1891) 5082.

Sandals. See **BOOTS AND SHOES.**

Sandalwood (a name corrupted from *Santal* wood), the wood of several species of the genus *Santalum*, of the natural order Santalaceæ (q.v.), natives of the East Indies and tropical islands of the Pacific Ocean. Sandalwood is compact and fine grained, very suitable for making work-boxes, desks, and small ornamental articles, and is remarkable for its fragrance, which is fatal to insects; so that cabinets of sandalwood are extremely suitable for the preservation of specimens in natural history, though much too expensive for general use. White Sandalwood, the most common kind, is the produce of a small tree (*Santalum album*), a native of mountains in the south of India and the Indian Archipelago, much branched, resembling myrtle in its foliage and privet in its flowers. The girth of a mature tree varies from 18 to 36 inches.

It is a government monopoly in India, the exports being now to the value of £80,000 a year. The annual sale in 1889 was 2420 tons, chiefly obtained in the Mysore province. Other species of sandalwood are now brought into commerce, among which may be named *S. Freycinetianum* of the Sandwich Isles, which has a peculiarly rich perfume, from the mountains of Hawaii, *S. Yasi* of Fiji, *S. austrocaledonicum* from New Caledonia, *S. Preissianum* of South Australia, and *S. cygnorum* of Western Australia. Of the latter 4500 tons have been exported in one year, valued at £36,200. The precious oil is obtained by slow distillation from the heartwood and root. The bark and sapwood have no smell, but the heartwood and roots are highly scented, the billet nearest the root being most esteemed. The average yield is about 2½ per cent. or more of oil; indeed 100 lb. of good sandalwood should yield from 15 to 20 oz. of otto. As imported from India it is very dense, of a pale straw colour and of a mild but lasting odour. The best is that prepared in Europe, principally in France and England. From its high price sandalwood-oil is especially liable to adulteration.

The oil forms the basis of many perfumes, and is sometimes used for disguising with its scent articles which, really carved from common wood, are passed off for true sandal. The roots, which are the richest in oil, and the chips go to the still; while the Hindus can afford to show their wealth and respect for their departed relatives by adding sticks of sandalwood to the funeral pile. The wood, either in powder or rubbed up into a paste, is used by all Brahmins in the pigments for their distinguishing caste-marks. In China the wood is used

for carving, for incense, and for perfume, the imports ranging there from 100,000 to 146,000 cwt. annually.

Red Sanderswood, sometimes called Sandalwood, is the produce of a very different small tree, *Pterocarpus santalinus*, of the natural order Leguminosæ, sub-order Papilionaceæ, a native of the tropical parts of Asia, particularly of the mountains of the south of India. The tree is about 40 feet high, with pinnated leaves, having generally three leaflets, and axillary racemes of flowers. The heartwood is dark red, with black veins, and so heavy as to sink in water. It is used as a dyestuff, imparting a pale pink colour to cloth, and also by apothecaries to colour certain preparations. In India it is chiefly employed to mark idols and the forehead in ceremonies. The Arabs use it as an astringent, and it is the basis of some of our tooth-powders.

Sandalwood Island, called also Tjindana and Sumba, one of the Sunda group belonging to the Dutch East Indies, has an area of 4385 sq. m. and a pop. of 200,000. The produce consists chiefly in sandalwood and cotton, horses and poultry. The island belongs to the residency of Timor.

Sandarac, or SANDARACH RESIN, is a friable, dry, almost transparent, tasteless, yellowish-white resin, which is imported from Mogador, Morocco. It is completely soluble in oil of turpentine, but not completely soluble in alcohol. When heated, or sprinkled on burning coals, it emits an agreeable balsamic smell. It exudes from the bark of the Sandarac tree (*Callitris quadrivalvis*), a native of the north of Africa, of the natural order Coniferae. The quantity of sandarac used is not great; it is employed in making varnish, and generally speaking for the same purposes as Mastic (q.v.). The Australian species also exude sandarac. The finely-powdered resin is rubbed, as *Pounce*, on the erasures of writing-paper, after which they may be written upon again without the ink spreading. The mottled butt-wood of the sandarac tree is highly balsamic and odoriferous, extremely durable and valuable for cabinet-makers. It fetched fabulous prices in Pliny's time. A current error is that the gum of the Juniper is identical with sandarac.

Sanday. See **ORKNEY ISLANDS.**

Sandbach, a market-town of Cheshire, near the right bank of the Wheelock, 5 miles NE. of Crewe. It has a good parish church, public rooms (1859), a grammar-school (1594), and manufactures of boots and shoes, fustian, iron, &c. Pop. (1851) 2852; (1891) 5824.

Sandbags, in military works, are canvas bags (sometimes tarred) 32 inches by 16. They are partially filled with sand or earth, averaging then 20" × 10" × 6", and forming a ready means of giving cover against the enemy's fire, or tamping the charge in a mine. See **MINES (MILITARY)**. They are also very useful in forming revetments to parapets, loopholes for rifle pits, and lining for embrasures, when they should be covered with raw hides to prevent them from taking fire.

Sand-blast, a method of engraving figures on glass or metal. See **GLASS**, Vol. V. p. 245.

Sandby, PAUL, 'the father of the water-colour school,' was born in 1725 at Nottingham, where he and his brother Thomas, afterwards an architect and R.A., kept a school for some years. In 1741 Paul obtained a post in the military drawing department at the Tower of London; and in 1746-52 he was draftsman of the survey of the Scottish Highlands, which was one result of the rebellion of 1745. Settling at Windsor, he made some seventy-six drawings of Windsor and Eton; and he subsequently made a series of drawings of castles in

Wales. He was a member of the St Martin's Lane Academy, of the Incorporated Society of British Artists, and an original member of the Royal Academy, to whose exhibitions he regularly contributed water-colour landscapes. Appointed drawing-master to the Woolwich Military School, he became famous as a fashionable teacher of painting. His drawings of Scottish scenery were published as etchings by himself, his Welsh views in aquatint; and he was known also as a caricaturist. His water-colours are outlined with the pen, and only finished with colour; his perspective is good, and his architectural drawings admirable. But his landscapes are 'tinted imitations of nature.' He died 9th November 1809. Thomas, born 1721, died 1798. See W. Sandby, *Thomas and Paul Sandby* (1892).

Sand-crack. See HOOFS, CRACKED HEELS.

Sandean, LÉONARD SYLVAIN JULES, French novelist and playwright, was born at Aubusson in Creuse, February 19, 1811, and went at an early age to Paris to study law, but soon gave himself entirely to letters. His short-lived intimacy with George Sand produced one joint-novel, *Rose et Blanche* (1831), and suggested to the more famous of the pair her literary name. Sandean's first independent novel was *Madame de Sommerville* (1834), his first hit *Mariana* (1839). These were followed by a long series of novels, many of which first appeared in the *Revue de Deux Mondes*; the best *La Muison de Penarvan*, *Mademoiselle de Kérouare*, *Mademoiselle de la Seiglière*, *Le Docteur Hébeau*, *Cathérine*, *Muleleine*, *Jean de Thommeray*, and among shorter stories, perfect in their kind, *Le Château de Montsabrey*, *Le Jour sans Lendemain*, and *Un Début dans le Magistature*. As a dramatist Sandean collaborated much with Émile Augier, his most celebrated plays being *Le Gendre de M. Poirier*, *La Pierre de Touche*, and *La Ceinture dorée*. Sandean became keeper of the Mazarin Library in 1853, was elected to the Academy in 1858, and appointed librarian at St Cloud in 1859. He died at Paris, 21st April 1883. As a novelist he never attained the popularity of some of his contemporaries, most probably because he steadily refused to make illicit love the staple of his plots. A pleasing style of reflection and an honest interest in the past are characteristic notes; his range of subjects is small and mostly confined to provincial life, but the work is fine, the characters distinct. See *Saintsbury's Essays on French Novelists* (1891).

Sandec, a town of Galicia, on the Dunajec, 45 miles SE. of Cracow. It was the scene of a great fire in April 1890. Pop. 11,185, half of them Jews.

Sand-eel. See EEL.

Sandefjord, a watering-place of Norway, 86 miles by rail SSW. of Christiania. Pop. 2307.

Sandemians. See GLASSITES.

Sanderling (*Calidris*), a genus of birds of the Snipe family, Scolopacidae, sub-family *Tringinae*, characterised by the absence of a hind-toe. There is only one species, the Common Sanderling (*C. arenaria*), which is widely distributed, breeding in the Arctic regions, and ranging from Iceland and east Greenland in the north to Cape Colony and Natal and to Chili and Patagonia in the south, and from north Alaska in the west to Ceylon, Borneo, Java, China, Japan, and the Hawaiian Islands in the east. It visits the British Isles in winter, coming about the middle of August, and beginning to depart in April, but found even till June. It is common on the coast, and is occasionally found near inland lakes. It is about 8 inches long, and it is very fat. The winter plumage is ash gray; the under parts are all white. The summer dress has the feathers of the upper surface of a reddish tinge with black markings. The sanderling in its

breeding-places feeds on the buds of saxifrages and on insects, but in Britain its food is chiefly marine worms, small crustaceans, and bivalve molluscs. Its note is a shrill wick. It is often found



Sanderling, Male and Female (*Calidris arenaria*).

in company with small plovers, and occasionally with dunlins.

Sanders, DANIEL, German lexicographer, was born at Alt-Strelitz in Mecklenburg on 12th November 1819. Educated at Berlin and Halle, he was head of the school in his native town from 1843 to 1852, and thenceforth devoted his energies to the making of dictionaries of the German language, books that enjoy a high reputation amongst his own countrymen. The most important and most popular are a *Wörterbuch* (3 vols. 1859-63), *Katechismus der deutschen Orthographie* (4th ed. 1878), *Handwörterbuch* (4th ed. 1888), *Fremdwörterbuch* (2 vols. 1871), *Wörterbuch der Hauptschwierigkeiten in der deutschen Sprache* (18th ed. 1888), and *Deutsche Sprachbriefe* (1878; 5th ed. 1885). He also wrote *Geschichte der deutschen Sprache und Litteratur* (3d ed. 1886), and edited, with Rangabe, *Geschichte der neugriechischen Litteratur* (1884). Died at Strelitz March 11, 1897.

Sanders, NICHOLAS. See SAUNDERS.

Sanderson, ROBERT, Bishop of Lincoln, the greatest of English casuists, was born on 19th September 1587, either at Sheffield or at his father's seat, Giltwhaite Hall, near Rotherham. From Rotherham grammar-school he passed in his thirteenth year to Lincoln College, Oxford, of which he became a Fellow (1606), reader of logic (1608), and thrice sub-rector (1613-16), in the last year being also chosen senior proctor. He had taken orders in 1611, and in 1618 was presented to the rectory of Wyberton in Lincolnshire, in 1619 to that of Boothby-Pagnell, near Grantham, in the same county. In 1631 he was appointed a king's chaplain: 'I carry,' said Charles I., 'my ears to hear other preachers, but I carry my conscience to hear Mr Sanderson, and to act accordingly.' He was created D.D. in 1636; from 1646 to 1648 filled the regius chair of divinity at Oxford; and continued parson of Boothby-Pagnell for upwards of forty years, even (in spite of one imprisonment and frequent plunderings) through all the Great Rebellion. In October 1660 he was consecrated Bishop of Lincoln, and in 1661 he was moderator of the Savoy Conference; to him are due the present preface to the Prayer-book and the General Confession. He died at his palace of Buckden, Hunts, 29th January 1663. His works, collected and edited by Professor Jacobson (6 vols. Oxford, 1854), comprise, besides sermons, the *Logicæ Artis Compendium* (1615), *De Obligations Conscientiæ Prælectiones* (1647; new ed. by Whewell, 1851), *Nine Cases of Conscience resolved*:

(1628-78), and *Episcopacy not Prejudicial to the Royal Power* (1661). See the Life by Izaak Walton, reprinted in vol. iv. of Wordsworth's *Ecclesiastical Biography* (1853).

Sandgate, a small watering-place on the south coast of Kent, within the parliamentary limits of Hythe, from which it is, however, nearly 3 miles E. by rail. In March 1893 two hundred houses were destroyed by a subsidence of the land. Sandgate Castle dates from 1539; near by is Shorncliffe Camp. Pop. (1891) 1756.

Sand-glass. See HOUR-GLASS.

Sand-grouse (*Pterocletes*), a small order of birds, quite distinct from the true grouse. There are two genera, *Pterocles* and *Syrnhaptes*—the former, including over a dozen species, frequenting sandy tracts in Asia, India, and especially in Africa, the latter represented by two species, both Asiatic. The sand-grouse are birds of beautiful plumage, with heavy body, long and pointed wings, very short legs and toes. They are awkward on the ground, but swift and graceful in flight. They seem to feed chiefly on seeds. *Pterocles alchata* is sometimes called Ganga.

Pallas's Sand-grouse (*Syrnhaptes paradoxus*), named after the traveller Pallas (q.v.), is at home on the sandy steppes of central Asia, migrating northwards in winter, but at intervals since 1859 this bird has wandered westwards over Europe; in 1863, 1872, 1876, 1888, and 1889 flocks reached British shores; flocks have been seen in Ireland also, and hundreds, 'following their instinctive desire to explore the extreme west,' have found an end in the waves of the Atlantic. The predominant colour is buff, barred with black; the total length of the bird is about 15 inches. The eggs, usually three in number, are buff-coloured with purple-brown blotches, and are laid in a slight hollow in the sand. On the plateaus of Tibet *S. tibetanus*, the other species of this genus, has its home. See Macpherson, *The Visitation of Pallas's Sand-grouse to Scotland* (1889).

Sand-hopper (*Talitrus locusta*), a small crustacean in the order Amphipoda, which so abounds on the sandy seashores of Britain that the whole surface of the sand often seems to be alive with the multitudes which, leaping up for a few inches into the air, look like swarms of dancing flies. This activity is not, however, displayed at all times; but if a mass of seaweed left by the retiring tide be turned over, countless sand-hoppers may be seen to leap away, or they may be found by digging in the sand, in which they burrow. The animal leaps by bending the body together, and throwing it open with a sudden jerk. It feeds on almost any vegetable or animal substance, particularly on what is already dead and beginning to decay. It is itself eaten by crabs, beetles, and by many shore-birds. To some other species of *Talitrus* and to some species of *Orchestia* the name sand-hopper is equally applicable, but *T. locusta* is commonest.

Sandhurst. See MILITARY SCHOOLS.

Sandhurst, now usually called Bendigo, from the district in which it is situated, stands on Bendigo Creek, 101 miles by rail NNW. of Melbourne, in Victoria, Australia, in the centre of a rich auriferous country. It owes its rise to the discovery of gold here in 1851. The mines give employment to 4600 persons, and yield about 144,500 oz. in the year. Pop. (1881) 28,662; (1891) 26,735. The chief public edifices are the government buildings in Rosalind Park, the banks, hospital, mechanics' institute, churches, and government offices. The town possesses fine botanical gardens, and is excellently supplied with water.

Besides gold-mining, the principal industries are brewing, iron-founding, coach-building, brick and tile making, and in the district farming and vine-growing. Sandhurst was proclaimed a municipality in 1855, a borough in 1863, and a city in 1871.

San Diego, the principal port of southern California, and capital of San Diego county, stands on the beautiful bay of the same name, 124 miles by rail SSE. of Los Angeles. The bay, 6 miles long, forms an excellent harbour, and the port is now a very busy one, exporting much wool and other chief products of the country. The climate is genial, the temperature moderate, although the orange and olive flourish here; water is supplied by a long 'flume,' which cost nearly \$1,000,000. Pop. (1890) 2637; (1890) 16,159. The old mission of San Diego (1769), the first white settlement in California, is 8 miles north of the present city.

Sand'iver (Fr. *suint de verre*, 'scum of glass'), a product of the glass furnaces. When the materials used in the manufacture of glass are melted a scum arises which has to be removed: this is called sandiver, and is, when powdered, used as a polishing material.

Sand-martin. See SWALLOW.

San (or **Santo**) **Dwango**, capital of the Dominican Republic, stands on the south coast of the island of Hayti, at the mouth of the Ozama. It was founded by Columbus as early as 1494. The principal buildings are the Gothic cathedral (1514-40), where the ashes of Columbus found a rest from 1536 till 1796, a college, a hospital, an arsenal, and the government buildings. The streets are broad and straight, the houses mostly of wood, and the town is surrounded by a wall. The harbour is defended by forts and batteries. Pop. 15,000.—See also HAYTI, and DOMINICAN REPUBLIC.

Sandoway, a district in the south of Arakan (q.v.) in Burma, named after its chief town (pop. 2000), 15 miles from the mouth of a small river of the same name, and 150 miles NW. of Rangoon.

Sandown, a watering-place on the south-east coast of the Isle of Wight, 6 miles by rail S. of Ryde. Pop. (1881) 3120; (1891) 3592.

Sandown Park, a well-known race-course (130 acres) in Surrey, near Esher, 15 miles SW. of London. All the inmates of an old hospital here were swept off by plague in 1348. See HORSE-RACING.—For Sandown Castle, see DEAL.

Sand-paper is made like Glass Paper (q.v.), but with sand in place of glass particles.

Sandpiper, the common English name for a group of birds of the Snipe family, Scolopaciæ. The name as now used is applied to all the birds in three sub-families, Totaninæ, Tringinæ, and Phalaropodinæ. In characters and habits they are all very similar. Their size is not large; their movements are active and graceful; their plumage is not gay, but pleasing and finely diversified in colour; legs rather long; lower part of the tibia naked; tail very short; wings moderately long; bill rather long and slender, grooved throughout the whole or a considerable part of its length, straight in some, a little arched in others. The feet have three long toes before, and one short toe behind, either partially webbed at the base or completely separate. They swim well, but are not often seen swimming; they frequent sandy seashores, some of them congregating in numerous flocks in autumn and winter, and seek their food by probing the sand with their bills, and by catching small crustaceans in pools or within the margin of the sea itself. Many are birds of passage, visiting high northern latitudes in summer, and spending the winter in the south. The flesh of all the species is good, and some of them are in much

request for the table. The following is a summary of the British species. (1) Of the *Totaniina*: bill stiff and acute, no change to summer plumage. The Common Sandpiper or Summer Snipe (*Totanus hypoleucus*) is a regular summer visitor to the British Isles, especially to Scotland, Ireland, Wales,

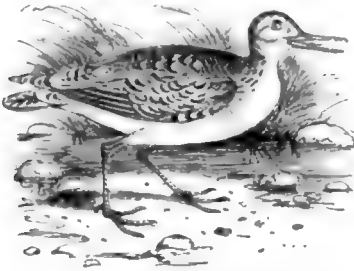

Common Sandpiper (*Totanus hypoleucus*).

and the south-east of England. In summer it ranges from the Arctic circle to the south of Europe; in winter it frequents the Mediterranean basin, and reaches Abyssinia and Madagascar and ranges through the oriental region to Australia and Tasmania. The Wood Sandpiper (*T. glareola*) is a much less common visitor to the British Isles, and is much more restricted in its range northwards than the common sandpiper. In winter it reaches Cape Colony. The Green Sandpiper (*T. ochropus*) differs in nesting habits from all other waders. It lays its eggs in the nests of other birds, such as thrushes, blackbirds, jays, wood-pigeons, and in old squirrels' dreys, and occasionally on stumps and broken-down trees, but always near pools. The Solitary Sandpiper (*T. solitarius*) and the Yellowshank (*T. flavipes*) are American species which are found extremely rarely as stragglers to Britain. The Common Redshank (*T. calidris*), resident in Britain, is a summer bird of passage to the most northern parts of Europe and Asia, and occurs in winter in Morocco and Cape Colony and



Redshank (*Totanus calidris*).

in Abyssinia and Natal; also in Japan, China, Borneo, and Java. The Spotted Redshank (*T. fuscus*) and the Greenshank (q.v.) are the only other species found in Britain.

(2) Of the *Tringine*: bill flexible and blunt; the plumage usually assumes a chestnut or reddish-brown tint in summer; more frequently found on the shore. The Dunlin, the Curlew Sandpiper, the Knot, the Sanderling, and the Ruff are described in

other articles. The Broad-billed Sandpiper (*Tringa* or *Limicola platyrhyncha*) is a straggler to the British Isles. The Pectoral Sandpiper (*T. maculata*), Bonaparte's Sandpiper (*T. fuscicollis*), the American Stint (*T. minutilla*), the Buff-breasted Sandpiper (*Tryngites rufescens*), and Bartram's Sandpiper (*Bartramia longicauda*) are all stragglers from America, some being fairly common, others extremely rare. The other species are the Little Stint (*Tringa minuta*), Temminck's Stint (*T. temmincki*), and the Purple Sandpiper (*T. striata*).

(3) Of the *Phalaropine*: swimming sandpipers; toes lobed and webbed at the base; lower plumage as close as that of a duck. The Gray Phalarope (*Phalaropus fulicarius*), an irregular visitor, breeding in the northern regions, the courtship being conducted by the larger and handsomer female, while incubation is performed chiefly by the male; the southern range of this bird extends to Chili, North Africa, and New Zealand. The Red-necked Phalarope (*P. hyperboreus*), also an irregular visitor. The only other and largest species of this sub-family, Wilson's Phalarope (*P. wilsoni*), is confined to America.

Sandpipes are cylindrical hollows existing in chalk deposits. They descend perpendicularly into the chalk at right angles to the surface, tapering downwards, and ending in a point; they reach occasionally a depth of 60 feet, and have a diameter varying from 1 to 12 feet. They are most probably produced by the chemical action of water, charged with carbonic acid, which exists more or less in all rain-water, and is especially abundant in water that has been in contact with decaying organic matter. The pipes are filled with sand, clay, or gravel from the overlying deposit.

Sandringham, a Norfolk estate, 3 miles from the sea and $7\frac{1}{2}$ miles NNE. of Lynn. Comprising over 7000 acres, it was purchased in 1862 by the Prince of Wales for £220,000 of the Hon. C. S. Cowper. The then existing mansion was demolished, and the present hall built in 1869-71, a red-brick Elizabethan country-house, standing in a pleasant park of 200 acres; special features are the iron 'Norwich gates,' the dairy, and the splendid cottages. A fire on 1st November 1891 did damage to the amount of over £10,000. Sandringham was the scene of the six-weeks' illness of the Prince of Wales (Nov.-Dec. 1871), and of the death of his eldest son, the Duke of Clarence (14th January 1892). See Mrs Herbert Jones, *Sandringham, Past and Present* (2d ed. 1888).

Sandrocottus, or CHANDRAGUPTA, the Hindu king of Pataliputra or Palibothra, to whom in 306 B.C. Megasthenes (q.v.) was sent by Seleucus Nicator.

Sandstone is a rock formed of compacted, and more or less indurated sand. The grains generally consist of quartz, though other mineral substances are often mixed with this; they are colourless, or of a dull white, yellow, brown, red, or green colour. The grains vary in size, forming, as the case may be, a fine or coarse grained stone. The loose sand becomes solidified by pressure simply, but generally there is some binding material present, as argillaceous matter; or the grains may have become cemented by infiltrating water, carrying with it carbonate of lime, or silica, or ferric oxide. The colour of the rock is often due to the cement. Highly indurated sandstones often pass into Quartzite. See the classification at PETROGRAPHY; also OLD RED SANDSTONE.

Sandstorm. See SIMOON.

Sandusky, a city and port of Ohio, and capital of Erie county, on the south shore of Sandusky Bay, an arm of Lake Erie, 56 miles by water (by rail 65) W. of Cleveland. The bay, 15 miles long and 5

wide, forms an excellent harbour. The city is built upon a bed of limestone, on a site rising gradually from the shore. It has several machine-shops, railway-car factories, manufactories of cutlery and edge-tools, wheels, and especially of carved and turned woodwork. From its busy wharves are shipped large quantities of fish, lime, limestone, lumber, salt, coal, ice, wool, wheat, flour, and native wine. Pop. (1880) 15,838; (1890) 18,471.

Sand-wasp. See WASP.

Sandwich, a decayed seaport of Kent, on the right bank of the Stour, 12 miles E. of Canterbury and 68 (by rail 84) ESE. of London. It now stands 2 miles from the sea, or 4 if one follows the windings of the river; but in the 11th century, when Edward the Confessor made it one of the Cinque Ports (q.v.), it was the 'most famous of all the English harbours.' It was the place of landing or embarkation of St Wilfrid, Canute, Becket, Courde-Lion, &c.; under Edward IV. had 95 ships and 1500 mariners; but has never recovered the silting up of its harbour in the 16th century, in spite of the settlement at it of Protestant refugees (c. 1561), and of some harbour improvements since 1847. Today its chief fame is as a headquarters of golf. The old walls have been converted into a pleasant promenade, but it retains the Fisher Gate and Barbican, and offers a good deal of interest in its two churches and hospitals, guildhall (1579), grammar-school (1564), a house that lodged Queen Elizabeth, and other quaint old buildings. Richborough, 1½ mile N., was the Roman *Rutupia*, the predecessor of Sandwich, like which it declined as the sea receded from its port. A great fortress, 460 feet square, it still has a wealth of Roman remains—walls, towers, the base of a pharos, and a castranian amphitheatre. Sandwich was made a borough by Edward III., and with Deal and Walmer returned two members, but was finally disfranchised in 1885. Pop. (1851) 2966; (1891) 2796.

See works by Boys (1792), Smith (1830), Bell (1831), and Montagu Burrows (1888).

Sandwich, EDWARD MONTAGU, EARL OF, born 27th July 1625, fought for the parliament at Marston Moor, sat in the House of Commons 1645-48, divided the command of the fleet with Blake from 1653, and used his position to forward the Restoration; hence his earldom. He commanded in several battles against the Dutch, was ambassador to Spain in 1666-69, and lost his life in a naval engagement with the Dutch, 28th May 1672. The fourth earl (1718-92) is famous as the inventor of *sandwiches*, which he could eat without having to rise from the gaming-table.

Sandwich Islands. See HAWAII.

Sand-worm, a general name for any of the numerous worms living in the sand of the shore. Most of them are Chaetopods, with setæ on their feet, but the title might also include forms without setæ, such as the Nemertean and the Sipunculids. The fisherman's Lobworm (q.v.) is one of the most important of the more sedentary sand-worms; the tubes of *Terebella conchilega*—mostly composed of fragments of shell—are familiar on the flat beach; while hidden under stones or burrowing deeply in the sand there are numerous species of errant Chaetopods, belonging to the genera *Nereis*, *Nephtys*, *Polynoe*, *Syllis*, &c.

Sandwort (*Arenaria*), a numerous genus of plants belonging to the natural order Caryophyllaceæ. The species are small, much-branched annuals, or tufted or prostrate perennials, usually glabrous and having small white flowers like those of the common chickweed, to which they are closely related. The Sea Sandwort (*A. marina*) has sprouts so succulent that in Cornwall and the Isle of Wight they are pickled and sold as samphire.

Sandy Hook, a narrow sandy peninsula of New Jersey, between the Atlantic and Sandy Hook Bay, 16 miles S. of New York. It extends some 6 miles northwards into New York Lower Bay. Near the north point are a fort, a fixed electric light 90 feet high (1894), and a life-saving station.

Sandy Point. See PATAGONIA.

San Felipe, (1) capital of the Chilian province of Aconcagua, in the fertile valley of the Aconcagua, 60 miles ENE. of Valparaiso. Pop. 12,000.—(2) A town of Lara state in Venezuela, 140 miles W. by S. of Carácas, in a district producing much coffee, cacao, sugar, and indigo. Pop. 7000. See also JATIVA.

San Fernando, a Spanish town on the same Isle of Leon on which Cadiz stands, is near the head of the bay and 9 miles by rail from Cadiz. Much salt is manufactured from sea-water. Pop. 29,287.

San Francisco, the largest city of the Pacific coast, and the commercial emporium of California, is situated in 37° 47' 22" N. lat. and 122° 25' 40' 76" W. long. The city occupies the end of a peninsula, having the ocean on one side and the Bay of San Francisco on the other. The site is uneven, embracing many hills, of which the highest ones, known as the Twin Peaks, are 925 feet high and form a crown of an amphitheatre of hills. In the built-up portion of the city several of these hills are covered with handsome residences, from which a magnificent view of the surrounding country with the bay and ocean can be had. The entrance to the bay is through the Golden Gate, a waterway about

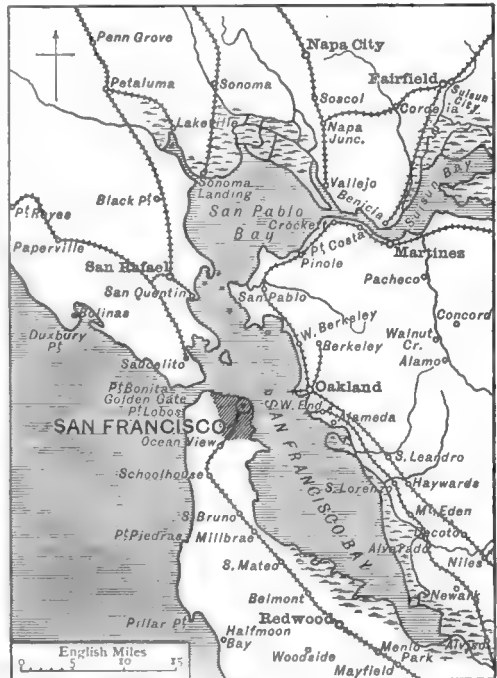

5 miles long by 1 mile wide. The Bay of San Francisco gives the city much of its commercial importance. It extends from Fort Point past the city in a southerly direction for about 40 miles, varying in width from 6 to 12 miles. Northwards, this bay connects by a strait with San Pablo Bay, 10 miles in length, having at its northerly end Mare Island and the Navy Yard. This bay is again connected with Suisun Bay, 2 miles long.

The total length of these bays and connecting straits is 65 miles. The Sacramento and San Joaquin rivers debouch near the head of Suisun Bay. Nearly in front of the city are three important islands—Alcatraz (fortified), Angel Island (fortified), and Yerba Buena or Goat Island.

The original site of the city was a grant made by the king of Spain of four square leagues of land. This grant was afterwards confirmed by congress, and is now wholly within the limits of the municipality, which extends its jurisdiction also over the islands in the bay. In the early part of 1849 the population of San Francisco was about 2000; at the close of that year the population had increased to 20,000. A large part of the mining immigration made it a point for supplies and departure for the mines in the interior (for the discovery of gold and the social conditions of that period, see CALIFORNIA). The city was originally built of wood, the first houses and stores being constructed in the Atlantic States, brought round Cape Horn, and set up as wanted. Three great fires in 1850 swept the greater part of these wooden structures away. Many of the business houses were thereafter built of brick and iron, but to this day the dwellings are chiefly of wood, for climatic reasons. Most of the pioneer business structures have disappeared; many large and costly buildings have been erected; and marble, granite, and terra-cotta are coming into extensive use, with interior frames of iron and steel. The public edifices for the most part are not of an imposing character; there are seven theatres and opera-houses, a sub-treasury, mint, custom-house, stock exchange, city hall, and other structures of less note. The largest edifice in the city is the Palace Hotel, costing upwards of three million dollars, with accommodation for 1200 guests. There are eleven public squares. The Golden Gate Park covers an area of 1050 acres; originally a barren tract of sand-dunes, it has been gradually converted into one of the most attractive places in the state. It is about 3 miles in length and 1 mile in breadth; and it is bounded on the west side by the ocean.

The number of churches and chapels is about one hundred and twenty. Of these eighty or more are Protestant, and not less than twenty-five are Catholic. Nearly every religious denomination in the world has a representative in the city. There are few church edifices of the first class. The new Roman Catholic cathedral, the Unitarian church, Grace Church, and the First Congregational Church are the more notable edifices for religious worship. The charities of the city are numerous and well supported. San Francisco is distinguished for the number and excellence of its free schools and other institutions of learning. There are sixty-five public schools which are practically free. In these the instruction is carried far enough to qualify pupils for admission to the state university at Berkeley, which is the culmination of the free-school system. In addition to these there are a large number of schools under private or denominational control. The higher institutions include the law, medical, and dental departments of the university, the Cooper Medical College, the Hahnemann Medical College, the School of Mechanic Arts, founded by a bequest from James Lick of \$540,000, and the Academy of Sciences, enriched by another large bequest from the same benefactor. The city has also a free library with 75,000 vols.; the Mercantile Library and the Mechanics' Library have nearly the same number, the Oddfellows' Library 40,000 vols., and the Law Library 25,000.

Most of the streets are laid out in rectangular form, and with little reference to the conformation of the surface. The horse tramway was the

pioneer method of street transit. But the abrupt elevation required some better facilities; and the cable-road (see TRAMWAYS) was first invented and put into successful operation in San Francisco. Gas, electric light, and water are supplied by private corporations. The water supply comes from springs, creeks, and reservoirs at points about 20 miles distant from the city. The Chinese quarter is one of the most curious, if least admirable, features of the city, has its own joss-houses, theatres, and opium dens, and a population of 25,000, mainly adult men. One of the most interesting historical relics is the old church of the (Spanish) mission Dolores, built of adobe, and dating from 1778.

San Francisco is the western terminus of the continental railroads, being 2434 miles W. of St Louis, and 3452 of New York. Lines of steamships ply between the port and Mexico, Central and South America, Australia and New Zealand, Japan, and China. The exports include gold, silver, grain, wool, wine, and fruit. Shipbuilding is carried on, and large war-vessels have been built here. Since 1895 the harbour is defended by pneumatic dynamite-guns. A stone dry-dock admits vessels of 6000 tons, and smaller docks take up the coasting fleet for repairs. Several whaling companies send out fleets to the Arctic, comprising both sail and steam vessels, and about a million dollars in value of oil and bone are annually brought in by these vessels. San Francisco is one of the most important grain ports in the United States. The annual exports of wheat range from 750,000 to 1,000,000 tons, and more than three hundred ships are employed in transporting this wheat to foreign countries. Iron and steel vessels of British register have the preference for wheat charters.

The city is rapidly acquiring large manufacturing interests. It gives employment to about 30,000 persons in the various manufactories, with an estimated annual product of \$134,000,000. There are large sugar-refineries, rolling-mills, foundries, machine-shops, where the largest steam-engines are constructed, ship-yards, cordage-works, sash and door factories, woollen-mills, tanneries, breweries, boot and shoe factories, and type-foundries. The whole range of mechanic arts, with few exceptions, is now represented in San Francisco. Pop. (1860) 56,802; (1870) 149,473; (1880) 233,959; (1890) 298,997, including about 25,000 Chinese; (1900) 342,782. See works cited at CALIFORNIA (Soulé, Hittell, Bancroft), and the Johns Hopkins Studies, Feb.-Mar. 1899.

San Fratello, a town of northern Sicily, 53 miles WSW. of Messina. Here is the cave of San Teodoro, discovered in 1859, and containing prodigious quantities of bones of mammals mixed with flint implements. Pop. 7554.

Saugaree (Span. *sangria*), a West Indian beverage, consisting of wine, sugar or syrup, water, and nutmeg, drunk cold.

Sangerhausen, an old town of Prussian Saxony, on the SE. of the Harz Mountains, 22 miles E. of Nordhausen, with manufactures of machinery, iron, copper, and beet-root sugar. Pop. 10,188.

San German, a city in the SW. part of Porto Rico, 10 miles direct SE. by S. of Mayaguez, and 66 miles WSW. of San Juan. Pop. (1899) 3954.

San Germano, now more generally called CASSINO, a town of Italy, standing 3 miles E. of the celebrated monastery of Monte Cassino (q.v.) and 69 miles NW. of Naples. It is built on the site and from the ruins of the ancient Volscian town of *Casinum*. The principal ruins are a monument and an amphitheatre. The first, now employed as a church, is built in the form of a Greek cross, constructed with enormous Cyclopean

blocks of stone. Here, too, was Terentius Varro's villa, in which Antony lived for some time. Pop. 6380.

San Gimignano, a town of Italy, 25 miles S. by W. of Florence, with several churches, some containing fine frescoes by Ghirlandajo and Gozzoli. Pop. 3591.

San Giovanni a Teduccio, a suburb of Naples, 3 miles to the SE. by rail. Pop. 14,397.

San Giovanni in Fiore, a town of South Italy, 25 miles E. of Cosenza. Pop. 10,500.

San Giovanni Rotondo, a town of South Italy, 27 miles NE. of Foggia, near Monte Garano. Pop. 8312.

Sangir Islands, a group of fifty islands, lying between the Philippines and Celebes, measure in all 323 sq. m. and contain 50,000 inhabitants, the largest, Great Sangir, being 28 miles long by 9 broad, and having nearly one-fourth of the population. All the islands are mountainous, volcanic, and fertile. The volcano Abu on Great Sangir was the scene of an eruption in 1856 that cost 3000 lives, and of another terrible one in 1892. The people are Malays, and are ruled by their own chiefs under the Dutch government.

Sang-koi. See TONGKING.

Sangreal. See GRAIL.

Sanguinaria, a genus of plants of the natural order Papaveraceæ, having eight to twelve petals, two stigmas, an oblong, swollen, and many-seeded capsule with two deciduous valves. *S. canadensis*, the Blood-root or Puccoon of North America, has a fleshy root-stalk abounding in a red juice, which abounds also in the leaf-stalks; and solitary radical leaves, which are roundish, deeply heart-shaped, and with about seven toothed angles. The flowers are solitary and spring from the root, on short stalks. The whole plant is acrid and narcotic, emetic and purgative in large doses; and



Blood-root
(*Sanguinaria canadensis*):
a, section of ovary; b, fruit.
(Bentley and Trimen.)

in small doses stimulant, diaphoretic, and expectorant. From its use by the Indians for staining, it is also called 'red Indian paint.' It is supposed to owe its properties to an alkaloid called *Sanguinarin*. The large white flowers appear early in spring, and are a frequent ornament of flower-borders.

Sanguine, a term used in art for a drawing in red chalks.

Sanguisorbaceæ, or SANGUISORBEÆ, according to some botanists a natural order of plants, but more generally regarded as a sub-order of Rosaceæ (q.v.). About 150 species are known, all of which are herbaceous or half shrubby, some of them spiny. The leaves of *Acana sanguisorba*, a native of Van Diemen's Land, are said to be an excellent substitute for tea. Of British species Burnet (q.v.) is the best known.

Sanhedrim, or SANHEDRIM (*Sanhedrin* being the Hebrew spelling of the Gr. *synedrion*, 'assem-

bly,' 'council'), the supreme national tribunal of the Jews, established at the time of the Maccabees, probably under John Hyrcanus. It consisted of seventy-one members, and was presided over by the Nasi ('prince'), at whose side stood the Ab-Beth-Din ('father of the tribunal'). Its members belonged to the different classes of society: there were priests (Gr. *archiereis*); elders, that is, heads of families, men of age and experience (Gr. *presbyteroi*); scribes, or doctors of the law (Gr. *grammateis*); and others, exalted by eminent learning—the sole condition for admission into this assembly. The presidentship was conferred on the high-priest in preference, if he happened to possess the requisite qualities of eminence; otherwise, 'he who excels all others in wisdom' was appointed, irrespective of his station. The limits of its jurisdiction are not known with certainty; but there is no doubt that the supreme decision over life and death, the ordeal of a suspected wife, and the like criminal matters were exclusively in its hands. Besides this, however, the regulation of the sacred times and seasons, and many matters connected with the *cultus* in general, except the sacerdotal part, which was regulated by a special court of priests, were vested in it. It fixed the beginnings of the new moons; intercalated the years when necessary; watched over the purity of the priestly families, by carefully examining the pedigrees of those priests born out of Palestine, so that none born from a suspicious or ill-famed mother should be admitted to the sacred service; and the like. By degrees the whole internal administration of the commonwealth was vested in this body, and it became necessary to establish minor courts, similarly composed, all over the country, and Jerusalem itself. Thus we hear of two inferior tribunals at Jerusalem, each consisting of twenty-three men, and others consisting of three men only. These courts of twenty-three men (Lesser Synedrion), however, as well as those of the three men, about both of which Josephus is silent, probably represent only smaller or larger committees chosen from the general body. Excluded from the office of judge were those born in adultery; men born of non-Israelitish parents; gamblers; usurers; those who sold fruit grown in the Sabbatical year; and, in individual cases, near relatives. All these were also not admitted as witnesses. Two scribes were always present, one registering the condemnatory, the other the exculpatory votes. The mode of procedure was exceedingly complicated; and such was the caution of the court, especially in matters of life and death, that capital punishment was pronounced in the rarest instances only. The Nasi had the supreme direction of the court, and convoked it when necessary. He sat at the head, and to his right hand was the seat of the Ab-Beth-Din; in front of them the rest of the members took their places according to their dignity, in a semicircle. The court met on extraordinary occasions in the house of the high-priest; its general place of assembly, however, was a certain hall (*Lishcat Hagazit*), probably situated at the south-west corner of one of the courts of the temple. With exception of Sabbath and feast days it met daily. The political troubles forced the Sanhedrim (70 B.C.) to change its meeting-place, which was first transferred to certain bazaars (*Hannyoth*) at the foot of the temple mount. After the destruction of the temple and Jerusalem it finally established itself, after many further emigrations, in Babylon. The question as to the origin and development of the Sanhedrim is a difficult one. It is said it was intended to be a faithful reproduction of the Mosaic assembly of the seventy (Moses himself making seventy-one), supposed to have been re-established by Ezra after the Exile. There are

widely different opinions respecting the jurisdiction and competence of the Sanhedrim at the time of Christ and the apostles. It has even been questioned how far, save for a few matters of small importance, it may be said to have existed at all, curtailed and circumscribed as it was by the Romans, who seem to have recognised only the 'high-priest.' Nor is it agreed whether it was really from the Sanhedrim at all some of those well-known acts recorded in the New Testament had their origin; and it is difficult to account, by what we know of its constitution, for many of the proceedings against the apostles ascribed to this body.

See the histories of the Jews by Ewald, Herzfeld, Jost, Graetz, Kuenen, and others; Hausrath's *Neutestamentliche Zeitgeschichte* (1868); Schürer's *History of the Jewish People in the Time of Jesus Christ* (Eng. trans. 1886-90).

Sanhitā is the name of that portion of the Vedas which contains the Mantras or hymns. See VEDA.

Sanidine, a clear, glassy variety of orthoclase. See FELSPAR.

Sanitation, in the widest sense of the word, is the science of sanitary conditions and of preserving health, and is accordingly synonymous with Hygiene; but the term is usually restricted to the methods and apparatus for making and maintaining houses healthy, for removing waste and nuisance by means of drainage and otherwise, for securing abundance of fresh air, and for the excluding of poisonous gases, especially sewer gas—in short, the province of the sanitary engineer. Sanitary science falls under various heads in this work: a sketch of the progress of sanitary knowledge and legislation is sketched under HYGIENE. Other branches of the subject are treated in the articles on Food and Diet, on Contagion, Infection, Disinfectants, Antiseptics, the Germ Theory of Disease, on Baths, Gymnastics, Hospitals, Nursing, and the Feeding of Infants, on Lodging-houses, the Factory Acts, Slaughter-houses, Nuisance, and Vital Statistics. The relation of churchyards to health, and legislation in that regard, is dealt with in the article Burial, and in that on Cremation. The subjects of Building, Ventilation, Warming, and Water-supply are dealt with under their own heads, and one of the most important subjects in sanitary science—how to remove waste substances without offence to health by drainage, how, by trapping and other methods, to prevent the entrance of poisonous sewer gases into bedrooms and dwelling-rooms through fixed wash-hand-basins and bath-rooms—is treated in the article on Sewage. The diseases that arise from blood-poisoning by foul air, poisonous gases, and lack of precautions to secure cleanliness are dealt with in the articles on Disease, Typhoid and Typhus Fevers, Jail Fever, Diphtheria, Pyæmia, &c.

Sanjak, a Turkish word signifying 'a standard,' is employed to denote a subdivision of a vilayet.

San Joaquin, a river of California, rises in the Sierra Nevada, and runs first SW., then NNW. to Suisun Bay, near the mouth of the Sacramento River. It receives numerous branches—the Merced, Tuolumne, Stanislaus, &c.—and has a course of 400 miles, mostly navigable for small steamboats.

San José, capital of Santa Clara county, California, on the Guadalupe River, 8 miles from the Bay and 50 miles by rail SE. of the city of San Francisco. Besides a fine court-house and a city hall, it contains the state normal school and a Roman Catholic college (Notre Dame) for girls; and the University of the Pacific (Methodist

Episcopal; 1862) and the Roman Catholic Santa Clara College are both at Santa Clara, close by. Lick Avenue extends from San José to the Lick Observatory (q.v.). The city enjoys a dry and delightful climate, has wide streets and three parks, and is noted for its gardens and fruit. Its manufactures include a number of foundries, fruit-canneries, woollen and flour mills, a furniture-factory, &c.; and much wine is made in the neighbourhood. Pop. (1880) 12,567; (1890) 18,000.

San José, (1) the capital since 1823 of Costa Rica, in a fertile plain (altitude, 3711 feet), is 104 miles by rail W. by S. of Limon, the Atlantic seaport. The streets are regular and well kept, with many squares and two large parks; the houses are low, and nearly all of brick, with gray-tiled, sloping roofs. It has government buildings, presidential, national, and episcopal palaces, cathedral, seminary, the old university buildings (now a museum and national library), two colleges for young men and women, the covered market, a small Protestant church, and the hospitals (one for lepers) and asylums. The principal manufactory is the government distillery (a monopoly); the others include steam flour-mills and two foundries. Population, 30,000.—(2) A port of Guatemala, on the Pacific, 80 miles by rail from the capital. It has only an open roadstead, with an iron pier running out past the surf, but not to where ships can approach. It has, however, a considerable trade: the imports alone reach £250,000. Pop. 1500.—(3) A town of Lower California, on the south-east coast, with an insecure harbour, but much visited by the whalers. Pop. 2500.—(4) A thriving inland town of Uruguay, capital of the southern department of the same name, 60 miles by rail NNW. of Montevideo. Pop. 6000. See also CÚCUTA.

San Juan, (1) a frontier province of the Argentine Republic, bordering on Chili. Area, 37,697 sq. m. The surface is partially occupied by the Andean and pampa mountains, and the province is rich in minerals, mainly unworked, except the coal. Agriculture—lucerne, corn, and grapes—is the chief occupation. Pop. (1896) 85,480. San Juan, the capital, on the river San Juan, is 735 miles by rail W. by N. of Buenos Ayres and 98 N. of Mendoza. It exports cattle and fodder to Chili, and has a custom-house, a national college, normal school, school of engineering, and a seminary, a library, hospitals for men and women, a gaol, public baths, a bull-ring, &c. Pop. 12,000.—(2) Of several San Juans in Mexico the chief is in Queretaro, 191 miles by rail NW. of Mexico city, with fruit and market gardens, and 10,000 inhabitants.—(3) For San Juan del Norte in Nicaragua, see GREYTOWN.—(4) For San Juan in Juan de Fuca Strait, see FUCA.

San Juan, or SAN JUAN BAUTISTA DE PUERTO RICO, the capital and chief seaport of Porto Rico, on a small island of the north coast, connected with the mainland by bridges and a fortified causeway. It is well laid out, but lacks sanitary arrangements, and has an excellent harbour. The manufactures are unimportant. Pop. (1899) 32,048.

Sankara, or SANKARA ACHARYA ('the spiritual teacher Sankara'), one of the most renowned theologians of India. His date, placed by tradition about 200 B.C., but by the best authorities in the 8th or 9th century after Christ, is unknown. Most accounts make him a native of Malabar, and a member of the caste of the Nambūri Brahmans. All accounts represent him as having led an erratic life, and engaged in successful controversies with other sects. He may be regarded as having finally brought into its completed form the Vedānta philosophy or Mimāṃsā; he taught that there was one sole supreme God, and is the origin of the sect of Smārta Brahmans. Towards the close of his life

he repaired to Cashmere, and finally to Kedarnáth, in the Himalayas, where he died at the early age of thirty-two. His principal works, which exercised a great influence on the religious history of India, are his commentary on the Vedanta Sûtras and his commentaries on the Bhagavad-gîtâ and the principal Upanishads. His learning and personal eminence were so great that he was looked upon as an incarnation of the god Siva, and was fabled to have worked several astounding miracles.

Sankey, IRA DAVID. See MOODY.

Sânkhya is the name of one of the three great systems of orthodox Hindu philosophy. See SANSKRIT LITERATURE.

Sanlúcar de Barrameda, a seaport of Spain, stands 15 miles N. by W. of Cadiz, on the left bank of the Guadalquivir, and at the mouth of that river; it exports wines. Pop. 22,667.

San Luis, a west-central province of the Argentine Republic, with an area of 29,304 sq. m. and a pop. (1896) of 76,500. It is mountainous in the north, and a series of dry and sterile plains in the south. Its mineral wealth, though unquestionably great, has as yet scarcely been tapped, and agriculture requires constant irrigation.—The capital, San Luis, founded in 1597, is on the trans-continental railway, 480 miles W. by N. of Buenos Ayres, and has a national college and a normal school, and 6000 inhabitants.

San Luis Potosí, capital of the Mexican state of the same name, stands on the edge of a plateau, 7400 feet above the sea, by rail 362 miles NNW. of Mexico city and 275 W. of Tampico. It is well built, though with steep streets, and contains a handsome cathedral, a seminary, railway workshops, a cotton-factory, and great smelting-works. There are silver-mines near by. Founded in 1586, the city has taken a prominent part in the country's civil wars, and in 1863 was the seat of Juárez' government. Pop. (1895) 69,050.—The inland state of San Luis Potosí, largely mountainous and so far healthy, has an area of 27,503 sq. m. and a pop. (1895) of 570,814. Some districts are very fertile, and much gold and silver is mined, besides salt and other minerals.

San Marco in Lamis, a town of South Italy, 16 miles inland from the Gulf of Manfredonia and 18 N. of Foggia. Pop. 15,345.

San Marino, the smallest independent state of Europe and a republic (Monaco, though smaller, is a protectorate of France), lies among the eastern spurs of the Apennines, 9 miles SW. of Rimini on the Adriatic. It has an area of 33 sq. m., and comprises a town of the same name (pop. 1600) and some villages. The town is built on a mountain crag, and is accessible only by one road; the streets are steep and narrow. Agriculture and cattle-breeding are the principal occupations. In the 13th century the little community of San Marino cast in its lot with the house of Urbino; but on the annexation of this duchy to the Papal States in 1631 its independence was recognised by the pope, and it has been maintained down to the present day. Its constitution is that of a republic; but it acknowledges the king of Italy as its friend and protector. The real governing body is the Grand Council of sixty life-members, self-elected, of whom one-third are nobles. From this number are selected the Council of Twelve, who superintend agriculture, and, with the assistance of two foreign lawyers, form the supreme court of the state. The executive is committed to two captains-regent, who are chosen, the one from the nobles, the other from the bourgeoisie. They each hold office for six months. The militia of the

republic numbers 950 men. Total pop. (1886) 7840; (1896) 8500.

See *Macmillan's Magazine* for Jan. 1891, and works by Delfico (2 vols. Milan, 1804), Bruc (Paris, 1876), Jonas (Vienna, 1878), and Cazeneuve (Paris, 1887).

San Miguel, a town of Salvador, at the foot of the active volcano (7775 feet) of San Miguel, is famous for a great annual fair. Pop. 10,000.

San Miguel Alende, a town in the Mexican state of Guanajuato, built on the side of a high hill overlooking the Rio de la Lara, 253 miles by rail NW. of Mexico city. It has manufactures of ponchos, saddles, small-arms, &c. Pop. of municipality, 39,290.

San Miniato, a city of Central Italy, 22 miles W. by S. of Florence, has a cathedral with fine sculptures. It is the original seat of the Bonaparte family. Pop. 2147.

Sannazaro, JACOPO, an Italian poet, of Spanish descent, was born at Naples, July 28, 1458. He attached himself closely to the court of Naples, and accompanied King Frederick III. when he took refuge in France (1501-4). It was during his absence that he published the *Arcadia*, a medley of prose and verse, which was greatly admired, and went through numerous editions (one at Turin in 1888). It has given its author the reputation of an Italian classic. Sannazaro died at Naples on 27th April 1530. Other works are *Sonetti e Canzoni* and *De Partu Virginis Libri III.*, mostly written in Latin verse. See Tiraboschi's *Storia della Letterat. Ital.*, and Life by Corniani (1806).

San Nicandro Garganico, a town of Southern Italy, 26 miles N. of Foggia. Pop. 8257.

San Nicolás de los Arroyos, the second city of Buenos Ayres province, in Argentina, stands on the Paraná, 150 miles by rail NW. of Buenos Ayres. It has a busy river trade, a large meat-freezing establishment, steam-mills, soap-factories, and slaughter and salting houses. Pop. 12,000.

Sanpo. See BRAHMAPUTRA and TIBET.

Sanquhar, a town of Dumfriesshire, on the Nith, 26 miles NNW. of Dumfries. It has a ruined castle, was the birthplace of the 'Admirable' Crichton, and has many Covenanted memories—including the affixing to the cross of the two Sanquhar Declarations, by Richard Cameron in 1680 and by Renwick in 1685. The *Corda* of Ptolemy, Sanquhar was made a royal burgh in 1598, and with Dumfries, &c. returns one member. Pop. 1315. See James Brown's *History of Sanquhar* (Dumfries, 1891).

San Remo, a city of Northern Italy, stands on a bay of the Gulf of Genoa, 26 miles by rail ENE. of Nice and 84 SW. of Genoa. It is built on rising ground, and is sheltered by hills behind. This, combined with its delightful climate, makes it one of the favourite winter-resorts of the Riviera (q.v.), especially for Englishmen and Germans. It is also much frequented during the summer. There are two quarters, an old town of steep, narrow streets, and a new town of handsome streets and picturesque villas, hotels, and palaces. Its little harbour serves a brisk trade in olive-oil, palms, and lemons. Pop. 12,285.

San Roque, a town of Spain, 8 miles N. by W. of Gibraltar. Pop. 8793.

San Salvador, or BANZA CONGO—the former being the Portuguese and the latter the native name—a town of Africa, in the Portuguese province of Angola, 170 miles E. by S. from the mouth of the Congo. A ruined fort and ruins of several churches are the only signs of what was an important town during the 16th and 17th centuries. Pop. 700.

San Salvador, the capital of the republic of Salvador (q.v.), stands in the midst of a fertile plateau, among green hills, and at the foot of the extinct volcano of San Salvador (8360 feet). Immense ravines, crossed for the most part only by narrow tracks, have been worn by streams in the surrounding plain, and serve as a protection to the city in time of war. The houses are mostly of one story, with walls built thick to resist the shocks of earthquake, and enclosing pleasant courts. The climate is agreeable and healthy. The government buildings are handsome, and the new cathedral promises to be a splendid structure when finished. The city, however, in spite of an excellent water-supply, is far from notable for its cleanliness. There is a busy trade, and coffee is extensively cultivated on the flanks of the volcano and in the surrounding country. San Salvador was founded in 1528. In 1854 it was a fine, well-built city, adorned with numerous splendid buildings, and containing a population of more than 25,000; but on the night of 16th April it was completely destroyed by an earthquake. A town of Nueva San Salvador was built 12 miles to the south-west, and thither the government removed until 1858. Violent shocks of earthquake have since visited the capital in 1873, 1879, and 1891. Pop. 30,000.—San Salvador is also one of the names for Bahía (q.v.), and for Cat Island in the Bahamas (q.v.).

Sansanding, or **SANSANDIG**, a town of Africa, stands on the left bank of the Niger, some 370 miles SW. of Timbuktu, and is a place of some commercial importance. Pop. 40,000.

Sansculottes, i.e. 'without breeches,' was the name given in scorn, at the beginning of the French Revolution, by the court party to the democratic party in Paris. The latter accepted the title with pride, and used it as the distinctive appellation of a 'good patriot.' According to the current interpretation in England (as in Carlyle's works), a *sansculotte* was a radical revolutionist who made a point of neglecting his apparel, and cultivating rough and cynical manners. But Littré makes no mention of breechlessness in the sense of raggedness in his definition of the word; on the contrary, he says that the *sansculottes* 'were so called because they gave up the knee-breeches in fashion during the *ancien régime* and took to wearing trousers or pantaloons.'

San Sebastián, a fortress and seaport in the north of Spain, 402 miles by rail NNE. of Madrid, and 11 miles from the French frontier. It is built on a peninsula, stretching from the base of a conical hill, Orgullo (400 feet), which is crowned with a castle strong enough to be called the Gibraltar of the north of Spain. Since its almost total destruction by the British, when they stormed it under Wellington during the Peninsular war, the town has been rebuilt on a regular plan. On the west is a magnificent roadstead, well protected, but difficult of access. It is bordered by a beautiful shore, which, on account of its suitability as a watering-place, attracts many summer visitors, especially from Madrid. Most of the loading and unloading is done at the more easily accessible harbour of Pasajes, 2½ miles to the E. The two ports are entered every year by some 1000 vessels of 380,000 tons burden, bringing principally coal, metals, fish, spirits, and yarn, to the average value of £672,000. The exports consist chiefly of wine, minerals, textiles, and matches, and average £1,140,000 in annual value. San Sebastián has suffered from numerous sieges in the wars between France and Spain. Pop. (1887) 29,047.

San Severo, a city of Southern Italy, by rail 18 miles NW. of Foggia and 141 NE. of Naples, has a fine cathedral. Pop. 19,756.

Sanskrit (*samskrita*, 'perfected,' 'polished'—viz. *sam*, together or completely, = *σμα*, Eng. 'same,' and *kṛita*, 'made,' probably connected with Lat. *creo*) is the name of the ancient literary language of India. It forms the easternmost branch of the great Indo-Germanic (Indo-European, Aryan) stock of languages, and the one which, thanks to its early literary cultivation (from c. 1500 B.C.) and grammatical fixation, and its consequent transparency of structure and fullness of form, approaches nearest to the parent language. In some respects, however (notably in the retention of a single *a*-vowel in place of the differentiation into *a*, *e*, *o*, prevailing in the European languages—e.g. Sansk. *bharantam* = *φάρωντα*), the primitive appearance of the Sanskrit, as of the closely allied Iranian or Persian branch, is now generally ascribed to a special Indo-Iranian development, or to a later return to a phonetic phase already outgrown by the parent language at the time of the separation. Whilst it is admitted on all hands that the Aryan dialect out of which the literary language of India has developed cannot have been indigenous to the peninsula, but must have been introduced from the north-east, there is still considerable difference of opinion as to the original home of the primitive Aryan community—whether it is to be sought for in Asia, as used to be universally believed till recent years, or whether, as many scholars are now inclined to think, it was from some part of Europe that the Asiatic Aryans—the Armenians and Indo-Persians—originally came. On entering India, the Aryan tribes found the country occupied by people of different races; but, favoured by physical and intellectual superiority, they gradually succeeded in extending their sway, as well as their language and their social and religious institutions, over the whole of Northern India. Owing, however, to various causes, such as new political formations or racial or tribal differences in the population absorbed by the ruling race, local dialects gradually sprang up within this area, which eventually developed into the modern vernaculars of Northern and Western India. See INDIA, Vol. VI. pp. 101–2.

Although the term Sanskrit, as the 'perfected' language, properly speaking only belongs to the grammatically fixed form of the language which was employed from about the 4th or 5th century B.C., and which came more and more to assume the character of a mere literary and learned idiom, it is usual to extend the term so as to include an earlier form of the same language used in the Vedic writings, and hence often called Vedic Sanskrit. The two phases of the language show considerable differences, as regards both vocabulary and grammar. The vocabulary of the older language includes numerous words which are no longer used in classical Sanskrit, and the very meaning of which had often become unknown; whilst, on the other hand, many of the commonest words of the later language are not found in the Vedic writings. As regards the inflectional system, the original wealth of grammatical forms has become considerably reduced in the later phase of the language. Thus, whilst the classical Sanskrit has but a single infinitive in *tum*—being the accusative case of a verbal abstract noun in *tu*, and corresponding to the Latin first supine (e.g. Sansk. *dātum*, *yojitum* = Lat. *dātum*, *junctum*)—the Vedic Sanskrit also makes use for the same purpose of different case-forms of quite a number of verbal nouns, several of which occur again with a similar function in one or other of the allied languages—e.g. Sansk. *vidmane* = *ἰδμεναι*; Sansk. *dāvane* = *δοῦναι*, *δοῖναι*; Sansk. *jīvase* = Lat. *vivere*; Sansk. *bharadhyaī* = *φάρσθαι*. Similarly the subjunctive mood, which formed a regular feature of the Indo-

Germanic and Vedic verb-systems, has almost entirely disappeared from the classical Sanskrit; and alternative declensional and conjugal forms have usually been reduced to a uniform level. Indeed, levelling processes of this kind are seen to have been at work from the earliest times. Thus, a comparison of the language of the older portions of the Rigveda with that of the later hymns, and the closely allied Atharvaveda, shows how, both in declension and conjugation, vowel-stems gradually supersede the original radical and consonantal stems, which less readily adapt themselves to case and personal affixes, and hence are apt to produce anomalies and irregularities. Such modifications become still more marked in the later Vedic prose-writings, the Brāhmanas and Sūtras, which may be considered an intermediate link between the two periods of the language. Though the process of change was at length arrested by rigid grammatical rules, to which every cultivated writer had to conform, it found all the more scope in the popular dialects, which soon lost touch of the literary language and became more and more removed from it.

Literature.—In accordance with the general development of the language, the history of the ancient literature of India may conveniently be divided into two chief periods, the *Vedic Literature* and the (*Classical*) *Sanskrit Literature*. It must be understood, however, that the two periods overlap each other to some extent, inasmuch as certain classes of works, on account of their subject-matter as well as the archaic character of their language, have to be grouped along with the Vedic literature, though they cannot have originated, in their present form, till after the language had become settled. The Vedic Literature forms the subject of a separate article. See VEDA.

Classical Sanskrit Literature.—The dates of many important Sanskrit works being still very uncertain, it is not yet possible satisfactorily to subdivide this period chronologically; and the usual practice of treating it under the different departments of literature is therefore adhered to.

A. Poetic Literature.—(1) *Epic Poetry.*—The Hindus possess two great national epics, the *Mahābhārata* (q.v.) and the *Rāmāyaṇa* (q.v.). Along with these may be classed the *Purānas* (q.v.), which, although in their present form they were doubtless composed or recast for sectarian purposes several centuries after Christ, seem to contain a considerable amount of genuine old legendary matter akin to large portions of the *Mahābhārata*. Though the final redaction of the two epics can scarcely be assigned to an earlier period than about the beginning of our era, it can hardly be doubted that the vast mass of legendary lore and complete epic lays of which the *Mahābhārata* is composed, at all events, must have required centuries to grow and assume its present shape. At a subsequent period, from about the 5th or 6th century A.D. onwards, there arose a second crop of epic poems of an entirely different character. Whilst the old poems are composed in easy, natural language, such as might well have formed the living though cultured language of the people, these later works are evidently the artificial product of an age when the literary language had long lost touch of the popular mind. Their subject-matter, such as there is, is entirely derived from the old legends; but the form in which it is here presented has nothing of the old popular ring about it—elaborate metres, long and complicated compounds, and laboured figures of speech through which the epic narrative hardly progresses at all being the characteristic features of most of these productions, wilt up in accordance with a narrow code of

rhetoric. They are nevertheless replete with poetic thoughts and genuine artistic feeling, which only require a less artificial form of presentment to please even the western taste. Of such poems (*kāvya*) there existed a considerable number; but the native taste has singled out six of them as *mahākāvya*s or great poems—viz. two by Kālidāsa (q.v.), by far the greatest poet of this period, the *Raghuvams'a* and the *Kumārasambhava*; further the *Kirātārjunīya* by Bhāravi (probably a contemporary of Kālidāsa, ? c. 500–550 A.D.); the *S'is'upālabadha* by Māgha, hence also called *Māgha-kāvya*; the *Rāvaṇabadhā* or *Bhaṭṭikāvya*, composed by Bhaṭṭi with the view of illustrating the less common grammatical forms of speech; and the *Naishadhīya* of S'ri Harsha (12th century).

(2) *Lyric, Descriptive, and Didactic Poetry.*—In this class of poetic production the palm is usually assigned to two poems by Kālidāsa—viz. the *Meghadūta*, or cloud-messenger, where an exiled demigod sends a message of love to his wife by a cloud, to which he describes, in glowing verse-pictures, the places and scenes it will have to traverse; and the *Ritusamhāra*, a description of the seasons. Of high poetic merit, though of a very sensuous character, is also the melodrama *Gītagovinda* (12th century) of Jayadeva (q.v.), which describes the love-making of the god Kṛishna among the milkmaids, his separation from, and ultimate reconciliation with, his wife Rādhā; and which, like the biblical Song of Songs, is considered capable of being explained in a mystic-allegorical sense. Moreover, scattered over dramas and manuals of rhetoric, or collected in poetic anthologies, there are extant thousands of single stanzas, composed with the view of depicting some striking local scene or emotional sensation. They may be likened to our sonnets, being like them artificial productions, though often composed with much skill and neatness, and inspired by genuine poetic sentiment. Didactic poetry, in Indian literature, takes chiefly the form of moral maxims, or sententious truths, expressed in single couplets or stanzas. There are a number of collections of such stanzas, intended to serve as manuals of ethical and social science, the best known of which are the *Rājāniti-samuchchaya*, or 'collection on the conduct of kings,' ascribed to Chanakya; the *Kāmaṇḍakīya-Nītisāra*, by Kāmaṇḍaki; and the *Nītisātaka*, or century (of stanzas) on ethic science, by Bhartrihari, who also wrote two centuries of erotic and devotional verses. To render moral instruction more attractive to the youthful mind, sententious verses of this kind were also combined with humorous stories and fables; the most famous reading-books of this class being the well-known *Panchatantra* (q.v.), or 'five books,' and the popular recast of it called *Hitopades'a* (q.v.), or 'good counsel'; further, the *Vetālapanchaviṃśati*, or twenty-five (tales) of the goblin; the *Simhāsanaadvātriṃśikā*, or thirty-two (stories) of the throne; and the *Sukasaptati*, or seventy (tales) of the parrot. Two highly popular collections of versified fairy-tales are Kshemendra's *Vṛihatkathā*, or great story (c. 1030 A.D.), and Somadeva's *Kathāsaritsāgara* (trans. by C. H. Tawney), or 'ocean of rivers of story' (c. 1120). The Sanskrit novellistic prose literature, on the other hand, is very scanty, and characterised by a stilted, highly involved style, the few best-known works of this class being Dandin's *Dasakumāra-charita* (6th century), or adventures of the ten princes (trans. by P. W. Jacob); Subandhu's *Vāsavadattā*; and Bāna's *Kādambarī* (c. 620 A.D.).

(3) *Drama.*—Though dramatic performances of some kind seem to go back to pretty early times, none of the existing plays are probably older than the 5th century of our era. The language is usually

of a mixed nature, higher male characters speaking in Sanskrit, whilst women and lower male characters use Prakrits, or popular dialects. Plays invariably begin with a benediction and a prelude in the form of a dialogue between the stage-manager and one of the actors, containing some allusion to the author, and leading over to the opening scene. Two standing and interesting characters of the Indian stage are the Vita, or dissolute associate of the hero, somewhat resembling the parasite of the Greek comedy, and the Vidūshaka, his humorous companion, or Gracioso. The extant plays number about fifty. Their plots are usually based on the epic legends. The greatest of Indian playwrights is Kālidāsa (q.v.; c. 500 A.D.), the author of the *Sakuntalā*, the *Vikramorvasī*, and *Mālavikāgnimitra*. Possibly somewhat older than these, and certainly highly interesting as a vivid picture of the social life of the time, is the *Mrichchhakatikā*, or toy-cart, ascribed to a king Sūdraka. Next to Kālidāsa, in the estimation of native scholars, ranks Bhavabhūti (q.v.; c. 700), likewise the author of three plays—viz. the heroic dramas *Mahāvīracharita* and *Uttararāma-charita*, and the domestic drama *Mālatimādhava*. He is, however, far less of an artist than his great rival, and his language is much more artificial. Besides these may be mentioned Śrī Harshadeva, king of Kanauj (c. 625), the reputed author (or patron) of the *Ratnāvalī*, *Nāgānanda*, and *Priyadarsīkā*; Bhatta Nārāyaṇa, author of the *Veni-sanhāra*; and Krishnamisra (12th century), who wrote the *Prabodhachandrodaya*, or 'moonrise of Intelligence,' a rather tedious allegorical play, the characters of which consist entirely of abstract ideas—virtues and vices—ranged in two contending armies (see H. H. Wilson, *Theatre of the Hindus*).

B. Scientific Literature.—The first beginnings of nearly all the branches of scientific inquiry cultivated in mediæval India may be traced back to the later Vedic times, being the natural outgrowth of the Vedic religion and of the study of the sacred writings. This fact indeed receives a direct recognition in the traditionary classification itself, inasmuch as it includes among the Vedic literature, under the title of *Vedāṅga*, or members of the Veda, the original or fundamental treatises of six sciences—viz. phonetics (*s'ikshā*), prosody (*chhandas*), grammar (*vyākaraṇa*), etymology (*nirukta*), astronomy (*jyotiṣha*), and ceremonial law (*kalpa*). Though some of these treatises, in their present form at all events, cannot justly lay claim to so high an antiquity, it is not improbable that they are based on older treatises on their respective subjects.

(1) *Law (dharma)*.—The earliest attempts at an orderly statement of social and civil usages are to be found in the *Dharmasūtras*, or rules of law, which form part of some of the *Kalpasūtras*, or ceremonial rules (see VEDA), in close connection with the *Grihyasūtras*, or rules of domestic rites, out of which they may indeed have originally grown. The few still extant sets of *Dharmasūtras*—viz. those of *Bandhāyana*, *Āpastamba*, *Gautama*, and *Vāsishtā* (all trans. by G. Bühler)—though mainly composed in aphorisms, are interspersed with couplets or stanzas, giving the substance of several rules; and it is in these detached verses that many scholars would trace the first tendency toward the composition of the versified codes of law, the *Dharmasūtras* or *Smṛitis*, which, somewhere about the beginning of our era, came to supplant the *Sūtra*-codes, and remained for centuries the standard authorities on matters of law. Whilst some few of these new codes, like their prose prototypes, appear to have been directly connected with certain Vedic schools, such does not seem to have been the case as regards the vast majority of

them, which were called by their authors, more or less fancifully, either after some old semi-mythic teacher or sage, such as Atri, Hārīta, Śātātapa, or even after some god, such as Vishṇu, Brihaspati, Yama. Hindu law usually recognises three distinct divisions—viz. *dharma*, or established usage; *vyavahāra*, or civil procedure; and *prāyas'chitta*, or penance. The three most important *Smṛitis* are those of Manu (q.v.), *Yājñavalkya*, and *Parās'ara*. This last code lacks, however, the section on civil law, which was only supplied some 500 years ago by the famous exegete Mādhyama, who composed a digest of law, based on *Parās'ara*, with a special chapter on *Vyavahāra*. The new school of practical jurisprudence to which this work belongs was ushered in by Vijnānes'vara's *Mitāksharā* (11th century), which, though primarily a commentary on *Yājñavalkya*, constantly quotes other authorities, and thus serves the purposes of a digest of law, and remains to this day one of the standard works on Hindu law. Amongst other famous digests may be mentioned Devaṇabhāṭṭa's *Smṛitichandrikā* (13th century), highly esteemed in Southern India; Jīmūtavāhana's *Dāyabhāga*, the chief authority on inheritance in the Bengal school; the *Vīramī-trodaya*, by Mitramisra (c. 1625); and the *Vyavahāramayūkha*, being the civil law section of a general digest by Bhaṭṭa Nilakaṇṭha (c. 1640).

(2) *Philosophy*.—While the main body of the Vedic hymns are the immediate outgrowth of a worship of the elemental forces of nature, not a few of the hymns, especially the later ones, evidence a strong tendency towards metaphysical speculation. It is only in the *Upanishads* (see VEDA), however, that we meet with the first attempts at some kind of systematic treatment of the great problems of mundane existence, and of the nature of the absolute spirit, and its relation to the human mind. The drift of speculative inquiry in those days, as ever afterwards, is determined by two cardinal notions which are never questioned, and have assumed the force of axioms in Hindu philosophy—viz. the pantheistic notion of the spiritual unity of all sentient beings, and the transmigration of souls. To the Hindu mind the latter notion seems the necessary consequence of the former. All individual souls are identical in nature, having emanated from, and being destined to return to, the infinite, all-pervading spiritual essence, the Brahman or Atman. The apparent difference of the spiritual element in different kinds of animated beings (elemental gods, men, animals, plants) is due to a greater or less degree of contamination with matter, and consequent obscuration; and it is only by a gradual process of improvement and purification, in repeated terms of bodily existence—i.e. through metempsychosis—that lower beings can raise themselves to the state of purity requisite for their union with the Supreme Spirit (*paramātman*). Ignorance of its own real nature, and of its identity with the world-soul, is what alone keeps the individual soul chained to matter, and to material existence with its hateful accompaniment of passion and suffering. To dispel this ignorance by setting forth the true relations between the individual being and the Brahman, as a preliminary to final emancipation, is the task and aim of philosophy.

Six philosophical systems (*dars'ana*) are recognised by orthodox Hindus, which fall, however, into three pairs so closely connected that each pair forms a common school of philosophy—viz. *Mīmāṃsā* and *Vedānta*, *Sāṅkhya* and *Yoga*, *Nyāya* and *Vaiśeṣika*. Nothing certain is as yet known as to their date or order. The tenets of each system are propounded in a manual of concise aphorisms (*sūtra*), ascribed to the respective founder, and commented upon by numerous writers.

The *Mīmāṃsā*—or properly *Pūrva-Mīmāṃsā*, 'Prior Inquiry'—is mainly a systematic exposition of the principles of scriptural interpretation. Its chief object is to maintain the authority of the Veda, and to urge the necessity of performing the duties enjoined therein, especially those of a ceremonial kind, with a view to securing the benefits, temporal and eternal, accruing from these meritorious works as the logical effect of an operative cause. A philosophical basis is secured for these dogmatic theories by the inclusion of verbal communication (*s'abda*) among the five or six sources of knowledge, or modes of proof, agreed upon by both schools of the *Mīmāṃsā*. The sage Jaimini is the reputed founder of this school, and author of its fundamental sūtras, which were afterwards commented upon and supplemented by S'abara Svāmin (? c. 500 A.D.) and Kumārila Bhaṭṭa (c. 700).

The *Vedānta*, i.e. 'end of the Veda'—as the *Uttara-Mīmāṃsā* ('Later Inquiry') is more commonly called—is the system most closely in accord with the development of religious thought in Brahmanical India. In its main features it simply formulates and carries on the speculations of the older Upanishads. According to this system, God is the omniscient and omnipotent cause, efficient as well as material, of the world: He is both creator and nature; and at the consummation of things all are resolved into Him. The individual soul is of the same essence as the supreme one; it emanates from Him like one of the sparks that issue from a blazing fire, and ultimately returns to Him. It is not a free agent, but ruled by God; its activity—the source of its suffering—being solely due to its bodily organs. Whilst the evolution of the elements and organised bodies is minutely expounded in the original aphorisms—the *Brahma-sūtras* of Bādarāyaṇa—the questions as to the *raison d'être* of material existence and the origin of evil find no satisfactory explanation. It is only by a later school of Vedāntists, represented by the famous theologian Śāṅkara-āchārya (q.v.), in his commentary on those sūtras, that a solution is found in the theory that the material world has no real existence, but is a mere illusion (*māyā*). This school is called the *Advaita*, or non-duality, school of Vedānta philosophy. In opposition to it arose two other schools, both of which identify the supreme spirit with Vishnu—viz. that of *Rāmānuja* (11th century), the founder of the *S'ri-Vaiṣṇava* sect, usually called the *Viśiṣṭādvaita*, or qualified non-duality school, because they allow the Brahman to be 'qualified' by all good qualities, and to be 'distinct' from matter; and the school of *Madhva-āchārya* (12th century), called the *Dvaita*, or duality, school from their maintaining the supreme spirit to be distinct both from man and from matter. These schools in fact show a certain leaning towards Śāṅkya doctrines. The *Rāmānujas* and other *Vaiṣṇava* sects—especially the one founded by Chaitanya (c. 1500)—have, moreover, grafted on the Vedānta the doctrine and practices of *bhakti* (implicit faith, fervent devotion), which had early found expression in works such as the famous philosophical episode of the *Mahābhārata*, the *Bhagavadgītā* (trans. by J. C. Thomson, and by K. T. Telang), and the *Bhāgavatapurāṇa*, and had been formulated in the *S'āṅkya-Bhakti-sūtra* (trans. by E. B. Cowell).

The *Śāṅkya* system, as propounded in the *Śāṅkya-sūtras* ascribed to Kapila, represents the materialistic school of orthodox Indian philosophy. It maintains the eternal co-existence of a material first cause—the *mūla-prakṛiti*, or prime originant (plastic nature); also called *pradhāna*, or 'principal (cause)'—and a plurality of spiritual entities or selves (*puruṣa*) connected with matter from all eternity. From the material first cause, devoid of

intelligence, the phenomenal universe has been developed by a gradual process of unconscious evolution. The school, thus denying the existence of an intelligent ruler (*is'vara*), is often called 'godless' (*nirīś'vara*). The most popular summary of the doctrines of this system is the *Śāṅkya-sāra* (trans. by H. J. Colebrooke, and by J. Davies), by Vijnāna Bhikṣu (16th century).

The *Yoga* school, founded by Patanjali, accepts the speculative system of the Śāṅkya with its twenty-four principles; but adds thereto a twenty-fifth—viz. the '*nirguṇa Puruṣa*' ('the self devoid of attributes'), the supreme god of the school, whence the *Yoga* is also called the Theistic (*śeś'vara*) Śāṅkya. Moreover, the school has developed, as its most characteristic feature, a complicated system of ascetic practices for the mortification of the senses, with a view to bringing about, even during life, a spiritual union (*yoga*) with the supreme spirit.

The *Nyāya* and *Vaiśeṣika*, though differing from each other on some important points, such as the number of the modes of proof, may be considered as two branches of a single analytical system of philosophy which supplement each other and are commonly studied together. The *Nyāya* (lit. 'method,' 'rule'), ascribed to Gotama (or Gautama, also called Akṣhapāda), though, like the other systems, it professes to deal with the whole round of metaphysical subjects necessary for complete knowledge and final emancipation, is especially remarkable for the very complete system of dialectics which it has developed, and which has gained for it the title of the Hindu science of logic. A regular argument, or complete syllogism (*nyāya*), according to this system, consists of five members—viz. (a) the proposition (*pratijñā*): e.g. 'this hill is fiery'; (b) the reason (*hetu*): 'for it smokes'; (c) the instance (*udāharaṇa*): 'as a culinary hearth'; (d) the application (*upanayana*): 'accordingly the hill is smoking'; (e) the conclusion (*niḡamana*): 'therefore it is fiery.' The *Vaiśeṣika* system, put forward by Kaṇāda, also called Kāśyapa, whilst on the whole accepting the analytical principles of the *Nyāya*, occupies itself more especially with the physical or cosmic aspect of metaphysics; its name being derived from the assumption of atoms (*anu*), or ultimate substances possessed of separate individuality (or 'particularity,' *viśeṣa*), which are innumerable and eternal, and of which the phenomenal world is composed. Their aggregation, according to the original view of the school, is caused by an invisible force (*adrīṣṭa*), whilst at a later stage it is ascribed to a supreme soul (*paramātman*), distinct from the individual souls (*jīvātman*) forming the immaterial atoms.

Of heterodox systems of philosophy—besides those of the Jainas (q.v.) and Buddhists (q.v.)—only one deserves special mention—viz. the *Chārvaṅkas*, or *Lokāyatikas* ('materialists'). The doctrines of this school, traditionally ascribed to Brihaspati, admit but one source of knowledge and proof—viz. perception. According to them there is neither a supreme spirit, nor a future life, nor a soul distinct from the body; and the sole end of man is enjoyment derived from sensual pleasures.

A kind of mystic philosophy—in the sense in which the peculiar practices of the *Yoga* are regarded as such—underlies the doctrines promulgated by the *Tantras*, the religious text-books of the numerous sects of *S'āktas*—i.e. worshippers of the *ś'akti*, or active divine energy, personified in some female deity, especially in one of the many forms of Pārvatī, the wife of Ś'iva. In its origin, the worship of the female principle as a means of obtaining transcendental powers is probably based on the Śāṅkya notion of the *prakṛiti* (fem.) or

plastic material principle as the prime cause of the universe; and considering that this form of belief is referred to amongst the heterodox doctrines contended against by S'ankarāchārya (? c. 700 A.D.), it would seem to be of tolerable antiquity, though probably not in the grossly licentious form in which it is inculcated in many of the Tantric writings. The number of original Tantras is usually fixed at sixty-four. The best-known works of this class are the *Rudrayāmala*, *Kulārṇava*, *Syāmārahasya*, and *Kālikātantra*.

The best native survey of the Indian systems (except Mīmāṃsā) is Mād'hava's *Sarradarśanasangraha* (trans. by E. B. Cowell and A. E. Gough); for other accounts, see Colebrooke's *Essays*, and Goldstücker's *Literary Remains*.

(3) *Grammar (vyākaraṇa)*.—Grammatical research in India probably goes back to nearly as early times as the redaction of the Vedic hymns. The work traditionally accepted as the Vedāngatreatise in this science—viz. the *Aṣṭādhyāyī*, or 'eight chapters' of aphoristic rules, by Pāṇini (q.v.)—marks the very highest point of its development, and would seem to presuppose a long period of growth. To the same author is ascribed the original treatise of another Vedāng—viz. phonetics (*ś'ikshā*), treating of the nature of the letters and accents, and the proper mode of sounding them. To this latter branch of science have to be referred the *Prātis'ākhya*s, elaborate treatises on the phonetic changes undergone by words in the connected form of the Vedic texts. Such treatises are in existence for all the *Samhitās*, except the *Sāma-veda*; those of the *Rik* and *Atharva* being ascribed to S'aunaka, that of the *Vājasaneyi-samhitā* to Kātyāyana, whilst the author of the *Taittirīya-prātis'ākhyā* is unknown. Whether these works are anterior or posterior to Pāṇini is still doubtful. Here must also be mentioned the oldest work on etymology and Vedic interpretation, Yāska's *Nirukta*, which is probably older than Pāṇini's grammar. Pāṇini's rules were partially amended and supplemented in Kātyāyana's *Vārttikas*, which on their part were critically examined by Patanjali (? 2d century B.C.), in his *Mahābhāshya*, or 'great commentary.' So minute and complete was the grammatical analysis of the language presented in these works that the efforts of subsequent authors of grammars were mainly directed towards the best rearrangement of the linguistic matter for practical educational purposes. The most important of these grammars, forming the text-books of special grammatical schools, are the *Chāndra-vyākaraṇa*, by Chandra-gomin of Kashmir (2d century, A.D.); the *Kātantra*, by Sarvavarman (? 6th century); the text-book of the *Kālāpa* or *Kaumāra* school; the *Sārasvatī prakriyā*, by Anubhūti-svarūpachārya; the *Haima-vyākaraṇa*, by Hemachandra (12th century); the *Mugdha-bodha*, by Vopadeva (13th century); and the *Siddhānta-kaumudī*, by Bhaṭṭoji-dīkshita (17th century).

(4) *Lexicography*.—Native dictionaries (*koṣha*), generally composed in verse, are either homonymous or synonymous. In the former the words explained are usually arranged according to the final consonant and then according to the number of syllables they contain. The most famous dictionary (chiefly synonymous), and one of the oldest, is the *Amarakoṣha*, or 'Immortal treasury,' by Amarasimha (c. 550). Of others the most important are Hemachandra's *Abhidhāna-chintāmaṇi*, Halāyudha's *Abhidhāna-ratnamālā* (11th century), and the *Medini* (c. 13th century).

(5) *Prosody (chhandas)*.—The privilege of representing this science among the Vedāngas is assigned to the *Chhandah-sūtra*, ascribed to Piṅgala, who is traditionally identified with Patanjali, the gram-

marian. But, strange to say, the section of this work treating of Vedic metres is very meagre, whilst the chapter on post-Vedic metres is tolerably complete, and, with a commentary on it by Halāyudha (probably the lexicographer), still forms one of the chief authorities on prosody. Of other important manuals may be mentioned the *Vṛittaratnākara*, or 'jewel-mine of rhythms,' by Kedārabhaṭṭa (before the 13th century); and the *Chhandomanjarī*, or 'cluster of metres,' by Gaṅgādāsa. See Colebrooke's excellent essay on Sanskrit and Prākṛit Metres, *Misc. Ess.* ii.

(6) *Music (saṅgita)*.—The existing treatises on music are of comparatively modern origin. The two most important are the *Saṅgita-ratnākara*, or 'jewel-mine of harmony,' by Ś'ārngadeva, and the *Saṅgita-darpaṇa*, or 'mirror of harmony,' by Dāmodara. These works treat not only of music proper—including the notes, melodies, and measures, singing, concerted music, and instruments—but also of dancing, acting, and mimic representation.

(7) *Rhetoric (alankāra-śāstra)*.—The theory of poetic composition and the approved forms of literary style has been a favourite subject with Hindu writers; and the result of their labours is a minute classification of the various forms of composition, and an elaborate system of rules regarding the different sentiments and forms of speech applicable to certain characters and conditions of life. Dramatic poetry, as the most varied form of literary composition, usually occupies a large share of the attention of rhetorical writers. The *Bharata-śāstra*, which is only imperfectly known, is considered the most ancient of the existing manuals of this art. Whether the author preceded the brilliant period of artificial poetry from the fifth century of our era onwards is still uncertain. The earliest work the date of which has been fairly ascertained is the *Kāvya-dars'a*, 'mirror of poetry,' by Daṇḍin (6th century). Of other works on poetics generally may be mentioned the *Kāvya-prakāś'a*, or 'lustre of poetry,' by Mammata (c. 12th century), and especially the *Sāhitya-darpaṇa*, or 'mirror of composition' (trans. in *Bibl. Ind.*); by Viśva-nātha Kavirāja (15th century), the standard authority on literary criticism. The favourite manual of dramaturgy is the *Daśarūpa*, or 'ten forms' (of plays), by Dhananjaya (c. 10th century).

(8) *Medicine (ayurveda, vaidyaśāstra)*.—The oldest systematic treatises on medical subjects are the *Samhitās* of Charaka and Suśruta (? c. 550 A.D.). Both works are composed in verse mixed with prose sections, and are characterised by great diffuseness. Of later handbooks of medical science may be mentioned Vāgbhaṭa's *Aṣṭāṅgahriḍaya* and Bhāvamis'ra's *Bhāvaprakāś'a*; whilst the *Rājamanjari*, by the Kashmirian Narahari, is the most approved manual of materia medica. Cf. T. A. Wise, *Commentary on Hindu Medicine* (1845), and *History of Medicine* (vol. i. 1867).

(9) *Astronomy and Mathematics*.—This science appears as one of the Vedāngas, or members of the Veda; and the treatise which has been handed down as such in the *Rik* and *Yajus* recensions—viz. the *Jyotiṣham*—presents indeed a comparatively primitive appearance, as it knows only a lunar year of 360 days, and mentions neither the zodiac nor the planets. Much the same phase of knowledge is represented by some other works, such as the *Gārgi Samhitā* (? c. 50 B.C.). A new scientific era, brought about by a knowledge of Greek astronomy, commenced about 250 A.D., and gave rise, in the first place, to five works called *Siddhānta* (*Sūrya-siddhānta*, &c.), and later on to the standard works on astronomy—viz. Āryabhaṭa's *Āryabhatīyam*

(c. 500), Varāhamihira's *Bṛihatsaṃhitā* (c. 540), Brahmagupta's *Brahmasiddhānta* (c. 625), and Bhāskara Achārya's *Sūryas'īromani* (1150).

Sanson. See EXECUTION.

Sansovino, ANDREA CONTUCCI DEL MONTE, Florentine sculptor, was born at Monte Sansovino in 1460. He worked in Florence, Portugal, Rome, and Loreto. He died in 1529. See *Life* by Schönfeld (1881).—His pupil, JACOPO SANSOVINO or TATTI (1477–1576), sculptor and architect, was born in Florence, and lived from 1527 in Rome.

Sans Souci. See POTSDAM.

San Stefano, a village 6 miles W. of Constantinople, where was signed (3d March 1878) the preliminary Russo-Turkish agreement.

Santa Ana, a town of Salvador, 40 miles inland, with trade in coffee; pop. 15,000.

Santa-Anna, ANTONIO LOPEZ DE, president of Mexico, was born in Jalapa, 21st February 1795. At the age of fifteen he entered the Spanish army, and served against his countrymen until 1821, when he joined Iturbide, who made him brigadier and governor of Vera Cruz. Iturbide had established an imperial rule over Mexico (q.v.), but in 1822 Santa-Anna proclaimed a republic, and brought about his patron's downfall. In 1828 he headed a rising which placed Guerrero in the presidential chair; and in 1829 he defeated and captured a division of Spanish troops which had landed near Tampico, with the view of again bringing Mexico under Spanish rule. He now engaged in a series of intrigues which culminated in an open revolt against the president, Bustamante, in 1832, and his own election. Santa-Anna, however, desired power without responsibility for the irksome details of government, and he retired to his country seat, leaving the executive in the hands of the vice-president; and when he ceased to be able to control this lieutenant, in 1834 he headed a rising against him, and had him deposed in 1835, and another appointed in his stead. But Santa-Anna's reactionary policy, which reduced the states to provinces and placed all the power in the hands of the central government, in 1836 cost the country Texas (q.v.). He invaded the revolted province with 6000 men, and defeated and massacred his opponents with unbroken success until April, when he was routed at San Jacinto by Houston, and soon after taken prisoner. He escaped with eight months' imprisonment and a short detention in the United States; but at home his influence was not restored until, luckily, in 1838 the French attacked Vera Cruz, and in the gallant defence of the city he lost a leg. He was now encouraged to renew his intrigues, which were again successful, and from 1841 to 1844 he was either president or the president's master. Then there was a revolution on the other side, the army deserted him, and he fled towards the coast, but was arrested, imprisoned for a time in 1845, and ultimately permitted to retire to Havana. From this exile he was recalled in 1846 to be first commander-in-chief and then president. The war with the United States had begun, and begun badly: Palo Alto and Resaca had been lost, and in September Monterey fell. In February 1847 Santa-Anna, who had brought together some 20,000 men, attacked Taylor's weakened force of 5000 at Buena Vista; but the narrow pass and the strength of the American artillery were fatal to him, and he was repulsed with heavy loss. At Cerro Gordo, in April, Scott defeated him and took 3000 prisoners. Santa-Anna retired on the capital, but when its fall became certain he resigned the presidency and withdrew from the city by night. He was allowed to retire to Jamaica in 1848, but was recalled by a revolution in 1853, and appointed

by an obedient congress president for life, with the title of Most Serene Highness. His harsh rule quickly produced a number of revolts, and in 1855 he was driven from the country, finally finding a refuge in St Thomas. On the establishment of the empire under Maximilian he was permitted to return on condition of his not interfering in political affairs; but he could not refrain from intriguing for himself and issuing the old proclamations, and so before long Bazaine sent him back to St Thomas. Even the appointment of grand-marshal of the empire could not keep him faithful, and a second conspiracy against Maximilian ended in another flight. He now vainly endeavoured to obtain employment against the empire, and in 1867, after the emperor's death, tried to effect a landing at Sisal; he was captured and was sentenced to death by a court-martial, but was pardoned on condition of his leaving Mexico; he returned in 1872 under the general amnesty, and died in the capital, harmless and disregarded, 20th June 1876.

Santa Caterina, a central town of Sicily, 9 miles NW. of Caltanissetta, with sulphur-mines and manufacture of earthenware. Pop. 7200.

Santa Catharina, a southern coast state of Brazil, with an area of 27,436 sq. m. and a pop. (1890) of 283,769. The coast is very irregular, the interior mostly a plateau sinking gently to the west. The climate is not unhealthy, but moist, and thick primeval forests remain. Agriculture and the rearing of cattle are the principal industries, largely carried on by colonies of Europeans. The capital is Desterro (30,000), on the hilly, fertile island of Santa Catharina (210 sq. m.).

Santa Clara, or VILLA CLARA, a city of Cuba, 194 miles by rail ESE. of Havana. It is well built, in a grazing and agricultural region, which yields high-grade tobacco. Mines of gold, graphite, copper, and asphalt are worked. Pop. (1899) 13,763.

Santa Clara. See ABRAHAM-A-SANTA-CLARA.

Santa Claus. See NICOLAS (ST).

Santa Cruz (also spelt Sainte Croix), (1) one of the Virgin Islands, belonging to Denmark, with an area of 74 sq. m. and a pop. (1890) of 19,783. Sugar, rum, and cotton are the chief products; the capital is Christianstadt (pop. 5500). Discovered by Columbus on his first voyage, the island was held by Dutch, English, Spanish, French, and the Knights of Malta at various dates, and was bought by Denmark in 1733.—(2) The largest of a group of Melanesian islands, sometimes called Queen Charlotte Islands, east of the Solomon archipelago and 100 miles N. of the New Hebrides. The largest is also called Nitendi (area, 216 sq. m.). The kidnapping of natives for service in Australia embittered the islanders, so that when Bishop Patteson landed on Nukapu, one of the smaller isles, he was murdered. Then some villages were bombarded in retribution; and in 1875 Commodore Goodenough was murdered.—(3) Santa Cruz, called also Teneriffe, the capital of the Canary Islands (q.v.), and the chief seaport of the group, stands on the north-east side of the island of Teneriffe. Its port, recently enlarged and improved, is protected by moles, and affords excellent anchorage. It is a clean, well-built little town, with houses of the Spanish style, flat-roofed and with square court-yards, and is defended by forts and redoubts. It is the seat of a bishop and the headquarters of the Spanish governor. This port is entered every year by an average of 1585 vessels of 1,019,400 tons. The exports, chiefly potatoes, tomatoes, and other garden produce, cochineal, wine and spirits, tobacco, sugar, and grain, increase steadily in value (£248,774 in 1887 and £302,175 in 1889); the imports, embracing coal, cotton and woollen goods, hardware, and provisions, are also increasing

gradually (£428,680 in 1887 and £517,918 in 1889). The greater part of the trade is to and from England, which supplies one-third of the imports and takes more than one-half of the exports. Santa Cruz is being much resorted to by steamers for re-coaling. See BLAKE, ROBERT (under date 1657), and NELSON (1797).—(4) Santa Cruz de la Palma is the capital of Palma, another of the Canary Islands (q.v.); it stands on the east coast, on a spacious bay. Pop. 6617.—(5) Santa Cruz, a southern territory of the Argentine Republic, between 46° S. lat. and Cape Dungeness, and stretching from the Atlantic to the watershed of the Andes. Area, 106,890 sq. m. It is, so far as known, a land of desolate plateaus, with little water and scanty pasturage, where, however, thousands of wild horses range.

Santa Fé, a wealthy province of the Argentine Republic, stretching north from Buenos Ayres to 28° S. lat., and so embracing a considerable portion of the Gran Chaco. Area, 54,790 sq. m.; pop. (1895) 405,360. The province is well watered by the Paraná and its tributaries. Agriculture and manufactures are the important industries. The largest town is Rosario. The capital is Santa Fé, on the Rio Salado, by rail 7 miles from its port, Colastiné, on the Paraná. It has also railway connection with Rosario and Buenos Ayres, possesses tramways and telephones, and contains a normal school, a seminary, and a Jesuit college with 400 pupils. Pop. 15,099.

Santa Fé, the capital of New Mexico, is built among the Rocky Mountains, 6840 feet above the sea, and 1327 miles by rail WSW. of Chicago. The climate is very dry, so that irrigation is necessary for agriculture; and most of the houses are built of *adobe*. It is an old Spanish-American town, and is still a Roman Catholic archbishop's see. Pop. (1890) 6713.

Santalaceæ, a natural order of exogenous plants, mostly trees and shrubs. The leaves are undivided, sometimes minute. There are about 110 known species, natives of various parts of the world, the European and most of the North American species being obscure weeds, whilst the trees of the order occur chiefly in the East Indies, New Holland, and the South Sea Islands. Sandalwood (q.v.) is the produce of plants of this order. The leaves of *Oxyris nepalensis* are used for tea. Some species are used in medicine in their native countries. *Fusanus acuminatus* is the Quandang Nut of New Holland. Its taste and qualities resemble those of Sweet Almonds, as do also those of the seed of the *Cervantesia tomentosa* of Peru. *Pyrularia oleifera*, the Buffalo Tree or Oil Nut, has a large seed, from which, in the southern states of America, oil is obtained.

Santalín, or SANTALIC ACID, the colouring matter of red Sandalwood (q.v.).

Santals, an aboriginal tribe of India, belonging to the Kolarian family, occupy a long narrow strip of country between the mouth of the Mahanadi in Orissa and the Ganges near Bhagalpur. In 1891 the total number of persons speaking Santali was 1,709,680, including Christian converts, and 10,000 Santals labouring in the Assam tea-plantations. They are fond of change, and prefer to live on the edges of the great forests: when the ground gets well cleared and cultivated they move to a new site. In personal appearance they are not unlike negroes, having a broad round face, a broad flat nose, a large mouth with projecting lips, and coarse black hair. Their chief occupations are cultivating the soil, hunting, playing the flute (in which they are great proficient), and dancing round dances. They worship the sun for their supreme god, and after him a number of malignant

spirits, whose evil influence they seek to avert. They are divided into twelve tribes, and their village government is patriarchal in type. The exactions of the Hindu money-lenders provoked the Santals to revolt in 1854; the rising was not suppressed without a good deal of bloodshed. Since then this people have been allowed to exercise their own forms of self-government, under the supervision of the British authorities. There is a Santal grammar by Skrefsrud (Benares, 1873).

Santa Lucia. See ST LUCIA.—Santa Lucia is also the name of a town of Uruguay, 30 miles NW. of Montevideo. Pop. 5000.

Santa Marta, a town of Colombia, on the Caribbean Sea, was founded in 1525, the second Spanish town planted on the mainland. In 1834 an earthquake almost utterly destroyed the place, which is still, however, a bishop's see and the capital of Magdalena province, and has an excellent harbour, formerly defended by two forts. Simon Bolivar died close by in 1830. Pop. 6000. See also SIERRA NEVADA.

Santa Maura. See LEUKAS.

Santander, a thriving seaport on the north coast of Spain, stands on an inlet of the Bay of Biscay, about equally distant from Oviedo on the west and San Sebastian on the east, and by rail 316 miles N. of Madrid. The bay on which it stands is accessible to the largest vessels at all times. The town occupies a picturesque site, but is quite modern in appearance, and has few buildings of note. Of its former convents one now serves as a theatre, another as a cigar-factory, giving employment to about 1000 people. The remaining industries are chiefly breweries, cotton, paper, and flour mills, iron-foundries, and ship-building-yards. The commerce of the port increases steadily: the exports—flour, wine, food-stuffs, and metals—have in some years reached a value of £898,000, and the imports—tobacco, food-stuffs, codfish, iron and steel goods, textiles, coal, petroleum, chemicals, timber, &c.—a value of £2,000,000. On the 4th November 1893 a ship discharging in the harbour took fire, and the consequent explosion of 21 cases of dynamite destroyed quays, whole streets of houses, and hundreds of lives. Santander is a favourite seaside resort in summer. Pop. (1887) 41,829. It was here Charles I. embarked for England after his trip to the Spanish court. The town was sacked by Sout in 1808.—The province, a mountainous land, with fertile transverse valleys, is the seat of active industries (cotton, paper, flour, beer, &c.), and rich in minerals (iron, coal, copper, zinc, lead). Area, 2113 sq. m.; pop. (1887) 242,843.

Santarem, capital of the Portuguese province of Estremadura, stands on the right bank of the Tagus, 46 miles NE. of Lisbon by rail. An old Moorish castle, crowning a hill that overlooks the town, was during the middle ages the residence of the kings of Portugal. It has a cathedral and several churches; the kings Diniz I. and Henry died here, and Ferdinand I. lies buried here, as well as Cabral, the discoverer of Brazil. The army of Pedro of Brazil under Napier and Villafior routed here the forces of the usurper Miguel on 16th May 1834. Pop. 7500.

Santa Rosa, capital of Sonoma county, California, on Santa Rosa Creek, 51 miles by rail N. by W. of San Francisco. Its manufactures include iron, soap, and carriages, and it contains a Methodist college and another. Pop. (1890) 5216.

Santa Rosa, (1) a town of Chili, on the Aconcagua, 82 miles by rail E. by N. of Valparaiso. Pop. 6000.—(2) A mining-town of Colombia, in Antioquia, 8335 feet above the sea, with

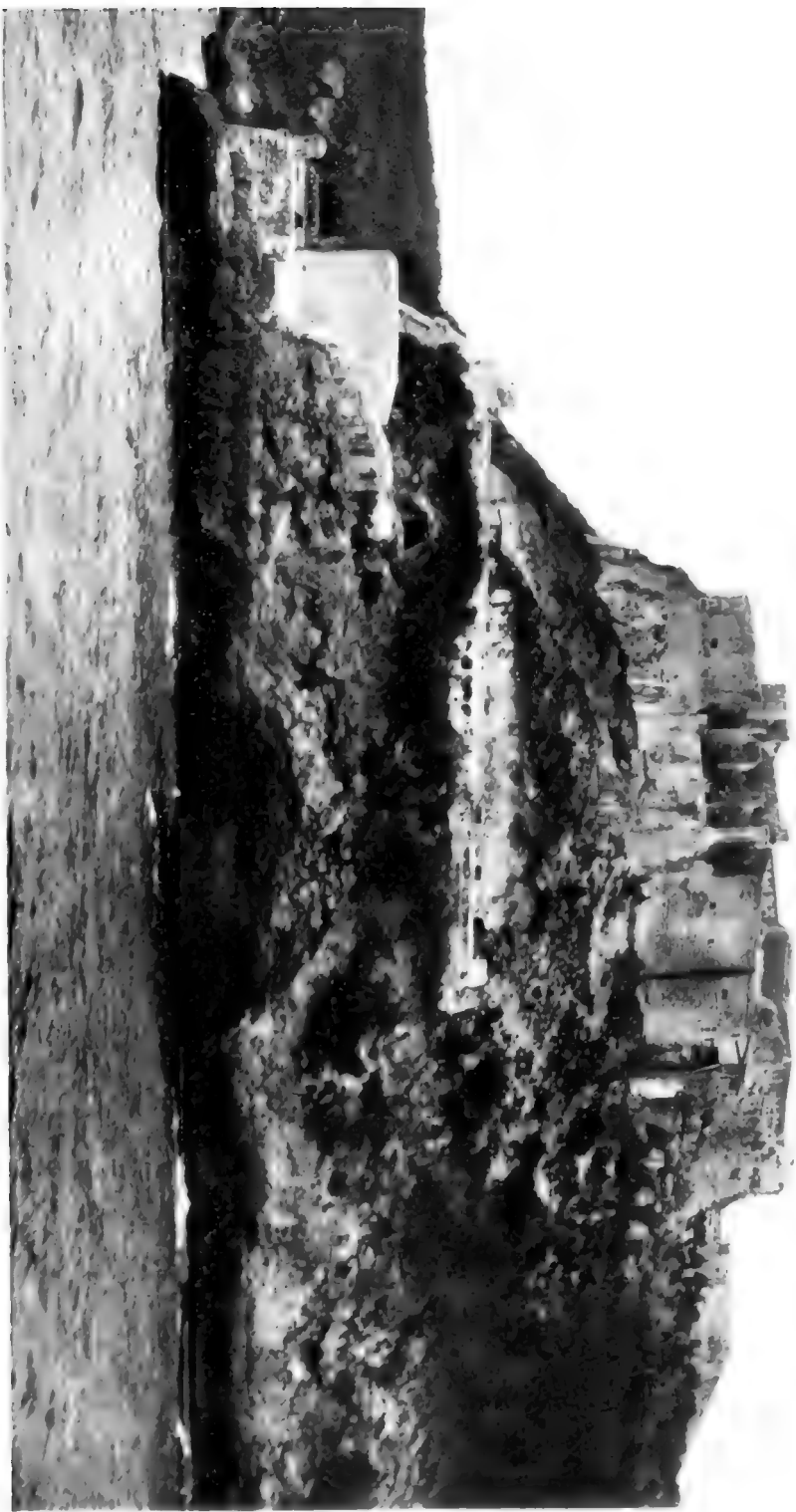

MORRO CASTLE, SANTIAGO DE CUBA.

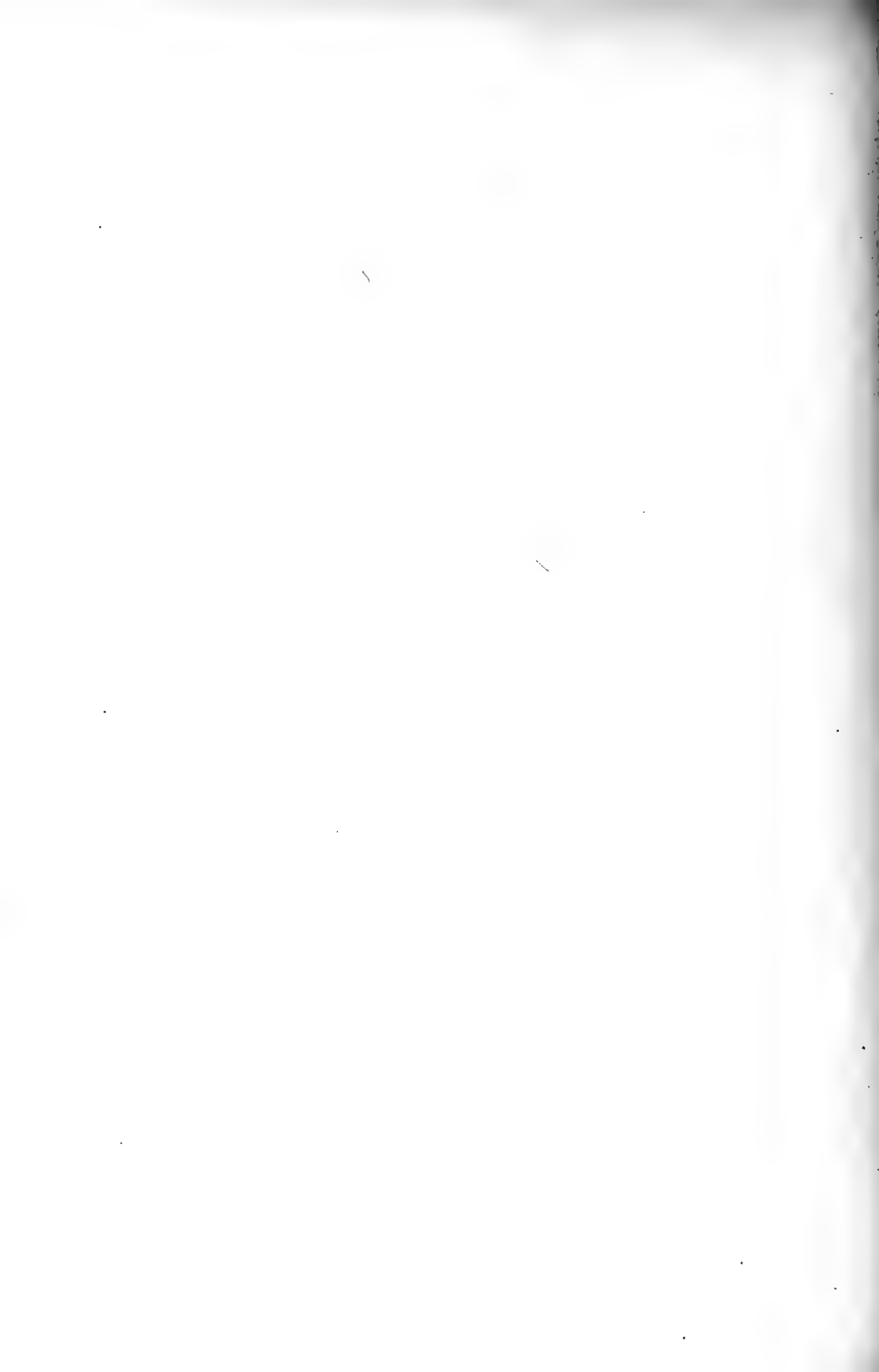

gold-washings. Pop. 8000.—(3) A town of Boyacá in Colombia, 9055 feet above the sea, with silver-mines, and 6000 inhabitants.

Santee, a river of South Carolina, is formed in the centre of the state by the junction of the Congaree and Wateree, flows south-east, and empties into the Atlantic Ocean. It is about 150 miles long, and is navigable for steamboats to Columbia and to Camden.

Santerre, ANTOINE JOSEPH, a French revolutionist, who for some time exercised an influence quite out of proportion to his abilities, was born at Paris, 16th March 1752. He followed the trade of a brewer in the Faubourg Saint-Antoine, and his wealth and generosity gave him an immense influence in the district. On the establishment of the National Guard in 1789 he received the command of a battalion, and took part in the storming of the Bastille. During the year 1792 the Jacobin agitators of the faubourgs often met in the brewery of Santerre, and it was there that the *émeute* of the 20th June was preconcerted, on which occasion Santerre marched at the head of the mob who invaded the National Assembly and turned out the Girondists. He also played a conspicuous part on 10th August, when he was made commander-in-chief of the National Guard. He was charged to keep order at the execution of the king, and it was he who bade the drummers drown the king's voice when he essayed to speak to the people from the scaffold. On 30th July he was appointed a general of division in the French army, and marched at the head of 20,000 men against the Vendéan royalists, but was miserably beaten (18th September), and in consequence recalled and imprisoned, and he only obtained his liberty after the death of Robespierre. He then withdrew into private life, and died 6th February 1809. Though he was hugely fond of 'brave words,' and menaced his opponents with all the bellicose grandiloquence of a French revolutionist, he was nearly as soft at heart as he was in the head. See *Life* by Carro (Paris, 1847).

Santhals. See SANTALS.

Santiago. See CAPE VERD ISLANDS.

Santiago, the capital of Chili and of Santiago province, stands in a wide and beautiful plain near the western base of the Andes, 1700 feet above sea-level, and 115 miles by rail ESE. of Valparaiso. The snow-capped cordilleras seem to enclose it on the north and east; while on the east side the picturesque Cerro de Santa Lucia—now dotted with grottoes, statues, kiosks, restaurants, a historical museum, and an observatory—rises abruptly within the city, some 800 feet from the level of the plain. Through the northern part rolls a small but turbulent stream, the Mapocho, now crossed by five handsome bridges. The city is regularly laid out, with streets comparatively broad, lit with gas and the electric light, and tramways in all directions; most of the houses, however, are of one story only, owing to the earthquakes (the most serious have occurred in 1575, 1647, 1730, 1822, 1835), though handsome private buildings are becoming every year more numerous. The principal square is the great Plaza Independencia, its sides formed by the government palaces, the Grand English Hotel, several arcades, and the cathedral and archbishop's palace. The cathedral is a large plain building of brick and stone, but inside it is very richly furnished. The Dominican church, only recently completed, is also worthy of notice. The Jesuit church which was burned down in 1863 has not been rebuilt; and on the site, opposite the capitol, a monument of marble and bronze has been erected (1872) in memory of the 2000 worshippers, mostly women, who perished in the fire. The capitol itself is a large two-story building

of yellow stucco. Other government buildings are the mint, with the official residence of the president; a large and well-managed prison; two excellent hospitals; a deaf and dumb asylum, &c. Santiago boasts a noble Alameda, with four rows of fine poplars, running nearly the whole length of the town, and adorned with numerous statues. Facing it are the university (1842), with 912, and the National Institute, with 1148 students. The city has also a military school; a school of arts; and a school of agriculture, with a large model farm; a conservatoire; two normal schools; a valuable national library (1813), with 65,000 volumes; botanical and zoological gardens; exposition buildings; and finally, three theatres, several club-houses, and a jockey-club. The suburbs of Santiago are very pretty, with villas and gardens bright with flowers. The climate is dry and generally agreeable, but the changes of temperature are somewhat trying. The city is of importance as a commercial place, and it has a busy stock exchange. Its manufactures include cloth, ship's biscuits, beer, brandy, &c., and it has also an ice-factory, a fruit-conserving establishment, and copper-smelting works. Santiago was founded by Pedro de Valdivia in 1541. Pop. (1865) 168,553; (1895) 256,403.—Area of the province, 5223 sq. m.; pop. (1895) 415,636.

Santiago de Compostella, a city of Spain, formerly the capital of Galicia, stands in a picturesque situation, surrounded by hills, 33 miles S. by W. of Corunna and 26 by rail N.E. of its port, Carril. Here in 835 the bishop of Iria discovered, according to the legend, the bones of St James (San Iago), being guided to the spot by a star, whence Compostella (*campus stellæ* = 'field of a star'); the relics were in 1884 solemnly affirmed by the pope to be still beneath the cathedral. This building, Romanesque in style, was built 1078-1188, and contains some fine sculptures and metal-work. It was the shrine that attracted every 25th July so many thousands of pilgrims in the middle ages, it being an especial favourite with Englishmen. It is now, however, out of repute, and is scarcely ever visited. This fact and the many ruined monasteries give the town a deserted and dreary appearance. Nevertheless it is still an archbishop's see, and has a university (1604) with 700 students, and a couple of colleges besides. Gold and silver ornaments are made and linen is woven. Pop. 24,302. The town is the headquarters of the knightly order of Santiago of the Sword (see ORDERS OF KNIGHTHOOD). For the festival of St James, see *Fraser's Magazine* (1864).

Santiago de Cuba, formerly the capital of the island of Cuba, and now the chief town of the eastern department, stands on a bay on the south coast, and has a harbour, deep, well protected, and fortified. During the Spanish-American War of 1898 Santiago was besieged by the United States forces; the Spanish fleet under Admiral Cervera, which had taken shelter in the harbour, made a dash out (3d July), but all the ships were sunk or captured. The town surrendered 17th July. It exports sugar, rum, cacao, coffee, tobacco, and mahogany. Pop. (1899) 43,090.

Santiago del Estero, a north central province of the Argentine Republic, with an area of 39,510 sq. m. and a pop. (1886) of 150,000. Except for a few insignificant sierras, it forms a vast plain, inclining gently from the north-west to the south-east. In the south-west and elsewhere there are great salt marshes. The only rivers are the Salado and Dulce; agriculture (sugar, maize, wheat, grapes, cotton, tobacco) depends mainly on irrigation. Cattle-farming is a leading industry.—The capital, Santiago, on the Rio Dulce, 750 miles by rail NNW.

of Buenos Ayres, was founded in 1553, has a national college and a normal school, and a pop. of 10,000.

Santipur, a town of Bengal on the Hooghly, 43 miles N. of Calcutta. Pop. 29,687.

Sants, or **SENTIS**, a mountain on the borders of the Swiss cantons of St Gall and Appenzell, consists of three parallel ridges, separated by deep valleys and connected by lofty saddles. The highest point is 8216 feet above sea-level. There are on the mountain, which commands very beautiful views, an observatory (since 1887) and a hotel.

Santley, CHARLES, baritone singer, was born in Liverpool on 28th February 1834, and trained as a singer partly in Milan (1855-57). He made his first appearance in England in Haydn's *Creation* in 1857, singing the part of Adam. Two years later he made his debut on the stage of Covent Garden; and three years later still he made his first essay in Italian opera. He was even better known from his appearances at concerts and in oratorio. In 1892, when he had largely withdrawn from public work, he published his reminiscences, *Student and Singer*.

Santo Domingo. See SAN DOMINGO.

Santo Espiritu, a city of Cuba, 22 miles by rail NNE. of Zaza, its seaport, on the south coast. It is damp and unhealthful. Pop. (1899) 12,696.

Santonin, $C_{15}H_{18}O_3$, is a crystalline neutral principle extracted from *Santonica*, the latter being defined in the British Pharmacopœia as the dried unexpanded flower-heads or capitula of *Artemisia maritima*, var. *Stechmanniana*. The plant grows in Russia, and belongs to the natural order Compositæ. Santonin occurs in brilliant white flat crystals, which become yellow on exposure to light, few specimens being colourless unless they have been recently prepared or very carefully kept in the dark. It is odourless, and almost tasteless; practically insoluble in water. Santonin is used in medicine solely as an anthelmintic, and is especially poisonous to the round worm (*Ascaris lumbricoides*), being much less so to the thread-worm (*Oxyuris vermicularis*). The dose is 2 to 6 grains for an adult, and 1 to 4 grains for a child; it may be given in powder, alone or mixed with sugar, or dissolved in a little olive or castor oil, or as the official lozenge (1 grain in each). It should be used with caution in weakly children. It is excreted in the urine, to which it imparts a deeper yellow colour, changing to red if the urine become alkaline. On colour vision it has often a peculiar effect, the cause of which has never been satisfactorily determined. Objects appear first purple or blue and then yellow, colour vision becoming finally destroyed.

Santorin, or **THERA**, an island of the Ægean, the southernmost of the Cyclades, 70 miles N. of Crete. It is shaped like a crescent, the horns pointing west; between them lies the island of Therasia. The space so enclosed, 18 miles in circuit, resembles a volcanic crater, and three small islands it encloses (the *Kaumenes*) are all of volcanic origin. Santorin and Therasia have lofty and precipitous shores (up to 1000 feet) next the crater; on their outer sides they slope away gradually to the sea, except that in the south-east of the former Mount St Elias rises to 1887 feet. The chief town, Thera or Phera, on the west coast of Santorin, is built in the cliffs of tufa and perched some 900 feet above the water's edge. Pop. of island (1889) 17,382. Excellent wine is grown on the disintegrated volcanic soil. Eruptions have taken place, chiefly near the *Kaumenes*, in the years 196 B.C., 726 A.D., 1573, 1650, 1707, and 1866. Interesting prehistoric dwellings, containing pottery and other remains, have been found in the

southern half of Santorin. The pottery is believed to be older than that of Mycenæ. There are also ruins of Greek temples and other buildings. This island is regarded as the special home of the vampire. See Tozer, *Islands of the Ægean* (1890); Fouqué, *Santorin et ses Eruptions* (Paris, 1879); and Bent, *Cyclades* (1885).

Santos, a port of the state of São Paulo in Brazil, founded in 1546, on the island of São Vicente, and at the foot of the church-crowned *Monte Serrate*. It has fine wharves, gas and tramways, and a good water-supply; but it is a hot, dirty, damp, unhealthy place, and yellow fever is endemic. A railway (40 miles, 5 of them by cable up the *Serra do Mar*—2500 feet) connects it with São Paulo, whose port it is. Of the exports the principal item is coffee. Pop. 15,000.

San Vicente, a pretty town of Salvador, 40 miles NE. of San Salvador, close to an extinct volcano of the same name, whose sides are among the most fertile places in the world, and produce especially coffee, indigo, and tobacco. Pop. 6000.

Sao Francisco, a large river of Brazil, rises in the south-west part of the state of Minas Geraes, flows north, north-east, and east-south-east to the Atlantic, and in its lower course separates the states of Bahia and Sergipe from Pernambuco and Alagoas. Length, about 1800 miles; drainage area, 248,000 sq. m. It is navigable as far up as its junction with the *Paraopêba*, except at three points—at the rapids of *Pirapôra*, near the frontier of Bahia, and where it breaks through the granite wall of the coast range, and forms the falls of *Paulo Affonso* (275 feet); traffic is carried past this last point by a railway (68 miles). Over the wide mouth there is a bar, with only 10 feet of water.

Saône, a river of France, an affluent of the Rhone (q.v.), rises in the dept. of Vosges, in the *Faucelles Mountains*, flows south-west as far as *Châlons*, thence south to the Rhone at *Lyons*. It is joined by the *Doubs* from the left. Entire length, 282 miles, of which 170 are navigable. Area of basin, 11,418 sq. m. See Hamerton's *The Saône: a Summer Voyage* (1887), a description of the river with numerous illustrations.

Saône, HAUTE, a department in the east of France, slopes south-west from the southern extremity of the Vosges, whose spurs diversify the north-east. It is watered chiefly by the *Saône* and its tributaries. Forests abound everywhere (31 per cent. of area). One-half of the total area of 2061 sq. m. is cultivable. The principal natural products are wheat, potatoes, and oats, iron, coal, and salt; and the manufactured, iron goods, glass and pottery, bricks, paper, and cottons. Fruit, especially cherries, is extensively cultivated. There are several mineral springs, the best known at *Luxeuil*. Pop. (1861) 317,183; (1896) 272,891. The *arrondissements* are *Gray*, *Lure*, and *Vesoul*; and *Vesoul* is the capital.

Saône-et-Loire, one of the largest departments of France, part of ancient Burgundy, is bounded on the SE. by the *Saône* and on the W. by the *Loire*. Area, 3300 sq. m.; pop. (1896) 621,237. The country consists for the most part of fertile plains, separated by rich vine-clad hills. The wines, of which 11,000,000 gallons are made annually, are well known as *vins de Mâcon*. Agriculture, iron and coal mining, and manufactures of cotton fabrics, pottery, iron rails and plates, machinery, engines, glass, &c. are carried on. The cattle are an exceptionally fine breed (white). There are five *arrondissements*—*Autun*, *Châlon*, *Charolles*, *Louhan*, and *Mâcon*; capital, *Mâcon*. The iron-town of *Creusot*, the pilgrimage

resort of Paray-le-Monial, and the once famous abbey-town of Cluny are all in this department.

São Paulo, capital of the Brazilian state of the same name, stands on a wide plain bounded by low hills, 4 miles from the Rio Tiete and 310 by rail W. by S. of Rio de Janeiro. It has houses of one story, a handsome public garden, and tramways running out to the beautiful suburbs. The principal buildings are the old Jesuit college, now the government palace, the bishop's palace, and a celebrated law-school. São Paulo is the headquarters of the coffee trade, and four railways connect it with the great coffee districts in the interior. There are cotton-weaving and printing works, and manufactories of tobacco, cigars, spirits, matches, gloves, and hats. Pop. 64,950, including 12,000 Italians and 1500 Germans; the latter have a school, a club-house, and a newspaper of their own.—The state (area, 112,330 sq. m.; pop. in 1895, 1,750,000), the most promising in the republic, stretches from the ocean to the river Paraná, and consists of a strip of coast-land (8 to 80 miles broad) and an elevated region, the latter occupying all the interior, and rising from 1600 feet: all this part is healthy, and the climate pleasant. The principal ranges are the Serras da Mantiqueira and do Mar. The rivers are numerous, and many of them of importance; regular steamboat service is maintained over a distance of 400 miles. The state possesses also 1133 miles of railway. Its mineral wealth includes magnetic iron, gold, marble, and precious stones. There is some cattle-rearing and a few manufactures; but the chief industry is agriculture. The principal crop is coffee; next follow sugar, cotton, tobacco, manioc, maize, and vinea. The exports of the state—by either Rio de Janeiro or its own chief port, Santos—amount to some 40 per cent. of the total for the republic.

Sap. See VEGETABLE PHYSIOLOGY.

Sap, in Military Engineering, is a narrow ditch or trench by which approach is made from the foremost parallel towards the glacis or covert-way of a besieged place (see SIEGE). For Sappers and Miners, see ENGINEERS.

Sapajou, a name sometimes applied to all that division of American monkeys which have a prehensile tail, and sometimes limited to those of them which are of a slender form, as the genera *Ateles* (see SPIDER-MONKEY), *Cebus* (q.v.), &c.

Sapindacea, a natural order of exogenous plants, consisting of trees and twining shrubs furnished with tendrils, very rarely herbaceous climbers. Their leaves are often marked with lines or pellucid dots. The order contains seventy genera and about 400 known species, natives of warm climates, especially of South America and India; none of them natives of Europe. The individuals of this natural order exhibit the most varied properties. Some produce delicious fruits, others are purely medicinal, some again abound in a saponaceous principle, while a few are dangerously poisonous, and still fewer yield wholesome food-products. The root of *Cardiospermum halicacabum* (Heart-seed) is diaphoretic, diuretic, and aperient, while in the Moluccas its leaves when cooked are eaten as a vegetable. The genus *Serjania* is poisonous; *S. ternata* (Supple Jack), a native of South America, is used to stupefy fish, and the long rambling stems from which it takes its popular name are cut into lengths for walking-sticks. The same poisonous principle resides in the genus *Paullinia* (see GUARANA); yet from the seeds of *P. sorbilis* Guarana bread is made. In the genus *Schmidelia* the same contradictory qualities are exhibited. The Soapberry (q.v.) is the fruit of *Sapindus saponaria*, the type of the order.

Sapodilla Plum, the name given in the West Indies to the fruit of *Achras sapota* and other species of *Achras*, a genus of the natural order Sapotaceæ. The seeds are aperient and diuretic, but an overdose is dangerous. The pulp of the fruit is subacid and sweet, and it is much esteemed for the dessert in the West Indies. Marmalade, Naseberry, &c. are names given to various species.

Saponification. See OILS, FATS, and SOAP.

Saponin is a vegetable principle contained in various plants, including the *Saponaria officinalis*, or Soap-wort, the *Polygala senega*, several varieties of *Lycchnis*, the fruit of the horse-chestnut, and in *Quillia* bark. It is readily extracted from the root of soap-wort by means of boiling alcohol, which, as it cools, deposits the saponin as an amorphous sediment. It derives its name from its behaviour with water, in which it is soluble in all proportions, yielding an opalescent fluid which froths when shaken like a solution of soap, if even $\frac{1}{100}$ th part of saponin be present. Its solution, or an infusion of soap-wort, is sometimes employed in place of a solution of an alkaline soap for cleansing the finer varieties of wool from grease. The various preparations for cleaning kid gloves, &c., which are sold under fancy names at every exhibition, owe their virtues to saponin. It is also employed by aerated water makers to give apparent body to their lemonade, &c., the public regarding a persistent head or froth as a guarantee of excellence.

Sapotaceæ, a natural order of exogenous plants, consisting of trees and shrubs, often abounding in milky juice. The leaves are leathery, entire, and without stipules. The order comprises about 20 genera and over 200 species. They are natives of the warmer regions of both hemispheres, but are comparatively rare in Australia, the Cape of Good Hope, North-west Africa, and South America. The most important species from an economical point of view is the Gutta-percha Tree (q.v.; *Isonandra gutta*). The substance called *Monesia*, an extract from the bark of *Chrysophyllum glycyphloemum*, employed in France in medicine, is a moderate stomachic excitant, alterative, and mild astringent. The fruit of *C. cainito* is the Star Apple (q.v.). *C. roxburghii*, a native of Silhet, also produces a fruit prized by the natives; but neither of these fruits find much favour with Europeans. The Mammee-Sapota, or American Marmalade, is the fruit of *Lucuma mammosa*, a lofty tree of tropical America and the West Indian Islands (not the Mammee-apple, q.v.). The pulp is luscious, but the kernels abound to a dangerous extent in prussic acid, a very little of one kernel being capable when eaten of causing sickness. The Sapodilla Plum (q.v.) is the fruit of *Achras sapota*. The flowers of some of the species of *Bassia* are edible; they are eaten raw or cooked in various ways; those of *B. latifolia* yield a strong ardent spirit by distillation. Oil is also expressed from the fruit of some of these, which is used in the manufacture of soap and as an inferior lamp-oil and lubricant. *B. butyracea* and *B. parkii*—the latter the Stea Tree of South Africa—both yield from kernels of their fruits a fine vegetable-butter. Valuable timbers are produced by some species of this order; one of the Ironwoods (q.v.) is the timber of *Siderozylon inerme*. The Galimeta Wood of Jamaica is the timber of *Bumelia salicifolia*. The flowers of *Mimusops elengi*, a native of the East Indies, are powerfully aromatic, and yield a fragrant water by distillation, and the seeds abound in oil which is used by painters.

Sappan Wood is the wood of *Cæsalpinia Sappan* (see CÆSALPINIA), used in Dyeing (q.v., p. 139).

Sapper, the name given to a private soldier in the corps of Royal Engineers (q.v.).

Sapphire, a gem excelled in value by no precious stone except diamond, and regarded as a variety of Corundum (q.v.), highly transparent and brilliant. It is sometimes colourless or nearly so. It more frequently exhibits exquisite colour, generally a bright red (i.e. the ruby) or a beautiful blue—the latter being that commonly called sapphire. Purplish or greenish colour indicates a flaw; and usual defects are clouds, milky spots, flakes, or stripes. It is found crystallised, usually in six-sided prisms, terminated by six-sided pyramids; it is sometimes found imbedded in gneiss, but more frequently occurs in alluvial soils. It occurs in Bohemia and Saxony, but European sapphires are of no commercial importance. The finest are found in Ceylon; Cashmere and Burma also produce fine specimens; and sapphires are found in Victoria, New South Wales, and parts of the United States. The value depends on quality more than on size, and does not increase with the size as does that of the ruby. Smaller ones vary from £2 to £12, carat-sized ones from £12 to £25. One of 165 carats, shown at the Paris Exhibition of 1867, was sold for £8000. In spite of its hardness it is sometimes engraved. It is doubtful if the sapphire named in Scripture was our sapphire or the Hyacinth (q.v.). By a 'male sapphire' (as in Browning) the ancients meant a dark-hued or indigo sapphire, by a 'female sapphire' one pale blue, approaching to white.

Sappho, one of the great poetesses of the world, was born either at Mitylene or at Eresos in Lesbos. She was only six years old when she lost her father Scamandronymus, and she must have flourished about the end of the 7th century B.C., as she was contemporary with Alceus, Stesichorus, and Pittacus. But little is known with certainty of her life, save that she had a daughter named Cleis, and was acquainted with Alceus. We are told, with much less certainty, that she fled about 596 from Mitylene to some place of refuge in Sicily, but after some years was again at Mitylene, the centre of a group of girls with a passion for poetry. Her famous plunge into the sea from the Leucæan rock, because Phaon did not return her love, seems to have no historical foundation whatever. The traditional account of her moral character was first assailed by Welcker (1816), who carried his argument to the absurd extreme of making her a paragon of virtue. This view Bergk and Colonel Mure both attacked, and the progress of the controversy may be seen in the *Rheinisches Museum* (1857-58). Without believing her the exceptionally immoral woman of Greek tradition, we can scarcely take her at Welcker's valuation, looking at the poetry itself and the easy standard of her age. But about the much more important question of her genius there can be no doubt whatever. For sincerity, depth of feeling, passion, and exquisite grace of form her lyrics stand alone among the masterpieces of antiquity. Her poems were divided by the Alexandrine scholars into nine books, according to their metres. But two of her odes, one to Aphrodite, with a number of short fragments, are extant. Most of these were composed in the metre named from her the *sapphic strophe*, rendered familiar from its use by Horace.

The best text is that contained in Bergk's *Poetæ Lyrici Græci* (vol. iii. 4th ed. 1882). See Poentzen, *Griechische Dichtersinnen* (Vienna, 1876); Arnold, *Sappho, ein Vortrag* (Beri. 1871); Koehly (in *Akademische Vorträge*, Zurich, 1850); Sobine, *Untersuchungen über das Leben der Sappho* (Leip. 1867); and H. T. Wharton's edition of the text, with life, translation, &c. (Lond. 1886). The last contains a good bibliography of the books

and papers written on Sappho, to which may be added the metrical translation by James S. Gasby-Smith (Washington, 1891).

Saprogonia. See SALMON, p. 117.

Saprophytic Plants are plants that feed upon decaying organic matter. In common with many of the Parasitic Plants (q.v.), which are plants that live on or in and at the expense of other organisms, they are often devoid of chlorophyll. The reason of this peculiarity is obvious. Chlorophyll being the material used by ordinary plants for the decomposition of the carbonic acid of the air in order that they may retain the carbon, and with it build up all the carbon compounds characteristic of organic nature (see VEGETABLE PHYSIOLOGY), it is plain that those plants which in virtue of a saprophytic or a completely parasitic habit obtain their carbon compounds ready-made up to a certain point do not require a special mechanism of green stuff to manufacture those compounds. If the saprophytism be not complete or 'pure' there will be at least some chlorophyll remaining, as in the flowering axis of the orchid *Neottia*. Saprophytes may obtain their nourishment and especially their carbon compounds either from the remains of dead organisms or from organic compounds formed by living organisms. The fungi that live upon the bark of trees and the leaf-soil of forests and meadows (e.g. mushrooms) are examples of the former case; those that feed upon the juice of fruits and sugary solutions (e.g. moulds and yeasts) of the latter case. Examples of saprophytes are found in the Phanerogams, the Fungi, and the Bacteria. Among the Phanerogams are some common native Orchids—*Neottia*, *Corallorhiza*, *Lactæa*, and *Monotropa*. After prolonged nourishment within the loose humus such plants send up flowering shoots above the surface.

Fungi (q.v.) may be physiologically classified as parasites and saprophytes; but this classification does not coincide with a morphological one. Further, there are certain species which lie between the two extremes, and these may be described as parasites which may become wholly or in part saprophytic, through the whole course of their development or during certain stages of it; and also there are saprophytes which, with the same variations, may become parasitic. Hence the complete physiological classification of the Fungi becomes (1) Pure saprophytes; (2) 'Facultative' saprophytes—i.e. parasites which become saprophytic; (3) 'Obligate' parasites—i.e. species to which the parasitic life is indispensable; (4) 'Facultative' parasites.

The external conditions necessary for the commencement of germination of Fungi are the same as those needful to the germs and seeds of other plants: they are a certain temperature, a supply of oxygen and of water, in certain cases a supply of nutrient substances. The spores of the Peronosporæ and of the Uredinæ germinate on drops of pure water; nutrient solutions may even be a hindrance. The Mucorini, on the other hand, emit only rudimentary germ-tubes in pure water; they require a nutrient solution for germination. Most Fungi vary towards one extreme or other according to the species.

A further characteristic of many Fungi is that certain species are only to be found upon a specific substratum. For instance, the Saccharomycetes, which excite alcoholic fermentation, appear on fruits only when these are ripe, and in the winter are found in soil around those plants whose ripe fruit they attack, and very rarely in any other place. Further, the effect upon the substratum varies with the species to a greater or less extent. On the other hand, many diverse species live on the same substratum and effect the same results upon it—e.g. many species of Saccharomycetes and certain

species of *Mucar* produce very similar fermentations in saccharine fluids (see FERMENTATION). A destructive effect is witnessed in the reduction of timber to a mass of dirt by *Merulius lacrymans*.

Bacteria (q.v.) may be classified physiologically in the same terms as the Fungi. And their functions vary in the same way. Many oxidise their substratum; the *Micrococcus* of vinegar oxidises ethyl-alcohol into acetic acid, and by further combustion into carbonic acid and water. Others excite characteristic fermentations, lactic acid, butyric acid fermentations, &c., produced by specific organisms. Others incite Putrefaction (q.v.).

For further information, see Goebel's *Outlines of Classification and Special Morphology*; De Bary's *Morphology of the Fungi, Mycetozoa and Bacteria*; Sachs's *Physiology of Plants*; Vines's *Physiology of Plants*; and the literature referred to in these works.

Sapucaia Nuts, the seed of *Lecythis ollaria* and *L. zabucajo* trees, plentiful in the forests of the north of Brazil, and belonging to the natural order Lecythidaceae. The fruit is urn-shaped, as large as a child's head, and opens by a lid which falls off. Each fruit contains a number of seeds or nuts, as in the case of the allied Brazil nut; but the flavour is finer than that of the Brazil nut. Its form is oval, somewhat pointed at both ends, which are slightly bent in opposite directions.

Saraband (Fr. *sarabande*, Span. *zarabanda*—word and thing both derived from the Moors), originally a slow dance, and hence a short piece of music, of deliberate character, and with a peculiar rhythm, in $\frac{3}{4}$ time, the accent being placed on the second crotchet of each measure. The saraband was of frequent occurrence among the *suites* or series of short pieces written by Handel, Sebastian Bach, and others of the old masters, for the harpsichord or clavichord.

Saracens, a name variously employed by mediæval writers to designate the Mohammedans of Syria and Palestine, the Arabs generally, or the Arab-Berber races of Northern Africa, who conquered Spain and Sicily, and invaded France. At a later date it was employed as a synonym for all infidel nations against which crusades were preached, and was thus applied to the Seljuks of Iconium, the Turks, the Gypsies, and even the pagan Prussians. The true derivation of the word was long a puzzle to philologists; Du Cange deduced it from Sarah, the wife of Abraham, an opinion coinciding with that of the mediæval Christian authors; Hottinger, from the Arab. *saraca*, 'to steal'; Forster, from *sakra*, 'a desert'; while others strove to see its origin in the Hebrew *sarak*, 'poor'; but the opinion which has been most generally supported, and prevails at the present time, is that the word was originally *Sharakeni* (Arab. 'eastern people'—as opposed to *Maghribe*, 'western people'—i.e. the people of Morocco), corrupted by the Greeks into *Sarakēnoi*, from which the Romans derived their word *Saraceni*. The epithet *Sarakenoi* was applied by the Greek writers (from the 1st century of the Christian era) to some tribes of Bedouin Arabs in eastern Arabia, though they do not agree among themselves as to the particular tribe so denominated. Pliny and Ammianus place the Saracens in Arabia Petrea and Mesopotamia, on the common frontier of the Roman and Persian empires; and the description of them by Ammianus, a most painstaking and accurate historian, coincides, in every important particular, with what is known at the present day of the Bedouin tribes of those regions. See ARABIA, CALIFS, CRUSADES, MOHAMMEDANISM, MOORS, SALADIN, SPAIN, TEMPLARS; and for Saracenic architecture, see ARABIAN ARCHITECTURE, and the section on architecture in the articles INDIA (Vol. VI. p. 109) and PERSIA (Vol. VIII. p. 70).

Saragossa (Span. *Zaragoza*), a city of Spain, formerly the capital of the kingdom of Aragon, by rail 212 miles N.E. of Madrid and 227 W. by N. of Barcelona, stands on the Ebro, which divides the city into two parts, and is crossed by a noble stone bridge of seven arches, built in 1437. The city has an imposing appearance from a distance, being adorned with numerous slender towers and spires; but inside the walls it is full of narrow winding lanes, with brick houses of most solid structure, though many of them are now falling into decay. The quarters that have been rebuilt since the French siege are of course different; the streets wide and the houses of better appearance. Saragossa was the Celtiberian *Salduba*, changed to *Cæsarea Augusta* in 25 B.C., of which the present name is a corruption. Although a place of importance under the Romans, there are few remains of the Roman city. One of the first cities of Spain to adopt Christianity (3d century), it afterwards became rich in relics, to which miraculous powers were ascribed. Saragossa was taken by the Goths in the 5th and by the Moors in the 8th century, and was recovered from them in 1118 by Alphonso of Aragon after a siege of five years, during which great part of the inhabitants died of hunger. The most momentous event in its recent history was the siege by the French (June to August 1808 and December 1808 to February 1809), in which the inhabitants, led by Palafox (q.v.), offered a most determined resistance, some 60,000 in all perishing. The services of the 'Maid of Saragossa,' said to have assisted or fought by the side of her artilleryman-lover, seem to have been greatly exaggerated by Southey, Byron, and Sir David Wilkie in treating the theme. Saragossa has two cathedrals, the older a Gothic edifice (1316); the more modern (17th century) boasts of a pillar on which the Virgin descended from heaven (40 A.D.), to which pilgrims still flock. Its defences include the citadel (Aljaferia), anciently the palace of the kings of Aragon and later the headquarters of the Inquisition in this part of Spain. There are also a university (1474) with 800 students, a library of 18,000 vols., an academy of sciences, and a large archiepiscopal palace. The leaning Torre Nueva, dating from 1504, was in 1890 deemed unsafe and doomed by the authorities to demolition. The leading industries turn out cloth, silks, leather, soap, and chocolate. Pop. 93,500.—The province has an area of 6727 sq. m. and a pop. of 415,000.

Sarajevo. See BOSNA-SERAI.

Sarakhs, a town in the extreme north-east of Persia, stands on the Heri-Rud, in a position of considerable strategic importance. It was destroyed by the Persians in 1832, and is now a miserable place of Turkoman tents and huts; but there is a strong fort. The Russians in 1885 occupied the opposite bank of the river; and the place has been often mentioned in connection with the delimitation of boundaries between Russian, Persian, and Afghan territory. See the map at AFGHANISTAN.

Saransk, a town of Russia, 65 miles N. of Penza; pop. (1895) 13,921.

Sarasate, MARTIN MELITON, violinist, was born of Basque parentage at Pampluna in Spain. 10th March 1844. Taken to Paris whilst still a child, he studied at the conservatoire there from 1856, and won the first prize for the violin in 1857; then, having finished his studies, he began what was to be his life's occupation, travelling from town to town and from continent to continent giving concerts. He first appeared at London in May 1874, playing at one of the Philharmonics. He always draws large audiences, his style being pure, easy, and graceful: he can play with fire and passion, and his taste is nearly faultless. He has

composed only light pieces, chiefly Spanish dance tunes.

Saraswati is, in Hindu Mythology, the name of the wife, or the female energy, of the god Brahma, the first of the Hindu Trimūrti or triad. She is also the goddess of speech and eloquence, the patroness of music and the arts, and the inventress of the Sanskrit language and the Devanāgarī letters.

Saratoff, a city of Russia, on the right bank of the Volga, exactly 500 miles by rail S.E. of Moscow. It is a city of broad streets and fine squares, and stands on terraces rising from the river. There are nearly thirty churches: a handsome new cathedral (1825), an old cathedral (1697), and Radistcheff's Museum, sheltering a fine art gallery and a library. Manufactures of brandy, liqueurs, flour, oil, and tobacco are carried on. Fishing is prosecuted in the river, and market-gardening (especially fruit and the sunflower) in the vicinity. There is an important trade in corn, salt, iron, wooden wares, textiles, and groceries. The population has grown rapidly—50,000 in 1830; 70,000 in 1860; 137,109 in 1897. The city was pillaged by Pugatcheff in 1774, and suffered severely from fire several times during the 19th century.—The *government*, the east side of which is washed by the Volga, has much fertile soil, growing rye, oats, wheat, oil-plants, and flax; it has few industries except agriculture, distilling, and corn-grinding, but considerable trade. It was colonised in the end of the 18th century. The population, 2,419,884 in 1897, embraces several flourishing German colonies (pop. 120,000) which settled here in 1763-65. Total area, 32,624 sq. m.

Saratoga Springs, one of the chief watering-places in the United States, is in New York, 38 miles by rail N. of Albany. It contains more than a score of mineral springs, whose waters, prescribed in diseases of the liver, chronic dyspepsia, &c., are bottled in large quantities for exportation. In the village are a large number of hotels, some accommodating over 1000 guests. There is a race-track, and regattas are held on Saratoga Lake, 4 miles distant. Twelve miles to the east a handsome obelisk (1877), 155 feet high, on a bluff 350 feet above the Hudson River and overlooking the scene, commemorates the surrender of Burgoyne (q.v.) to Gates, on October 17, 1777. Pop. (1890) 11,975.

Sarawak, a state on the north-west of the island of Borneo, in the East Indies, placed by its ruler, Rajah Brooke, in 1888 under the protection of Britain. The Chinese Sea washes its north-west side; on the north-east is the protected state of Brunei; and on every other side it is surrounded by Dutch Borneo. The boundaries next Dutch Borneo were fixed by an Anglo-Dutch commission appointed in 1891. The area of Sarawak is estimated to be 41,000 to 45,000 sq. m., and its pop. 300,000. The coast belt is in many parts low, the interior hilly, rising to close upon 8000 feet near the frontiers. The country is drained by a number of short streams, several of which have wide estuaries; the longest, the Rajang, has a sinuous course of 350 miles, and is easily navigable for 150 miles up. The state contains some valuable minerals: antimony, quicksilver, gold, and coal are mined to some extent, and copper, diamonds, and manganese exist, though hardly in paying quantities. The most important products are sago, pepper, gambier, gutta-percha, india-rubber, birds' nests, rattans, tea, coffee, and timber, all of which are exported. Trade is carried on principally with Singapore. The exports average £234,800, the imports £202,700 a year. The people consist principally of Malays, Chinese, and Dyaks. Chief town, Kuching, with a pop. of 25,000, standing 20 miles up the Sarawak River. Dying in 1868, Sir

James Brooke (q.v.) was succeeded by his nephew, Sir C. J. Brooke, who, after greatly extending his territory northwards after 1881, put it in 1888 under the protection of Britain. The English bishop of Singapore is also bishop of Sarawak.

See Spencer St John, *Life in the Forests of the Far East* (1862); Charles Brooke, *Ten Years in Sarawak* (1866); N. Denison, *Tour amongst the Land Dyaks of Upper Borneo* (Singapore, 1879); Helms, *Pioneering in the Far East* (1882); and books quoted at BROOKE.

Sarcomet. See SARNET.

Sarcina. See BACTERIA, Vol. I. p. 647.

Sarcocystis. See GREGARINIDA.

Sarcode. See PROTOPLASM.

Sarcolemma is the term applied to the delicate sheath which invests each primary muscular fibre. See MUSCLE.

Sarcoma is an ancient term which was vaguely used of tumours of a more or less flesh-like consistence, but had fallen into disuse. It was adopted by Virchow as the general name for a large and important class of new formations, and is at present universally employed as defined by him. The tumours now called Sarcomata are mainly composed of cells resembling those of some form of embryonic or imperfectly developed connective tissue, rather than those of any part of the adult organism. Their structure, as well as their individual cells, usually suggests an embryonic condition: the cells are imbedded in a structureless matrix; and the blood-vessels are often mere channels between the tumour-cells. They are thus distinct from the Carcinomata, or cancers proper, which consist of epithelial cells in a framework of fully organised fibrous tissues; though they share with them the property of malignancy (see CANCER, TUMOUR). They are generally classified, according to the form of their most characteristic cells, as round-celled, spindle-celled, and myeloid sarcomata. They are most common before middle life, and may occur in any organ of the body. Their course presents the greatest possible variety: some myeloid and spindle-celled sarcomata are slow in their growth, and but little apt to recur after removal; some forms of round-celled sarcoma may rival and even surpass the true cancers in rapidity of growth and diffusion through the body. When secondary tumours occur they are not commonly in the neighbouring lymphatic glands, as in cancer, but in distant organs, and particularly in the lungs.

Sarcophagus (Gr., 'flesh-eater'), any stone receptacle for a dead body. The name originated in the property assigned to a species of stone, found at Assos in Troas and used in early times, of consuming the whole body, with the exception of the teeth, within the space of forty days. The oldest known sarcophagi are those of Egypt, some of which are contemporary with the pyramids. The earliest of these are of a square or oblong form, and either plain or ornamented with lotus leaves; the later are of the form of swathed mummies, and bear inscriptions. The pyramids were sepulchral tombs built to contain the sarcophagi of the kings of Egypt: the Phœnician and Persian kings were also buried in sarcophagi. The Roman sarcophagi of the earlier republican period were plain. Sarcophagi were occasionally used in the later republic, although burning had become the more general mode of disposing of the dead. The use of stone chests for the interment of distinguished persons has not been altogether discontinued in modern times. See BARROW, BURIAL, COFFIN, MAUSOLEUM.

Sard, or SARDA, a variety of quartz, differing from carnelian only in its very deep red colour,

blood-red by transmitted light. It is rare, and brings a much higher price than common carnelian. The name is probably from Sardinia. The Sardonyx is an Onyx (q.v.) containing layers of sard.

Sardanapa'lus. See ASSYRIA.

Sardes. See SARDIS.

Sardine (originally 'the Sardinian fish,' and applied to a kind of tunny), the French name for Pilchard (q.v.), in England used for small pilchards specially prepared. In France and Portugal sardines are cured with oil in tin boxes, forming a much-esteemed delicacy, and, at the same time, a most wholesome article of food; in this form they are exported to all parts of the world. To cure them in this way, they are first carefully washed in the sea, then sprinkled with fine salt, and after a few hours the head, gills, &c. are removed; they are then washed again, and spread out on willow branches or wire-work, exposed to the sun and wind, if the weather is dry, but in damp and rainy weather to a current of air under cover. They are next put into boiling oil, in which they remain for a short time, and when they are taken out the oil is drained away from them as much as possible, and they are put into the tin boxes whose shape and appearance are so familiar to every one. The boxes, being filled with sardines, are filled up with oil, the lid is soldered on, and they are placed for a short time in boiling-water, or exposed to hot steam. The boxes which have leaked or have burst in boiling are rejected, and those which remain sound are now ready for the market. Sardines have of late years been much less abundant off the French coasts. *Sardines à l'huile* are made from sprats at Deal in Kent. Maine, U.S., now produces large quantities of excellent sardines from a small kind of herring, Eastport canning as many as 600,000 cases in a year. In the south of France sardines are sometimes cured in red wine.

Sardinia, an island of Italy, after Sicily the largest in the Mediterranean, lies 135 miles W. of the Tiber mouth, and immediately south of Corsica, being separated from it by the Strait of Bonifacio, $7\frac{1}{2}$ miles wide. In shape it resembles an oblong set on end, with a deep wide bay, the Gulf of Cagliari, in the south, and another, the Gulf of Porto Torres, in the north. From north to south it measures 170 miles, and from east to west, on the average, 75 miles. Area, 9206 sq. m. Off various points along the shores lie islands, the largest being San Antioco, San Pietro, Dell'Asinara, Maddalena, Caprera, Tavolara, &c. The surface is generally mountainous, the configuration that of a tableland running up into ranges and isolated peaks. The highest points occur along the eastern side of the island, and reach 6233 feet in Gennargentu in the centre, and 4287 in the mountains of Limbara in the north. The western side of the island ranges at about 1240 feet, though the extinct volcano of Monte Ferru reaches 3400. The south-west corner is separated from the main mass of the island by the low alluvial plain of Campidano, which stretches from the Gulf of Cagliari to the Gulf of Oristano, on the west coast; at both extremities of it there are extensive salt lagoons. The only other low-lying tracts are the lower portions of the river valleys. The streams, however, are mostly short, the longest not exceeding 65 miles. The north-eastern shores are high and rocky. On the west the coast-line is more irregular than on the east; the grotto of Neptune, on this west coast, is one of the finest in Europe. Ever since the time of the Roman possession the climate of the island has been in evil repute. This is because of the malaria that prevails in the low-lying tracts, where there is often much stagnant

water after the rains, and much decaying vegetable matter in the hot season. The parts that lie at a higher level are quite as healthy as the corresponding districts of Italy. A more extended cultivation of the soil and the drainage of the marshes or inland lagoons would greatly diminish the malaria, as experiment in certain districts has proved.

Sardinia is in nearly all respects a backward island. It has fine natural resources—fertile soil, valuable mines, extensive forests, rich fisheries, and excellent facilities for manufacturing industry. But owing to the old-fashioned conservatism of the people, their apathy, their primitive methods of agriculture, lack of enterprise and capital, and want of means of communication, and long years of negligent if not inefficient government, its resources are by no means developed to the extent they could be; many lucrative industries are in the hands of foreigners, others are neglected by the Sardes, and those that they do carry on are often carried on in a half-hearted manner and with obsolete methods. Feudalism was not finally abolished in the island until 1856. Of the total area about one-third is arable land, one-third pasture, and nearly one-third (28 per cent.) forest. The first place amongst the natural resources is taken by the agricultural products, in spite of the backward farming, the heavy taxation, and the extremely minute subdivision of the soil. The principal produce is wheat, barley, beans, potatoes, wine (21,500,000 gallons per annum), olive-oil ($1\frac{1}{2}$ million gallons), oranges, lemons, tobacco, flax and hemp, cheese, butter, and wool. The breeding of horses is an important industry; and large numbers of cattle, sheep, swine, and goats are kept. The growing of fruits and the breeding of the domestic animals are both carefully attended to, and the products of both industries are improving; but the only improvement in the management of the soil is the drainage of the marshes by the government (who own one-fifth of the area) and private individuals. Besides being in ancient times the granary of Rome, Sardinia was renowned for its mineral wealth. After lying unused from the fall of the Roman empire the mines were again worked by the Pisans in the 14th and 15th centuries; but work was not resumed in them with any degree of energy until towards the middle of the 19th century. At the present time some 10,000 persons are employed in extracting of lead (with silver) and zinc, and to a less extent lignite, antimony, and manganese. Iron and copper also exist. Granite, marble, and clay for pottery are quarried. Salt is manufactured from sea-water, chiefly by convicts at Cagliari. The mines are mostly situated in the south-west, in the neighbourhood of Iglesias. The total produce for a year averages £675,000 in value. The centre and north of the island are chiefly covered with forests, though they are being all too rapidly diminished. The commonest as well as the most valuable trees are the oak, ilex, cork, and wild olive, which yield timber, cork, bark for tanning, acorns, and charcoal to the annual value of close upon £300,000. The seas yield large quantities of tunny, sardines, anchovy, and coral, though the fisheries, except for tunny, are not prosecuted by Sardinians, but by Italians; the native fishermen prefer to catch trout, eels, lobsters, crabs, &c. in the rivers and inland lagoons. Sardinia has no extensive manufacturing industries, though there is some tanning and making of cigars, aerated waters, macaroni, flour, and spirits. There are, however, a variety of domestic industries for home use; most of the women still ply the spinning-wheel. Until the year 1828 Sardinia had no roads for wheeled vehicles, the Roman roads having gone to ruin centuries ago. Now there are good roads throughout the island; and they are supplemented by 350

miles of railway. In spite of their maritime situation the Sardinians are not fond of the sea. The island has numerous fairly good ports—Cagliari (the capital), Porto Torres, Terranova, Tortoli, Alghero, Carloforte, and Bosa—most of which are being improved by the construction of harbour-works. About 6000 vessels of 1½ million tons enter every year. The inhabitants are for the most part of mixed race, Spanish and Italian elements predominating. Pop. (1815) 352,867; (1840) 524,000; (1871) 636,660; (1881) 682,000; (1895) 751,255; (Sicily, with an area of 9961 sq. m., has a pop. of 3,484,125). This gives a density of 81 persons to 1.6 square mile; Italy has 280 to the square mile. Education is in a very backward state, 83 per cent. of the population being unable to read and write. The two universities at Cagliari and Sassari are frequented by only 260 students in all. The practice of the vendetta and brigandage were extremely prevalent amongst this people; but both have now almost entirely ceased. The language is a mixture of Latin, Spanish, and Italian; but the dialects of different parts differ considerably. Classical Italian is the official language, and is used by the educated classes. The moufflon or wild sheep, with red deer, fallow deer, wild boar, and an abundance of smaller game, such as hares, partridges, woodcock, snipe, &c., are the creatures chiefly hunted. Administratively the island is divided into the two provinces of Cagliari and Sassari. There are three archbishoprics, Cagliari, Sassari, and Oristano, and eight bishoprics. Sardinia sends twelve members to the Italian chamber of representatives and three to the senate.

There are numerous remains of a remote and now wholly forgotten antiquity, about which nothing is known beyond the *nurhags* or Nuraghe (q.v.) and 'giants' graves,' and other memorials. The 'giants' graves' are excavated spaces, 15 to 30 feet long and 4 to 6 feet wide, surrounded by stones.

History.—The aboriginal inhabitants are believed to have been of Iberian stock, though this is by no means certain. They seem to have been conquered by the Phœnicians at an early period; but little authentic is known before the conquest by the Carthaginians in 512 B.C. For two centuries and a half this people bitterly oppressed the native inhabitants, so that when the Romans came in the 3d century they were hailed as deliverers. But the Sardinians did not at first bear the Roman yoke very patiently, though afterwards, from the reign of Tiberius onwards, they enjoyed three hundred years of continuous peace, and prospered greatly. After the fall of the Roman empire evil days again fell upon the island: it was overrun by Vandals and Goths, and then for many years was incessantly harassed by the Saracens. During this time its nominal masters were the Byzantine emperors (till 774) and the popes. In the beginning of the 11th century the Pisans and Genoese undertook the task of driving out the Saracens and holding the island against them; but they had a hard task for twenty years or more. Then, the Moslems beaten off, they took to quarrelling with one another, and only agreed to divide the island between them in 1299, Genoa taking the north, Pisa the south. But the real internal government was in the hands of four 'judges' or chiefs, each ruling a separate province; this arrangement existed several centuries before the Pisans came, and continued to exist for several centuries longer. The pope, who still claimed the overlordship, at this time gave Sardinia to the king of Aragon; and he made himself definitively master of it in 1416. The Aragonese and their sovereign successors, the Spaniards, kept possession of it till the treaty of Utrecht (1713); it then passed to Austria, but in 1720 was given to the

House of Savoy in exchange for Sicily. United with Savoy and Piedmont, it gave title to a new kingdom, the kingdom of Sardinia. See SAVOY.

See Tennant, *Sardinia and its Resources* (Rome, 1885); Tyndale, *Island of Sardinia* (3 vols. 1849); C. Edwardes, *Sardinia and the Sardinians* (Lond. 1889); *Annali di Statistica*, No. XI. (Rome, 1887); *Nineteenth Century* (June 1887); La Marmora, *Voyage en Sardaigne* (5 vols. 2d ed. Paris, 1837-57); and the historical works of Manno (4 vols. Turin, 1825, and 1 vol. Florence, 1858).

Sardis, the capital of ancient Lydia in Asia Minor, stood at the northern foot of Mount Timolus (5906 feet) and 2½ miles S. of the Hermus. Through its market-place flowed the Pactolus over sands rich in gold, an allusion in all probability to the wealth of the inhabitants, who wove woollen stuffs and carpets, and organised the traffic between the highlands of the interior and the coast; it was, moreover, the grand and luxurious capital of Croesus, a monarch of fabulous wealth. In spite of the strength of its citadel, it was destroyed by the Cimmerian Gauls in the 7th century B.C., by the Athenians in the 6th, by Antiochus the Great in 215 B.C., and by Timur in 1402; besides this it was overwhelmed by earthquake in the reign of Tiberius. Both Xerxes and Cyrus the Great resided here before setting out on their great expeditions. As Byzantium rose to importance, Sardis lost the advantages of its situation on the great land-route between Persia and Rome, and gradually declined. At the present day there is nothing left at its site, Sart, except a small village and ruin mounds. The cemetery of the ancient city, 4 miles distant across the Hermus, is of great extent, and has been in part opened up in recent times.

Sardonie Smile is a term applied by the older medical writers to a convulsive affection of the muscles of the face, somewhat resembling laughter. It may occur in tetanus or lock-jaw, and other convulsive affections, or may result from the action of certain vegetable poisons. The name is said to be from a ranunculus termed *Herba sardonica*, a Sardinian plant; but is probably from the root *sar*, 'to grin' (Gr. *sairein*).

Sardonyx. See ONYX, and SARD.

Sardou, VICTORIEN, a French dramatist, was born at Paris on 7th September 1831. He studied medicine, but took to the writing of dramas instead of practising. His first efforts were decidedly failures, but through his marriage with an actress, who nursed him when sick and in the extremity of want, he became acquainted with the celebrated Déjazet, for whom he wrote two very successful pieces, *Monsieur Garat* and *Les Prés Saint-Gervais* (1860). In a few years he had amassed a fortune. He has been almost as prolific as Scribe, with whom he may be fitly compared, but whom he in many respects exceeds. With a first-rate knowledge of stage-effect he combines an unrivalled instinct for what will just suit the taste of the playgoing public. His comedies are in general loosely constructed, but full of rapid action; the character-sketching and the emotional elements are both superficial; the dialogue is brilliant and witty, but the episodes are often very improbable. Sardou makes fun of the foibles of his contemporaries in a very clever, amusing fashion. His works are hardly literature; they are much better suited for acting than for being read. Pieces like *Nos Intimes* and *Les Ganaches* (1861), *Les Vieux Garçons* and *La Famille Benoitton* (1865), *Nos Bons Villageois* and *Maison Neuve* (1866), *Rabagas* (1872), *Dora* (1877), *Daniel Rochat* (1880), *Odette* (1882), and *Marquise* (1889) make a fair sample of his capabilities and style. For Sarah Bernhardt he wrote the well-known

Fédora (1883), *Théodora* (1884), and *La Tosca* (1887). He has, moreover, attempted the higher historical play in pieces like *La Patrie* (1869), *La Haine* (1874), and *Thermidor* (1891). Sardou was elected to the Academy in 1877. See Montégut in *Revue des Deux Mondes* (1877).

Sargasso Sea. See ATLANTIC, GULF STREAM, GULFWEED.

Sargent, JOHN SINGER, subject and portrait painter, son of an American physician, was born at Florence, Italy, in 1856, and was elected an A. R. A. in 1894, and R. A. in 1897.

Sargon. See ASSYRIA, Vol. I. p. 516.

Sari, capital of the province of Mazanderan, Persia, lies 18 miles S. of the Caspian Sea. It is a greatly decayed place of some 8000 inhabitants.

Sark (Fr. *Gers*), the smallest of the four Channel Islands (q.v.), 6 miles E. of Guernsey and 12 NNW. of Jersey. Only 2 sq. m. in area, it is almost entirely rockbound, and consists of two portions, Great and Little Sark, connected by an isthmus called the Coupée, 456 feet long, 5 to 8 broad, and 384 high. Lead was mined during 1835-45; fishing and agriculture are now almost the only occupations. Pop. (1841) 785; (1891) 571.

Sarmatians (anc. *Sarmate*, *Sauromate*), a race who spoke the same language as the Scythians (q.v.), and who are believed to have been of Median descent and so Iranian in stock, though some authorities think they belonged to the Ural-Altai family. They were nomads, wild and savage in appearance, excellent horsemen and archers, and dressed in leather armour. Their young women went into battle on horseback; hence probably the Greek legends about the Amazons. Several tribes were embraced under the name; they roamed over the wide plains of eastern Europe, from the Vistula and the Danube to the Volga and the Caucasus. Their country was arbitrarily divided by the ancient writers into European and Asiatic Sarmatia, the river Don being made the dividing-line. In the second half of the 4th century B.C. they subjected the Scythians to their yoke. Their empire lasted until the 4th century A.D., when it was overthrown by the Goths. Shortly after that their name disappears from history. The Jazyges (q.v.) were a Sarmatian tribe who also disappeared amongst Goths and Huns. But the name of Sarmatia is sometimes applied to the vast region in which the Sarmatians roamed, and is sometimes rhetorically used for Poland.

Sarnia, a town and port of Canada, just below the issue from Lake Huron of the St Clair River, 170 miles WSW. of Toronto by rail. A great tunnel beneath the St Clair (q.v.) connects it with Port Huron (q.v.) on the American side. Pop. 3847.

Sarno, a city of Southern Italy, 30 miles by rail E. of Naples, on the farther side of Vesuvius, has an ancient castle, a cathedral (1625), a seminary, paper, cotton, linen, and ribbon manufactories, and produces fine silk. Pop. 14,464. Here Teia, king of the Goths, was vanquished and slain in a desperate battle with the Greeks, commanded by Narses, in 552.

Sarpi, PIETRO, better known by his monastic appellation, FRA PAOLO, was born at Venice on 14th August 1552, embraced the monastic life, and took the vows in the religious order of the Servites (q.v.) in 1565. Five years later the Duke of Mantua made him his court theologian; but he was soon after summoned to be professor of philosophy in the Servite monastery at Venice, and there he remained all the rest of his life. For nine years, however (1579-88), he was absent in Rome looking after affairs connected with the reform of the Servite order. In early life his thoughts were

principally given to the study of oriental languages, mathematics, astronomy, and other branches of natural philosophy, including the medical and physiological sciences, in which he attained to great proficiency, being by some writers regarded (although without sufficient grounds) as entitled to at least a share in the discovery of the circulation of the blood. He kept up a correspondence with Galileo, Harvey, Bacon, and W. Gilbert. In the dispute between the republic of Venice and Paul V. (q.v.) on the subject of clerical immunities Sarpi stepped forward as the valiant champion of the republic and of freedom of thought. On the repeal (1607) of the edict of excommunication launched against Venice Sarpi was summoned to Rome to account for his conduct. He refused to obey, and was excommunicated as contumacious; and an attempt was made upon his life by a band of assassins, who professed to be actuated by zeal for the papal cause. Seriously wounded, he after his recovery confined himself within his monastery, and busied himself with writing his celebrated *History of the Council of Trent*, a *History of the Interdict*, and other works. The first named was published in London in 1619 by Antonio de Dominis (q.v.), the ex-bishop of Spalato, at first under the pseudonym of Pietro Soave Polano, an anagram of Paolo Sarpi Veneto; and it almost immediately rose into popularity with the adversaries of Rome as well in England as throughout the Continent. It is by no means a simple history of the proceedings of the council, but rather a controversial narrative of the discussions, in which the writer freely enters into the merits of the doctrines under discussion, and in many cases displays a strong anti-Catholic bias. His judgment of the motives and conduct of the members of the council, especially of the representatives of the pope and his partisans in the assembly, is uniformly hostile. Ranke, who criticises the work in an appendix to his *History of the Popes*, ranks Sarpi, in spite of the partisan spirit of his writing, as the second of Italian historians, next after Machiavelli. A voluminous history of the Council of Trent from the papal standpoint was written by the Jesuit Pallavicino (q.v.). Sarpi died on 15th January 1623. His life as an ecclesiastic was above reproach; and his long-tryed zeal in the cause of the republic had made him the idol of his fellow-citizens, who accordingly honoured him with a public funeral. His *History of the Council of Trent* has been reprinted in numberless editions; his collected works were published at Naples, in 24 vols., in 1789-90.

See Lives by A. G. Campbell (1869), Bianchi-Giovini (Zurich, 1836), and T. A. Trollope's *Paul the Pope and Paul the Friar* (1861), largely based upon the Italian work of Bianchi-Giovini.

Sarracenia. See INSECTIVOROUS PLANTS.

Sarrakhs. See SARAKHS.

Sarreguemines. See SAARGEMÜND.

Sarsaparilla, or SARSAPARILLA. This is the dried root of the *Smilax officinalis*, a plant belonging to the natural order Smilacaceæ, and a native of Central America. In the British Pharmacopœia it is known as *Sarsæ Radix*, or Jamaica Sarsaparilla, being imported from that island, and having first been brought into Europe from the West Indies about 1530. There are, however, several other species of *Smilax* having the same properties, and growing in the warmer parts of America. They are twining shrubs, sometimes attaining a very considerable height, and growing only where there is abundance of water. The root is many feet long, about the thickness of a goose-quill, brownish in colour, with numerous rootlets. They are folded and packed into bundles about 18 inches

long and 4 inches in diameter, bound by a long root. The taste is mucilaginous, slightly bitter and acid; it has no smell. The root contains a crystalline glucoside, *smilacin*, a volatile oil, resin, starch, &c. A decoction, a compound decoction, and a liquid extract made from the root are all official. These preparations act as diuretics and diaphoretics, and are used as alteratives in syphilis, rheumatism, and some skin diseases. Their value is much disputed, and they are not nearly so often prescribed as formerly. The root of *Hemidesmus Indicus* is also official, and is sometimes called Indian Sarsaparilla. The root of *Smilax aspera* is known as Italian Sarsaparilla, while those of various species of *Carex* are known as German Sarsaparilla. The form *Zarsaparella* occurs in Lyte's *Dodoens* (1578), the word being perhaps a compound of the Spanish *zarza* or *zarza*, 'bramble,' and *parilla*, 'a little vine.'

Sarsden Stones, a name given to the Grey-wethers (q.v.) of Cornwall, and erroneously interpreted to mean Saracen stones, as the piles of old mining refuse are called *attal-Sarsen* and Jews' leavings—on the theory that Saracens, Jews, Phœnicians had wrought there; but really a corruption of a Celtic word.

Sarsfield, PATRICK, Irish Jacobite, had fought abroad under Monmouth, and in England at Sedgemoor against him, when in 1688 he was defeated in the skirmish of Wineanton, and crossed over to Ireland; (he was member for Dublin county). Created Earl of Lucan by James II., he drove the English out of Sligo, was present at the battles of the Boyne and Aghrim, defended Limerick (q.v.), and on its final capitulation in 1691 entered the service of France. He fought at Steenkirk (1692), and was mortally wounded at Neerwinden, 19th July 1693.

Sarsnet, or SARACENET, a thin tissue of fine silk, plain or twilled, used for ladies' dresses and for linings. It is said to have been introduced from the Orient in the 13th century. See RIBBON.

Sarthe, a dept. of France, north of the Loire, formed out of the old provinces of Anjou and Maine. Area, 2396 sq. m.; pop. (1866) 465,615; (1891) 429,737. The Sarthe flows south through the department, and the Loir west along the southern border. The department is fairly level, and the soil fertile. Essentially an agricultural department, it produces wheat, oats, barley, and potatoes, sends its geese, chickens, eggs, cattle, and swine to Paris, is famous for its breed of horses, and makes every year nearly 4 million gallons of wine and 15½ million gallons of cider. Coal is mined, and there are manufactures of hemp, linen, and cotton textiles, paper, glass, leather, machinery, &c. The arrondissements are Le Mans, La Flèche, Mamers, and St Calais; capital, Le Mans.

Sarti, GIUSEPPE, musical composer, was born at Faenza on 1st December 1729, and held the office of organist to the cathedral of Faenza from 1748 to 1750. The success of two operas—*Pompeo in Armenia* (1751) and *Il Re Pastore* (1753)—brought him a royal invitation to Copenhagen in 1753; and there he remained until 1775. After his return to Italy he was successively director of the conservatory at Venice (till 1779) and *maestro di capella* of Milan cathedral; in this last post Cherubini was his pupil and assistant. During this period he composed some of his most successful operas, *Le Gelosie Villane* (1775), *Giulio Sabino* (1781), *Le Nozze di Dorina* (1782), and others. In 1784 Catharine II. invited him to St Petersburg. On his way he made the acquaintance of Mozart at Vienna. His most notable productions whilst in Russia were the opera *Arnida* (1786) and a *Te Deum* in celebration of the taking of Otchakoff,

in which real fireworks and cannon were discharged to heighten the realism. Sarti died at Berlin, on his way home to Italy, on 28th July 1802. He composed, in addition to operatic music, several masses, sonatas, and other pieces.

Sarto, ANDREA DEL, a painter of Florence, where he was born in 1487 or 1486. The family name was Vannucchi; and Andrea was nicknamed Del Sarto ('the tailor's son') from his father's occupation. He studied under one or two Florentine painters, and gained greatly by copying from Leonardo da Vinci and Michelangelo. In 1509-14 he was engaged by the Servites in Florence to paint for their church of the Annunciation a series of seven frescoes, of which the first four illustrated the life of St Philip Benizzi, the founder of the order; the two last, depicting the 'Nativity of the Virgin' and 'Journey of the Three Kings,' are esteemed the best in the series. During the next eleven years he painted a second series of frescoes, those illustrating the Life of John the Baptist and intended for the cloisters of the Recollets or Barefooted Friars. But in 1518 he accepted the invitation of Francis I. of France and went to Paris, and was warmly received. In the following year he returned to Italy with a commission from the king to purchase works of art; but Andrea squandered the money entrusted to him, and so dared not return to France. The rest of his life was spent at Florence, where he died of the plague on 22d January 1531. The most celebrated of the single pictures painted by Andrea are the 'Madonna del Sacco,' for the Servites; the 'Last Supper,' for S. Salvi near Florence; the 'Madonna with the Harpies,' now in the Uffizi; the 'Fathers of the Church Disputing,' an altar-piece, likewise in the Uffizi; a Pietà, now at Vienna; a copy of Raphael's portrait of Leo X., which deceived even Giulio Romano into believing it was the original, although he himself had had a hand in that original; and two fine Annunciations, in the Pitti Palace at Florence. Andrea was a rapid worker, had a quick, sure brush, excelled in accurate drawing, and displayed a refined feeling for harmonies of colour, but, though called 'the Faultless,' lacks the elevation and spiritual imagination of the greatest masters.

See Crowe and Cavalcaelle, *Painting in Italy*; and Life by Von Reumont (Leip. 1835), and by Janitschek, in Dohme's *Kunst und Künstler*, part iii.

Sartoris, ADELAIDE. See KEMBLE.

Sarts, a name given to the settled inhabitants, whether agriculturists or traders, as distinguished from the nomad inhabitants of Turkestan, Afghanistan, Persia, and the adjacent regions of Asia. Strictly speaking, the name has no ethnological significance, though it is often used, but incorrectly, to designate the Aryan aborigines of those same regions, properly called Tajiks.

Sarum. See SALISBURY, LITURGY.

Sarzana, a city of Northern Italy, 8 miles by rail E. of Spezia. It has a cathedral (1355-1470), and an ancient fortress (now a prison), and is the birthplace of Pope Nicholas V. Pop. 4016.

Sasin. See ANTELOPES.

Sasine. See INFEBTMENT.

Saskatchewan, a large river of British North America, draws its waters from the Rocky Mountains, and is formed by two head-waters called the South and North Branches. The North Branch rises among the glaciers near Mount Hooker, the South Branch in the very north of Montana. The former has a course of 770, the latter of 810 miles, before they meet at about 105° W. long. and 53° 15' N. lat. The river then flows east 282 miles to Lake Winnipeg, from which its waters are carried

to Hudson Bay by the Nelson River (q.v.). Including the Nelson, its total length is 1514 miles; catchment basin, 450,000 sq. m. It is now navigated by steamers from Lake Winnipeg to Edmonton (700 miles); the Nelson is rendered unnavigable by rapids. The upper Saskatchewan drains a rich prairie country; near Medicine Hat it is sunk almost 300 feet below the general surface.—The river gives name to one of the Western Territories, lying between Manitoba and Keewatin, Assiniboia, Alberta, and the parallel 55° N. lat. Both branches of the river traverse the territory, and on their banks are the settlements of Prince Albert, Battleford, &c. Area, 114,000 sq. m.; pop. (1891) 11,146.

Sassafras (*Sassafras*), a genus of trees or shrubs of the natural order Lauracæ. The Sassafras-tree (*S. officinale*) of North America, found from Canada to Florida, a mere bush in the north,



Sassafras (*Sassafras officinale*):

a, branch of male tree in flower; b, branch with ripe fruit and developed foliage. (Bentley and Trimen.)

but a tree of 50 feet in the south, has deciduous leaves, yellow flowers, which appear before the leaves, and small dark-blue fruit. The wood is soft, light, coarse in fibre, dirty-white and reddish brown, with a strong but agreeable smell, resembling that of fennel, and an aromatic, rather pungent and sweetish taste. The wood of the root possesses these properties in a higher degree than that of the stem, and the thick spongy bark of the root most of all. The wood is brought to market in the form of chips, but the bark of the root is preferred for medicinal use, is a powerful stimulant, sudorific, and diuretic, and is employed in cutaneous diseases, gout, rheumatism, and syphilis, generally in combination with other medicines. It contains a volatile oil, *Oil of Sassafras*, which is often used instead. An agreeable beverage is made in North America by infusion of sassafras bark or sassafras wood; and a similar drink was once commonly sold in the streets of London under the name of *Saloop*. The leaves of sassafras contain so much mucilage that they are used for thickening soup.—Another species of *Sassafras* (*S. parthenoxylon*), possessing similar properties, is found in Sumatra; and the name, with or without explanatory prefixes, is given to trees of various orders found in Victoria, New South Wales, Tasmania, Brazil, and Chili.

SASSAFRAS NUTS, a name given to the cotyle-

dons of the seed of the South American tree *Nectandra puchury*, used as medicinal aromatics. They are also called Pichurim Beans and Brazilian Beans.

Sassanidæ. See PERSIA, Vol. VIII. p. 67.

Sas'sari, a city in the north-west of Sardinia, ranking next after the capital Cagliari, which it has indeed attempted to supplant as the capital; it stands 12 miles by rail from the Gulf of Asinara, where its port, Porto Torres (pop. 2034), is situated, and 162 miles N. by W. of Cagliari. A prosperous-looking town, with both old and new houses, embosomed in orange and olive groves, it has a cathedral (1531), an old castle (1327-31), a university (1677, reopened in 1766) with about 120 students, a museum of Roman antiquities, a natural history collection, and a library (1566) of 25,000 vols., and is the seat of an archbishop and of several of the old Sardinian nobles. There is a busy trade in grain, olive-oil, cheese, and hides. Pop. (1881) 31,596; (1895) 38,000.

Sassoferrato, an Italian painter, whose real name was GIAMBATTISTA SALVI, was born at Sassoferrato in the March of Ancona, 11th July 1605, and worked mainly at Rome, where he died 8th April 1685. He painted Madonnas, Holy Families, an Annunciation, and an Assumption.

Sassoon, or SASSUN, the scene of atrocities perpetrated on the Armenian inhabitants by Kurds and Turks in 1894, is a small town in the mountains of Armenia, 50 miles W. of Bitlis. Sassoon is the name of a munificent Jewish banking house in Bombay, directed by Sir Albert Abdullah Sassoon, born in Bagdad in 1832.

Satan. See the articles DEVIL, HELL.

Sâtârâ, a town of Bombay presidency, India, occupies a high, healthy site on the Deccan plateau, near the Kistna, 56 miles S. of Poona. It is commanded by a hill-fort, which came into the hands of the British in 1848. Pop. 29,028.—The *district* has an area of 4988 sq. m. and a pop. of 1,062,350.

Satellites are small members of the solar system, taking the place of attendants of the larger planets, by which their motions are controlled. In relation to them, the controlling planet is called their 'Primary.' For a discussion of the satellite of the earth the reader is referred to the article MOON. The satellites of *Mars* are interesting as by far the smallest known. One of them, Phobos, revolves round its primary so quickly that its rising and setting are determined chiefly by its own motion. To an observer on *Mars* it will rise in the *west*, and cross the sky in a few hours. Both were discovered in 1877. The first three of Jupiter's satellites are eclipsed at every revolution, the fourth less frequently. Their frequent passages before and behind their primary form one of the most attractive spectacles for small telescopes. Their orbits differ but little from circles, and between the first three a curious relation exists—viz. the mean sidereal motion of the 1st added to twice that of the 3d is equal to three times that of the 2d; so that, except at a vast interval, the three cannot all be eclipsed at once, although *each* is eclipsed once in every period. Long observation and careful calculation have enabled the places of these satellites to be so accurately predicted that their eclipses have been used to determine the velocity of light. Jupiter, owing to the earth's orbital movement, is at one time 183,000,000 miles nearer us than at another. The eclipses of his satellites are therefore delayed or hastened, according to the velocity of light, as the strokes of a hammer at a distance are delayed in reaching us by the finite velocity of sound (see LIGHT, SUN). From this difference

(about 500 seconds) the velocity of light has been calculated. One of the satellites of Saturn, *Titan*, is much the largest of all, approaching in size the smaller planets. The motion of the satellites of Uranus is retrograde. The table sums up what was known prior to the discovery at the Lick Observatory in 1802 of a fifth (very small) satellite of Jupiter, which ranks first (as nearest its primary), probably under 100 miles in diameter.

being somewhat similar in appearance, although they do not appear to be closely allied botanically. One kind is obtained from a moderate-sized deciduous tree (*Chloroxylon swietenia*), growing in Central and South India, including Ceylon. It is allied to the mahogany tree, and as regards appearance the wood might be called a yellow mahogany. In India satinwood is used for house-building and agricultural implements, as well as for furniture purposes; but richly figured pieces of it, especially, are exported to England for cabinet-work. West Indian satinwood is the better of the two kinds — at least it is more commonly used for furniture. It comes chiefly from San Domingo and Porto Rico, but, although the wood has been long used in Europe, its botanical source is not certainly known. It is, however, supposed to be furnished by an Ebenaceous tree. Satinwood, of either kind, is hard, very close-grained, and takes a fine polish. It can be cut into small mouldings better than most woods, but it is of a 'greasy' nature, and does not hold glue well. In colour it is of a subdued yellow passing

Primary	Name of Satellite	Mean Distance from Primary	Sidereal Period			Diameter.	Discoverer.
			d.	h.	m.		
EARTH	Moon	238,833	27	7	43	2160	
	Phobos	5,820	0	7	39	11	Hall.
MARS	Deimos	14,600	1	6	18	9	"
	Io	267,380	1	18	27	2252	Galileo.
JUPITER	Europa	425,160	3	18	14	2099	"
	Ganymede	676,390	7	3	43	3436	"
	Callisto	1,192,820	16	16	32	2929	"
	Mimas	120,800	0	22	37	1000	W. Herschel.
	Enceladus	155,000	1	8	51	?	"
SATURN	Tethys	191,000	1	21	18	500	Cassini.
	Dione	246,000	2	17	41	500	"
	Rhea	343,000	4	12	25	1200	"
	Titan	798,000	15	22	41	3300	Huygens.
	Hyperion	1,007,000	21	7	8	?	Bond & Lassell.
	Iapetus	2,314,000	79	7	65	1800	Cassini.
	Ariel	123,000	2	12	28		Lassell.
URANUS	Umbriel	171,000	4	3	27		"
	Titania	281,000	8	16	55		W. Herschel.
	Oberon	276,000	13	11	6		"
NEPTUNE		220,000	5	21	8	?	Lassell.

Sati. See SUTTEE.

Satin, a fabric in which so much of the weft is brought uppermost in the weaving as to give a more lustrous and unbroken surface to the cloth than is seen when the warp and weft cross each other more frequently; this will be better understood by reference to the figure than by any verbal description. A are the warp threads, of which only every tenth one is raised to allow the shuttle to pass, but they are all raised in regular succession, so that the weaving is quite uniform throughout; B are the weft threads; and C is the selvedge, which is formed on each side of the piece of stuff

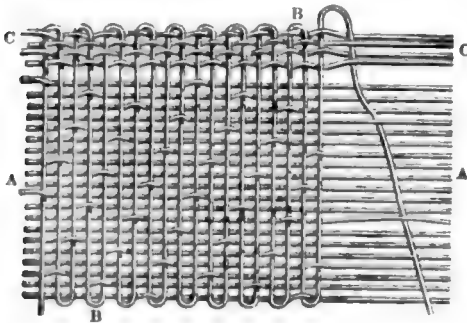

by the regular method of plain weaving—that is, by raising every other warp thread for the passage of the weft. The figure shows a ten-thread satin twill, but there are various others made, such as a five, a six, a seven, and an eight-thread satin. The lowest satin twill that can be produced is a four-thread, which is sometimes called the satinnet twill. The term satin is rarely applied to other than silk textiles (see SILK). A cotton, and sometimes even a woollen, fabric woven in the way described is called sateen.

Satin-bird. See BOWER-BIRD.

Satin Spar. See ARAGONITE, GYPSUM.

Satinwood. This is perhaps the most valuable of the light-coloured furniture woods. Two kinds of satinwood are known in commerce, both

into brown, and much of it has a rich satiny or feathery figure which is very beautiful. It has been much used in costly furniture, but not so extensively in recent years. The cabins of passenger steamers are often panelled with satinwood, which is also a good deal employed for small ornamental articles.

Satire, one of the capital divisions of literature, is in its essence criticism of man and his works, whom it holds up either to ridicule or to scorn. One of the greatest masters in the art (Dryden) describes it as—

The boldest way, if not the best,
To tell men freely of their foulest faults,
To laugh at their vain deeds and vainer thoughts.

The chief instruments of the satirist's equipment are irony, sarcasm, invective, wit, and humour, this last generally in its lower or inferior grades. The satiric denunciation of a writer burning with indignation at some social wrong or abuse is capable of reaching to the very highest level of literature. The writings of a satirist of this type, and to some extent of every satirist who touches on the social aspects of life, present a picture, more or less vivid, though not of course complete or impartial, of the age to which he belongs—of the men, their manners, fashions, tastes, and prevalent opinions; thus they have a historical as well as a literary and an ethical (or philosophical) value. All types of satirist, except the philosophical and the social, tend to be personal in their criticism. Their invective too often slips into scurrilous abuse, or verbal insolence and the calling of opprobrious names; and their ridicule is either light badinage, or playful irony, or sarcastic mockery, or caricature, or rollicking fun, or jeering laughter. How powerful an instrument satire is for influencing men's actions, especially in the sphere of politics, has been abundantly manifested from the day when Elijah taunted the prophets of Baal on Mount Carmel to the latest cartoon of *Punch* or *Kladderadatsch* or *Puck*. Satiric writers have made use of many different forms of literature: Dryden and Pope, for instance, adopted the mock-heroic epic, Ulrich von Hutten chose epistles, Langland (*Piers Plowman*) and Quevedo imaginary visions, Cervantes and Swift

the mock romance, *Marnix* and the writers of *Reynard the Fox* the beast-fable, Voltaire fictitious travels, Molière and Gay plays, John Barclay the allegory, James and Horace Smith the parody. Pictorial illustration was turned to splendid purpose as a satiric weapon by Hogarth, and by the caricaturists (Rowlandson, Gilray) and cartoonists of more modern times; and medals even have been put to satiric purposes.

Ancient Greece, though she never produced a school of satire, had in Aristophanes and others men of the highest satiric genius. Archilochus (720-680 B.C.) is the first we read of as having used the iambic metre for the purposes of satire. He wrote with such effect that certain of his victims are said to have gone and hanged themselves. Simonides of Amorgus and Hipponax of Ephesus intervene between Archilochus and Aristophanes. The last named is the most brilliant representative of the Athenian Old Comedy, the writers of which, bold and outspoken, constituted themselves censors of public morality and critics of current events. Satire as a special branch of literature was the creation, the only original literary creation, of the practical-minded Romans. It grew out of the rude dramatic medleys (*saturæ*) with which, in primitive republican times, the citizens were wont to be diverted on the occasion of large festive gatherings. The father of poetical satire was Lucilius, who criticised boldly and freely, equally without moral indignation and without any desire to provoke laughter. It is, however, Horace and Juvenal whose names are principally associated with Roman satire. Both expended their chief efforts upon social topics; but whilst the former uses satire as a medium for recording his personal tastes and distastes, and enlarging on his own experience, and writes with the easy good-nature of a thorough man of the world, Juvenal dwells upon the tragic and sombre aspects of the society of his time (the age of Domitian and Trajan), and denounces them with the scornful indignation of the moralist. Horace is the model, the archetype of 'classic satire,' the form that was imitated or adapted by the French satirists of the school of Boileau and by their English successors. For grim intensity of scorn and sustained power of invective Juvenal's work has never been equalled; indeed the only man who can at all be put on the same level with him is Dean Swift. The Greek Lucian, and the Romans Persius, Petronius, Martial, and Apuleius, all wrote satire, but in different forms; and some of the strongest satire ever written stands in the grave pages of the historian Tacitus.

During the long night of the dark ages satire, like most other branches of good literature, was almost entirely neglected. It began to revive in the 10th century: certain of the early versions of *Reynard the Fox* (e.g. *Reinardus Vulpes* and *Reinaert Vos*) are thinly disguised satires on the clergy. This class continued a favourite butt until past the Reformation; they were attacked, for instance, by the *goliards*, wandering scholars with a turn for witty buffoonery, who jotted down their effusions in doggerel Latin verse. Walter Mapes, whose name is connected with the preservation of the Grail legends, wrote (12th century) vigorous Latin verses in the same strain.

The first notable name in the annals of English satire is that of William Langland, who in *Piers Plowman* inveighs against the clergy and mendicant orders, the law-courts, and abuses generally. Skelton, who railed at Wolsey, and at the clergy, was perhaps the wildest and most reckless of English satirists. Thomas Nash, one of the most able opponents of the Martin Marprelate writers, puts a good deal of strong vituperation

into his *Anatomic of Absurdity* (1589). The invectives of Gosson and Stubbes are not satire, for they are hardly literature. In the same century Scotland had two satirists of rare quality, one in Sir David Lyndsay, whose *Satyre of the Thrie Estaitis*, written in the vernacular, helped to pave the way for the Reformation, and the other in George Buchanan, the ripest scholar of his country, who made the Franciscans smart under his cutting irony. Bishop Joseph Hall and John Donne are chiefly notable as the forerunners of Dryden and Pope, both writing classic satire in the heroic verse measure. Then came John Barclay, the author of the clever political allegory *Argenis* (1621); Andrew Marvell, who was very skilful in the use of banter, with which he assailed the private and social corruptions of the reign of the second Charles; Oldham (1653-83), an imitator of Horace and Juvenal, and a writer who in spite of much extravagance had something of the gift of true satiric wrath, which he expended upon the Jesuits; and Congreve, the master of witty repartee, who went in for light lampooning, and in *The Double-dealer* and other pieces ridiculed the fashionables of the Restoration. But the reputations of all these is eclipsed by Samuel Butler, the writer of *Hudibras*, a burlesque character-sketch, in doggerel rhymes, of the Puritan anti-royalist. He was seconded, though at a long distance, by the royalist Cleveland, who enjoyed great popularity in his day for his satires on Cromwell and the Scotch. The greatest English writer in the field of classic satire was John Dryden; a manly, large-hearted man, a stranger to meanness and spite, he spoke out boldly and dealt downright stunning blows, pouring the most unsparring ridicule upon Shaftesbury, the supporters of Monmouth, the literary satellites of the Whigs, and the poet Shadwell. Amongst others who had to repent for having provoked 'Glorious John' were the Duke of Buckingham, author of the *Rehearsal*, and Tom Brown 'of facetious memory.' The reign of Anne is, however, the golden age of English satire, its brightest ornaments being Swift, Pope, and Addison. The first named is both philosophical and personal in his treatment, and writes with marvellous force of invective and savage scorn. Pope, as a man almost the direct opposite of the masculine Swift, had a wholly inimitable way of putting things, with the finest point and precision, elegance and ease, and the keenest wit. His satire is by preference personal, strongly spiced with malice, and feminine spite, and elfish fun. Next to these two comes Addison, whose subtle irony and exquisite literary touch and admirable character-sketching are familiar to all readers of good English. Gay, the friend of satirists, had literary partnerships with Swift, Pope, and Arbuthnot, and won enormous success with *The Beggars' Opera*, a hit at the social vices of the day. Dr Arbuthnot, the chief if not sole author of *Martinus Scriblerus*, in which he gibbeted the pedantic follies of antiquaries and metaphysicians, is best known for his *History of John Bull*, an amusing attack on Marlborough and the war policy of the Whigs. Dr Johnson too tried his hand at satire, and wrote *London* and *The Vanity of Human Wishes* in free imitation of Juvenal. Young of the *Night Thoughts* wrote on *The Universal Passion* (i.e. love of fame), but without much point. Charles Churchill is the most important satirist between Pope and Byron. A literary swashbuckler, he assailed with plenty of Drydenic vigour the actors, critics, and opponents of Wilkes (of whom he was a rabid partisan), as well as Dr Johnson, Warburton, and other individuals. Sir C. Hanbury Williams, one of Walpole's men, was accounted by his admirers a

master of the light political squib in gay and easy verse. But he is altogether overshadowed by 'Junius,' whose polished sarcasm, cutting invective, and dignity of style elevated the political pamphlet to the level of permanent literature. Wolcot (Peter Pindar), a sort of street buffoon in letters, a man with more rollicking wit and impudence than real malice, poked rare fun at the oddities of George III., at Sir Joseph Banks, the French philosophers, &c. Gifford, the founder of the *Quarterly*, was a translator of Juvenal and author of some vigorous but ill-bred invective; thus, Peter Pindar, who had assailed him personally, is styled a 'dotard,' 'reptile,' and 'brutal sot.' Cowper denounced in old-fashioned satire the extravagances of a society he knew at second hand only. A much greater name than any of these in the annals of satire is that of Burns, who hated as he loved, well and ardently; uniting reckless glee with fine irony and boisterous fun with keen wit, he hit out boldly at hypocrisy and pride of birth, as well as at individuals. Byron turned his ready command of easy verse and fluent sarcasm, and his keen appreciation of an opponent's weak places, to admirable account in his celebrated rejoinder to the Scotch critics, and in his attack upon the Lake poets (*Vision of Judgment*). But his satiric masterpiece is of course *Don Juan*. Tom Moore's political squibs in verse are full of sparkle, waggyery, and airy fancy. Political warfare indeed has always been very prolific of satirical effusions, especially in England: *The Rolliad* (1784-85) and *The Anti-Jacobin* (1797-98) series may be instanced. Theodore Hook wrote in *John Bull* satires, vigorous, scurrilous, but funny, upon the Whigs and lampoons upon Queen Caroline. James and Horace Smith in *The Rejected Addresses* raised parody to perhaps its highest level. A more or less distinctive vein of satire occurs in the writings of Douglas Jerrold, Leigh Hunt, and Landor. Thackeray has said some very fine things about quacks and fools, snobs and toadies, and has many exquisite touches of satire scattered through his novels. He is also distinguished as the author of some of the finest burlesques in English. Carlyle employed the resources of his powerful genius—thundering invective, grand rhetoric, indignant scorn, grim humour, satiric gloom—in denouncing the shams of human society and human nature; and admirable social satire, in prose or verse, in article, in novel or in poem, has been written by Sydney Smith, Hood, Dickens, Disraeli, Browning, George Meredith, Lytton, Tennyson, and Swinburne.

On the other side of the Atlantic satire has been cultivated by Washington Irving (*Knickerbocker*), Paulding, Lowell (*Biglow Papers*), Holmes, Artemus Ward, Charles Dudley Warner, and others. Some of the best American satire—not always the best known—is remarkable alike for its delicacy and its effectiveness, and takes rank not unworthily with that of other countries.

Many of the best French *Fabliaux* (12th and 13th centuries) are essentially social satires, and of these not a few are of high literary quality; Jean de Meung (13th century) was a true satirist; the first in France to write satires on the classic model was J. Vauquelin de la Fresnaye, in the 16th century. The Huguenot D'Aubigné made a bold, impetuous onslaught upon the Roman Catholic ecclesiastics; nor did he spare Henry of Navarre. His greater contemporary Regnier, a writer of pungent but polished verse, confined himself to general satire of poets, pedantic dryasdusts, hypocrites, and the types of which French satire has always been so fond. Rabelais, to lash the abuses of monkery, had long before written one of the greatest masterpieces of the world's literature. Pierre Pithou had a hand in the *Satire Ménippée*,

which cast so much discredit upon the chiefs of the League. But the real exponent of classic satire in France was Boileau, who set the example to Dryden, Pope, and the English school. But few among the countless *mazarinades* attained the dignity of permanent literature. La Bruyère wrote, by the way, exquisite social satire, influenced by Theophrastus; Molière, besides his other gifts, stands among the greatest satirists of the world; the *Histoire Amoureuse des Gaules* of Bussy-Rabutin and the *Historiettes* of Tallemant des Réaux supply a form of malicious personal satire, hardly found out of French literature. There is ample store of fine satire alike in the fiery wrath of Saint Simon's *Mémoires* and the sprightly malice of Madame de Sévigné's letters. Pascal's onslaught upon the Jesuits is a piece of work that for polished irony and literary grace, as well as for effect, still stands unrivalled. Théophile de Viaud, Motin, and Berthelot all wrote satirical books. Voltaire is the next great satirist of France; a downright scoffer, a master of mocking irony and stinging sarcasm, he penned personal lampoons with the same gusto with which he sneered at religion and the politics of the day. Contemporary with him were M. J. Chénier, and Piron. Béranger turned the *chanson* or song into a powerful weapon of political warfare; Courier too wrote political satires.

Ulrich von Hutten, though he wrote chiefly in Latin, is the first great German satirist. He made fiery and fierce attacks upon papal rule. His name recalls that of his greater contemporary Erasmus, who, besides satirising the superstition and ignorance of the ecclesiastics, found ample opportunity in numerous personal quarrels for the effective use of a biting sarcasm. Sebastian Brant's *Narrenschiff* ridicules certain typical classes of men. Murner and Fischart followed in the footsteps of Hutten. Gryphius and Moscherosch deal with characters of the Thirty Years' War. Rabener, Liscow, and Kästner wrote general satire. Wieland ridiculed popular credulity and litigiousness. The true successors of Hutten are Jean Paul and Lichtenberg. The former indulges in general social satire, and steeps all he says in a golden bath of the rarest humour; Lichtenberg is much more bitter and severe. Goethe and Schiller both wrote satire—e.g. in the *Xenien*, a collection of verses on their literary contemporaries. Goethe also had a bit at Wieland, and Schiller at tyrannical rulers. Tieck, Hauff, and Hamerling all deserve mention here; and especially so does Heine, first because of the mocking spirit he breathed upon nearly everything he touched, and second because of his *Atta Troll*, a burlesque sketch of his countrymen.

The satirists of the remaining countries of Europe must be very briefly enumerated. Spain has two men of the highest rank in Cervantes and Quevedo. Holland boasts of Marnix (St Aldegonde) and Anna Bijns, who took opposite sides in the Reformation quarrel; and it produced much fair satire through the literary guilds. Italy's principal satirists are Dante, Ariosto, Salvatore Rosa, the writers of macaronic verse, Alfieri, and Carlo and Gasparo Gozzi. In Scandinavian literatures we have the nothing verses of the ancient Norwegians, and in more recent times admirable satire by Wessel, Holberg, Paludan-Müller, Ibsen, Kjelland, and Strindberg. The corruptions of the officers of government in Russia have been mercilessly exposed by Gogol and Schtchedrin (Soltykoff).

See the articles under the several writers' names in this work: the standard histories of literature mentioned under the respective countries; such articles as BURLESQUE, CARICATURE, FABLIAUX, and PARODY; and more especially HANNAY, *Satire and Satirists* (1864); and 'English Political Satires,' in *Quar. Rev.* (1857).

Satisfaction. See ATONEMENT.

Satrap was the governor of a province in the ancient Persian monarchy. Their duties and position were clearly defined by Darius I. in the 6th century B.C., although there had been satraps before his day. They enjoyed the right to command the royal army in the province (though not the troops in the fortresses), to levy mercenaries, and to coin money. Alexander in the 4th century greatly curtailed their power. When the Persian monarchy began to decline some of the satraps founded independent kingdoms, the most famous being that of Pontus.

Satsuma. See JAPAN, Vol. VI. p. 284; POTTERTY, Vol. VIII. p. 368.

Saturn, an ancient Italian divinity, who presided over agriculture. His name, from the same root as *satum* (*sero*, 'I sow'), indicates what was probably one of the earliest personifications in the Italian religion Saturn being the god who blessed the labours of the sower. His identification with the Greek Kronos by the later Grecising myth-mongers was a peculiarly infelicitous blunder, the two having absolutely nothing in common except their antiquity. The Greek *Demeter* (Ceres) approaches far more closely to the Italian conception of the character of Saturn. The process of amalgamation in the case of Kronos and Saturn is visible enough. First, there is the Greek myth. Kronos, son of Uranos ('Heaven') and Gæa ('Earth'), is there the youngest of the Titans. He married Rhea, by whom he had several children, all of whom he devoured at birth except the last, Zeus (Jupiter), whom his mother saved by a stratagem. The motive of Kronos was his hope of frustrating a prophecy which declared that his children would one day deprive him of his sovereignty, as he himself had done in the case of his father Uranos; but fate is stronger even than the gods, and when Zeus had grown up he began a ten years' war against Kronos and the Titans, which ended in the complete discomfiture of the latter, who were hurled down to Tartarus, and there imprisoned. So ran the common myth. But other myths added that after his banishment from heaven Kronos fled to Italy, where he was received hospitably by Janus, who shared his sovereignty with him. At this point the Greek myth coalesced with the Italian. Saturn, the old homely deity of the Latin husbandmen, was transformed into a divine king, who ruled the happy aborigines of the Italian peninsula with paternal mildness and beneficence, taught them agriculture and the usages of a simple and innocent civilisation. Hence the whole land received from him the name of *Saturnia*, or 'land of plenty,' and his reign was that 'golden age' of which later poets sang as the ideal of earthly happiness. At the foot of the Capitoline, where the fugitive god had formed his first settlement, there stood in historical times a temple dedicated to his worship. Ancient artists represented him as an old man, with long, straight hair, the back of his head covered, his feet swathed in woollen ribbons, a pruning-knife or sickle-shaped harp in his hand. Other attributes are of later invention. For the planet Saturn, see PLANETS.

The SATURNALIA was most probably an ancient Italian rural festival of the old Italian husbandmen, commemorative of the ingathering of the harvest, and therefore of immemorial antiquity. Its characteristic cessation from toil and its self-abandoning mirth were expressive of the labouring man's delight that the work of the year was over, and not of an artificial enthusiasm for a 'golden age' that never had been. During the festival the distinctions of rank disappeared or were reversed. Slaves were permitted to wear the *pileus*, usually

the mark of freedom, and sat down to banquets in their master's clothes, while the latter waited on them at table. Crowds of people filled the streets, and roamed about the city in a peculiar dress, shouting '*Io Saturnalia!*' sacrifices were offered with uncovered head; friends sent presents to each other; all business was suspended; the law-courts were closed; schoolboys got a holiday; and no war could be begun. During the Republic the Saturnalia proper occupied only one day—the 19th of December (xiv. Kal. Jan.). The reformation of the calendar by Julius Cæsar caused the festival to fall on the 17th (xvi. Kal. Jan.), a change which produced much confusion, in consequence of which the Emperor Augustus ordained that the Saturnalia should embrace the whole three days 17th, 18th, and 19th of December. Subsequently the number was extended to five, and even seven; but even in the times before the Empire it would appear that the amusements often lasted for several days. But while the whole week was regarded in a general sense as devoted to the Saturnalia, three distinct festivals were really celebrated—the Saturnalia proper; the *Opalia*, in honour of *Ops*, the wife of Saturn, and the goddess of field-labour (from *opus*, 'a work'); and the *Sigillaria*, in which *sigilla*, or little earthenware figures, were exposed for sale, and purchased as children's toys. The modern Italian carnival would seem to be only the old pagan Saturnalia baptised into Christianity.

Saturnian Verse, the name given by the Romans to that species of verse in which their oldest national poetry was composed. In the usage of the later poets and grammarians the phrase has two different significations. It is applied in a general way to denote the rude and unfluxed measures of the ancient Latin ballad and song, and perhaps derived its name from being originally employed by the Latin husbandmen in their harvest-songs in honour of the god Saturn (q.v.). It is also applied to the measure used by Nævius, and a common opinion, sanctioned by Bentley, is that it was a Greek metre introduced by him into Italy. But most scholars now maintain that the measure of Nævius is of Italian (Hermann even thinks of Etruscan) origin, and that it merely improved on the primitive Saturnian verse. According to Hermann, the basis of the verse is contained in the following *schema*:

— — — — — | — — — — —

which, as Macaulay points out, corresponds exactly to the nursery rhyme,

The queen was in her párlour | éating bréad and hóny,

and is frequently found in the Spanish poem of the *Cid*, the *Nibelungenlied*, and almost all specimens of early poetry; but in the treatment of it a wide and arbitrary freedom was taken by the old Roman poets, as is proved by the extant fragments of Nævius, Livius Andronicus, Ennius, and the old inscriptionary tables in the Capitol.

Satyriasis is a phase of insanity in man of which the characteristic is ungovernable sensuality. The term has also sometimes been applied to Leprosy (q.v.), on account of the disfigurement of the face to which it leads. See SATYRS.

Satyrs, in Greek Mythology, were a race of woodland deities, half human, half animal in their attributes. They are generally described as roaming the hills in the train of Dionysus (Bacchus). In appearance they were at once grotesque and repulsive, like all old woodland demons. They are described as robust in frame, with broad snub noses, large pointed ears like those of animals (whence they are sometimes called *theres*, 'wild beasts'), bristly and shaggy hair, rough skin, little

horny knobs on their foreheads, and small tails. The satyrs are of course sensual in their inclinations, and ravishers of the woodland nymphs, fond of music, dancing, wine, and of the deep slumbers that follow a debauch. To men they were mostly inimical. The Roman poets identified them with the *Fauni* of their own mythology, and gave them larger horns and those goats' feet with which they are so often represented (see FAUNS). Ancient sculpture was fond of the Satyr as a subject; the older satyrs were called *Sileni*, and were represented as already described; the younger had a handsomer and more pleasing exterior—e.g. Praxiteles' famous Satyr at Athens.

Sauces. See DIET, Vol. III. p. 809.

Sauchleburn. See JAMES III.

Sauerkraut, a preparation of the common white cabbage, in extensive use in Germany and the north of Europe. The cabbages are gathered when they have formed firm white hearts, are sliced or cut fine, and then placed in a succession of thin layers in a cask, each layer being sprinkled with fine salt, to which some add juniper-berries, cumin-seed, caraway-seeds, or other condiment. A board is placed on the top, with a heavy weight, so as to press the whole down firmly, but gently; and ere long fermentation takes place. Sauerkraut is generally eaten boiled, in the same way as fresh cabbage, but is sometimes sweetened. Sauerkraut is also made of red cabbage.

Saugor. See SAGAR.

Saul, the first king of Israel, was the son of Kish, a wealthy chief of the tribe of Benjamin. The circumstances that marked his election to the royal dignity are familiar to all readers of Scripture. Gigantic in stature, noble in mien, and imperious in character, he was admirably fitted to accomplish the task of consolidating the tribes of Israel. His earlier achievements augured hopefully for his future. The deliverance of the men of Jabesh Gilead, above all his victories over the Philistines, Ammonites, and Amalekites, were unmistakable proofs of his military capacity; but gradually there showed itself in the nature of the man a wild perversity—an evil spirit of God' it is called—which found vent, along with other forms, in a mad jealousy of David, his son-in-law and the chief of his bodyguard, and culminated in paroxysms of insane rage, which led him to attempt David's life with his own hand, and to commit such frightful deeds as the massacre of the priests of Nob. Saul had, however, apparently the strong opposition of the priestly class to contend against, for at length Samuel retired from court, and secretly anointed David as king; see the article SAMUEL. Saul fell in a disastrous and bloody battle with the Philistines on Mount Gilboa. The Afghans claim to be descended from Saul.

Saulcy, FÉLICIEN CAIGNART DE, numismatist, was born at Lille, 19th March 1807, became an artillery officer, and after lecturing for a few terms on mechanics, was made keeper of the artillery museum in Paris in 1842. A member of the Academy and a senator, he travelled in Iceland and Greenland, and subsequently in Syria and Palestine. Besides innumerable works on numismatics (Roman, Greek, Carthaginian, French, &c.) he wrote a description of the Dead Sea in which there were many discoveries noted (1852-54), a *Voyage en Terre Sainte* (1865), the illustrated Jerusalem (1881), and books on Julius Cæsar in Gaul and on Jewish history. He died at Paris, 4th November 1880.

Sault Ste Marie (pron. *Soo*), a port of Ontario, on the St Mary River, near the outlet of Lake Superior, 622 miles by rail W. of Montreal. A

canal avoids the obstruction caused by the rapids (*sault*), and nearly three times as many boats pass as through the Suez Canal (annual tonnage, 8,500,000 tons). A fine iron bridge connects the C. P. Railway with lines to Duluth, St Paul, &c., U. S. A. Here are Indian schools for boys and girls. Pop. 1000.

Saumarez, JAMES, BARON DE, English naval commander, was born at St Peter-Port, in Guernsey, on 11th March 1757. He entered the navy as midshipman at the age of thirteen, and served in the American war (1774-82), for his gallantry at the attack of Charleston (1775) being promoted to lieutenant. He did good service in the action against a Dutch convoy fleet off the Dogger Bank (August 1781), and was made commander, being soon afterwards placed under the orders of Admiral Kempenfeldt on the Jamaica station. In the great fight between Rodney and De Grasse (12th April 1782) Saumarez commanded the *Russell*, a line-of-battle ship, and gained much distinction by his coolness and intrepidity. For his gallant capture on 20th October 1793 of the French frigate *La Réunion*, with one inferior in size and equipment, he received the honour of knighthood; and in command of the *Orion* he served under Lord Bridport at the battle of L'Orient, June 23, 1795. He also took a prominent part in the battle off Cape St Vincent (February 14, 1797), and was second in command at the battle of the Nile, in which he was severely wounded. In 1801 he was created a baronet and vice-admiral, and in the same year fought his greatest action, off Cadiz (July 12), defeating a French-Spanish fleet of fourteen ships with a squadron of only six, causing to the enemy a loss of 3000 men and three ships. This contest, than which, according to Nelson, 'a greater was never fought,' gained for Saumarez the Order of the Bath, the freedom of the city of London, and the thanks of parliament. In the war that broke out between Sweden and Russia in 1809 he commanded the English Baltic fleet that was sent to the assistance of the Swedes. In 1814 he was promoted to the rank of admiral, to that of vice-admiral of Great Britain in 1821, was created a peer in 1831, and died in Guernsey, 9th October 1836. See Sir John Ross, *Memoirs of Admiral Lord de Saumarez* (2 vols. 1838).

Saumur, a town of France, dept. Maine-et-Loire, on the left bank of the Loire and on an island in it, 38 miles by rail W. by S. of Tours. The most prominent buildings are an old castle (now arsenal and powder magazine), the 16th-century town-house, some interesting churches, and private houses of good French architecture. There are a town museum and a cavalry school with some 400 pupils. Rosaries and articles in enamel are manufactured. Pop. 14,867. Saumur was a stronghold of the Protestants during the reign of Henry IV., at which time it contained 25,000 inhabitants. Its prosperity was annihilated by the revocation of the Edict of Nantes, and its population reduced to a fourth. From 1598 till 1685 it was the seat of a famous school of Protestant theology, the most conspicuous professors being John Cameron of Glasgow (1577-1625) and his pupils Amyraut (or Amyraldus, 1596-1664) and Cappel (1585-1658). The school was noted for its freedom in biblical criticism and its less rigid doctrine of the divine decrees; it was even denounced by the opposing school of Sedan as heretical for teaching a hypothetical universalism—the view that God had not by arbitrary decree excluded any from being saved by the death of Christ. Saumur was brilliantly captured by Larochejaquelein and the Vendéans in the summer of 1793. The largest dolmen in France is $1\frac{1}{2}$ mile south of the town; and prehistoric caves line the river close by.

Saunders, NICHOLAS, polemical writer, was born in 1527 of a good old Surrey family at Charlwood Place near Reigate, and from Winchester passed to New College, Oxford, being admitted scholar in 1546, and fellow in 1548. Regius professor of Common Law (1558), in 1561 he resigned his fellowship and quitted England, at Rome was created D.D. and ordained priest, and thereafter accompanied Cardinal Hosius to the Council of Trent, 'where he showed himself to be a man of great parts by his several disputations and arguments.' He had lived at Louvain for some thirteen years as professor of Theology, and had paid two visits to Spain (1573-77), when in 1579 he landed in Ireland; and here in 1580, 1582, or 1583 (all three dates are given) he 'died,' says Lord Burghley, 'wandering in the mountaines, and raving in a phrensy.' Saunders, who is to Protestants what Foxe is to Catholics, was the author of fourteen works (1565-1610), of which the best known are *De Visibili Monarchia Ecclesie* (1571) and *De Origine ac Progressu Schismatis Anglicani*, edited and completed by Edward Rishton (Cologne, 1585). See the translation of the latter by D. Lewis (1877).

Saunderson, NICHOLAS, the blind mathematician, was born at Thurlstone in Yorkshire in January 1682. He lost his eyesight from smallpox at the age of twelve months, but received a good education in both classics and mathematics. In 1707 he proceeded to Cambridge, and there delivered a series of lectures on the Newtonian philosophy, including Newton's theory of optics. Four years afterwards he was appointed to succeed Whiston as Lucasian professor of Mathematics. He was on friendly terms with Newton, Demoivre, Halley, and other eminent mathematicians amongst his contemporaries. He died 19th April 1739. A Life is prefixed to his *Elements of Algebra* (2 vols. 1740); another treatise by him on *Fluxions*, including a discussion of the principal propositions in Newton's *Principia*, appeared in 1756. It is said that, in spite of his blindness, he understood the rules of perspective, the projections of the sphere, and some of the more recondite propositions of solid geometry.

Sauria, in the system of Cuvier an order of reptiles, including what are now distinguished as separate orders—the lizards (*Lacertilia*) and the crocodilians (*Crocodylia*). Saurian is often used as a very general title for extinct reptiles, and Huxley applied the term Sauroid to birds and reptiles which he included under the technical title Saur-opsida. See REPTILES.

Saurin, JACQUES, a celebrated French Protestant preacher, was born at Nîmes, 6th January 1677, studied at Geneva, and was chosen minister of a Walloon church in London in 1701. But the climate of England did not agree with his delicate health; and in 1705 he settled at the Hague, where his extraordinary gift of pulpit oratory was prodigiously admired. But at length his clerical brethren enviously assailed him with the accusation of heresy. The dispute was carried to the synod of the Hague, and Saurin was subjected to a series of petty persecutions that shortened his days. He died at the Hague on December 30, 1730. As a preacher he has often been compared with Bossuet, whom he rivals in force, if not in grace and subtlety. His chief productions are *Sermons* (12 vols. the Hague, 1749; abridged Eng. trans. 6 vols. 1775-76); *Discours sur les Evénements les plus Memorables du V. et du N. T.* (Amst. 1720-28), often called Saurin's Bible; and *Etat du Christianisme en France* (the Hague, 1725).

Saury Pike (*Scomberesox saurus*), a species of fish of the family Scomberesocidae, having the

body greatly elongated, and covered with minute scales; the head also much elongated, and the jaws produced into a long sharp beak, as in the Garfish (q.v.); from which, however, the present species differs in the division of the dorsal and anal fins into finlets, as in mackerels. The Scomberesocidae are usually placed among the Physostomi, although the air-bladder has no opening. They resemble the Physostomi in the abdominal position of the



Saury Pike (*Scomberesox saurus*).

pelvic fins. The saury pike is about 15 inches long, the back dark blue, the under parts white; the fins dusky-brown. It approaches the coast in summer and autumn and enters friths in shoals, which are pursued by larger fishes, porpoises, &c.; and in order to escape from these it often leaps out of the water, or rushes along the surface, for a distance of one hundred feet, scarcely dipping or seeming to touch the water. Hence the name Skipper, which it very commonly receives on the British coasts. Vast shoals sometimes enter bays, so that they may be taken by pailfuls, and great numbers are sometimes found among the sludge at the ebbing of the tide in the upper parts of the Firth of Forth and elsewhere. It is not uncommon on the east and west coasts of England, but most abundant on the south coast, where it is often taken in pilchard nets. The eggs are furnished with long filaments, like those of other species of the family, by which they are entangled in clusters and attached to solid objects. As food the saury pike is said to be palatable, but it is not commonly sent to the market.

Sausage-poison. It is well known that sausages made or kept under certain unknown conditions are occasionally highly poisonous; and in Germany, where sausages form a staple article of diet, fatal cases of sausage-poisoning are by no means rare. The symptoms are slow in appearing, three or four days sometimes elapsing before they manifest themselves. They resemble those of poisoning by Atropia or Belladonna (q.v.), and are believed to be due to the presence of animal alkaloids or Ptomaines (q.v.) developed by putrefaction. Cases observed in Britain differ from those commonly occurring in Germany in this respect, that in England the sausages are usually comparatively fresh, while the sausages which have proved poisonous in Germany had always been made a long time.

Saussure, HORACE BÉNÉDICT DE, a Swiss physicist and geologist, was born at Conches, near Geneva, 17th February 1740. He early showed an interest in the study of nature, his inclination being quickened by his uncle Bonnet, the naturalist, and his friend Haller, the physicist. In 1762 he obtained the chair of Physics and Philosophy in the university of Geneva. In 1768 he commenced a series of journeys which were fraught with important consequences to science; he visited the Jura and Vosges Mountains, Germany, England, Italy, Switzerland, Sicily and the adjacent isles, the extinct craters of Auvergne, and traversed the Alps in nearly all directions. He was the first 'traveller' (a party of guides were actually the first) who ever ascended

to the summit of Mont Blanc, in 1787. During this course of travel he made numerous observations on the minerals, physical features, botany, and meteorology of the districts he visited; and these were put together in the work *Voyages dans les Alpes*, &c. (4 vols. Geneva, 1779-96). His observations were made with considerable labour; he had in many cases to perfect or even invent the instruments he used. In 1786 he resigned his chair, and, after a long period of suffering, died at Geneva, 22d January 1799. He always took a deep and active interest in the public affairs of his native canton. Besides the great work above mentioned, and some minor productions, he wrote *Sur l'Hygrométrie* (1783), which, according to Cuvier, is one of the most important contributions to science in the 18th century. His *Life* was written by Senebier (1801), by Cuvier in *Biographie Universelle*, and by De Candolle in *Phil. Magazine*, t. 4. See also Douglas Freshfield, *De Saussure and the Alps*, in 'Great Explorers' (1892).—His son NICOLAS THÉODORE (1767-1845) lived a very retired life, but wrote a valuable work on the physiology of plants, entitled *Recherches Chimiques sur la Végétation* (Paris, 1804).

Saussurite (named after Saussure), a dull, opaque, white, gray, or greenish compact mineral, of indeterminate or variable composition, which has resulted from the alteration of felspar, as in the rock called Gabbro (q.v.). Examined microscopically saussurite is seen to consist of a compound aggregate of minute fibres and grains of zoisite and other minerals.

Sauvage, FRÉDÉRIC, a shipbuilder of Boulogne, whom the French regard as the inventor of the screw-propeller, in virtue of his having in 1832 improved the pattern in use.

Savage, RICHARD, a minor English poet, who loudly claimed to be the illegitimate child of Lord Rivers and the Countess of Macclesfield—a story for which he himself was the only original authority. His alleged mother married in 1683, but lived unhappily with her husband, and separated from him in March 1685. She bore two children to Richard Savage, fourth and last Lord Rivers, during the period of separation; the one, christened Ann Savage, was born in 1695, and died in infancy; the other, whom Richard Savage afterward claimed to be, was born January 16, 1697, was baptised and registered as Richard Smith, and most probably died also at nurse. The Earl of Macclesfield raised proceedings against his wife in the Arches Court in 1697, and obtained a divorce in the House of Lords in 1698, but some extenuation seems to have been found in the husband's conduct, for the whole of the wife's fortune was restored to her. Two years later she married Colonel Henry Brett, who died in 1724, apparently before the startling story was made fully public. Meantime the disreputable claimant, having no profession, had become by necessity an author, and had assumed the name of Savage at least as early as 1717 in the title to a pamphlet on the Bangorian controversy. In the title-page and dedication to *Love in a Veil* (1718) he first claims the parentage openly, but in Curll's *Poetical Register*, or *Lives of the Poets*, edited by Giles Jacob (1719), the story is for the first time fully given, no doubt by his own pen. Aaron Hill befriended him, and in June 1724 published in *The Plain Dealer* a brief outline of his story. Further letters and allusions followed, together with significant hints of pecuniary distress, which brought subscribers for his *Miscellanies* (1726). A *Life* appeared in 1727, from the pen of Beckingham and another, and undoubtedly helped to get him off the sentence of death for murder in a tavern brawl. His insulting attacks upon Mrs

Brett now became louder and more bitter—in a 'Preface' (1728) to the *Life* of the year before; in his poem, *The Bastard* (1728). Mrs Brett herself took not the slightest notice of the claim; but her nephew, Lord Tyrconnell, seems to have laboured privately to procure Savage's pardon, and after the publication of *The Bastard* to have silenced him with a bribe. *The Wanderer* was dedicated to him in 1729, but his bounty soon ceased, and Savage was again thrown upon the world. His disreputable habits brought with them misery and hunger, and the pension of £50 which the queen allowed him in return for a birthday ode was usually dissipated in a week's debauchery. On the queen's death Pope set agoing a subscription to find him the means of living quietly at Swansea, but after about a year of impatient exile he went over to Bristol, where he wearied out the benevolence of the most long-suffering sympathising friends, was flung into gaol for debt, and there languished till he died, July 31, 1743.

Neither to his poetry nor yet to his remarkable story does Savage owe his enduring reputation, but solely to the noble and touching Apology in which Samuel Johnson immortalised his ill-fated friend (1744). He knew Savage in his own years of hunger in London, had walked round St James's Square with him all night for want of a lodging, warned only by the resolution to stand by their country, and out of the profound pity of his heart for a dead friend's sufferings wrote what is perhaps the most perfect shorter *Life* in English literature. He had heard Savage's story from his own lips, and the natural strength and shrewdness of his own intelligence was betrayed by the partiality of friendship. Yet Savage had not been communicative of the facts of his early life, and he never furnished the world with the proofs he boasted in 1724 that he possessed. All Johnson's authorities were traceable to Savage himself, and the story remains imperishably enshrined in literature, although marked, as Mr Moy Thomas has proved, by 'inherent improbabilities, cautious vagueness, inconsistencies, and proved falsehoods.' But even so stout a friend as Johnson should have paused for proof of such startling and unnatural charges as that Mrs Brett kept the child out of a death-bed legacy (1712) of six thousand pounds by giving Lord Rivers a false assurance of his death, and still further that she tried to kidnap him to the American plantations, and even laboured to prevent his obtaining a pardon when lying under sentence of death.

See the five papers by W. Moy Thomas in *Notes and Queries*, November 6 to December 4, 1858.

Savage Island, or NIUE, a coral islet to the east of the Friendly Islands. The 5000 inhabitants belong to the same Polynesian stock, and were formerly notorious for their ferocity, but are now Christianised.

Savali. See SAMOA.

Savanna, a port of Colombia, on a bay of the same name on the Caribbean Sea, 17 miles WNW. of Barranquilla by the railway to Puerto Colombia. The roadstead is roomy but shallow, and its trade is passing away to Puerto Colombia.

Savannah (Span. *sabana*, 'a sheet'; at first used of a plain covered with ice or snow), a name given by the early Spanish settlers to the great treeless plains of the North American continent. It is practically the equivalent of 'prairie' and 'steppe'; but is a term in use mainly in the southern Atlantic States of the American Union, especially Florida.

Savannah, a river which, with its right branch, forms the boundary between Georgia and South Carolina, rises near the southern border of North

Carolina, and flows south-south-east to the Atlantic. Its length is 450 miles, and it is navigable from November to June for large vessels to Savannah, for steamboats of 150 tons to Augusta.

Savannah, a city and port of Georgia, capital of Chatham county, stretches several miles along the south bank of the Savannah River, 18 miles from its mouth, and 115 miles by rail SW. of Charleston. It is built on a sandy plain, 40 feet above the river, with broad streets shaded by beautiful trees. The dozens of commodious parks are a delightful feature of the place; and almost in the centre of the city is Forsyth Place (30 acres), thickly planted with forest pines. Here is a monument to the Confederate dead; and others in the city commemorate General Nathanael Greene and Count Pulaski, who fell here. Savannah has tramways, gas, and electric light, and many handsome private houses. The chief edifices are the custom-house, city exchange, cotton exchange, court-house, Hodgson Hall, the Telfair Academy of Arts and Sciences, a Roman Catholic cathedral, the Independent Presbyterian Church, Christ Church, on the site of the chapel where John Wesley first ministered to the colonists, and the hospitals and asylums. The coloured people have churches and good schools for themselves. Savannah has long been the first naval stores station and the second port in the United States in respect of the quantity of cotton exported; this has a value annually of from \$15,000,000 to \$25,000,000. Other articles of export are spirits of turpentine (value about \$3,000,000), resin (\$2,000,000), lumber, and cotton-seed. Value of all about \$25,000,000 annually. The annual value of imports is about \$400,000, including principally fertilizers, brimstone, fruit, cotton ties, and salt. More than half of the foreign trade is with Germany and Britain. The entire business of the port for the fiscal year 1894-95 was \$21,813,440. River and harbour improvements provided a channel of 24 feet, subsequently deepened to 28 feet, and over six miles of wharfage and quayage. Savannah has rice-mills, foundries, planing-mills, flour, cotton, and paper-mills, cotton-presses, packing-houses, ice and furniture factories, &c. The city was founded in 1733, and incorporated in 1789. It was taken by the British in 1778, and by General Sherman in December 1864. Pop. (1880) 30,709; (1890) 43,189; (1900) 54,224. See *Harper's Magazine*, January 1888.

Savary, ANNE JEAN MARIE RENÉ, Duc de Rovigo, a French general and diplomatist, was born at Marcq, in Ardennes, 26th April 1774, entered the army as a volunteer in 1790, and served with distinction under Custine, Pichegru, and Moreau on the Rhine, under Desaix in Egypt, and in the battle of Marengo (1800). Napoleon, whose notice he had attracted, made him commander of his bodyguard, and employed him in diplomatic affairs, for which he showed an admirable capacity. In 1804, as commandant of the troops stationed at Vincennes, he presided at the execution of the Duc d'Enghien, an event which he is believed to have unduly hastened; and in the wars of 1806-8 he acquired high military reputation at Jena, in the capture of Hameln, and by his victory at Ostrolenka (February 16, 1807), a brilliant achievement. Created Duke of Rovigo in the beginning of the following year, he was sent to Spain by the emperor, and negotiated the perfidious arrangement by which the Spanish king and his son were kidnapped. In 1810 he superseded Fouché as minister of Police. After the fall of Napoleon, to whom he had always been passionately devoted, and whom he served with a fidelity that stopped not at unscrupulous acts, he wished to accompany him to St Helena; but he was confined

by the British government at Malta for some months, and at last made his escape to Smyrna. After experiencing several vicissitudes he returned to Paris in 1819, and was reinstated in his titles and honours. In 1831 he was appointed commander-in-chief of the army in Algeria; but ill-health forced him to withdraw to France in March 1833, and on the 2d of June following he died at Paris. Savary's *Mémoires* (Paris, 8 vols. 1828) are among the most curious and instructive documents relating to the first empire.

Save, a river in the south of Austria, and an important affluent of the Danube, rises in the north-west of Carniola, and flows south-east, passing Laibach, and forming in part the boundary between Carniola and Styria; then it traverses Croatia, and going eastwards separates Bosnia and Servia on the south from Slavonia on the north, and after a course of 556 miles effects its junction with the Danube at Belgrade. It is navigable up to Sissek in Croatia, 366 miles from Belgrade.

Savernake, a beautiful woodland region in Wiltshire, to the south of the town of Marlborough. Its 40,000 acres of farm and forest and hill, yielding only £12,000 net per annum, were sold in 1891 to Lord Iveagh for £750,000 by the Marquis of Ailesbury; but the sale, after prolonged litigation, was cancelled by the courts in 1893.

Savigliano, a town of North Italy, by rail 32 miles S. of Turin. It is surrounded by old fortifications, and has a triumphal arch to Victor Amadeus I. of Savoy. Pop. 9932.

Savigny, FRIEDRICH KARL VON, writer on jurisprudence, was born, of an old Alsatian family, on 21st February 1779 at Frankfort-on-the-Main, and studied law at Marburg and other German universities. In 1800 he began to teach as a *privat-docent* at Marburg; three years later he was made professor of Jurisprudence there and published a treatise on the Roman law of property, *Das Recht des Besitzes* (Eng. trans. 1849), that quickly won him European fame. In 1808 he was called to the chair of Jurisprudence at Landshut, but in 1810 removed to the corresponding chair at Berlin. This he held, along with several state offices, such as member of the commission for revising the code of Prussia, member of the Supreme Court of the Rhine Provinces, &c., until 1842. In that year he devoted his energies entirely to the task of reforming the laws. He resigned office in 1848, and died in Berlin on 25th October 1861. His greatest books were *Geschichte des römischen Rechts im Mittelalter* (6 vols. 1815-31) and *System des heutigen römischen Rechts* (8 vols. 1840-49), and the continuation of this last, entitled *Das Obligationenrecht* (2 vols. 1851-53). Savigny in those works applied the principles of the historical school to the study of the historical aspects of Roman law with brilliant success. From 1815 onwards he edited in conjunction with Eichhorn and others the *Zeitschrift für geschichtliche Rechtswissenschaft*. His writings appeared as *Vermischte Schriften* (5 vols. 1850). There are biographies by Arndt (1861), Rudorff (1862), Bethmann-Hollweg (1867), Enneccerus (1879), and others.

Savile. See HALIFAX (MARQUIS OF).

Savile, SIR HENRY, a learned scholar, was born in Yorkshire, 30th November 1549, entered Brasenose College, Oxford, but migrated in 1561 to Merton College, where he was elected to a fellowship. He travelled on the Continent (1578), after his return was Queen Elizabeth's tutor in Greek and mathematics, became Warden of Merton College in 1585, Provost of Eton in 1596, was knighted in 1604, and died February 19, 1622. Three years before he had founded chairs of Geometry and Astronomy at Oxford which still bear his name.

His principal works are *Rerum Anglicarum Scriptores post Bedam precipuis* (1596), a folio containing the works of William of Malmesbury, Henry of Huntingdon, Roger Hoveden, and Ingulph; *Commentaries concerning Roman Warfare* (1598); *Fewer Books of the Histories and the Agricola of Tacitus* (1581); and a magnificent edition of St Chrysostom's works (8 vols. folio, 1610-13), a work which cost £8000, one-fourth for paper alone.

Savine, or SAVIN (*Juniperus Sabina*), a low, much-branched, and widely-spreading shrub, with very small, imbricated, evergreen leaves, which grows in Europe, Siberia, Canada, and the northern United States. It bears small black berries, covered with a pale blue bloom. Its foliage has a strong, aromatic, penetrating odour. The fresh and dried tops, and a volatile oil distilled from the former, are used in medicine. Their odour is strong and terebinthinate, and their taste acrid, bitter, resinous, and disagreeable. The therapeutic properties of savine are due to the volatile oil, of which it contains about 2 per cent., consisting chiefly of a body having the chemical composition $C_{10}H_{16}$ and isomeric with oil of turpentine (see JUNIPER).

Savine exerts a stimulating effect on the pelvic organs, and is employed in cases of amenorrhœa and chlorosis. It is best given in the form of the oil, 1 or 2 minims of which may be prescribed in a pill, to be taken twice a day. This drug is sometimes employed for the purpose of procuring abortion; but if given in a sufficiently large dose to produce the desired effect, the life of the mother is placed in the greatest possible peril. Savine in the form of ointment is used as an external application, with the view of keeping up the discharge from a blistered surface. The ointment cannot, however, be kept long without losing its properties.

Savings-banks.—General History.—Savings-banks, for the receipt of small deposits by poor persons, and their accumulation at compound interest, are either (1) voluntary associations, the property and management of which are vested in their trustees and officers, and which are termed *trustee savings-banks*, or (2) institutions established and managed by the state, such as the post-office savings-banks.

The formation of *trustee savings-banks* was first suggested by Defoe in 1697. Though, however, the project was revived by Francis Maseres, Cursitor Baron of the Exchequer, in 1771, and by Jeremy Bentham in 1797, it was not practically carried out in England till the year 1799. The first savings-bank established in Europe is said to have been that of Brumath in France, established in 1765, which was followed by one at Loire (dept. Rhone) in 1790. In Germany savings-banks were first established at Hamburg in 1778 and Oldenburg in 1796; in Switzerland at Berne in 1787, Basel 1792, Geneva 1794, and Zurich 1805; and in Denmark at Kiel in Holstein in 1796. The first English bank was established in 1799 by the Rev. J. Smith, rector of Wendover, Bucks, who, in order to encourage frugality in his parish, offered with two other inhabitants to receive any weekly sums not less than 2d., and if the amount were not touched before Christmas to add 1s. 3d. to it as bonus or encouragement. In Scotland the Rev.

John Mackay established a friendly bank for savings of the poor at West Calder in 1807, and in 1810 the Rev. Henry Duncan founded a similar institution at Ruthwell in Dumfriesshire, which has served as a model for all subsequent ones. In Ireland a savings-bank was established at Stillorgan, County Dublin, in 1815; and one of the earliest founded in Wales appears to have been that at Brecon, established in 1816. In the same year the first savings-banks in the United States—the Philadelphia Savings Fund Society, suggested by Condy Ragnet, and the Boston Savings-bank—were established, and in 1819 were followed by one at New York.

The establishment of savings-banks under government supervision was proposed as early as 1806 by Mr Whitbread; but the credit of first suggesting their formation in connection with the post-office is due to George Hans Hamilton, the Ven. Archdeacon of Northumberland. In 1852 he propounded a scheme to this effect to the Financial Secretary to the Treasury, Mr Alexander Hamilton, which at the request of the latter he again published in 1858, and which was in many respects identical with that now in force. In 1859 a paper, containing many valuable suggestions subsequently adopted by Mr Scudamore, then Postmaster-general, was read by Mr Sikes of the Huddersfield Banking Company, before a Social Science Congress at Bradford; and in 1860 Mr Chetwynd of the post-office drew up the plan of the present system, which was established by the Post-office Savings-bank Act, 1861 (see below).

The system is now established in India and in nearly all the colonies, as well as in all the principal European states, excepting Germany. Its remarkable growth throughout the world will be seen from the following compendium of a table compiled by the Controller of Post-office Savings-banks, published in the report of the Postmaster-general for 1889. It has also been adopted by the following countries not noticed in the table: Russia, Servia, Norway, Japan, and Hawaii. At December 31, 1897, there were in the United Kingdom 7,239,761 accounts open, amounting to £115,896,786; average, £16. 0s. 2d.

POST-OFFICE SAVINGS-BANKS IN 1887.

Country.	Year of Establishment.	Number of Offices.	Number of open Accounts at the close of the Year.	Rate of Interest on Deposits.	Amount due to Depositors.	
					At close of Year.	Average Balance per Account.
FOREIGN.—						
Austria.....	1882	4356	697,708	Per Cent. 3	£1,271,250	£ 2 2 6
Belgium.....	1870	624	542,057	3	9,154,968	16 17 9
France.....	1882	6712	979,597	3	8,940,787	9 2 6
Hungary.....	1886	2962	110,939	3½	214,131	1 18 7
Italy.....	1876	4237	1,570,840	2½	9,600,406	6 2 4
Sweden.....	1884	..	162,004	2½	167,353	1 2 0
Netherlands.....	1881	1164	169,027	2-64	929,393	5 9 11
BRITISH EMPIRE.—						
United Kingdom.....	1861	8730	3,951,761	2½	53,974,065	13 13 2
Canada.....	1868	423	101,693	4	4,137,806	40 13 9
Cape of Good Hope.....	1854	141	12,858	3½	966,800	30 15 0
Ceylon.....	1885	144	6,085	..	12,917	1 18 7
India.....	1882	6048	219,010	2½	4,251,984	19 18 3
New South Wales.....	1871	313	64,002	4	1,501,458	23 9 2
New Zealand.....	1867	283	70,724	4½	1,813,084	22 14 10
Queensland.....	..	113	29,780	5	1,426,018	35 16 11
South Australia.....	..	109	60,301	5	1,627,541	26 19 9
Tasmania.....	1882	..	2,996	3½	46,001	15 7 1
Victoria.....	1865	280	82,876	4	1,406,477	16 19 5

Trustee Savings-banks.—The first two savings-banks acts were passed in 1817, and authorised the formation of banks in Ireland and England for the benefit of depositors, deducting thence only sufficient to provide for the expenses of management, but 'deriving no benefit from such deposits or the produce thereof.' In 1818 the rules, like

those of friendly societies, were made subject to confirmation by justices at quarter sessions, and in the following year the system was introduced into Scotland. In 1828 it was, however, enacted that the rules should be submitted to a barrister appointed by the National Debt Commissioners, who was to certify that they were in conformity with law; and in 1844 it was provided that one of the two copies of rules thus certified was to be returned to the institution, and the other transmitted to the commissioners, while the barrister was also empowered to settle all disputes between the trustees and the depositors. In 1863 the law was consolidated by an act which repealed all previous acts, and enacted that the rules of all banks should contain regulations providing for (1) the attendance of at least two trustees, managers, or specially appointed paid officers on all occasions of public business; (2) the comparison of the pass-books of the depositors with the ledger on every repayment, and also on their first production at the bank after each 20th November; (3) the audit half-yearly of the books of the bank by a public accountant, or one or more auditors appointed by the trustees and managers, but 'not out of their own body;' (4) a book containing an extracted list of the depositors' balances made up every year to the 20th November, to be kept open at any time during the hours of public business for the inspection of the depositors; (5) meetings of the trustees and managers half-yearly at least, and the keeping of minutes of their proceedings in a separate book. The trustees and managers were required to transmit weekly returns, showing the amount of the week's transactions, to the National Debt Commissioners. Lastly, the interest payable to depositors—which, together with that payable to the banks, was, until 1828, 3d. per diem, or nearly 5 per cent.—was reduced to £3, 0s. 10d. per annum, that payable to the banks having been previously reduced to £3, 5s. per annum by the Act of 1844.

Post-office Savings-banks were established in 1861 by an act designed to grant additional facilities for depositing small savings at interest, with 'the direct security of the state' for the repayment of the deposits. It empowers the Postmaster-general, with the consent of the Treasury, to authorise 'such of his officers as he shall think fit to receive deposits for remittance to the principal office and to repay the same,' under such regulations as, with the consent of the Treasury, he may prescribe, paying the moneys so received to the National Debt Commissioners. It provides for the transfer of deposits to and from ordinary savings-banks, and fixes the rate of interest on deposits at £2, 10s. per annum. The Act of 1861 was amended in 1863 by one which provided for the transfer of the accounts of minors, and also for the closing, under certain conditions, of trustee banks, and the transfer of their funds to the post-office banks.

Since 1863 several acts relating to savings-banks have been passed, three of which apply to trustee banks only, the others to both classes of banks. In 1876 the Savings-bank Barrister Act transferred the powers of settling disputes and certifying rules vested in the barrister appointed by the National Debt Commissioners to the Friendly Societies Central Office. The Savings-bank Act of 1880 reduced the interest payable to the trustees of savings-banks to 3 per cent., and that payable to depositors to £2, 15s.—or to within 5s. of that payable to depositors in post-office banks—viz. £2, 10s. per cent. Its most noteworthy provisions, however, were those authorising the investment of deposits in post-office and trustee banks in government stock, to the amount of £100 in any one year, and to a total amount of £300. Regulations issued under this act in 1881 were amended by those of

1888, which fixed the minimum amount of stock purchasable at one shilling. The act thus doubled the original limits of investment, which now amount to £130 in one year instead of £30, provided the £100 be for investment in stock, and to a total of £300 plus £200 deposit. The Savings-bank Act of 1887, while extending the powers of the Postmaster-general to make regulations, conferred a similar power on the Treasury as respects trustee savings-banks, and three important sets of regulations have been issued under it. In the same year the failure of the Cardiff Savings-bank, through a deficiency of £37,000 in the funds due to the frauds of the actuary, led to the passing of the Trustee Savings-bank Act, 1887. Similar failures, chiefly caused by the negligence of trustees in controlling the work of the paid officers of banks, have been of frequent occurrence, one of the earliest being that of the Mildenhall Bank (Suffolk) in 1825. Between 1842 and 1857 there were twenty-three in England and four in Ireland, the loss to the depositors in some cases being very heavy, while in others it was made good by the trustees, and since 1857 there have been fourteen cases of defalcations by paid officials, eleven of which resulted in the closing of the bank. Prior to 1828 the trustees and managers appear to have been personally liable for any deficiency unless they protected themselves by their rules. The Act of 1863 has now provided that no trustee or manager of any bank in the United Kingdom shall be personally liable except (1) for moneys actually received by him on account of or for the use of the bank, and not disposed of as directed by the rules; (2) for neglect or omission in complying with the regulations prescribed by the act as to the maintenance of checks, the audit and examination of accounts, the holding of meetings and keeping minutes of proceedings; (3) for neglect or omission in taking security from officers as required by the act. The 50 and 51 Vict. chap. 47 empowers the Treasury, if satisfied, on the representation either of the depositors or of the National Debt Commissioners, to appoint a commissioner to hold a local inquiry with regard to any trustee bank and to report thereon; while it also provides for the winding-up of trustee banks as 'unregistered associations' under the Companies Acts. The Savings-bank Act, 1891, takes a further step in the same direction by providing for the appointment of an Inspection Committee of Trustee Savings-banks, charged with the duty of ascertaining, by means of inspectors, whether the banks are duly complying with the law, and are keeping their expenditure within due limits. If the committee, on the report of any inspector, are of opinion that a bank has made default in either of these respects, they are to report the matter to the National Debt Commissioners, who may, in their discretion, either close the account of the trustees, or report to the Treasury, with a view of an inspection being made of its affairs under the Act of 1867.

Progress of the System.—The first trustee savings-bank in the United Kingdom was established in 1799. By the end of 1817, when legislation on the subject first began, upwards of 135 were in existence, of which 122 were in England, 4 in Wales, 5 in Ireland, and 4 in Scotland. The establishment of the post-office system in 1861 almost immediately caused a decrease in the business of the older institutions, and by the end of 1869, 145 of the 638 trustee banks open in 1860 had been closed, and capital amounting to £1,816,335 transferred to the post-office banks, the number of which has risen from 2535 in 1862 to 9681 in 1890. The average of the deposits in each seems to show that the latter class of banks benefit a lower social stratum than the former.

In 1829, after the passing of the Act of 1828, the

number of savings-bank accounts in the United Kingdom was 409,714, amounting to £14,314,192. In 1845, after the passing of the Act of 1844, it rose to 1,062,930, amounting to £36,748,868; and at the introduction of the post-office system was 1,585,778, amounting to £41,259,145. At the close of 1890 the total number of depositors in the trustee and post-office savings-banks combined was 6,363,096, and the total amount due to them amounted to £111,248,862.

The following table shows the progress of the system:

	1840.		1860.	
	Banks.	Accounts.	Banks.	Accounts.
England & Wales.	444	678,163	535	1,377,370
Scotland	23	43,737	51	139,114
Ireland	79	76,155	54	69,294
	546	798,055	638	1,585,778

	1870.			
	Trustee Banks.	P. O. Banks.	Accounts in T. B.	Accounts in P. O. B.
England and Wales.	401	2091	1,129,397	1,105,841
Scotland	52	452	196,196	39,033
Ireland	43	539	60,164	28,279
	496	4082	1,384,756	1,183,153

	1890.			
	Trustee Banks.	P. O. Banks.	Accounts in T. B.	Accounts in P. O. B.
England and Wales.	251	7833	1,113,219	4,456,066
Scotland	51	967	372,959	172,438
Ireland	22	861	49,643	196,700
	324	9661	1,535,782	4,827,314

The percentage of depositors to total population throughout the United Kingdom was 2.9 in 1840; 4 in 1850; 5.4 in 1860; 8.1 in 1870; 10.5 in 1880; and in 1890 it was 19.1 in England and Wales, 13.5 in Scotland, and 5.2 in Ireland.

The total amounts due to depositors in trustee banks and post-office banks was as follows:

	In Trustee Banks.	In Post-office Banks.	Total Amount.	Average per Depositor.			
	£	£	£	£	s	d	q
1862	40,563,139	1,608,221	42,261,360	25	0	8	9
1872	39,680,652	19,318,339	58,998,991	27	16	11	13
1882	44,012,580	39,037,821	83,050,401	28	14	7	13
1890	43,614,055	67,634,807	111,248,862	28	7	11	14

The amount of stock standing to the credit of depositors in savings-banks was as follows:

	Trustee Banks.	Post-office Banks.	Total.
1881	£124,067	£739,968	£863,035
1885	650,356	2,452,252	3,102,608
1890	1,280,069	4,680,168	5,960,237

In 1880 there were 1080 penny banks established in schools, and in 1890, 2498 such banks.

The Government Annuity and Insurance System.

The government insurance system, though in itself distinct, has by recent legislation become so closely connected with the savings-banks system that it cannot be left out of consideration in treating of the latter. Its foundations were laid in 1833 by the 3 and 4 Will. IV. chap. 14 (extended to Scotland in 1835), which allowed the purchase of annuities, immediate or deferred, through the medium of savings-banks or of societies authorised to be established for the purpose in parishes where there were no savings-banks, and the system was further developed in 1853 by the 16 and 17 Vict. chap. 45, and in 1864 by the 27 and 28 Vict. chap. 43. The latter act is embodied in the Government Annuities Act, 1882, the one now governing the subject. Under these statutes a 'savings-

bank annuity' may be of any amount not exceeding £100 a year, and may be granted to any person not under five years of age, while a 'savings-bank insurance' may be granted for not exceeding £100 to any person between the ages of fourteen and sixty-five, or for not exceeding £5 to a person not under eight years. 'Annuity and insurance regulations' under the acts are made by the National Debt Commissioners as respects trustee, and by the Postmaster-general as respects post-office savings-banks.

Taken in conjunction with the Savings-bank Act, 1880, these acts extend the limits of investment in any one year to £230—viz. £30 ordinary deposit, £100 for investment in stock, and £100 for an annuity or insurance; and to a total of £200 ordinary deposit, £300 stock, £100 insurance, and an annuity of £100.

The Savings-bank Act of 1893 raised the limit of ordinary deposit which may be made in one year to £50, and the total of stock to £500.

In the United States the 'Philadelphia Savings Fund Society,' founded in 1816, received a state charter in 1819; between 1817 and 1846 twelve states had granted charters; fifty years later there were 684 savings-banks in the United States. These do not belong to any connected national system, each being regulated by the legislature of its own state. Before 1870 there were very few failures of savings-banks; but in the seven years that followed no less than twenty-nine failed in the state of New York alone, not by reason of fraud, but mainly on account of commercial depression, the panic of 1873, and injudicious investments. In 1874 the constitution of the New York state was modified so as to prevent the legislature from sanctioning any savings-bank that did not strictly conform to rigorous conditions, fixing the duties and responsibilities of trustees, prescribing the rate of interest (never to exceed 5 per cent. until a surplus of 15 per cent. of deposits as security has been accumulated), and specifying the stocks in which such banks may invest. These regulations have been adopted by other states. Most of the states have endeavoured, ineffectually, to prevent the savings-banks from becoming rivals to other banks, so as to reserve their privileges for the poorer classes. The following table shows the progress of savings-banks in the United States:

	Banks.	Depositors.	Total Deposits.
1825	15	16,981	\$2,537,082
1845	70	145,206	24,506,677
1875	771	2,359,664	924,037,304
1885	684	3,158,950	1,141,530,578
1890		4,258,623	1,524,844,506

See Lewins, *History of Banks for Savings in Great Britain and Ireland* (1866); Keyes, *History of United States Savings-banks* (2 vols. New York, 1878); Scratchley's *Practical Treatise* (2d ed. 1863); *The Law relating to Trustees and Post-office Savings-banks*, by the present writer (1878-84); the reports of the Select Committees on Savings-banks of 1857 and of 1889; the annual reports and returns; also the articles BANKING, CO-OPERATION, FRIENDLY SOCIETIES, SCHULZE-DELITZSCH, &c.

Savona, a seaport of Northern Italy, on the Gulf of Genoa, by rail 26 miles S. by W. of the city of that name and 91 SSE. of Turin. A handsome modern town embowered in orange-groves, it has a Renaissance cathedral (1589-1604), with the tomb of Pope Sixtus IV.; a castle (1542), now used as a prison, in which Mazzini was confined in 1830-31; the Della Rovere Palace, a picture-gallery, a marine institute, &c. The industries embrace ironworks, potteries, glass-works, tanneries, and brick-yards. Coal, wheat, and iron are imported, and chestnut staves and pottery exported. A total of 642,000 tons (510,000 British) enters every year. Pop. 24,481. The poet Chiabrera was born here. The history of Savona has been a long

struggle against its successful rival Genoa, who in the 16th century filled up its harbour; it was only opened again in 1815.

Savonarola, GIROLAMO (JEROME), religious and political reformer, was born of a noble family at Ferrara, September 21, 1452. He was educated at home, and at a very early age became deeply versed in the philosophy of the schools; but his disposition was from the first tinged with religious asceticism, and in 1474 he formally withdrew from secular affairs, and entered the Dominican order at Bologna. Having completed his novitiate and the studies of the order, he seems to have made his first public appearance as a preacher in 1482, at Florence, where he had entered the celebrated convent of his order, San Marco, and where he preached the Lent in that year. His first trial, however, was a failure; his voice was harsh and unmusical, and his simple, devout earnestness failed to interest his hearers, so that, after a time, the course of lectures was entirely deserted. Some time afterwards Savonarola was sent to a convent of his order at Brescia, where his zeal began to attract notice, and the disadvantages of manner and address ceased to be felt under the influence of his sterling genius and irresistible enthusiasm. In 1489 he was once more recalled to the convent of San Marco at Florence. His second appearance in the pulpit of San Marco was a complete success. The great subject of his declamation was the sinfulness and apostasy of the time; and in his denunciation of the vices and crimes of his age he took as his theme what has been the topic of enthusiasts in almost every age, the mystical visions of the Apocalypse. These he applied with terrible directness to the actual evils with which, as with a moral deluge, the age was inundated; and for his half-expositions, half-prophetic outpourings his followers claimed for him the character of an inspired prophet. Under the rule of the great head of the Medici family, Lorenzo the Magnificent, art, literature, and philosophy had all followed the common direction of that elegant but semi-pagan revival which the scholars of the 15th century had inaugurated; and the whole spirit of the social as well as intellectual movement of which Florence, under the Medici, was the centre was utterly at variance with the lofty Christian spirituality and severe asceticism in which Savonarola placed the very first conditions of the restoration of true religion and morality. His preaching, therefore, in its spirit, as well as in its direct allusions, was no less antagonistic to the established system of the government than to the worldly and irreligious manners of the age; the visions and predictions ascribed to him had quite as much of political applicability as of religious significance; and thus, to the aristocratic adherents of the Medici, Savonarola early became an object of suspicion, if not of antipathy and dread. It is said by Pico de Mirandola that he refused to grant absolution to Lorenzo when the latter lay dying in 1492 as the Magnificent declined to accede to the demands made by his confessor.

Up to this time, however, Savonarola's relations with the church were, if not of harmony, at least not of antagonism; and when, in the year 1493, a reform of the Dominican order in Tuscany was proposed under his auspices, it was approved by the pope, and Savonarola was named the first vicar-general. About this date, however, his preaching had assumed a directly political character, and the predictions and denunciations which formed the staple of many of his discourses pointed plainly to a political revolution in Florence and in Italy as the divinely ordained means for the regeneration of religion and morality. In one of his discourses he pointed plainly to the advent of the French

under Charles VIII.; and when this prediction was fulfilled by the triumphant appearance of the French expedition, Savonarola was one of a deputation of Florentines sent to welcome Charles VIII. as the saviour of Italy, and to invite him to Florence. Very soon, however, the French were compelled to leave Florence, and a republic was established, of which Savonarola became, although without political functions, the guiding and animating spirit, his party, who were popularly called *Piagnoni*, or 'Weepers,' from the penitential character which they professed, being completely in the ascendant. It was during this brief tenure of influence that Savonarola displayed to the fullest extent both the extraordinary powers of his genius and the full extravagance of the theories to which his enthusiastic asceticism impelled him. The republic of Florence was to be the model of a Christian commonwealth, of which God Himself was the chief ruler, and His Gospel the sovereign law; and thus the most stringent enactments were made for the repression of vice, and of all the sinful follies by which it is fomented and maintained. All the haunts of debauchery were suppressed; gambling in all its forms was prohibited; the vanities of dress were restrained by sumptuary enactments; and, under the impulse of the popular enthusiasm which the enthusiasm of the prophet engendered, women flocked in troops to the public square to fling down their costliest ornaments, and his followers made in the piazza an immense 'bonfire of vanities,' destroying in one hecatomb large numbers of cards, dice, masks, carnival costumes, and probably some books of licentious poetry and indecent pictures. There seems no ground for the charge often made that he and his disciples destroyed in indiscriminating zeal valuable statues and rare manuscripts.

Meanwhile, the extremes of his rigorism; the violence of his denunciations, which did not spare even the pope himself (Alexander VI.); the assumption by him, or attribution to him, of a supernatural gift of prophecy; and the extravagant interpretation of the Scriptures, and especially of the Apocalypse, by which he sought to maintain his views, drew upon him the displeasure of Rome. He was cited, in the year 1495, to answer a charge of heresy at Rome; and, on his failing to appear, he was forbidden to preach; the brief by which the Florentine branch of his order had been made independent was revoked; he was offered a cardinal's hat on condition of his changing his style of preaching—an offer he indignantly refused; and he was again forbidden to preach. Once again Savonarola disregarded this order. But his difficulties at home now began to deepen. The measures of the new republic proved impracticable. The party of the Medici, called 'Arrabbiati' ('Enraged'), began to recover ground. A conspiracy for the recall of the exiled House was formed; and although, for the time, it failed of success, and five of the conspirators were condemned and executed, yet this very rigour served to hasten the reaction. The execution of these conspirators was afterwards laid to the charge of Savonarola, who was said to have been the chief opponent of the proposal to grant them an appeal—a charge for which there seems to be no foundation. But all circumstances seemed now to count against the once all-powerful Savonarola. At the critical point of the struggle of parties came, in 1497, a sentence of excommunication from Rome against Savonarola. Savonarola openly declared the censure invalid, because unjust, and refused to hold himself bound by it. During the plague Savonarola, precluded by the excommunication from administering the sacred offices, devoted himself zealously to ministering to the sick monks. A second 'bonfire of vanities' in

1408 led to riots. In the same year, when the new elections took place, the party opposed to Savonarola, the Arrabbiati, came into power. He was ordered to desist from preaching; and the struggle was brought to a crisis by the counter-denunciations of a preacher of the Franciscan order, long an antagonist of Savonarola, Francesco da Puglia. In the excited state of the popular mind thus produced an appeal was made by both of the contending parties to the interposition of divine providence by the ordeal of fire; and one of Savonarola's disciples agreed to make trial of the dread ordeal along with a Franciscan friar. But at the moment when the trial was to have come off (April 1498) difficulties and debates arose, and nothing was actually done. The result of this was to destroy with the populace the prestige of Savonarola's reputation, and to produce a complete revulsion of public feeling. In the midst of this reaction he was cited before the council, and brought to trial for falsely claiming to have seen visions and uttered real prophecies, for other religious errors, and for political insubordination. He denied the charges; but, put to the torture, he made avowals which he afterwards withdrew. The conclusion was a foregone one; he was declared guilty of heresy and of seditious teaching, and of being an enemy to the peace of the church. The acts of the trial were sent to Rome, where the sentence was confirmed; he, with two disciples of his order, was given up to the secular power; so on May 23, 1498, this extraordinary man and his two companions, brothers Domenico and Silvestro, were strangled, and their bodies burned by the executioner. They died professing their adherence to the Catholic Church, confessed and received absolution, and on the morning of the execution Savonarola administered the last communion to his two companions and himself. There seems no doubt that Savonarola firmly believed in the dogmas of the Roman Catholic Church; and it is only as a moral and religious reformer, and not a theological teacher, that he can in any way be regarded as a forerunner of the Reformation of the 16th century.

His works, mainly sermons, religious essays, theological treatises (of which the chief is *The Triumph of the Cross*), some poems, and a political discourse on the government of Florence, were mainly written in Latin. An edition in 6 vols. appeared at Lyons in 1633-40; and one by Baccini of his Sermons at Florence since 1889. The principal work on him is the *Life* by Professor Villari (1903, Eng. trans. by Horner; 2d ed., much altered, 1887; Eng. trans. by Linda Villari, 1888). There are also English works by R. Madden (1854) and W. R. Clark (1878); see also Mrs Oliphant's *Makers of Florence*, and George Eliot's *Romola*.

Savory (*Satureja*), a genus of plants of the natural order Labiate, nearly allied to Thyme (*Thymus*). The species are herbaceous and half-shrubby plants, all natives of the south of Europe and the East. The Common Savory, or Summer Savory (*S. hortensis*), is commonly cultivated in kitchen-gardens for flavouring dishes. It is an annual plant, $\frac{1}{2}$ to 1 foot high, with lilac or white flowers, has a strong and agreeable aromatic smell, and an aromatic pungent taste, and is in common use both fresh and dried for flavouring dishes, and especially for flavouring beans. It is stomachic and tonic. Winter Savory (*S. montana*) is used in exactly the same way. It is a half-shrubby plant, with prickly-pointed leaves and larger flowers. Its taste is pungently aromatic. Summer savory is propagated by seed; winter savory by slips and cuttings.

Savoy, formerly a province of the kingdom of Sarlinia, was transferred to France in 1660, and divided into the two departments of Savoie and

Haute-Savoie. It is an alpine region, having the Graian Alps on the eastern frontier, as the boundary next Piedmont. On that side it runs up to 15,792 feet in Mont Blanc, and to 11,792 in Mont Cenis; thence it falls away gradually to the Rhone (950 feet), which separates it on the west from the French department of Ain. The northern boundary passes through the Lake of Geneva; and on the south-west lies the French department of Isere. The area is 3889 sq. m. (2223 in Savoie and 1666 in Haute-Savoie); the total population (1881) 540,525; (1891) 531,564, of whom 263,297 were in Savoie and 268,267 in Haute-Savoie. The rivers are mostly mountain-torrents, as the Isère, Drance, Arve, and Fier, all tributaries of the Rhone, though the Drance falls into the Lake of Geneva. A large part of the surface is covered with forests (29 per cent.) of pine, fir, larch, beech, oak, elm, ash, hazel, walnut, and chestnut, and with pastures (14 per cent.), on which many cattle, sheep, and goats are kept. The vine is extensively grown, some $7\frac{1}{2}$ million gallons of wine being produced annually. Only 23 per cent. of the surface is cultivated. Potatoes, oats, rye, and wheat, with hemp, beet-root, tobacco, colza-seed, and maize, are the principal crops; much honey is made; butter and cheese are exported in large quantities; silkworms are bred; and chestnuts form an article of commerce. Building-stone of various kinds, iron ore, and anthracite are the most valuable of the mineral products. Mineral baths are found at Aix-les-Bains, Evian, Challes, and other places. There is considerable manufacturing industry, especially in the making of cottons, silk stuffs, gauze, woollens, iron, clocks, leather, paper, flour, &c. The peasant women make rough woollen stuffs for home wear. The people are poor, thrifty, and industrious; large numbers leave home every year to fill the lower grades of domestic service in Paris and other large towns; but nearly all return home when they have made a little money. The dept. of Savoie has the four arrondissements of Albertville, Chambéry, Moutiers, St Jean-de-Maurienne; capital, Chambéry. Haute-Savoie has the four arrondissements of Annecy, Bonneville, St-Julien, Thonon; capital, Annecy.

HOUSE OF SAVOY.—The territory of Savoy formed a part of ancient Gaul. After the decline of the Roman empire it was occupied by the Burgundians (437), and from them passed to the Franks in the next century. Subsequently it formed part of the Burgundian kingdom of Arles, and towards the middle of the 11th century became a fief of the empire. The counts of Maurienne, the ancestors of the Savoy counts and dukes, are sometimes stated to have been descended from Wittekind, last king of the Saxons; it is more probable that they had a local or Provençal origin. The emperor, Conrad II., invested Humbert I. (d. 1048), Count of Maurienne, with the counties of Chablais and Lower Valais. For some centuries the chief features in the history of the house are the successive additions of territory that were made to this early nucleus, until, in the beginning of the 15th century, the dominion of the Savoy rulers extended from Lake Geneva southwards to the Gulf of Genoa, and from the river Saône south-eastwards to Lago Maggiore, and Vercelli and Alessandria in Piedmont. Otto (1048-60) acquired by marriage the marquisate of Susa and the counties of Val d'Aosta and Turin. The province of Bugey and the lordship of Tarentaise were added by the next two counts. Amadeus III. (1103-49) called himself margrave of Turin and Count of Savoy, being the first to use the latter title. Amadeus IV. (1233-53), following the traditions of the family, gave his support to the emperor, Frederick II., against the pope, and

was rewarded by being created Duke of Chablais and Aosta. Peter (1263-68) before succeeding to power had spent some time in England, where he built in London the palace afterwards called the Savoy; two of his nieces married Englishmen, King Henry III. and Richard Earl of Cornwall. Amadeus V. (1285-1323), surnamed the Great, extended his territories considerably in the north-west (Geneva, Faucigny, Bresse, &c.), acquired the county of Asti in Piedmont, and was made a prince of the empire. The protectorate over Nice, Ventimiglia, Villafranca, and Barcelonette was acquired by Amadeus VII. (1383-91). The Emperor Sigismund made the eighth Amadeus (1391-1433) Duke of Savoy and of Piedmont (1416), and afterwards invested him with the county of Vercelli. But this prince resigned the title and retired to a monastery. In 1439 the Council of Basel deposed Pope Eugenius IV. and elected Amadeus of Savoy pope in his stead; he took the name of Felix V., but resigned the papal dignity in 1448, and died a cardinal in 1451.

The reign of Charles III. (1504-53) was one long train of misfortunes, occasioned by the fact that he sided with the Emperor Charles V. in his great duel with Francis I. of France: Geneva and Valais put themselves (1533) under the protection of the Swiss Confederation; Berne in 1536 seized Chablais, Gex, and Vaud; and by the treaty of Nice France kept possession of Savoy (which she had seized) and the emperor garrisoned the cities of Piedmont, so that Nice only was left to the duke. Emmanuel Philibert, his son, the next duke (1553-80), obtained great renown as an imperial general in the Netherlands, where he won the great victory of St Quentin (1557); this gained him the recovery of his hereditary dominions (except Pignerol, Savigliano, and Saluzzo) in 1559, 1560, and 1564. Ten years later he received again Pignerol and Savigliano, and subsequently acquired the principality of Oneglia and the county of Tenda. His son, Charles Emmanuel (1580-1630), waged war against Henry IV. and Louis XIII. of France, and was deprived of large slices of territory and several fortresses. The succeeding dukes vacillated between the empire and France. Victor Amadeus II. (1675-1730) was at last saved from the clutches of France by the military genius of the celebrated Prince Eugene of Savoy, a distant cousin, who routed the French before Turin in 1706. By the treaty of Utrecht (1713) the Duke of Savoy gained the principality of Montferrat, the kingdom of Sicily, and the recognition of his claim to the crown of Spain should the Bourbon family become extinct. Seven years later the emperor of Austria forced him to exchange the crown of Sicily for that of Sardinia. Henceforward, for 140 years, the sovereignty was known as the kingdom of Sardinia.

The principal immediate aim of the new kings was to get possession of Milan and its territory—i.e. virtually Lombardy. (Turin had been the capital of Savoy since the reign of Emmanuel Philibert.) Charles Emmanuel III. (1730-73) aided France against Austria in two long wars, and thereby gained accessions of territory on his eastern frontier, but he did not get Milan. Under his son and successor, Victor Amadeus III. (1773-96), Savoy, having put herself at the head of the Italian princes in opposing the French Republic and Napoleon, was along with Nice annexed to France. The next duke, who succeeded whilst the French were masters of his continental territories, took refuge in Sardinia (1798), and in 1802 Piedmont was incorporated with France. Victor Emmanuel I. (1802-21) returned to Turin in 1814, not only receiving back his patrimony, but becoming master also of Genoa. This prince left the government to his wife, an Austrian princess, and

his father confessor; their efforts were directed to the extirpation of the elements of liberal sentiment and politics implanted by the French during their occupation. This policy provoked a rising of the liberal-minded in 1821, whereupon the king abdicated in favour of his brother Charles Felix (1821-31), who brought in an Austrian army and continued the oppressive and reactionary policy dictated by Austria. He was the last of the elder branch of the family; and on his death the crown passed to Charles Albert (1831-49), the head of the branch Savoy-Carignano, that had been founded by a younger son of Charles Emmanuel in the 17th century. He abdicated in favour of his son Victor Emmanuel II. during the fever of the revolution of 1848-49. From the time of the French Revolution the Sardinian monarch was one of the most influential potentates in Italy, and from the reign of Charles Felix he was singled out by Italian patriots as the man to effect the future unity of Italy. The history of the monarchy from the accession of Charles Albert has been already sufficiently told under Italy (q.v.).

See *Histories of Savoy* by Cibrario (Turin, 3 vols. 1840-47), Frézet (3 vols. 1826-28), Bertolotti (2 vols. 1830), St-Genis (3 vols. 1869); and of Piedmont by Bianchi (4 vols. 1877-84) and Ricotti (6 vols. 1861-69). For the Stuart connection with the House of Savoy, see STEWART.

Savoy, a cultivated variety of Cabbage (q.v.), forming a large close head like the true cabbages, but having wrinkled leaves. A number of sub-varieties are in cultivation. The mode of cultivation and the uses are the same as those of cabbage. Savoyes are much cultivated for winter use; they require a light, rich soil.

Savoy Palace, an ancient palace of London, situated between the Strand and what is now the Thames Embankment, was first built by Peter, Count of Savoy, uncle of Henry III.'s queen, Eleanor of Provence. It was the prison of the captive king John of France after the battle of Poitiers. Then it was the town residence of John of Gaunt, and was burned by the peasants during Wat Tyler's revolt (1381). Henry VII. rebuilt it, and in 1505 endowed it as a 'hospital' or house for one hundred poor people—'rogues and masterless men' they came to be. In its precincts was held in 1661 the Savoy Conference (see PRAYER-BOOK, Vol. VIII. p. 381). 'The Savoy' also included a chapel royal, built in 1515; it was injured by fire in 1864, but restored at the expense of the Queen. The Savoy Theatre occupies part of the site. See Loftie, *Memorials of the Savoy* (1879).

Savu, an East Indian island W. of Timor, is ruled by Malay rajahs who pay tribute to the Dutch. Chief products, maize, tobacco, rice, cotton, &c., and horses. Pop. 16,000.

Sawdust. Besides being very useful for such purposes as cleaning dusty floors and stuffing such articles as dolls and pin-cushions, sawdust is turned to account in other ways. Oxalic Acid (q.v.) is manufactured on a large scale from it, by oxidising with a mixture of the hydrates of potash and soda. Mixed with tan in the proportion of one to three, it is employed in our cavalry barracks as a better floor for riding-schools than the pure bark. *Chilled* sawdust is found to be superior to and cheaper than ice for the packing of fish. Carbonised sawdust makes a better filter for many purposes than ordinary charcoal. Boxwood sawdust is used for cleaning jewellery, that of mahogany for smoking fish. Sawdust is also used in the 'carbonating' stage of the process for the manufacture of soda ash. The substance called *Bois-durci*, of which beautiful ebony-like medallions and other ornaments are made, consists of the fine sawdust of rosewood,

ebony, and other woods formed into a paste with blood and pressed into moulds or dies. The furrier finds a use for the sawdust of mahogany and rose-wood in dressing his furs, and the small fragments of some woods, such as the pencil cedar, made by saw cuts or the turning tool, yield perfumes. Sawdust sinks in water although the wood from which it is cut floats.

Sawfish (*Pristis*), a genus of cartilaginous fishes distinguished by the prolongation of the snout into a formidable weapon bordered on each side by sharp teeth. Five species of this genus include *P. antiquorum* in the Mediterranean and in many other seas, and *P. pectinatus* off the southern coasts of North America and in the Gulf of Mexico. With its saw, which is sometimes six feet in length, the sawfish slashes or rips up its prey, and its assault is often fatal to large cetaceans. The torn-off pieces of the victim are swallowed by the sawfish, whose true teeth are small and adapted for crushing. The sawfishes are viviparous. The flesh of the sawfish is coarse and almost inedible; the shagreened skin is sometimes used for polishing. Analogous to *Pristis*, which, although it is somewhat shark-like, belongs to the order of rays, is the genus *Pristiophorus*, which is



Lower View of Head of Sawfish.

ranked among the sharks.

Sawfly, the common name of a number of Hymenopterous insects, injurious to plants. They owe their name to the saw-like ovipositors with which the females drill holes in which to lay their eggs. In one family (Tenthredinidæ) the ovipositor is like a double saw, in the other family (Siricidæ) it is rather comparable to a borer. The adults



Turnip Sawfly (*Athalia spinarum*) in its various stages of development.

differ from bees and wasps and other Hymenoptera in having the abdomen attached to the thorax by the whole width of its base instead of by a narrow waist. The larvæ are peculiar in having three pairs of thoracic legs, with which in the Tenthredinidæ a number of abdominal appendages are also associated. They are thus somewhat like caterpillars. Indeed the larva of the Gooseberry and Currant Sawfly (*Nematus ribesii*)—a most destructive pest—is often called a caterpillar. The Corn Sawfly (*Cephus pygmaeus*) lays its eggs on the young stalks of corn, which the grubs afterwards destroy. The Turnip Sawfly (*Athalia spinarum*) is a beauti-

ful insect of an orange colour with deeper red shade behind the black head; the destructive larvæ, which frequently ruin the turnip crop, are almost black, and are familiarly known as *Black Jacks* or *Niggers*. The larvæ of the Pine Sawfly (*Lophyrus pini*) are destructive in young fir-woods; and the young of various species of Sirex—e.g. *Sirex gigas*—bore galleries in the wood of various kinds of pine. See Ormerod's *Injurious Insects* (new ed. 1891).

Sawtre, or CHATRYSS. See HENRY IV.

Saxe, JOHN GODFREY, American poet, born in Highgate, Vermont, 2d June 1816, was by turns lawyer, journalist, politician, lecturer, and journalist again, and died at Albany, 31st March 1887. His poems, of which there are several volumes, are mostly humorous and satirical, though the more serious and tender touches in which American poets are so facile are not lacking.

Saxe, MAURICE, Marshal, a celebrated soldier of the 18th century, was the natural son of Augustus II. (q.v.), Elector of Saxony and king of Poland, and the Countess Aurora von Königsmark, and was born at Goslar, 28th October 1696. When only twelve years of age he ran off from home, made his way to Flanders, joined the army of Marlborough, and took part in the capture of Lille and the siege of Tournay. With a boyish love of change he joined the Russo-Polish army before Stralsund (1711), and distinguished himself under his father's own eyes. Then, returning to Dresden, he was induced by his mother to marry the young Countess Löben; but the union did not last long, being dissolved in 1721. In the meantime Maurice had fought against the Turks in Hungary under Prince Eugene, and studied the art of war in France. In 1726 he was elected Duke of Courland, and for a time maintained himself in his new possession against both Russians and Poles, but was compelled to retire to France in 1729. Joining the army on the Rhine, under the Duke of Berwick, he signalised himself at the siege of Philippsburg (1734), and decided the battle of Ettingen by a desperate charge; for these services he was made a lieutenant-general in 1736. On the breaking out of the war of the Austrian succession he was given command of the army which was appointed to invade Bohemia, and took the strongly-fortified city of Prague by storm. The capture of Eger was effected a few days afterwards, and the rest of the campaign showed that his abilities in the field were not inferior to his skill against fortifications. Heretofore known as the Comte de Saxe, he was in 1744 made a marshal of France, and appointed to command the French army in Flanders; and on this occasion he gave decisive proofs of the superiority of his system of tactics by reducing to inaction an enemy much superior in number, and taking from him, almost before his face, various important fortresses. The following year was for him more glorious still: he defeated the Duke of Cumberland in the battle of Fontenoy. In 1746 Maurice by a series of able manœuvres threw back the allies on the right bank of the Meuse, and gained (11th October) the brilliant victory of Raucoux, for which he was rewarded with the title of marshal-general, an honour which had been conferred upon none but Turenne. For the third time, at Laufeldt (2d July 1747), the victor of Culloden suffered complete defeat at the hands of Maurice, and the brilliant capture of Bergen-op-zoom brought the allies to peace. The Dutch, however, were still disposed to hold out, till the capture of Maestricht (1748) destroyed their hopes, and the peace of Aix-la-Chapelle followed. Saxe had previously carried on a correspondence with Frederick the Great of Prussia; he now took occasion to

visit him at Berlin, and met with a brilliant reception. He then retired to his estate of Chamboard, and died there of dropsy, 30th November 1750. His work on the art of war, entitled *Mes Réveries*, was published at Paris in 1751. Saxe was a gallant soldier, but no scholar. When the French Academy wanted to make him a member he declined the proffered honour in a sentence whose extraordinary orthography accidentally rebuked, more than the most cutting sarcasm could have done, the sycophancy of the Academy: '*Il s'agit de la cademie; cela m'irait come une bage a un chas.*' His love for the actress Adrienne Lecouvreur forms the subject of one of Scribe's best-known plays; and from an illegitimate daughter of his George Sand (q.v.) was descended.

His character and genius are well, though not flatteringly, portrayed in Carlyle's *Frederick the Great*; and see also Lives by Karl von Weber (German, 2d ed. 1870); Saint-René Taillandier (French, 1865); and Vitzthum von Eckstädt (French, 1867), with the Duc de Broglie's *Maurice de Saxe et le Marquis d'Argenson* (2 vols. 1891).

Saxe-Coburg, &c. See SAXON DUCHIES.

Saxhorn, the name of a series of brass wind musical instruments invented by Antoine or Adolphe Sax (1814-94), born at Dinant in Belgium, who settled in Paris in 1842, taught instrumental music, and died in poverty. By inventing Saxhorns and Saxophones he greatly influenced military music over the world. The saxhorn consists of a conical tube opening out to a wide bell, is sounded through a cupped mouthpiece, and is provided with valves or pistons on a principle similar to the Cornet (q.v.). Saxhorns are made in several sizes, the principal being the soprano in F, E \flat , and D; the contralto in C and B \flat ; the tenor or althorn in F and E \flat ; the baritone and euphonium in C and B \flat ; the bass or bombardon in F and E \flat ; and the contra-bass or contra-bombardon in B \flat . These have all the usual open harmonic notes of their respective tubes (see HARMONICS, HORN, &c.), the pistons providing the intermediate tones and semitones. The series have a very wide compass, stated by the inventor as more than five octaves. They are all more or less like the one (the euphonium) shown in the figure, except the contra-bombardon, which, on account of its size and weight, is usually



Euphonium.

made circular, so as to go round the shoulders of the performer. Their number and variety supply all the different parts required by a brass band, and in many places very efficient bands are entirely composed of them. From the fact that their fingering is all alike, a performer, having mastered one, can by a little practice play with equal facility on any of the others. This has tended in great measure to supersede the older instruments, which, from their diversity of fingering, had to be studied separately. This result has also been helped by the short-service system in the British army, where, as the maximum time during which the services of the men can be claimed is so short, the simpler the instrument the sooner they can be taught, and consequently the better return for the trouble of teaching them.

Their compass, richness, and flexibility of tone render them peculiarly suitable for military music, and their form renders them easy to play either on the march or on horseback. The euphonium and bombardon are, however, the only two which have found a place in the orchestra. See BAND.

Saxifragaceæ, a natural order of exogenous plants, comprising herbs, shrubs, and trees, so varied in character that botanists are not in agreement respecting its limits. The British genera, of which there are four, all of which are herbs, are very diverse in character, yet they give very little idea of the range of the variation of generic character in the order when they are compared with the ligneous or arborescent exotic genera. They are all, however, distinguished from the genera of the closely allied orders by their regular flowers; four, five, or rarely ten-lobed calyx, more or less adherent to the ovary; petals equal in number to segments of calyx or wanting; stamens also generally equal in number or twice as many, still more rarely indefinite in number; ovary either adherent or inserted in a broad base, either two or four celled, or, if one-celled, having two or more parietal placentas often lobed at the top, with the same number of styles or stigmas as cells or placentas, rarely twice as many; fruit a capsule, with several seeds, usually many to each cell or placenta; the albumen usually copious. The family is spread over nearly the whole world, most numerous in the mountainous regions of the northern hemisphere; they are rare in tropical America, in Peru and Java, and in southern Australia. The prevailing property is astringency. The small grain-like roots of *Saxifraga granulata*, a native of Britain and other temperate countries of Europe, were formerly reputed to be efficacious in calculus. *S. tridactylites*, also a native of Britain, is said to be beneficial in diseases of the liver. But the only species of the numerous herbaceous class having any well-based reputation for medicinal or official virtues is the Alum-root (*Heuchera americana*), which is abundantly distributed in rocky and shady places throughout the United States. The root, which is intensely astringent, is employed by the Indians to heal wounds and persistent ulcers, and it is said to form the basis of a powder reputed in America to be a cure for cancer.

Among the arborescent species there are some which produce valuable timber. *Cunonia capensis* is the Red Alder or Rood Els of the Cape of Good Hope. Its timber resembles that of the lime-tree, but is more tough and close-grained, and being also susceptible of a fine polish is valued alike for agricultural purposes and for cabinet-work. *Platylophus trifoliatius* is the White Alder or Wit Els of the same country; it is a larger growing tree than the preceding, the trunk often attaining a diameter of 3 or 4 feet. The wood is white, light, and comparatively soft, and is valued for making boxes, drawers, the more common articles of furniture, picture-frames, and the like. The bark of some of the species of *Weinmannia* are employed in Peru and in the West India Islands in the tanning of leather, and also for adulterating Peruvian bark. Some of the Australian species yield gum. The Hydrangea, so popular in British gardens and in cottage windows, belongs to this family.

Saxifrage (*Saxifraga*, 'stone-breaker,' because supposed to break stones in the bladder), a genus of plants of the natural order Saxifragaceæ or Saxifragaceæ (q.v.). The genus is a numerous one, consisting of annual and perennial herbs, mostly tufted. The species are chiefly mountain or rock plants, and are most abundant in the northern hemisphere. Many species are cultivated in gardens for their pretty flowers and neat habit of growth, being

especially valued for ornamenting rockeries. Some thirteen species are natives of Britain, the best known of which is *S. umbrosa*, which, under the popular names London Pride, None-so-pretty, and St Patrick's Cabbage, is a favourite in nearly every cottage garden. The predominant property of the genus is astringency, but it has never been utilised.



Tufted Saxifrage
(*Saxifraga cespitosa*).

Saxo Grammaticus (i.e. Saxo the 'Grammarians' or 'Scholar'), the most celebrated of the early Danish chroniclers, flourished in the end of the 12th century. He was secretary to Archbishop Absalom of Roskilde, was a Zealander by birth, and is said to have died at Roskilde in 1208. At the request of the archbishop he wrote a chronicle of the early kings of Denmark, and brought his

narrative down to the year 1185. The work is entitled *Gesta Danorum*, or *Historia Danica*. The earlier portions are uncritical, but in regard to times near his own Saxo Grammaticus is a most invaluable authority. According to his own statement, he derived his knowledge of the remoter period of Danish history from old songs, Runic inscriptions, and the historical notices and traditions of the Icelanders. The best editions are by P. E. Müller and Velschow (Copen. 1839-58) and A. Holder (Straasb. 1886). There are good translations from the original Latin into Danish by Vedel (new ed. 1851) and Grundtvig (3 vols. 1818-20). To an English translation in the Folklore Society series by Ö. Elton of the first nine books (1892) is prefixed a mythological commentary by York Powell.

Saxon Architecture, the

style of building used in England before the introduction of the Norman architecture at the Conquest. There are few specimens remaining which can be depended upon as genuine. The Saxons built chiefly in wood, and all their wooden edifices are now lost. It seems probable that a rude and simple style, in which many features resembling Norman work were introduced, was that used by the Saxons in the 11th century. But there are also more ancient structures, still partly preserved, in which more characteristic features exist. Amongst these

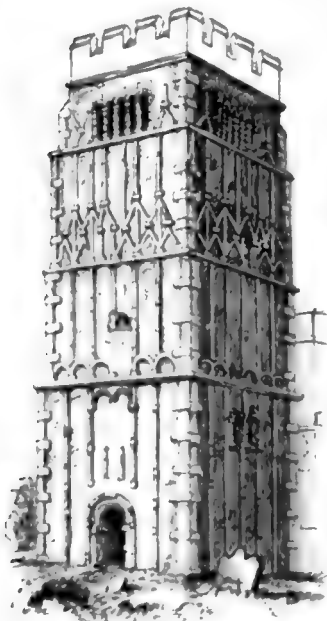

Tower of Earl's Barton,
Northamptonshire.

the towers of Earl's Barton and Barnack, Northamp-

tonshire, a church at Bradford-on-Avon (q. v.), and the crypt at Repton are good examples. The peculiar 'long and short' work of the quoins, the projecting fillets running up the face of the walls and interlacing like woodwork, and the baluster-like shafts between the openings of the upper windows resembling the turned woodwork of the period, are all characteristic of the style. Ancient Roman bricks seem also to have been used in some of the Saxon works, as at the churches of Brixworth, Northamptonshire, and that on the Castle Hill of Dover.

Saxon Duchies, a group of sovereign states in the centre of Germany, lying W. of the kingdom of Saxony, N. of Bavaria, E. of Hesse-Nassau, and S. of the province of Prussian Saxony.

State.	Area in sq. m.	Pop. in 1880.	Capital.
Saxe-Altenburg.....	511	170,867	Altenburg.
Saxe-Coburg-Gotha.....	755	206,329	Coburg and Gotha.
Saxe-Meiningen.....	963	223,920	Meiningen.
Saxe-Weimar-Eisenach.....	1387	325,824	Weimar.

In no one of these states do the territories form a compact mass. Altenburg and Coburg-Gotha each consists of two principal portions, with smaller fragments; Weimar-Eisenach embraces three large divisions; and Meiningen, in addition to a long narrow crescentic piece of territory, has some detached parcels. Except the easternmost part of Altenburg, they are all generally hilly, embracing the Thuringian Highlands and their valleys, and are watered by the tributary streams of the Elbe—the Saale, Unstrut, Ilm, and Elster—and by the Werra. In all the duchies the chief occupations are agriculture and fruit and vegetable growing. Cattle, sheep, and horses are bred with care; poultry are reared in large numbers in Coburg and Meiningen. Various minerals are mined, as iron, coal, and marble in Gotha and Meiningen, lignite, turf, limestone, and sandstone in Altenburg, and kaolin and slates in Meiningen. There is a good deal of industrial activity displayed in all the duchies, especially in the manufacture of glass; and the people of Altenburg make bricks, porcelain, woollens, linen, wooden articles, beer, toys, cottons, chemicals, tobacco-pipes, cloth, machinery, and metal instruments, &c. Education reaches a high level in all the duchies, which maintain in common the university of Jena. The government in each state is framed on the model of a constitutional monarchy. At the head of each is a duke (in Weimar a grand-duke), controlled and assisted by an assembly chosen for three years, and embracing in Altenburg thirty members, in Coburg-Gotha thirty, in Meiningen twenty-four, in Weimar thirty-one members. The representatives are chosen in part directly, in part indirectly. Each state has a ministry (three members in Altenburg, two in Coburg-Gotha, five in Meiningen, and four in Weimar); and each has one vote in the council of the empire. To the imperial parliament Altenburg sends one representative, Coburg-Gotha and Meiningen two each, and Weimar three. The several ducal houses, which have a common ancestor (see SAXONY), are united by family compacts and agreements; the Grand-duke of Weimar ranks as senior, and is the heir to the crown of Saxony in case that royal family dies out.

History.—Saxe-Altenburg was ruled by imperial burgraves from the 12th to the 14th century; in 1485 it became subject to the ruling house of the Saxons, and has continued to be governed by a member of that house ever since. From 1672 to 1825 it was united (for the most part) with Gotha; since then it has formed an independent duchy. Saxe-Coburg has been ruled over by the Saxon house since 1353, as an independent duchy from 1840. In 1826 its duke became duke of Gotha too, but the two duchies were not constitutionally

and politically united until 1873. Saxe-Gotha was made an independent duchy in 1641, was united with Altenburg from 1672 to 1825, and after that joined to Coburg. As Ernest II., Duke of Saxe-Coburg-Gotha and brother of Prince Alfred, died childless (1893), the succession passed to the Duke of Edinburgh (1844-1900). Saxe-Meiningen has been a separate duchy since 1681. Saxe-Weimar has been under the rule of the Saxon house since 1376. Bernhard (q.v.), a brother of the reigning duke, distinguished himself as a Protestant general in the Thirty Years' War. Duke Karl August (1758-1828) made Weimar (q.v.) the centre of the intellectual and artistic life of Germany by gathering round him Goethe, Schiller, Herder, Wieland, &c., and by encouraging the theatre, the university of Jena, and the fine arts.

Saxons (Lat. *Saxones*, Ger. *Sachsen*), a Germanic people, whose name is usually derived from an old Teutonic word *sahs*, meaning a 'knife,' though some authorities believe it to be another form of *Sassen* = 'the settled people,' are first mentioned by Ptolemy as dwelling in the south of the Cimbric Peninsula. In the 3d century a 'Saxon League' or 'Confederation,' to which belonged the Cherusci, the Angrivarii, the Chauci, and other tribes, was established on both sides of the estuary of the Elbe and on the islands off the adjacent coast. During the reigns of the emperors Julian and Valentinian they invaded the Roman territory; but their piratical descents on the coasts of Britain and Gaul are far more famous. In 287 Carausius, a Belgic admiral in the Roman service, made himself 'Augustus' in Britain by their help; and about 450 they, in conjunction with the Angles, established themselves permanently in the island and founded the Anglo-Saxon kingdoms. Before the 5th century they had settled along the North Sea coasts from the Elbe to the Loire, a part of what was later Flanders being called the 'Saxon shore.' But these Saxon settlements soon became absorbed in the kingdom of the Franks. In Britain too there was a Saxon shore with its count. In Roman times the coast districts of Britain from Brighton northwards to the Wash were called *Litus Saxonium*, or Saxon shore. These localities were particularly exposed to the attacks of the Saxons from across the North Sea, and were placed under the authority of a special officer, the Count of the Saxon Shore. At home the Old Saxons enlarged their territory by conquest till it embraced all the lands between the Rhine and Elbe, the North Sea and the Harz Mountains. Along with the Franks they destroyed the kingdom of the Thuringians in 531, and obtained possession of the land between the Harz and the river Unstrut; but this region too was forced to acknowledge the Frankish sovereignty. But the Saxons having thrown off the yoke, wars between the Saxons and the Franks were constant after 719; and the latter after 772 were, under the vigorous leadership of Charlemagne, generally successful, in spite of the determined opposition offered by Wittekind (or Widukind). The desperate resistance of the Saxons was not finally broken until 804, though Wittekind submitted in 785. After the final submission the conquered people accepted Christianity, having before defended their heathen faith in conjunction with their freedom. By the treaty of Verdun (843) the Saxon districts fell to Austrasia, the nucleus of the German empire (see SAXONY). The 'Saxons' of Transylvania (q.v.) are not all of pure Saxon descent; the name is used rather as synonymous with 'German.' See HELIAND and ANGLO-SAXON LANGUAGE and LITERATURE.

To the Celtic Britons the English or Anglo-Saxon invaders were known only as Saxons, and *Sassenach*, or other Celtic form of the word Saxon,

is still the name for Englishmen and their language alike in Wales, the Scottish Highlands, and Ireland. But the 'hated Saxon' as a political war-cry was the coinage of O'Connell.

Saxony, a kingdom of Germany, taking in respect of area the fifth place, but in respect of population the third place, amongst the states of the empire; it is surrounded by Bohemia (on the S.), Silesia (N.E. and N.), Prussian Saxony (N. and N.W.), and the minor Saxon states (W.). It measures 130 miles from east to west, 90 miles from north to south, and has a total area of 5787 sq. m. (a little smaller than Yorkshire); in shape it roughly resembles a right-angled triangle, the right angle being in the north-west, the hypotenuse in the south, along the Erzgebirge (to 3343 feet). The greater part of the surface is diversified by the spurs (2800 feet) of this mountain-chain, with to the west the outliers (2900 feet) of the Fichtelgebirge and to the east the northern extensions (2600 feet) of the Riesengebirge. The northern districts pass over into the great North German plain. On the whole the surface is therefore elevated (nearly 60 per cent. above 800 feet); in many parts it is studded with isolated peaks of basalt and sandstone (e.g. the fantastic pinnacles of the Saxon Switzerland, skirting the Elbe just above Dresden). It lies almost wholly within the basin of the Elbe, being drained by that river and its tributaries. The climate, owing to the elevation, is somewhat colder and severer than the latitude (50° 10' to 51° 29' N.) would indicate. The population grows fast: (1815) 1,178,802; (1840) 1,706,276; (1864) 2,344,094; (1880) 2,972,805; (1890) 3,500,513. Thus it has doubled since 1840. Saxony, whose area is a little more than half that of Belgium (pop. 6,093,798 in 1890), is more densely inhabited, having 605 inhabitants on the square mile to Belgium's 535. By race the majority of the people are Germanised Slavs, close upon 50,000 being Wends, living in Lusatia; the non-Slavonic remainder are descended from ancient immigrants from Franconia and Thuringia. More than 96 per cent. of the population are Lutherans. The capital is Dresden; the largest towns are Leipzig, Dresden, Chemnitz, Plauen, Zwickau, Freiberg, Zittau, Meerane, and Glauchau, in the order named, the first three having each more than 100,000.

Saxony is essentially a mining and manufacturing country; whilst more than 58 per cent. of the population are engaged in the mines and manufactures, less than 20 per cent. depend upon agriculture. The first place amongst the manufactures is taken by the textile industries, which embrace the making of linen, damask, muslin, hosiery, ribbons, cloth and buckskin, flannel, woollen goods, and waxcloth; to these must be added numerous dye-works and factories for printing and stamping textiles. The other branches of industry deal with machinery, pottery, porcelain and glass, chemicals, beer (83 million gallons annually), spirits, lace, paper, straw-plait, tobacco, artificial flowers, pianofortes, hats, toys, watches, books, musical instruments, ornamental wooden articles, &c. These various industries employ close upon 800,000 persons, a large proportion being women. The principal mineral products are coal, argentiferous lead, zinc, iron, and cobalt. Coal is extracted to the annual value of £2,178,850, the other minerals to £175,000. Nearly 30,000 persons are employed in and about the mines, which, however, have decreased since 1860 in number and consequently now employ fewer people. Building-stones, turf, lime, slates, potter's clay, &c. are extracted in considerable quantities. Freiberg is one of the chief centres in Germany for smelting metals, the annual output for all except iron being

valued at £850,000. Iron is smelted, cast, and worked by 6800 workmen to the annual value of £993,000. Less than 56 per cent. of the total area is actually cultivated; but 13 per cent. is meadows and 27 per cent. forests. In spite of the high state of agriculture in Saxony, grain and fat animals are imported annually to the value of £3,300,000, the home produce being insufficient for the people's wants. The crops grown in largest quantity are potatoes, hay, roots and fodder, oats, rye, and beet-root. Fruit-culture, market-gardening, the breeding and fattening of cattle and sheep, and of geese, and bee-keeping are carried on with much zeal and success. Nearly 83 per cent. of the area of the land in cultivation is divided into farms ranging between 2 and 250 acres. A vast amount of trade is done in all kinds of produce, on the Elbe and on the railways (1575 miles in 1890). Of the ordinary revenue over one-half is derived from domains, forests, and state railways; while the chief expenditure is interest and sinking fund of the public debt. The total income of the population increased from £47,975,000 in 1879 to £89,633,000 in 1896. The educational status is very high: amongst the recruits there is only a proportion of about 1 in 5000 who cannot read and write. Amongst the educational institutions are the university of Leipzig, two famous high schools at Meissen and Grimma, a polytechnique at Dresden, a superior industrial academy at Chemnitz, a mining academy at Freiberg, a forestry school at Tharandt, and numerous inferior mining and technical schools throughout the manufacturing districts. The annual ordinary income and expenditure balances at £5,760,000; the public debt, principally incurred in buying up private railways, amounted in 1890 to £32,394,000. The army, some 33,000 strong, forms the 12th army corps of the imperial forces. The constitution is that of a hereditary constitutional monarchy. The king exercises the supreme executive. There are two legislative chambers. The First Chamber is made up of various *ex-officio* dignitaries of the kingdom, as chief-magistrates, high officers of the church, the princes of the royal family, &c., together with twelve representatives chosen by the landed proprietors, and ten more selected by the king. The Second Chamber consists of eighty representatives, thirty-five elected by the towns and forty-five by the rural districts.

To understand the history of Saxony it is necessary to go back to the Old Saxons (q.v.), who, before their submission to the Franks, had been accustomed to choose a 'duke' to lead them in war. After the division of the Frankish dominion into an eastern and western kingdom, in which division the Saxons and their territory passed to the eastern half or Austrasia, the Saxons were greatly exposed to the attacks of the Northmen on the north-west and of the Slav tribes on the north and north-east, and so they chose them a duke again, one Otto (880-912), who not only defended his people valiantly but extended their supremacy southwards over Thuringia. His son, Henry (912-936), was in 919 chosen king of the eastern or German kingdom, and thus the Saxon chief ruler became the head of all the peoples in the future Germany. Henry reduced the Slav tribes living beyond the Elbe, and so made himself master of all the territories included in the present kingdom of Saxony, the Prussian province of Saxony, the minor Saxon duchies, and more besides. His son, Otto II., king of the Germans, made Count Hermann Billung duke of the Saxons, and the dignity continued in his family down to 1106. The princes of this house, to whom the Saxon people were greatly attached, were the most difficult enemies of the German emperors, who after 1024 were

again men of Frankish race. The power of the Saxon dukes was greatly increased under Henry the Proud of Bavaria, who succeeded to the dignity in 1137, and especially under his son Henry the Lion, who conquered Mecklenburg, Hither Pomerania, and Holstein. This prince was deprived of his possessions by the Emperor Frederick I. (1180), who confined the duchy of the Saxons to the territories lying east of the Elbe, and divided those to the west of it between the Archbishop of Cologne and numerous petty bishops and princes. The dignity of duke of the Saxons was given to Bernard of Ascania, son of the prince of Brandenburg. His descendant, Rudolph II. (1356-70), called himself Elector of Saxony. In 1423 the Emperor Sigismund invested Frederick, Landgrave of Meissen and of Thuringia, with the fief of Saxony. This prince, of the House of Wettin, was the ancestor of the reigning royal family in Saxony and of the various dukes of the minor Saxon states. The princes and nobles of the House of Wettin frequently divided and interchanged their possessions in whole or in part, and all the sons of a deceased elector often ruled in common or in conjunction with uncles, so that the history of the house is extremely complicated down to the beginning of the 19th century. But in 1485 a division was made which has in its broad features continued to hold good down to the present day. The family split into two main branches, called, from the two brothers who divided the territories between them, the (elder) Ernestine and the (younger) Albertine lines. The electoral dignity fell to Ernest, who ruled over Thuringia and the western part of modern Saxony. His son, his grandson, and his great-grandson were all zealous supporters of the Reformation, whilst the heads of the Albertine branch, who ruled in the eastern lands (beyond the Elbe), although they were Protestants, supported the pope and the emperor. In 1547 the emperor, after defeating the Elector of Saxony in battle, deprived him of the dignity and of the greater part of his lands; and gave title and lands to his own ally, the head of the younger line, and with that line they remained, the title being exchanged in 1806 for the higher dignity of king. Only the Thuringian territories (see SAXON DUCHIES) remained with the older line.

During the Thirty Years' War the reigning elector, John George I. (1611-56), remained neutral until Tilly invaded his territories; this drove him over to the Protestant side (1631). He made his peace however with the emperor in 1635, receiving Lusatia; but in revenge for this desertion the Swedes wrought terrible havoc in his land and amongst his people ten years long. The Elector Frederick Augustus I. (1694-1733), a vain man, fond of magnificence and eager to make a stir in the world, went over to Roman Catholicism and made an eager canvas for the throne of Poland. He was chosen king as Augustus II. (q.v.); after that the headship of the Protestant states of Germany passed to the Elector of Brandenburg (see PRUSSIA), and the court and dynasty of the Protestant kingdom of Saxony have remained Catholic till the present day. Saxony, in consequence of this alliance with Poland, was drawn into the war against Charles XII. of Sweden, and again suffered greatly from the Swedish armies. In the second Silesian war she sided with Austria, was beaten, and had to pay a million thalers indemnity to Prussia. When the Seven Years' War broke out Frederick the Great refused to recognise the neutrality of Saxony, and, capturing her army, treated her as a conquered province, and forced the elector (Frederick Augustus II.) to take refuge in Poland, to

the crown of which country he had been elected in succession to his father. Frederick Augustus III. (1763-1827) bent himself energetically to the task of building up his state again and restoring the prosperity of his subjects, matters in which he was eminently successful. He took little part in the early Napoleonic wars, and in 1806 proclaimed himself king of Saxony as Frederick Augustus I. Then he went over entirely to the side of Napoleon, and sent the Saxon army to fight side by side with the French down to the battle of Leipzig (1813). After the rout of the French in that battle Frederick Augustus was taken prisoner, and his land occupied by the allied Germans and Russians. The congress of Vienna deprived him of a large portion of his territories and subjects, namely 7720 sq. m. out of 13,510, and 864,404 inhabitants out of 2,047,148; these formed part of the new province of Prussian Saxony. This separation of lands that for centuries had been ruled over by the House of Wettin encountered the strongest opposition on the part of the people. In 1832 the old machinery of government, consisting of a secret cabinet and the two chambers of the feudal estates, was abolished to give place to a constitutional system. In May 1849 the Russian Bakunin and other democratic socialists stirred up a rising in Dresden, which resulted in a week's severe barricade fighting in the streets. From 1858 to 1866 the ruler *de facto* of Saxony was Count von Beust (q.v.). In the Austro-Prussian war of 1866 Saxony sided with Austria, but, being along with her ally defeated, she joined the North German Confederation and paid an indemnity of 10 million thalers to Prussia. In the Franco-German war the Saxon army fought of course on the side of Prussia. Since 1871 the country has been peaceful and in a wonderful degree prosperous.

See *Zeitschrift des sächsischen statistischen Büreaus; Kalender und statistisches Jahrbuch für das Königreich Sachsen*; Böhmert, *Das sächsische statistische Bureau 1875-90* (1891); Engelhardt, *Vaterlandskunde* (ed. Flathe, 3d ed. 1877); and Daniel, *Handbuch der Geographie* (1881) for geography and statistics. The standard history is Böttiger's (ed. Flathe, 3 vols. 1867-73); but consult also Weisse (7 vols. 1802-12), Meynert (2 vols. 1833-35), Gretschel and Von Bülow (1863), and Köhler (1886).

Saxony, PRUSSIAN, a province of Prussia, formed in 1815 out of districts taken from the kingdom of Saxony, part of the duchy of Magdeburg, the Altmark, the principalities of Halberstadt and Erfurt, and some smaller territories. It lies between Brandenburg, Hanover, Brunswick, Hesse-Cassel, the minor Saxon duchies, and the kingdom of Saxony. The duchy of Anhalt almost divides it into two portions. Area, 9746 sq. m.; pop. (1890) 2,579,852. The greater part of the surface belongs to the North German plain, being watered by the Elbe and its subsidiary streams, the Saale, Mulde, two Elsters, Ilm, &c. The soil, except in the north and on the mountains (Harz and Thüringer Wald) in the south, is extremely fertile, the valley of the Golden Meadow (*Goldene Aue*) being particularly famous. Lignite and salt are extracted to the annual value of 1½ million pounds sterling. Copper is mined. Wheat, beet-root, flowers, vegetables, hops, &c. are extensively grown. There are important manufactures of cloth, cottons, machinery, oil, small-arms, beer, chemicals, and other articles. Halle is the seat of one of the first universities of Germany. The province sends 20 members to the imperial parliament, and 38 to the Prussian House of Representatives. The capital is Magdeburg; other large towns are Halle, Erfurt, Halberstadt, Aschersleben, Mühlhausen, and Nordhausen.

Saxophone, the name of a family of musical instruments invented by M. Sax (see SAXHORN).

They consist of a conical brass tube, sounded by a mouthpiece furnished with a single reed similar to that of the Clarinet (q.v.), and are made in as many different keys as the saxhorn. The contralto and baritone are mostly used in Britain; but in France all the varieties are more or less used. They have twenty holes covered by keys and studs for the first three fingers of each hand, and are all fingered alike. They are greatly valued in military music, but are not much used in the orchestra.



Saxophone.

Say, JEAN BAPTISTE, a French political economist, was born at Lyons, 5th January 1767. Being destined for a commercial career, he passed a part of his youth in England, and on his return to France began his work in a life-insurance office. On the outbreak of the Revolution he made his way to Paris, and worked for Mirabeau on the *Courrier de Provence*, and a year or two later acted as secretary to Clavière, the minister of finance. From 1794 to 1800 he edited a journal called *La Décade*, in which he expounded with great effect the views of Adam Smith. After 18th Brumaire (1799) he was appointed a member of the tribunate, but at the end of a few years he began to express his disapprobation of the arbitrary tendencies of the new consular government, and in 1804 ceased to be a member of a body that had become a mere tool in the hands of Bonaparte. Under the despotism of the empire Say was forced into private life, and betook himself to industrial pursuits. In 1803 he issued the first edition of his principal book, *Traité d'Économie Politique* (8th ed. 1876). In 1814 the French government sent him to England to study the economical condition of that country; he laid down the results of his journey in *De l'Angleterre et des Anglais* (1816). From 1819 he lectured on political economy at the Conservatory of Arts and Trades, and in 1831 was appointed professor of Political Economy at the Collège de France, but died 16th November 1832. A follower of Adam Smith, but an independent and sagacious writer, Say was the first to teach Frenchmen to consider rationally such questions as customs-duties, the currency, public credit, the colonies, and taxation, and to him belongs the credit of having made Adam Smith extensively known on the Continent. Besides the books cited he also wrote *Catechisme d'Économie Politique* (1815; 6th ed. 1881), *Cours Complet d'Économie Politique* (1828-30)—this merely an expansion of the *Traité*—and *Mélanges et Correspondance* (1833). His principal writings form vols. 9-12 in Guillaumin's *Collection des Économistes*.

Sayce, ARCHIBALD HENRY, philologist, was born at Shirehampton, near Bristol, September 25, 1846, and was educated privately and at Grosvenor College, Bath. He entered Queen's College, Oxford, in 1865, took a classical first-class in 1869, and became fellow, then tutor, of his college. He took orders in 1870, and was appointed in 1876 deputy to Max-Müller in the chair of Comparative Philology at Oxford, which office he resigned in

1890. Professor Sayce joined the Old Testament Revision Company in 1874, was elected a member of numerous home and foreign learned societies, and received the degree of LL.D. from Dublin in 1881, and D.D. from Edinburgh in 1889.

Among his many books the most important are *The Principles of Comparative Philology* (1874), *Introduction to the Science of Language* (2 vols. 1880), *The Ancient Empires of the East* (1884), *Origin and Growth of Religion as Illustrated by the Ancient Babylonians* (1887); and admirable short popular works on *Fresh Light from the Ancient Monuments, Assyria, the Hittites, and the Races of the Old Testament* (1891), in 'By-paths of Bible Knowledge.' Besides his *Assyrian Grammar* (1872) and *Lectures on the Assyrian Syllabary* (1875), he has contributed many books and papers on the subject to the learned journals, and he edited George Smith's *History of Babylonia* (1877) and *Chaldean Genesis* (1890). Further works were an edition of Herodotus L.-III. (1883), an *Introduction to Ezra, Nehemiah* (1885), *Records of the Past* (2d series, 1888-93), *The Times of Isaiah* (1889), *Egypt of the Hebrews* (1895), &c.

Scab, in Sheep, like itch in man, or mange in horses or dogs, depends upon the irritation of three varieties of minute acari, some of which burrow in the skin, especially if dirty and scurfy, causing much itching, roughness, and baldness. The parasite readily adheres to hurdles, trees, or other objects against which the affected sheep happen to rub themselves, and hence is apt to be transferred to the skins of sound sheep. Chief amongst the approved remedies are diluted mercurial ointments, tobacco-water, turpentine and oil, and arsenical solutions, such as are used for sheep-dipping. One of the best and simplest applications consists of a pound each of common salt and coarse tobacco, boiled for half an hour, in about a gallon of water; to this are added two drachms of corrosive sublimate; and the mixture diluted until it measures three gallons. For each sheep a pint of this mixture should be carefully applied, from a narrow-necked bottle, along the back, and to any other scurfy itchy parts. A second dressing, after an interval of a week, will generally effect a perfect cure.

Scabies. See ITCH.

Scabious (*Scabiosa*), an extensive genus of herbaceous plants, exclusively natives of the eastern hemisphere, of the natural order Dipsacæ (see TEASEL). The flowers are collected in terminal heads, surrounded by a many-leaved involucre, so as to resemble those of the order Compositæ. The Devil's-bit Scabious (*S. succisa*) is a very common autumnal flower in British pastures. The plant possesses great astringency, but no important medicinal virtues, although it was formerly supposed to be of great efficacy in all scaly eruptions, and hence the name scabious, from Lat. *scabies*, 'scab,' 'itch.' The end of the root appears as if abruptly bitten off, and the superstition of the middle ages regarded it as bitten off by the devil, out of envy, because of its usefulness to mankind. The Sweet Scabious (*S. atropurpurea*) is a well-known fragrant garden-flower. It is supposed to be a native of India.

Scad (*Caranx trachurus*, or *Trachurus trachurus*) a fish of the family Carangide, sometimes called the *Horse Mackerel*, because of its resemblance to the mackerel, and its comparative coarseness. It is from 12 to 16 inches long, of a dusky olive colour, changing to a resplendent green, waved with a bluish gloss, the head and lower parts silvery, the throat black. It has two dorsal fins, the first short, the second long, and one long ventral fin opposite the second dorsal. There are two small free spines in front of the anal fin. The ordinary scales are very small, but those of the lateral line are large, spiny, and strongly keeled, the keel terminating in a curved spine. The

species of *Caranx* are very numerous, and it is sometimes divided into several genera; but the scad is the only species found on the British coasts. It is common on the south-western coasts of England, but comparatively rare to the north. It sometimes appears in immense shoals, pursuing the fry of herring or similar prey, and the multitudes have sometimes been so great and so

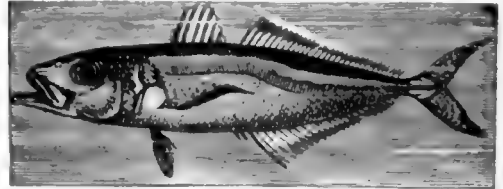

Scad (*Caranx trachurus*).

crowded together that they could be lifted out of the sea by buckets, and overloaded nets have been torn to pieces. The scad has something of the mackerel flavour. Although not much cared for when fresh, it is often salted, and in that state is esteemed as an article of food in Cornwall and the Scilly Isles. This species has a very wide range: it is rare on the west coast of Norway, but abounds along the coasts of France and Portugal and in the Mediterranean. It is found along all the Atlantic coast of Africa to the Cape of Good Hope, and is also abundant in Australia and New Zealand, and on the west coast of South America.

Scævola. CAIUS MUCIUS, a patriotic Roman who, during the siege by Porsena, tried to stab the Etrurian prince, but by mistake killed his secretary. Porsena ordered his would-be assassin to be burned alive; but when the Roman showed his contempt for pain by thrusting his right hand into a blazing fire and holding it there without flinching, Porsena ordered him to go free. By return courtesy Mucius told Porsena he was but the first of a band of 300 who had sworn to slay their country's enemy; and Porsena, startled by the prospect of having to face in succession a band of such reckless men, was, according to the legend, moved to make peace and depart. Mucius received the name of Scævola ('left-handed') in reference to his loss of the right, and proudly handed this cognomen down to his posterity.

Scafell, a double-peaked mountain in Cumberland, on the Westmorland border, 14½ miles SSW. of Keswick. The loftiest summit in England, it is a chief feature in the scenery of the Lake District (q.v.), in the heart and centre of which it stands. Of its two peaks, the higher, Scafell Pike, attains 3210 feet, the other 3161.

Scagliola, a composition made to imitate the more costly kinds of marble and other ornamental stones; and so successfully that it is often difficult to distinguish between the artificial and the real stone. It consists of finely-ground plaster of Paris mixed with a thin solution of fine glue, and coloured with any of the earthy colours, such as ochres, umber, Sienna earth, Armenian bole, and sometimes chemical colours, such as the chrome yellows, &c. This is spread over the surface intended to represent marble; and whilst still soft pieces of fibrous gypsum, marble, alabaster, and other soft but ornamental stones are pressed into it, and made level with the surface. When the composition is set hard it is rubbed down, and polished with the ordinary stone-polishing materials, which give it a very fine gloss. This kind of work is only adapted for interiors, because scagliola will not bear exposure to damp for any length of time;

but its lightness, and the extreme ease with which it may be applied to walls, pillars, pilasters, and even cornices, render it very useful for the decoration of the better class of dwellings and public buildings.

Scala, DELLA. See VERONA, SCALIGER.

Scala Nova, called by the Turks KUSCHADASSI, a seaport of Asiatic Turkey, stands at the head of a gulf of the same name, 40 miles S. of Smyrna, and over against Samos, to which it is the nearest mainland port. The ruins of the ancient city of Ephesus (q.v.) are in the vicinity. Liquorice, 'halwa,' tobacco, and raisins are exported to the value of £124,000 a year, and clothing and groceries imported to the value of £40,000. Pop. 9000.

Scala Santa. See LATERAN.

Scald-head (Chaucer, *scalled*, 'scabby') is the popular name of Favus (q.v.).

Scalds. See BURNS AND SCALDS.

Scale (It. *scala*, 'a ladder'; cf. Ger. *Tonleiter*, 'a ladder of sounds') is in Music any regular succession of sounds between one note and its octave which has been established by custom. The perfection of the octave interval (see HARMONICS) is the natural reason why it has been chosen as the limit, but the scale itself varies, and has varied at different periods and in different countries. The most important of still existing scales which differ from the modern European are the *pentatonic*—the foundation of Chinese and other Oriental scales, as well as of Scotch and those of Celtic origin—and the Gregorian scales or 'modes' (see MUSIC). The first can easily be illustrated by playing the black notes on a pianoforte, beginning from F♯; 'Auld Lang Syne' will serve as an example of a pentatonic air. The modern scales are *diatonic*—i.e. through the tones or steps ('degrees') of the ladder—and *chromatic*, which, proceeding by uniform degrees, includes all the twelve semitones into which the octave has been divided. Diatonic scales are major or minor according to the disposition of the tones and semitones. They may begin from any note in the octave, and are therefore twenty-four in number—twelve major and twelve minor. The scales of C are given as example. The semitone intervals are marked by brackets, those not so distinguished being tones, save that between A♭ and B in the minor scale, marked N.B., which is a tone and a half. T. indicates the tonic, D. the dominant.

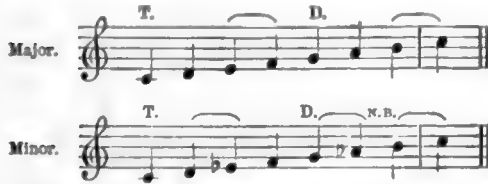

For information about other forms of the minor scale, as well as the abstruse speculations of theorists as to the origin of scales, and philosophic justification of those which have been empirically selected, consult treatises on Harmony (Ouseley, 3d ed. 1883; Prout, 2d ed. 1890); also the scientific treatises of Logier, Helmholtz (*Tonempfindungen*), &c.

Scale Insect. See COCCUS.

Scales. Besides the articles which precede and follow, see BALANCE, WEIGHTS AND MEASURES, DEGREE, GRADUATION, THERMOMETER, FAHRENHEIT, VERNIER; also EPIDERMIS, SKIN.

Scales, modifications of the skin especially characteristic of fishes and reptiles. Those of lizards and serpents are due to folds of the epidermis, the

outer or horny layer of which is in various degrees hardened. So the scales of the pangolin and of the beaver's tail, or those which cover the legs and toes of many birds, are epidermic. On the other hand, the scales of most bony fishes (Teleostei) and of the Dipnoi are developed from the under skin or dermis, and are thus comparable to the little bony plates which occur in the skin of not a few lizards, to the large bony 'scutes' of the crocodylians and many extinct reptiles, and to the armature of the armadillos. A third type of scale is represented by the skin-teeth or 'dermal denticles' of Elasmobranch fishes, for in these, as in the teeth of the mouth, the epidermis forms an external coating of enamel, while the bony core and base are developed from the dermis. To this type the hard scales of some Ganoids (e.g. the sturgeon, bony pike) and a few Teleosteans are also to be referred. Dermal scales are of especial interest, for in a coalescence of these the 'investing bones' of the skull and shoulder-girdle had probably their origin. See FISHES, SKELETON.

Scales, MATHEMATICAL. Maps, estate plans, architectural, engineering, and other proportionate drawings are made to scale. An inch, for example, of the scale may represent a foot, yard, mile, or other length of the space to be shown. The first thing to be determined is the *representative fraction*, which shows the ratio between the scale and the object it represents, and should always be given with the scale. If the scale is to be of 1 inch to 8 miles, as there are 506,880 inches in 8 miles the representative fraction will be $\frac{1}{506880}$, which is usually printed on maps 1:506880. From this fraction a workable length of scale is easily found.



Fig. 1.—Simple Scale of 1 : 506880.

Suppose a scale showing 20 miles would be convenient to work from; as there are 1,267,200 inches in 20 miles, the proportion would be 506880 : 1 :: 1267200 : 2.5. But this result is usually more readily arrived at by taking the proportion of the original lengths instead of using the representative fraction. Thus, 8 : 20 :: 1 : 2.5. To make the scale, draw a line 2½ inches long. This line represents 20 miles. Bisect it, and each half shows 10 miles. Subdivide the half to the left into ten equal parts, and each of these tenths stands for 1 mile. This is a *simple scale* ready for use, and how it is usually drawn and figured is shown in fig 1.

The *diagonal scale* is a vertical subdivision over the simple one, and is an application of the principle in geometry that the sides about the equal

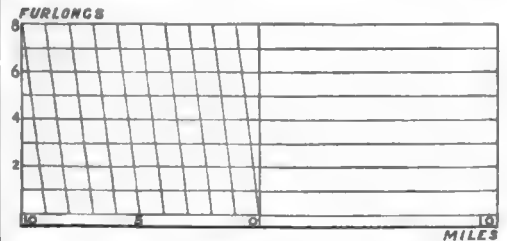

Fig. 2.—Diagonal Scale of 1 : 506880.

angles of equiangular triangles are proportional. Suppose the further subdivision of miles into furlongs were required. Draw above the simple scale

eight parallel lines at equal distances from each other (fig. 2). From its ends and point of bisection draw perpendiculars to the eighth of these parallel lines. Subdivide the left half of the eighth line as the same half of the simple scale is subdivided. Join the first subdivision of the uppermost line from its bisection with the point of bisection of the simple scale, and draw lines parallel to this one from the other nine points of subdivision. The space between the bisecting line and the diagonal nearest it on the first parallel shows one furlong, the space above it two, and so upwards according to the geometrical principle stated. Suppose 16 miles 6 furlongs were to be measured. Put the one leg of the divider on the right end of the sixth parallel line and the other where the diagonal line sixth from the centre cuts that parallel, and the length required is found. The diagonal scales on mathematical rules are generally engraved with ten parallel lines, so as to give subdivision of tenths, this being the most generally useful proportion.

The comparative scale involves no new principle. It is a scale drawn in a different denomination to the same representative fraction. A scale in leagues comparative to the scale in miles would be three times as long itself and in each of its subdivisions; and if the comparative scale were drawn to the same number of units it might be inconveniently long or short. Thus, a comparative scale showing 20 leagues to the representative fraction given above would be 7.5 inches, which might be too long for working purposes or to be exhibited in print or on the plan. But it is not necessary that the same number of units in the larger or smaller denomination be taken; and the length of scale for a convenient number is easily found by proportion. Thus, in a scale 40 Russian versts are represented by 4.5 inches; draw a comparative scale in English miles. Show 20 miles. Take the verst roundly as 1167 English yards. There are 1760 yards in a mile. In 40 versts there are 46,680 yards; in 20 miles, 35,200 yards. Then $46680 : 35200 :: 4.5 : 3.4$. This line 3.4 represents 20 miles to the same representative fraction as the Russian scale of versts, and it can be divided and subdivided like the simple and diagonal scales above.

Scales of Notation, in Arithmetic, have to do with the representation of numbers of any magnitude by means of a few symbols. We ordinarily express numbers in terms of the first nine digit symbols and the symbol known as the cipher—i.e. ten in all. The number 'ten' is then represented by 10, a combination of the 'one' and cipher symbols, and so on in the familiar manner. Mathematically there is no reason why ten should be chosen in preference to any other number as the radix of our common scale of notation. Its convenience arises from the way in which it suits our numeration or naming of numbers. Historically the development of decimal arithmetic—of which our denary scale is the highest phase—is intimately connected with the fact that man has ten fingers. The full significance of the denary scale will be best seen if we take some other number, seven say, as the radix. Our object is now to express all numbers in terms of the cipher and the first six digits only. The number seven itself will be represented by 10, eight by 11, twelve by 15, fourteen by 20, forty-nine, or seven times seven, by 100, and so on. In other words, 49 to radix ten is the same number as 100 to radix seven. As another example take the number of days in the year, and let it be expressed in terms of scales whose radices are twelve, ten, seven, and three. Remembering that 365 to radix ten is a concise notation for $3 \times 10^2 + 6 \times 10 + 5$, we must, in order to express

it in the duodenary scale, throw it into a similar form with twelve substituted for ten. We find easily

$$\begin{aligned} 365 &= 30 \times 12 + 5 \\ &= (2 \times 12 + 6) \times 12 + 5 \\ &= 2 \times 12^2 + 6 \times 12 + 5. \end{aligned}$$

Hence 365 to radix ten is the same number as 265 to radix twelve. In the other cases we get

$$\begin{aligned} 365 \text{ to radix ten} &= 265 \text{ to radix twelve} \\ &= 1 \times 7^3 + 0 \times 7^2 + 3 \times 7 + 1, \text{ or } 1031 \text{ to radix seven} \\ &= 1 \times 3^5 + 1 \times 3^4 + 1 \times 3^3 + 1 \times 3^2 + 1 \times 3 + 2, \\ &\text{ or } 111112 \text{ to radix three.} \end{aligned}$$

These examples show that the simplicity of having a few symbols is balanced by the disadvantage of having to use long expressions for large numbers. The attempt to work in other than the denary scale is moreover greatly hampered by our lifelong habit of thinking and naming our numbers according to a decimal system.

The fact that there are twelve pence to the shilling and twelve inches to the foot has often suggested the introduction of the duodenary scale. According to this scale twenty-four feet nine inches would be represented symbolically by 20.9. To use this scale we should be compelled to invent two new symbols for what we call ten and eleven. But unless we altered our numeration so as to be in accord with the symbolism, the method would be impracticable. For example, we should have to rename *fourteen* and *twenty-six* so as to bring them into line with their duodenary symbols 12 and 22. At present in all calculations involving shillings and pence or feet and inches we are compelled to work partly in the duodenary scale; but the numbers themselves are expressed both symbolically and verbally according to the denary scale and decimal nomenclature. As a matter of history the denary scale is the only one that has ever been used purely; to establish any other would necessitate a complete revolution in modes of thought and habits of language.

Very similar to the mixture of decimals and duodecimals in the examples just given is the method of sexagesimals, which still survives in the subdivision of hours and degrees. There are sixty minutes to the hour (or degree), and sixty seconds to the minute. This method is of great antiquity, and had no doubt an astronomical origin. To the early astronomers it offered special facilities for calculation and for representation of fractions. It was used extensively by Ptolemy and the Alexandrian mathematicians, who employed for symbols the usual Greek numerals as far as the symbol for sixty (see NUMERALS). At its best, however, the sexagesimal notation must have been very cumbersome, even when assisted, as it probably was, by use of the Abacus (q.v.). It is evident that it does not form a pure scale; to do so sixty distinct symbols including the zero would be required. The Alexandrians no doubt borrowed the system from the Chaldeans. In the older Babylonian inscriptions there is found a sexagesimal notation identical, in so far as it is a notation, with that used by Ptolemy and his school. The symbolism is of course quite different, all numbers being represented by appropriate combinations of two cuneiform characters. The numbers up to nine are represented each by the proper number of the simple wedge-shaped character. Ten is symbolised by the angle-shaped character, two of which give twenty, three thirty, four forty, and five fifty. Sixty, however, is represented by the same simple character as one; five times sixty, or 300, by the same character as five, and so on. The famous tables of Senkereh contain the squares and cubes of all numbers from 1 to 60, expressed

in terms of this sexagesimal notation. A few examples will suffice. Thus we find

$$\left\{ \begin{array}{l} \text{VVV} \\ \text{VV} \end{array} \right\} \left\{ \begin{array}{l} \text{VVV} \\ \text{VV} \end{array} \right\} \text{ given as the square of } \left\{ \begin{array}{l} \text{VVV} \\ \text{VV} \end{array} \right\}$$

—i.e. $48 \times 60 + 36 = 2916 = (54)^2$.

We may most simply exhibit the Babylonian method by using heavy figures for the tens and light figures for the units. Thus the above example would be translated $4836 = \text{square of } 54$. Others from the table of Senkereh are

$$\begin{aligned} 12153 &= \text{cube of } 17 \\ (1 \times 60^2 + 21 \times 60 + 53 &= 4913 = 17^3) \\ 73 &= \text{cube of } 3 \text{ (i.e. thirty).} \end{aligned}$$

This last must mean $7 \times 60^2 + 30 \times 60$, although there is nothing in the notation to show what place in the sexagesimal representation is to be occupied by the 3 (or thirty). The example is instructive as showing how far short the Accadians and Assyrians fell of our modern cipher system. It is clear, however, that they were in possession of a sexagesimal scale as true and as complete as the much later Alexandrians. It was used probably only for purposes of calculation; for in simply representing numbers the Assyrians, if not the earlier Accadians, used another scale, in which a special symbol for the hundred was introduced. In this scale, however, the sexagesimal symbolism for 60, 70, 80, and 90 was retained. In the later cuneiform inscriptions of the Persians all trace of the sexagesimal scale is obliterated.

Scaliger (Ital. *Della Scala*, Fr. *De l'Escalpe*), JULIUS CÆSAR, according to the account given of him by the famous son Joseph Scaliger, was born in 1484 in the castle of Ripa, at the head of the Lago di Garda, in the north of Italy. On the same authority we are told that Julius was the second son of Benedetto della Scala, a descendant of the princely family of Verona of that name, which had been dispossessed of its territory by the republic of Venice. In all probability this genealogy is a pure fiction, as in Julius' letters of naturalisation as a French citizen he is styled simply 'a native of the town of Verona in Italy.' If we may trust his son's further account of him, Julius was bred to the profession of arms along with other noble youths under the immediate supervision of his kinsman the Emperor Maximilian, whom he subsequently served in his wars in different parts of Europe. The son of a fallen house, he was at one time so hopeless of his future that like other noble youths of Italy in similar circumstances he seriously thought of entering the brotherhood of St Francis. With this object he proceeded to the university of Bologna, where he devoted himself mainly to the study of Duns Scotus. His zeal for a monastic life, however, soon cooled, and 'to the last day of his life he would never willingly interchange a word with any Franciscan.' Returning to his former profession of arms, he took service in the French armies then attempting the conquest of Italy, and distinguished himself alike by his marvellous feats of strength and his adventurous courage. Having gained the command of a troop of light horse, he behaved with such gallantry as to win for him the special notice of King Francis himself. Notwithstanding his restless life Scaliger never neglected his studies, and to other attainments he added a knowledge of medicine and Greek. Such is the account of Julius Scaliger up to this point in his life which is given by his son in the epistle entitled 'De Vetustate et Splendore Gentis Scaligeræ et Jul. Cæs. Scaligeri Vita.' An account more likely to be true is that Julius was the son of a sign-painter of Verona, by name Benedetto Bordone, and that he studied at Padua, where he took the degree of doctor of medicine.

It is only from his naturalisation as a French citizen in 1528 that our knowledge of Scaliger is drawn from authentic sources. In that year, on the invitation of the Bishop of Agen, he settled in that town as a physician, and remained there for the rest of his life. Here he married a girl of nineteen, Andiette de Roques Lobejac, by whom he had fifteen children. The best-known circumstance of his later life is his attempt to gain notoriety by an unscrupulous attack on Erasmus, the foremost scholar and man of letters of the age. In ridicule of the Latin stylists of Italy Erasmus had published a satire entitled *Ciceronianus*. Construing this satire as a censure of Cicero himself, Scaliger attacked Erasmus (1531) in an oration which for sheer wantonness of abuse is unparalleled even in that age of unscrupulous controversy. As Erasmus paid no heed to this attack, Scaliger produced a second oration which in brutal scurrility surpassed even his former effort, but before its publication Erasmus was dead. Into all his work, much of which was of undoubted value, Scaliger carried the same coarse and jealous temper. Yet his son Joseph, while frankly admitting his father's faults, which, indeed, were largely his own, claimed for him an essential nobility of character, and an especial hatred of everything that suggested falsehood or hypocrisy. Engaged to the last in his labours as a scholar, Julius died in 1538, under suspicion of decided leanings towards the religious teaching of Calvin.

As a scholar Scaliger's fame has been overshadowed by that of his greater son. His vast attainments, however, and his natural force of mind have been admitted by every generation of scholars. But what Lessing said regarding one of his works (*Poetices libri septem ad Sylvium filium*) is the accepted opinion regarding them all: 'Scaliger's judgments as often show want of sanity and taste as insight and good sense.'

For the Life of Julius Scaliger, see the epistle of his son above referred to; Charles Nisard, *Les Gladiateurs de la République des Lettres* (1860); Bouroussé de Laffore, *Étude sur Jules César de Lesca* (Agen, 1860); Magen, *Documents sur Julius Cæsar Scaliger et sa famille* (Agen, 1873). Exclusive of his Latin poems, Scaliger's chief works are *De Causis Lingue Latine libri tredecim*; *Ecotericarum Exercitationum liber quintus decimus de Subtilitate ad Hieronymum Cardanum*; *Poetices libri septem ad Sylvium*; *Commentarii in sex libros de causis Plantarum Theophrasti*; *Animadversiones in Theophrasti Historias plantarum*; *Aristotelis Historia de Animalibus*, J. C. Scaligero interprete, cum ejusdem Commentariis; *Commentarii in Hippocratis Librum de Insomniis*.

Scaliger, JOSEPH JUSTUS, the tenth child and third son of the foregoing, was born at Agen, in the district of France then known as Guyenne, in 1540. At the age of eleven he was sent to the Collège de Guyenne at Bordeaux, then, according to Montaigne (himself one of its scholars), the best institution of its kind in France. Owing to the outbreak of one of the many plagues which then devastated that part of the country, in 1555 he returned home, where he remained till his father's death some three years later. Julius Scaliger was too old to give his son methodical instruction; but indirectly the boy profited by his father's attainments. In accordance with the practice of almost all the scholars of the 16th century, the elder Scaliger was an indefatigable writer of Latin verse. Almost daily he was in the habit of dictating from 80 to 200 lines of his own composing, which it was the business of his son to copy. Daily also the boy had to present to his father a Latin theme on any subject which he himself might choose. Thus, without the regular training of other boys, Joseph early acquired that mastery of the mechanism of Latin prose and verse in which he surpassed all the scholars of his time.

Shortly after his father's death Scaliger proceeded to the university of Paris with the special purpose of acquiring the Greek language, with which he had as yet no acquaintance. The teacher whom he sought was Adrian Turnebus, since the death of Budæus the first Greek scholar in Europe. After two months' attendance in the class of Turnebus, Scaliger discovered, to his mortification, that he was too ignorant to profit by it. With the invincible resolution which was the basis of his character, he shut himself up in his own room and set himself to master the elements of the language. His method of procedure and its extraordinary result have a place among the anecdotes of scholarship. With the help of a Latin translation he read through Homer in twenty-one days, making a grammar for himself as he went along. From Homer he proceeded to the other Greek poets, and in four months he had gone through the whole series. Encouraged by his success with Greek, he next attacked Hebrew, but of Hebrew, according to his best biographer, Bernays, he never acquired that mastery which he showed in the case of Latin and Greek. Eventually he boasted that he spoke thirteen languages, ancient and modern. It is to be noted, however, that he acquired these languages, not in the vain spirit of a mere polyglot, but with the aim of a scientific scholar, who realised that the language and literature of one people are indispensable to the thorough understanding of another. Scaliger remained four years at the university of Paris, but of this period of his life only one notable circumstance is related. It was at this time that he adopted the Protestant faith, a change which eventually proved of the first importance in the subsequent direction of his life.

In 1563 he was invited by Louis Chastaigner de la Roche-Pozay to join him in the capacity of travelling companion, and with the family of this noble he was more or less closely connected for the next thirty years. In 1565 he accompanied Roche-Pozay to Italy, of whose scholarship and religion he received the most unfavourable impression. Of England, which they next visited, Scaliger formed an equally unfavourable opinion. Scotland was also included in their tour, but of the Scots he speaks more kindly, specially mentioning the beauty of their ballads. In 1570 he settled at Valence in Dauphiné, where for about two years he studied under the great jurist Cujacius. From 1572 to 1574 he was in Geneva in the capacity of professor in the academy established there by Calvin. Returning to France, he found a home in the family of Roche-Pozay for the next twenty years. It was the period of the Huguenot wars, and Scaliger, like the rest of his countrymen, suffered from the confusions of the time. It was during these years, however, that he produced a series of works which placed him at the head of European scholars. Among them may be mentioned his editions of Catullus, Tibullus, and Propertius, his commentaries on which are equally remarkable for their learning and spirit of vainglorious assumption. But the works which definitively established his reputation were his edition of Manilius in 1579 and his *De Emendatione Temporum* in 1583. By these works he founded the science of modern chronology, an achievement unsurpassed in the history of scholarship. This labour he crowned by his edition of Eusebius in 1606.

In 1593, on an invitation from the Netherlands in the highest degree flattering to his vanity, Scaliger went as successor to Justus Lipsius in the university of Leyden, where he remained for the rest of his life. Though his connection with the university was almost nominal, it is to his example and inspiration that Holland owes her

long line of scholars during the 17th and 18th centuries. Scaliger's last years were embittered by controversies which he had himself largely provoked by his indifference to the feelings of others. His chief enemies were the Jesuits, who regarded him as the most formidable foe of their order. In Gaspar Scioppius they found a match for Scaliger himself in the use of trenchant Latin, and one, moreover, who carried the qualities of a hired bravo into the domain of letters. The vulnerable point in Scaliger's coarse nature was his pride in his descent from the family of La Scala. In what is perhaps the most unscrupulous lampoon in literature, Scioppius, in his *Scaliger Hypobolimaxus* ('The Supposititious Scaliger'), held the great scholar up to Europe as a baseborn impostor, a profligate, and an atheist. Scaliger wrote a reply; but it was ineffectual against the poisoned weapons of Scioppius. It is generally accepted that the attack of Scioppius hastened Scaliger's death. He still continued his labours, indeed, but his spirit was broken, and he died in 1609, in the arms of his favourite scholar Heinsius.

By his combined knowledge, sagacity, and actual achievement, Scaliger holds the first place among the scholars of all times. 'More than any one before or after him,' says Bernays, 'he approached to a complete conception of the life of antiquity.' To the same effect is the statement of Niebuhr, that 'Scaliger stood on the summit of real and universal knowledge, as no one after him has done.' In his personal character Scaliger was vainglorious, overbearing, and exacting to the verge of absurdity. It was his single-minded devotion to learning, his love of truth, his noble independence of spirit that redeemed a nature essentially coarse and unlovable.

See Jacob Bernays, *Joseph Justus Scaliger* (Berlin, 1855); Charles Nisard, *Juste Lipsius, Joseph Scaliger, et Isaac Casaubon* (Paris, 1852); Tamizey de Larroque, *Lettres françaises inédites de Joseph Scaliger* (Agen, 1881); Mark Pattison, *Essays*, edited by Henry Nettleship, M.A. (vol. i. Oxford, 1889). It was Pattison's intention to write a biography of Scaliger; but the fragments that appear among these essays are all that he actually accomplished of his book. A list of Scaliger's works and their various editions is given by Bernays.

Scallop (*Pecten*), a well-known bivalve, one of those with a single muscle closing the shell. The valves are fan-shaped, the left often more or less flat, the right more markedly arched; both are marked with sinuous radiating ridges, to which the name *Pecten* (Lat., 'a comb') refers. The hinge-line is without teeth, and is extended laterally in two ears. The beautiful colouring of the shells is remarkable even among bivalves. On the margins of the mantle there are hundreds of small sparkling eyes of different degrees of visual efficiency. The small finger-shaped foot is usually marked with bright orange or red colour. The scallops are widely distributed in all seas, at depths of 3 to 40 fathoms. When young they are active and able to swim a little by rapidly opening and closing their valves, but as they grow older they become more sedentary, and are often found thickly covered with acorn-shells, serpulæ-tubes, and zoophytes. Many species attach themselves by a



Pecten opercularis.

byssus secretion, but often this disappears in adult life. Some of the larger species are often popularly called *clams*, a name shared by other bivalves. *P. Jacobæus*, a native of the Mediterranean, is the Scallop-shell which pilgrims were accustomed to wear in front of their hat in token of having visited the shrine of St James at Compostella. *P. maximus*, found on many parts of the British coasts, is about 6 inches broad. It is sometimes eaten, but is said to be indigestible. About 180 living species are known, and over 400 are recorded as fossils from Carboniferous strata.

Scalp, the term employed to designate the outer covering of the skull or brain-case. Except in the fact that hair in both sexes grows more luxuriantly on the scalp than elsewhere, the skin of the scalp differs so slightly from ordinary Skin (q.v.) that it is unnecessary to enter into any details on this point. But besides the skin the scalp is composed of the expanded tendon of the occipito-frontalis muscle, and of intermediate cellular tissue and blood-vessels. Injuries of the scalp, however slight, must be watched with great caution, for they may be followed by erysipelas, or by inflammation and suppuration under the occipito-frontal muscle, or within the cranium, or by suppuration of the veins of the cranial bones, and general pyæmia that may easily prove fatal. If dressed antiseptically at an early stage the risk of such accidents is of course greatly diminished. In the treatment of a wound of this region no part of the scalp, however injured it may be, should be cut or torn away; and, if possible, the use of stitches should be avoided, as plasters and bandages will generally suffice to keep the separated parts in apposition. The patient should be confined to the house (and in severe cases to bed), should be moderately purged, and fed upon non-stimulating but not too low diet. Burns of the scalp are very liable to be followed by erysipelas and diffuse inflammation, but the brain is comparatively seldom affected in these cases. Tumours of the scalp are not uncommon, the most frequent being the cutaneous cysts popularly known as *Wens* (q.v.), and vascular tumours. See HAIR; and for diseases of the scalp, see BALDNESS, and other references given at HAIR.

SCALPING is the act, peculiar to North American Indian warfare, of partly cutting, partly tearing off a piece of the skin of the head, with the hair attached; whether the victim is alive or dead at the time does not affect the operation. The Indians, with whom scalps are the trophies of victory, have always left a long lock or tuft on the scalp as a challenge. Bounties have, in American history, more than once been offered for scalps: in 1724 £100 was offered by Massachusetts for Indian scalps; in 1754, during the French and Indian war, a bounty was offered by the French for British scalps, and £100 by the Colonies for Indian scalps; in 1755 Massachusetts offered £40 for every scalp of a male Indian over twelve years old, and £20 for scalps of women and children; &c.

Scamander, the ancient name of a river in the Troad (see TROY), which was also called Xanthus (Gr., 'yellow') by the gods. As a divinity Scamander took an important part in the Trojan war through its destructive floods. The river rose in Mount Ida and discharged itself into the Hellespont, after being joined by the Simois about two miles from its mouth: the two rivers, however, since the 1st century A.D. have had separate courses. There has been much controversy as to what modern river corresponds to the ancient Scamander; but recent investigators have decided in favour of the Menderes.

Scammony is a gum-resin of an ashy-gray colour, and rough externally, and having a resinous, splintering fracture. Few drugs are so uniformly adulterated as scammony, which, when pure, contains from 81 to 83 per cent. of resin (the active purgative ingredient), 6 or 8 of gum, with a little starch, sand, fibre, and water. Ordinary adulterants are chalk, flour, guaiacum, resin, and gum tragacanth. Scammony, when pure, is an excellent and trustworthy cathartic of the drastic kind, well adapted for cases of habitual constipation, and as an active purgative for children. The resin of scammony, which is extracted from the crude drug by rectified spirit, possesses the advantage of being always of a nearly uniform strength, and of being almost tasteless. The *Scammony Mixture*, composed of four grains of resin of scammony, triturated with two ounces of milk, until a uniform emulsion is obtained, forms an admirable purgative for young children in doses of half an ounce or more. According to Christison, 'between 7 and 14 grains of resin, in the form of this emulsion, constitute a safe and effectual purgative' for adults. Another popular form for the administration of scammony is the *Compound Powder of Scammony*, composed of scammony, jalap, and ginger, the dose for a child being from 2 to 5 grains, and for an adult from 6 Scammony (*Convolvulus Scammonia*): to 12 grains. a, portion of root (Bentley and Trimen).

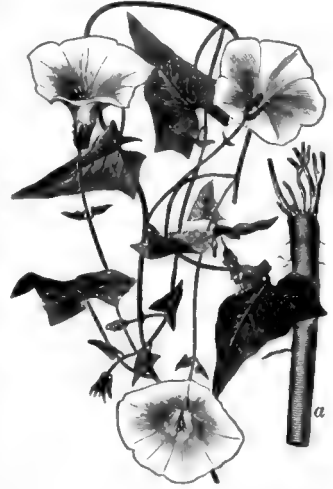

Scammony is frequently given surreptitiously in the form of biscuit to children troubled with thread worms.

The plant which produces this valuable drug is *Convolvulus Scammonia* (see CONVOLVULUS), a native of the Levant. It is a perennial, with a thick fleshy tapering root, 3 to 4 feet long, and 3 to 4 inches in diameter, which sends up several smooth slender twining stems, with arrow-head-shaped leaves on long stalks. The root is full of an acrid milky juice, which indeed pervades the whole plant. The scammony plant is not cultivated, but the drug is collected from it where it grows wild. The ordinary mode of collecting scammony is by laying bare the upper part of the root, making incisions, and placing shells or small vessels to receive the juice as it flows, which soon dries and hardens in the air.

Scandalum magnatum, in English law, means slander against the great men of the realm, an offence which consisted in spreading false reports concerning a peer, judge, or other great officer. The statute of 1275 which created this offence was repealed in 1887, and the special forms of action or criminal process formerly in use are superseded by the more general rules of the law relating to Libel (q.v.) and Slander (q.v.). A somewhat similar offence in Scotland is called Leasing-making (q.v.).

Scanderbeg, i.e. Iskander (Alexander) Beg or Bey, the patriot chief of the Albanians, was

born in Albania about 1403, but his parents were both of Servian descent. By the Christians he was commonly called George Castriot, though the Servian family name was Branilo. Young George was carried away by the Turks when only seven years of age, and was brought up in the creed of Islam. His personal prowess and skill as a military leader made him a favourite with Sultan Murad (Amurath) II., who gave him the command of a division in the Ottoman armies. But when about forty years of age he took a momentous step, which he had some time been meditating: after the Turks were repulsed by the Hungarian forces at Nissa (Nisch) in 1443, Scanderbeg deserted with three hundred Albanian followers, having first extorted from the sultan's secretary an order to the governor of the mountain fortress of Croya (Ak-bissar) that he was to hand over that stronghold to him (Scanderbeg). From that time the Albanian chief, who now renounced Islam for Christianity, the creed of his fathers and his countrymen, was an unrelenting foe to the Turks; they never beat him but once, and his name grew to be a terror to their soldiery. In less than a month after the capture of Croya the whole of Albania was up in arms, and the Turkish garrisons had been seized or compelled to retire out of the country. Early in the following year the Albanian chiefs unanimously elected Scanderbeg their leader. He collected an army of 15,000 men, and with them nearly annihilated in the defiles a Turkish force of 40,000; and other columns shared the same fate in the succeeding campaign. The years 1446-48 were chiefly occupied with a fierce war against Venice. At length Amurath II. himself took the field (1449) with 150,000 men; but the little hill-fort of Sfetigrad successfully defied him until he had lost 30,000 soldiers, and then it was only taken through treachery. And being after that effectually foiled before the walls of Croya, the sultan withdrew in disgust. These splendid achievements brought to Scanderbeg congratulations, as well as material assistance in stores and volunteers, from the potentates of Italy and Hungary; but none of them sent the brave leader an army, or took up the war with him. The proud Albanian chiefs too began to fall away, mainly because of Scanderbeg's manifest purpose of aggrandising his own family and enlarging its power; some of them even went over to the enemy and led Turkish armies against him. But he nevertheless continued to crush every force that the Turks poured into the mountain fastnesses of Albania, or stationed near its frontiers. At length in 1461 a truce of ten years was concluded between the combatants. Two years later, however, at the instigation of Pope Pius II., who tried in vain to league the Christian princes together against the all-conquering Ottomans, Scanderbeg renewed the war, and again defeated every force that dared to attack him. Even Mohammed II., conqueror of Constantinople, conducted two campaigns in person against the invincible chief, and retired baffled both times, on the first after losing 35,000 men before Croya. Scanderbeg died at Alessio on 17th January 1468, of malarial fever, doubtless also worn out by a quarter of a century's fierce and incessant fighting. He was personally a man of tall stature and commanding appearance, terrible in battle, inflexible in resolution, of wonderful activity, and full of resource, a man whom victory did not demoralise, nor desertion dishearten; nor was natural kindness wholly destroyed by the savage nature of the strife he was engaged in. There can be no doubt that for a time he broke the force of Moslem irruption, and had he been adequately supported would have inflicted some permanent injury upon the Turkish power. After his

death the Albanian opposition speedily collapsed—an incontrovertible proof of Scanderbeg's genius. See C. Paganell, *Histoire du Scanderbeg* (1855), and the *Edinburgh Review* (October 1881).

Scanderoon, or ALEXANDRETTA (*Iskanderun*, 'Alexander's town'), the port of Aleppo, stands on the east shore of the Gulf of Scanderoon, in the extreme north-east of the Levant, 30 miles N. of Antioch, and 77 NW. of Aleppo. It is a poor and unhealthy place, of some 1500 inhabitants, with a large but neglected harbour. Nevertheless it has a transit trade worth £2,601,600 a year—£1,698,200 being for imports destined for Aleppo and the towns of northern Syria, and £903,400 for exports, chiefly wool, specie, native manufactures, cereals, leather and hides, cattle, butter, &c., galls and yellow berries, pistachio nuts and raisins, liquorice root, copper ore, and silk cocoons. The imports consist principally of manufactured goods (two-thirds of the total), cloth, groceries, indigo, specie, metals, leather and hides, silk, drugs, &c. Britain's share of the whole is 31½ per cent.; next comes Turkey with 19 per cent. Alexandretta was founded by Alexander the Great to commemorate his victory of Issus (333 B.C.). Off here Sir Kenelm Digby defeated a Franco-Venetian squadron (1628); and close by the Egyptian Mehemet Ali defeated the Turkish troops in 1832.

Scandinavia, a large peninsula in the north of Europe, bounded on the N. by the Arctic Ocean, on the W. by that branch of the Atlantic now called the Norwegian Sea, and on the S. and E. by the Baltic Sea and the Gulf of Bothnia. The character of the country, its physical features, industries, &c., are given under NORWAY and SWEDEN. Historically, Scandinavia includes Denmark and Iceland, and in a literary sense also the productions of the Swedish race in Finland. For Scandinavian languages and literatures, see ICELAND, NORWAY, SWEDEN, DENMARK, and EDDA.

Scandinavian Mythology, NORSE or NORTHERN MYTHOLOGY, or more properly TEUTONIC MYTHOLOGY, since its chief deities were worshipped by all branches of the Teutonic race. The sources to be examined in regard to Scandinavian mythology are many and varied. 'Runic monuments,' of which George Stephens has published three volumes, a work of great importance to students of mythology, are found throughout the Scandinavian countries. From heathen Germany we have a few ancient laws, and a few glossaries containing mythological words. The *Lex Saticæ*, of which we have a Latin translation, was doubtless originally produced in the German tongue. Then there are formulæ by which the new converts to Christianity renounced the old gods, and in which names of heathen divinities therefore occur. But precious though it be, the amount of mythological information to be gathered from these and similar sources is very small. A richer vein of information is the tolerably well-represented collection of German heroic poems, among which the most important are the Niblung story and Gudrun. The *Heliant* preserves a number of heathen phrases and figures of speech. The Anglo-Saxon *Beowulf* poem would be more valuable had not the transcriber conceived it to be his duty to omit the names of the heathen gods occurring in the lay. Iceland is the Mecca to which all must turn who would understand the Odinic religion; Iceland is the Patmos where Scandinavian mythology was recorded. There we find a large mythological literature put in writing after the introduction of Christianity (1000 A.D.), and after the people had adopted the Roman

Copyright 1892, 1897, and 1900 in the U.S. by J. B. Lippincott Company.

alphabet, but still written in the spirit of the asafæth, 'naught extenuating and putting down naught in malice.' The most important of the Icelandic documents are the Elder or Poetic Edda and the Younger or Prose Edda. The Heimskringla, completed by Snorre Sturlasson about the year 1230, contains much information concerning Scandinavian heathendom, for it gives a very elaborate account of the introduction of Christianity in the north, portraying the conflict between the old and the new religion, and begins with sketches of a number of kings who ruled Norway 140 years before the introduction of Christianity. Hence valuable information may be found in that work not only in regard to the rites and ceremonies prescribed by the Odinic ritual, but also of the morals and habits inculcated and produced by the Odinic code. Several of the Icelandic sagas are also of value in this respect. Cæsar and Tacitus furnish some important data, and next after them come the Christian writers down through the foggy and dark middle ages, who wrote in Latin; but the very small amount of mythological information contained in their books is due in part to their ignorance, but mainly to their hostility to the heathen religion. Among this class of writers Denmark presents a remarkable exception in Saxo Grammaticus, who lived in Denmark in the 12th century. He wrote a *Historia Danica*, and embodied in it an outline of Scandinavian mythology based on old songs. But he presents it as history, assuming Odin, Thor, and the other deities to have been kings and potentates in the north. The first eight books of his history are exclusively mythological. Saxo had a world of valuable light, though he himself saw nothing. Finally the student of Scandinavian mythology must look for fragments of Odinism in the customs, habits, speech, traditions, ballads, folklore tales, and in the usages of the Christian churches throughout Teutondom.

It was Time's morning
When Ymer lived;
There was no sand, no sea,
Nor cooling billows;
Earth there was none,
No lofty heaven;
No spot of living green;
Only a deep profound.

Thus the Elder Edda. The beginning was this: Many ages ere the earth was made there existed two worlds. Far to the north was Nifheim—i.e. the nebulous world, and far to the south was Muspelheim—i.e. the fire world. Between them was Ginungagap, the yawning deep. In the middle of Nifheim lay the spring Hvergelmer, and from it flowed twelve ice-cold streams, called the Elivogs (Elivagar), of which Gjøl was situated nearest Hel's gate. Muspelheim was so bright and hot that it burned and blazed, and could only be entered by those who had their home there. In the midst of this intense light and burning heat sat Surt, guarding its borders with a flaming sword in his hand. The Elivogs flowed far from their spring-head in Hvergelmer into Ginungagap, and the venom they carried with them hardened as does dross from a furnace, and became ice. Vapours gathered and froze to rime, and thus were formed in the yawning gap many layers of congealed vapour. But the south side of Ginungagap was lighted up by sparks from Muspelheim. Thus, while freezing cold and gathering gloom proceeded from Nifheim, the other side of the gulf was exposed to the dazzling radiance and scorching blasts from Muspelheim, and when the heated blasts met the frozen vapours they melted into drops, and, by the might of him who sent the heat, these drops quickened into life and took the form of a giant man. His name was Ymer, and he became the progenitor of all the evil race of giants. At the

same time and in the same manner sprang into life a cow, Andhumbra, by whose milk Ymer was nourished. The cow fed herself by licking the salt rime on the rocks, and at the end of the first day she produced by licking the stones a man's hair, on the second evening a head, and on the third evening a perfect man. His name was Bure. He was fair, great, and mighty. He begat a son by name Bor. Bor married the giantess Bestla, and she bore him three sons, Odin, Vile, and Ve (Spirit, Will, and Holiness), and Odin became the father of the gods, who rule heaven and earth. The three brothers, Odin, Vile, and Ve, slew the giant Ymer, and when he fell so much blood flowed that all the race of giants were drowned excepting Bergelmer and his wife, who escaped in a boat and perpetuated their race. The three sons of Bor dragged Ymer's body into Ginungagap, and out of it they made the world: of his flesh the land, of his blood the ocean, of his bones the rocks, of his hair the forests, of his skull the vaulted sky, which they decorated with red hot flakes from Muspelheim to serve as sun, moon, and stars. Ymer's brain they scattered in the air, and made of it the melancholy clouds. Dwarfs quickened like maggots in Ymer's flesh. But there were yet no human beings upon the earth. One day Odin, Hœner, and Loder were walking by the sea, and found two trees, an ash and an elm. They made of them the first man and woman. Odin gave them the breath of life (*ônd*), Hœner gave them feeling (*ôf*), and Loder gave them blood and the form (image) of the gods (*la ok lito godða*). The man they called Ask and the woman Embla, and from them are descended the whole human family.

It is worthy of note that the world does not pass from chaos to cosmos. The old Scandinavians took a step farther back into primeval time, and conceived first a *pre-chaotic* state (Muspelheim, Nifheim, and Ginungagap), then a *chaotic* epoch (Ymer, Andhumbra, Bure, Bor, Bestla, Bolthorn, Odin, Vile, and Ve), and finally *cosmos* made from Ymer slain. The gods belonging to the Asgard pantheon and also giants came into being in the chaotic epoch. Odin was born in chaos. But the Scandinavian mythology conceived living and life-giving beings in the pre-chaotic age also. Surt guarded Muspelheim before any creation or birth had taken place. Surt is also the last figure who appears in Ragnarok, where he flings fire and flame over the world, and he is the last one who appears in that terrible act of the drama. The Edda says that Nidhug, a terrible serpent, dwelt in Hvergelmer in Nifheim. Venom flowed with the Elivogs rivers out of Hvergelmer. This points to an evil being in pre-chaotic Nifheim. This dualism in the pre-chaotic epoch is a very interesting point in Scandinavian mythology. The Odinic pantheon has twelve gods to whom divine worship is due, and there are twenty-six goddesses. The twelve gods are Odin, Thor, Balder, Hermod, Tyr, Brage, Heimdal, Hoder, Vidar, Uller, Vale, and Forsete. The asa-god Hœner disappears from the circle of gods, having been given as a hostage to the Vans. To the number of gods must however be added Njord and Frey, who originally were Vans, and also Loke, who was of giant descent, but had entered into foster-brotherhood with Odin himself, and was adopted by the gods. Chief among the goddesses is Odin's wife Frigg; Thor's wife is Sif, Balder's is Nanna, and Brage's is Idun. Freyja is the goddess of love. The gods and goddesses dwell in Asgard, but nearly every one has a separate dwelling. Odin's high-seat is in Hlidskjalf, whence he looks out upon all the nine worlds. He also has a large hall, the famous Valhal, whither he invites all men fallen in battle. Thor lives in Thrudvang, Balder in Breidablik,

Concerning the different gods, and particularly about Thor, Odin, Balder, and Frey, there are a number of myths giving accounts of their exploits.

The most poetical and significant myth is that of the great world-tree, the ash Ygdrasil. It is the tree of existence, the tree of life and knowledge, the tree of grief and fate, the tree of time and space; it is the tree of the universe. This tree has three roots extending into the three principal worlds. The lowest strikes down into Niflheim into the well Hvergelmer, where it is gnawed by the ancient dragon Nidhug and all his reptile brood. The second root stretches into Jotunheim to the fountain of Mimer, where wisdom and wit lie hidden, and of whose waters Odin once purchased a draught, leaving one of his eyes as a pledge with Mimer. The third root is found in Asgard among the gods, near the sacred fountain of Urd the norn of the past, where the gods sit in judgment, riding thither daily over the Bifrost bridge—i.e. the rainbow. At this fountain dwell the three norns Urd (the Past), Verdande (the Present), and Skuld (the Future), and dispense the destinies of men. They weave the web of men's lives. It is a web of golden thread from east to west, from the radiant dawn to the glowing sunset of man's horizon. The woof of this web is fixed in the far north, but the web woven by Urd and Verdande is torn into pieces every evening by Skuld. The branches of Ygdrasil spread over the whole world and aspire above heaven itself. An eagle is perched on the topmost bough, and between his eyes a hawk. A squirrel called Ratasok runs up and down the tree seeking to cause strife between the eagle and Nidhug. Four stags leap beneath its branches, and feed on its buds. Two swans swim in the Urd fountain, and everything placed therein becomes as white as the film of an egg-shell. The norns draw water from the spring, and with it they sprinkle Ygdrasil in order that the boughs may continue green in spite of the destructive agencies that constantly assail it. Honey-dew falls from Ygdrasil, and is food for the bees. Odin hung nine nights on this tree and offered himself to himself.

In Scandinavian mythology there is a very elaborate development of the evil principle. The dragon Nidhug and his brood originated in Hvergelmer in Niflheim. The giant descendants of Ymer were evil, and they did not all perish in his blood-deluge, for Bergelmer and his household escaped and produced a numerous offspring, with whom Thor and the other gods carried on a constant war. But the great type or representation of evil is Loke. He is the instigator of all the misfortunes that have happened both to gods and to men. He is of giant race, but was adopted by the gods, and was already in the dawn of time a foster-brother of Odin. The countenance of Loke is fair, but his disposition is thoroughly bad. Loke frequently accompanies the gods, and they make use of his strength and cunning, and when out of sight he usually plots with the giants for the purpose of bringing ruin upon the gods. He became the father of three terrible children in Jotunheim—i.e. in the home of the giants. These are (1) the Fenriswolf, (2) the Midgard-serpent, and (3) Hel, the goddess of death. The gods knew that these children of Loke were growing up, and would some day cause them great mischief. Therefore they bound the Fenriswolf on a barren island, and put a sword in his open-stretched mouth; but for this the god Tyr had to sacrifice his right hand. They cast the Midgard-serpent into the deep sea, where he encircles the whole earth and bites his own tail. Thor was at one time out fishing with the giant Hymer. He caught the Midgard-serpent on his hook, and would have slain him with his hammer Mjolner had it not been for the giant Hymer, who got frightened and

cut the fishing-line just at the moment when Thor had his hammer raised to strike. The third child of Loke, Hel, goddess of death, was thrown into Niflheim, and Odin commanded that all who died of sickness or old age should go to her, while warriors slain in battle were borne on Valkyrian arms to Valhal. Hel's dwelling is called Helheim, and is large and terrible. Her realm in the lower world is divided into nine abodes, one below the other, and it is in the lowest of these that her palace is, called Anguish, her table Famine, her waiters Slowness and Delay, the threshold Precipice, and the bed Care. The English word *hell* is of course intimately connected with her name.

Loke caused the greatest sorrow to gods and men when by his cunning he brought about the death of the good Balder. Balder was the favourite of all nature, of the gods and of men. He was the son of Odin and Frigg, and the Edda says that he is the best god and that all mankind are loud in his praises. So fair and dazzling is he in form and feature that rays of light seem to issue from him, and we may form some idea of the beauty of his hair when we know that the whitest of all flowers is called Balder's brow. Balder is the mildest, the wisest, and the most eloquent of the gods; yet such is his nature that the judgment he has pronounced can never be altered. He dwells in the heavenly mansion called Breidablik ('broad-shining splendour'), into which nothing unclean can enter. Balder was tormented by terrible dreams indicating that his life was in danger. He told his dreams to his fellow-gods, who resolved to conjure all things animate and inanimate not to harm him, and accordingly Odin's wife Frigg took an oath from all things that they would do Balder no harm. But still Odin felt anxious, and having saddled his eight-footed horse Sleipner, he rode down to Niflheim, where he waked the vala or seeress, and compelled her to give him information as to the fate of Balder. When it had been made known that all things had taken a solemn oath not to hurt Balder it became a favourite pastime of the gods at their meetings to put him up as a mark and shoot at him. But it sorely vexed Loke to see that Balder was not hurt. So he took on the guise of an old woman, went to Frigg, and asked her if all things had promised to spare Balder. From Frigg he learned that on account of his insignificance she had neglected to exact an oath from the mistletoe. So he straightway went and pulled this up, repaired to the place where the gods were assembled, and induced the blind god Hoder to throw the mistletoe at his brother, and do him honour as did the other gods. Loke himself guided Hoder's hand. The twig did not miss its shining mark, and Balder fell dead. The gods were struck speechless with terror. When they had had time to recover their senses Frigg sent Hermod to the goddess Hel to ask her to permit Balder to return to Asgard. Hel said she would release Balder if it was true that he was so universally beloved, and this she would test by observing if all things would weep for him. Messengers were despatched throughout all the world to beseech all things to weep Balder out from Hel's domain. And all things did so with alacrity, men, animals, the earth, stones, trees, and metals, just as we see things weep when they come from the frost into the warm air (a beautiful evidence that Balder is the sun or summer). The messengers were returning confident that their mission had been successful; but on their way home they found a hag crouching on the ground. She called herself Thokk, but she was none other than Loke in disguise. Thokk said she could not weep other than dry tears; and so Hel kept her prey. Now as Loke is physical heat and fire, Thokk's dry tears are the

sparks that fly from the burning wood. Soon afterwards Loke was captured and bound with strong chords to the points of rocks in a cave. A serpent was suspended over him in such a manner that the venom fell into Loke's face drop by drop. But Sigrvyn, Loke's wife, took pity on him. She stands by him, and receives the drops as they fall in a cup, which she empties as often as it is filled. But while she is emptying it venom falls upon Loke's face, which makes him shriek with horror and twist his body about so violently that the whole earth shakes, and thus earthquakes are produced.

But when Balder, the bright and good god, had passed from the happy family circle of the gods to the cold and gloomy abodes of Hel the awful day of doom was impending. It was a fatal thing for the gods and for the world that they united themselves with the giant race. The gods should not have admitted Loke into Asgard. Balder's death was the result, and this hastened the day when the whole world shall be destroyed, when gods and men and giants shall perish in Ragnarok, the twilight of the gods. Increasing corruption and strife in the world are the signs that this great and awful event is impending. Continuous winters rage without any intervening summer now that Balder has been slain; the air is filled with violent storms, snow, and darkness, and these are the signs that Ragnarok is at hand. The sun and moon are swallowed by giants who pursue them in the guise of wolves, and the heavens are stained with blood. The bright stars vanish, the earth trembles in the throes of the earthquake, and the mountains topple down with a tremendous crash. Then all chains and fetters are severed, and the terrible Fenriswolf gets loose. The Midgard-serpent writhes in his giant rage, and seeks land upon the tumultuous waves. The ship Naglfar, which has been built of the nail-parings of dead men, floats upon the waters, carrying the army of frost-giants and mountain-giants over the sea, and having the mighty giant Hrym as its helmsman. Loke too is now freed from his dark cave and strong chains, and comes to the scene as the leader of the hosts of Hel. The Fenriswolf advances and opens his enormous mouth. His lower jaw rests on the earth, and the upper touches the sky. It is only from want of room that he does not open his mouth still wider. Fire flashes from his mouth and nostrils. The Midgard-serpent, placing himself by the side of the Fenriswolf, vomits forth floods of venom that fill the air and waters. In the midst of this confusion, crashing, and devastation the heavens are rent in twain and the sons of Muspel come riding down the opening in brilliant battle-array. And now Surt, the same being that sent the heated blasts from Muspelheim into Ginungagap in the pre-chaotic world, and by whose might the drops of venom sent by Nidhug in Nifheim quickened into the giant Ymer, he who is from everlasting to everlasting, appears on the scene wrapped in flames of fire. His flaming sword outlines the sun. All the hosts here described come riding over the Bifrost bridge, that is the rainbow, which breaks beneath so great a weight. All this vast and glittering array direct their course to the great battlefield called Vigrid, and thus the evil forces on their part are ready for the final struggle.

Meanwhile Heimdal, on the part of the gods, blows his Gjallarhorn to arouse the gods, who assemble without delay. In his embarrassment Odin now for the third time in his life goes to the giants for advice. He rides to Mimer, where in his youth he had pawned his eye for knowledge, to consult him as to how he and his warriors are to enter into action. The answer is not recorded, but in the meanwhile the ash Ygdrasil begins to

quake and quiver, nor is there anything in heaven or on earth that does not fear and tremble in that awful hour. The gods and all the einherjes (i.e. those fallen in battle and brought to Valhal) don their armour, arm themselves and speedily sally forth to the field of battle, led by Odin, who is easily recognised by his golden helmet, resplendent cuirass, and his flashing spear Gungner. Odin places himself against the Fenriswolf as the foe most worthy of his steel. Thor stands by Odin's side, but can give him no assistance, as he must himself contend with the Midgard-serpent. Frey encounters the mighty Surd himself; but, though terrible blows are exchanged, Frey falls, and the Edda says he owes his defeat to the fact that he did not have that trusty sword which in his passion for a giantess he gave to his servant Skirner, when he sent him to ask for the hand of the charming giantess Gerd. In the last hour the dog Garm, which for ages had been chained in the Gnipa cave, also breaks loose. He is the most terrible monster of all, and he attacks the one-handed Tyr, who had sacrificed his right hand to get the Fenriswolf bound. Garm and Tyr kill each other. Thor gains great renown by dealing the deathblow to the Midgard-serpent with his mighty hammer Mjolner, but he retreats only nine paces before he too falls dead, suffocated by the flood of venom which the expiring serpent vomits forth upon him. The Fenriswolf with his enormous and wide-open mouth swallows Odin; but Vidar, Odin's son, immediately advances to avenge his father. He places his foot upon the wolf's lower jaw, the other he seizes with his hand, and thus tears and rends him till he dies. Vidar is able to do this, for he wears a shoe, for which materials have been gathered in all ages. It is made of scraps of leather cut off from the toes and heels in making patterns for shoes; hence, says the Edda, shoemakers should throw away such pieces if they desire to render assistance to the gods in the final conflict. Loke and Heimdal meet in a duel and become each other's slayers. The conflict is still raging with unabated fury, when the immortal god Surt flings fire and flame over the world. Smoke wreathes up around the ash Ygdrasil; the high flames play against the lurid heavens, and the earth consumed sinks down beneath the watery waste.

After Ragnarok comes a new world. The earth rises a second time from the sea, and is completely clothed in green. Sparkling cascades fall, over-arched by rainbows glistening in the sunbeams. The eagle soars on lofty pinion in pursuit of his prey. The gods risen from the dead assemble on the Ida plains and talk over the strange events of the past. The fields unsown yield bountiful harvest, all ills cease, and the gods live in peace. A new sun brighter and more resplendent than the former appears, and there is naught but beauty, plenty, and happiness.

The Scandinavian mythology has two heavens and two hells for humanity, a heaven and hell before Ragnarok, and a heaven and hell after Ragnarok. Before Ragnarok those fallen in battle or by the sword went to Valhal, to become einherjes, who took part with Odin in the first conflict on the plain of Vigrid. Those who died a straw-death (that is, from sickness or old age) went after death to the domain of Hel, and, though the Edda is silent on the subject, they probably fought on the side of Loke. But after Ragnarok there is a heaven called Gimle and a hell called Nastrand. Gimle is a hall more radiant than the sun; it is the uppermost realm, and in it the virtuous shall dwell for ever and enjoy delights without end. Nastrand is a place set apart for the wicked. The word means strand of corpses. It is situated far from the sun, in the lowest region of the

universe. It is a large and terrible cave, the doors of which open to the north. This cave is built of serpents wadded together, and the fanged heads of all the serpents turn into the cave, filling it with streams of venom, in which perjurers, murderers, and adulterers have to wade. Bloody hearts hang outside of the hearts of the damned. Their faces are dyed in gore. Strong-venomed serpent fangs fiercely pierce their hearts; and their hands are riveted together with red-hot stones. Their clothes wrapped in flames are not consumed, and remorseless ravens keep tearing their eyes from their heads. From this terrible cave the damned are, to increase their anguish, washed by the venomous floods into Hvergelmer, that fearful well in Niflheim, where their souls and bodies are subjected to even more terrible pains and woes; torn by countless clusters of serpents, and borne from agony to agony on the whizzing plumage of the primeval Nidhug, the dragon of the uttermost darkness. The Scandinavian mythology appears not to teach eternal punishment. There comes a mighty one to the great judgment, and makes Nidhug sink. In her last vision in Voluspa the vala points to a time when all that is evil shall be dissolved and washed away by the eternal streams of goodness. This is the last vision of the vala :

There comes the dark
Dragon flying,
The shining serpent
From the Nida-mountains
In the deep.
Over the plains he flies :
Dead bodies he drags
In his whizzing plumage.
Now must Nidhug sink.

Sophus Bugge has published an elaborate work, *Studier over de nordiske gude, og heltesagns Oprindelse* (German trans. by Professor Bremner, Munich, 1889), in which he attempts to trace the influence of Greek and Roman mythology and of Christianity on Scandinavian mythology. On the other hand, Viktor Rydberg, in his monumental work *Teutonic Mythology* (trans. into English by the present writer, London, 1889), has given an account of the mythology as it existed before it came in contact with and was modified by the Christian religion. The mythological materials in a more or less changed form have been largely augmented by Rydberg, particularly by his subjecting the mythic portions of the *Historia Danica* of Saxo Grammaticus to a most painstaking analysis. He has found the key to Saxo's method of turning myths and traditions into history, and by this discovery he has secured many new and important contributions to Scandinavian mythology. Rydberg shows that the Younger Edda is an unreliable record of the Odinic religion. He has also largely increased our stock of mythological materials by analysing, for the first time, the mythic fragments found in the old Norse literature outside of the Elder Edda.

See Finn Magnussen's *Lexicon Poeticum*, J. Grimm's *Deutsche Mythologie* (Eng. trans. by Stallybrass), Gudbrand Vigfusson's *Corpus Poeticum Boreale*, Laing's *Heimskringla* (new ed. by R. B. Anderson, 1889), N. M. Petersen's *Nordisk Mythologie*, P. A. Munch's *Norrøne gude, og Helte-Sagn*, Karl Simrock's *Deutsche Mythologie*, Wilhelm Mannhardt's *Germanische Mythen*, the present writer's *Norse Mythology* (5th ed. 1891).

Scania, the southernmost part of Sweden (q.v.).

Scansores. See CLIMBERS.

Scapegoat. See AZAZEL.

Scaphoid Bone (Gr. *skaphe*, 'a boat'), a term applied to two somewhat boat-like bones, of which one occurs in the carpus or wrist (see HAND), and the other in the tarsus of the Foot (q.v.).

Scapula. See SHOULDER.

Scapular (Lat. *scapula*, 'the shoulder'), a portion of the monastic habit, so called from its being worn upon the shoulders. It consists of a long strip of serge or stuff, the centre of which passes over the head, one flap hanging down in front, the other upon the back. The colour differs for different religious orders or congregations. Besides the scapular worn by the members of religious orders strictly so called, there exists also in the Roman Catholic Church a religious association or confraternity, the members of which, while living in the world and mixing in the ordinary life, wear, under the ordinary garb, two little pieces of cloth, connected by strings passing over the shoulders. The chief duties of this confraternity consist in the recitation of certain prayers, or the observance of certain religious or ascetical exercises in devotion to the Blessed Virgin. This pious association was founded in the first half of the 13th century by an English Carmelite friar named Simon Stock, and was said to have originated in a vision; but this story is now discredited even by Catholics, while they hold that the observance itself is an aid to piety.

Scarabæus (*Ateuchus sacer*), one of the dung-beetles (Coprophaga), well known for the zeal with which they unite in rolling balls of dung to their holes. The dung serves as food, and a beetle having secured a ball seems to gnaw at it continuously—sometimes for a fortnight—until the supply is exhausted. Sometimes an egg is laid in the ball and the parents unite in rolling this to a place of safety, above the level of the annual inundations. The genus is represented by about sixty species in the countries around the Mediterranean. By the Egyptians the scarabæus was venerated during its life, and often embalmed after death! Entomologists have recognised four distinct species sculptured on the Egyptian monuments, and gems of various kinds of stones were often fashioned in their image. Several mystical ideas were associated with the scarabæus: the number of its 'toes,' thirty, symbolised the days of the month; the time it deposited the balls containing the eggs was supposed to refer to the lunar month; the movement of the ball referred to the action of the sun on the earth, and personified that luminary. The scarabæus was supposed to be only of the male sex, hence it signified the self-existent, self-begotten, generation or metamorphosis, and the male or paternal principle of nature. In this sense it appears on the head of the pygmean deity, Ptah-Socharis Osiris, and in astronomical and sepulchral formulas; and Khepra was a scarab-headed god. The custom of engraving scarab gems passed from Egyptians to Greeks and Etruscans. An engraved scarab of carnelian is figured at GEM.



Engraved
Scarab.

See Rev. W. J. Loftie, *An Essay on Scarabs* (1884); and W. M. Flinders Petrie, *Historical Scarabs* (1889).

Scaramouch (Ital. *scaramuccia*, 'skirmish'), a character in the old Italian comedy, originally derived from Spain, representing a military poltroon and braggadocio. He was dressed in a sort of Hispano-Neapolitan costume, including a black *toque* and mantle, and a mask open on the forehead, cheeks, and chin, and always received an inglorious drubbing at the hands of harlequin.

Scarborough, the 'Queen of Watering-places,' in the North Riding of Yorkshire, 54 miles N. of Hull, 21 SSE. of Whitby, 43 NE. of York, and 233 N. of London. Backed by Oliver's Mount (500 feet), it rises like an amphitheatre round a beautiful sandy bay, protected on the north by a castle-crowned headland (300 feet), beyond which is the

quieter North Cliff. The South Cliff and the old town (below the Castle) are separated by a picturesque gully, which is spanned by the Cliff Bridge (1827; 414 feet long, 75 high), and, farther up, by the Ramsdale Valley Bridge (1865). Scarborough (A.S. *Skardeborge*, 'fortified rock') is an old place, for Harold Hardrada ravaged it in 1066, and in 1181 it received a renewal of an earlier charter; and it returned two members to parliament from Edward I.'s time till 1885, when the representation was reduced to one. The castle, now a shattered Norman keep, dates from 1136, but was rebuilt as a royal fortress by Henry II. It was captured by the Earl of Pembroke from Piers Gaveston (1312), by Bruce (1318), by the Earl of Westmorland from the insurgent Lord Stafford (1553), and twice by the parliamentarians (1644-48), besides being unsuccessfully besieged by Aske in the Pilgrimage of Grace (1536). Near it is St Mary's, the church originally of a Cistercian priory (1320). Transition Norman and Early English in style, with later additions, it suffered much during the siege of 1644, and was restored in 1848-50, at a cost of £7000. St Martin's (1862) is a good Early English structure, with windows by Morris. Other buildings are the splendid aquarium (1877), the museum (1828), the market-hall (1853), the huge Grand Hotel (1867), and the Spa (1880), the third on the site, whose two saline and chalybeate springs were discovered about 1620, and which has charming grounds. Scarborough was made a head port in 1840. The tidal harbour, with a lighthouse and a floating-dock, was formed between 1732 and 1850, and is enclosed by three piers, the longest and outermost curving 1380 feet; on the North Sands is a promenade pier 1000 feet long; and here, too, a promenade, nearly 4000 feet long and 24 wide, constructed in 1887-90 at a cost of £50,000, was opened by the Duke of Clarence. The jet manufacture is a speciality. The season lasts from June till the middle of October, when visitors pour in by thousands from every part of the kingdom. Resident pop. (1851) 12,915; (1881) 30,504; (1891) 33,776.

See works by Gent (1735), Hinderwell (3d ed. 1832), J. Brogden Baker (1882), and Haviland (1883).

SCARF. See STOLE.

Scarlatina, or SCARLET FEVER, is one of the group of diseases called Exanthemata (q.v.). In addition to the characters common to the group, scarlatina is almost always attended by sore throat, and the rash or eruption, which is of bright scarlet colour, commonly appears as early as the second day after the manifestation of the febrile symptoms, and is followed by very distinct desquamation of the cuticle. The period of incubation (see MEASLES) is very rarely more than a week; sometimes as little as twenty-four hours. Most writers on medicine make three varieties of this disease—viz. *S. simplex*, in which there are the fever and the rash, but only slight throat affection; *S. anginosa*, in which, in addition to the fever and the rash, the throat affection is the most prominent symptom; and *S. maligna*, a name which is applied to certain cases of extreme virulence, in which the system is at once overwhelmed by the force of the disease, or in which the symptoms disclose an extraordinary degree of weakness and want of vital power.

The disease begins with shivering, lassitude, headache, a frequent pulse, a hot dry skin, a flushed face, thirst, loss of appetite, and a furred tongue. Shortly after the appearance of the febrile symptoms the throat begins to feel irritable, and, on examination, is found to be red, and often more or less swollen. This redness becomes diffused over the interior of the mouth and the tongue. The rash on the skin begins in the form of minute red

points, which soon become so numerous that the surface appears almost of a uniform red. It first appears on the neck and breast, whence it gradually spreads over the trunk and extremities. The reddened surface is smooth to the touch, and the colour temporarily disappears on pressure of the finger. The eruption, in ordinary cases, is persistent for three or four days, after which it gradually disappears, and is usually gone by the end of the seventh day. The cuticle then begins to scale off in small bran-like scurf, or in flakes of various sizes. Specimens of an almost entire epidermic covering of the hand or foot, forming a natural glove or slipper, are of common occurrence in our pathological museums; but it is comparatively seldom that such perfect moulting takes place. The desquamative process is hardly ever completed till at least five weeks from the commencement of the disease, and may last considerably longer. The fever does not abate on the appearance of the rash, but continues in a more or less decided degree till that has faded; it is often attended by delirium.

Scarlatina anginosa presents in addition to the symptoms above described much more severe affection of the throat, with great pain and swelling. The inflammation is very apt to spread from the throat to the nose and ears: to the latter it is very destructive, life-long deafness often resulting in the case of those who recover from the fever. Sometimes a form of inflammation resembling, if not identical with, diphtheria supervenes; in other cases inflammation and suppuration invade the glands or other tissues in the neck.

Malignant Scarlatina is so terrible a disease that its characteristic symptoms require a brief special notice. The rash comes out late and imperfectly, and sometimes is hardly perceptible; or, having appeared, it may suddenly recede; and sometimes it is intermixed with livid spots. The pulse is feeble, the skin is cold, and there is extreme prostration of strength. In such a case as this death may occur (apparently from blood-poisoning) in a few hours. Other cases rapidly assume a typhus-like character.

Besides the dangers connected with the severity of the fever, and the results of the throat affection, the chief risk arises from inflammation of the kidneys. It is uncertain whether they become affected in all cases; in many there is no evidence that they are. But there are none in which the risk of this complication is absent; and it frequently supervenes in the mildest forms of the disease, if it has been unrecognised, or if due precautions have not been taken. It is essentially similar to catarrhal nephritis arising from other causes (see KIDNEYS), and may arise at any period till desquamation is completed, but most frequently in the second or third week of the disease. Rheumatic fever not unfrequently follows closely upon scarlet fever. Scarlet fever is rare in infancy and after thirty, most common between two and fifteen. But it is very apt to attack persons suffering from wounds and lying-in women exposed to the infection. It is common in Europe, whence it has been introduced into America and Australasia; but is rare in Asia, except Asia Minor, and Africa, except Algiers. In the tropical parts of these continents it is almost unknown; but in tropical America severe epidemics have often occurred.

Like all the exanthemata, scarlet fever occurs in epidemics; and nothing is more remarkable in the history of the disease than the extreme variations in severity in different outbreaks. Sometimes the mortality is almost nil; sometimes as many as 30 and 40 per cent. of those attacked succumb. It is undoubtedly caused by a micro-organism (see GERM THEORY); but the

nature of the organism has not yet been conclusively demonstrated. It is very contagious; as, however, the contagium is given off chiefly in the desquamated cuticle it is generally possible, if the patient can be isolated as soon as the disease is recognised, to prevent or greatly to limit its extension to others. On the other hand, the contagium retains its vitality with great persistence, and can be conveyed by letters, clothes, &c. Cases are on record where it has lain dormant in clothes for at least a year. Milk is a frequent vehicle for the disease; and it seems certain that in some epidemics it has acquired its infectious properties not from scarlet fever in man, but from a form of disease affecting milch cows.

Treatment.—No specific is known which can cut short the disease; the feverish state must be treated on general principles, by rest in bed, diluents, &c.; and in simple cases little more is necessary. Severe local symptoms or complications must be met as they arise; bad sore throat by application of Condy's fluid, boracic acid, or some other antiseptic with a brush or as a gargle, by chlorate of potash lozenges, by poultices applied externally, &c. A severe case of scarlatina anginosa will test to the utmost the patience and resource of both nurse and doctor; while scarlatina maligna usually defies all their efforts. In ordinary cases it is of the greatest importance to guard against chills. The patient should be confined to bed for at least a fortnight, and to his room till desquamation is completed. The application of carbolic oil, one to thirty, all over the body, is valuable for neutralising the poison in the skin, and preventing its diffusion; it is moreover generally soothing to the patient. Tonics, especially quinine and iron, are useful during convalescence. Strict isolation during the progress of the case, and careful disinfection afterwards, are of course essential.

In the early stage, before the appearance of the rash, scarlatina may be readily mistaken for several other febrile diseases; after the appearance of the rash the only disease with which it is likely to be confounded is measles, and we must refer to the article on that disease for a notice of the distinctive characters of the two affections. There is no complaint in which the final result is more uncertain than this, and the physician should give a very guarded opinion as to how any special case may terminate.

The popular delusion that *scarlatina* is a mild and diminutive form of *scarlet fever* should always be corrected, as the error, if uncorrected, may do much harm by leading to a disregard of those precautions which are always necessary in this disease.

Scarlatti, ALESSANDRO, composer and teacher of music, was born at Trapani in Sicily in 1659, and is stated to have studied music under Carissimi at Rome. There too, at the court of Queen Christina of Sweden, he produced in 1680 his first opera; he remained in her service, probably, until 1688. After acting as musical director at the court of Naples from 1694 to 1703, he returned to Rome to take up the duties of musical director to the church of Santa Maria Maggiore; but two years later he went back to Naples. There he conducted, one after the other, the three musical conservatoria, and became the founder of the Neapolitan school of musical composition. He died at Naples on 24th October 1725. A man of untiring energy, Scarlatti worked as composer, teacher, director, and player, and wrote a vast number of works, including nearly 120 operas, 200 masses, 10 oratorios, 500 cantatas, and innumerable motets, madrigals, and similar pieces. But, although he was so prolific, he was not a careless composer; on the contrary, he was a master of counterpoint and a fertile inventor of melodies (see OPERA, Vol.

VII. p. 608). The most celebrated amongst his pupils were his son, Durante, and Hasso. This son, DOMENICO (1683-1757), early distinguished himself as a composer of church music, and lived successively in Rome, London, Lisbon, Naples, and Madrid. In the history of music he figures as a clever writer of sonatas for the pianoforte, and as the author of various technical improvements in the writing and playing of pianoforte music.

Scarlet Fever. See SCARLATINA.

Scarlet Runner. See BEAN.

Scarlett, OLD. See PETERBOROUGH.

Scarlett, SIR JAMES, BARON ABINGER, an English barrister and judge, was born in Jamaica in 1769, but sent to England to be educated. After graduating at Cambridge, from Trinity College, in 1790, he chose to follow law, and entered at the Inner Temple. His fine personal appearance, backed up by an excellent knowledge of his profession, and by a quiet unassuming manner, soon secured him a large practice, especially as his pleadings began to have an extraordinary weight with the juries. He took silk in 1816, and from that time held the first rank on the northern circuit and in the law-courts at Westminster. In 1818-31 he sat in parliament as member for Peterborough. Canning in 1827 appointed Scarlett Attorney-general, when he was also knighted. He held that office, except for fifteen months, till November 1830. In 1834 Sir James was raised to the bench as Lord Chief Baron of the Court of Exchequer, and took his seat in the House of Lords as Baron Abinger. He died 7th April 1844.—**SIR JAMES YORKE SCARLETT,** General, G.C.B., second son of the above, was born in 1799, educated at Eton and Cambridge, entered the army, and was colonel of the 5th Dragoon Guards (1840-53). He was sent to the Crimea in command of the heavy cavalry, which he led in their famous charge of 15th October 1854. He afterwards commanded all the cavalry in the Crimea, and (1865-70) the Aldershot camp. He died in December 1871.

Scarpa, ANTONIO, anatomist (1747-1832), studied at Padua, and from 1783 to 1812 was professor at Pavia. He gained distinction by treatises on the anatomy of the nose, ear, and heart.

Scarpanto (anc. *Carpatho*), a long narrow island in the Mediterranean, belonging to Turkey, midway between Rhodes and Crete. It is 85 sq. m. in area, bare and mountainous; pop. 5000.

Scarron, PAUL, the creator of French burlesque, was born at Paris in 1610, son of a counsellor of Parlement, of good family and fortune. His mother having died early, his father married again, and not happily for the children. The step-mother's dislike of Paul's epigrams forced him at fifteen to leave the house, but at seventeen he returned to Paris, became an *abbé*, and gave himself up to a life of pleasure. About 1634 he paid a long visit to Italy, and soon after his return began to suffer from that terrible malady which racked him with tortures, and ultimately left him completely paralysed in his limbs. A mythical story used to be told how that he had first caught his disease, hiding in a swamp from the populace of Mans scandalised at an *abbé* appearing tarred and feathered at the carnival; but, as he had been seized with his disease half-a-dozen years before he obtained a prebend in Mans (1643), it is much more likely he owed it to the excessive debaucheries of his youth. After trying one physician after another, and spending about three years of decorous comfort at Mans, he gave up all hope of remedy, and returned to Paris to depend upon letters for a living. From this time he began to pour forth endless complimentary epistles in verse, sonnets,

madrigals, songs of drinking and of eating, and satires; in 1644 published *Typhon, ou la Gigantomachie*, a long jocose poem in five cantos describing the war of the Giants against the Gods; and next year made a still greater hit with his laughable metrical comedy, *Jodelet, ou le Maître Valet*, followed quickly by *Les Trois Dorothees, ou Jodelet souffleté* and *Les Boutades du Capitain Matamore et ses Comédies*—the last apparently never represented. The plots of these Scarron owed to the Spanish, and similarly the idea of his *Virgile Travesti* he borrowed from the Italian poet J. B. Lalli's *Enéide Travestita*. The first part of this famous work of Scarron's appeared in 1648; the whole included only eight of Virgil's books, and of these the first and fourth were translated into English, in all their coarseness and vigour, by a kindred spirit, Charles Cotton. In 1648 appeared also the popular comedy, *L'Héritier Ridicule*, which, it is said, the young king Louis XIV. liked so much that he had it performed twice in one day. During the struggle of the Fronde countless satires appeared against Mazarin, and one of the bitterest of these, entitled *La Mazarinade*, was ascribed to Scarron. On the cardinal's return to Paris in triumph the facile poet addressed him in terms of unmeasured flattery—'Jule, autrefois l'objet de l'injuste satire.' But he did not recover his pensions, although the famous Surintendant Fouquet made good the loss to the poor poet. Scarron was a consummate beggar, but he always did it like a humorist and without spleen or meanness. The exceptional sufferings of this 'living epitome of human misery' extenuate his ceaseless applications for relief, and the facility with which he accepted everything, money, books, a carriage, pies, poultry, puppies. His importunities were so jocular that they never estranged him from his friends, and he never lost his own kindness of heart, for we find him troubling his powerful friends for their good offices on behalf of others, as well as sheltering within his house two nuns thrown on the world through the bankruptcy of their convent—with one of these, Céleste Palaiseau, in earlier days he had been in love.

In 1651 appeared the first part of his famous work *Le Roman Comique* (2d part, 1657), intended as a reaction against the euphuistic and interminable novels of Mlle. de Scudéry and Honoré d'Urfé, then at the height of popular favour. It describes the adventures of a troop of strolling players in the provinces, and, loose and ill-constructed as it is, has the one surpassing excellence of the creative faculty, of bringing before us real men and women. It inspired Gautier's not altogether superior *Capitaine Fracasse*; but more important still, gave the impulse out of which sprang the masterpieces of Le Sage, Defoe, Fielding, and Smollett. The third part, which bears the title of 'Suite d'Offray,' was not the work of Scarron. All three were translated into English by Tom Brown, Savage, and others, and an abridgment by Goldsmith was published posthumously. Other works of Scarron's that deserve mention are the comedies, *Don Japhet d'Arménie* and *La Précaution Inutile*; his *Nouvelles Tragiques*, from one of which (*Les Hypocrites*) Molière took the idea of Tartuffe; and the poem, *Relation des Parques et des Poëtes sur la Mort de Voiture*, prefaced by a characteristically gay description of his own appearance and condition. Few men have had his sufferings, and fewer still his courage—'I hate no man, and could wish all the world had the same feelings for me; I am as blithe as a bird when I have money—and should be much more so were I in health; I am merry enough in company, and am quite happy when I am alone; I bear all my ills pretty patiently.'

The income he derived from his publisher—his

'Marquisat de Quinet'—his pensions, and the fruits of his dedications and his importunities enabled him to enjoy good living and to receive in the Hôtel d'Impécuniosité the visits of the greatest figures of the day in the world of fashion as well as letters. About 1650 he became filled with a desire to visit the islands of America, and actually journeyed as far as Tours in October—'I take my leave of burlesque verse, of comedies and comical romances,' wrote the brave-hearted cripple, 'to go to a happy climate, where there are no affected coxcombs, no canting rascals, no inquisition, no rheumatism to cripple any one, nor no confounded wars to starve me.' But this craze brought him to the strangest adventure of his life. One day a friend brought to his house a beautiful but penniless young girl of fifteen, Françoise d'Aubigné, who had been brought up at Martinique, and whose character remains one of the enigmas of history. The poet was enchanted with her, and in 1652 married her to save her from a convent. In the marriage contract, with characteristic buffoonery, he recognises her as bringing him a dowry of four louis, two large and very expressive eyes, a fine bosom, a pair of beautiful hands, and plenty of intelligence; while he on his part brought her immortality. 'The names of kings' wives die with them,' said he, 'that of the wife of Scarron will live for ever'—a strange prophecy, strangely to be fulfilled in the history of Madame de Maintenon. For eight years she waited on her poor husband with pious care, managed admirably his dubious finances, and brought an unknown decorum and refinement into his Bohemian household. Even his writings henceforward lose their grossness under that gentle influence; although indeed this can hardly be said of the earliest after the marriage, *Don Japhet*, which is prefaced by a dedication to the king, a masterpiece of begging without humiliation—'Sire, I will endeavour to persuade your Majesty it would not be very wrong to assist me a little, for if you did assist me a little I would be more jovial than I am; and if I were more jovial than I am I would write lively comedies; if I wrote lively comedies your Majesty would be amused by them; and if you were amused the money bestowed on me would not be lost. All this leads to such an inevitable conclusion that I imagine I should be convinced by it if I were a great king instead of being what I am, a poor wretched creature.' Death came at last to relieve the sufferer in October 1660, but he saw it come with anguish; his greatest sorrow, to leave his poor young wife behind in destitution. For a heart beat warmly in that feeble and distorted frame, and in his dying words we feel a penetrating pathos hardly hidden under an effort of irony: 'If there be a hell I have nothing to fear from it, having endured it in this world.' The eight verses of his own epitaph irresistibly touch the heart. Dead, he could lay aside the mask, and confess all that he had borne in silence—'Passer-by, tread lightly here, take care not to awake him, for it is the first night that poor Scarron sleeps.'

There are editions by Bruzen de la Martinière (10 vols. 1737) and by Baume (2 vols. 1877); of the *Roman Comique*, by Victor Fournel (1857) and A. France (1881). See Christian's *Étude* (1841); Morillot, *Scarron et le genre burlesque* (1888); André Le Breton, *Le Roman au Dix-Septième Siècle* (1890); an excellent article by Van Laun in the *Genl. Mag.* for April 1885; and Jusserand's introduction to a new edition of Tom Brown's translation of *The Comical Works of Scarron* (1892).

Scattery Island, an islet in the Shannon's estuary, 3 miles SW. of Kilrush, containing a fort, fragments of several small churches, and an ancient round tower 87 feet high. It was a sacred place in early Christianity—St Senan's retreat in the

6th century. At the southern extremity of the island stands a lighthouse, whose light, 50 feet above water, is visible 10 miles.

Scaup Duck. See POCHARD.

Scavenger's Daughter. See TORTURE.

Scawfell. See SCAFELL.

Scepticism (Gr. *skeptomai*, 'I consider') strictly denotes that condition in which the mind is before it has arrived at conclusive opinions—when it is still in the act of reflecting, examining, or pondering subjects of thought. Scepticism is therefore the opposite of dogmatism. The notion of 'disbelief' is quite a secondary meaning of the term. Among the Greeks a *skeptikos*, 'sceptic,' was a thoughtful, inquiring person. But inasmuch as the mass of men rush to conclusions with haste, and assert them with far more positiveness than their knowledge warrants, the discerning few of clearer vision are often brought into collision with popular beliefs—more especially in religion, the sphere in which popular beliefs are most numerous, most positive, and most inconsiderate—and are compelled, by the shock given to their reason, to 'doubt,' it may be to 'disbelieve' what is believed and affirmed by the multitude. Thus it is that in common parlance a sceptic has come to mean an infidel, and scepticism infidelity. But the field of thought in which scepticism properly so called exercised itself is not religion but philosophy. In philosophy too the word acquired a meaning different from doubt, or the negation of dogmatism; there was a distinct tendency on the part of those called sceptics to avoid coming to a conclusion one way or another. Philosophical sceptics in all ages and countries have not so much used doubt, like Descartes, as a philosophical instrument; they seem generally to have denied or at least doubted the trustworthiness of the senses as vehicles of absolute truth, and so have destroyed the very possibility of speculation. Pyrrho (q.v.) was the head of the first great school of professed sceptics; the Second Academy under Arcesilaus, and the Third under Carneades, were less thoroughly sceptical. The teaching of the Sophists (q.v.) was also sceptical in temper and tendency. In modern times David Hume represented advanced scepticism in philosophy (as well as in theology); and Kant's opposing philosophy, or a large part of it, has been made the foundation of sceptical systems. The doctrine of the Relativity of Knowledge (q.v.) taught by Hamilton and Mansel may easily be pushed to a highly sceptical extreme. Comte's positivism is in the metaphysical sphere even dogmatically sceptical; in Secularism (q.v.) there is a scepticism of indifference towards all theological and religious doctrine; while Agnosticism (q.v.) may fairly be described as combining most of the characteristic features of philosophical and theological scepticism.

See the articles referred to above; the histories of philosophy; Green's *Introduction to Hume's works*; Balfour's *Defence of Philosophic Doubt*; and Rev. J. Owen's three works on the Sceptics (1881-93).

Sceptre (Gr. *skeptron*, 'staff'), originally a staff or walking-stick, hence in course of time also a weapon of assault and of defence. At a very early period the privilege of carrying an ornamental sceptre came to be connected with the idea of authority and station. Both in the Old Testament and in Homer the most solemn oaths are sworn by the sceptre, and Homer speaks of the sceptre as an attribute of kings, princes, and leaders of tribes. The sceptre was frequently an ivory truncheon pierced with gold or silver studs. The sceptre of the kings of Rome, apparently derived from Etruria, and afterwards borne by consuls, victorious generals, and emperors, was of

ivory and surmounted by an eagle. The sceptre, which has varied much in form, has kept its place as a symbol of royal authority through the middle ages and down to the present time. The English Sceptre Royal, surmounted by a cross, is 2 feet 9 inches in length, and is of gold, richly adorned with precious stones. This is placed in the sovereign's hand at coronation. St Edward's staff, carried before the sovereigns at coronation, is of beaten gold, 4 feet 7½ inches long, with a foot or pike of steel and the orb and cross at the top. There are also in the English regalia a king's sceptre with the dove, a queen's sceptre with the cross, the queen's ivory rod (the sceptre of the consort of James II.), and another found in 1814, presumably that of Mary, consort of William III. See REGALIA.

Schadow, a family of Berlin artists, of whom three must be named. (1) JOHANN GOTTFRIED SCHADOW, a sculptor, was born in Berlin on 20th May 1764, received his best training in Rome (1785 to 1788), and was, on his return home, appointed sculptor to the Prussian court, and in 1805 rector (in 1816 director) of the Academy of Arts. He died at Berlin on 27th January 1850. Among his most important works were the quadriga on the Brandenburg gate in Berlin, statues of Frederick the Great for Stettin, Blücher for Rostock, Luther for Wittenberg, numerous busts of great Germans, and monumental tombs to General Taubentzen and Von Arnim. He wrote some books dealing with his art. See his *Briefe und Aufsätze* (1864).—(2) RUDOLF, son of the preceding, born in Rome on 9th July 1786, died there on 31st January 1822, was trained as a sculptor by his father, and, following the example of his brother (see below), renounced Protestantism for Roman Catholicism. His best works were a Spinning-girl, Achilles and Penthesilea, John the Baptist, and Virgin and Child.—(3) FRIEDRICH WILHELM SCHADOW-GODENHAUS, second son of the first-named above, was a painter, one of the 'Nazarete' school, to which belonged Overbeck (q.v.), Schnorr, and Veit. Born in Berlin on 6th September 1789, he proceeded to Rome in 1810, studied there the works of the old masters, came under the influence of Cornelius, Overbeck, and their associates, went over to Roman Catholicism (1814), and executed two frescoes for Bartholdy's villa at Rome. In 1819 he was called to be professor of Painting at the Berlin Academy of Arts, and in 1826 was appointed to succeed Cornelius as the head of the Düsseldorf school. He gathered round him enthusiastic pupils; indeed his gifts as a teacher were superior to his talents as a painter, although his 'Mignon,' the 'Wise and Foolish Virgins,' 'Heavenly and Earthly Love,' 'Heaven,' 'Purgatory,' and 'Hell' are admirable in their way. In 1859 he resigned the directorship of the Düsseldorf Academy, and on 19th March 1862 died in that town. He wrote *Über den Einfluss des Christenthums auf die bildende Kunst* (Düsseldorf, 1843) and an art romance, *Der Moderne Vasari* (1854). See Hübner, *Schadow und seine Schule* (1869).

Schafarik (*Szafarzik*), PAUL JOSEPH, Slavonic philologist and archaeologist (1795-1861). See BOHEMIA (LITERATURE).

Schaff, PHILIP, a learned Presbyterian theologian, was born at Coire in Switzerland, January 1, 1819, studied at Tübingen, Halle, and Berlin, and was already a *privat-docent* in the last university, when in 1843 he was called, on the recommendation of Neander, Tholuck, and Julius Müller, to be professor in the theological seminary at Mercersburg, Pennsylvania, of the United States German Reformed Church. Here he lectured for twenty years; and during the war he

lectured at Andover, Hartford, and New York. In 1869 he was called to be professor in the Union Theological Seminary, New York, and lectured there successively on Christian Symbolics, Hebrew, and Sacred Literature. One of the founders of the American branch of the Evangelical Alliance, he went as a delegate to its General Conferences at Basel in 1879 and Copenhagen in 1884. He attended as delegate also the meetings in London in 1875, out of which grew the Alliance of the Reformed Churches, the first General Council of which met at Edinburgh in 1877, the second at Philadelphia in 1880. He was president of the American Old Testament Revision Committee. He died 20th October 1893.

Of his many books the most important are a *History of the Christian Church*, in its enlarged form (12 vols. in the Edinburgh edition; 1882-94); *The Creeds of Christendom* (3 vols. 1877); *The Person of Christ* (1865); a *Bible Dictionary* (Phila. 1880); *Popular Commentary on the New Testament*, to which he himself contributed 'Matthew' and 'Galatians' (4 vols. 1878-83); and an enlarged edition of Lange's *Commentary on the Old and New Testaments* (25 vols. 1864-80). Besides these he edited the 'Philosophical and Theological Library,' including Ueberweg's *Hist. of Philos.*, Van Oosterzee's *Christian Dogmatics, &c.*; *The Religious Encyclopedia*, based on Herzog (3 vols. 1884), and (with Rev. S. M. Jackson) the supplementary *Encyclopedia of Living Divines* (1887); and 'A Select Library of the Nicene and Post-Nicene Fathers' (25 vols. New York, 1st series, 3 vols. 1886-89; 2d series, vols. i. and ii. 1890-91).

Schaffhausen, the most northern canton of Switzerland, is bounded on all sides but the south by the duchy of Baden. Area, 114 sq. m.; pop. (1870) 37,721; (1888) 37,876, of whom about 34,000 are Protestants. The chief river is the Rhine, which forms the southern boundary, and within the basin of which the canton is wholly included. The surface is hilly, especially in the north and east; of the many rich valleys that slope southward to the Rhine that of the Klettgau is famous for its fertility and for its wines. Agriculture is the principal branch of industry; grain, potatoes, fruits, hemp, and wine being the chief products. The great council is the governing body; it embraces one representative for every 500 citizens, chosen for four years. The executive is in the hands of a ministry of five persons chosen by the people for four years. The actions of the government are controlled by the optional referendum. The canton is simply the territory belonging to the town, which joined the Swiss confederation in 1501.

SCHAFFHAUSEN, the capital of the above canton, is beautifully situated on the right bank of the Rhine, above the celebrated falls, 31 miles by rail WNW. of Constance. Overlooking the town stands the curious castle of Munoth (1564-90), and this edifice, the cathedral (12th century), the Imthurneum (a concert and lecture hall), a library, and a museum are the chief buildings. The town is remarkable for the antique architecture of its houses. There is a statue to the Swiss historian Johannes von Müller, a native of the place. Pop. 19,320. The falls of Schaffhausen, about 3 miles below the town, form the grandest waterfall in the whole course of the Rhine (q.v.). They are utilised for electric and other factories, which turn out iron and other metals, arms, oil, flour, beer, spirits, soap, candles, wool, cotton, and agricultural machines.

Schäffle, ALBERT EBERHARD FRIEDRICH, political economist of the historical or evolutionary school, was born 24th February 1831 at Nürtingen in Würtemberg, studied theology at Tübingen, and, after spending some time on the editorial staff of a newspaper, became professor of Political Economy at Tübingen in 1861, and in 1868 at Vienna.

He had sat in the Würtemberg diet, and in 1871 was for a short time Austrian minister of commerce. In that year he returned to Stuttgart, devoting himself to literary labours. His chief works are *Die Nationalökonomie* (1861; 3d ed. with a new title, *Das Gesellschaftliche System der Menschlichen Wirtschaft*, 1873), *Kapitalismus und Sozialismus* (1870), *Quintessenz des Sozialismus* (1874; 8th ed. 1885; Eng. trans. 1889), *Grundsätze der Steuerpolitik* (1880)—besides the work cited at POLITICAL ECONOMY.

Schall, JOHANN ADAM VON, a Jesuit missionary to China, was born at Cologne in 1591, entered the Jesuit order in Rome in 1611, and was sent out partly in consequence of his knowledge of mathematics and astronomy to China in 1622. His fame as a scholar led to his being invited to the imperial court at Peking, where he was entrusted with the reformation of the calendar and the direction of the public mathematical school. The Emperor Shun-che, the founder of the Manchu dynasty (1644), showed him great honour and respect. Through this favour Schall obtained an edict for the building of Catholic churches and for the liberty of Christian preaching throughout the empire; and in the space of fourteen years the Jesuit missionaries are said to have made 100,000 converts. On the death of this emperor, however, a change took place; the edict was revoked, and Schall was thrown into prison and sentenced to death. He was afterwards liberated; but he was again imprisoned, and, at the end of a long incarceration, died August 15, 1669. He had acquired a perfect mastery of the Chinese language, in which he compiled numerous treatises upon scientific and religious subjects. A large MS. collection of his Chinese writings, amounting to 14 volumes in 4to, is preserved in the Vatican Library. In Latin he wrote a work *On the History of the Jesuit Missions in China* (Vienna, 1655).

See Mably's *Histoire Générale de la Chine*, and Huo's *Le Christianisme en Chine*.

Schamyl. See SHAMYL.

Scharnhorst, GERHARD JOHANN DAVID VON, the organiser of the Prussian army, was born on 12th November 1756, at Bordenau, the son of a Hanoverian farmer. At twenty he entered the army of Hanover, and he took part in the campaigns in Flanders of the years 1793-95. In 1801 he transferred his services to Prussia and was appointed director of the training-school for Prussian officers. Five years later he was wounded at Auerstädt and taken prisoner at Lübeck, but released in time to be present at the battle of Eylau. In 1807 he began the great work of his life: he was put at the head of the commission for reorganising the armies of Prussia. He reformed the army, introduced the short-service (Krümper) system, created a better spirit amongst both officers and men, and so converted what had been a mercenary force into a national army. It was principally by means of this new weapon that Germany was able to crush the great Napoleon at Leipzig six years later (1813). But before that event took place Scharnhorst was dead; he was wounded at Grossgörschen on 2d May 1813, whilst acting as chief of the staff of the Silesian army, and died on 28th June at Prague.

See *Life* by Lehmann (2 vols. Leip. 1886-87) and Klippel (3 vols. Leip. 1869-71)—the former rather an account of his public work than a biography—and the *Erinnerungen* of Von Boyen (1891).

Scharwenka, XAVER, pianoforte player and musical composer, was born at Samter near Posen on 6th January 1850, and was trained as a musician at Posen and Berlin. On the conclusion of his studies he began to teach in Kulluk's music

academy in Berlin; but since 1873 he has devoted himself to composing and concerts. In 1881 he started a music school in Berlin. His compositions, embracing trios, quartets, sonatas, concertos, 'studies,' and some famous Polish dance tunes, belong to the modern school.

Schässburg. See SEGESVAR.

Schaumburg-Lippe, a sovereign German principality, lying between Westphalia and Hanover. Area, 131 sq. m.; pop. (1890) 39,183. Agriculture is the chief occupation, though some coal is extracted. The people are mostly Lutherans. The prince governs with the help of an assembly of fifteen members, ten of whom are elected by the towns and the country districts, the rest by the prince, the nobility, and the clergy and educated classes. The state sends one deputy to the German Reichstag. Capital, Bückeburg (pop. 5088). The principality was founded by a member of the Lippe (q.v.) family, as the countship of Schaumburg, in 1640. The head of this branch of the family assumed the princely title in 1807.

Scheele, CARL WILHELM, chemist, was born on 19th December 1742, at Stralsund in Pomerania, then belonging to Sweden, and was apprenticed to a chemist at Gothenburg, and was afterwards chemist's assistant at Malmö, Stockholm, Upsala, and Köping (at the western end of Lake Mälär), and died at Köping, 19th May 1786. His whole life was devoted, with the absorbing passion of the lover of science and of nature, to chemical experiment and investigation. And, although his apparatus was very primitive and his means limited, he made a great number of discoveries of the utmost importance for the advance of chemistry. He discovered hydrofluoric, tartaric, benzoic, arsenious, molybdic, lactic, citric, malic, oxalic, gallic, and other acids. Chlorine, baryta, oxygen (1777), glycerine (1783), and sulphuretted hydrogen gas were all separated by him independently. He obtained the salts of manganese, and showed how manganese colours glass. The green pigment called Scheele's green, the arsenite of copper, derives its name from the chemist who first described it (see GREEN PIGMENTS), as does also the mineral scheelite or tungsten. He demonstrated in 1777 that the atmosphere consists chiefly of two gases, one, empyreal or fire-air (i.e. oxygen), supporting combustion, the other preventing it. This discovery of oxygen was made independently of Priestley's discovery three years before. In 1783 Scheele described prussic acid, which he proved to be the determining cause of the colouring matter in Prussian blue. He was a worker of wonderful accuracy, perseverance, and genius, and worked both analytically and synthetically. His papers were published in English by T. Beddoes (Lond. 1786), there being corresponding Latin, German, French, &c. editions; and in 1892 Baron Nordenskiöld published a number of his unedited letters and papers.

Scheffel, JOSEPH VIKTOR VON, German poet, was born at Karlsruhe on 16th February 1826, and was educated, at Heidelberg, Munich, and Berlin, to follow the law. But he always had a dislike to this pursuit, and after five years' work at it he gave it up. His interest was fixed upon the life of early and mediæval Germany, and his inclination towards literature was irresistible. As soon as he had shaken off the trammels of routine work, he hurried away to Italy and began to write. His first book, which he never surpassed, was *Der Trompeter von Sakkingen, ein Sang vom Oberrhein* (1854), a tale in verse of the time of the Thirty Years' War, steeped in the spirit of German romance, but as fresh in feeling as a May morning, and lightened with sly, genial humour; not the

least charming features of the book are its many songs and the humorous reflections of Hiddigeizei the Tom-cat. Its popularity is attested by the fact that the 190th edition appeared in 1891, or at the rate of more than five editions a year since it was first published. Scheffel's second book, a prose story of the 10th century, *Ekkehard* (1857), telling how the young monk of St Gall fell in love with the Duchess of Swabia whilst teaching her to read Virgil, also enjoys extraordinary popularity: the 120th edition was published in 1891. Ten years after *Ekkehard* appeared Scheffel sent out *Gaudevanus* (1867; 54th ed. 1891), a collection of songs and ballads, which are known to all German students, and sung everywhere throughout the Fatherland. Yet, curiously enough, Scheffel himself had no ear for music, and is said never to have been present at a concert in his life. His remaining books include two romances—*Hugideo* (1884), a tale of the 5th century, and *Juniperus* (1868), placed in the end of the 12th century, the era of the crusades and the heyday of chivalry—three collections of poems—*Frau Aecntiure, Lieder aus Heinrich von Osterdingens Zeit* (1863; 15th ed. 1883); *Bergsalmen* (1870; 4th ed. 1883), the visions of St Wolfgang, bishop of Ratisbon, seen in the solitude of his hermit's hut on the Salzburg Alps; and *Waldeinsamkeit* (1880), a dozen pictures of landscape-painting in words—and three or four short collections of posthumous *Gedichte* (1887-91). After his return from Italy Scheffel settled down in his native town, and died there on 9th April 1886.

See Life by J. Prölas (1887), by Ruhemann (1886), and Pilz (1887); also the *Erinnerungen* by Zornin (1886).

Scheffer, ARY, a painter, was the son of a German painter settled at Dordrecht in Holland, and was born there on 12th February 1795, studied under Guérin in Paris, and began his artistic career as a painter of genre pictures. But the Romanticism of the early 19th century captivated his fancy; he produced numerous pieces illustrative of Goethe's, Byron's, and Dante's works, such as 'Margaret at the Well,' 'Faust in his Study,' 'Mignon and her Father,' the 'Soldiers of Missolonghi,' the 'Suliot Women,' 'Francesca da Rimini,' 'Dante and Beatrice in Heaven,' and many others. Shortly after 1835 he turned to religious subjects, and painted (but did not always then exhibit) 'Christus Remunerator,' 'Christus Consolator,' 'The Temptation of Christ,' 'St Augustine and Monica,' &c. His best portraits were of the Duchess de Broglie, Prince Talleyrand, Queen Amélie, Liszt, Madame Viardot, Madame Guizot, La Fayette, Béranger, and Lamartine. He died at Argenteuil, near Paris, 15th June 1858. The pure and lofty expression he gives to his creations is a conspicuous feature of his work, which has been accused of sentimentality, and is inferior to that of many contemporaries in technique and execution. See *Memoir* by Mrs Grote (1860).

Scheldt (Lat. *Scaldis*, Fr. *Escaut*), a river that rises in the French dept. of Aisne, flows north past Cambrai and Valenciennes, and, entering Belgium, passes Tournai, Oudenarde, Ghent, Dendermonde, and Antwerp, having received among other tributaries the Lys, Dender, and Rupel. Arrived opposite the island of South Beveland, it divides into two arms. The left or southern, called the Wester Scheldt, flows south of the islands of Beveland and Walcheren, and meets the North Sea at Flushing; the northern or right arm, called the Ooster Scheldt, passes to the north of the same two islands. The river is navigable to Cambrai, 211 miles from its mouth and 56 from its source. From the middle of the 17th to the end of the 18th century the Dutch

monopolised the navigation of the lower Scheldt and levied tolls upon all foreign vessels sailing on its waters. When Belgium was separated from Holland in 1831 the rights passed to the former, though they were vainly disputed by the latter. Belgium in 1863 finally renounced her rights for an indemnity of three-quarters of a million sterling paid by the foreign nations using the Scheldt, Great Britain contributing £175,650.

Schellenberg, a village 9 miles S. of Salzburg, near the south-east border of Bavaria, was the scene of the first engagement in the war of the Spanish succession in which the English took part. Marlborough's army of 40,000 men drove an Austrian corps of 12,000 from the fortified heights above the village, after a short, fierce fight, on 4th July 1704.

Schelling, FRIEDRICH WILHELM JOSEPH (afterwards von Schelling), was born at Leonberg in Würtemberg, 27th January 1775; studied theology and philosophy at Tübingen; then (1796) science and mathematics at Leipzig; began his career as a teacher of philosophy in the university of Jena in 1798 as successor to Fichte, from which time he was, with Fichte and Hegel, one of the pioneers of post-Kantian speculative thought. In 1803 he married Carolina (1763-1809), the divorced wife of A. W. von Schlegel (q.v.). From 1803 to 1808 he was professor at Würzburg; then until 1820 secretary of the Royal Academy of Arts at Munich; again professor at Erlangen until 1827, when he returned to Munich to the new university there; and was finally called in 1841 by Frederick-William IV. to Berlin amid great expectation of results from his long-promised final, positive philosophy. He died at the baths of Ragaz in Switzerland, 20th August 1854.

Schelling's significance consists not in his being the founder of a philosophical system, but in his having by the force of his genius and prolonged fervid activity lived into and through the speculative questions of his day, condensing them into profound intuitions and thoughts which not only excited others to systematic thinking, but entered into the philosophical development as landmarks of speculation. His manifold productions may be grouped around the leading ideas of three distinct periods, the first of which extends from 1797 to 1800, when Schelling was under the influence chiefly of Fichte, and embraces the so-called 'Philosophy of Nature' and 'Transcendental Philosophy'; the second culminates in the 'Philosophy of Identity,' and falls between 1801 and 1803, Schelling's lights being then Spinoza and Boehme; the third and least valuable of the three represents the growth of what Schelling called his Positive (in opposition to the previous Critical or Negative) Philosophy, and may be traced as far back as 1809, when *The Inquiry into the Nature of Human Freedom* appeared. Schelling began as an adherent of Fichte's principle of the Ego as the supreme principle of philosophy: the Ego alone cannot be explained by anything outside itself; it posits itself and is conditioned only by itself—i.e. in its form and matter coincide; such are the ideas of his first production, *On the Possibility of any Form of Philosophy* (1795). In the next work, *On the Ego as Principle of Philosophy*, Schelling seems to make the transition to the Absolute Ego as the ground of the opposition between the Ego and Non-Ego, and thus arrives at the pantheism characteristic of the idealism of Fichte and Hegel. In the *Letters on Dogmatism and Criticism* (1796-98) he sets at naught Kant's arguments for the limitation of knowledge to phenomena, in laying claim to a 'secret wonderful faculty which dwells in us all' of beholding the transcendental ground of all

reality, which he calls 'Intellectual Intuition'—a conception to be associated with the Reason or faculty of ideas of Spinoza and Kant and Plato, and with the intuition of the mystics. This notable doctrine, though resting on some basis of psychological experience (such, for example, as the 'Consensus Gentium' talked of in theistic proof or the 'Faith' of Jacobi), is apt to be either vague or presumptuous; the former as it hardly admits of exact definition, and the latter as it is apt to look like a claim to a private view of truth which may not be enjoyed by everybody.

In the *Philosophy of Nature* writings, and in *The World-Soul* (1797-99), we find Schelling supplementing the Fichtian doctrine of the Ego or Absolute Ego, by showing that the whole of Nature may be regarded as an embodiment of a process by which Spirit tends to rise to a consciousness of itself—that in fact we may supplement Subjective Idealism by an Objective Idealism in which Nature is seen to be the other pole of Spirit, slumbering or petrified intelligence. We might therefore say: 'I is everything, because everything is I.' Because of this affinity with Spirit that Nature has we may, thought Schelling, construct a 'Philosophy of Nature'—i.e. we can say what Nature is prior to actual empirical research—and we find him trying to explain Nature by a logical manipulation of such opposites as Self and Not-Self, attraction and repulsion, and such principles as polarity, excitability, light, &c. The *System of Transcendental Idealism* (1800), one of the most important of Schelling's works, speaks of the two fundamental and complementary sciences, Transcendental Philosophy and Speculative Physics, which together constitute the whole of knowledge; the one starts with the Subjective and shows how the Objective belongs thereto, while the other shows how the Objective must become Subjective. Schelling about this time edited two journals, the one for *Speculative Physics*, and the other (with Hegel) the *Critical Journal of Philosophy*, which not only contain some important articles of his own, but express at a stage of white heat the movement of thought which can only be said to culminate in the stupendous system of Hegel. It is easy to see in the *Transcendental Idealism* the germs of the 'Philosophy of Identity.' If either Spirit or Nature conduct us to the unity which Philosophy seeks, the metaphysical ground of Being may be viewed as a supra-sensuous Identity that is above all difference: the Absolute as the unity of the Ideal and the Real is higher than either Spirit in itself or Nature in itself, and Spirit Philosophy and Nature Philosophy merge in Identity Philosophy, the theory of the One which is above dualism and multiplicity. Following Spinoza, Schelling teaches (*Method of Academical Study*, 1803; *Bruno*, 1803, &c.) that it is only the imagination and the reflecting Understanding which cause us to separate things or conceive them separately; Reason beholds all things in their totality or oneness; the Absolute is not only the unity of all contradictions, but the unity of unity and itself unendingness. We here see the roots of the Dialectic or Logic of Hegel, who, however, is careful to avoid, as the grave of thought, a mere formal identity (i.e. to say that the Absolute is that which is one with itself is to say practically nothing about it) and to set forth a unity which is concrete (i.e. a unity in which all variety persists and is not lost). Schelling differs though from Spinoza in keeping the process of development strongly to the fore as indeed the truth of the world ('In the beginning was the Act,' in Goethe's words), a most valuable side of his philosophy, linking it through disciples of his with the tremendous development of the historic method in

the 19th century; and again in tending to make *Spirit* the chief factor in the world process. In the Identity Philosophy Schelling repeats a good deal of the Natural Philosophy, and the weakest part of his system (only possible in the infancy of science) is his partly rational and partly fantastical and merely verbal construction of nature in the so-called *a priori* way.

The fact that Schelling could never describe to himself his Absolute save in the most formal way left his mind open to the influence of mystical speculation; he could never think exactly to himself how the finite arose out of its dark, infinite background, a question with which he occupied himself in the *Investigations into the Essence of Human Freedom*. In the latter treatise what he chiefly does is to translate into language of Reason such truths of Revelation as that of the Trinity, under which God the Father is seen to go out of Himself to the creation of a world; in some such way by an eternal act before all time man made himself what he is, and ever asserts his freedom until by another eternal act he unites himself to God, and thus brings the world back to God and becomes its Redeemer. The promised Positive Philosophy which was to advance beyond merely negative or critical philosophy came to be simply the philosophy of Mythology and Revelation. What Schelling objected to in the philosophy of Hegel was its attempt to extract all out of the Idea or Reason; there must be thought be something like Will, or Tendency, or Process to account for the illogical and finite aspect of some things, a fact which turned his mind to Nature as the forefront to Spirit, and connects his philosophy with the strange system of Schopenhauer, which is a pantheism of the Will, as Hegel's philosophy may be called a pantheism of the Idea, and Schelling's of the Spirit. It was in keeping with the mystical character of Schelling's mind that he should look forward to a Johannine church of the future rising over the ruins of Petrinism and Paulinism.

A full account of Schelling will be found in any of the larger histories of Philosophy, such as those of Erdmann (Eng. trans. by Hough, 3 vols. 1889) and Kuno Fischer. Morell, in his *History of Modern Philosophy*, is largely influenced throughout by Schelling, and gives, of course, an account of him. See also Watson's *Schelling's Transcendental Idealism* (Grigg's Classics, Chicago, 1883); A. Seth's *Kant to Hegel*; Frantz, *Schellings Positive Philosophie*; Hartmann, *Studien u. Aufsätze*; D. Marheinecke, *Criticism of Schelling's Philosophy of Revelation* (1843); Pfleiderer, *Philosophy of Religion*, vol. ii.; works on Schelling by Noack (1859), H. Becker (1875); and the biographical *Aus Schellings Leben: in Briefen*, ed. by Plitt (3 vols. 1870).

Schemnitz (Magyar *Selmeczbánya*), the oldest and most famous mining town of Hungary, stands in a narrow mountain gorge, 65 miles N. by W. of Pesth. Together with its suburbs it has 15,265 inhabitants, mostly Slovaks. The academy for mining and forestry, embracing collections of minerals and a chemical laboratory, is the principal building; there are also two castles and a pilgrimage church. A highly-esteemed tobacco-pipe is manufactured here and exported to America. The mines have been worked since Roman times, and produce gold and silver, copper and lead. The families of the miners make lace. Tobacco and violin strings are also made. Two-thirds of the mines are state property.

Schenectady, a city and county-seat of New York, on the Erie Canal and the south bank of the Mohawk River, 17 miles by rail N.W. of Albany. It is the seat of Union College (1795; since 1873, in virtue of the affiliation to it of law and medical schools at Albany, Union University), and contains machinery and locomotive works, stove-foundries,

woollen and flour mills, broom-factories, &c. Schenectady was settled by the Dutch in 1661. In 1690 the place was burned and 60 of the inhabitants massacred and 90 carried off by the French and Indians. Pop. (1890) 19,902; (1900) 31,682.

Schenkel, DANIEL, a learned and aggressive German theologian, born in Switzerland, at Dägerlen in Zurich, December 21, 1813. He studied at Basel and Göttingen, and had been successively *privat-docent* at Basel and pastor at Schaffhausen, when in 1849 he became professor of Theology at Basel. In 1851, through the influence of Ullmann and Umbreit, he was called to Heidelberg, where he died, May 19, 1885, shortly after retiring from his chair. Here also he had been both university preacher and Kirchenrath. In his youth almost orthodox and a vigorous antagonist of Swiss radicalism, he became a prominent leader of the famous *Protestantenverein*, a champion of ecclesiastical liberalism and of the rights of the laity. From 1860 to 1872 he edited in its interest the *Allgemeine Kirchliche Zeitschrift*, and with a yet wider propagandist aim he associated with himself a group of its liberal theologians in the preparation of a great *Bibel-Lexikon* (5 vols. 1869-75). His most important scientific work was *Das Wesen des Protestantismus aus den Quellen des Reformationszeitalters beleuchtet* (3 vols. 1846-51), in which he explains Protestantism as a task to be progressively realised rather than a system of doctrine or of church government. Its aim is more than to give a comprehensive scheme of dogma to the church and a key for the interpretation of divine revelation to the individual Christian conscience—it is to create a community of believers whose fellowship rests on the re-establishment of humanity through Jesus Christ. Further, in *Der Unionsberuf des evangelischen Protestantismus* (1855) he pointed out the substantial identity that underlay the differences between the Lutheran and the Reformed Confessions. His *Christliche Dogmatik* (2 vols. 1858-59) follows Schleiermacher in making conscience the spring of religion, the intellectual and the moral elements involved being but different aspects of its essence. In his famous book, *Das Charakterbild Jesu* (1864), he essayed a task for which his powers were inadequate. He attempts to construct the human character of Jesus in relation to his consciousness of the Messianic idea, and entirely eliminates the supernatural, the only miracles admitted—those of healing—being reduced to mere psychological cures. His Jesus is merely a sublimated modern radical reformer, and one over-addicted to rhetoric besides.

Other books of this voluminous writer were *Die Kirchliche Frage und ihre Prob. Lösung* (1862); *Die Grundlehren d. Christenthums aus dem Bewusstsein d. Glaubens* (1877); a Life of Schleiermacher (1868); *Christentum und Kirche* (1867); and *Das Christusbild der Apostel u. der Nachapostolischen Zeit* (1879).

Scherer, EDMOND-HENRI-ADOLPHE, a distinguished French critic, was born in Paris in 1815. His father was of Swiss extraction, and his mother was the daughter of a London banker settled in Paris. After receiving the elements of his education in Paris, he was sent to England to reside with a dissenting minister, the Rev. Thomas Loader of Monmouth. During his two years' residence Scherer acquired a knowledge of the English language, which he turned to excellent account in his subsequent career as a literary critic. At this time also he became so deeply influenced by religious feelings that it was his strong desire at once to begin theological studies with a view to entering the church. By the desire of his parents, however, he returned to Paris, and during the next three years he completed his studies in literature and law. In 1838 he went to Strasburg, where he

qualified himself for the ministry of the Protestant Church. Discovering that preaching was not his true function, he accepted the professorship of Exegesis in the Oratory at Geneva (1845). In Geneva he was closely associated with Vinet in his advocacy of a severance between church and state, expounding his views in *La Réformation au XIX^{me} Siècle*, a journal of which Scherer himself was editor. Gradually, however, he drifted away from his early faith, and in 1850 he was finally expelled from the church. For the next ten years he still lived in Geneva, mainly occupied in religious controversy. In 1860 he left Geneva for Paris, where he at once found ample scope for his powers in literary and political criticism. Besides being a regular contributor to *Le Temps*, he also acted as French correspondent to the *Daily News*, and sent occasional communications to different American papers. In 1871 he was elected representative for the department of Oise-et-Marne, and attained considerable distinction as a practical politician. He died in Paris, 16th March 1889.

By the solidity and extent of his knowledge, his severely logical method, and the range of subjects he has treated Scherer takes a high place among modern literary critics. His distinctive character as a critic lies in his combination of the qualities of the trained thinker and scholar with a keen susceptibility to the most diverse products of creative effort. His defects appear in a certain lack of elasticity and flexibility, partly due to his early training and partly to a naturally rigorous cast of mind, which disposes him to undue severity where he cannot sympathise.

See *Edmond Scherer*, par Octave Gréard of the French Academy (1890), and the Introduction by Mr Saintsbury to *Scherer's Essays on English Literature* (1891). Scherer's chief works are *Mélanges de Critique Religieuse; De l'État actuel de l'Église Reformée en France; Alexandre Vinet et ses Ecrits; Etudes Critiques sur la Littérature Contemporaine* (9 vols.); *Mélanges d'Histoire Religieuse; Melchior Grimm*.

Scherr, JOHANNES, historian, novelist, and writer of humorous prose and verse, was born 3d October 1817, at Reclberg in Swabia, studied at Zurich and Tübingen, and became a schoolmaster at Stuttgart. In 1844 he came to be known in act and writing as a strong democrat, and in 1848 was a member of the Würtemberg diet. In 1849 he fled to Switzerland, where in 1860 he obtained a post as lecturer in the Zurich Polytechnic. He died 21st November 1896. He wrote a universal history of literature, and histories of religion, of English literature, of German manners and customs, a whole series of romances and novels, and various miscellaneous works in prose and verse. He was vehement and one-sided in polemics; and his lively wit and caustic humour, though they give vivacity to a very characteristic and original style, are extravagant and overstrained.

Scherzo (Ital., 'jest,' 'sport'), in Music, a term applied to a passage or movement of a lively and sportive character, forming part of a musical composition of some length, as a symphony, quartet, or sonata.

Scheveningen, a fishing-village and seaside resort in South Holland, is situated on the North Sea, about two miles NW. of the Hague. Pop. 7980. It is visited by the aristocracy of Holland for sea-bathing, there being an excellent 'bath-house,' numerous villas, and hotels, and, during the season, all the gaieties and amusements of a fashionable watering-place. A range of sandhills protects the village from the sea. The road from the Hague to Scheveningen passes beneath an avenue of fine trees and wooded banks, with a tramway for passengers and goods. Off Scheven-

ingen the Dutch fleet was defeated, and its admiral Tromp killed, by the British under Monk on 8th-10th August 1653.

Schiedam, a town in South Holland, 2½ miles W. of Rotterdam, and close to the Maas. It is known the world over as the place where Hollands gin is made, in some 300 distilleries. Large numbers of pigs and cattle are fed on the refuse grain in the surrounding country. There is a large shipping trade, some shipbuilding, and cooperages, malt-kilns, &c. Pop. (1870) 18,854; (1890) 25,260.

Schiehallion. See PERTSHIRE, and MASKE-LYNE.

Schiller, JOHANN CHRISTOPH FRIEDRICH, German poet and dramatist, was the son of an army surgeon, a man of deep religious feeling and strict conscientiousness. His mother was a woman of gentle disposition, true humility and piety, and some poetic feeling. Fritz was born at Marbach on Neckar on 10th November 1759, and inherited the distinguishing traits of both his parents. He was brought up amid the vine-clad hills of Marbach, beneath the ancestral castle and monastery of the Hohenstaufens at Lorch, and at Ludwigsburg, the Versailles of the Dukes of Würtemberg. Besides learning Latin and Greek at the grammar-school of Ludwigsburg, Schiller was carefully educated, especially in religious matters, by his father, whose ambition it was to make him a pastor. But destiny in the person of Duke Carl Eugen decreed otherwise. This Würtembergian imitator of the 'Grand Monarch,' who set up to be the father of his people, established in 1773 a school at his castle of the Solitude, near Ludwigsburg, for the purpose of training army officers and servants for the public service. Captain Schiller, who was at that date superintendent of the ducal forests and gardens around the Solitude, was given to understand that the duke wished to enrol his clever son Fritz amongst the first pupils of his new institution. Accordingly the boy turned to law instead of to theology; and at the ducal school (moved to Stuttgart in 1775) was kept under a rigid discipline, partly military, partly monastic. About 1776 Schiller, tired of law, which he never liked, threw it up for medicine, which he liked very little better. It was not long after this that, principally through reading Klopstock's *Messias*, he became conscious of his own poetic powers. From the first he conceived a decided fancy for tragedy; and now, instead of studying medicine, he spent most of his time in reading and writing poetry and tragedies, although both occupations were strictly forbidden by the duke. In philosophy also he took a more than ordinary interest, and this taste remained with him to the end of his days. The duke was very proud of his clever protégé, and on 14th December 1779, in the presence of Goethe and Duke Carl August of Weimar, was delighted to bestow upon him three medals for excellence in his medical studies; for Schiller had at last worked hard to qualify himself for leaving the Carl's School, and so becoming master of himself.

Exactly one year after Goethe's visit Schiller left school, and was appointed surgeon to a Würtemberg regiment. One month later (13th January 1782) his play *Die Räuber*, begun in 1777, was put on the stage at Mannheim. People took their seats at noon, five hours before the performance began, and the piece made a tremendous sensation—being full of the revolutionary sentiments with which the air was charged previous to the outbreak of the French Revolution. Young Schiller had breathed the spirit of such 'storm and stress' productions as Goethe's *Götz*, and the ideas of the eccentric C. F. D. Schubart; moreover, he had

drunk deeply at the wells of Plutarch's hero-ship and Rousseau's overwrought sentimentalism. The play itself, however, in spite of the gravest faults—gross crudities, improbabilities, exaggerated and unreal sentiment, inflated and bombastic diction—literally throbbled with energy and passion, and contained many passages of remarkable tragic force. Schiller himself was present at the performance; but because he quitted Stuttgart a second time without his ducal leave Carl Eugen had the aspiring dramatist arrested, and on his release forbade him both to write plays and to leave Würtemberg. This treatment Schiller's pride, as writer and as man, would not brook; so on the night of 22d September he fled from the capital in disguise, and under an assumed name (Dr Ritter). He lay concealed at Mannheim and at Oggersheim, and latterly on Frau von Wolzogen's estate of Bauerbach near Meiningen. In that quiet retreat he finished two more plays, *Die Verschwörung des Fiesco zu Genua* and *Kabale und Liebe*. The structural idea of the former, Schiller's first historical play, printed in 1783, is that of nearly all his historical works, a revolt against some constituted authority that has degenerated into tyranny and become an enemy of freedom. The latter (1783) is a protest, dramatically a more successful work than *Fiesco*, against the tyrannies of social convenience, involving an attack upon the court life of the typical German ruler of the epoch.

On 1st September Schiller was appointed dramatist to the Mannheim theatre, and thought he had reached his port. But at the end of the year the engagement was not renewed; neither intendant, nor dramatist, nor actors were satisfied one with another. Thus Schiller was again thrown on his own resources; and from the time he left Stuttgart until he settled in Weimar he was always in debt and always struggling with narrow means. One of his plans of self-support was the issue of a sort of theatrical journal, *Die Rheinische Thalia*, begun in November 1784, and written almost entirely by his own hand. In this journal were first printed most of his *Don Carlos*, many of his best poems (e.g. *An die Freude*), and the stories *Verbrecher aus Verlorener Ehre* and *Der Geisterscher*. In 1785 he resolved to depart from Mannheim, and to accept a warm invitation from a circle of admirers in Leipzig, which included, he found, Göschen the publisher (grandfather of the English statesman) and Körner, father of the poet.

Schiller had not been without his love affairs: he had known the pangs of jealousy in connection with Frau von Wolzogen's daughter, he had paid suit to Margareta Schwann, the publisher's daughter in Mannheim, and he had been half fascinated by Charlotte von Kalb, perhaps the most remarkable woman of her generation in Germany. At Dresden, where Körner was living, Schiller found the rest he so much needed, rest from emotional excitement and rest from pecuniary worries. And this rest, which he owed in great part to Körner's generosity, he turned to good account. He finished *Don Carlos* (1787), which may be called his first mature play, in that the enthusiasm is more chastened, the language more sober and disciplined, the plot better elaborated, and the knowledge much riper. Nevertheless it suffers artistically from its excessive length, from its inherent lack of unity, and more especially from the shifting of the interest from Carlos to the Marquis Posa. The play was written in blank verse, as being more appropriate to the dignity of the subject: and besides embodying Schiller's ideas of a perfect political society, it presents a most noble type of the true friend of man in Posa. From the day he first saw Körner he shared with him nearly all his thoughts, and continued to do so after he left Dresden and be-

came intimate with Wilhelm von Humboldt and Goethe. Amongst the finest fruits of his discussions with Körner and his circle are the poems *An die Freude* and *Die Künstler*. Under the stimulus of the same society he went back to his old love philosophy, and at the same time began to study history in a serious and systematic way. After two years in Dresden something of the old restlessness took possession of him again, caused in part by another unhappy love affair (with Henriette von Arnim), and he thought to allay it by a visit to Weimar and elsewhere. But of Weimar and its court circles the truth-loving poet soon grew tired—Goethe and Duke Carl August were both absent at the time. Nevertheless he stayed on awhile, finding society in Charlotte von Kalb, in Herder, and certain of the professors at Jena near by. One of these, Reinhold (Wieland's son-in-law), brought Kant to his notice; and Schiller steeped himself in the thoughts of the Königsberg recluse with his usual ardour, though he greatly modified Kant's system ere he adapted it for his own use. About the same time he met his future wife, Charlotte von Lengefeld; and, getting some hints of a possible chair at Jena, he resolutely bent his mind to the writing of a work of more practical value, and began his history of the revolt of the Netherlands. In the end of 1788 he was appointed to a professorship at Jena, and, being further granted a small pension by the Duke of Saxe-Weimar, he married Lotte von Lengefeld. In order to meet the responsibilities entailed by these changes Schiller worked terribly hard, so hard in fact that he eventually broke down his health. Besides lecturing, he wrote a number of minor papers and the greater work, the history of the Thirty Years' War. These productions are not of course the outcome of a prolonged or exhaustive course of special studies; but they rank high amongst German historical writings by virtue of their great merits of style, the warm human interest the writer has breathed into them, and the broad philosophic ideas that form their life and substance.

Towards the end of the year 1792 Schiller was agreeably surprised by the offer, brought about chiefly by his admirer, the Danish poet Baggesen, of a free gift of 3000 gulden from the Duke of Augustenburg and his friend Count Schimmelmann. The first use the now invalid poet made of his freedom was to finish the Thirty Years' War, and his next to pay a visit to his old father and mother, whom he had not seen for eleven years. In the year of this visit (1793) he began the *Briefe über die aesthetische Erziehung des Menschen*, letters of noble and weighty import concerning the function of art as the supreme educative agent. At this period, in the irony of circumstances, it came into the heads of the French revolutionists to nominate Schiller (M. Gille) an honorary member of the republic, a distinction which, although himself a man of democratic sentiments, he spurned with horror on learning of the execution of the king. The diploma of citizenship took five years to reach him (1798).

The year 1794 is in some respects the most important in the whole course of Schiller's life: he made the acquaintance of Fichte, he formed an intimacy with Wilhelm von Humboldt, and began his wonderful friendship with Goethe. He was introduced to the great poet at his future mother-in-law's house in the summer of 1788; but for a while they were both distant and reserved, and it was only in the course of a chance conversation at Jena in the summer of 1794 that they discovered common ground of sympathy. The ice once broken, however, they soon drew together; the dreamer and idealist and the man of universal human interests had both worked their

way from entirely opposite starting-points to pretty nearly the same conclusions. Both regarded art as the crowning-stone of human culture, as in fact the best practical religion, and both thought and wrote in the spirit of that conviction. The year 1794 is marked in Schiller's career by two other events: he composed the essay *Ueber Naive und Sentimentale Dichtung*, in which the respective characters of ancient (classic) and modern poetry were for the first time clearly defined and discriminated; and he started the magazine *Die Horen*, which died after a precarious existence of three years. But it gave birth to the much more celebrated *Xenien* (1797), a collection of satirical epigrams, written by Schiller and Goethe conjointly, and aimed at all who, in their estimation, did not pay fit and proper reverence to Art, and its object Beauty. Schiller's intercourse with Goethe had reawakened his poetic instincts, and he once more began to write poems, at first pieces of a reflective and lyric character, principally for his annual *Die Musenalmanach* (another bread-winning project), such as *Die Macht des Gesanges*, *Die Ideale*, *Würde der Frauen*, *Der Spaziergang*, and so forth, and later, mostly in his garden-house at Jena during the years 1797 and 1798, the matchless ballads (*Kraniche des Ibykus*, *Der Handschuh*, *Der Taucher*, *Ritter Toggenburg*, &c.) that in the estimation of many constitute his principal contribution to literature, and that certainly make him the favourite beyond all other poets of the German people. And, under the same stimulus, he went back to the drama, and spent many a long night on the finishing of *Wallenstein* (1798-99), in spite of the fact that every hour's writing cost him several hours' suffering. This play (embracing the trilogy *Wallenstein's Lager*, *Die Piccolomini*, and *Wallenstein's Tod*), which Carlyle declares to have been 'the greatest dramatic work of which the 18th century can boast,' is in every way a remarkable advance on *Don Carlos*. It is built on a wider and truer estimate of human nature, displays a juster conception of the limits and possibilities of dramatic composition, and attains a happier, loftier harmony of the poetic and dramatic ideals; and, especially on account of the magnitude and masterly arrangement of the action, the character of Wallenstein, and the pathetic love-story of Max Piccolomini and Thekla, ranks as one of the greatest, if not the very greatest, of all plays in German literature.

In 1799 Schiller settled in Weimar—he had never lectured since 1793—in order to be nearer the theatre and close to Goethe, whom he zealously supported in his efforts to elevate the German stage into an influential engine of culture. In quick succession he finished *Maria Stuart* (1800), *Die Jungfrau von Orleans* (1801), *Die Braut von Messina* (1803), and *Wilhelm Tell* (1804). The first named, whilst not exactly answering the expectations of the English reader, is nevertheless an admirable drama. Mary, the heroine, is represented as an erring, but repentant and lovable woman, whose character shines out all the more beautiful from contrast with her cold and selfish cousin, Elizabeth; and the play contains several fine passages, descriptive and dramatic. *Die Jungfrau* is artistically one of Schiller's most successful performances; Joan of Arc, the principal character, is drawn as a lovely and innocent maiden inspired with the spirit of the prophesies—a deeply religious and ideally beautiful conception well carried out. *Die Braut von Messina* was confessedly an experiment, and, it is universally admitted, an unsuccessful experiment, at combining the ancient and the modern ideals of dramatic excellence, more especially by the introduction of the choros as the principal supporter of the action.

Tell, however, is a noble piece of work, in spite of some technical defects (principally the lack of a central character and of a progressive concentration of the dramatic interest). All the *dramatis personæ* are thoroughly human and are cleverly put before us, and there are many fine descriptions of Swiss landscapes; but the finest thing of all is the unquenchable spirit of freedom that pulses in every line. This was the last drama Schiller lived to finish, though he left others in various stages of completion, *Warbeck* and *Demetrius* being the most advanced. His health, long enfeebled, finally and suddenly broke down; he died on the 9th May 1805, still a comparatively young man, in the prime of his intellectual activity.

Schiller's life was one long struggle against pecuniary difficulties, greatly aggravated at times by the most uncongenial surroundings, and latterly by ill-health. Yet through all he remained true to himself and to his high calling. He pressed ever strenuously forward along the path of knowledge and self-culture, and his literary career is an advance from crude elemental strength to finished and matured art. Personally, in spite of the drawbacks and hindrances of his outward situation, his character and conduct were of the noblest: he made it his constant end, deliberately chosen, to try and carry out in his own daily life the loftiest ideals he believed in, and strove to 'live like a man whom the world would be sorry to lose.' The key to his speculative ideas, especially with respect to art, is contained in the high and reverential regard he paid to moral beauty. That is the chief cornerstone of his æsthetic creed and of his principles of action. He had an enthusiastic admiration for what is noble and grand and magnificent, and this passion enters into the structure and substance of nearly all his writings. Two other great qualities ring through his works, an incorruptible love of truth and a lofty spirit of freedom. His poetic strength lay in a peculiar blending of moral and intellectual force. As a lyric poet he can hardly be accounted as of the first rank: he lacked not only the spontaneity but also the immediate insight and sympathy with the actual world, and the living men and women in it, that in so eminent a degree distinguished his greater friend and contemporary Goethe. As a dramatist, however, he undoubtedly stands first of the Germans, and must justly take a high rank amongst the dramatic writers of the world.

The standard editions of his works are those by Gödeke (17 vols. Stutt. 1868-76), Kurz (9 vols. Hildburghausen, 1868-69), and Boxberger (8 vols. Berlin, 1882). All preceding lives of Schiller have been superseded by Minor's (4 vols. Berlin, 1890 *et seq.*). See also the longer works of Weltrich (Stutt. 1885 *et seq.*) and O. Brahm (Berlin, 1888 *et seq.*). Of the earlier biographies the best were those by Hoffmeister and Viehoff (5 vols. Stutt. 1875), Palleke (2 vols. 12th ed. Stutt. 1886), Düntzer (Leip. 1881), Scherr (4th ed. Leip. 1865), Caroline von Wolzogen (5th ed. Stutt. 1876), Schwab (3d ed. Stutt. 1859), and Hepp (Leip. 1885). Schiller's *Briefe* (2 vols. 1846) and his *Correspondence with Goethe* (2 vols. 4th ed. 1881), Körner (4 vols. 2d ed. 1874), W. von Humboldt (2d ed. 1876), Lotte (his wife) and her sister (3d ed. 1879), and others contain abundance of biographical matter. There are biographies in English by Carlyle (Lond. 1825), Bulwer-Lytton (Edin. 1844), J. Sime (Edin. 1882), 'Foreign Classics for English Readers', and H. W. Nevinson (Lond. 1889, 'Great Writers' series), and English translations of Palleke (Lond. 1860) and Düntzer (Lond. 1883). Various English writers have published translations of Schiller's works in whole or in part; the versions of poems by Bulwer-Lytton (1844), Merivale (1844), Bowring (1851), and Lord Lytton (Lond. 1887), and of the dramas Coleridge's *Piccolomini* and *Wallenstein's Death* deserve special mention. The Schiller museum was united with the Goethe museum (*Archiv*) at Weimar in June 1889.

Schilling, JOHANNES, German sculptor, was born at Mittweida in Saxony, on 23d June 1828, and was trained in Dresden and Berlin. In 1853 he went to Italy, having won a three years' travelling scholarship. In 1868 he was elected a professor of the Academy of Fine Art in Dresden, where he had been settled since his return from Italy. His first great work was the four groups of the Seasons for Dresden; for that city he also executed monuments of Rietchel the sculptor and King John of Saxony, and the colossal Dionysus and Ariadne in bronze for the Royal theatre. His masterpiece is the national monument of Germania on the Nieslerwald (q.v.), commemorative of the war of 1870-71. Besides numbers of frescoes and similar ornamental works, he has also turned out monuments of Schiller (for Vienna) and the Emperor Maximilian (for Trieste), and a war memorial for Hamburg.

Schimmelpenninck, MARY ANN, was born in Staffordshire, 25th November 1788, the daughter of a Quaker manufacturer named Galton. After her marriage in 1805 to Mr Lambert Schimmelpenninck, she lived at or near Bristol; in 1818 joined the Moravian body; and, having suffered from paralysis since 1837, died at Clifton in August 1856. Her nine works, published between 1813 and 1860, include two on Port Royal, a *Theory of Beauty, Sacred Musings*, and an *Autobiography*.

Schinkel, KARL FRIEDRICH, a German architect, was born at Neuruppin in Brandenburg, March 13, 1781, and studied the principles of drawing and design at Berlin. In May 1811 he was elected a member of, and in 1820 a professor at, the Berlin Royal Academy. He died October 9, 1841. The designs to which he chiefly owes his reputation are those of the Museum, the Royal Guard-house, the Memorial of the War of Liberation, the New Theatre, the New Potsdam Gate, the Observatory, the Artillery and Engineers' School, all in Berlin, the Casino in Potsdam, another at Glienicke near Potsdam, and a great number of castles, country-houses, churches, and public buildings. His designs are classic in feeling, noble, harmonious, and dignified. He also excelled as a painter, and as a designer of monuments and of furniture. His designs and sketches were published in *Sammlung architektonischer Entwürfe* (174 plates, 1857-58), *Werke der höheren Baukunst* (25 plates, 1873), *Grundlage der praktischen Baukunst* (2 vols. 1835), and *Sammlung von Möbelentwürfen* (16 plates, 1852). See *Life* by Kugler (1842), by Quast (1866), and by Dohme (1882).

Schinus, a genus of trees and shrubs of the natural order Anacardiaceæ, natives of South America. The leaves so abound in a resinous or turpentine-like fluid that upon the least swelling of the other portions of the leaf by moisture it is discharged from the sacs which contain it. Thus they fill the air with fragrance after rain, or if thrown into water start and jump about as if alive, discharging jets of this peculiar fluid. A sort of honey and also a kind of vinegar is made by the Peruvians of the fruit of *Schinus mulli* (Peruvian mastic), and they also make a vinous drink from it by boiling. A resinous gum exudes from the stem which is of the nature of mastic. The fresh bark of *S. aroeiri* is employed by the Brazilians to coat newly-made ropes with, to which it gives a very durable dark-brown covering. It is said to be dangerous to sleep under its shade, causing painful swellings. The same phenomenon is exhibited by the leaves of some species of the kindred genus *Durvaia*, of which specimens are occasionally to be seen in our greenhouses. The leaves and twigs when bruised have a very strong odour of turpentine.

Schipka. See SHIPKA.

Schipperke (Flemish, 'little skipper'), the name of a breed of dogs that has recently become familiar at dog shows, belonging to the same group as the Eskimo and Pomeranian dog, but with almost no tail. They are favourites of the Belgian bargees, and from them have derived their name.

Schism, ecclesiastical division in a church or separation from a church; as also the tendency to promote such division. The Great Schism or Greek Schism is the separation of the Greek Church (q.v.) from the Latin: the temporary Western Schism is dealt with at ANTIPOPE, POPE.

Schist (Gr. *schistos*, 'split') is a term properly applied to crystalline rocks with a foliated structure (see FOLIATION), as mica-schist, hornblende-schist, &c. Indurated clay-rocks with a fissile structure are sometimes erroneously described as schists. For the schistose rocks, see PETROGRAPHY and GEOLOGY.

Schizomycetes ('fission-fungi'), a botanical term for Bacteria. It refers to their commonest mode of reproduction—by transverse division. The term Schizophyte is also synonymous with Bacteria. The advantage of the term Schizomycetes is its harmony with similar terms—Saccharomycetes, Zygomycetes, Ascomycetes, &c.—applied to other sets of fungoid plants. See BACTERIA.

Schlagintweit, the name of five brothers who all distinguished themselves as travellers or as writers on sciences allied to geography. Three of them—HERMANN VON SCHLAGINTWEIT, born at Munich on 13th May 1826; ADOLF, born at Munich 9th January 1829; and ROBERT, born on 27th October 1833—worked for the most part in company, and in the same departments of inquiry. Hermann and Adolf first made themselves known as investigators of the physical geography of the Alps, through two books—*Untersuchungen über die physikalische Geographie der Alpen* (1850) and a continuation, *Neue Untersuchungen* (1854). Shortly after the publication of the last named Wilhelm von Humboldt got them, along with Robert, recommended to the British East India Company, who sent them out to India to make observations on terrestrial magnetism, to measure mountain altitudes, and carry on meteorological and geognostic investigations. They spent nearly two years and a half in executing their commission, and in the course of it traversed great part of the Deccan, and crossed the main chains of the Himalayas, and penetrated into Tibet. Hermann also made his way alone into Sikkim and Assam, and then in company with Robert explored parts of Ladakh, and crossed, the first of all Europeans, the Kuen-Lun Mountains, for which feat Hermann was in later years nicknamed 'Sakünlünski.' Adolf in the meantime examined the geological structure of the Nilgiris in the south, explored parts of Balti in western Tibet, and in the summer of 1857 crossed the Karakorum and Kuen-Lun Mountains and reached Yarkand; there, however, he was seized by Yakub Beg, emir of East Turkestan, and put to death on 26th August. Hermann on his return to Europe settled down to private life, and gave his energies chiefly to the publication of scientific papers. He died at Munich on 19th January 1882. Robert was in 1863 appointed professor of Geography at Giessen, where he died on 6th June 1885. The Schlagintweits' travels in India are recorded in their *Results of a Scientific Mission to India and High Asia* (4 vols. Leip. 1860-66). During two long journeys through the United States in 1869 and 1880, Robert gathered materials for works on the Pacific railways (1870, 1884, 1886), California (1871), the Mormons (1877), &c.

A fourth brother, EDUARD, born on 23d March 1831, took part in the Spanish invasion of Morocco of 1859-60 and wrote an account of it. He was killed in the battle of Kissingen, fighting in the Bavarian army, on 10th July 1866. EMIL, the fifth brother, born 7th July 1835, chose law for his calling, and the study of Tibetan and Indian languages for his amusement during leisure hours. He has written *Buddhism in Tibet* (Lond. 1860), *Die Könige von Tibet* (Munich, 1865), *Die Götterurteile der Inder* (1866), and other books.

Schlangenbad, one of the best-known spas of Germany, in the Rheingau district, stands in a beautiful wooded valley of the Taunus Mountains, 5 miles W. of Wiesbaden. The water of the baths (82°-90° F.) is of the character called 'indifferent,' is used for the most part externally, in baths, and is helpful in nervous diseases, for women's complaints, and for purifying the skin. Pop. 403. Visitors in the season, 2000. The place gets its name from a species of harmless snake (*Coluber flavescens*) which is found there.

Schlegel, AUGUST WILHELM VON, German critic, poet, and translator, was born at Hanover on 8th September 1767, and began to study theology at Göttingen, but, like his younger brother Friedrich (see below), soon turned to literature, writing poems for two magazines edited by the poet Bürger, and later for Schiller's *Horen*, and contributing to the *Göttinger Gelehrte Anzeigen* and other periodicals. In 1795 he settled in Jena, and in 1796 married a widow lady, Caroline Böhmer (1763-1809), the clever, restless daughter of Professor Michaelis, who separated from him in 1803, and at once married Schelling. In 1798 Schlegel was appointed professor of Literature and Fine Art in that university; and the years 1801-4 he spent in Berlin, lecturing on the subjects he had taught at Jena. The greater part of the following fourteen years he lived in the house of Madame de Staël at Coppet on the Lake of Geneva; the chief incidents that mark this period of his life were the delivery of *Lectures on Dramatic Art and Literature* (Eng. trans. 1815) at Vienna in 1808, and his officiating as secretary to the Crown-prince of Sweden during the war of liberation (1813-14). In 1818 he was appointed professor of Literature in the university of Bonn, a post he filled down to his death there on 12th May 1845. He had already, years before going to Bonn, done what has proved to be his best work: gifted with considerable feeling for poetic form and much fine taste, he translated into German verse most of the works of Shakespeare, and followed up the success he thereby achieved by publishing admirable translations of Dante, Calderon, Cervantes, Camoens, and other foreign masters of literature. The translation of Shakespeare, afterwards revised and continued by Tieck, is still the classic German version. Along with his brother Friedrich he enjoyed great influence throughout Germany as one of the most active leaders of the Romantic movement, his critical papers in *Das Athenaeum* and in the volume of *Charakteristiken und Kritiken* (1801) being greatly valued in their day. In Bonn he devoted his attention principally to Indian studies, and issued editions of the *Bhagavad-Gita* and the *Ramayana*. Heine attended his lectures at Bonn, and learned from him many of the secrets of poetic workmanship; for A. W. Schlegel's own poems, lifeless and cold as they are, show no little finish as to form. Heine's picture of the vain old dictator of letters coming to lecture to his class is worth quoting: 'He wore kid gloves and was dressed after the latest Paris fashion; he still had about him the perfume of elegant society and *eau de mille fleurs*; he was the *beau-ideal* of elegance

and politeness, and when he spoke of the English Lord of the Treasury he always began with the words "My friend." Beside him stood his servant, dressed in the grand livery of the noble house of Schlegel; his business was to snuff the wax candles in the silver candlesticks that stood, along with a glass of sugared water, on the desk before him, the "genius of the age." His inordinate self-esteem, and the unwarranted influence he enjoyed, led him to pass severe censure upon the literary work of men like Schiller, Wieland, and Kotzebue, and involved him in unseemly polemics. Apart from this feature, his judgment as a critic in matters of pure literary taste makes his lectures still worthy of consideration, especially the set already named and another series, *Ueber Theorie und Geschichte der bildenden Künste*, delivered at Berlin in 1827. His writings were published in three separate collections—*Sämmtliche Werke* (12 vols. Leip. 1846-47), *Œuvres écrites en Français* (3 vols. 1846), and *Opuscula quæ Latine scripta reliquit* (1848).

See the books quoted under FRIEDRICH SCHLEGEL; the letters of his first wife, edited by Waitz under the title *Karoline* (3 vols. 1871-82); and Mrs Alfred Sidgwick's *Caroline Schlegel and her Friends* (1889).

Schlegel, FRIEDRICH VON, German critic and writer, was born at Hanover on 10th March 1772. After receiving a classical education at Göttingen and Leipzig, he took to his pen for a livelihood. He abducted the wife of the Jewish merchant Veit (a daughter of Moses Mendelssohn and mother of Veit the religious painter), thus putting into practice views as to free love which he had enounced in a notorious romance, *Lucinde*. He then joined his brother August Wilhelm at Jena, and along with him wrote and edited the journal *Das Athenaeum*, in which they laid down the characteristic principles or features of Romanticism. His zeal for these principles was so strong that he has ever been accounted the head of the Romantic School (q.v.). With him too Friedrich wrote *Charakteristiken und Kritiken* (1801), a set of longer critical essays, which gave a real stimulus to good work in German literature and contain some of both brothers' best writing. Friedrich Schlegel at length sought relief for his romantic yearnings, and refuge from the harsh realities of actual life, by becoming a faithful son of the Roman Catholic Church. From 1808 down to his death, which occurred during a lecture-tour at Dresden on 11th January 1829, he was employed in the public service of Austria. It was he who penned the proclamations of that empire against Napoleon in 1809. The best known of his books, at least in Britain, are lectures on the *Philosophy of History*, first delivered at Vienna in 1827 (Eng. trans. 1835), and *History of Literature*, delivered at Vienna in 1814 (Eng. trans. 1859); both are clever, but one-sided, the Roman Catholic tendencies of the writer being too strongly pronounced. There are also English versions of his *Philosophy of Life* (1847) and *Lectures on Modern History* (1849). The book the Germans esteem most highly of his is *Ueber Sprache und Weisheit der Indier* (1808), which was a pioneer for the study of Sanskrit in Europe. The best edition of his *Sämmtliche Werke* is Feuchterleben's (15 vols. Vienna, 1846).

See his *Briefe an A. W. Schlegel* (1889); Haym, *Die Romantische Schule* (Berlin, 1869); and G. Brandes, *Den Romantiske Skole i Tydskland* (Copenhagen, 1873).

Schleicher, AUGUST, philologist, was born at Meiningen, on 19th February 1821, studied at Leipzig, Tübingen, and Bonn, and began to lecture on comparative philology at the last-named university in 1846. Four years later he was called to the chair of Slavonic Languages at Prague.

From 1857 to 1868 he lived at Jena as an honorary professor; and there he died on 6th December 1868. With him the comparative study of the Indo-Germanic languages took a decided step forward. In his *Kompendium der vergleichenden Grammatik der Indogermanischen Sprachen* (1861; 4th ed. 1876; Eng. trans. 1874-77) he showed clearly the relations of the members of the group, not only one to another, but of each to the original parent language, which he made a gallant attempt to reconstruct, and laid down the phonetic laws that had governed their respective developments. Schleicher did first-rate service also in advancing the scientific study of the Slavonic family of tongues and the Lithuanian language; for instance, in the *Handbuch der litauischen Sprache* (1857). Further labours were embodied in *Die Sprachen Europas* (1850), *Die Deutsche Sprache* (1860; 5th ed. 1888), *Indogermanische Chrestomathie* (1869), and *Litauische Marchen und Lieder* (1857). His views as to the study of language, which he wished to treat as a purely natural science, have been hotly contested by Max Müller. There is a Memoir by Lefmann (1870).

Schleiden, MATTHIAS JAKOB, botanist, was born at Hamburg, 5th April 1804, studied law at Heidelberg, practised at Hamburg as advocate, but in 1833 went to Göttingen and devoted himself to the study of physiology and botany. In 1839 he was called to the chair of Botany at Jena, and in 1863 at Dorpat. In 1866 he retired, and died at Frankfurt, 23d June 1881. He contributed greatly to establish the cell-theory (see CELL); and of his numerous works, including two collections of poems, books on materialism, the sense of sight, the age of man, a Life of Linnaeus, &c., the most important is his *Grundzüge der wissenschaftlichen Botanik* (1842-43; Eng. trans. *Principles of Scientific Botany*, 1849). See BOTANY, Vol. II. p. 352.

Schleiermacher, FRIEDRICH ERNST DANIEL, the greatest German theologian since Luther, was the founder of that modern theology which seeks to understand Christianity without doing despite to the reasonable convictions of the human mind. What marked him out as reformer was first and foremost his mental constitution, in which a profoundly religious temperament was happily blended with an acute intelligence, and an unhesitating independence of thought and feeling with an exceptional susceptibility to the most various impressions from without. Then he was fortunate in having his various gifts developed by the course of his education and the experiences of his life.

He was born on the 21st November 1768 at Breslau, the son of an army chaplain belonging to the Reformed confession. The pious atmosphere of his home awakened vivid religious feelings in the boy, which attained fuller growth at the Moravian educational institutes of Niesky and Barby, where he studied from 1783 till 1787. But deep as was the impression made upon him by the godliness of social life amongst the brethren, the narrow and rigid dogmatic form of religion as taught by them was simply intolerable to the eager mind of Schleiermacher, already leavened by the wisdom of classical antiquity; and he felt that he could no longer profess this faith without a lie against his own nature. There was a painful conflict of opinion between him and his rigorously orthodox father ere the son forsook the theological seminary of Barby to study philosophy and theology at Halle. Of the philosophers it was mainly Plato, Spinoza, and Leibnitz, and afterwards also Kant, Fichte, and Schelling, who made a permanent impression on him and moulded his mental development. A powerful influence was also exerted from 1797 onwards by the intimacy into which, now a preacher

in Berlin, he was drawn with the devotees, both male and female, of Romanticism (q.v.). He thoroughly sympathised with that cultus of personal feeling and that contempt for mere intellectual *Aufklärung* which the romantics carried to an extreme; but he was saved from falling into the speculative and practical excesses of the romantics by the anchor which his character had found in personal piety, and by the scientific prudence and breadth that came of his constant study of philosophy, ancient and modern. To this first sojourn in Berlin belong the earliest of those publications which made Schleiermacher known to the learned world: the *Reden über Religion* (1799; new ed. 1879), the *Monologen* (1800; 7th ed. 1868), and the ethical work, the *Grundlinien einer Kritik der bisherigen Sittenlehre* (1803). In these he expounded in scientific form that hostility to the traditional moral philosophy and the Kantian ethic of the categorical imperative to which he had already (1801) given audacious expression in the 'Confidential Letters on Schlegel's *Lucinde*,' where he attempted a defence of the notorious romance of his friend Friedrich Schlegel. A more valuable undertaking was the translation of Plato, which the two friends set about jointly, but which was ultimately carried through in 1804-10 by Schleiermacher alone. This work, epoch-making for the comprehension of Plato's philosophy, was in great part the fruit of the involuntary idleness imposed upon the translator by Napoleon, when in 1806 he closed the university of Halle, at which since 1804 Schleiermacher had been extra-ordinary professor. Returning to Berlin, he entered into close relations with Stein and Humboldt, with the philosopher Fichte, and with other patriots; and he took an active share in all the efforts which were being made to bring about the moral regeneration and the political restoration of the German Fatherland, especially of Prussia. One scheme with this aim was the establishment of the new Frederick-William university of Berlin, in which Schleiermacher took part; and in the theological faculty of this university he became professor in 1810. The fame of his academic lectures on all branches of theology and philosophy attracted yearly increasing crowds of enthusiastic students; and as preacher at the *Dreifaltigkeitskirche* he exercised a profound religious influence by his sermons, both on hearers and readers. Equally influential were his labours in the sphere of church politics; he was the soul of the movement which led to the union in 1817 of the Lutheran and Reformed Churches in Prussia; and it was not his fault that his far-sighted proposals for the preparation of a new constitution and forms of ritual suited to the wants of the united church were not adopted. His resolute bearing in these controversies was the more to his honour, inasmuch as it made him so unpopular with the government that for years he ran the risk of losing his university chair.

Yet all these public labours—some of them trying and ungrateful—could not prevent the indefatigable scholar from devoting concentrated energy to the advancement of learning. The outcome of these studies was on the one hand short essays on ethical problems and on points connected with ancient philosophy which were published in the transactions of the Berlin Academy; and on the other the theological works *Die Weihnachtsfeier* (1806; Eng. trans. *Christmas Eve*, 1889); a critical treatise on the first epistle to Timothy (1807); *Kurze Darstellung des theologischen Studiums* (1811); and finally his most important work, *Der Christliche Glaube nach den Grundsätzen der Evangelischen Kirche im Zusammenhang dargestellt* (1821; 2d ed. 1831; 6th ed. 1884). He died 12th February 1834; and after his death friends published several

other works from his manuscripts or from notes of his lectures taken by students. Of these the most important are *Die Christliche Sitte* (1843), *Leben Jesu*, Sermons, a work on Dialectic, and a sketch of a system of Ethics. A collection of letters, of great importance for understanding Schleiermacher's very singular personality, was edited by Dilthey in four volumes (1860-64; partly trans. by Frederica Rowan, 1860). Dilthey began a biography, of which only the first volume has appeared (1870). A multitude of larger and smaller books and articles dealing with the man and his work appeared on occasion of the centenary of his birth, 1868. In 1825 Thirlwall published a translation of his *Essay on St Luke*; his *Introduction to Plato's Dialogues* was translated into English by Dobson in 1836; and a volume of *Selected Sermons* was issued in England in 1890.

Schleiermacher has been for theology what Kant was for philosophy. Kant submitted the theoretical and practical reason to a critical analysis, in order to distinguish the primordial and perennial laws of thought and will from the ever-changing sensations which supply the materials of experience. In like manner Schleiermacher undertook a critical analysis of religion, in order to discover what in it was the original essence and what were the derivative forms. Dogma, he taught, is not religion, but a statement about religion which is the product of reflection; religion itself is feeling, the immediate sense of our dependence on the divine source of all things, on God. But devout feeling, though the inmost part of individual life, is not itself merely individual; the individual man is conditioned by the community he belongs to, and the mode in which that community experiences the religious emotion, in a manner common to its members, rests on and is conditioned by the historical and fundamental fact of the establishment of the community. In this fact we may recognise a 'revelation,' inasmuch as a creative religious personality communicates to others its own peculiar religious feeling, its consciousness of God. Every historical religion rests in this sense on a revelation, on the communication of the original religious life of creative personalities, such as could not be thought out *a priori* or deduced from universal truths. This is especially true of Christianity, which is peculiarly a *positive* religion, one to be realised through experience, inasmuch as it has for its very centre the relation to the historical person of Jesus Christ as the redeemer; and by this fact all statements of doctrine as to God and the world and mankind must be regulated. The Christian church recognises that it has received 'Redemption'—liberation and strengthening of the consciousness of God heretofore trammelled by nature—as the influence of the person of Christ, and that it continues to receive the same by means of the spirit of the church, which has proceeded from Christ. From this experience the church is led upwards to its cause in the person of Christ, and for that reason believes in the typical perfection of Christ; this distinguishes Christ from all other men, yet without abrogating his true humanity. Similarly our faith in Christ rests only on that quickening of the pious disposition which we experience through and from him, and which in a sense is common to us with him. But this faith is independent of all historical reports of miraculous events that took place in him or by him. It is not because of the Bible and its miracles that we believe in Christ; it is because of Christ, whose influence we experience in our consciousness of redemption, that we believe in the Bible. That is, we ascribe to the Bible a normative dignity, as containing a substantially true picture of Christ; while it must not, however, prevent us from submitting

its story in detail to the same critical tests as we apply to all historical traditions whatsoever. Schleiermacher did not expressly deny all miracle; but he laid down the general principle that it is not to the advantage of piety to hold, in the case of any single events, that their connection with the order of nature is interrupted by their dependence upon God. His general conception of the relation of God to the world, of the mutual correspondence of the infinite with the many finite causes (which approximates very closely to Spinoza's view), excludes the possibility of miracles in the fully supernaturalistic sense of the word. In this reference Schleiermacher has avoided and superseded alike supra-naturalism and rationalism, by emphasising Christian experience, and insisting on the historical character of the Christian religion in the person and influence of Christ. He has interpenetrated theology with philosophical idealism by taking as its basis the human self-consciousness. On the other hand, he set philosophy free from the un-historical individualism and rationalism which had clung to it even in Kant's hands by widening the religious and ethical consciousness into the social consciousness of the community; in the common consciousness of ethical beings he discovered reason historically developing itself, and saw in the individual reason no more than the special form of manifestation, the organ which is but its servant. By means of his dogmatics and his ethics Schleiermacher has done more than any other thinker to solve the great problem of this age—the reconciliation of the individual with the community, of private conscience with the claims of historical tradition.

See, besides books referred to above, the article RELIGION in this work; Lichtenberger, *History of German Theology in the Nineteenth Century* (1873; Eng. trans. by Hastie); and *The Development of Theology since Kant* (1890), and *The Philosophy of Religion* (Eng. trans. 1886-88), by the present writer.

Schleswig. See SLESWICK.

Schlettstadt, a town of Lower Alsace, on the left bank of the Ill, 27 miles by rail SSW. of Strasbourg. It manufactures wire-gauze. In the 13th century it was made a free imperial town, and in the 15th was chosen by Agricola as the seat of a higher school that greatly helped to foster humanistic studies; Erasmus was a pupil. In 1634 the town became French; it was fortified by Vauban in 1676. The Germans, after capturing the town in 1870, razed the fortifications. Here Martin Bucer (q.v.), the Reformer, was born. Pop. (1875) 9094; (1885) 9172; (1895) 9304.

Schliemann, HEINRICH, the excavator of the sites of Troy and Mycenæ, was a native of Mecklenburg-Schwerin, born at Neubuckow on 6th January 1822. Whilst working in a merchant's office and afterwards trading on his own account in St Petersburg, he acquired a knowledge of the principal languages of modern Europe and of ancient Greek. Having in the meantime become possessed of a large fortune, he began in 1870 to explore and excavate at his own cost the mounds of Hisarlik in the Troad (Asia Minor), and continued the work for twelve years. Schliemann maintained that it was the site of ancient Troy (q.v.). For carrying off, contrary to his agreement with the Turkish government, all the spoils he unearthed, he was compelled, through a judgment of the Greek courts, to pay the Ottoman Porte the sum of £2000. But he retained possession of his collections, and in 1882 presented them to the German nation; they are now preserved in the Ethnological Museum at Berlin. In 1876 Schliemann commenced, in like manner, to excavate the site of ancient Mycenæ in Greece;

and there he discovered invaluable treasures (now in the Polytechnic at Athens), and exposed buildings of great antiquity and interest (see MYCENÆ). He also carried on explorations in the island of Ithaca (1869 and 1878), at Orchomenus (1881-82), and at Tiryns (1884-85). The results of his labours are described in the monographs on *Mykenæ* (1877; Eng. trans. 1877); *Ilios*, with an autobiography of the author, and notes, &c. by Professors Virchow and Max-Müller (1880; Eng. trans. 1880); *Orchomenos* (1881); *Troja* (1883; Eng. trans. 1883); *Tiryns* (1886; Eng. trans. 1886); and *Bericht über die Ausgrabungen im Troja im Jahre 1890* (1891). He wrote also *Ithaka, der Peloponnes, und Troja* (1869); *Trojanische Alterthümer* (1874); and *Reise in der Troas* (1881). Schliemann died at Naples on 27th December 1890, and was buried at Athens. See Dr Schuchardt's *Schliemann's Ausgrabungen* (1890; Eng. trans. 1891), and his own *Selbstbiographie* (1891).

Schlosser, Friedrich Christoph, a German historian, born at Jever in Oldenburg, 17th November 1776, was educated at Göttingen, and, after spending many years as a private tutor and academic teacher, was (1819) called to Heidelberg as professor of History, and died there, September 23, 1861. His principal writings are *Geschichte der bilderstürmenden Kaiser* (1812); *Weltgeschichte* (9 vols. 1817-24); *Geschichte des 18 Jahrh.* (1823; 5th ed. 8 vols. 1864-66; Eng. trans. 1843-52); *Geschichte der Alten Welt und ihrer Cultur* (1826-34); *Weltgeschichte für das Deutsche Volk* (18 vols. 1844-56; 4th ed. 19 vols. 1884-88); and *Studien über Dante* (1855). Schlosser's ideal of the historian's art was ethical: he wrote neither from the literary standpoint, nor yet from the critical, but from the moral. Yet he is not uncritical; for he exercised the critical intelligence of a widely-read historian with a stern love of truth. His books have had great influence with the middle classes of Germany. There are German Lives of him by Gervinus (1861), Weber (1876), Erdmannsdörffer (1876), and O. Lorenz (1878).

Schlüsselburg, a town and prison-fortress of Russia, the fortress being on a rocky islet in the Neva where it issues from Lake Ladoga, and the town (pop. 5542) on the right bank of the river. Here the dethroned Czar Ivan VI. was murdered by authority, after twenty-three years' imprisonment in this and other fortresses.

Schmalkalden, an old town of Hesse-Nassau, Prussia, stands 19 miles SW. of Gotha, is surrounded with double walls, contains a castle, a town-house in which the historic 'articles' were signed, and carries on iron-mining and hardware manufactures. Pop. 7318. It is the birthplace of Karl Wilhelm (1815-73), composer of the 'Wacht am Rhein.'

LEAGUE OF SCHMALKALD, a defensive alliance concluded at Schmalkalden on 4th April 1531 between nine Protestant princes and eleven imperial cities, with whom other princes and imperial cities subsequently made common cause. The Elector of Saxony and the Landgrave of Hesse were appointed chiefs of the league. The object of this formidable alliance, which included nearly all the Protestant states from Denmark to Switzerland, was the common defence of the religion and political freedom of the Protestants against the Emperor Charles V. and the Catholic states. The confederation was consolidated by the *Articles of Schmalkald*, drawn up by Luther at Wittenberg in 1536. A conflict was of course inevitable. In the war of Schmalkald that ensued (1546) when the emperor got leisure to turn his attention to the matter the strength of the Protestants was crippled and dissipated by jealousies, but especially by the

defection of Duke Maurice of Saxony, so that in the battle of Mühlberg (24th April 1547) the Elector of Saxony (the head of the elder branch of the Saxon house, Duke Maurice being the head of the younger branch), Philip of Hesse, and other Protestant chiefs were taken prisoners and their army routed. This caused the league to break up. The Protestant cause was, however, revived five years later by Duke Maurice, who had in the meantime been made Elector instead of his unfortunate kinsman, and who in 1552 returned to his old allegiance to Luther's teaching.

Schmitz, Leonhard, was born in 1807, and educated at the Gymnasium of Aix-la-Chapelle and at the new university of Bonn, where he was profoundly influenced by Niebuhr, Welcker, and Brandis. His marriage to an English lady in 1837 drew him to England, and here with Dr W. Smith he completed the translation (vol. iii. 1842) of Niebuhr's history which Hare and Thirlwall had begun (vols. i.-ii. 1828-32). His translations of Niebuhr's *Lectures on the History of Rome* (1834; 2d ed. 3 vols. 1849-50), *Lectures on Ancient History* (3 vols. 1852), and *Lectures on Ancient Ethnography and Geography* (2 vols. 1853) followed; and later, from his own pen, excellent manuals of the *History of Greece*, and of *Rome, Ancient History, Ancient Geography, and Medieval History*. He edited the *Classical Museum* for some years, and was a large contributor to the *Penny Cyclopædia* and Dr W. Smith's *Dictionaries of Greek and Roman Antiquities, of Biography and Mythology, and of Geography*. He translated Zumpt's *Latin Grammar*, and edited a popular series of Latin class-books for W. & R. Chambers. In 1846 he became Rector of the Edinburgh High School, and in 1866 head of the International College at Isleworth, which post he resigned in 1874. He acted for some years as classical examiner to London University, was injured by a street accident in 1889, but recovered, only to be carried off by influenza, 28th May 1890.

Schneeberg, a mining-town of west Saxony, 20 miles SW. of Chemnitz, producing silver (though not in its former great abundance), cobalt, tin, and iron. Dolls, lace, chemicals, &c. are manufactured, and embroidery is carried on. Pop. (1890) 8213.

Schneekoppe, the highest point (5260 feet) of the Riesengebirge (q.v.).

Schnitzer, Eduard, better known as **EMIN PASHA**, was born of Jewish parents at Neisse in Silesia, on the 28th of March 1840, and was educated at the Gymnasium of Neisse until 1858, when he commenced the study of medicine at the university of Breslau; and he graduated at Berlin in 1864. Soon after, he proceeded to Turkey with the view of settling there in practice, and had till 1873 an appointment at Scutari on the staff of Haki Pasha. During this appointment Schnitzer gained an intimate acquaintance with Armenia, Syria, and Arabia, and it was during this period of his life that he adopted the name of Emin and the habits and customs of the Turks. He took the name the better to enable him to identify himself with the people and to disarm their prejudices. After a brief visit to Nissa in 1875, where his studies in natural history were continued, we find him in 1876 entering the Egyptian medical service as Dr Emin Effendi. He proceeded to Khartoum, was sent by Ismail Pasha, the governor-general, to the Equator, and appointed by Gordon Pasha chief medical officer of the Equatorial Province. This appointment he held until 1878, being employed, however, by Gordon Pasha, who greatly appreciated his talents, in various diplomatic missions and tours of inspection. In 1878 Gordon Pasha appointed Emin Effendi governor of the Equatorial Province, which position he held until the arrival of Mr

Stanley's expedition in 1889. In 1879 he was raised to the rank of Bey, in 1887 to that of Pasha.

An extraordinary linguist, Emin acquired, besides French, English, Italian, Turkish, and Arabic, a knowledge of several Slavonic languages, as well as many central African dialects. He was known as a skilful medical man, and his ability as a governor and an administrator is witnessed to by the fact that he for years, cut off from all communication with the outside world, single-handed maintained his position at the farthest outpost of civilisation. It is true that after the expedition sent to his relief arrived his troops revolted; but this is to be explained by the fact that his ignorant men were disappointed at the sorry spectacle which the expedition presented after its heroic march to their assistance. Emin gained a wonderful insight into the habits and customs of the people amongst whom he has lived, and probably no one has added more to our anthropological knowledge of central African tribes than he. For over seven years he carried on meteorological investigations with such success that Lado has become the standard to which all barometrical observations are referred in East Equatorial Africa. With reference to his geographical work, his route surveys extend over more than 4000 miles, and he made a triangulation survey of the country extending from the Victoria and Albert Lakes in the south to Lado in the north, to the river Djour in the north-west, to Mombuttu and the river Welle in the south-west. Between 1878 and 1883 eleven geographical papers of extreme value were published by him in *Petermann's Mittheilungen*. Emin's services to natural history were exceptionally great; throughout the whole of his residence in central Africa he showed himself an intelligent and painstaking collector. It is impossible to specify the number of examples he sent to Europe, but one collection sent to the British Museum in 1878 consisted of over 100 mammals, 350 birds belonging to 179 species, many reptiles, batrachians, 380 butterflies belonging to 356 species (15 of which were new to science), besides many beetles, scorpions, and a large number of land and fresh-water shells. The results of his labours in this direction have almost completely elucidated the distribution of the flora and fauna of central Africa. Apart from this work, Emin made valuable botanical collections; and his cultivation experiments, carried on for many years, will prove of service in the agricultural development of central Africa. Steadily working at the central African languages, he collected numerous and valuable vocabularies, the most important being of the Waganda, Wanyoro, Wahuma, Madi, Bari, and Mombuttu dialects.

When it is considered that all the work here indicated was performed by a man weighted with the government of a large uncivilised province, and who was for years cut off from all communication with Europe, it will be seen what force of character and energy he possessed. Emin Pasha was no military genius, but he proved himself to be an enlightened ruler and a bitter foe to the slave-dealers, managing to abolish slave-dealing throughout his province. He constantly endeavoured to civilise the people committed to his charge, and in this he succeeded to a very large extent. In December 1889 Emin Pasha arrived at Zanzibar with Mr Stanley. He met with an accident there from which he nearly lost his life, and from whose effects he suffered for three months. Notwithstanding this, and the urgent desire of his friends in Europe for his return home, such was his energy and his love for the country which he had left that he entered the service of the German government, and returned at the head of a large

expedition to central Africa. He was energetic in extending the German sphere of influence, made favourable treaties with native chiefs, and founded German stations on the Victoria Lake; besides sending large zoological and ethnographical collections to the museum in Berlin. But he never regained his old influence, and seems, defeated in his hopes, to have been marching for the west coast when, about the 22d October 1892, he was slain by the Arabs in the Manyema country.

See Stuhlmann, *Mit Emin Pascha ins Herz von Afrika* (1894); Vita Hassan, *Die Wahrheit über Emin Pascha* (1893); *Uganda and the Egyptian Soudan*, by the present writer and the Rev. C. T. Wilson (2 vols. 1882); *Emin Pascha in Central Africa: his Letters and Journals* (trans. by Mrs Felkin, 1888); *Petermann's Mittheilungen* (1878-83); *Scottish Geographical Magazine* (1886-89); *Proceedings of the Zoological Society* (1888); *Journal of the Anthropological Institute* (1888); Stanley, *In Darkest Africa* (1890); and the standard Life by G. Schweitzer, *Emin Pascha: his Life and Work* (trans. 1893).

Schnorr von Carolsfeld, BARON JULIUS, painter, was born at Leipzig on 26th March 1794, and was trained as a painter by his father (likewise an artist) and at the Vienna Academy. In Vienna he became associated with the German school of Cornelius, Overbeck, Schadow, and Veit, who went back for their inspiration to the old masters anterior to the days of Raphael, and in 1818 he followed them to Rome. But though he agreed with them in principle, he avoided their extremes, and was the only one of them who remained a Protestant. For the walls of the Villa Massimi at Rome he executed, as his share of the work, nearly two dozen frescoes from Ariosto's *Orlando* (1820-26). The year after the completion of this labour he was called by King Louis of Bavaria to fill the chair of Historical Painting in the Academy of Munich, and was besides commissioned to paint for the king's new palace and other royal apartments a series of frescoes illustrative of the *Nibelungenlied* and of the lives of Charlemagne, Frederick Barbarossa, and Rudolph of Hapsburg. In 1846 he accepted the appointment of professor at the Fine Art Academy in Dresden, coupled with the directorship of the royal picture-gallery. Schnorr's designs for 180 pictures to illustrate the narratives of the Bible (*Bible Pictures*, Lond. 1860) are accounted by many authorities the best things he did. The illustrations for Cotta's great edition of the *Nibelungen Not* were also designed by him; and his skill as a draughtsman and designer are further exhibited in stained-glass windows in St Paul's Cathedral, London, and in Glasgow Cathedral. Amongst his representative easel-pictures may be quoted the 'Marriage at Cana,' 'Jacob and Rachel,' 'Three Christian and Three Heathen Knights of Ariosto,' 'Ruth in Boaz's Wheat-field,' 'Christ Bearing the Cross,' 'Siegfried and Kriemhild,' and 'Luther at Worms.' His best qualities are balance of arrangement, freedom of design, and vivacity, together with many happy inspirations; in fact, he had too many ideas, and did not give himself time to mature them properly. Besides, his work is frequently too decorative in effect, and the figures lack individuality and dignity. Schnorr died in Dresden, 24th May 1872. See *Art Journal* (1865).

Schöffer. See GUTENBERG.

Scholarship, a benefaction, generally the annual proceeds of a bequest permanently invested, paid for the maintenance of a student at a university or at a school. See UNIVERSITIES, CAMBRIDGE, OXFORD, ETON, HARROW, &c.

Scholasticism. The term scholasticism specially designates the aims, methods, and products of thought which constitute the main endeavour of the intellectual life of the middle

ages. As under the names of its leading representatives special accounts have been given of their distinctive teaching, it will here be sufficient to indicate the conditions from which scholasticism arose, the general course of its history, and the causes that wrought its decay. In the case of no other great development of human thought can we mark with such precision its beginning, process, and end.

It was with the reign of Charlemagne (died 814) that the start was fairly made towards a new civilisation with the Christian religion and theology for its basis, and with a character and aim of its own essentially distinct from the civilisation of antiquity which had died with the ruin of the empire of Rome. In the political confusions that followed the dismemberment of the Carolingian empire much was lost that had been recently gained, yet the tradition was never again lost of those ideals of a higher culture inaugurated in the schools founded by Charlemagne. In John Scotus Erigena (died 875) we have the first great thinker of the early middle ages. As he drew his inspiration from Plato rather than from Aristotle, however, and as his methods are not those of the schoolmen proper, he does not in strictness belong to the scholastic philosophy. It is by his translation of the writings of the Pseudo-Dionysius, a work which exercised the profoundest influence on the religious life of the middle ages, that he holds his place among the thinkers who have determined the development of Christian Europe. In the 10th century the tradition of higher studies was represented by one who, though also not a schoolman, cannot be passed over in any history of the origins of the new civilisation. By his great school at Rheims, Gerbert, afterwards Pope Sylvester II. (died 1003), kept alive in France that intellectual eagerness which it had mainly owed to the genius of Charlemagne, and which eventually justified the saying of the middle ages—"To the Germans the empire, to the Italians the pope, to France studies!"

During the 11th century western Europe grew to a clearer consciousness of the aims it had to follow in the development of the ideas on which the Christian society must be based. Till the year 1000 all endeavour had been paralysed by the belief that with that year God's account with men must close. As the dreaded hour was left behind, however, the sense of relief and gratitude showed itself in a quickened life in every field of human activity. The first crusade (1096) is conclusive proof that the church now confidently reckoned on a renewed term of terrestrial existence, and that it felt the duty of signalling the unexpected respite. In the sphere of thought, also, that movement now began which, in spite of its fatuities and eventual stultification, had for its essential aim the reasoned account of the ideas on which the new order was founded. In this endeavour there were initial conditions which at once determined the nature and direction of men's reasonings and vitiated at the source the value of their results. It is the essential distinction between the schoolmen and the thinkers of antiquity that the former were not left free to question the subject-matter on which their ingenuity was expended. Of all ultimate questions the church provided a solution ready to hand and beyond appeal. The liberty to choose or reject that solution would have nullified the very principle of the church's existence. Moreover, the intellectual life of the middle ages directly proceeded from the organisation of the church, and individual thinkers were but the organs of its doctrine and tradition. The mediæval university was an essentially a religious institution as a monastery or a cathedral, and its members held their place solely on condition of their acceptance

of the church's standard of faith. But it was exclusively in the universities that intellectual life was then possible. With their thought thus fettered in its fundamental process, a natural development, following every indication of truth to its legitimate conclusion, could not be looked for in the schoolmen. The most daring conclusion they could reach was to question whether the teaching of the church could be made good to the mind by any process of merely human reasoning. Uniformity of method, and futile distinctions or petrifying routine, were thus the inevitable outcome of the mediæval philosophy.

According to the statement of Victor Cousin, now generally accepted as true, the fundamental problem of scholasticism had its first suggestion in a remark of Porphyry (died 304) regarding the difficulty of settling the question whether *genera* and *species* have a real objective existence or are merely abstractions of the mind. Put in as simple language as its nature admits, the problem is this: Is there or is there not an objective reality corresponding to our general notion, say of *man*, *horse*, *flower*, &c.? Those who answered the question in the affirmative came to be known as *realists*, their opponents as *nominalists*. Trifling as the question may appear in itself, for the schoolmen it lay at the root of every attempt to render account to human reason of divinely revealed truth. An abstract question assumed vital importance when the disputants saw behind it the doctrines of the Trinity, the Incarnation, the Immaculate Conception, and the nature and existence of angels. It was especially in its bearing on the doctrine of the Trinity that the question of Nominalism *versus* Realism for more than four centuries exercised the acutest intellects the world has perhaps seen. It was the contention of the Realists that on the principle of Nominalism the doctrine of the Trinity was irrational and inconceivable. Grant, they argued, that our general notions have objective reality, then, just as from the totality of men we have an objective unity in the notion *man*, so from the Divine Trinity of Persons we can conceive a Divine Unity of Substance. On the other hand, if general notions be mere names, the doctrine of the Trinity in Unity is absurd on the face of it. Of the two theories it was Realism which had the approval of the church, and which was associated with the pious feeling of the middle ages. Till its final triumph in William of Ockham Nominalism had to fight for its existence against the main current of the religious and speculative tendency of the mediæval church. The history of scholasticism is in large degree the history of the varying fortunes of these two rival theories and their rival champions.

An event of the first importance divides this history into two periods so distinctly marked that they have come to be known as the periods of the earlier and the later scholasticism. This event was the introduction into the Christian schools through the medium of the Arabian commentators (chiefly Avicenna and Averroës) of the writings of Aristotle on natural science, metaphysics, and ethics. Till the beginning of the 13th century Aristotle had been known to the schoolmen only by his writings on logic. From the knowledge of Aristotle's complete work, therefore, they received an impulse which led the way to bolder speculation, and gave birth to questionings that stirred the deepest consciousness of the later middle age. On the one hand, the new Aristotle ministered to the intellectual want of the time in supplying the material it needed to exercise those faculties which had been so assiduously trained by Aristotle's own dialectic. But Aristotle was a pagan, and many points in his teaching ran counter to Christian

doctrine. To give him that place in the schools which many now wished would be a standing menace to the authority of the church. From the first appearance of the new writings, therefore, Rome steadily set its face against the 'Grecian Doctor,' and in a succession of anathemas forbade certain parts of his writings to be used in the universities. In the relation of thinkers to Aristotle we have thus the distinction between the earlier and the later scholasticism. Of the first period the great names are Roscellinus, Anselm, William of Champeaux, Abelard, and Peter Lombard; of the second, Albertus Magnus, Alexander of Hales, Thomas Aquinas, Duns Scotus, William of Ockham, and Jean Gerson.

The name of Anselm (1033-1109) is chiefly remembered in connection with his attempt to prove the existence of God from the innate idea which he supposed to be common to all mankind. His place in the line of the schoolmen, however, is not due to this argument, famous as it is in the history of thought. It was in his controversy with his contemporary Roscellinus (born near Soissons about 1050) on the burning question of universals that he entered the peculiar domain of scholasticism. Though not the first to renew the old controversy, Roscellinus, by the notoriety which he gave to it, may be regarded as the founder of the scholastic philosophy. With a skill and success that alarmed the authorities of the church he argued for the theory of Nominalism, Anselm taking up the contrary position with equal subtlety and persistence. It proves the importance assigned to the question at issue that in 1092 a council held at Soissons condemned the teaching of Roscellinus as implicitly involving the negation of the doctrine of the Trinity. As Roscellinus was the founder of Nominalism, William of Champeaux (1070-1122), the head of a famous school of logic in Paris, was the founder of Realism. It was in refuting his teaching that his pupil Abelard (1079-1142) gained the first triumphs of his extraordinary career. In Abelard we have the boldest thinker and one of the most striking figures in the history of the middle ages. His celebrated pamphlet *Sic et Non* was a manifesto of rationalism, which sent a shudder through the conservatism of the time. Selecting 158 points of Christian doctrine he arrayed the opinions of the most revered authorities on each. Presented in this startling fashion, the opinions of St Paul, Augustine, Gregory, Jerome, Athanasius, and others were seen to be so essentially self-contradictory that no doctrine was left on which an intelligent believer could rest. On the main question of the schools he rejected the orthodox Realism, and adopted an eclectic theory which was neither Realism nor Nominalism, but a middle position between each. A thinker like Abelard striking at the very root of the Christian tradition could not in the reason of things be tolerated by the church; and by a great assembly at Sens in 1140, and afterwards at Rome, his writings were ordered to be burned and himself prohibited from teaching. But the spirit of Abelard was never completely exorcised during the subsequent centuries, and he has always been regarded as the brilliant precursor of the modern time. By his 'Four Books of Sentences' (i.e. right rules) Peter Lombard (c. 1100-60), a pupil of Abelard, came to hold a place in the history of scholasticism hardly second to any other thinker. The object of his book was to be the antidote of *Sic et Non*; and in a different spirit from Abelard the Lombard brought together the opinions of the Latin fathers Augustine, Ambrose, and Hilary, as also of Cassiodorus. To each article he annexed a series of 'Distinctions,' in which he sought to define more precisely the doctrine under considera-

tion. Though conceived in a spirit of orthodoxy, the 'Sentences' did not escape the leaven of Abelard's scepticism. Regarded with suspicion on its first appearance, it yet became the great text-book of the universities to the close of the middle ages, and was itself made the subject of interminable commentaries by subsequent schoolmen.

In the second period of scholasticism larger interests and more various problems quickened the speculations of the successive thinkers. During the 13th and 14th centuries the rivalries of the two mendicant orders, the Dominicans and the Franciscans, divided the schools, and introduced a polemical element into philosophical discussion unknown in a similar degree to the earlier period. Generally the Franciscans, as the body of democratic origin, counted in their ranks the bolder thinkers among the schoolmen. Thus, Roger Bacon, Duns Scotus, William of Ockham were Franciscans, Albertus Magnus and Thomas Aquinas Dominicans. The new Aristotle was the battle-ground of the two rival camps of thinkers, and specially the Aristotelian doctrine of the soul. As that doctrine had been expounded by the Arabian commentator Averrhoes, it involved the negation of the Christian doctrine of the resurrection and of the immortality of the soul. It is mainly by their attitude towards Averrhoes that we distinguish the different tendencies of the schoolmen of the 13th and 14th centuries.

An eclectic in his view of universals, Albertus Magnus (1193-1280) accepted Aristotle through the commentator Avicenna in preference to Averrhoes. The task of the later schoolmen was to harmonise the newly-received teaching of Aristotle with the doctrines of the church, and Albert was the first to bring together the materials for the furthering of this end. To effect this harmony was the life's endeavour of the most constructive mind of all the schoolmen, Thomas Aquinas (c. 1226-74). In his *Summa Theologiæ* Aquinas sought to supply a complete repertory of human thought on all subjects touching religion and philosophy, the fundamental principle of his work being that as faith and reason have two distinct spheres, neither can conflict with the other. On the subject of universals he was an eclectic like his master Albertus. Even Aquinas did not escape the charge of heresy, and through the efforts of the Franciscans his teaching on the nature of the soul was formally condemned by the church. Eventually, however, he came to hold the first place as the oracle of divine and human wisdom, so that a pope could say of him that 'the articles of Thomas were so many miracles.' What Aquinas was to the Dominicans Duns Scotus (c. 1265-1308) was to the Franciscans. Roger Bacon (c. 1214-94), also a Franciscan, holds a place apart from the other thinkers of the middle ages by his contempt for the studies of the schoolmen. The introduction into the western schools of what is known as the Byzantine logic by Petrus Hispanus (1226-77) is a turning-point in the history of the scholastic philosophy. Through its influence logic in the teaching of Duns Scotus and William of Ockham assumed an importance which had the most disastrous results on the entire scholastic system. With an acumen which gained for him the title of 'The Subtle Doctor,' Duns applied the new logic to the main position of Aquinas that reason and revelation are two distinct sources of knowledge, and sought to prove that there is, in truth, no knowledge apart from the Christian teaching. On the question of universals he shows all his subtlety, but his position is virtually that of Aquinas himself. It was in the hands of William of Ockham (c. 1270-1349), a pupil of Duns Scotus, that the scholastic philosophy assumed a form which speedily led to its disintegration. By his triumphant demonstration

of the theory of Nominalism scholasticism ceased to have a reason for its existence, and the foundation was laid for that method of experiment and induction which was the outcome of the long travail of the schools of the middle ages. With Ockham closes the line of the great schoolmen; and of the thinkers who followed him Jean Gerson (1363-1429) alone deserves to be mentioned as one of the representative figures of the later scholasticism. In certain of the great universities, indeed, the scholastic methods continued to prevail long after a better way had been opened up for the freer development of the human spirit. In the university of Paris scholasticism held its place into the 17th century; and in Spain, till comparatively recent years, it was still the only philosophy that could be learned by her students. By the close of the 15th century, however, scholasticism was dead as a vital phase of human thought. In itself it was an exhausted movement, and the revival of antiquity and the religious reformation of the 16th century supplied a fresh stream of ideas, which opened up a larger scope of the possible development of humanity.

It was natural that the humanists and the reformers should do their utmost to discredit the system from which they were seeking to emancipate their contemporaries; and so effectually did they do their work that not till within recent years has scholasticism been thought worthy of a serious attempt to understand it. At present the tendency is to recognise in it for its own time and place a perfectly rational system, yielding healthy exercise to the best minds of the middle ages. The ridicule of the humanists is seen to be true only of its later phases. While, therefore, from the very conditions of its origin and growth, scholasticism was debarred from that free and direct questioning of things which is the distinctive characteristic of ancient and modern times, it nevertheless, as in Dante and Thomas Aquinas, produced certain types of thought and feeling which could have sprung from no other system, and for the absence of which the world would have been emphatically the poorer.

See Hauréau, *Histoire de la Philosophie Scolastique*; Milman, *History of Latin Christianity*; Hampden, *Scholastic Philosophy* (Bampton Lecture, 1848); Cousin, *Ouvrages inédits d'Abélard*; Prantl, *Geschichte der Logik im Abendlande*; Jourdain, *Recherches Critiques sur l'Âge et l'Origine des Traductions Latines d'Aristote* (1843); Roman, *Averroès et l'Averroïsme*; also, the various histories of philosophy by Lowes, Schwegler, Ueberweg, and others.

Scholasts, ancient grammarians, for the most part anonymous and known only by their short annotations written on the margins of the MSS. of the ancient classics, Greek and Roman. These remarks concern the language more frequently than the substance, and are sometimes feeble and pedantic, but often tend to elucidate the text or even critically amend it. The earliest scholiasts were those of the Alexandrian School (q.v.); many are as late as the Byzantine period. A Gloss (q.v.) was one of the merely verbal scholia.

Scholten, JAN HENDRIK, the chief of the modern school of Dutch critical theologians, was born at Vleuter near Utrecht, August 17, 1811. He studied at Utrecht, and became in 1840 professor of Theology at Franeker, in 1843 extraordinary, and in 1845 ordinary professor at Leyden, where he died 10th April 1885, four years after his retirement. His writings were either in Dutch or Latin, but French and German translations carried them far beyond their country. The chief were *Principles of the Theology of the Reformed Church* (2 vols. 1848-50), *Historical and Critical Introduction to the New Testament* (1853), *A Critical Study*

of the Gospel of John (1864), *The Oldest Witnesses to the Writings of the New Testament* (1866), *The Oldest Gospel* (1868), and *The Pauline Gospel* (1870). The school of which he was the most conspicuous leader eliminates the supernatural element from Christianity, evolving the religion from the religious consciousness of Jesus.

Scholten gave an interesting sketch of his own religious development in his *Afscheidsrede bij het Neerleggen van het Hoogleeraarsambt* (1881). See also Kuenen's *Levensbericht*, with a complete list of his writings (1885).

Schomberg, FREDERICK HERMANN, DUKE OF, was born in 1618 of an ancient house taking its name from its castle of Schönburg on the Rhine, and fought against the Imperialists in the Thirty Years' War. Entering the French service in 1650, he conducted a successful campaign in Spain, was naturalised in France, and, though a Protestant, obtained a marshal's baton in 1675. On the revocation of the Edict of Nantes in 1685, after some unimportant work done for the House of Brandenburg and the Elector Palatine, he accepted the post of second in command under the Prince of Orange in the English expedition. The new king made him K.G., duke, and master of the ordnance, and gave him command of the army in Ireland in 1689. Wintering in Ulster, he joined William III. in 1690, and fought and fell in the battle of the Boyne (1st July). His son Meinhart commanded the right wing, and was made Duke of Leinster. But in the war of the Spanish succession he was recalled as inefficient for his command, and died childless in 1709, the title dying with him. The fourth Marquis of Lothian married a granddaughter of the first Duke of Schomberg.

Schomburgk, SIR ROBERT HERMANN, a traveller, was born at Freiburg in Prussian Saxony, June 5, 1804. He was trained for the mercantile profession, and went out to the United States in 1829, but in the following year he removed to Anegada, one of the Virgin Isles. Having surveyed the island and laid a report before the Royal Geographical Society, he was charged by that body to lead an exploring expedition to British Guiana in 1835. This enterprise, which was surrounded with formidable difficulties, he satisfactorily achieved, and from time to time laid the results of his investigations before the society, in whose *Journal* they were regularly published. It was during this exploration, and while he was ascending the Berbice River, that he discovered, January 1, 1837, the magnificent aquatic plant, the *Victoria regia* (q.v.), described in his *Description of British Guiana* (Lond. 1840), and his magnificent *Views in the Interior of Guiana* (folio, 1841). In 1840 he returned to Guiana to survey the colony for government, and to draw the long controverted 'Schomburgk-line' as a provisional boundary with Venezuela (q.v.) and Brazil, and was knighted. He was accompanied by his brother Richard, whose *Reisen in Britisch-Guiana, 1840-44* (Leip. 1847-48) embody the results of this expedition. In 1847 the former published an excellent and elaborate *History of Barbadoes*, and in the following year departed for San Domingo, whither he had been accredited as British consul and representative. In this new sphere he continued to pursue his geographical and scientific researches, the results of which he communicated to the Geographical Society till 1853. In 1857 he was appointed British representative to the Siamese court, but returned to Europe ill in 1864, and died 11th March 1865 at Schöneberg near Berlin.

Schönbein, CHRISTIAN FRIEDRICH, chemist, was born at Metzgingen in Württemberg, 18th October 1799, studied natural science at Tübingen

and Erlangen, and visited England in 1826, and after that Paris. In 1828 he was called to a chair in the university of Basel. In 1839 he discovered *Ozone* (q.v.), and invented *Gun-cotton* (q.v.) in 1845, obtaining from it by dissolution in ether the material called *Collodion* (q.v.). In his later years he confined himself chiefly to experiments with oxygen. Of his works the chief are *Das Verhalten des Eisens zum Sauerstoff* (Basel, 1837), *Beiträge zur physikalischen Chemie* (1844), *Ueber die Erzeugung des Ozons* (1844), *Ueber die Verbrennung der Körper in atmosphärischer Luft* (1845). He died at Baden-Baden, 29th August 1868. See *Life* by Hagenbach (Basel, 1869).

Schönbrunn, a royal palace in the outskirts of Vienna, the summer residence of the imperial family, was built by Maria Theresa in 1744, and has attached to it a zoological and a botanical garden. The treaty of Vienna was signed within its walls.

Schönebeck, a town of Prussia, 9 miles by rail south of Magdeburg, on the left bank of the Elbe. Here some 65,000 tons of salt are made annually, and there are a variety of manufactures—machinery, chemicals, percussion caps, starch, varnish, &c. Pop. 15,319.

Schönlein, JOHANN LUKAS, professor of medicine, was born at Bamberg on 30th November 1793, studied medicine at Landshut, Würzburg, Jena, and Göttingen, and began to lecture at Würzburg in 1819. In the following year he was appointed professor of Clinics and Therapeutics there; in 1833 he removed to a similar chair at Zurich; and in 1839 he was called to Berlin to be professor of Pathology and Therapeutics, and to preside over the clinical instruction given in the Charité hospital. He retired in 1859, and died at Bamberg on 23d January 1864. His principal merit is that he introduced into Germany the exact methods of study which were in vogue in England and France, and thus founded what was called the Natural History School of Würzburg (see *MEDICINE*, Vol. VII. p. 119). See *Life* by Rothlauf (1874).

Schoodic Lakes (pron. SKOODIK), a group of twelve lakes in the east of Maine, U.S., drained by the Schoodic, or west branch of the St Croix.

Schoolcraft, HENRY ROWE, American ethnologist, was born in New York state, March 28, 1793, studied at Union College, and in 1817-18 visited the mining region west of the Mississippi, afterwards publishing a *Journal* (1819; revised 1853). He also published a narrative of General Cass's exploring expedition to Lake Superior and the Upper Mississippi (1820), of which he was geologist. In 1822 he became Indian agent for the tribes about the lakes, and in 1823 he married the granddaughter of an Ojibway chief, who had been educated in Europe. From 1828 to 1832 he was an active member of the legislature of Michigan territory, and founded its Historical Society, and the Algic Society of Detroit. In 1832 he commanded an expedition which discovered the sources of the Mississippi (*Narrative*, 1824). While superintendent and disbursing agent for the Indians, he negotiated treaties by which the government acquired lands to the extent of 16,000,000 acres. In 1845 he collected the statistics of the Six Nations (*Notes on the Iroquois*, &c. 1848). In 1847 congress authorised him to gather, collate, and edit all accessible information relating to the Indians. The result is to be found in his *Historical and Statistical Information respecting the History, Condition, and Prospects of the Indian Tribes of the United States* (5 vols. 1851-55, published by congress at a cost of nearly \$30,000 per vol., with over 300 illustrations; a sixth was added by Schoolcraft in 1857). His numerous other works include many

poems, a *Life of Cass*, *Algic Researches* (1839), *The Red Race of America* (1847), *Thirty Years with the Indian Tribes* (1851), *The Indian in his Wigwam*, &c. He died 10th December 1864.

School Inspectors. After annual government grants for education were commenced in 1846 (see *EDUCATION*), H.M. Inspectors of schools were appointed. Inspection was intended to be a means of co-operation between the government and the clergymen, local committees, and trustees of schools, for the improvement and extension of education; it was not intended as a means of exercising control, but of affording assistance; not for the restraint, but encouragement of local efforts. The inspector was instructed to communicate with those who had up to that time interested themselves in education with a view to such co-operation. He was also instructed to visit, when conveniently able to do so, any schools not aided by public grants whose school committees or promoters desired such visits. The general duties of the inspector were gradually divided into three distinct heads: (1) Furnishing information to enable the committee of Council to determine the propriety of granting funds in aid of erecting new schools. (2) Inspecting and reporting on the method and matter of instruction in schools aided by public grants. (3) Furnishing information when required by the committee of Council respecting the state of education in particular districts. These instructions, with such additions as the fuller development of the system required, continue to describe generally the relation between the committee of Council, inspectors, school managers, and teachers, with the single exception that, on the passing of the Education Acts of England in 1870 and of Scotland in 1872, religious teaching was removed from inspectorial supervision. As the various religious bodies both in England and Scotland had hitherto taken by far the keenest interest in education, before any inspector was appointed his name was submitted for approval to the authorities of the church over whose schools he was to have supervision. Up to the passing of the Acts of 1870 and 1872 there were five classes of inspectors for the schools respectively of the Church of England, of bodies not connected with that church, of the Church of Scotland, of the Free Church, and of the Roman Catholic Church. Now every inspector visits every aided school in his district irrespective of denomination; and since the passing of these acts the churches are not consulted about the appointments.

As grants were steadily increasing, and there was considerable doubt as to the efficiency both of instruction and inspection, Mr Lowe (Lord Sherbrooke) introduced in 1862 the Revised Code, the leading feature of which was individual examination and payment by results. The passing of the English Education Act in 1870 and of the Scotch Act in 1872, and the codes framed upon them, introduced most important changes; but the fundamental principle of payment by results, which had been operative for about ten years in England, was retained, and for the first time applied to Scotland. In 1885 the administrative functions of the English and Scotch departments were separated; and the latter has now a committee of Council and secretary of its own; but the Lord President of the Council is the head of both departments. Provision has from time to time been made to prevent the examination becoming a mechanical recording of results, and by the Codes of 1890 (England) and 1891 (Scotland) a more elastic method of examination was applied both to higher and lower standards. The English and Scotch Codes are on similar lines, and differ only in unimportant details. The fixed grant on average attendance was much enlarged, and the

variable grant depending on examination correspondingly reduced, enough, however, being left to differentiate fair, good, and excellent work. The basis of this variable grant also is average attendance. The minimum number of attendances hitherto qualifying for examination was removed, and thus the temptation to neglect those whose attendance fell below that minimum.

There are four classes of officers engaged in inspection—chief inspectors, district inspectors, sub-inspectors, and assistants. In England there are twelve chief inspectors, two being almost wholly occupied with the training colleges. In Scotland there are three, one of whom combines ordinary inspection with supervision of the training colleges. The chief inspector, besides having a district of his own, has a general supervision over the other districts in his division, and is appealed to in cases of difficulty. Each chief has an annual divisional conference with his colleagues, the object of which is to compare experiences and, as far as possible, secure uniformity of test and standard. Assistants are chosen by the department from the ranks of eminent elementary teachers, and from them sub-inspectors are appointed. The English staff consists of 107 inspectors, 45 sub-inspectors, and 152 assistants; the Scotch staff, of 25 inspectors, 4 sub-inspectors, and 21 assistants. Of the 25 school inspectors, 5 are Oxford, 4 Cambridge graduates; almost the whole of the others and a number of the sub-inspectors and assistants are graduates of Scotch universities. Inspectors are appointed by a minute of the committee of Council, and must be not more than thirty-five years of age. Applications with testimonials are made to the Right Honourable the Lords of the Committee of Council on Education. Those appointed are at first placed alongside of a chief inspector, with the result that they obtain considerable experience of the work before being placed in independent charge of a district. They are, as a rule, selected on the ground of academical distinction, and all but very few have had considerable experience as teachers. In Ireland only, candidates for the inspectorship have to pass an examination in the theory and practice of education, and of school management, besides spending a period of probation under a chief inspector.

In the United States inspectors are known as superintendents of schools, whose duty includes both inspection (in regard to the discipline and methods of the school) and examination (of the pupils, to ascertain the amount and kind of progress made). On the continent of Europe generally inspectors are drawn from the ranks of elementary teachers, and have less to do with examination of the pupils' attainments than with seeing that the law is obeyed, the school programme carried out, and the teachers perform their work properly.

Schools. See EDUCATION, ARMY (Vol. I. p. 439), MILITARY SCHOOLS; ART (Vol. I. p. 456); the articles on the nine great English public schools; and for the Schoolmen, SCHOLASTICISM.

Schools, BROTHERS OF CHRISTIAN, a religious congregation in the Roman Catholic Church, established for the religious and secular education of the poor. It originated in France in the end of the 17th century, and was organised by a charitable ecclesiastic, the Abbé de la Salle, canon of the church of Rheims (1651–1719), who in 1684 resigned his canonry, sold his possessions for the poor, and drew up rules for his brotherhood of teachers—all lay brothers and subject to one general head. Teaching was made gratuitous for day-scholars, but boarders and day-boarders paid fees. Learning Latin was not obligatory on the poor; after the catechism the basis of the teaching was reading

and writing the mother-tongue. On this ground it has been claimed for the canon of Rheims that he was really the founder of organised primary schools and primary education. The brothers devote themselves by a vow to the profession of teaching for life, and are trained in normal schools of their own. They wear a special ecclesiastical costume, and work always in pairs, and, though laymen, are bound by the usual vows of poverty, chastity, and obedience. In 1725 Benedict XIII. issued a bull recognising them as a religious congregation. It still continues to flourish in France (in spite of the secularisation of public schools), as also in Belgium, Italy, southern Germany, Great Britain, North America, and Africa. Their system of education has received the highest testimonies, and they still form one of the most flourishing of all the lay orders in the Catholic Church. The brothers have over 2000 schools, with some 325,000 scholars—more than two-thirds of them in France and her colonies, and the most part receiving gratuitous education.

The *Institute of Irish Christian Brothers* was founded at Waterford in 1802 by Ed. Ignatius Rice, merchant. Branches of the order were soon established in Dublin, Cork, and other towns, especially in the south of Ireland. The institute was formally approved as a congregation by Pius VII. in 1820, and since then has received many favours from succeeding pontiffs. It is governed by a superior-general, who resides at the head house in Marino, Dublin. For a time the Brothers accepted a government grant under the National Board of Education, established in 1832, but soon withdrew from this connection on account of the separation of religious and secular teaching insisted on by the National Board as a fundamental condition of receiving any share of the grant at its disposal; and since then the Brothers' primary schools have been supported by the voluntary contributions of the people. Their system of teaching has met with the warm approval of successive royal commissions appointed to inquire into the state of primary education in Ireland. There are some 700 Brothers, with 40,000 pupils. Besides primary schools, the Brothers conduct institutions for the deaf and dumb, industrial schools, orphanages, high schools, and colleges; they have also extensive establishments in India, Australia, New Zealand, Gibraltar, and Newfoundland.

Schooner is a swift, sharply-built vessel, carrying usually two masts, though occasionally a greater number, and commonly is of small size.



Topsail Schooner.

There are two classes of schooners—the 'fore-and-aft schooner,' or schooner proper, and the 'topsail-

schooner.' In the former both foremast and mainmast are rigged like the mainmast of a cutter, with fore-and-aft Sails (q.v.). In the latter the foremast carries a square topsail and a square topgallant-sail. Topsail schooners, though carrying no square foresail, have a squaresail for running free which sets from the deck. On a wind the former rig has a great advantage, as the schooner can sail up within 4½ or even 4 points of the wind; but before the wind the square topsail gives the advantage

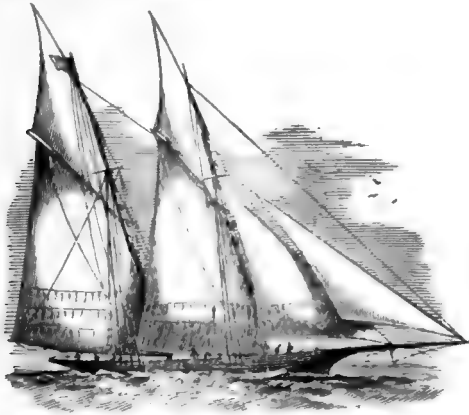

Fore-and-aft Rigged Schooner.

to the topsail schooner; and as the latter can on occasion strike her squaresails, and set a fore-and-aft topsail in their place, she has usually the preference. No sailing-vessel is faster than a schooner of fine build when she carries ample canvas; hence it is a favourite form for the larger class of Yachts (q.v.), and before the introduction of steam despatch-vessels was employed much in the packet service. Schooners are still employed to a great extent in the merchant service for running small cargoes, and especially those of perishable goods, as fish or fresh fruit. They are easily managed by a small crew, but, from the sharpness of their build, have no great amount of stowage.

Schopenhauer, ARTHUR, the founder of systematic modern Pessimism (q.v.), was born at Danzig, 22d February 1788. His father was a banker; his mother, Johanna Trosina (1776-1838), wrote twenty-four volumes of novels and novelettes, and on her husband's death settled in 1806 at Weimar, where she saw much of Goethe. Schopenhauer, after resigning the business career for which his father had trained him by travel and residence in foreign countries (France, England), acquired a classical education at the schools of Gotha and Weimar; and having after his father's death inherited a patrimony of £150 a year, entered the university of Göttingen in 1809, heard later Fichte and Schleiermacher, and devoted much attention to physical and medical science in Berlin. He graduated at Jena with his first work, *On the Fourfold Root of the Principle of Sufficient Reason*, a treatise in which he seeks to classify the principles which determine respectively the provinces of Physics, Logic, Mathematics, and Ethics. Schopenhauer's philosophy, although not devoid of elements of objective value, is a perfect expression of his most unique personality, and cannot be fully understood save in connection with his character. He inherited from his father an unbreakable energy of character (some friends of his youth called him a *Jupiter Tonans*) and cosmopolitan, freethinking sympathies, and from his mother a brilliant polish of mind and facility of

literary expression. His mind was not formed by years of patient acquisition but by the society of his seniors and by a congeries of vivid sights and experiences of travel, and retained to the end its habit of seizing at a conclusion through the force of intuition or apprehension rather than of reasoning. Inner discord was the keynote of his life in that in him the subjective and the objective, feeling and reason, were in perpetual conflict; he believed the tendency of life to be to separate more and more the heart and the head. His disposition was heavy and severe, dark, mistrustful and suspicious, preventing him from entering into permanent trustful relations with men or women: his mother desired him to live apart from her after the death of her husband, and he could hardly think seriously of marriage as he saw only in woman a wayward, mindless animal—ugly too he said—existing solely for the propagation of the species, an end which perpetuated the woe of the world. Lastly he believed that he had brought to the birth a philosophy which made himself the successor of Socrates, since whose time nothing had been done in philosophy save Kant's undoing of the mass of traditional error; and he saw himself and his thinking passed over until he was sixty, and what he regarded as fatuous ravings (the Fichte-Schelling-Hegel philosophy) praised as the highest wisdom, so that he was tempted to believe there was a conspiracy of professors of philosophy against him and his truth. The cardinal articles of his philosophical creed, which he seized as it were by intuition early in life, were: first, Idealism (Idealism is of course more likely to lead to Pessimism than Realism, as it believes the world to be illusory)—Subjective Idealism—i.e. that the world is my idea, a mere phantasmagoria of my brain, and therefore in itself nothing; secondly, that the way of knowledge or speculation to the centre of things, to the 'thing-in-itself,' was demolished for ever by the immortal criticism of Kant (it simply galled him to fury to hear Schelling talking of *knowing* God by 'Intellectual Intuition'); and thirdly, that there was accessible to the mind, to the intuition of genius, the contemplation of the Platonic ideas—that is, the ideas of Art, the only knowledge not subservient to the Will and to the needs of practical life.

His own contribution to the sum of human knowledge, as he thought, was the truth that Will, the active side of our nature, or Impulse, was the key to the one thing we did know directly and from the inside—i.e. the self (all else of course we know from without and through the self), and therefore the key to the understanding of all things from the atom up through plants and animals to the starry systems. His philosophy thus is, as he puts it, that the world is through and through Will, and also (but secondarily) through and through Idea: Will is the creative, the primary, while Idea is the secondary, the receptive factor in things—a mere offshoot from the brain. There is thus a pronounced Materialistic side to Schopenhauer's philosophy which is inconsistent with his Idealism; he always taught too the descent of man from some lower form of life—the basis of his theory that what animals wanted from man was not compassion but justice and equality, although of course as a metaphysician he deprecates a natural as opposed to a philosophical explanation of the world. Time, as he said, is only in us a form of our thought; and Schopenhauer had no sense for history. His chief book, *The World as Will and Idea* (1819), expounds in four books the Logic, the Metaphysic, the Æsthetic, and the Ethic of his view; it teaches a pantheism of the Will (Pantheismus), and defends the extension of the word Will as blind irresistible energy or impulse (it is essential to remember the irrationality of

the Will in Schopenhauer) to include all processes from attraction and gravitation to motivation, which last is simply 'causality seen from within.' He collected in the *Will in Nature* what he deemed the scientific confirmations of his doctrine. The first meed of praise which fell to him was the crowning by the Norwegian Academy in 1839 of his prize essay on the *Freedom of the Will*, in which he defends the phenomenal necessity or determinism of the Will and its supra-sensible freedom. His ethical theory rests on sympathy, the treatment of self and others as not two or many but as one and the same, as both the manifestation of the All-Will which rises to a feeling of hunger in the stomach, gnawing in the teeth, thinking in the brain, &c. Sympathy, however, is only a 'civic virtue'; the highest virtue is asceticism, the denial of the Will to live, in which the Intellect through contemplation of the idea of Art frees itself from desire and willing and pierces the 'Veil of Maya' (Illusion) which hides from us the supra-sensible, and the Will is reduced to its original state of quiescence or potency. Remove the Will from life and there is no more: 'before us there is certainly Nothing.' Schopenhauer preferred Buddhism and Mysticism and Anchoretic Christianity to the reigning forms of religion and to Rationalistic Theism. He gave out his occasional papers in the *Parerga and Paralipomena* (1851), which more than the other works express the man himself, illustrate the eloquence of his pen, and perhaps have led people to his shrine who know next to nothing of his strict theory. In an appendix to *The World as Will and Idea* he criticises the Kantian theory of knowledge as laying too much weight on the Reflective or Indirect Method as opposed to the Intuitive or Direct. His essay on *Seeing and Colours* (1816) contains practically Goethe's theory of colours; Goethe had been pleased to get Schopenhauer's help in his optical researches, and had predicted for Schopenhauer a hearing in the world. From Weimar and university circles Schopenhauer had gone to Dresden (1814-18) for the writing of *The World as Will and Idea*; thence he had gone to Italy; his unsuccessful attempt as lecturer in Berlin University was made in 1820. Of two lawsuits one concerning money matters was settled in his favour through his own legal acumen; the other ended in his having to pay £9 a year to a seamstress as compensation for injuries received by her when the irate philosopher ejected her with violence from his rooms as an intruder. After renewed travel and residence in the south he finally in 1831 left Berlin for Frankfurt-on-the-Main, where he chose to live as an isolated thinker until his death there, 21st September 1860. Frauenstädt, his literary executor, was the chief of his 'evangelists' and 'apostles'—as he called the most enthusiastic of his admirers.

The complete works, edited by Frauenstädt, appeared in 6 vols. in 1876. There is an English translation of *The World as Will and Idea*, by Halldane and Kemp (1883-86), and of the *Fourfold Root and Will in Nature* (1888); and a volume of *Selected Essays*, by E. B. Bax, appeared in 1891. Mr Saunders in his Schopenhauer series has translated somewhat from the *Parerga*, &c. The first magazine article on Schopenhauer which drew attention to him abroad was in the *Westminster Review* (vol. III, new series, 1853, pp. 398-407). The best life is by Gwinner (Leip. 1862; new ed. 1878). Frauenstädt writes on Schopenhauer's life and philosophy in an introduction in vol. I. of the *Works*. See also his *Letters on the Philosophy of Schopenhauer* (Leip. 1854), &c. Miss Zimmer's life (1876) and that of Professor Wallace (1890, with bibliography) are both very good. See also the larger histories of philosophy: German works by Haym (1864), Busch (1874), and Koeber (1888); the bibliographies by Laban (1880) and Hertslet (1896); the *Shaw Lectures* on Schopenhauer by the present writer (1896); and works cited at the article *Pessimism*.

Schorl-rock, a compound of quartz and schorl or black Tourmaline (q.v.). It may be fine or coarse grained. Sometimes it consists principally of quartz with prisms of schorl scattered irregularly through it; at other times it may be so fine grained as to form a blackish-gray mass in which the naked eye cannot distinguish the separate ingredients. The rock occurs associated with granite and the crystalline schists.

Schottische (a Frenchified form of the German word for *Scottish*), a somewhat fanciful name given to a slow modern dance in ¾ time.

Schouvaloff, COUNT PETER ANDREIEVITCH, Russian ambassador, was born at St Petersburg on 15th July 1827, became head of a department in the ministry of the Interior in 1862, and in 1866 head of the secret police; in 1873 he was sent on a secret mission to London, when he arranged the marriage between the Duke of Edinburgh and the only daughter of the Emperor Alexander II. In 1878 he was one of the representatives of Russia at the Congress of Berlin. He died 22d March 1889.—His brother, COUNT PAUL, born in 1830, entered the army and took part in the defence of Sebastopol and in the battle of Inkermann. As head of a department in the ministry of the Interior he helped to organise the liberation of the Russian serfs (1861). In the war of 1878 he held a command at Philippopolis. In 1885 he was appointed ambassador to Germany, and in 1895 governor of Warsaw; and in 1897 he retired.

Schouwen, an island of Holland, in the province of Zeeland, with an area of 62 sq. m. and a pop. of 24,000, who grow madder, refine salt, and salt fish. Chief town, Zierikzee.

Schrader, EBERHARD, a learned Assyriologist, was born at Brunswick, January 5, 1836, studied at Göttingen, where his bent to oriental studies was confirmed by Ewald, and became ordinary professor of Theology at Zurich in 1863, Giessen in 1870, and Jena in 1873. In 1875 he obeyed a call from Berlin to the chair of Oriental Languages, with a seat in the Academy of Sciences.

His earliest books were devoted to Old Testament criticism—*Studien zur Kritik und Erklärung der biblischen Urgeschichte* (1863), and a fresh edition—the eighth—of *De Wette's Einleitung* (1869). Turning next to Assyriology, he quickly placed himself at the head of German scholars by an unrivalled combination of wide erudition and critical sagacity. His books are *Die Assyrisch-Babylonischen Keilinschriften* (1872); *Die Keilinschriften und das Alte Testament* (1872; 2d ed. 1883; Eng. trans. 2 vols. 1885-86); *Die Höllenfahrt der Istar* (1874); *Keilinschriften und Geschichtsforschung* (1878), in which he combats in masterly fashion the attack of the historian Gutschmid on the method and result of work in the cuneiform inscriptions; and *Zur Frage nach dem Ursprung der Babylon. Kultur* (1884). There is a translation by Mr F. B. Jevons of his important *Prehistoric Antiquities of the Aryan Peoples* (1890).

Schreiner, OLIVE, a gifted South African authoress, daughter of a Lutheran clergyman at Capetown, who startled the conventional English world of letters in 1883 by '*The Story of an African Farm: a Novel*. By Ralph Iron.' The simple yet forcible style of its pictures of rough life on a Boer farm, and of the spiritual problems that rend an inquiring soul, the penetrating pathos, and the feeling of intense personality underlying the book arrested even the readers of the circulating library. *Dreams* (1890), a group of spiritual allegories, was followed by *Dream Life and Real Life* (1893) and *Trooper Peter Halket of Mashonaland* (1897). Married in 1894 to Mr Cronwright, Mrs Schreiner-Cronwright actively opposed the general policy of Mr Cecil Rhodes.

Schrevelius, CORNELIUS, born at Haarlem in 1615, became in 1642 rector of the university of

Leyden, and died 11th September 1664. He was a laborious and erudite man, but possessed little critical discernment. His most notable performance was a *Lexicon Græco-Latinum et Latino-Græcum* (Leyden, 1654), of which there have been innumerable editions. He also executed between 1648 and 1665 many *variorum* editions of the classics—Juvenal, Hesiod, Terence, Virgil, Horace, Homer, Martial, Lucan, Cicero, Ovid, and Claudian.

Schubart, CHRISTIAN DANIEL, poet, was born 13th April 1739 at Sontheim in Swabia, and studied theology, afterwards becoming school-master and organist, first at Geisslingen and then at Ludwigsburg. But he wrote satirical poems and spoke unadvisedly, lost his post, and then led a wandering life in various cities and countries, giving poetical readings and piano performances. He got into difficulty in Austrian territory at Ulm, was enticed back to Württemberg by the prince, whom he had greatly irritated by a stinging epigram, was carried to the fortress-prison of Hohen-Asperg (1777), and there pined for ten years. Then he was set free by intervention of the Prussian court, and straightway appointed court musician and theatre-director at Stuttgart to the same prince who had kept him all these years in prison. But he was utterly broken in health, and died 10th October 1791. His poetry is very unequal in value; he was an effective satirist of abuses in church and state, and some of his patriotic pieces, odes and hymns, have real poetic worth; but he is chiefly remembered for his tragic fate, and for the influence his work exercised on Schiller. His *Gesammelte Schriften* (including essays and newspaper articles) fill 8 volumes.

See the autobiographical *Schubarts Leben* (1793), and monographs on the man by D. F. Strauss (1849), Hauff (1885), and Nägele (1888).

Schubert, FRANZ PETER, the celebrated composer, was born in Vienna on January 31, 1797. His father, who came of a Moravian peasant stock, had settled some years previously as a school-master in a district of the city called the Lichtenthal; his mother before her marriage had been a cook. Their two elder sons, Ignaz and Ferdinand, adopted the father's calling. Franz's musical gifts very early declared themselves. At first he was taught the violin by his father, and the piano-forte by his brother Ignaz; but he very soon outstripped their powers of instruction. His training was therefore entrusted to Holzer, organist of the parish church, whose raptures over the boy's talents were a poor substitute for the conscientious care which they demanded. Before he was eleven years of age young Schubert was leading soprano in the Lichtenthal choir, whence he was soon transferred to the Konvikt or choristers' school of the Court-chapel. Franz at once took his place as one of the violin-players in the school band, where he soon became leader. The constant practice thus afforded him was doubtless an inestimable advantage, though it must always be regretted that his theoretical training was practically left to take care of itself; for Ruzicka, the music-master at the Konvikt, seems to have taken much the same line with Schubert as Holzer had done before him. The circumstances of the school were not favourable to study. The boys were allowed to go hungry, and in winter without fire, so that even practice was carried on under difficulties. But Schubert's thirst for composition triumphed over all such obstacles, and in its endeavour to be satisfied interfered seriously with his progress in the ordinary curriculum. He made many friends at this time, for his schoolfellows were all proud of his gifts and were delighted to

take part in the performance of his compositions; while in Spaun, one of the senior choristers, he found a benefactor who kept him supplied with music-paper, a luxury beyond the reach of his own very slender resources. During the five years thus spent Schubert tried his hand at almost every kind of composition, the work which marks the completion of this period being a symphony in D (October 28, 1813).

On his departure from the Konvikt he became an under-teacher in his father's school in order to avoid the conscription. Even at this early date he wrote some of his most enduring compositions. Of these may be mentioned that immortal song the *Erl King*, truly marvellous as the work of a youth of eighteen, and the Mass in F, first performed by the Lichtenthal choir under the direction of the composer. Among those who congratulated him on this occasion was Salieri, under whose guidance his more recent studies had been made. Schubert's delivery from the drudgery of his father's school was brought about by Franz von Schober, a young man of his own age, who had met with some of his songs, and who, on coming to the university of Vienna, lost no time in finding out the composer. As soon as he became aware of Schubert's anomalous position, he proposed that he should share his lodging and be free to devote himself entirely to his art. Franz fell in with the arrangement, which, however, was put an end to by the interference of Schober's brother after a few months, when Schubert was doubtless laid under a similar obligation to other friends; for, with the exception of £4 paid to him for a cantata written for a Herr Watteroth, his work as yet had brought him in nothing. His short residence with Schober was marked by an event which had a lasting influence on his career—his acquaintance with Vogl, the eminent singer and actor, who very soon appreciated his genius, and became his firm and most valued friend. Vogl's fine literary taste enabled him to curb that omnivorous instinct of Schubert's which impelled him to lavish his treasures of melody on words altogether unworthy of them. To him also Schubert owed the recognition (inadequate as it was) of his talents by the Viennese, for Vogl constantly sang his songs at the houses of people of influence in the first instance, and eventually in public.

In 1818 Schubert became teacher of music in the family of Count Johann Esterhazy at his country seat at Zelész, in Hungary, where he passed several months, finding in the beauty of his surroundings a new stimulus to composition. The end of the year, however, saw him back in Vienna and installed in lodgings with the poet Mayrhofer. The two would often work together in the same room, the one writing verses which the other as rapidly set to music. On February 28, 1819, Schubert was first brought before the public as a composer by the performance of one of his songs, the *Schäfers Klagelied*, at a concert in Vienna. In the summer he made an extended tour with Vogl, and found time to compose, during a halt at Steyr, his well-known pianoforte quintett (op. 114). His comic operetta, the *Zwillingenbrüder*, finished 19th January 1819, was produced at the Kärnthnerthor theatre on June 14, 1820, and two months later came the first performance of the *Zauberharfe* at the Theater-an-der-Wien. His appearance in print was delayed until April 1821, when his old schoolfellow Leopold Sonnleithner and another friend named Gymnich had the *Erl King* engraved at their own cost. But as Schubert's songs began to be heard more frequently the enthusiasm with which they were received at length overcame the hesitation of publishers in accepting his MSS. As

many as twenty songs were issued in eight months, but unfortunately no permanent pecuniary benefit was secured to the composer. In 1822 Schubert completed his opera *Alfonso and Estrella*, the libretto of which was furnished by Schober. It was rehearsed at Gratz, but was not brought to performance during the composer's lifetime. Liszt produced it at Weimar in 1854; but it did not meet with any real success until March 1881, when with a new libretto and considerable curtailment it was produced at Karlsruhe. To 1822 belong also the two movements of the unfinished symphony in B minor, in which for the first time in his orchestral writings Schubert displays a complete individuality. His first acquaintance with Weber and his formal introduction to Beethoven are also noteworthy among the events of this year.

During 1823 Schubert devoted much attention to dramatic music, writing with great rapidity the three-act opera of *Fierabras*; but to himself these labours resulted only in intense disappointment and depression, although we owe to his efforts in this direction the beautiful *Rosamunde* music, the orchestral parts of which were discovered at Vienna in 1867 by Sir George Grove in a cupboard where they had remained untouched for forty-four years. A second long stay with the Esterhazys at Zélez restored Schubert from his state of extreme dejection, the visit being marked by the composition of many important works, including some pianoforte duets written for his two pupils, the daughters of Count Esterhazy. Of these the best known is probably the *Divertissement à la Hongroise*, inspired by Hungarian airs which Schubert heard sung by a servant as he passed the door of the kitchen. The summer of 1825 was devoted to a pleasant tour with Vogl, the two friends delighting every one with their performance of Schubert's new songs from Walter Scott's *Lady of the Lake*, to which he referred when he wrote 'The way in which Vogl sings and I accompany, so that for the moment we appear to be one, is something quite new and unexpected to these good people.' And yet the seven songs which proved so successful were sold on his return to Vienna for the paltry sum of £20!

The compositions of 1826 included a quartett in D minor and the pianoforte sonata in G, usually known as the *Fantasia*. One of Schubert's happiest inspirations, the song *Hark! Hark! the lark*, came suddenly upon him as he sat in a beer-garden one Sunday afternoon in July; his other Shakespearian songs, *Who is Sylvia?* and the 'drinking song' in *Antony and Cleopatra*, being also attributable to this date. In the autumn he missed a probable appointment as director of the music at the Court Theatre of Vienna through his refusal to alter certain pieces which he had composed as a test of his fitness for the post. Some months later Schubert's songs were brought under the notice of Beethoven. They were put into his hands during his last illness by his devoted attendant Schindler, who had Schubert's welfare much at heart. The perusal of them was a revelation to him, and drew from him the exclamation: 'Truly Schubert has the divine fire!' A recurrence of his malady prevented his acquaintance with Schubert's other works, but he often spoke of him and foretold the stir which he was destined to make in the musical world. During these days Schubert twice visited the man whom of all others he admired, and, when the end had come, was one of the torch-bearers at Beethoven's funeral.

In 1827 Schubert was elected a member of the representative body of the Musical Society of Vienna, an honour which he greatly appreciated, while his prospects were further brightened by advantageous proposals from foreign publishers, the best possible proof of his growing reputation.

He was thus spurred on to surpass his former achievements in the composition of his noblest symphony (No. 9 in C), begun in March 1828, and if possible more characteristic of him than the earlier one in B minor. His rate of production during this his last year was truly prodigious, for besides the symphony he wrote his Mass in E flat, the oratorio *Miriam's War-song*, the string quintett in C, and three pianoforte sonatas. He also composed several songs, the words of which his friend Schindler had found among Beethoven's papers. One of these, *Die Taubenpost*, is dated October 1828, and is probably the last piece written by Schubert. He gave his first and, as it proved, his only concert in the hall of the Musik-Verein at Vienna on the evening of March 26. The venture was extremely successful, so that for the time being the needy composer was placed beyond want, although he had to abandon his usual summer excursion on account of his poverty, which must indeed have been extreme, since he was driven to dispose of some of his finest songs for a few pence apiece.

At the end of August he took up his abode with his brother Ferdinand in a new house in the suburb of Neue Wieden, but the change seems to have had a bad effect upon his already weak state of health. He recovered sufficiently to join some friends in a short walking tour; but his illness soon returned, bringing with it complete loss of appetite. Yet he was as active as ever, both in body and in mind. He walked much, and talked of his plans for a proposed new opera, *Graf von Gleichen*. He was able to go to hear Beethoven's quartett in C sharp minor, which greatly moved him, and to attend the first performance of a Requiem composed by Ferdinand Schubert. At the same time a study of Handel's scores caused him to reflect upon his own deficiencies in counterpoint, and to determine to remedy them by a course of lessons with Sechter, the best-known authority on the subject. The dates of the lessons were fixed and the text-book chosen. But Schubert's time for work was now over. On November 11 he wrote to Schober telling him that for eleven days he had taken neither food nor drink, and asking for some of Cooper's novels to read. A few days later he became delirious and was found to be suffering from an attack of typhus fever, to which he succumbed on Wednesday, November 19, 1828, in the thirty-second year of his age. In accordance with his latest wish his remains were buried near Beethoven's grave in the cemetery of Währung; they were reinterred in the central cemetery of Vienna on September 23, 1888.

Among composers Schubert is remarkable for the apparently ceaseless impulse to compose which possessed him; and, as a consequence, for the vast and, considering the shortness of his life, almost incredible quantity of music with which he has enriched the world. He is still more renowned for the absolute spontaneity of his writings and for the poetic spirit with which he has imbued them. But his special and peculiar eminence lies in the department of song-writing, in which he reached the highest limit of excellence, the earliest of his lyrical productions affording perfectly mature examples of artistic musical form applied to song. In other branches of composition the deficiencies of his theoretical training are often evident, but here his instincts were never at fault. There were occasions when the torrent of inspiration rushed upon him with irresistible force. At such times the recitation or perusal of a poem seemed to touch some hidden spring in him, and in a few moments he had wedded it to music in such perfect accord with the words that the finest poems of the greatest poets were by this means not so much enhanced as transcended. His usual

custom, however, was to write steadily for a long time every morning; and he would sometimes compose six or seven songs in his best manner in less than as many hours. But the lyrical spirit was by no means confined to his songs; it found its way into his instrumental works, which reveal a wonderful prodigality of ideas, although comparatively little learning is displayed in turning them to account. In his orchestral writings Schubert is celebrated for extraordinary delicacy in his method of instrumentation, especially in his treatment of the wood-wind; and this is the more remarkable from the fact of his never having heard the effect of his very finest passages—for some of his noblest pieces were not performed until long after his death. He rarely altered anything he had written, and could never understand the immense pains taken by Beethoven in perfecting his scores. Schubert wrote as one impelled by imperious necessity to relieve his mind of ideas, which in his case were sometimes forgotten as soon as they were committed to paper—a fact which will be the more readily appreciated when it is remembered that, although his years were fewer than those of any other master of the first rank, he composed more than 500 songs, ten symphonies (including two left unfinished), six masses, a host of sonatas and other works for the pianoforte, a number of string quartets (those in A minor and D minor being especially fine), as well as several operas, cantatas, and overtures. Schubert's personal character was extremely modest and retiring; hence perhaps, to some extent, his failure to obtain any permanent appointment by which he might have been delivered from that sadly precarious mode of existence which doubtless hastened his end. His sweetness and amiability of disposition endeared him to every one, while he was generous to a fault. The insignificance of his appearance gave no token of the genius it concealed; his friend Lachner describes him as 'looking like a cabman.'

For an exhaustive account of Schubert's life, together with a complete list of his works, see the article by Sir George Grove in his *Dictionary of Music*. There are Lives by Kreissle von Hellborn (1866) and Reissmann (1873); see also the *Beitrag* by Max Friedländer (1883).

Schultz, HERMANN, theologian, born at Lüchow in Hanover, December 30, 1836, studied at Göttingen and Erlangen, and became professor at Basel in 1864, at Strasburg in 1872, Heidelberg in 1874, and Göttingen in 1876. There also he became university preacher and consistorial councillor.

His writings include *Die Voraussetzungen der Christlichen Lehre von der Unsterblichkeit* (1861); *Alttestamentliche Theologie* (1869; 4th ed. 1889; Eng. trans. 1892), a work masterly in its religious insight; *Die Lehre von der Gottheit Christi* (1881), in which he applies Ritschl's method to the central question of Christianity, the Divinity being apprehended neither from the metaphysical nor eschatological point of view, but as the expression of the experience of the Christian community, a human personal life having become the expression of an eternal divine life through a moral rather than a natural miracle; a volume of sermons (1882); *Lehre vom Heiligen Abendmal* (1886); and *Grundriss d. prakt. Theologie* (1889); *Grundriss d. Evangel. Dogmatik* (1890).

Schulze-Delitzsch, HERMANN, founder of the people's banks of Germany, was born on 29th August 1808, at Delitzsch, a small town of Prussian Saxony. He was educated to follow the law, at Leipzig and at Halle, and entered the public service of Prussia; but in 1841 he settled down in his native town as patrimonial judge (a kind of estate manager discharging also judicial and administrative functions), and thenceforward devoted his life to the better economic education of the small farmers and operatives amongst whom he lived. When the National Assembly was called together

in Berlin in 1848 Schulze-Delitzsch, who represented his native town, was chosen chairman of a commission to inquire into the distress prevailing amongst the labouring and artisan classes; and two years later, for protesting that it was unjust to tax the people when their representatives were not allowed to deliberate together, he was tried on a charge of treason, but was acquitted. On his return to Delitzsch he started the first people's bank. In these institutions the subscribers, all contributors of small sums, received credit and dividends in proportion of their savings; the joint credit of the association was used for borrowing money; and the banks were managed by a board of the subscribers. By 1859 there were already more than two hundred of these banks in the central districts of Germany; and in that same year, at a congress which met at Halle, these were united under one organisation, with Schulze-Delitzsch as manager. The system was introduced with great success into Austria, Italy, Belgium, and Russia; and when its deviser and founder died, on 29th April 1883, at Potsdam, there were in Germany alone 3500 branches, having twelve million members, with a share capital of £10,000,000 and deposits to more than twice that sum. In 1861 he again took his seat in parliament, joining the Progressist party and labouring for constitutional reform. When Lassalle began to agitate for state loans to productive associations he found Schulze-Delitzsch, a firm believer in self-help, writing and speaking in opposition to him. 'He who preaches to the people self-help, self-responsibility, self-reliance as the condition of their economic independence and political freedom must in the first place practise these principles in his own life,' such was the social creed he lived by. And when the members of his party wished to make him a gift of £7000 in recognition of his disinterested labours in behalf of social reform, they could only prevail upon him to accept £1000 for himself; the rest he set aside for the payment of men who should promote the cause of social reform. An account of his system of people's banks is contained in *Vorschuss- und Kredit-Vereine als Volksbanken* (5th ed. 1876); besides this he wrote *Die Entwicklung des Genossenschaftswesens* (1870) and other books on co-operation. See *Life* by Bernstein (Berlin, 1879), and a paper by John Rae in *Good Words* (1885).

Schumann, ROBERT, the great apostle of the Romantic school in music, was born at Zwickau in Saxony, 8th June 1810. His father was a man of a distinctly artistic turn of mind, and until his death in 1826 Robert had every encouragement to indulge any taste he had for music. No very decided manifestation, however, was apparent until Schumann's mother and guardian had to face a most unwelcome desire on the part of the young man, who should have been pursuing his law studies. His mother was sorely troubled, and sought advice from Frederick Wieck, the eminent pianoforte teacher. His answer favoured Schumann's ardent ambition, and at the age of twenty-one, after a desultory course of law and philosophy, a good deal of observant travel in Germany, Switzerland, and Italy, and a thorough course of Jean Paul Richter, Schumann began to qualify himself for his great mission, and settled down in Leipzig as an ardent student of music under Wieck. In his haste to become perfect in his art he defeated his own ends; for, not content with arduous practising, he had recourse to mechanical means for improving the power of his hands—one of them so violent that he permanently disabled the third finger of his right hand. He turned perforce to composition, and his misfortune has proved our gain. In 1832 Clara Wieck, his teacher's daughter, wh

though only thirteen years of age was already an accomplished pianist, made a deep impression on Schumann, which later developed into a still deeper and a mutual feeling.

In 1833 his first important pianoforte compositions were published (*Tocatta*, &c.), and in the following year his overflowing energy conceived the idea of a new musical paper, and inspired three friends with the same enthusiasm for art criticism as he had himself. As editor of this *Neue Zeitschrift für Musik* for more than ten years he contributed many essays, some very fantastic, some of inestimable value, and all showing strong imaginative and poetical powers. His critiques on young composers are particularly interesting for their keen critical acumen, their frank admission and fearless proclamation of any good quality in any artist however young or unknown, and their generous encouragement of all earnest workers. For an account of Schumann's charming idea of an imaginary society, the *Davidbündler*, reference must be made to a more detailed notice of his life.

From the year 1836 his genius for composing asserted itself more and more, and it is very interesting to notice how it seems to have turned deliberately and methodically from one branch of composition to another. His greatest pianoforte works were written between 1836 and 1839 (*Fantasia*, *Novelletten*, *Kinderscenen*, *Kreisleriana*, *Humoreake*, *Faschingschwank*, &c.). The reception of these works was on the whole very encouraging, and against the neglect of some authorities, and the adverse criticism of others, Schumann had the support of such as Liszt and Moscheles.

In 1835 Mendelssohn came to Leipzig filled with the energy and enthusiasm which in a few years raised Leipzig to the dignity of the most important musical centre in Germany. Schumann with ready and generous appreciation at once fell down and worshipped. 'I look up to Mendelssohn as to a high mountain peak,' he wrote. He accepted a professorship in the new Conservatorium, but he was eminently unfitted for such work, and in a short time he resigned the appointment. In 1836 a visit to Vienna yielded important though indirect results. Interested as he was in Franz Schubert's writings, he made thorough investigations for possible MSS., and was rewarded with the score of the C major symphony, which he forwarded to Mendelssohn in Leipzig, and it was performed there for the first time eight years after the composer's death. At length in 1840, in spite of Wieck's opposition, he married his daughter Clara Josephine (born 13th September 1819). And as the time of trial had inspired some of his most tender works, notably many songs, so the perfect happiness of the next few years gave his compositions an impulse to a richer, fuller style, characterised by more repose. In the following year he turned his attention to instrumental work, and rapidly produced three symphonies and the romantic concerto in A minor. Chamber music next claimed his attention, and the three beautiful quartets prepared the way for what is probably the most widely popular, as it is one of the most perfect of all Schumann's concert pieces—the *Quintett* for pianoforte and strings. The pianoforte *Quartett* belongs to the same year (1842). In 1843, the last year of his residence in Leipzig, he produced two important choral works, *Paradies* and *the Peri*, which met with great success, and scenes from *Faust*. But the insidious disease which had been working in his brain since early youth, and which bereft him of reason before his death, first broke out now in unmistakable symptoms, and in order to comply with medical advice he left the exciting musical life of Leipzig and settled in Dresden. For more than two years the

state of his health gave his friends great anxiety, but in 1847 the clouds lifted—only, alas, to gather for the last dark years. From 1848 to 1850 works of all kinds appeared in rapid succession—*Genoëva* (his only opera), incidental music to Byron's *Manfred*, songs, and much instrumental solo and concerted music.

In 1850 Schumann was invited to succeed Dr Hiller as musical director in Düsseldorf—a post for which he was as unfitted as he had proved for the professorship in Leipzig. He had none of the qualities so necessary in a conductor—concentration of attention, prompt decision, resource; and an eyewitness of the circumstance assured the present writer that on one occasion Schumann in a fit of absent-mindedness went on beating time after the piece had concluded!

Much desultory work, some remarkably fine, some only grand fragments, some never attaining beyond ambitious design, belongs to the years in Düsseldorf (1850–54); but it became ever more and more evident that he must retire from his post as a conductor, and this, naturally enough, he could not be induced to consider necessary. Hence arose ill-feeling and unpleasantness. In 1851 his former ailment broke out anew, and his eccentricity gradually grew more marked. He was subject to most curious delusions, and devoted himself largely to the art of table-turning and spiritualism. One famous delusion was that the spirits of Schubert and Mendelssohn visited him; and once he jumped up during the night to note down a theme given him, as he imagined, by Schubert—the unfinished Variations on which were his last work. In February 1854, during an attack of extreme depression, he threw himself into the Rhine, but was rescued by boatmen. Insanity had asserted its sway, and Schumann spent the last two years of his life in a private asylum near Bonn, where he died in his wife's arms, July 29, 1856, aged only forty-six.

The characteristics of Schumann's compositions are great originality and fertility in subjects and themes, freshness, force, and piquancy in rhythm, and a wealth and resource in harmony which places him among composers not far from Bach himself. Those works which are cast in certain forms, as sonatas, symphonies, &c., do not always follow the recognised canon, but the exuberance of what is generally self-contained and restrained fancy maintains such unflagging vivacity and interest that the analytical faculty is often quite disarmed. Among writers of songs and ballads he is second to none. The extreme originality and unconventionality of his work account for a tardy appreciation, but he has won a secure place now among the great composers. His talented and devoted wife laboured incessantly to obtain a hearing for his pianoforte compositions, and she lived to see her labours crowned with success. After his death she taught at the Frankfort Conservatoire, and played in the chief cities of Europe—her visit to London in 1886 was a splendid success. She died 20th May 1896.

Other biographies and criticisms will be found in Wasielewski's *Robert Schumann* (Dresden, 1858; 3d ed. Bonn, 1880; Eng. trans. 1878), the work of an intimate friend and a long recognised authority; Dr Spitta's admirable article in *Grove's Dictionary of Music*; Reissman's *Life and Works of Robert Schumann* (Eng. trans. 1886); Pohl's 'Reminiscences' (*Deutsche Revue*, vol. iv. Berlin, 1878); Fétis, in the *Biographie Universelle* (a singularly unappreciative estimate); *Life of Schubert told in his Letters* (trans. from the German by May Herbert, 2 vols. 1800); innumerable notices and criticisms in periodicals (such as E. Prout, in the *Monthly Musical Record*, 1871–79; J. Bennet, in the *Musical Times*, 1879); but the *Life* (1892) by Professor Niecks of Edinburgh, who has had access to the best authorities, must henceforth rank as the standard authority.

Schürer, EMIL, a learned biblical scholar, was born at Augsburg, 2d May 1844, studied at Erlangen, Berlin, and Heidelberg, became professor of theology first at Leipzig, in 1878 at Giessen, in 1890 at Kiel, and in 1895 at Göttingen. He edited the *Theologische Literatur-zeitung* from its commencement in 1876 until his association with Harnack in 1881.

His books are *Schleiermacher's Religionsbegriff* (1868); *De Controversiis paschalis* (1869); and the *Lehrbuch der Neutest. Zeitgeschichte* (1874), re-issued in its second edition (2 vols. 1886-87) under the title *Geschichte des Jüdischen Volkes*. This splendid work has been translated into English (5 vols. 1886-90).

Schurz, CARL, born near Cologne, 2d March 1829, entered Bonn University in 1846, joined Kinkel (q.v.) in the revolutionary movement of 1848-49, and the next year returned from Switzerland and effected his master's escape. In 1852 he passed to the United States, where he speedily engaged in politics, lectured, practised law, and as major-general of volunteers took part in several battles during the civil war. Journalism next engaged his attention till in 1869 he was elected to the United States senate. In 1877 he was made Secretary of the Interior, and from 1880 to 1884 he was again an editor. In 1887 he published a *Life of Henry Clay*, and a *Life of Lincoln* in 1892.

Schuyler, PHILIP JOHN, a leader of the American Revolution, was born at Albany, 22d November 1733, raised a company and fought at Lake George in 1755, and rendered other services during the French and Indian War. He was a member of the colonial assembly from 1768, and was a delegate to the Continental congress of 1775, which appointed him one of the first four major-generals. Washington gave him the northern department of New York, and he was preparing to invade Canada when ill-health compelled him to hand the command over to General Montgomery. He still retained a general direction of affairs from Albany, but jealousies and complaints, especially from Gates, rendered his work both hard and disagreeable, and in 1779, after a congressional committee had acquitted him honourably of all charges, he resigned. He would not again accept a command, although he remained one of Washington's closest friends and advisers. Besides acting as commissioner for Indian affairs, and making treaties with the Six Nations, he sat in congress from 1777 to 1781, and was a state senator for thirteen years between 1780 and 1797, a United States senator in 1789-91 and 1797-98, and surveyor-general of the state from 1782. With Hamilton (who married a daughter) and John Jay he shared the leadership of the Federal party in New York; and he aided in preparing the state's code of laws. He died at Albany, 18th November 1804. See the *Life* by B. J. Lossing (enlarged ed. 2 vols. 1872), and G. W. Schuyler's *Philip Schuyler and his Family* (2 vols. New York, 1888).

Schuykill (pron. *Skoolkill*), a river of Pennsylvania, which rises in the coal region, near Pottsville, and, flowing 130 miles south-east, past Reading and Norristown, empties into the river Delaware at the southern limit of Philadelphia. This city is built on both sides of the Schuykill, and draws its water-supply from it. Coal-barges ascend the river by dams and locks.

Schwalbach, or LANGENSCHWALBACH, a spa of Germany, 8 miles W. by N. of Wiesbaden, has eight springs impregnated with iron and carbonic acid gas, the water of which is efficacious in female complaints, poor blood, and muscular weakness. Pop. 2658, increased to about 7000 in the season.

Schwann, THEODOR, naturalist and founder of the cell-theory, was born 7th December 1810, at

Neuss in Rhenish Prussia, studied at Bonn, Würzburg and Berlin, and became assistant to Johannes Müller. In 1838 he became professor of Anatomy at Louvain, in 1848 at Liège, where he also lectured on physiology. He died at Cologne, 14th January 1882. He made many discoveries on the digestion, muscular structure, contractility of the arteries, and the nervous system; but his chief contributions to science, practically establishing the cell-theory, are found in his classic *Microscopic Investigations on the Accordance in the Structure of Plants and Animals* (1839; Eng. trans. 1847), the main ideas of which are explained at CELL, Vol. III. p. 46.

Schwanthaler, LUDWIG MICHAEL, a German sculptor, was born on 26th August 1802, at Munich, the descendant of an old family of Tyrolese sculptors, and was trained in the Munich Academy of Art and in his father's workshop. After a visit to Rome he set up a studio at Munich, and, being brought under the notice of King Louis, was charged to execute for the Glyptothek several bas-reliefs and figures. In 1832 he revisited Rome, for the purpose of preparing models for the national monument of Valhalla and the Pinakothek. On his return to Munich (1834) he began his bas-reliefs and sculptures for the Königsbau. In 1835 he was appointed professor at the Munich Academy. The number of his works is singularly great, while their excellence places him in the first rank of German sculptors. Yet, spite of his power of design, he is somewhat conventional in his conception: and his influence on art has not been all for good. The multitude of his commissions is responsible for a good deal of work being left to his assistants, and for the lack of careful finish such work shows. Among his remaining efforts may be mentioned two groups for the gable ends of the Valhalla, the colossal statue of Bavaria, 60 feet high, that stands in front of the Temple of Fame, statues of Goethe, Jean Paul Richter, and Mozart, of Venus, Diana, Apollo, Bacchus, &c., and many others, both groups and single figures. He died on 28th November 1848, leaving his models to the nation. See *Art Journal* (1880).

Schwarz, BERTHOLD. See GUNPOWDER, Vol. V. p. 470.

Schwarz, CHRISTIAN FRIEDRICH, a German missionary in India, was born at Sonnenburg, in Brandenburg, 8th October 1726. He studied at Halle, and, having resolved to become a missionary, obtained ordination at Copenhagen, with the view of joining the Danish mission at Tranquebar, where he arrived in 1750. His career is a beautiful example of what may be accomplished when piety, integrity, good sense, and a charity that knows how to prevent the virtue of zeal from lapsing into fanaticism are united harmoniously in a man. After labouring sixteen years at Tranquebar he went to Trichinopoly, where he founded a church and school, and also acted as chaplain to the garrison. In 1769 he gained the friendship of the Rajah of Tanjore, and removed to his capital in 1778; there he died on 13th February 1798. He was highly successful in making converts to Christianity, and gained the esteem and confidence of the native rulers, including Hyder Ali, of Mysore, who, when he was arranging terms of peace with the Madras government, demanded that Schwarz should act as their agent—'him, and no other one,' said the sultan, 'will I receive and trust.' The Rajah of Tanjore, before he died, appointed Schwarz tutor and guardian of his young son, who turned out one of the most accomplished sovereigns of India. See the *Life of Schwarz* by H. N. Pearson (1855).

Schwarzburg, an old princely family of Germany, which traces its descent from a Thuringian

count, Günther, whom St Boniface converted to Christianity. The first to adopt the title of Schwarzburg was Count Sizzo IV., early in the 12th century. Count Günther XXXIX., who introduced the reformation into his states, was the common ancestor of the two existing lines of the Schwarzburg family: his son Johann Günther founded the line of Schwarzburg-Sondershausen, and Albert that of Schwarzburg-Rudolstadt.

SCHWARZBURG-RUDOLSTADT, a sovereign principality of the German empire, consists of the upper lordship (283 sq. m. and 79 per cent. of the pop.) in the Thüringer Wald, surrounded by the Saxon duchies of Weimar, Altenburg, and Meiningen, and the lower lordship (80 sq. m. and 21 per cent. of the pop.), lying 40 miles to the north in Prussian Saxony. Pop. 85,863. Both divisions are mountainous; in the lower lordship stands the Kyffhäuser (1545 feet), under which, according to the legend, Frederick Barbarossa sleeps. In the lower lordship agriculture is the mainstay of the people; in the upper manufacturing industry (porcelain, glass, machinery, mathematical instruments, &c.), mining, forestry, and grazing. Education stands at a high level. The constitution is in principle that of a constitutional monarchy, the head of the state being the prince. The national assembly consists of sixteen members, elected every three years. Capital, Rudolstadt.

SCHWARZBURG-SÖNDRERSHAUSEN, a sovereign principality of Germany, consists of the lower lordship (200 sq. m. and 51½ per cent. of pop.) in Prussian Saxony and two separate portions constituting the upper lordship (132 sq. m. and 48½ per cent. of pop.) in the Thüringer Wald, surrounded by the Saxon duchies of Gotha, Weimar, and Meiningen. Pop. 75,510. The occupations are the same as for Schwarzburg-Rudolstadt, and distributed in the same way. The government is in the hands of the prince and an assembly of fifteen members, ten elected by the people, five nominated by the prince. Capital, Sondershausen.

Schwarzenberg, a princely family of Germany, the head of which was raised (1429) by the Emperor Sigismund to the dignity of Baron of the Empire. Three of this family have acquired a European reputation. ADAM, Count of Schwarzenberg, who was born in 1584, became (1619) prime-minister and adviser of George William, Elector of Brandenburg. He was all-powerful during the Thirty Years' War, and brought down terrible calamities on Brandenburg by his obstinate refusal to join the Protestant union and his firm adherence to a policy of neutrality. He died 14th March 1641, shortly after the death of his master.—KARL PHILIPP, Prince of Schwarzenberg, won distinction as an Austrian field-marshal during the Napoleonic wars. He was born at Vienna, 15th April 1771, and first served against the Turks. In the war against the French republic he fought with especial honour at the battles of Cateau-Cambrésis (1794), Würzburg (1796), and Hohenlinden (1800), and reached the grade of lieutenant field-marshal. He was under the orders of Mack in the campaign of 1805; and, when he saw that Ulm was lost, he cut his way through the French army and retired to Eger. He was ambassador at the Russian court in 1808 by the express wish of the Emperor Alexander, fought at Wagram in 1809, and conducted the negotiations for the marriage between Napoleon and Maria Louisa. In this capacity and as ambassador at Paris he so far gained the esteem of Napoleon that the latter expressly demanded him as general-in-chief of the Austrian contingent which was sent to aid France in the invasion of Russia in 1812. Schwarzenberg passed the Bug and achieved some slight successes, but was driven into the 'duchy of Warsaw,' where, acting on secret instructions

from Napoleon, he took up a position at Pultusk and remained inactive. In the following year he was appointed to the command of the Austrian army of observation in Bohemia; and, when Austria joined the allied powers, he became generalissimo of the united armies, and won the great battles of Dresden and Leipzig. The year after (1814) he marched into France and captured Paris. He died of apoplexy at Leipzig, 15th October 1820. Although a bold and skilful leader of cavalry, as a general he was a pedant. His memoirs were edited by Prokesch-Osten (Vienna, new ed. 1861).—His nephew, FELIX LUDWIG JOHANN FRIEDRICH, born October 2, 1800, was sent on a diplomatic mission to London in 1826, but became involved with Lady Ellenborough in a divorce case, was ambassador at Naples in 1846, distinguished himself in the Italian campaign of 1848, was placed at the head of affairs at Vienna, called in the aid of the Russians against Hungary, and pursued a bold absolutist policy, his object being to make Austria supreme amongst the German states. He died at Vienna, April 5, 1852. See Life by Berger (Leip. 1853).

Schwarzwald. See BLACK FOREST.

Schwatka, FREDERICK, Arctic explorer, was born at Galena, Illinois, 29th September 1849, graduated at West Point in 1871, and served as a lieutenant of cavalry on the frontier till 1877, meanwhile being also admitted to the Nebraska bar and taking a medical degree in New York. In 1878-80 he commanded an expedition to King William's Land which discovered and buried the skeletons of several of Sir John Franklin's party, and gathered information which filled up all gaps in the narratives of Rae and McClintock, besides performing a notable sledge-journey of 3251 miles. After exploring the course of the Yukon in Alaska, in 1884 he resigned his commission. In 1886 he commanded the *New York Times* Alaskan expedition, and ascended Mount St Elias to a height of 7200 feet; and in 1891 he led another party to Alaska which opened up some 700 miles of new country in the same quarter. In 1889 he had led an expedition, for the journal *America*, into Chihuahua, in Northern Mexico. He published *Along Alaska's Great River* (1885), *Nimrod in the North* (1885), *The Children of the Cold* (1886). Died at Portland, Oregon, November 2, 1892. See also *Schwatka's Search*, by W. H. Gilder (1881).

Schwedt, a town of Prussia, in the province of Brandenburg, on the Oder, 28 miles SSW. of Stettin, with wood-sawing, lime-burning, and tobacco industries. It was the residence of the margraves of Brandenburg from 1689 to 1788, and was entirely rebuilt after a fire in 1684. Pop. 9756.

Schwegler, ALBERT, theologian and philosopher, born at Michelbach in Württemberg, 10th February 1819. He studied theology at Tübingen, and was profoundly influenced by the writings of Hegel, Strauss, and especially Baur. His striking treatise on Montanism (1841) and many contributions to Zeller's *Theologische Jahrbücher* brought him into collision with the church authorities in Württemberg, and caused him to abandon the clerical calling. In 1843 he started the *Jahrbücher der Gegenwart*, and habilitated as *privat-docent* in philosophy and classical philology at Tübingen, where in 1848 he became extra-ordinary professor of Classical Philology, later ordinary professor of History, and died 5th January 1857.

His other theological works were *Das Nachapostolische Zeitalter* (2 vols. 1846)—a hastily written and uncritical exaggeration of the Baur hypothesis, Christianity being represented as a mere outgrowth of Ebionitism—and editions of the Clementine homilies (1847) and the Church History of Eusebius (2 vols. 1852). More valu-

able was his contribution to the history of philosophy: a translation with commentary of Aristotle's *Metaphysics* (4 vols. 1847-48); the *Geschichte der Philosophie* (1848; Eng. trans. by Dr Hutchison Stirling, 1872), a masterly sketch; and the posthumous *Geschichte der Griech. Philosophie* (ed. by Köstlin, 1859), in which he broke away from his earlier Hegelianism. He left unfinished a *Röm. Geschichte* (3 vols. 1853-58; 2d ed. 1867-72; continued by Clason, vols. iv. and v. 1873-76).

Schweidnitz, a town of Prussian Silesia, 36 miles by rail SW. of Breslau. Woollen and linen goods, agricultural implements, gloves, needles, pottery, and numerous other articles are manufactured. The beer has been celebrated since the 16th century. Considerable quantities of flax and beet-root are grown in the neighbourhood. Between 1641 and 1807 Schweidnitz was besieged and taken six times, the last time by the French, after which the defences were in great part destroyed. Pop. (1890) 24,780.

Schweinfurt, an ancient and long an imperial free city in the north-west of Bavaria, on the Main, 28 miles NE. of Würzburg by rail. It contains a beautiful market-place, in which important cattle and wool markets are held. Wine-growing, sugar-refining, and manufactures of chemicals, paper, bells, dyeing materials, as white-lead, ultramarine, Schweinfurt green, &c., and numerous other articles are carried on. Pop. 12,502. Rückert, the poet, was born here; and a monument was erected in 1890.

Schweinfurth, GEORG AUGUST, a German traveller in Africa, was born in Riga, 29th December 1836. He studied at Heidelberg, Munich, and Berlin, making botany his specialty. In 1864 he made a journey through the valley of the Nile, and along the coasts of the Red Sea as far as Abyssinia. In 1869, by the aid of a grant from the Humboldt Society of Berlin, he again started for Khartoum, whence he made his way into the interior in the company of ivory-traders, passed through the regions inhabited by the Bongo, Dinka, Niam-Niam, Madi, and Monbuttu peoples, and discovered the Welle. He returned in 1871, and in 1874 published his travels, an English translation, *The Heart of Africa*, appearing the same year. At the request of the Khedive he founded in 1872 the Egyptian Geographical Society, and was nominated president of the same. Between 1874 and 1883 he explored various districts of Egypt, especially their botany. In 1880 he was appointed director of all the Egyptian museums, collections, &c. in Cairo. He has published *Artes Africanae* (Leip. and Lond. 1875) and numerous papers in the journals, *Petermann's Mitteilungen*, *Zeitschrift für Erdkunde*, *Globus*, &c. In 1891-94 he made a botanical expedition to Erythraea.

Schwenkfeld, CASPAR VON, founder of a Protestant sect, was born of noble family in 1490 at Ossig near Liegnitz in Lower Silesia, studied two years at Cologne and elsewhere, and, before retiring into private life in 1521 to a constant study of the Scriptures, served at various courts with Duke Charles of Münsterberg, and as aulic counsellor with Duke Frederick II. of Liegnitz. He became acquainted with the views of John Huss, from his youth up had been a student of Tauler, and was permanently won over to the Reformation by the noble courage of Luther at Worms. About 1525 he openly declared for Luther, and went to Wittenberg to converse with him, but found his views widely divergent on baptism and the eucharist. Still further, he found himself unable to accept any confessions of faith except such as followed closely the letter of Scripture, and in his profound conviction that the new movement should proceed from within outwardly, and not from without inwardly, he disagreed with the Lutherans in

their policy of linking the Reformed Church with the state, instead of waiting passively for the direct guidance of the Holy Spirit, the sole fountain of sanctification. Schwenkfeld did not himself partake of the Lord's Supper, although he did not forbid it to others, for he held that there could be no right participation without the exclusion of unbelievers, and that the true Lord's Supper is kept through faith inwardly in the soul as often as a man receives *divine sweetness in Christ*. He did not approve of infant baptism, yet without admitting the Baptist view of the importance of the baptism of adults. His views coincide with those of George Fox in the doctrine of the Inward Light, the Immediate Revelation, and the inability of mere outward bodily acts, such as partaking of the Lord's Supper or baptism, to give the inward and spiritual reality and power of the Lord's 'body' and 'blood,' or that of the spiritual 'washing of regeneration.' Schwenkfeld's views in that intolerant time brought him the hatred of Lutherans and Catholics alike. The influence of the Emperor Ferdinand forced the Duke of Liegnitz to banish him in 1529, and he thereafter travelled to Ulm, Augsburg, Nuremberg, and Strasburg, everywhere gaining disciples. Luther fiercely denounced him, and many untrue charges were brought against him by others, but all the violence of his antagonists the much-enduring man received with saintly patience. He died at Ulm, 10th December 1561. Schwenkfeld wrote ninety distinct works, most of which were burned, if not answered, by both Protestants and Catholics. One of the most important was his *Bekandniss und Rechenschaft von den Hauptpunkten des Christlichen Glaubens* (1547). By means of personal teaching and his books a group of earnest disciples more than 4000 strong was formed all over Germany, but mostly in Swabia and Silesia, who separated themselves under the name of Confessors, or Followers of the Glory of Christ. They were persecuted in Silesia in his lifetime, and many emigrated to Holland, some to England. The Jesuit mission established in Silesia in 1719 persecuted the remnant still further, and some joined the Protestant churches, some fled to Saxony, where they were protected by Count Zinzendorf. In 1734 forty families emigrated to England, and finally thence to Pennsylvania, where, as Schwenkfeldians, they have maintained a distinct existence to this day, and in 1890 numbered 306 members, with six churches.

See H. W. Erdkam, *Geschichte der Protestantischen Sekten im Zeitalter der Reformation* (Hamburg, 1848); Kadelbach, *Geschichte Schwenkfelds und der Schwenkfeldianer* (Lauban, 1861); and Robert Barclay, *The Inner Life of the Religious Societies of the Commonwealth* (Lond. 1876).

Schwerin, capital of the grand-duchy of Mecklenburg-Schwerin, is agreeably situated on the west shore of the Lake of Schwerin (14 miles in length and 3 broad), with smaller lakes behind it. It is surrounded with suburbs and contains the grand-duke's castle (1845-58), a Renaissance structure; the cathedral (1365-1430), with interesting monuments and stained glass; an arsenal; a museum and picture-gallery; and manufactures of lacquered wares, machinery, cloth, &c. Pop. (1890) 33,730.

Schwyz, a canton of Switzerland, touches in the north the Lake of Zurich, and in the west the Lakes of Zug and Lucerne. Area, 350 sq. m.; pop. (1888) 60,396, nearly all Roman Catholics. The surface is mountainous, rising to 7494 feet, and in Kinzigkalm on the border to 9052 feet. Cattle-breeding and the keeping of swine, goats, and sheep are the principal occupations, though cotton and silk are both spun and woven, and much fruit is grown, Schwyz *kirschenwasser* being in great

demand. The celebrated monastery of Einsiedeln (q.v.) attracts large numbers of pilgrims, and the Rigi (q.v.) vast numbers of tourists in the summer. Schwyz, one of the three original cantons of the Swiss Confederation, and also one of the Four Forest Cantons, has supplied the name to the whole country of which it forms a part. The people govern themselves through a grand council, consisting of one representative for every 600 citizens, and an executive of seven members chosen by the council from its own body; all these rulers are elected for four years. Schwyz, the capital, is picturesquely situated 26 miles by rail east of Lucerne. Here on 1st August 1891 was held the sixth centenary of the League of Brunnen and the seventh of the founding of Bern. Pop. 6624.

Sciaccia (anc. *Therme Selinuntinæ*), a seaport on the south coast of Sicily, stands on a bold cliff 30 miles NW. of Girgenti, has a fine 11th-century cathedral, the ruined castles of the Lunas and the Perollos (between whom there existed a terrible feud), hot sulphurous and saline springs, and half-way up the adjacent mountain San Calogero caves that have been used as steam baths since Phœnician times. Off the coast very productive coral banks were discovered in 1875-80. Agathocles, tyrant of Syracuse, was a native. Pop. 20,709.

Sciatica is the term given to neuralgia of the great sciatic nerve, the largest in the body, which passes down the back of the thigh. It is characterised by irregular pains about the hip, especially between the great trochanter of the thigh-bone and the bony process on which the body rests when sitting, spreading into neighbouring parts, and running down the back of the thigh to the leg and foot; or the pains may occupy only isolated parts, as the knee-joint, the calf of the leg, or the sole of the foot. It generally differs from the most typical forms of Neuralgia (q.v.) in that the pain, though subject to severe exacerbations, is constantly present. The nerve usually becomes very tender to touch, either at isolated points or throughout; and, in severe and prolonged cases, diminution of sensation in the area of distribution of the nerve, and wasting of the muscles of the limb, are apt to occur. It is sometimes dependent on a gouty condition of the system; but more frequently than other forms of neuralgia can be traced to some definite exposure to cold or wet. It is often a very obstinate disease: the treatment must be conducted on the same lines as that of other forms of neuralgia. Here Acupuncture (q.v.) is specially valuable. In intractable cases *nerve-stretching*—i.e. cutting down upon the trunk of the nerve, and forcibly pulling upon it—has often been successful where all other measures have failed to cure. The same result may sometimes be obtained by forcibly bending the thigh up towards the abdomen.

Scellì, a town in the south-east corner of Sicily, 36 miles SW. of Syracuse, with some cloth-weaving and cheese-making. Near by are the remains of the ancient *Casmene*. Pop. 11,842.

Science, in its widest significance, is the correlation of all knowledge. To know a truth in its relation to other truths is to know it scientifically. For example, the recognition that the alternation of day and night depends upon the apparent daily motion of the sun is a distinct scientific achievement, being one of those elementary scientific truths which have been the possession of thinking minds from time immemorial. By generalisation from everyday experiences like that just mentioned, and from the historic or traditional experiences of the race, man has been led to the belief that natural events follow each other in an orderly and connected way. To investigate this orderly connection is the aim of all science; and in pursu-

ing this aim the human mind consciously or unconsciously takes for granted the Law of Continuity, which postulates that in their development and interactions the phenomena of nature follow an intelligible plan which never has failed and which never can fail. In assuming intelligibility in nature science rests of necessity upon the fundamental laws of thought. To express it otherwise, the end of science is the rational interpretation of the facts of existence as disclosed to us by our faculties and senses.

In all scientific inquiry the first step is to scrutinise the evidence of the senses, whose indications are always imperfect and often misleading. History shows again and again that the supposed scientific beliefs of one age are at variance with the scientific facts of a later age. In every such case it will be found that the earlier and false science has laid too great stress on the apparent, and has from insufficient knowledge failed in apprehending the real. In the history of Astronomy, the most self-contained and in itself the most developed of the physical sciences, we find many familiar illustrations of this. None is more striking perhaps than the recognition of the earth's diurnal rotation as the reality which produces the appearance of the daily motion of sun, moon, and stars. At first a heresy, then a rational hypothesis commanding assent from all thinking minds, the earth's axial rotation is now a demonstrable fact.

Experiment is the great method of scientific inquiry. In it we arbitrarily interfere with the circumstances of a phenomenon, or produce an entirely new phenomenon by an appropriate combination of causes. Contrasted with Experiment is Observation, in which we simply watch and record the events as they occur in nature. But even in Astronomy, emphatically an observational science, experiment plays an important part. The dynamical knowledge which Newton developed into the cosmic law of gravitation was founded on experiment; and every time the astronomer points his telescope to a celestial object he experiments by arbitrarily interfering with the course of the rays of light. Meteorology again, which twenty years ago could hardly be called a science, has made great strides in these days by appealing to laboratory experiments for the elucidation of its phenomena. Likewise in Biology very little true scientific progress was made until experiment was appealed to. Till then Botany and Zoology were simply lists of plants and animals, classified according to characteristics or according to distribution on the earth's surface. The gardener and breeder led the way in a form of experimenting which Darwin made scientific; while such branches of the subject as Embryology and Bacteriology are as truly experimental as Chemistry itself. In studying the laws alike of inorganic and of organic nature the experimenter must be careful not to destroy the phenomenon that is to be studied. This consideration makes the biological problem particularly difficult of attack.

In the psychical group of sciences the method of experimenting still awaits development. The complexity of the problems presented, and the manner in which they affect the welfare and happiness of humanity, render social and political experimenting excessively hazardous and of doubtful morality. History, however, affords many instructive examples of attempted reforms which were largely tentative. From these and from the general study of customs and rites as they have been in the past and are now, the economist, the ethnologist, the moralist, or the theologian can accumulate his own materials for the upbuilding of his appropriate science. Such sciences are of necessity essentially observational.

It is obvious from what has gone before that sciences may be grouped, or science partitioned, on a broad and intelligible principle. There are the Physical Sciences, which have to do with inorganic nature—that is, with the laws and properties of Matter, Energy, and Ether. Then there are the Biological Sciences, which consider the laws of Life. And finally, there are the Psychological Sciences, which deal with the phenomena of Mind. The influence of Life upon the Matter and Energy of the Universe, profound though it is, in no way renders nugatory the great principles that hold in inorganic nature. These principles are the Conservation of Matter and the Conservation of Energy, Ether being the medium through which and by which Energy is transmitted and transformed. The great principle of biology, which enters along with these physical principles as a factor in organic nature, is the law of Biogenesis, or Life from Life. In the higher mental sphere of activities these three great principles still hold, however much mind may interfere in what would otherwise have been the natural progress of events in the lower spheres of activity. So far no broad psychic principle comparable to the physical and biological principles has been discovered, or even imagined to be discoverable. It must ever be remembered, however, that this broad gradation in the sciences is itself a psychic phenomenon.

Numerous attempts have been made to give a detailed classification of the sciences, so as to bring out the natural relation of the one to the other. Such classifications may have a historic interest, inasmuch as they must have been largely conditioned by the extent of knowledge or degree of ignorance of the classifier. They may also have a philosophic value as affording a glimpse into the nature of the human mind. But it is extremely doubtful if they have in any appreciable way assisted in the progress of science itself. One of the most celebrated is the classification due to Comte, who first explicitly drew the distinction between Abstract and Concrete sciences, or what might better be termed Fundamental and Derivative sciences (see POSITIVISM). The distinction is most simply expressed by saying that a derivative science requires for its elucidation no peculiar principle or law of nature, but involves only those principles which are already discussed under the fundamental sciences. The truth is that a derivative science is a special or limited branch of science in general, separated out for purposes more or less concrete or practical; and it is impossible logically to mark off such special sciences as a group from other branches of science, which, though no more abstract and no less special, are still treated as included in the fundamental sciences. The mistake which Comte himself made in classifying Astronomy in his group of abstract sciences along with Mathematics, Physics, Chemistry, Biology, and Sociology is an illustration in point. Comte's scheme has been severely criticised by Herbert Spencer, who suggests a threefold grouping into Abstract, Abstract-Concrete, and Concrete Sciences. The second group is essentially what we have called above Physical Science, including Physics and Chemistry as ordinarily understood. Mr Spencer considers it as dealing with the laws of 'Force' in the abstract, or as exhibited by matter. Biology appears for the first time in the third or Concrete group as exhibiting certain 'laws of redistribution of matter and motion actually going on.' But surely there is a fundamental science of Biology dealing with the laws of vital 'Force,' and having to Botany and Zoology the same kind of relation which Physics and Chemistry have to Astronomy and Geology. The whole fallacy of the position lies in making 'Force,' even with its vague Spencerian sense, one

of the central props of the argument. Force is apparent, not real, unless we take it in the sense of Energy; but this will not apply to Mr Spencer's classification. From the present outlook of science the existences of the universe are five—namely, Ether, Matter, Energy, Life, and Mind. The first three are inseparable agents in the simplest phenomenon that occurs in nature. They may ultimately be reduced to two or conceivably to one.

See Comte, *Philosophy of the Sciences*, trans. by Lewes (1853; new ed. 1878); Herbert Spencer, *Classification of the Sciences* (1864; new ed. 1880), and his *First Principles* (new ed. 1884); Jevons, *Principles of Science* (1874); Clifford, *Common Sense of the Exact Sciences* (1885); Louis Agassiz, *Essay on Classification* (1859); C. W. Shields, *The Order of the Sciences* (New York, 1884); J. S. Mill, *Logic*; Mrs Somerville, *Connection of the Physical Sciences* (ed. by Buckley, 1877); Whewell, *History of Inductive Science* (1837; new ed. 1877), and *History of Scientific Ideas* (1858-60); Huxley, small volume introductory to the *Science Primers* (1880), and his *Science and Culture* (1881); also the articles in this work under the following headings, and books there cited:

Aesthetics.	Ether.	Meteorology.
Agriculture.	Ethics.	Mineralogy.
Anthropology.	Ethnology.	Motion.
Archaeology.	Evolution.	Mythology.
Art.	Geography.	Philology.
Astronomy.	Geology.	Philosophy.
Biology.	Geometry.	Physiology.
Botany.	Law.	Political Economy.
Chemistry.	Logic.	Psychology.
Dynamics.	Materialism.	Religion.
Education.	Mathematics.	Sociology.
Energy.	Matter.	Theology.
Engineering.	Medicine.	Zoology.

Science and Art. See KENSINGTON.

Scientific Frontier, a term used by Lord Beaconsfield at the Guildhall banquet of 9th November 1878, when speaking of the boundaries between India and Afghanistan. He stated that at that time the frontier in question was 'a haphazard frontier,' but that steps were being taken to make it 'a scientific frontier,' by which he meant a frontier that would admit of being occupied and defended according to the requirements of the science of strategy.

Scilla. See SQUILL.

Scilly Islands, a Cornish group, lie about 27 miles WSW. of Land's End. They occupy, as a group, about 30 sq. m. of sea-room, and consist of six large islands—St Mary's (1528 acres; pop. 1290), Trecoy (697 acres; pop. 328),

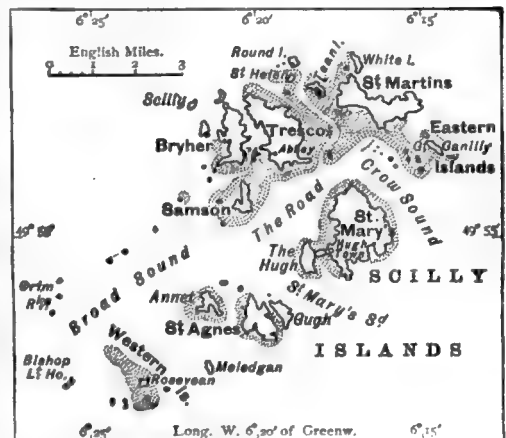

St Martin's (515 acres; pop. 175), St Agnes (313 acres; pop. 148), Bryher (269 acres; pop. 103), and Samson (78 acres, uninhabited)—and some thirty

small ones, besides innumerable rocks and ledges, of which about a hundred are named. They are composed entirely of a coarse type of granite, a continuation of that running through Devon and Cornwall. Tin is found, but in such minute quantities that to justify the identification of these islands with the *Cassiterides* (q.v.) or 'Tin Islands' of the ancients the west end of Cornwall would almost require to be included as the all-important member of the group. The idea of a land of Lyonesse between the islands and the mainland submerged within historic times is now abandoned. The present name 'Scilly' belongs strictly to a small, very inaccessible, double, rocky island in the north-west of the group, and is most probably derived from Cornish *Silya*, or *Sillis*, 'a conger eel.'

Athelstan conquered the islands in 938, and established monks upon Tresco, the ruins of whose abbey still remain. Olaf Trygvason (995-1000), who forced Christianity upon Norway and introduced it into Iceland, is said to have been converted by a hermit upon one of the islands. They were handed over to the wealthy abbey of Tavistock by Henry I., but reverted to the crown upon the dissolution of the monasteries in 1539. In 1568 Queen Elizabeth leased them to Sir Francis Godolphin, who built the Star Castle on St Mary's—over the doorway stands 'E. R. 1593.' They remained in his family for more than 250 years—hence the hamlet of 'Dolphin' town upon Tresco. They sheltered Prince Charles in 1645 before he fled to Jersey (Clarendon here began his History), and Cromwell's Tower on Tresco was set up by the parliamentary forces. In 1834 they were leased to Mr Augustus John Smith, a radical reformer although somewhat of an autocrat, and the best friend the islanders have ever had. He made Tresco his home for thirty-eight years, and his tropical gardens there are unique in northern Europe. He built churches and schools, suppressed smuggling, encouraged agriculture, and forbade overcrowded holdings. He was succeeded as 'lord proprietor' in 1872 by his nephew, T. A. Dorrien Smith.

The climate is mild, but necessarily damp, and the weather is changeable and frequently stormy; but the temperature is extremely equable, averaging 58° F. in summer and 45° F. in winter. The leading natural features of the scenery are the fantastically weathered rocks and rock-basins and the bold coast-lines. There are remains of cromlechs and stone circles; and a perfect kistvaen (containing human bones showing traces of fire action) was opened upon Samson in 1862. Tresco Abbey and its gardens are considered the leading objects of interest for the tourist. No part of the islands is more than 160 feet above sea-level. The highest points are the 'Telegraph' on St Mary's, and St Martin's Head, which has had a daymark since 1683. There has been a lighthouse on St Agnes since 1680, on Bishop Rock since 1858, and on Round Island since 1887; there are also lights on the Wolf, the Seven Stones (floating), and the Longships off Land's End. Hugh Town on St Mary's, the only town on the islands, with plain, substantial and uninteresting houses (mostly two-storied), has a church (resident chaplain, with curates on Tresco, St Martin's, and St Agnes), two chapels, two comfortable hotels, banks, shops, schools, telegraph (since 1870), and Jubilee Hall. It has also a pier (erected by Mr A. J. Smith), a coastguard station, and a lifeboat. There is good anchorage in the roadstead. Many of the islands, especially Annet, abound with sea-fowl.

Wrecks used to be very numerous and were a fruitful source of wealth. One of the most famous was that of three ships of Sir Cloudesley Shovel's

fleet in 1707, when 2000 men, including the admiral, were drowned. The Scillonians also lived by pilotage, but steam and more lighthouses now help vessels to avoid the islands. Smuggling was formerly largely indulged in. In the early years of the 19th century, before the days of iron ships, there were three shipbuilding-yards on St Mary's. Kelp-making, introduced in 1684, has been given up. Nowadays most of the young men emigrate and are found doing well in all parts of the world. Farming is practised, and early potatoes and broccoli are exported; but the principal industry now is the cultivation of narcissus and other lilies—100 tons of flowers being shipped in a single spring. There is a steamer to Penzance three times a week all the year round. In May and June, during the mackerel-fishing, there is one steamer (often two) daily with cargoes of sometimes over 100,000 fish. The fishing-boats, however, belong to Penzance and the east coast. Politically the islands belong to the St Ives division of Cornwall.

See *Borlase's Observations* (1756), *White's A Week in the Isles of Scilly* (1850), *Tonkin's Guide* (Penzance, 1887), and *Besant's Armored of Lyonesse* (1890).

Scimitar. See SWORD.

Scinde. See SIND, SINDHIA.

Scink. See SKINK.

Scintillation, or twinkling of the stars, is a familiar phenomenon to all who have directed their attention to the firmament above us. Under ordinary atmospheric conditions this flickering is possessed only by the so-called fixed stars (see STARS). A planet shines steadily and by this mark can readily be picked out. When near the horizon, however, planets have been observed to scintillate slightly; while stars at low altitudes invariably twinkle more vigorously than stars overhead. This at once points to the atmosphere as an important factor, since the phenomenon is more pronounced when the light has to traverse a greater depth of air. Again, when viewed through sufficiently large telescopes stars cease twinkling altogether. The action of the telescope is to concentrate upon the eye a much larger pencil of rays than could naturally enter it. Instead of one slender ray the eye receives the integral effect of a great number of rays, whose individual features are lost in the general average. In the case of a planet, again, the rays which fall upon the retina converge from all parts of a disc of sensible size; and in the integral effect of this pencil the individual features of the component rays are lost. But a star is so far distant as to be virtually a point of light. In this case we have an excessively slender ray infinitely narrow compared even to the small pencil of light that comes to us from a planet. The vicissitudes of refraction which a star-ray experiences in passing through the infinitely irregular variations of density, temperature, and humidity in our atmosphere characterise its integral effect on our retina, and the result is twinkling. The exquisite chromatic effects that accompany the twinkling of a bright star like Sirius are fully accounted for in terms of this general explanation. It is possible indeed by separating the images of a star produced in the two eyes to observe two different scintillations at one and the same time. Scintillation may thus be said to depend on three factors: (1) The vast distance even of the nearest stars reducing the largest of them to mere points of light; (2) the ever-changing variability in condition of the atmosphere through which the light must come to us; (3) the smallness of aperture of our eye, which receives an almost ideal single ray of light.

Scio. See CHIOS.

Scioppius (Latinised form of *Schoppe*), KASPAR, a classical scholar and controversialist, was born at Neumarkt in the Palatinate, 27th May 1576, and studied at Heidelberg, Altdorf, and Ingolstadt. Whilst on a visit to Prague in 1598 he abjured Protestantism and became a Roman Catholic. Henceforth his career is a series of fierce onslaughts on his former co-religionists, on the old Latin writers, and on all who enjoyed a reputation in the world. He was honoured with the title of a count of Spain, and was made a pensioner of the Vatican. Amongst the first to feel his venom was Scaliger (q.v.), against whom in 1606 he launched *Scaliger Hypobolimeus*. Sent in 1608 by the court of Rome to the diet of Ratisbon for the purpose of observing the religious condition of Germany, he published numerous pamphlets against the Protestants, recommending the Catholic powers to use every means for their extermination. Shortly afterwards he fired off several venomous libels against James I. of England. For this the servants of Lord Digby, ambassador in Madrid, gave him a sound cudgelling in that city in 1614. Scioppius fled from Spain to Ingolstadt, where he issued his *Legatus Latro* (1615) against the ambassador. In 1618 he went to Milan, where he resided for the next twelve years, devoting himself partly to philological studies and partly to theological warfare. He died at Padua, 19th November 1649, the reviler of all respectable parties, loved by none, but also feared by none. Scioppius was a prodigious scholar, and might have rivalled Scaliger himself in reputation, as he did in learning, had it not been for the infirmities of his temper and judgment. His most important work is *Grammatica Philosophica* (1628); next in value come *Verisimilium Libri Quatuor* (1596), *Suspectæ Lectiones* (1597), *De Arte Critica* (1597), *Observationes Lingvæ Latinæ* (1609), *Paradoxa Literaria* (1628), and *De Scholarum et Studiorum Ratione* (1636).

Scoto, a beautiful river of Ohio, rises in the north-west portion of the state, and flows east and then south, past Columbus and Chillicothe, to its junction at Portsmouth with the river Ohio. It is nearly 300 miles long, and from its mouth to Columbus feeds the Ohio and Erie Canal.

Scipio, PUBLIUS CORNELIUS, surnamed AFRICANUS MAJOR, one of the most famous soldiers of ancient Rome, was born in 237 B.C. He took part in the disastrous battle of the Ticinus (218), where he saved his father's life, and later at the Trebia and the fatal field of Cannæ. In 212 he was elected ædile, though not yet of legal age, and in 210 was specially selected by acclamation of the people as a general extraordinary for Spain. His noble beauty and personal charm proved irresistible, but in this gracious and self-reliant youth of twenty-seven the people had found a hero and the state a saviour. His arrival gave a new turn to the war. By a bold and sudden march he captured *Nova Carthago*, the stronghold of the Carthaginians, and his courtesy soon won over many of the native chiefs. He checked Hasdrubal, but failed to prevent him from crossing the Pyrenees to the assistance of Hannibal. In 207 he won a decisive victory over the other Hasdrubal (son of Gisgo) and Mago, which gave him the whole of Spain. Soon after he returned to Rome, where he was elected consul (205) though he had not yet filled the office of prætor. His favourite plan to transfer the war to Africa was opposed by a party in the senate; but the popular enthusiasm for the name of Scipio proved too strong, and in 204 he sailed from Lilybæum, in Sicily, with 30,000 men, and landed on the coast near Utica. His successes against Syphax and their own armies compelled the Car-

thaginians to recall Hannibal from Italy—the very object Scipio had laboured to achieve. After some abortive efforts at reconciliation the great struggle between Rome and Carthage, between Scipio and Hannibal, was terminated by the battle fought near Zama, 19th October 202, in which the Carthaginian troops were routed with immense slaughter. Hannibal advised his countrymen to abandon what had now become a hopeless and ruinous contest, and his advice was taken. The noble magnanimity of Scipio's character made submission the more easy; and peace was concluded in the following year, when the conqueror returned to Rome to enjoy a triumph. The surname of Africanus was conferred on him, and so extravagant was the popular gratitude that it was proposed to make him consul and dictator for life, honours which would have been the destruction of the constitution, but which Scipio was either wise enough or magnanimous enough to refuse. In 190, in order to give him his aid, he served as legate under his brother Lucius in the war with Antiochus, and crushed his power in the great victory of Magnesia. But after their triumphant return a prosecution was raised against Lucius for allowing himself to be bribed by Antiochus, the colour being the too lenient terms he had been granted. Lucius was declared guilty by the senate; his property was confiscated, and he himself would have been thrown into prison had not Africanus forcibly rescued him from the hands of the officers of justice. In 185 Scipio was himself accused by the tribune M. Nævius; but, instead of refuting the charges brought against him, he delivered, on the first day of his trial, a eulogy on his own achievements, and opened the second day by reminding the citizens that it was the anniversary of the battle of Zama, and therefore a time to return thanks to the immortal gods, and to pray for other citizens like himself. The people followed him to the Capitol in a fever of excitement, and the prosecution was at an end. But Scipio felt that popular enthusiasm was uncertain, that the power of the oligarchy was irresistible, that its hatred of him was unappeasable, and that his day was over. He retired to his country-seat at Liternum, in Campania, where he spent the remainder of his life, and where he died about 183. His wife was daughter to the Æmilius Paulus who fell at Cannæ; his daughter was Cornelia, mother of the Gracchi. Scipio Africanus is commonly regarded as the greatest Roman general before Julius Cæsar; and certainly in the brilliancy of his gifts and accomplishments he was unsurpassed; but if his career be strictly examined it will be found that he owed as much to fortune as to genius. No doubt he won splendid successes, and made the most of his great advantages. Yet his fondness for sounding titles and lavish display, his nepotism, his corruption of the public spirit by largesses, and his assumption of personal superiority to the common law were influences distinctly harmful to the state. His beauty, bravery, and courtesy, his proud yet pious belief that the gods favoured him with their inspiration, won him the love and reverence of soldiers and of women; and his magnanimity towards his fallen foe, who flitted about the eastern courts in dreary exile, is a bright feature in his character, and nobly distinguishes him from the cruel-hearted oligarchs of the senate.

Scipio Æmillianus, PUBLIUS CORNELIUS, surnamed AFRICANUS MINOR, born 185 B.C., was a younger son of that Lucius Æmilius Paulus who conquered Macedon, but was adopted by his kinsman, Publius Scipio, son of the great Scipio Africanus. He accompanied his father on his expedition against Macedon, and fought by his side at Pydna (168). In Greece he made the acquaintance

of Polybius the historian, who afterwards became one of his most valued friends. In 151 he went to Spain as military tribune under the consul Lucius Lælius, and two years later began the third and last Punic war, which mainly consisted in the siege of Carthage. Scipio still held the subordinate position of military tribune; but the incapacity of the consuls, M. Manilius and L. Calpurnius Piso, (149-148), and the brilliant manner in which he rectified their blunders, drew all eyes to him. The favourite both of the Roman army and the Roman people, Scipio was at length in 147, when only a candidate for the ædileship, elected consul by an extraordinary decree of the Comitia, and invested with supreme command. Even the aged Cato, who was not liberal with his praise, marked his opinion of the relative worth of the young Scipio and his comrades by quoting the Homeric line, 'He only is a living man; the rest are gliding shades.' The story of the siege of Carthage, the despairing heroism of its inhabitants, the determined resolution, the sleepless vigilance, the incessant labours of Scipio belong to history. The city was finally taken by storm in the spring of 146; and by the orders of the senate it was levelled to the ground, and the ploughshare driven over its site. Scipio, a man of noble and refined soul, steeped from his youth up in the culture of Greece, obeyed the savage command with sorrow, even with horror. As he gazed on the ruin he had wrought, the thought flashed across his mind that some day Rome too might perish, and the words of the *Iliad* rose to his lips: 'The day shall come when sacred Troy shall perish, and Priam and his people shall be slain.'

Scipio, though probably the most accomplished Roman gentleman of his age, was rigorous in his observance of the antique Roman virtues; and when holding the office of censor in 142 he made fruitless efforts to follow in the footsteps of Cato. In 139 he was accused on the charge of *majestas* by the tribune Tiberius Claudius Asellus, but was acquitted, and soon after was sent to Egypt and Asia on a special embassy. Meanwhile affairs had gone badly in Spain. Viriathus, the Lusitanian patriot, had again and again inflicted the most disgraceful defeats on the Roman armies, and his example had roused the hopes of the Celtiberian tribes, who also rushed to war against the common foe. The contest continued with varying success; but the interest centres in the city of Numantia, whose inhabitants displayed amazing courage in the struggle with Rome. For long it seemed as if the Numantines were invincible—one consul after another finding their subjugation too hard a task; but at length in 134 Scipio, re-elected consul, went to Spain, and after a siege of eight months forced the gaunt and famished citizens to surrender, and utterly destroyed their homes. He then returned to Rome, where he took a prominent part in political affairs as one of the leaders of the aristocratic party, and, though one of the more moderate, his popularity with the populace greatly declined. Although a brother-in-law of Tiberius Gracchus, whose sister Sempronia he had married, he disclaimed any sympathy with his political aims; and when he heard of the murder of his kinsman quoted his favourite Homer: 'So perish all who do the like again.' The Latins, whose lands were being seized by the commissioners in their unwise haste to carry out to the full the Sempronian law, appealed to Scipio for protection, and he succeeded (129) in getting the jurisdiction suspended until the consuls should determine what were domain lands and what private property. But his action caused the most furious indignation among the party of reform, and shortly after Scipio was found dead in his bed, doubtless mur-

dered by some unscrupulous member of the Gracchan party. Scipio was neither a rigid aristocrat nor a flatterer of the people. Inferior in splendour of genius to his adoptive grandfather, he surpassed him in purity of character, in simplicity of patriotism, and in liberality of culture. 'The history of Rome,' says Mommsen, 'presents various men of greater genius than Scipio Æmilianus, but none equalling him in moral purity, in the utter absence of political selfishness, in generous love of his country, and none, perhaps, to whom destiny has assigned a more tragic part. . . . It was his lot to fight for his country on many a battlefield and to return home uninjured, that he might perish there by the hand of an assassin; but in his quiet chamber he no less died for Rome than if he had fallen beneath the walls of Carthage.'

Scire Facias, a writ for enforcing judgments, decisions about patents, &c., or for annulling them: often contracted, like *fi. fa.*, into *sci. fa.* See WRIT.

Scirpus, a genus of plants of the order Cyperaceæ (q.v.). The plants of this genus are called Club-rushes, and the Common Bulrush (*S. lacustris*) of our ponds and sluggish streams is a familiar example. The rhizomes of *S. dubius* are eaten by the natives of the south of India; as are the tubers of *S. tuberosus* by the Chinese, who cultivate the plant in tanks and ponds. The species of this genus, about 300, are universally diffused, although found chiefly in temperate climates. They date from the Lower Miocene period.

Scirrhus (Gr., 'hard'), a term applied to a kind of Cancer (q.v.).

Scissors. See CUTLERY.

Scitamineæ. See ZINGIBERACEÆ.

Sclerostoma, a genus of nematode worms (see THREAD-WORMS), one of which, *S. duodenale*, is a parasite of the human intestine, and another, *S. syngamus* or *Syngamus trachealis*, is the cause of Gapes (q.v.) in fowls.

Sclerotium is a hard, multicellular tuber-like body formed towards the end of the vegetative season by the close union of the ordinary mycelial filaments of Fungi (q.v.). It represents the dormant or resting stage of the fungus, but is not common to all fungi. At the beginning of the period of growth it sends out filaments or groups of filaments which carry on the active life-history of the individual, and soon the store of nourishment is absorbed from the sclerotium by these filaments. The Ergot of Rye (q.v.) is the sclerotium of the fungus *Claviceps purpurea*.

Scolopendrium. See HART'S-TONGUE.

Scomberidæ. See MACKEREL.

Scone (pronounced *Scoon*), in Perthshire, on the Tay's left bank, 2 miles N. of Perth, was the capital of Pictavia as early as 710, and the coronation place of the Scottish kings from 1153 till 1488, as afterwards in 1651 of Charles II. (see SCOTLAND, p. 239). Fordun vividly describes the semi-Celtic coronation of Alexander III. (1249), who was the last to be seated on the 'Stone of Destiny,' carried off in 1296 by Edward I. An Augustinian abbey, founded by Alexander I. in 1115, was totally demolished by a rabble in 1559; and the subsequent Palace of the Viscounts Stormont, in which the Old Pretender lived for three weeks in 1716, and which was also visited by Prince Charles Edward, has given place to a modern castellated mansion, the seat of their descendant, the Earl of Mansfield. Queen Victoria stayed here in 1842. See Urquhart's *History of Scone* (1884).

Scopas, an ancient Greek sculptor, founder, along with Praxiteles (q.v.), of the later Attic school, was a native of the island of Paros, and

flourished during the first half of the 4th century B.C. One of his earliest works we read about was the temple of Athena Alea at Tegea in Arcadia, on the site of a previous one burned down in 395 B.C.; he superintended both the building of it and the adorning of it with sculpture. Some fifteen years or so later he settled in Athens, where for more than a quarter of a century he laboured at his profession. Towards the end of his life he was associated with Leochares and others in preparing sculpture for the great Mausoleum (q.v.) of Halicarnassus in Asia Minor. A large composition representing Achilles being convoyed to Leuce by Poseidon, Thetis, and the Nereids, preserved for some time in the temple of Neptune at Rome, was accounted one of his greatest masterpieces. Another composite work attributed to him, though doubtfully, was the 'Slaughter of the Children of Niobe.' He excelled also in statues of single gods and goddesses, as the 'Apollo with the Lyre.' See the German monograph by Ulrichs (1863).

Score, in Music, compositions for several voices or instruments, or for an orchestra, so written that each part has a separate staff for itself, these staves being placed over each other, bar corresponding to bar. Occasionally, where there is a deficiency of staves for all the parts, or where any of the parts have so little to do that it is not worth while to assign them a separate staff, parts related to or connected with each other, as two flutes, two clarionets, or three trombones, may be written on the same staff together. As a general rule, the highest part should be placed uppermost, then the next lower, and gradually descending. All the parts of a chorus should be placed together.

Scoresby, WILLIAM, an Arctic explorer and savant, was born at Cropton near Whitby, October 5, 1789. He commenced a seafaring life at the age of eleven, by accompanying his father, a whaling captain, to the Greenland seas; and next succeeding his father, he made several voyages to the Spitzbergen and Greenland whaling-grounds. He attended classes at Edinburgh University, carried on investigations in natural history, botany, meteorology, magnetism, &c., and published the results in *An Account of the Arctic Regions* (2 vols. 1820). In 1822 he surveyed 400 miles of the east coast of Greenland. After one more voyage he retired from seafaring life in order to enter the church; and having studied at Cambridge, and been ordained (1825) at Bessingby, laboured faithfully at Liverpool, Exeter, and Bradford. At length failing health compelled him to retire (1849) to Torquay; but he still continued his physical researches. The results of these, as of some earlier inquiries, were published in the transactions of the learned societies, and in *Magnetical Investigations* (2 vols. 1839-52). For the better prosecution of these researches Scoresby made a voyage to the United States in 1847, and to Australia in 1856. He died at Torquay on March 21, 1857. He was elected F.R.S. in 1824, and a corresponding member of the French Institute in 1827. See *Life* by his nephew (1861).

Scoriae are the cinders and slags of volcanoes, more or less porous from the expansion of the gases contained in the melted materials. See VOLCANOES and IGNEOUS ROCKS.

Scorpion, a name applicable to any member of the family Scorpionida, included along with spiders, mites, &c. in the heterogeneous class Arachnida. Among the common genera are *Scorpio*, *Androctonus*, and *Buthus*. Altogether there are about 200 species, natives of warm countries in both hemispheres. About thirteen species live in southern Europe. Shy of the light, they lurk during the day under stones and in

crevices, but run about actively in the darkness seeking their prey—usually insects or spiders—which they sting and afterwards suck. The form of the body is distinctive: the head and the thorax are united, covered by a cephalo-thoracic shield, and bear a pair of chelicerae, a pair of large pedipalps, and four pairs of walking legs. On the



Common Scorpion (*Scorpio europæus*).

anterior part of the shield there are several pairs of simple eyes, a pair centrally and several pairs near the margin. The abdomen consists of twelve segments, of which five form the narrow 'tail,' which is curled over the back when the animal runs. On the under surface of the abdomen we see most anteriorly a small double plate covering the genital aperture, then a pair of remarkable comb-like appendages or 'pectines,' probably with tactile functions, and behind these on four successive segments the slit-like apertures of four pairs of respiratory lung-books (so called as the lamellae are superimposed like the leaves of a book). The tail ends in a sting, containing a paired gland from which poison flows through the perforated sharp point. When the scorpion strikes it suddenly straightens the tail, bringing the point (which is usually upturned) rapidly downwards. It does not seem possible for the scorpion to sting itself, as is often alleged; there has been much controversy on the subject, the old allegation being that a scorpion surrounded by a ring of fire would, recognising its fate, deliberately commit suicide by stinging itself on the head. Of late years many experiments have been made: scorpions evidently suffer much from great heat, and their excited movements may readily have given rise to apparently suicidal designs such as the creature is of course utterly incapable of forming. As poisonous snakes cannot kill themselves or others of their own species by their venom, so scorpions cannot injure by their poison either themselves or other scorpions. See *Fayrer, Thanatophidia of India* (1873); *Bourne, in Proc. Roy. Soc.* (1887).

In seizing the prey the scorpion's large pedipalps are of use, and the small chelicerae may serve to hold the dead body close to the mouth; the pharynx is suctorial, and the food-canal is very narrow, the food being for the most part merely the juices of the victim. The brain is well developed, and there is a ventral nerve-cord with seven ganglia. The lung-books are like those of spiders. In regard to their reproduction the most interesting fact is the parental care of the mother scorpion, who brings forth her young alive, shelters them under her body, or carries them about with her. When alarmed or irritated scorpions show some fierceness, moving their tail threateningly; they are highly sensitive to sound, musical or other. They are universally disliked, and not a little dreaded, being apt to get into houses, and into beds, hiding themselves under pillows, in shoes, boots, &c., so that accidents are very frequent in countries where they abound. The wound which

they give is seldom fatal, but even that of the common European scorpions is very painful, and that of some of the largest species—which are six inches long—is much more severe, attended with nausea and constitutional derangement, nor do the effects soon cease. It is of use to press a large key or other tube on the wound, so as to force out part of the poison. The best remedy is ammonia, internally administered, and also applied externally; see VENOMOUS BITES.

Scorpion-grass, an old name for Forget-me-not (q.v.), supposed on the Doctrine of Signatures (q.v.) to be good for scorpion bites.

Scory, JOHN, Bishop of Hereford, was born at Acle in Norfolk, and about 1530 was a friar in a Dominican house at Cambridge. After its dissolution in 1538 he got preferment from his patron, Archbishop Cranmer, to whom he was chaplain until in 1551 he became Bishop of Rochester. He was translated next year to Chichester as successor to the deprived Dr Day, but on Mary's accession he was himself deprived, and, appearing before Bonner, renounced his wife, did penance, and had formal absolution (1554). Still he cannot have felt safe, for he fled abroad, first to Emden, and then to Geneva; and from the Continent addressed an 'Epistle to the faithful in prison in England,' exhorting them to continue in patience and hope. Mary dead, he came back to England (1559), and the same year was made Bishop of Hereford, and helped to consecrate Archbishop Parker. We find him in 1579 petitioning Burghley for removal from Hereford ('my present purgatorie') to Norwich, but death only removed him, on 26th June 1585, at his palace of Whitbourne. See vol. i. of Cooper's *Athenæ Cantabrigienses* (1858).

Scorzonera (Ital. *scorza*, 'bark'; *nera*, 'black'), a genus of plants of the natural order Compositæ, sub-order Cichoraceæ, having yellow or rarely rose-coloured flowers. The species are numerous, mostly natives of the south of Europe and the East. No species is found in Britain. The Common Scorzonera of kitchen-gardens, *S. hispanica*, a native of the south of Europe, has long been cultivated for its esculent roots. The root is black externally, white within, about the thickness of a man's finger, long, and tapering very gradually, whence the name *Viper's Grass*, sometimes given to the plant, the root being supposed to resemble a viper. It contains a white milky juice, and has a mild, sweetish mucilaginous taste; it is very pleasant when boiled, the outer rind being first scraped off, and the root steeped in water, to abstract part of its bitterness. The leaves are an inferior substitute for mulberry-leaves in feeding silkworms.—Other species of Scorzonera are used in the same way. The roots of *S. deliciosa*, a native of Parma, are preserved with sugar; those of *S. tuberosa* are a favourite food of the Kalmucks.

Scot, MICHAEL. See SCOTT.

Scot, REGINALD, a writer ever to be held in honour as an early disbeliever in the reality of witchcraft, was a younger son of Sir John Scot of Scotshall near Smeeth in Kent, and was born about 1538. He studied at Hart Hall, Oxford, married in 1568, a second time after 1584, gave himself up to study and to gardening, and perhaps acted as steward to his cousin, Sir Thomas. But little more is known of his life save that he was collector of subsidies for the *lathes* of Shepway in 1586-87, that he himself had property and bore arms, and that he died 9th October 1599. Dr Nicholson finds traces of legal education in his writing. He published *The Hoppe Garden* in 1574 (3d ed. 1578), and is credited with the introduction of hop-growing into England. His famous work, *The*

Discoverie of Witchcraft, appeared in 1584, its deliberate aim to check the persecution of witches. The work is marked by humanity and strong sense, great boldness and power of logic, and is an admirable exposure of the childish absurdities which formed the basis of the witchcraft cases, and of the absurd manner in which the evidence was collected by the inquisitors and witch-finders. The healthy rationalism and openness of mind of the writer were more than two centuries before their time in England, and naturally excited the antipathy of a self-conceited fool like King James, who wrote his *Demonology* (1597) 'chiefly against the damnable opinions of Wierns and Scot, the latter of whom is not ashamed in public print to deny there can be such a thing as witchcraft.' The king's answer was pitiful, but he had the advantage of being able to burn Scot's book by the hands of the common hangman. Scot's work should have been complete as an antidote to 'Sprenger's fables and Bodin's bables, which reach not so far to the extolling of witches' omnipotence as to the derogating of God's glorie;' but, besides the feeble effort of the royal Solomon, answers and refutations continued to be written by Gifford, Perkins, Meric Casaubon, Cotta, and many eminent divines, and, with such few exceptions as the writers Webster, Wagstaffe, Ady, and others, witchcraft kept its hold upon the minds even of great men down to and beyond Glanvill, Sir Thomas Browne, Richard Baxter, and even John Wesley. One great merit of Scot's book to the modern student is its richness as a collection of forms of incantations and the processes of sorcery, for its rational and liberal-minded author had the fairness to quote his antagonists honestly before pulverising them with his logic. The full title of the book best explains its scope and aim: 'The discoverie of witchcraft, wherein the lewd dealing of witches and witchmongers is notable detected, the knaverie of conjurers, the impietie of inchantors, the follie of soothsayers, the impudent falsehood of cousenors, the infidelitie of atheists, the pestilent practices of Pythonists, the curiositie of figure-casters, the vanitie of dreamers, the beggarlie art of Alcumystrie, the abomination of idolatrie, the horrible art of poisoning, the vertue and power of naturall magike, and all the conveinances of Legierdemaine and juggling are deciphered: and many other things opened, which have long lien hidden, howbeit verie necessarie to be knowne'—'for the undeceiving of Judges, Justices, and Juries, and for the preservation of poor, aged, deformed, ignorant people; frequently taken, arraigned, condemned, and executed for Witches, when according to a right understanding, and a good conscience, Physick, Food, and necessaries should be administered to them' was added in the 1651 title-page, besides other changes. This second edition was in quarto; the third, in 1665, was in folio, and contained, from an unknown and less rational pen, nine fresh chapters, commencing the fifteenth book, and a second book of the 'Discourse on Devils and Spirits' appended to the first and second issues. The next edition in time was the limited reprint of 1886, admirably edited, with an Introduction, by Brinsley Nicholson, M.D. See also CONJURING.

Scot and Lot. The old legal phrase *Scot* (A.S. *scot*, 'pay') and *Lot* embraced all parochial assessments for the poor, the church, lighting, cleansing, and watching. Previously to the Reform Act the right of voting for members of parliament and for municipal officers was, in various English boroughs, exclusively vested in payers of Scot and Lot.

Scotch Fir. See PINE.

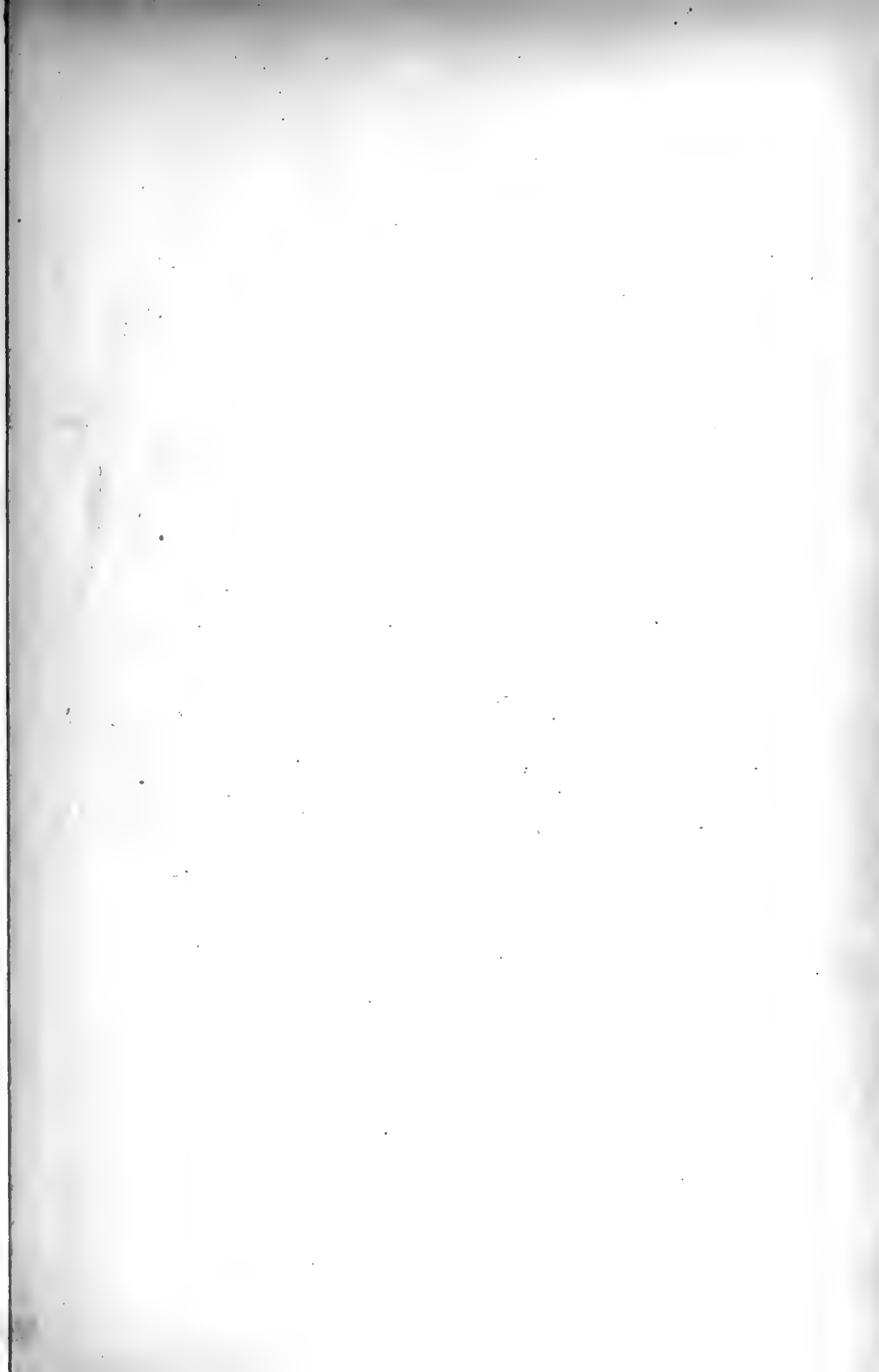

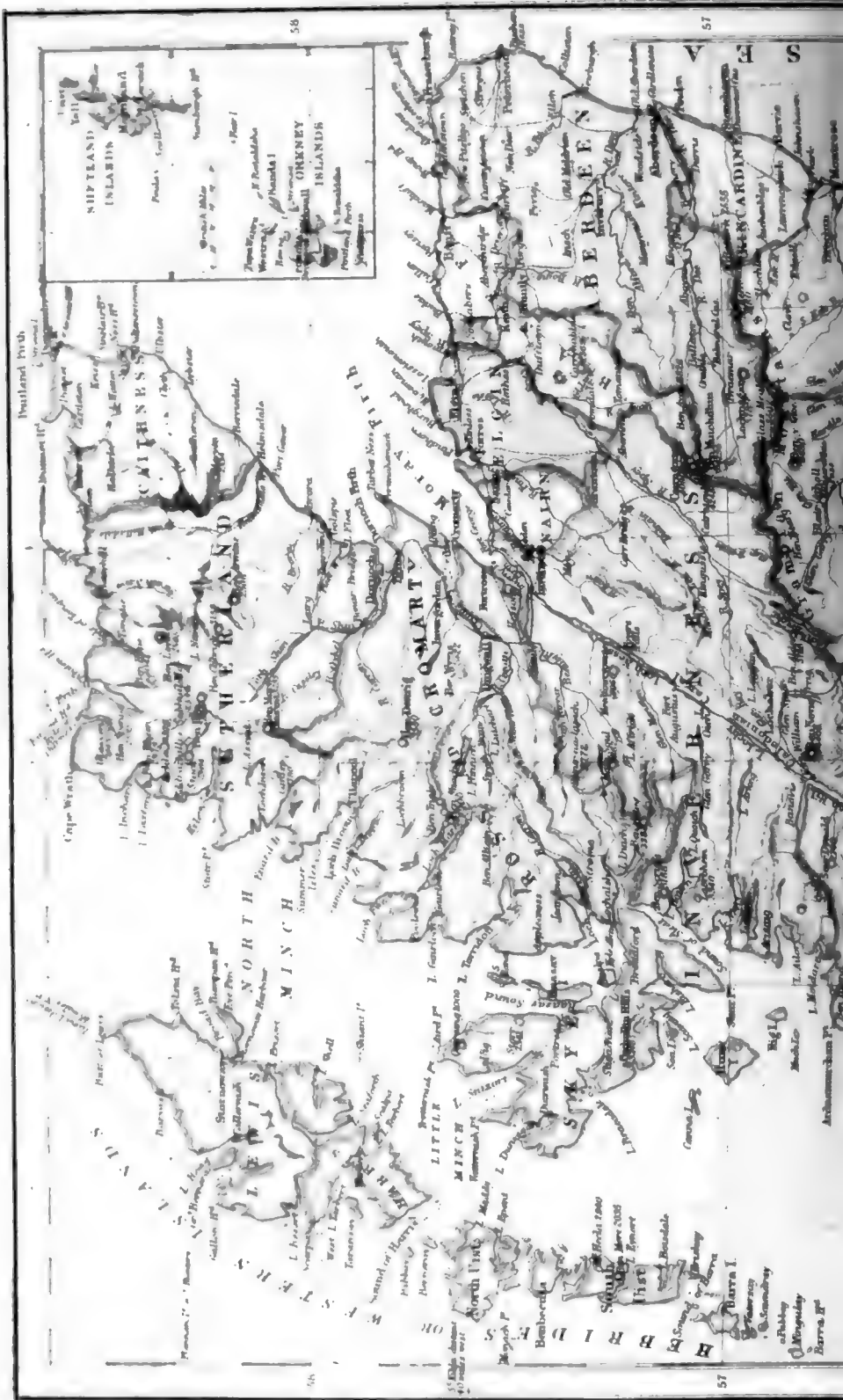

SHETLAND ISLANDS

Map 1

Great Britain

North Harris

Harris

North Lewis

Lewis

South Lewis

South Harris

South Uist

Uist

Barra

Burray

Map 2

North Harris

Harris

North Lewis

Lewis

South Lewis

South Harris

South Uist

Uist

Barra

Burray

56

57

56

57

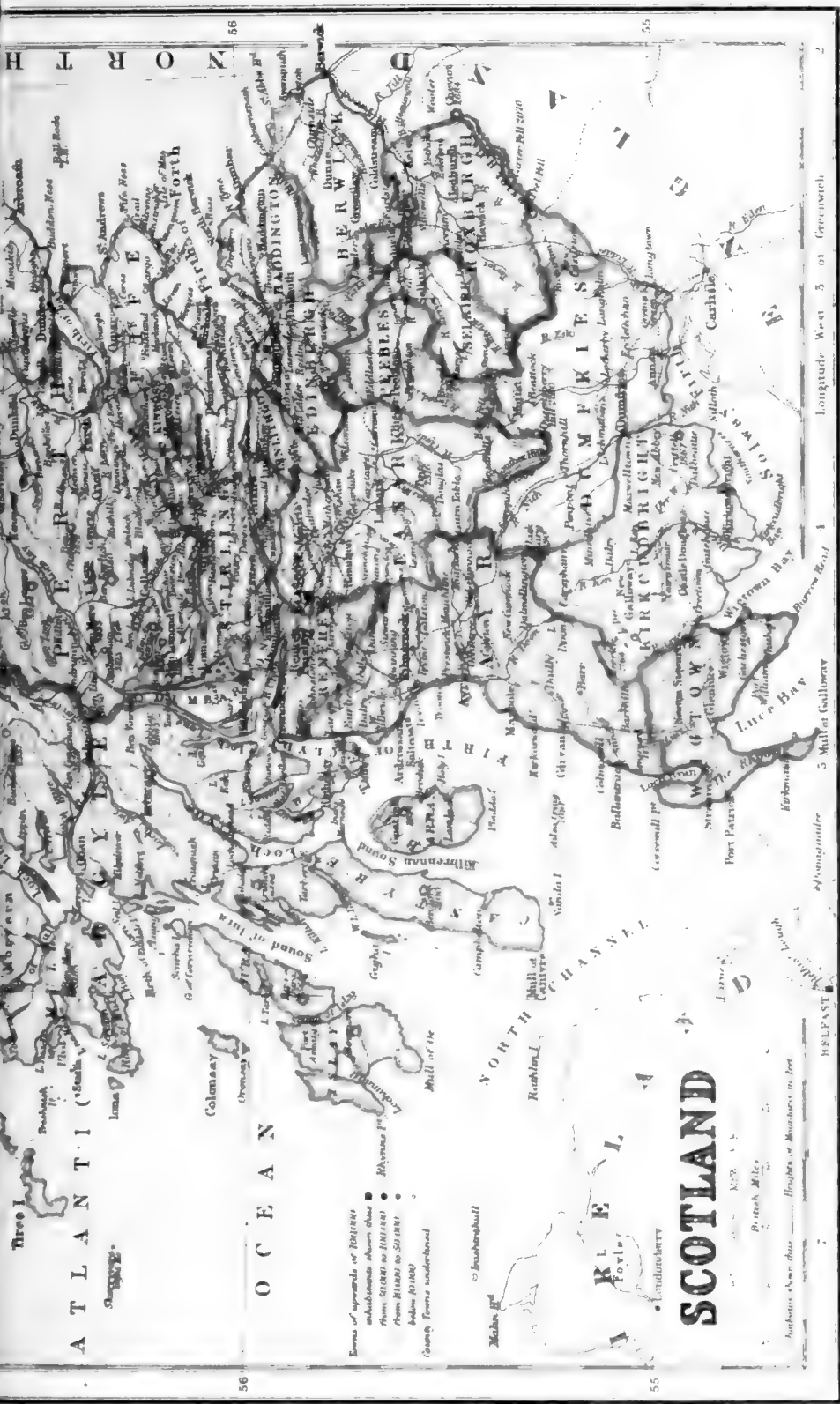

N O R T H

A T L A N T I C O C E A N

56

O C E A N

Terms of copyright of 1911 (1914) subsistence shown above
 From 1914 to 1917 (1917)
 From 1917 to 1918 (1918)
 Below 1918 (1918)
 (Some towns underlined)

London

SCOTLAND

Scale
 1 inch = 10 miles
 1 centimetre = 1 mile

Author's name this

Longitude West 5 of Greenwich

4

5 Mull of Gallura

BELFAST

W & R CHAMBERS LIMITED LONDON & EDINBURGH.

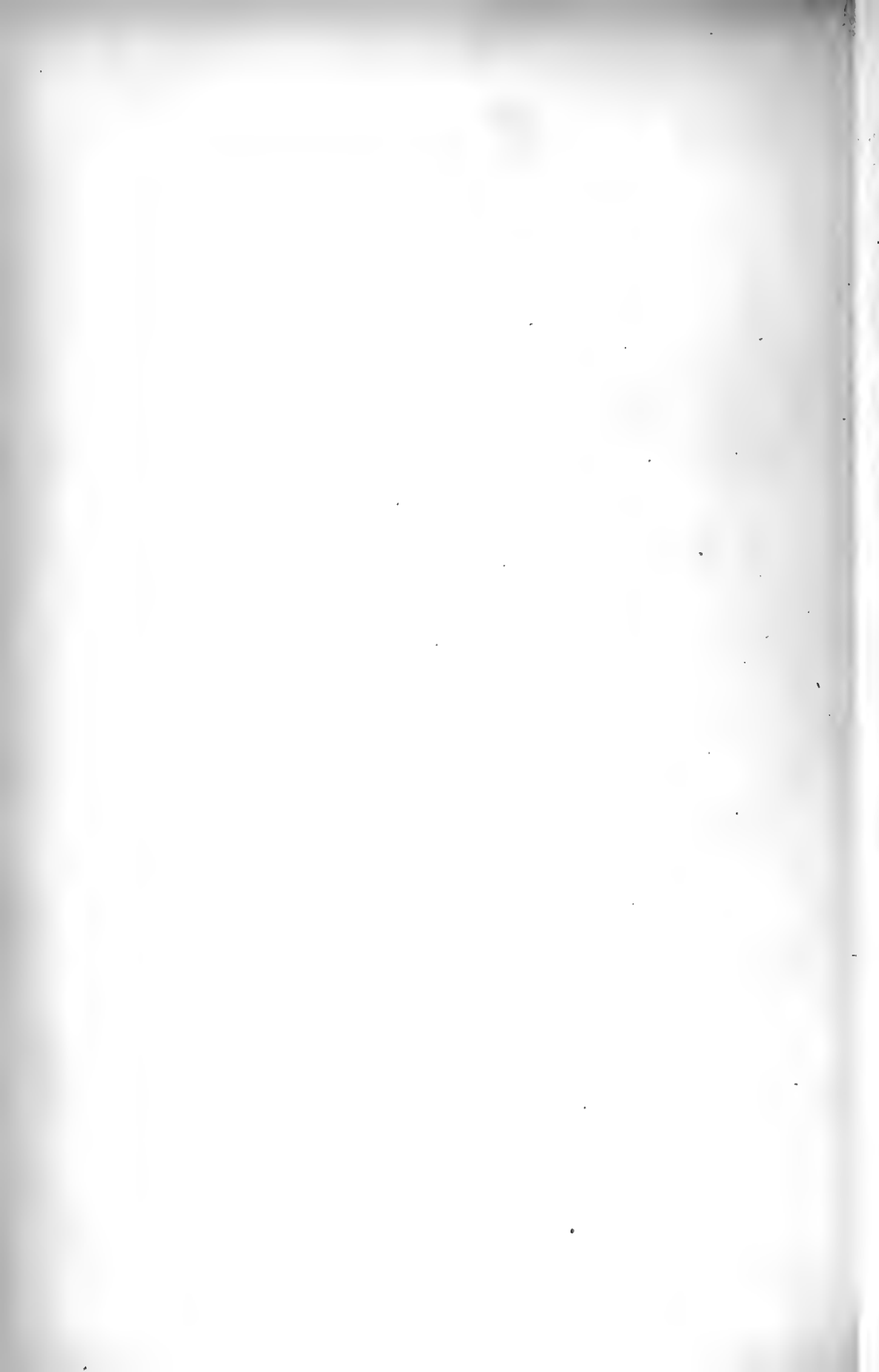

Scoter (*Ædemia*), a genus of oceanic ducks, represented on British coasts by the Common Scoter (*Æ. nigra*), the larger Velvet Scoter (*Æ. fusca*), and occasionally by the North American Surf Scoter (*Æ. perspicillata*). In

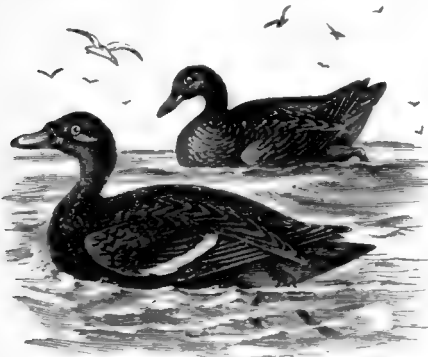

Velvet Scoter (*Ædemia fusca*).

North America *Æ. americana* is widely distributed. The Common Black Scoter is about the size of the common duck. The whole plumage of the male is deep black; that of the female is dark brown. They are abundant in winter on many parts of the British coast, but most migrate in spring to northern Scandinavia, Russia, and Siberia. They usually nest by inland fresh-water lakes. They feed on molluscs. The flesh is oily, and has a fishy taste, but, being therefore permitted to Roman Catholics during Lent, is in great request in some countries.

Scotists. See DUNS SCOTUS, SCHOLASTICISM.

Scotland, the northern part of Great Britain, is washed on the W. and N. by the Atlantic, on the E. by the North Sea, and on the S. is parted from England by the Solway Firth and the (largely artificial) line described in the article BORDERS. Its length, from Cape Wrath to the Mull of Galloway, is 274 miles; its breadth varies between 24 and 146 miles; and its total area is 19,777,490 acres or 30,902 sq. m., of which 631 sq. m. are water and 485 foreshore. The geology, physical geography, meteorology, &c. have already been sketched at GREAT BRITAIN; still, here we may recapitulate the outstanding features of Scotland for purposes of comparison and of reference to innumerable articles scattered throughout this work. Of 787 islands, belonging mostly to the Hebrides, Orkneys, or Shetland, sixty-two exceed 3 sq. m. in area, and of these the largest are Long Island (Lewis and Harris, 859 sq. m.), Skye (643), the Mainland of Shetland (378), Mull (347), Islay (246), Pomona (207), Arran (168), Jura (143), and North Uist (136). Of twenty-six rivers flowing direct to the sea the chief are the Tweed (97 miles long), Forth (75), Tay (93), Dee (87), Don (82), Deveron (62), Spey (96), Clyde (106), and Nith (71); and of these the Forth, Tay, and Clyde expand into important estuaries. There is also the Moray Firth; and indeed the whole coast is so intersected by arms of the sea that few places are more than 40 miles inland. Fresh-water lakes are numerous—Lochs Lomond (27 sq. m.), Ness (19), Awe (16), Shin, Maree, Tay, Earn, Leven, Katrine, &c. The division of Scotland into Highlands and Lowlands, which puzzles strangers, who cannot understand how Wick comes to be Lowland and Inveraray Highland, is explained at HIGHLANDS (q.v.). In the Lowlands the highest points are Merrick (2764 feet) in Kirkcudbrightshire, and Broad Law (2723)

in Peeblesshire; in the Highlands there are no fewer than 184 summits that exceed 3000 feet above sea-level—among them Ben Nevis (4406), Ben Macdhuì (4296), Ben Lawers (4004), Ben Cruachan (3689), Ben Wyvis (3429), and Ben Lomond (3192). See CHEVIOT HILLS, OCHIL HILLS, GRAMPIANS, &c.

In the whole of Scotland the percentage of cultivated area is only 24·2—in Fife as high as 74·8, in Sutherland as low as 2·4. Woods cover less than 1400 sq. m.; and there are 1800 acres of orchards, nearly 5300 of market-gardens, and 1400 of nursery grounds. Between 1857 and 1890 the number of horses increased from 185,406 to 189,727, of cattle from 381,053 to 1,185,876, of sheep from 5,683,168 to 7,361,461, and of pigs from 140,354 to 159,674. In 1890 the value of the total mineral output was £10,705,780, including £8,382,957 for 24,278,589 tons of coal (in 1854 only 7,448,000 tons), £534,265 for 998,835 tons of iron ore, and £599,633 for 2,180,483 tons of oil shale. No very reliable figures are published for the manufactures, which are noticed under the various towns (Glasgow, Dundee, Greenock, Aberdeen, Edinburgh, Dunfermline, Hawick, Galashiels, &c.); but in 1890 there were in all Scotland 747 textile factories, with 2,413,735 spindles, 71,471 power-looms, and 154,591 hands. In shipbuilding, during a period of five years, there was a minimum output of 203 vessels of 112,072 tons in 1886, a maximum of 264 of 209,718 in 1890; whilst during that same period foreign and colonial imports ranged between £27,919,943 and £36,771,016, the exports between £18,248,094 and £24,749,907, and the customs between £1,650,950 and £1,789,260. In 1890 at the twenty-seven head ports there entered 53,212 sailing and steam vessels of 14,651,134 tons, and cleared 53,819 of 12,080,812. The length of the railways has grown from 1243 miles in 1857 to 2700 in 1874, and 3118 in 1890.

The gradual growth of the total population has been as follows: (1801) 1,608,420; (1821) 2,091,521; (1841) 2,620,184; (1861) 3,062,294; (1881) 3,735,573; (1891) 4,025,647, of whom 1,942,717 were males, 2,082,930 females, and 254,415 Gaelic-speaking, and of whom 1,589,874 belonged to the nine principal towns, 1,308,821 to the other towns, 1,008,464 to the mainland rural districts, and 125,944 to the insular rural districts. Those nine principal towns are Glasgow (pop. in 1891 of 565,714, or 792,728 with suburbs), Edinburgh (261,261), Dundee (155,640), Aberdeen (121,905), Leith (69,696), Paisley (66,427), Greenock (63,498), Perth (30,760), Kilmarnock (27,959); and the other towns with more than 10,000 inhabitants are Coatbridge (29,996), Kirkealdy (27,151), Hamilton (24,863), Ayr (24,800), Arbroath (22,960), Dunfermline (22,365), Inverness (19,214), Hawick (19,204), Airdrie (19,135), Motherwell (18,662), Dumfries (17,804), Falkirk (17,307), Galashiels (17,249), Dumbarton (16,908), Stirling (16,895), Wishaw (14,869), Port Glasgow (14,624), Rutherglen (13,361), Montrose (13,048), Forfar (12,844), Peterhead (12,195), Alloa (10,711), and Pollokshaws (10,228).

The officers of state for Scotland are the Secretary for Scotland, the Lord Keeper of the Privy Seal, the Lord Clerk Register, the Lord Advocate, and the Lord Justice-clerk. The duties of the first, appointed under an Act of 1885 (amended 1887), were transferred to him from the Home Secretary, and relate to education, sanitation, manufactures, prisons, &c. For the government of Scotland reference may be made to the articles PARLIAMENT, BOROUGH, and COUNTY, a system similar to that described in the last-named article having been extended to North Britain by the Local Government (Scotland) Act, 1889, with some differences—e.g. that in Scottish county councils there are

no aldermen. Under that act a good many changes have been made in the county boundaries, detached portions of Nairn, Perth, Selkirk, &c. being annexed to the counties surrounding them; whilst Orkney and Shetland, united for parliamentary purposes, were disvered. There thus are thirty-three counties, whose area and population are shown in the following table :

Counties.	Area in statute acres.	Population.	
		1801.	1881.
Aberdeen.....	1,262,097	121,065	281,331
Argyll.....	2,134,274	81,277	75,945
Ayr.....	735,262	84,297	224,222
Banff.....	413,791	37,216	64,167
Berwick.....	297,161	30,206	32,398
Bute.....	143,997	11,791	18,408
Caithness.....	448,967	22,609	37,161
Clackmannan.....	31,876	10,858	28,438
Dumbarton.....	172,677	20,710	94,511
Dumfries.....	706,946	54,597	74,308
Edinburgh.....	234,928	122,597	444,056
Elgin.....	312,346	27,760	43,448
Fife.....	328,427	98,743	187,320
Forfar.....	569,851	99,053	277,788
Haddington.....	179,142	29,986	37,491
Inverness.....	2,767,078	72,672	88,362
Kincardine.....	248,195	26,349	35,647
Kinross.....	49,812	6,725	6,289
Kirkcubright.....	610,343	29,211	39,979
Lanark.....	568,868	147,692	1,045,787
Lanlithgow.....	81,113	17,844	62,789
Nairn.....	137,906	8,322	10,019
Orkney.....	240,640	24,445	30,438
Peebles.....	227,869	8,785	14,760
Perth.....	1,664,680	125,583	126,128
Renfrew.....	162,428	78,501	290,790
Ross and Cromarty.....	1,861,572	56,318	77,751
Roxburgh.....	428,404	33,721	53,726
Selkirk.....	166,524	5,388	27,349
Shetland.....	852,876	22,379	28,711
Stirling.....	298,579	50,825	125,604
Sutherland.....	1,359,846	23,117	21,940
Wigtown.....	327,906	22,918	36,048

See P. Hume Brown's *Early Travellers in Scotland, 1295-1689* (1891); F. Grose's *Antiquities of Scotland* (2 vols. 1789-91); Sir John Sinclair's *Statistical Account of Scotland* (21 vols. 1791-99); Dorothy Wordsworth's *Tour in Scotland* (ed. by Shairp, 1874); G. Chalmers' *Caledonia* (3 vols. 1807-24; new ed. Paisley, 7 vols. 1888 et seq.); R. Chambers's *Picture of Scotland* (2 vols. 1827); the *New Statistical Account* (15 vols. 1845); Sir Thomas Dick Lauder's *Scottish Rivers* (ed. by Dr John Brown, 1874); Billings' *Baronial and Ecclesiastical Antiquities of Scotland* (4 vols. 1848-52); Cosmo Innes' *Origines Parochiales Scotiæ* (3 vols. 1850-55); Hugh Miller's *Cruise of the Beesey* (1858); Sir A. Geikie's *Scenery of Scotland viewed in connection with its Physical Geology* (1865; 2d ed. 1887); Dean Ramsay's *Reminiscences of Scottish Life and Character* (22d ed. 1874); J. Anderson, *Scotland in Early Christian and Pagan Times* (4 vols. 1881-86); F. H. Groome's *Ordnance Gazetteer of Scotland* (1882-85; 2d ed. 1893-95); C. Rogers' *Social Life in Scotland* (3 vols. 1884-86); and MacGibbon and Ross's *Castellated and Domestic Architecture of Scotland* (4 vols. 1886-92). A general reference may suffice to our articles on the counties, towns, rivers, lakes, &c. of Scotland; and special information will be found under a multitude of headings—e.g.:

Advocate, Lord.	Earth-houses.	Ordnance Survey.
Agriculture.	Education, p. 217.	Paraffin.
Ballad.	Fisheries.	Parliament.
Banking, p. 712.	Gaelic.	Pisciculture.
Borders.	Golf.	Poor-laws, p. 315.
Bridge, p. 443.	Great Britain.	Printing, p. 469.
Brochs.	Grouse.	Round Towers.
Canal, p. 699.	Hebrides.	Salmon.
Catrail.	Highlands.	Sculptured Stones.
Celts.	Hill-forts.	Shipbuilding.
Court of Session.	Jute.	Signet.
Covenant.	Lake-dwellings.	Stone-circles.
Criminal Law.	Library, p. 607.	Universities.
Crofter.	Maeshowe.	Volunteers.
Deer-forests.	Newspapers, p. 476.	Whisky.
	Ogam.	Wool.

CIVIL HISTORY.—An account has been given under the article PICTS of the early inhabitants of the country which has long been known by the name of Scotland, but which by the Romans was called Caledonia (q.v.). The original Scotia or Scotland was Ireland, and the Scoti or Scots, at their first appearance in authentic history, were the

people of Ireland (q.v.). The Scots were a Celtic race, and their original seat in Northern Britain was in Argyll, which they acquired by colonisation or conquest before the end of the 5th century; and thence they spread themselves along the western coast from the Firth of Clyde to the modern Ross. The name of Scotland seems first to have been given to the united kingdom of the Picts and Scots in the 10th century. It was then sometimes styled, by way of distinction, *Scotia Nova* (New Scotland), and it was a considerable time afterwards before the name of Scotland was applied to it, to the exclusion of Ireland. This interchange of names was a fruitful source of dispute between Irish and Scottish writers in the 16th and 17th centuries.

The first prince of the British Scots mentioned in our authentic annals was Fergus, son of Erc, who crossed over to Britain about 495 or 498. His nation had been converted to Christianity by St Patrick, and Fergus himself is said to have received the blessing of the saint in his early years. His great-grandson, Conal, was king of the British Scots when Columba (q.v.) began the conversion of the Northern Picts; and by that prince, according to the best authorities, Iona was given for the use of the mission. Conal was succeeded by his nephew, Aidan, who was inaugurated as sovereign by St Columba in the island of Iona—a ceremony which Scottish writers, misled by the great French antiquary Martène, long believed to be the first example of the benediction of kings. Aidan was a powerful prince, and more than once successfully invaded the English border, but in 603, towards the end of his reign, he received a severe defeat from the Northumbrian sovereign Ethelfrid at Dægstane (probably Dawstone in Liddesdale).

The history of Aidan's successors is obscure and uninteresting, except to the professed students of our early history. Their kingdom was overshadowed by the more powerful monarchy of the Picts, with which, as well as with its neighbours in the south—the Britons of Cumbria—it was engaged in almost unceasing conflict. The Scots were for a time under some sort of subjection to the English of Northumbria, but recovered their independence on the defeat and death of King Egfrid in battle with the Picts at Nechtansmere (Dunnichen, Forfarshire) in 685. In the middle of the 9th century, by a revolution, the exact nature of which has never been ascertained, the Scots acquired a predominance in Northern Britain. Kenneth Macalpin, the lineal descendant of Fergus and Aidan, succeeded his father as king of the Scots in 836. The Pictish kingdom was weakened by civil dissension and a disputed claim to the crown. Kenneth laid claim to it as the true heir in the female line, and was acknowledged king of Alban in 843.

King Kenneth transferred his residence to Forteviot in Strathern, which had been the Pictish capital, fixing soon afterwards the ecclesiastical metropolis of the united kingdom at Dunkeld, whence in 908 it was translated to Abernethy. The Picts and Scots, each speaking a dialect of the Celtic tongue, gradually coalesced into one people, whose territory extended from the Firths of Forth and Clyde to the northern extremity of Britain. The crown descended to a line of princes of the family of Kenneth, whose rule gave a unity and comparative tranquillity to the Scots of Britain which those of Ireland, at no time really united under one prince, never possessed. The first interruption to the descent of the crown in the line of Kenneth was the reign of a usurper named Grig, round whose name, amplified to Gregory by the writers of a later age, a cloud of legendary fiction gathered. The old family was restored on his expulsion in 893.

The reign of Constantine, son of Aodh, who succeeded in 904, was a remarkable one. In his time it is probable that the seat of the ecclesiastical primacy was transferred from Abernethy to St Andrews, and that the regal residence was fixed at Scone. At the latter place, in the sixth year of his reign, the chronicles mention that Constantine the king, Kellach the bishop, and the Scots swore to observe the laws and discipline of the faith and the rights of the churches and the gospels. This seems to indicate the meeting of some sort of council, civil or ecclesiastical, or more probably a combination of both, according to the form prevalent at this period both among the Celtic and the Teutonic nations. Even before the establishment of the kingdom of the Picts and Scots in the person of Kenneth, Northern Britain had experienced the attacks of a new enemy, the Scandinavian invaders, generally spoken of under the name of Danes. Constantine resisted them bravely, but towards the end of his reign he entered into an alliance with them in opposition to the English. In 937 a powerful army, composed of Scots and Picts, Britons and Danes, disembarked on the Humber, and was encountered at Brunanburh (q.v.) by Athelstan, king of England. A battle was fought there, the first of a series of unfortunate combats by Scottish princes on English ground. The confederate army was defeated, and, though Constantine escaped, his son was amongst the slain. Weary of strife, the king soon afterwards retired to the Culdee monastery at St Andrews, of which he became abbot, and there died in 953.

During the reign of Malcolm, the first of that name, and the successor of Constantine, a portion of the Cumbrian kingdom, including the modern Cumberland and part of Westmorland, which had been wrested from the Britons by Edmund, king of England, was bestowed by that prince on the Scottish sovereign. This grant was the foundation of that claim of homage made by the English kings on the Scottish sovereigns, which afterwards became the cause or the pretext for the great struggle between the two nations. The northern kingdom was still further increased in the reign of Kenneth, son of Malcolm, by the acquisition of Lothian, and of Northern Cumbria, or Strathclyde. The former province, previously a part of the Northumbrian kingdom, and entirely English in its population, was bestowed on Kenneth by Edgar, king of England. The Cumbrian kingdom, which had at one time extended along the west coast from the Firth of Clyde to the border of Wales, had been weakened by the loss of its southern territories; it was inhabited by a Celtic people speaking Cymric or Welsh, and now fell under the dominion of the Scottish king, though its inhabitants long retained their own speech and a peculiar system of laws (see BRETT'S AND SCOTS). The last addition to Scotland in the south took place under Malcolm II., son of Kenneth, who acquired the Merse and Teviotdale from the Earl of Northumbria, and thus advanced his kingdom on the eastern border to the Tweed. The reign of Malcolm II. extended from 1003 to 1033. The kings who immediately followed are better known to the general readers than any of their predecessors, Shakespeare having made their names familiar to every one. Malcolm's successor was his grandson, Duncan, whose brief reign was followed by that of Macbeth (q.v.). The latter was a vigorous and prudent ruler, munificent to the church, and famous as the only Scottish king who made a pilgrimage to Rome. But, although by marriage he was connected with the royal line, he was unable to secure the affection of his subjects. Malcolm, the eldest son of Duncan, assisted by his kinsman, Siward, Earl of Northumbria, invaded Scotland. The usurper was defeated and

slain at Lumphanan, in Mar, in 1057, and Malcolm was acknowledged as king.

The long reign of Malcolm Canmore was the commencement of a great social and political revolution in Scotland. His residence in England, and still more his marriage with the English Princess Margaret, the sister of Edgar Atheling, led to the introduction of English customs, the English language, and an English population into the northern and western districts of the kingdom. The influx of English colonists was increased by the tyranny of William the Conqueror and his Norman followers. All received a ready welcome from the Scottish king, whose object it was to assimilate the condition of the Scots in every respect to that of their fellow-subjects in Lothian; and what his stern, though generous, character might have failed to accomplish was brought about by the winning gentleness and Christian graces of his English queen.

Malcolm fell in battle before Alnwick Castle in the year 1093, and Margaret survived only a few days. It seemed as if the work of their reign was about to be utterly overthrown. The Celtic people of Scotland, attached to their old customs, and disregarding the claims of Malcolm's children, raised his brother, Donald Bane, to the throne. The success, however, of this attempt to restore a barbarism which the better part of the nation had outgrown was of brief duration; Donald was dethroned, and Edgar, the eldest surviving son of Malcolm and Margaret, was acknowledged as king. The very name of the new sovereign marked the ascendancy of English influence. That influence, and all the beneficial effects with which it was attended, continued to increase during the reigns of Edgar and his brother and successor, Alexander I. The change went steadily on under the wise and beneficent rule of David (q.v.), the youngest son of Malcolm. His reign, which extended from 1124 to 1153, was devoted to the task of ameliorating the condition of his subjects, and never was such a work more nobly accomplished. David was in every respect the model of a Christian king. Pious, generous, and humane, he was at the same time active and just, conforming himself to the principles of religion and the rules of the church with all the devotion of his mother, but never forgetting that to him, not to the clergy, God had committed the government of his kingdom. He was all that Alfred was to England, and more than St Louis was to France. Had he reigned over a more powerful nation his name would have been one of the best known among those of the princes of Christendom. At the time of David's accession Scotland was still but partially civilised, and it depended in a great measure on the character of its ruler whether it was to advance or recede. It received a permanent stamp from the government of David. The Celtic people were improved morally, socially, and ecclesiastically, and all along the eastern coast were planted Norman, English, and Flemish colonies, which gradually penetrated into the inland districts, and established the language and manners of that Teutonic race which forms the population of the greater part of Scotland. David encouraged and secured the new institutions by introducing a system of written law, which gradually superseded the old Celtic traditional usages, the first genuine collections of Scottish legislation belonging to his reign. David was as great a reformer in the church as in the state. The ecclesiastical system prevalent in Scotland almost up to his time differed in some points from that established in England and on the Continent, bearing a great resemblance to that of Ireland, from which it was indeed derived. David established dioceses, encouraged

the erection and endowment of parishes, provided for the maintenance of the clergy by means of tithes, and, displacing the old Celtic monastic bodies, introduced the Benedictine and Augustinian orders.

David, though devoting his energies to the improvement of his subjects in the manner which has been mentioned, did not forget duties of a less agreeable kind. He knew that a Scottish king really held his crown by the tenure of the sword, and none of his fierce ancestors was a more intrepid warrior than the accomplished and saintly David. His skill and courage were shown, though without success, at the Battle of the Standard. As the representative through his mother of the ancient kings of England, he had many friends in that country; and had the Scottish army been successful the history of the two kingdoms might in some respects have been different. As it was, he contented himself with maintaining the cause of his sister's child, the Empress Matilda, against King Stephen.

David's grandson and successor, Malcolm IV. (1153-65), and his brother, William the Lion (1165-1214) pursued the policy of their grandfather with equal resolution, though sometimes with less success. They were embarrassed by their connection with the English King Henry II., who took advantage of his superior power and ability to impose unwise and unjust restraints on the independence of the Scottish sovereigns and their kingdom—a policy which laid the foundation of the unhappy national strife of after years. This was averted for a time by the concessions of Richard I. in 1189. 'For more than a century,' says Lord Hailes, 'there was no national quarrel, no national war between the two kingdoms—a blessed period.' That period was well employed by the next two kings, Alexander II. and Alexander III., the son and grandson of William the Lion, to consolidate the institutions of their kingdom, and extend and confirm what had been begun by David. Alexander III. was one of the ablest and best of the Scottish kings. By a treaty with the king of Norway he added to his kingdom Man and the other islands of the Western Sea, held by the Norwegians. His sudden death in 1286 was one of the greatest calamities with which Scotland could have been afflicted. It closed a period of prosperity—a course of improvement—which the kingdom did not again enjoy for fully 400 years.

On the death of the infant granddaughter and heiress of Alexander III. in 1290 the succession to the crown was disputed. The question between the two chief claimants, Baliol and Bruce (q.v.), was not free from doubt according to the customs of the time; and Edward I. (q.v.) of England, to whom the decision was referred, appears at first to have acted with good faith. But this great king, who had already subdued Wales, was now bent on uniting the British Islands under one sceptre; and in the pursuit of that object he sacrificed humanity, honour, and justice. The results were most deplorable. The national spirit of the Scots was finally roused, and after a long struggle under Wallace and Bruce, in 1314 they secured their independence on the field of Bannockburn (q.v.). The battle of freedom was won; but it was at the expense of tranquillity and civilisation. The border counties were continually wasted by the English; the central provinces were the scene of frequent warfare among the chief nobles; and the highland districts became more and more the seat of barbarism, the Celtic tribes re-acquiring something of their old ascendancy, just as they did in Ireland in the troubled times which followed the invasion of Edward Bruce. The strong arm of King Robert might have repressed these disorders had his life been longer spared after

the treaty of Northampton; but his death in 1329 and the accession of an infant son again plunged the country into all the miseries of foreign and civil war. When that son, David II., grew up to manhood he proved in every respect unworthy of his great father. The reigns of this prince and his successors Robert II. and Robert III., the two first princes of the House of Stewart, may be regarded as the most wretched period of Scottish history. In the year 1411 the kingdom would have become absolutely barbarous if the invasion of the Lord of the Isles had not been repulsed at Harlaw (q.v.) by the skill of the Earl of Mar and the bravery of the lowland knights and burghesses.

A happier time began to dawn with the release of James I. in 1424 from his English captivity. The events of the following period are better known, and a brief notice of the most important will be sufficient. Reference may be made for details to the accounts of the particular kings. The vigorous rule of James I. had restored a tranquillity to which his kingdom had long been unaccustomed; but strife and discord were again brought back on his assassination. One of the most calamitous features of the time was a long series of minorities. James himself had succeeded to the crown when a child and a captive; James II., James III., James IV., James V., Mary, and James VI. all succeeded while under age, and all except James IV. when little more than infants. The courage and ability shown by almost all the Stewart princes were insufficient to repair the mischiefs done by others in the beginning of their reigns, and to abate the great curse of the country—the unlimited power and constant feuds of the nobles. The last addition to the Scottish kingdom was made in the reign of James III., when the islands of Orkney and Shetland were made over to him as the dowry of his queen, Margaret of Denmark. The marriage in 1503 of James IV. with Margaret of England was far more important in its ultimate results, and brought about in the reign of his great-grandson that peaceful union with England which the death of the Maid of Norway had prevented in the 13th century. Many good laws were enacted during the reigns of the Jameses; but the wisdom of the Scottish legislature was more shown in framing them than the vigour of the government in enforcing them. Among the most important improvements of the period was the establishment of universities—the first of which, that of St Andrews, was founded during the minority of James I.—and the institution of the College of Justice in the reign of James V.

During the reign of the fifth James religious discord added another element to the evils with which Scotland was afflicted. The practical corruptions of the church were greater than they were almost in any other country in Europe, and one of the consequences was that the principles of the Reformation were pushed further than elsewhere. The first great ecclesiastical struggle had hardly ceased, by the overthrow of the Roman Catholic system, when the strife began anew in the Reformed Communion in the shape of a contest between Episcopacy and Presbyterianism, the former being supported by the sovereign, the latter by the common people, the nobles throwing their weight into either scale as it suited their policy at the time. James VI. struggled hard to establish an absolute supremacy, both in church and state, in opposition to a powerful party, which admitted no royal authority whatever in the former and very little in the latter. After his accession to the English crown he was apparently successful in carrying out his designs, but during the reign of his son, Charles I., the contest again broke out with increased bitterness. The nobility, whose rapacity

had been checked by the sovereign, joined the popular party. The opponents of the crown bound themselves together, first by the National Covenant, and afterwards, in alliance with the English Puritans, by the Solemn League and Covenant. Their efforts were completely successful, but their success led to the utter overthrow of the monarchy by Cromwell. See MONTROSE.

The restoration of Charles II. was welcomed by all classes, wearied as they were of a foreign and military rule, but especially by the nobles and gentry, who had learned by bitter experience that the humiliation of the sovereign was necessarily followed by the degradation of their order. Had the government of Charles II. and James VII. been reasonably just and moderate it could hardly have failed in securing general support; but it was more oppressive and corrupt than any which Scotland had experienced since the regencies in the minority of James VI. The natural result was the revolution which seated William and Mary on the throne: the Jacobite victory of Killiecrankie was more than neutralised by the fall of Dundee.

The parliament of Scotland, which met for the last time in 1706, was originally composed, like the English parliament, of three classes—the ecclesiastics (consisting of bishops, abbots, and priors), the barons, and the burghesses. The spiritual lords during the establishment of Episcopacy after the Reformation were composed of bishops only. When Presbyterianism was established at the time of the Covenant, and when it was formally ratified by law at the Revolution, the ecclesiastical estate ceased to have any place in parliament. The barons, or immediate vassals of the crown, at first sat in their own right, whether holding peerages or not; but afterwards the peers alone sat, the others sending their representatives. The burghesses were the representatives of the burghs. All the three estates sat to the very last in one house, the sovereign presiding in person, or through a commissioner named by him.

Hardly had the majority of the nation been successful in the Revolution settlement when many of them began to repent of what they had done, and Jacobitism became more popular than royalist principles had ever been when the House of Stewart was on the throne. The discontent was greatly increased by the fears entertained of English influence. Ancient jealousies had been revived and intensified by the collapse of the Darien Scheme (q.v.). The state of matters grew so threatening after the accession of Queen Anne that the ruling English statesmen became satisfied that nothing short of an incorporating union between the two kingdoms could avert the danger of a disputed succession to the throne and of a civil war. Supported by some of the ablest and most influential persons in Scotland, they were successful in carrying through their design, though it was opposed by a majority of the Scottish people, under such leaders as Fletcher (q.v.). The Act of Union was formally ratified by the parliament of Scotland on the 16th of January 1707. It subsequently received the royal assent, and came into operation on the 1st of May of the same year. The union continued to be unpopular in Scotland for many years, an unpopularity increased by the corrupt means freely used to carry it through. Suspicions were cherished that the national life would pass away with the national separateness, and that the independence of the Scottish church and the distinctness of the national system of jurisprudence would inevitably suffer. There were agitations and petitions for the repeal of the union and the restoration of the national parliament. But the discontent gradually died down; not that the malcontents were silenced by argument but by the logic of facts. The

association with the larger and wealthier kingdom of the south opened a vastly wider field to the enterprise for which in all departments of life the 'præferendum ingenium Scotorum' had already been noted; and the rapid growth of prosperity by the extension of old and the establishment of new industries helped to bring about a sense of well-being and content. The peaceful acquiescence of the great majority of the nation in the union was brought out at the time of the Jacobite rebellions of 1715 and 1745 (see JACOBITES); the Porteous Mob (q.v.) was a temporary ebullition of a discontent only partly political. It became patent to all that the consequences of the union were beneficial to both countries; yet Scotland and England are in many respects two countries still, and a Scot abroad, asked if he is an Englishman, will seldom give an affirmative answer.

Scotland and Scotsmen have taken a prominent part in the public affairs and intellectual life of the United Kingdom, in its warfare and colonial expansion; the literature of Scotland blossomed luxuriantly (see below) after the union; Reid and Dugald Stewart founded a school of philosophy (see SCOTTISH PHILOSOPHY), as Jeffrey and Cockburn did a school of criticism; and in the 18th century the 'Modern Athens' was more conspicuously a centre of literary and intellectual culture than at any former period. A long series of scientific worthies connects the days of Napier of Merchiston with those of Lord Kelvin (Sir William Thomson) and Professor Tait—including in mathematics, physics, and chemistry the Gregories, Simon, Black, Brewster, J. D. Forbes, Clerk-Maxwell, and Macquorn Rankine; in engineering and steam navigation, Watt, Rennie, Telford, Symington, Henry Bell, Fairbairn, and the Stevensons; in geology, almost all the greatest British names—Hutton, Playfair, Hall, Murchison, and Lyell; in zoology, Edward Forbes and Wyville Thomson; Brown the great botanist; and in medicine and surgery, the dynasties of Gregories, Cullens, Monros, Hunters, and Bells, Simpson, Liston, and Syme. Paterson and Law, founders of the Bank of England and the Bank of France, were Scotsmen. Erskine and Campbell sat on the woolsack of England, Sir Alexander Cockburn was Lord Chief-justice. Of painters, Jameson, Allan, Nasmyth, Thomson, Raeburn, Wilkie, Dyce, David Scott, Phillip, and MacCulloch may be named, with the brothers Adam, architects. Amongst soldiers have been Marshal Keith, Marshal Stair, Abercromby, Moore, Heathfield, Lynedoch, and Lord Clyde; amongst sailors, Camperdown and Dundonald; and there have never failed Scottish travellers and explorers from the days of Bruce 'the Abyssinian' to those of Livingstone and Joseph Thomson.

The 'Scot abroad' was always a familiar phenomenon equally in French universities and in French, Austrian, Swedish, and Russian armies; and Scotsmen have not since then become a race of stay-at-homes. From a paper in the *Scottish Geographical Magazine* for 1885 it appears that, apart from the incalculable numbers of persons of Scottish descent in the south, there were then in England and Wales upwards of 253,000 persons of Scottish birth. Sir Charles Dilke has said (in *Greater Britain*), 'In British settlements from Canada to Ceylon, from Dunedin to Bombay, for every Englishman you meet who has worked himself up to wealth from small beginnings without external aid, you find ten Scotsmen.' Yet the comparative numbers of Scotsmen in the colonies are not so great as this statement suggests; in the various Australian colonies they vary from a fifth to a seventh of the total number of colonists born in the United Kingdom; in New Zealand about one-third; in

Canada settlers of Scottish descent are to those of English descent as 70 to 100; in the United States the Scottish born are not a fourth of the English born citizens. Eminent English statesmen like Mr Gladstone have been of purely Scotch descent. Sweden has its Hamiltons, Germany Douglasses; the great philosopher Kant, the Russian poet Lermontoff, the Norwegian composer Grieg bear Scottish names more or less modified.

See the 'Historians of Scotland' series (10 vols. 1871-80), comprising the chronicles of Fordun and Wyntoun, the lives of SS. Ninian, Kentigern, and Columba, the *Critical Essay on the Ancient Inhabitants of Scotland*, by Father Innes (q.v.), &c.; the *History of Bede*, the *Irish Annals*, and especially Skene's *Celtic Scotland* (3 vols. 1876-8); new ed. 1886). For the period down to the Reformation may be added the *Chronicles of Melrose and Lanercost*, Leslie's and Buchanan's *Histories*, E. W. Robertson's *Scotland under her Early Kings* (2 vols. 1862), and the *Acts of the Scottish Parliament*. For the period from the Reformation to the Union—Knox's, Calderwood's, Spottiswoode's, and Robertson's *Histories*, Baillie's *Letters*, Wodrow's and Burnet's *Histories*, the *Acts of Parliament*, and the *State Papers*. The Scotch Records publications include *The Exchequer Rolls of Scotland*, *Accounts of Lord High Treasurer*, *Register of Privy-council*, *Documents illustrating Scottish History*. See also Pinkerton's *Inquiry*; Hailes's *Annals*; the histories by Tytler, Laing, Hill Burton, Hume Brown (vol. i. 1899), and Laing (vol. i. 1899), with smaller works by Mackenzie and Macarthur; Chambers's *Domestic Annals*; the works of Cosmo Innes; Hill Burton's *Scot Abroad*; Mackintosh's *History of Civilisation in Scotland* (1878-84), his *Scotland from the Earliest Times to the Present Century* (1890); and the Duke of Argyll's *Scotland as it was and as it is* (1887); besides works on special periods. Additional references may be found by consulting articles in this work, such as GOWRIE CONSPIRACY, JACOBITES, &c., and the lives of the kings and other great personages of Scottish history. For the royal arms of Scotland, see HERALDRY, Vol. V. p. 669.

ECCLESIASTICAL HISTORY.—Christianity in Scotland dates from the 4th century, but its beginnings are obscure. What we know centres mainly round the lives of the great Celtic missionaries, Ninian, Kentigern, and Columba, and may be traced in the articles on them, as also in those on Adamnan, on Cuthbert, on the Culdees, and on the Picts. The connection of St Palladius, 'chief apostle of the Scottish nation,' with Scotland seems mythical; he is said to have been sent 'in Scotia' in 430 by Pope Celestine; but the 'Scotia' here meant was certainly Ireland, and Skene doubts if Palladius was ever in Scotland till after his death, when St Ternan brought his relics to Fordoun in Kincardineshire. The doctrines of the ancient Scottish Church were the same as those of the rest of Western Christendom. In ritual there were some points of difference, but so slight that the most important related to the time of observing the Easter festival. In these points also the Scots gradually conformed to the usage of the Roman and English Churches. In one point, however, there continued for several centuries to be a marked distinction between the Scots and Irish on the one hand and the churches of England and the Continent on the other. This was in reference to ecclesiastical government. The Scots recognised the same orders of the ministry, bishops, priests, and deacons, as other Christians did; and like them they held that ordination could be given only by bishops. But they acknowledged no such supremacy of jurisdiction in the episcopal order as was held by other churches. In Scotland there were neither dioceses nor parishes; but there were numerous monasteries in which the abbots, whether bishops or priests, bore the chief rule, all being in subordination to the successor of St Columba, the presbyter-abbot of Iona, who in virtue of that office was primate of the Picts and Scots.

When Iona was desolated by the Northmen the primacy seems to have been transferred in the middle of the 9th century to the Abbots of Dunkeld, then to the Bishops of Abernethy, and finally to the Bishops of St Andrews, who became known as *Episcopi Scotorum*, the bishops of the Scots. Slowly at first, but gradually, an assimilation to the English and continental usages began, a change rendered more easy by the Scottish dominion being extended over Lothian, in which the ecclesiastical system was the same as that of England. A great impulse was given in the same direction by the marriage of Malcolm III., king of the Scots, with Margaret the sister of Edgar Atheling. The king and queen used their utmost efforts to introduce the English usages in ecclesiastical as in other matters; and Margaret herself held repeated conferences for that purpose with the chief Scottish ecclesiastics, at which her husband acted as interpreter. The principal points in which she attempted to bring about a reform were the commencement of the Lent fast, the superstitious infrequency of receiving the communion, and the lax observance of Sunday and of the scriptural and canonical restrictions on marriage between relations.

The reform begun by Malcolm and Margaret was fully carried out by their youngest son, David I. These improvements were completed by his successors, and before the end of the 12th century the ecclesiastical system of Scotland differed in no important point from that of the rest of Europe. Some Scottish writers have lamented the change, as being one from purity of belief and practice to superstition and immorality. This is undoubtedly a mistake. The Celtic Church had become very corrupt, and the clergy were inferior both in learning and morals to their brethren in the south. King David was a reformer in the best sense of the word, and it does not detract from the character of his reformation that as time went on the Scottish Church became involved in those superstitions with which the rest of Christendom was overspread.

The ritual of the Scottish mediæval church was almost the same as that of England, the Salisbury Missal and Breviary being the models of the Liturgies and Office Books used in Scotland. The external system of the church—cathedral, parochial, and monastic—was also in almost every point identical. The chief monastic orders were the Benedictine and its most important branches the Clugniac and Cistercian, the canons regular of St Augustine, and the Reformed Premonstratensian canons. The Clugniacs and Cistercians were in strict subordination to the mother-houses of their orders at Clugny and Cîteaux. In the 13th century the Dominican, Franciscan, and Carmelite friars were introduced into Scotland. The chapters of all the Scottish cathedrals, except those of St Andrews and Whithorn, were composed of secular canons—the chief dignitaries being a dean, archdeacon, chancellor, precentor, and treasurer. The prior and canons regular of the Augustinian monastery at St Andrews formed the chapter of that see, and the prior and Premonstratensian canons of Whithorn formed the chapter of the cathedral of Galloway. There were twelve dioceses in the Scottish Church, to which Orkney was added on the transference of those islands to the Scottish sovereign in the 15th century. The twelve dioceses were Caithness, Ross, Moray, Aberdeen, Brechin, Dunkeld, Dunblane, St Andrews, Argyll, the Isles, Glasgow, and Galloway. The larger of these dioceses were divided, like the English dioceses, into rural deaneries. The single point in which the mediæval church down to the 15th century differed from that of England and other churches of the west was in its having no metropolitan. St Andrews, and next to

it Glasgow, had a certain precedence; the bishops of the former see, and failing them the bishops of the latter, having the privilege of crowning and anointing the sovereign. But they had no jurisdiction over the other sees, nor did their bishops bear the style of archbishop. This led to claims on the part of the Archbishops of York to metropolitan authority in Scotland, which had no foundation except in regard to the southern portion of the diocese of St Andrews and the see of Galloway, the bishops of which were for several centuries suffragans of York. The court of Rome found it convenient, for the sake of its own privileges, to encourage this anomalous system; but to provide for the meetings of the Scottish bishops in provincial council a bull of Pope Honorius III. in 1225 authorised them to meet in synod. In virtue of this bull the bishops, abbots, priors, and other chief ecclesiastics, with representatives of the capitular, collegiate, and conventual bodies, assembled annually in provincial synod, sitting in one house under the presidency of a conservator chosen by and from the bishops. The chief government of the church under the pope thus devolved on these synods and their elective presidents. This continued until the erection of St Andrews into an archiepiscopal and metropolitan see, in virtue of a bull of Pope Sixtus IV. in 1472. By this bull all the Scottish sees were made suffragans to that of St Andrews, whose bishops were now to be styled archbishops.

In 1492 Glasgow was raised to the dignity of a metropolitan see by a bull of Pope Innocent VIII., and the bishops of Dunkeld, Dunblane, Galloway, and Argyll were made suffragans to its archbishop, an arrangement which was soon afterwards altered to some extent—Dunkeld and Dunblane being reannexed to St Andrews, and Glasgow having for its suffragan sees those of Galloway, Argyll, and the Isles. This last arrangement continued till the Reformation, and afterwards during the establishment of Episcopacy—the two Scottish archbishops occupying towards each other precisely the same position as the Archbishops of Canterbury and York, and being sometimes involved in the same unseemly broils, in regard to jurisdiction and precedence, which long existed between the English metropolitans.

The ignorance and immorality of the clergy were far worse than they were in England, or perhaps anywhere in Europe, except in the Scandinavian churches. The desire for reformation which led to the proceedings of Huss and Wyclif produced similar effects in the Scottish kingdom. As early as the year 1406 or 1407 James Resby, an English priest and a disciple of Wyclif, was burned at Perth; and in 1433 Paul Crerar, a Bohemian Hussite, was burned at St Andrews. The opinions of Wyclif continued to be privately taught, particularly in the south-western counties, where his followers were known by the name of the Lollards (q. v.) of Kyle. In the following century the intercourse with the Continent was frequent and close, and the effects of Luther's preaching and writings were soon felt in Scotland. In the year 1525 the importation of Lutheran books and the propagation of the Reformer's tenets were forbidden by an act of the Scottish parliament; and in February 1528 Patrick Hamilton, abbot of Ferne, was burned at St Andrews for teaching and publishing Lutheran doctrines. The piety of Hamilton and the patience with which he bore his sufferings induced others to follow his teaching and example. Several persons, both ecclesiastics and laymen, were subsequently burned, and many more fled to England or the Continent.

The persecution, though encouraged or permitted

by the bishops, was disapproved of by some ecclesiastics of learning and influence, who were desirous of effecting a reform in the church without breaking off from communion with the hierarchy. The efforts of this school were unsuccessful, and the Scottish nation was gradually divided into two parties—one of which, headed by the bishops and supported by the state, was determined to resist all change; and the other, composed of a considerable number of the clergy both regular and secular, of the gentry, and of the burghesses of the large towns, was disposed to carry its reforming principles far beyond what had been done by Luther and Melancthon. These two parties came into deadly conflict in 1546. On the 28th of February in that year George Wishart, the most eloquent of the Reforming preachers, was condemned to death by an ecclesiastical court—at which Cardinal Beaton, Archbishop of St Andrews, presided—and was burned. On the 28th of May following the cardinal was murdered by Norman Leslie and other adherents of the Reforming party. The struggle continued during the regency of the Earl of Arran and that of Mary of Lorraine, the mother of Mary, the young queen of Scots.

In the year 1559 the Reformers became strong enough to set the regent at defiance. Various circumstances encouraged them to demand freedom for their opinions, particularly the death of Mary of England and the accession of Elizabeth. They were further animated at this time by the return from Geneva of their chief preacher, John Knox. The conflict was to be decided by other than spiritual weapons. The regent and the Reformed party, now known by the name of the Congregation, met in open warfare. The contest was carried on for a twelvemonth, and ended in the triumph of the Congregation. A parliament met at Edinburgh on the 1st of August 1560. The Reforming party had the complete ascendancy, and succeeded in passing several acts by which the jurisdiction of the pope was abolished, the mass was proscribed, and a Confession of Faith drawn up by Knox and his associates was ratified, the spiritual lords making a faint resistance.

The new Confession of Faith adhered in all essential articles of belief to the ancient creeds of the church. In regard to the sacraments it differed entirely from the recent teaching of the Western Church; but its language, on the whole, was moderate and conciliatory. In reference to ceremonies and the details of church polity it declared that such things were temporary in their nature, and not appointed for all times and places, and that they ought to be altered when they fostered superstition and ceased to be conducive to edification.

A Book of Discipline was soon afterwards drawn up by the compilers of the Confession, which was generally approved of, but did not receive the sanction of parliament. It followed out in detail the principles laid down in the Confession. In regard to the office-bearers of the church various orders were mentioned, but three were specially of importance—ministers, elders, and deacons. Ministers were to be chosen by each several congregation, but were to be examined and admitted in public by the ministers and elders of the church. No other ceremony, such as imposition of hands, was to be used. The elders and deacons were to be chosen yearly in each congregation, and were not to receive any stipend, because their office was only to be from year to year and because they were not to be debarred from attending to their own private occupations. In order to the better provision for the wants of the time certain persons called superintendents were appointed in particular districts, with power to plant and erect churches

and to appoint ministers within the bounds of their jurisdiction.

The chief governing as well as legislative and judicial power in the Reformed Church was entrusted to a General Assembly, which met half-yearly or yearly, and was composed of the superintendents, ministers, and lay commissioners, and which gradually, by the introduction of the system of representation, assumed the form and more than the power of a parliament.

The worship of the Reformed Church was modelled on that established by Calvin at Geneva. It was embodied in a formulary called the Book of Common Order, which for nearly a century continued to be generally used. It contained forms for the ordinary worship both on Sundays and weekdays, and for the administration of the sacraments, and for certain other occasions. The minister was not absolutely restricted to these forms. Except in the singing of Psalms, the people took no direct part in ordinary worship, and there was no distinction of ecclesiastical seasons, all holydays whatever except Sunday being abolished.

The form of church government established at the Reformation did not remain long undisturbed. Some of the most zealous Protestants thought the danger to which the church was exposed from state tyranny and aristocratical oppression could best be met by restoring the bishops to their ancient position both in the church and in the parliament; while others of equal zeal and sincerity saw in this only the commencement of a plan for bringing back all the errors of popery. A scheme of this kind was actually established for some time, and the sees were filled with Protestant bishops set apart for the office by their brethren of the ministry. It was almost immediately attacked by some of the ministers, who soon found a leader in Andrew Melville, a scholar of considerable eminence, who returned to Scotland in 1574, after a residence in Geneva, during which he had ardently embraced the new opinions as to ecclesiastical government maintained by Beza.

The struggle continued for some years, the bishops being encouraged by the sovereign and his advisers, whose support was frequently of little real advantage to them, and Melville receiving the zealous assistance of many of the ministers, and of the great body of the common people, who sympathised with him in his democratic theories of civil and ecclesiastical government. Melville was at last entirely successful. His opinions were embodied in what was called the Second Book of Discipline, which received the formal sanction of the General Assembly in 1581. This formulary differed very much from the First Book. It laid down authoritatively those principles in regard to ecclesiastical authority which the English Puritans were vainly striving to establish in the southern kingdom, and was in reality an attempt to make the civil power subordinate to the ecclesiastical, even in matters secular. It recognised four orders of office-bearers in the church, the Pastor, Minister, or Bishop, the Doctor, the Presbyter or Elder, and the Deacon. These were to be set apart by ordination and the imposition of the hands of the eldership, but no one was to be intruded into any office contrary to the will of the congregation or without the voice of the eldership. Four sorts of church courts, each rising above the other, were sanctioned; first, of particular congregations one or more; second, of a province or what was afterwards called the Provincial Synod; third, of a whole nation; and fourth, of the universal church. What is generally regarded as the most essential feature of the Presbyterian system—the Presbytery—was not yet introduced in its proper form, the lowest court being a combination of what were

afterwards known as the Presbytery and the Kirk-session. It was, however, introduced before the year 1592, when the privileges of general and provincial assemblies, presbyteries, and parochial sessions were ratified by parliament, though the Book of Discipline itself did not receive any formal sanction.

King James had agreed to the establishment of Presbyterianism, but personally and as a sovereign he disliked its discipline, and he soon endeavoured to overthrow it. His accession to the crown of England enabled him to do this with more authority. He gradually obtained from the General Assembly a recognition of the civil rights of the bishops, and this led to the restoration of their ecclesiastical privileges. His changes were sanctioned by a General Assembly which met at Glasgow in 1610, and in the course of the same year Episcopacy was restored in reality, as well as in name, by the consecration of three Scottish prelates by four of the English bishops at London.

The king wished to assimilate the Scottish Church as far as possible to that of England, and his next important movement was the establishment of what are called the Five Articles of Perth (see PERTH).

These various changes excited great dissatisfaction in Scotland, particularly in the southern counties, but it gradually abated to a considerable extent, and might have altogether ceased had not further innovations been attempted. It was the wish of James to introduce a prayer-book like that of the English Church in place of the Book of Common Order, but he saw the danger with which the proposal was attended, and gave it up or postponed it. His son Charles was as inferior to his father in prudence as he excelled him in conscientiousness and religious zeal. During his first visit to Scotland he added another bishopric—that of Edinburgh—to the dioceses of the Scottish Church. Most unwisely and most improperly he endeavoured by his royal authority to introduce into that church a Book of Canons and a Liturgy framed on the model of those of England. The king had many loyal supporters in all parts of Scotland, and in the north Episcopacy was preferred by the people to Presbyterianism. But the storm of popular indignation which was now roused swept everything before it. The king's opponents banded themselves together by the National Covenant, and at a General Assembly held at Glasgow abolished the Perth Articles and Episcopacy and re-established Presbyterianism. Charles attempted to maintain his claim by the sword, but was unsuccessful, and obliged to ratify in parliament all that had been done by his opponents.

Had the Covenanters been satisfied with the victory which they had won Presbyterianism might have remained the established religion of the Scottish kingdom. But they could not resist the entreaties for aid from the English Puritans, or rather they yielded to the delusion of extending their own discipline over the churches of England and Ireland. They just attempted, in an opposite direction, what James and Charles had failed to accomplish. For a time their policy seemed to triumph. The Solemn League and Covenant of the three kingdoms, after having been approved by the General Assembly in Scotland, was signed by the Assembly of Divines which the parliament had summoned to meet at Westminster and by the parliament itself. The ecclesiastical documents which were afterwards drawn up originated with the Assembly of Divines, but were sanctioned by the Assembly in Scotland. The principal of these were a Directory for Public Worship, a Confession of Faith, and a Larger and Shorter Catechism. The first of these documents was intended to

supersede the Book of Common Prayer in England, and indirectly the Book of Common Order in Scotland. It laid down certain general rules in regard to public worship and the administration of the sacraments, but left very much to the discretion of the particular ministers and congregations.

The union between the Scottish and English Puritans was dissolved by the ascendancy of the Independents. Scotland, distracted by civil and ecclesiastical dissension, was unable to defend itself against Cromwell. It was conquered and kept thoroughly under subjection by the English army, which forbade the meetings of the General Assembly, but left the other courts and the rest of the church system as they were before. At the Restoration the higher classes generally, who had suffered under the ecclesiastical tyranny of the ministers, were zealous for the re-establishment of Episcopacy. The greater part of the nation, except in the south-western provinces, was indifferent, and the king experienced no difficulty in restoring the bishops to their former rights both in church and state. But Episcopacy alone was restored; there was no attempt to introduce a liturgy, or even to enforce the observance of the Perth Articles. The new primate, Archbishop Sharp, was an able man of good moral character, but ambitious and overbearing, and the Covenanters never forgave his change from Presbyterianism, though he had always belonged to the more moderate of the two parties into which the church was divided. He was almost the only one of the bishops who enjoyed political influence; and, unfortunately for himself and the hierarchy, that influence was generally used to encourage, not to restrain, the severe measures of the government. When the primate was assassinated that severity became a cruel tyranny, and many who had no predilection for any particular ecclesiastical opinions were ready to welcome the change which took place at the Revolution.

When the Scottish Estates met in 1689 to consider what course was to be adopted in the northern kingdom the bishops declined to abandon King James. Whatever might have been the consequences had they taken an opposite course, this resolution was fatal to the Episcopal establishment. William and Mary were called to the throne, and Prelacy was declared to be an insupportable grievance and was abolished. In the following year Presbyterianism was re-established, and the Westminster Confession of Faith was ratified as the national standard of belief, and the right of patrons to nominate to ecclesiastical benefices was taken away. In the end of the same year a General Assembly was held, the first which had been allowed to meet since its dissolution by the order of Cromwell. It was composed as before of ministers and elders from the various presbyteries and of elders from the burghs and universities, and was presided over by a lay commissioner named by the crown and a minister elected by the members as moderator. With the exception of some years in the reign of William, the Assembly has continued to meet annually since the Revolution and to transact business during the periods when it was not in session by a commission named by itself for the purpose. The other chief ecclesiastical events of William's reign were a series of vain attempts on the part of the sovereign to bring about a comprehension of the Episcopal clergy with those of the Establishment and the passing by the Assembly in 1697 of what was called the 'Barrier Act,' which guarded against sudden legislation by providing that no permanent act should be passed until it had received the approbation of the majority of the presbyteries.

During the reign of Queen Anne and in the year

1707 England and Scotland were united into one kingdom. A special statute was passed for the security of the Protestant religion and Presbyterian church government in the latter country; providing that these should continue without any alteration in time to come, and confirming the act of William and Mary which ratified the Confession of Faith and settled the Presbyterian form of church government.

In the year 1712 an act was passed by the British parliament which restored to patrons in Scotland their right of presentation to benefices. This statute excited great discontent among the members of the Established Church, and for many years attempts were made to obtain a repeal of it. These attempts were unsuccessful, but its provisions were long practically disregarded. When at length the General Assembly began to act upon it the dissatisfaction increased among those who held the divine right of the people to choose their own ministers. The leader of the discontented party was a minister named Ebenezer Erskine, and he with his adherents in the year 1733 finally separated from the Establishment and formed a communion which took the title of the Associate Presbytery, though its members were popularly known as the Seceders. The Seceders themselves were soon divided by a dispute as to whether it was consistent with principle to take the Burgher's oath of allegiance into two bodies, called the Burgher and Anti-burgher Synods. In the year 1761 another secession from the Establishment took place in connection with the law of patronage; and the separated body assumed the name of the Presbytery of Relief.

There were no further secessions for nearly a century; but the church was divided into two parties, known as the Moderates and Evangelicals, the former of whom were favourable, the latter hostile, to the law of patronage. For many years the Moderates, headed by Dr Robertson the historian and others of his school, and supported by the influence of the government, maintained an ascendancy in the General Assembly and throughout the country. In the later years of George III. and during the reign of George IV. this ascendancy began to decrease. The political excitement which prevailed in the beginning of the reign of William IV. strongly affected the Scottish Establishment, which from its very constitution is peculiarly liable to be moved by the impulses of popular feeling. The two parties in the General Assembly engaged in a struggle more fierce than any in which they had yet met; and the subject of dispute as before was immediately connected with the law of patronage. Dr Chalmers, the most distinguished minister in Scotland, added the whole weight of his influence to the popular party, and in 1834 an interim act of Assembly was passed, known as the Veto Act, which declared it to be a fundamental law of the church that no pastor should be intruded on any congregation contrary to the will of the people, and laid down certain rules for carrying out this principle. The legality of this act was doubted; and in connection with a presentation to the parish of Auchterarder the presentee, on being rejected by the presbytery in terms of the Veto Act, appealed, with concurrence of the patron, to the Court of Session—the supreme civil court in Scotland. That court decided that the conduct of the presbytery in rejecting the presentee was illegal, and their judgment was affirmed by the House of Lords. Other cases of a similar nature followed, and something like a conflict took place between the civil and ecclesiastical courts, the former enforcing their sentences by civil penalties, the latter suspending and deposing the ministers who obeyed the injunctions of the Court of Session. In the

General Assembly of 1843 the dispute came to a crisis. A large number of ministers and elders of the popular party left the Assembly and met apart in a similar body, of which Dr Chalmers was chosen moderator. They formed themselves into a separate communion under the title of 'The Free Church of Scotland,' and gave up their benefices in the Established Church and all connection whatever with that body. The Free Church carried off about one-half of the members of the Establishment and became a rival communion in most of the parishes. By an act of parliament in 1874 patronage was abolished in the Established Church and the right of choosing the minister transferred to the congregation.

In 1820 the Burgher and Anti-burgher Seceders were united under the name of the Associate Synod of the Secession Church; and in 1847 this Associate Synod and the Relief Synod were united under the name of 'The United Presbyterian Church.' Negotiations for a union of the United Presbyterian Church and the Free Church have led to no practical result; but the desirableness of a union between the three Presbyterian churches is constantly discussed, though the agitation for the disestablishment of the Church of Scotland has embittered the relations between the mother-church and her daughters.

Episcopal Church in Scotland.—It is a common but erroneous opinion that almost all the Episcopal clergy were Jacobites from the time of the accession of William and Mary. The bishops were so (see NONJURORS); but a large number, probably a considerable majority of the clergy, had at first no objection to take the oath of allegiance to the new government. During the reign of Queen Anne the Episcopal clergy were well disposed to the government, knowing the queen's good wishes to their communion. They were frequently harassed by the courts of the Establishment; but all who were willing to take the oaths obtained an ample protection for their worship on the passing of the Toleration Act of 1712. On the death of the queen almost all the clergy and most of the laity were involved directly or indirectly in the attempts to overthrow the Hanoverian dynasty, and it was this which finally made the names of Episcopalian and Jacobite for many years to be convertible terms.

In the meantime the succession of bishops had been kept up by new consecrations, and after some years the dioceses, though diminished in number, were regularly filled. An important change took place in the forms of worship. No longer trammelled by their connection with the state, they adopted liturgical forms similar to those in the English Prayer-book, and in almost all cases identical, except that many of the congregations used an Office for the communion modelled on that of the Scottish Liturgy of King Charles I. The Episcopalians took no such open part in the insurrection of 1745 as they did in that of 1715, but their sympathies were known to be with the House of Stewart; and the government carried through parliament some intolerant acts, which were put in execution with great harshness, and which for many years suppressed all public worship in the Episcopal communion. It was only after the accession of George III. that these statutes ceased to be actively enforced; and it was not till 1792 that the Episcopalians, who from the death of Prince Charles had acknowledged the reigning dynasty, were relieved from the penal laws. The act which gave this relief imposed restrictions on their clergy officiating in England and prohibited their holding benefices in the English Church. In 1804 the bishops and clergy agreed to adopt the Thirty-nine Articles of the Church of England, and

in 1863 the Prayer-book was adopted as the authorised service-book of the Episcopal Church, permission being given in certain cases to use the Scottish Communion Office. The restrictions imposed on the Scottish clergy by the Act of 1792 were modified by an act passed in 1840; and in 1864 they were entirely removed, the right being reserved to bishops in England and Ireland to refuse institution to a Scottish clergyman without assigning any reason, on his first presentation to a benefice in England or Ireland, but not after he should have once held such benefice.

The dioceses of the Scottish Episcopal Church are seven in number—viz. Moray, Aberdeen, Brechin, Argyll, St Andrews, Edinburgh, and Glasgow. The bishops are chosen by the clergy of the diocese and by representatives of the lay communicants, a majority of both orders being necessary to a valid election. One of the bishops, under the name of Primus, chosen by the other bishops, presides at all meetings of the bishops, and has certain other privileges, but possesses no metropolitan authority. The highest judicial body is the Episcopal College, composed of all the bishops. The highest legislative body is a General Synod, composed of two houses, the one of the bishops, the other of the deans and the representatives of the clergy. There is also a Church Council, composed of the bishops, clergy, and representatives of the laity, which meets yearly, and is recognised as the organ of the church in matters of finance.

Roman Catholic Church.—The ecclesiastical revolution of 1560 by no means extinguished the Roman Catholic Church. An act of parliament was indeed passed making the saying or hearing of mass a crime punishable by confiscation of goods and imprisonment for the first offence, banishment for the second, and death for the third. Under its provisions Archbishop Hamilton and some few other priests were thrown into prison in 1563. The bishops for the most part were cowed and helpless, and a number of priests fled the country. Nevertheless, many noblemen and a large part of the population, especially in the north, remained faithful at heart to the old religion, and were till the end of the century a formidable political power upon which the partisans of Queen Mary in England, the Guises, and the king of Spain could rely in their projects against the throne of Elizabeth. Missionaries, chiefly Jesuits, came into the country to keep alive as best they could the decaying faith. The sufferings of both priests and people were extreme, yet notwithstanding the bitter hostility displayed by the kirk with whom the coercive power lay, it is notable that only one priest, John Ogilvy the Jesuit, suffered the penalty of death (1615), and this not on the ground of his priestly office, but for language which was, not unnaturally, judged to be treasonable.

The Scottish Roman Catholics suffered also for a long time from the want of any regular ecclesiastical organisation. In 1598 the secular clergy were placed under the jurisdiction of the newly-appointed archpriest of England, George Blackwell, and in like manner continued to be subject to Dr William Bishop, the first vicar-apostolic of England and Scotland, in 1623. It was not until nearly a century after the Reformation (1653) that they were granted a 'prefect' of the mission in the person of William Ballantyne. Meanwhile measures were taken to keep up the supply of missionary priests by the foundation of seminaries abroad. Clement VIII. founded the Scots college at Rome in 1600. In 1612 a seminary originally set up at Tournai, after many wanderings, was finally established at Douai. A college was opened at Madrid in 1633, and subsequently transferred to Valladolid. Another seminary was

established at a later period in connection with the Scottish monastery at Ratisbon. During the whole of the 17th and 18th centuries, or until the episcopate of the illustrious convert from Protestantism, Dr William Hay (1769-1811), the fortunes of the Scottish Catholics were at a very low ebb. Bishop Hay founded in 1799 a seminary at Aquhorthies near Inverurie, and provided Catholics with a new literature.

A report made to Rome in 1679 estimated the total number of Catholic *communicants* at 14,000. Of these 12,000 belonged to the Highlands, where, however, there were only 3 or 4 priests. In 1705 there were said to be 160 Catholics in Edinburgh, 5 in Leith, and 12 in Glasgow. Certain districts of the Highlands and Islands named as exclusively Catholic are South Uist and Barra, Canna, Rum and Muck, Knoydart and Morar, Arisaig, Moydart and Glengarry, in which places there were about 4500 Catholics. The district of Braemar contained 500. There were at this time 36 priests on the mission in all Scotland. The number of Catholics in the country about the year 1779 has been estimated at from 20,000 to 30,000, while it is said that not more than twenty of these possessed land worth a hundred a year. A very great increase, chiefly owing to the influx of Irishmen, took place at the beginning of the 19th century. In 1800 Edinburgh and Leith contained 1000 Catholics; in 1829, 14,000. In the latter year there were 25,000 in Glasgow, 1500 in Perth, 1400 at Preshome, 1500 in Glengarry, 1000 in Dumfries, and 3000 in Aberdeen—the whole Catholic population being reckoned about this time at 70,000, including the bishops and 50 priests. In 1890 there were in Scotland 338,643 Catholics (220,000 in Glasgow alone), 332 chapels, and 350 priests.

The first bishop appointed as vicar-apostolic for Scotland was Thomas Nicolson (1695). The vicariate was divided into a Lowland District and Highland District in 1731, and into three districts in 1828. The Hierarchy, consisting of two archbishops, St Andrews and Edinburgh, and Glasgow, and four bishops suffragans of the former, was established by Leo XIII., March 4, 1878. St Mary's College at Blairs, 6 miles south-west of Aberdeen (whither the seminary was removed from Aquhorthies in 1829), has a president and four professors.

The chief original authorities for the ecclesiastical history of Scotland down to the Revolution are the same as those mentioned in the article on the Civil History, to which may be added Theiner's *Vetere Monumenta Hibernorum et Scotorum* and Joseph Robertson's *Concilia Scotie* (2 vols., Bannatyne Club, 1866). The chief modern authorities are Cook's *History of the Reformation and History of the Church of Scotland*; Principal Lee's *Lectures* (1860); Principal Cunningham's *Church History of Scotland* (2d ed. 1883); the present writer's *Ecclesiastical History of Scotland* (4 vols. 1861); Scott's *Facts Ecclesie Scoticanæ*; *The Church of Scotland, Past and Present*, edited by Professor Story (5 vols. 1891). See also Dean Stanley's *Lectures on the History of the Church of Scotland* (2d ed. 1879), with Principal Rainy's Reply (1872); the *St Giles' Lectures* (1881); Bishop Wordsworth's *Discourse* (1881); for the Free Church point of view, M'Crie's *Sketches* (1841), Hetherington's *History* (1841), and Buchanan's *Ten Years' Conflict* (1849); for the Episcopal side, Russell's *Church of Scotland* (1838) and Miss Kinloch's *History* (1888). See W. Forbes-Leith, S.J., *Narratives of Scottish Catholics under Mary Stuart and James VI.* (1885); *The Catholic Church in Scotland*, edited by the Rev. J. F. S. Gordon (Glasgow, 1869); and Dr Bellesheim, *History of the Catholic Church in Scotland*, trans. by F. Hunter-Blair, vols. iii. and iv. (1889-90); and see in this work the articles on CONFESSIONS OF FAITH, COVENANT, PRESBYTERIANISM, ASSEMBLY, ELDER, FREE CHURCH, UNITED PRESBYTERIANS, CAMERONIANS, and those on the great church leaders, Knox, Melville, Henderson, Chalmers, Macleod, Tulloch, &c.

SCOTTISH LANGUAGE.—This name is now applied to the Teutonic speech of Lowland Scotland, especially in its literary form, as the official language of the kingdom in the 15th and 16th centuries, and the vehicle of ballad and lyric poetry down to the present day. As originally used, it meant the Celtic language of the Scoti or Scots of Ireland, and to a comparatively late date it continued to be applied to the same language as spoken by the Celtic people of the Highlands and Western Isles, the 'Saxon' tongue of the Lowlander being then usually distinguished as 'Inglis' or English. All the earlier Scottish writers, Barbour, Wyntoun, Harry the Minstrel, Dunbar, and even Sir David Lyndsay recognised their language as 'Inglis'; Fordun, about 1400, still applied the name *Scottish* to the Celtic, saying of his countrymen: 'For they use two languages, the Scottish and the Teutonic (*Scotica et Teutonica*); the people speaking the latter occupies the seacoast and lowland districts, the people of Scottish language (*lingua gens Scotica*) inhabit the highlands and isles beyond.' But as the nationality of Scotland, as distinct from England, became more definitely recognised, there were obvious inconveniences in applying the name *Scottish* to the speech of what had become the least important section of the nation, and the Celtic tongue began to be usually spoken of by Lowlanders as *Yrische* or *Ersche*; it was natural also that in the struggle with 'oure alde enemeis of Ingland,' the name *Inglis* should become distasteful to patriotic Scots; and, accordingly, in the 16th century, the name 'Scottis,' after having been disused for more than a century, was recalled, and applied to the Lowland tongue as being the official language of Scotland and of the vast majority of Scotsmen. Thus Gavin Douglas in the preface to his translation of *Virgil*, and the author of the *Complaynt of Scotland*, claimed to write in the 'Scottis toung'; and from 1550 onwards this has always meant the Teutonic or Saxon speech of Lowland Scotland, the original *lingua Scotica* of the Highlanders being distinguished as Erse or Scottish Gaelic. The latter is a form, or group of forms, of the common Celtic tongue which is spoken, with many dialectal gradations, from Cape Wrath in Scotland to Cape Clear in Ireland, the Gaelic of Argyll and Islay not differing from the Irish Gaelic of Ulster on the one hand, more than it does from the Scottish Gaelic of Inverness and Skye on the other. The Erse has been a literary language in Ireland from a remote period; its literary career in Scotland is much shorter, beginning with Carswell's Gaelic version of John Knox's Liturgy, printed in 1567, and of little moment before the 19th century. The Gaelic is still extensively spoken in Scotland west and north of a line which runs up the Firth of Clyde and Loch Long, and crosses by Glen Douglas, Rowardennan, Aberfoyle, Callander, Comrie, Dunkeld, Glen Shee, Mount Blair, till it reaches the Dee 6 miles above Balmoral; leaving the Dee 3 miles above Ballater, it continues by the southern watershed of Glen Livet to the Spey and Knock of Moray, Coulmony on the Findhorn, and reaches the Moray Firth about 3 miles west of Nairn. East of this line, as also in the north-east half of Caithness and in the Orkney and Shetland Isles, Gaelic is no longer native; but even to the west of the line a large proportion of the population is bilingual. There has never been any newspaper or journal published in Gaelic, so that the literary standing of the language is very different from that of Welsh.

The Lowland Scotch is a form of the Teutonic or Germanic speech introduced into Britain by the Angles and Saxons in the 5th century. These tribes spoke different dialects, which may be broadly distinguished as *Saxon*, including West

Saxon and Kentish, and *Anglian*, including Mercian and Northumbrian. In the Middle English period these developed into the Southern, Midland, and Northern English dialects respectively. Lowland Scotch forms part of the Northumbrian or Northern English division; modern standard English is a blending of Midland and Southern. Before the Norman Conquest, and for some centuries later, the old Northumbrian was spoken probably with little or no variation from the Humber to the Firth of Forth. But after the division of the Northumbrian territory between England and Scotland, and especially after the final establishment of the independence of Scotland in the beginning of the 14th century, this common speech began to be exposed to diverse influences north and south of the Border. South of the Tweed and Cheviots the Northumbrian sank from the rank of a literary language used by poets, preachers, and chroniclers, to that of a local dialect, or group of patois, overshadowed by the king's English of London, and more and more depressed under its influence. After 1400, or at least after the 15th century, it disappears from the view of the student. But north of the Tweed and Solway the Northumbrian remained the language of a court and a nation; it spread westward and northward over districts formerly occupied by British and Gaelic (or it may be Pictish) populations, from which it sustained modifications phonetic and structural; it received literary culture, and especially contracted alliances with French and Latin on its own account; so as to acquire by the close of the 15th century distinctive and strongly-marked features of its own not found in the cognate dialects in the north of England. From the close of the 14th to the beginning of the 17th century it was the vehicle of an extensive and in many respects brilliant literature, it was the medium of legislation and justice, and fulfilled every function of a national language. But a serious shock to its independent development was given by the Reformation, in consequence of the close relations between the leaders of that movement and the English Protestants, and the use of English books, especially of the English version of the Geneva Bible, printed at Edinburgh in 1576-79. Then followed the accession of James VI. to the crown of England, the transference of the seat of government to London, and the consequent disuse of the 'Scottish tongue' by the court and by the nobility, who found it desirable to speak the king's English, and gradually grew ashamed of their Scotch. After this, few works were written in the native tongue, except such as were intended for merely local use. It became obsolete in public legal use at the time of the Commonwealth, and though retained a little longer in the local records of remote burghs and kirk-sessions, it disappeared from these also by 1707. But though it thus became obsolete in official and literary use, so that Scotchmen thenceforth wrote in English tinged more or less with Scotticisms, or words, phrases, and idioms derived from their native speech, it still continued, in several dialectal varieties, to be the vernacular of the people, and after a period of neglect it bloomed forth anew as the vehicle of ballad and lyric poetry, in Lady Wardlaw, Allan Ramsay, Burns, and their numerous fellow-singers. Sir Walter Scott also led the way in its use in prose fiction as the characteristic speech of local characters, a purpose for which it has continued to be effectively used down to the present day by many popular writers. These uses are, however, only *dialectal*; they must be classed with the similar use of Lancashire, Cumberland, Dorset, or Devonshire dialect, by English poets and novelists as the appropriate language of

local muse, and of local *dramatis personæ*; with this difference that Scottish, having been a literary language, has preserved a certain literary status which is wanting to these English dialects. But even this difference tends to disappear; recent writers of Scottish tales have sought to heighten the local truthfulness of their delineations, by giving as close a transcript as possible of the local speech, regardless of the traditional conventionalisms of the 'literary' Scotch.

The Teutonic tongue was probably introduced into the country south of the Forth as early as into any part of England. But few actual specimens of the language in these early times have come down to us; the chief is the Runic inscription still extant on the Ruthwell Cross in Dumfriesshire in the old Northumbrian of about 660; then there are the local names, which, in so far as they are those of the dwellings of men, or of the less conspicuous natural features, are in eastern Lothian, Teviotdale, and lower Tweeddale, as truly Teutonic as in Kent or Essex. Isolated vernacular words and phrases in early Latin charters, and in the Latin texts of the early laws, some of which go back to the reign of David I., testify to the currency of the language in the 11th and 12th centuries. But connected specimens are all of later date, and the earliest of these are, moreover, known only in transcripts much later than their own date. Thus the eight lines of verse beginning:

Quhen Alysander oure kyng wes dede
That Scotland led in luve and le,

though referring to events which followed the year 1289, are preserved for us only by Wyntoun who wrote after 1400. Rude snatches of song relating to the siege of Berwick in 1296 are preserved by Fabyan who wrote about 1500. Even Barbour's *Brus*, written about 1375, is, with the exception of the passages incorporated by Wyntoun, preserved only in MSS. more than a century younger. A charter of 1385 in the 'Red Book of Glen Tully,' and fragments of Scottish acts of 1389 and 1398 are among the earliest contemporary documents. But after 1400 the remains become plentiful.

The Scottish language as thus known to us has been divided into three periods: *Early Scottish*, during which the language did not differ appreciably from the Northern Middle English, extending from the earliest remains down to about 1475; *Middle Scottish*, the national period of the language, from that date to about 1650; *Modern Scotch*, the dialectal period, from 1650 onwards. The distinctive characters of these periods are fully set forth in the Historical Introduction to a treatise on the *Dialect of the Southern Counties of Scotland* (1873), by the present writer. It will be observed that the first is coterminous with the Middle English Period of the English language, as recognised by modern scholars, and that the second is co-extensive with the Early Modern or Tudor and Early Stuart Period of modern English. Barbour and Wyntoun represent the Early Period; Dunbar, Gavin Douglas, Lyndesay, Montgomery, and the fine prose of Bellenden and the *Complaynt of Scotland*, Archbishop Hamilton's Catechism, and the writings of Ninian Winzet, Father Dalrymple, and other Roman Catholics belong to the Middle Period; the poets and novelists of the 18th and 19th centuries, the Modern Period.

The living tongue now exists in numerous dialects and sub-dialects, easily distinguished from each other by differences of pronunciation and vocabulary. The researches of Dr Murray, followed by those of Dr Alexander J. Ellis, have established three main dialects, classed as Southern or Border Scotch (Teviotdale, Dumfriesshire, and Selkirkshire); Central Scotch (Lothian and Fife, Ayrshire and Clydesdale, Galloway, south-east

Perthshire); North-eastern Scotch (Angus, Aberdeen and Moray, Caithness). In the Orkney and Shetland Isles dialects of the Norse survived till a century ago, many traces of which still characterise this fourth or *Insular Scotch* group (see the article DIALECT, by Dr A. J. Ellis).

It was long a favourite notion that the Scottish speech contains a much larger Norse element than English; some writers even went to the length of claiming that it was of Scandinavian rather than of Anglo-Saxon origin. This is an entire mistake. There is no record of any Norwegian or Danish conquests and settlements in the east of Scotland, as in the east of England. In England the northern limit of Danish influence is about Durham; the county of Northumberland and the whole Scottish Lowlands, except a small district near the Solway, are entirely void of Danish characteristics. The differences relied upon as evidences of Scandinavian influence in Scotland, are really the differences between a pure Anglian dialect such as that of Scotland, and the largely Saxon dialect which lies at the basis of literary English. Scandinavian words and forms prevail extensively in certain English dialects, as in Yorkshire and Lincolnshire, but fewer of them have passed into Scotch than into literary English.

The greatest work dealing with the Scottish language is Dr Jamieson's *Dictionary published 1804*; with supplement, 1825; new ed. 1879-87). The author aimed to include both the literary words of the earlier periods and the modern words from all the dialects. For the former he was necessarily hampered by the deficiency of available printed material. For the latter he was dependent on the co-operation of friends in different districts. It is to be wondered that in these circumstances he produced so estimable a work. Its most serious defect was due to his utter ignorance of the subject historically, and his erroneous fancy that Scotch was more intimately related to the tongues of Scandinavia, even to Sui-Gothic, as he called old Swedish, than to northern English. This coloured his whole work, even his definitions. The *New English Dictionary* (vol. i. 1888) of the Philological Society includes all literary Scottish words, either in separate articles or as variants of corresponding English ones. It would still be desirable to make a systematic collection of all living Scottish words, of all the dialects. The *English Dialect Dictionary* (vol. i. 1895-98), edited by Prof. Jos. Wright, partly covers the ground. See also Gregor's *Glossary of Banffshire* (1866) and Edmonston's *Shetland Glossary* (1866), both published by the Philological Society.

SCOTTISH LITERATURE.—A special difficulty presents itself in connection with the literary history of Scotland. Are we to regard as Scottish literature only what is written in the Scottish vernacular in its various developments from Barbour to Burns? Thus regarded, Scottish literature would manifestly be the inadequate expression of the Scottish character and genius. On the other hand, the literature produced by Scotsmen in standard English is for many reasons best treated under the general head of English literature. Nevertheless, a national literature being the expression of the national consciousness only when considered as an organic whole, the survey here attempted will take account of the total contribution made by Scotsmen to the literature of the world.

The literature of Scotland definitely begins with John Barbour (died 1395). A few scraps of verse of questionable authenticity and doubtful authorship hardly justify us in saying that he had any predecessor. Barbour's *Brus* marks an epoch at once in the literature and the political history of the country. As has been said of him, he is the first poet and, at the same time, the first historian of Scotland. In his sober and yet imaginative presentment of his theme—the deeds of the national hero and the establishment of the national independence—Barbour struck that note in Scottish

literature so conspicuously manifest in the intense national feeling of Burns and Scott. As the exponent of the same tradition with all the exaggerations of popular feeling, Blind Harry, though he came a century later, may be naturally grouped with Barbour. Of little value as poetry, and grotesque in its perversion of the story he professed to tell, Blind Harry's *Wallace* has its distinct place in the national life of Scotland. 'Next to the Bible,' says its latest editor, 'it was probably the book most frequently found in Scottish households.'

Chaucer may with even greater truth be called the father of Scottish than of English poetry. In England he had predecessors who cannot be altogether disregarded: in Scotland, with the exception of Barbour, who was not great enough to be a source of inspiration, he had none. Moreover, the Scottish poets who looked to him as their master made a far more distinguished succession than his imitators in England. Inspired by the form and the themes of Chaucer, his followers in Scotland in individual effects often surpassed their model, and even suggest the question whether they would not have done better to trust more to their own natural impulse. To the close of the 16th century, however, it was on Chaucer that the poets of Scotland had ever their eyes fixed, and it was by their approximation to his models that they measured their success in their art.

The Scottish line of Chaucerians begins with James I. (died 1437). By his own natural affinities, and by the accident of his personal history, James is the most deeply imbued of them all with the spirit of the English poet. While he was thus so distinctly the vehicle of another's inspiration, every reader of the *King's Quair* feels that in its delicacy of feeling, its sense for the music and subtler shades of language, it is the expression of a mind essentially poetic in its deepest construction of nature and human life. It is in itself a fact of curious interest that the Scotland of James II. and James III. should have produced a poet of the type and of the importance of Robert Henryson. That Henryson achieved the work he did is, in truth, conclusive proof that there was a higher consciousness in the nation than the external history of the time would lead us to infer. The work of Henryson is marked by qualities which have not been conspicuous in poets of his country even greater than himself—pervading artistic feeling and justness of thought and sentiment. In his *Fables*, the *Abbey Walk*, *Robene and Makyne* ('the first English pastoral'), and the *Garmond of Fair Ladies* he exhibits such a range of poetic gifts, and of such an order, as must always ensure to him his own niche among the imaginative writers of British literature. Of a very different type and of far greater natural force is Henryson's younger contemporary William Dunbar. A Chaucerian also, Dunbar is generally acknowledged to have surpassed his master in imaginative intensity and in the blended effects of ghastly humour and daring conception. 'In brilliancy of fancy,' says Scott, 'in force of description, in the power of conveying moral precepts with terseness, and marking lessons of life with conciseness and energy, in quickness of satire, and in poignancy of humour, the Northern Maker may boldly aspire to rival the Bard of Woodstock.' Where Dunbar falls short of the highest order of poets is in that largeness of humanity, in that just and genial survey of life which gives its breadth and serenity to the work of Chaucer, and has assured his supreme place in English literature. From the number of Dunbar's poems it is sufficient to specify *The Thrissil and the Rois*, *The Golden Targe*, *The Dance of the Sevin Deidly Synnis* (one of the memorable efforts of poetic genius), *The Justis*

betwix the *Tailzeour* and the *Soclar* as those which best exhibit his power. Of Dunbar it has to be added that he is the first Scottish writer in whom are unmistakably present the distinctive traits of the national genius as it has expressed itself in literature. As the translator of the *Æneid*, Gavin Douglas (1475-1522) must always remain an interesting figure; and it is on his translation that his claims as a poet mainly rest. In the opinion of the very latest critics Douglas has rendered his author with a sympathetic insight and frequent felicity of interpretation which have not been surpassed by any subsequent translator. Without natural inspiration, however, he fails when left to his own resources. His *Palice of Honour* and *King Hart* are purely conventional productions, without individual stamp, in the tedious allegorical fashion of the time. Like his three predecessors, Sir David Lyndsay (1490-1555) regarded Chaucer as his great exemplar in poetry, and in his early poem *The Dreme* he is directly inspired by his model. Yet no two minds could be more essentially unlike than Chaucer and Lyndsay. Chaucer's view of life was essentially that of a poet: for Lyndsay the world around him was a sight which he regarded not through the medium of the poetic imagination, but with the direct feeling of one moved to the heart by the strivings and sufferings of his fellow-men. The period in which he lived, also, was more proper to men of his type than to men of the purely poetic temper. By the time he reached manhood the great religious revolution of the 16th century had broken upon western Europe, and was begetting universal discontent with existing conditions, and specially with the clergy of the ancient church, who were mainly responsible for the state to which society had come. With the majority of the men of letters of his time, therefore, Lyndsay found scope for his talent as the critic and censor of the social order around him. By the vigour and effect with which he accomplished this task in such poems as *The Testament of the Papyngo*, *The Satyre of the Thrie Estatis*, and *The Dialog concerning the Monarchie* he did for Scotland what Erasmus did for Europe, preparing the way for Knox as Erasmus did for Luther. As poet and champion of the people Lyndsay came to hold a place in the hearts of his countrymen from which Burns alone was able to dislodge him.

The very success which the four poets just named achieved in their art is proof of a cultivated opinion which made their development possible. It is but what we should expect, therefore, that these four poets are only the brilliant survivors of a numerous race who were their rivals for poetic distinction. The list of such given by Dunbar in his *Lament for the Makars* leaves us with a lively impression of the intellectual activity of an age which many things might persuade us was one in which the finer play of the human spirit was hardly to be looked for. In this connection reference should also be made to that ballad poetry of which Scotland has produced such splendid specimens in their kind. Though their date and authorship cannot be definitely fixed, it seems unquestionable that many of the best of the ballads belong to the 15th and 16th centuries.

It was in vernacular poetry that the Scottish genius found its highest expression during the period of which we are speaking; but along other lines of expansion there was no lack of well-directed effort. There is conclusive evidence that the intellect of Scotland had already taken that bent which it has kept ever since—that bent for the dialectic treatment of abstract questions which eventually produced Scottish theology and Scottish philosophy. At the close of the 15th century

Erasmus notes as a generally recognised fact the affinity of the Scots for abstract thinking, and about the middle of the 16th the younger Scaliger made a similar remark in somewhat different terms. According to Renan, Michael Scott was the first (1230) to introduce the Aristotelian Commentaries of Averroes into the western schools—an event of the first importance in the intellectual history of Europe. To Duns Scotus (who according to the best authority, John Major, was undoubtedly a Scotsman) belongs the credit of leading the way by his remorseless logic to the emancipation of men's minds from the scholastic philosophy after it had done its work of discipline on the mind of Europe. The foundation of the three universities of St Andrews (1411), Glasgow (1451), and Aberdeen (1494) is another proof of what has been already said, that in spite of chronic strife and confusion there was a section of the community who had steadily at heart the highest interests of the country.

Like other countries of Europe, Scotland had also during this period its succession of chroniclers of varying degrees of merit. The first of these was John of Fordun, who between 1384 and 1387 wrote his Latin chronicle of the Scottish nation (*Scotichronicon*), afterwards unscrupulously interpolated and continued by Walter Bower (died 1449). With these, though he wrote in vernacular verse, may be mentioned Andrew of Wyntoun, who towards the end of the 14th century composed his *Orygynale Cronycle*, or story of the world from its creation. Of much higher merit as being the product of a time when the Revival of Learning had extended knowledge and raised the level of thought are the Latin histories of Hector Boece (died 1536) and John Major (died 1550). The translation of Boece's history into Scots by John Bellenden is the work of a writer who consciously uses language both with knowledge and skill. An interesting anonymous tract in the Scottish dialect, *The Complaynt of Scotland* (1548), is a curious example of that superlative writing which among the humanists of the time was known as Ciceronianism.

During the latter half of the 16th century the mind and heart of Scotland were engrossed in the task of adjusting its social and political system to the religious settlement accepted by the country in 1560. The time was therefore in the highest degree unfavourable to the growth of imaginative literature. Such productions as the *Gude and Godly Ballades*, interesting as the deepest utterance of the time, show the dominant note even of poetic feeling. When every explanation has been suggested, however, it is a strange fact that Scotland, which during the 15th century had so distinctly the advantage of England in the quality of its poetic literature, for this period can only show against the Elizabethan galaxy such names as Sir Richard Maitland, Alexander Montgomery, Alexander Hume, and King James VI. In vernacular prose the most notable production of the period is John Knox's *History of the Reformation in Scotland*, a work of national importance to his own country, and by the imprint it bears of a commanding personality holding a unique place in its literature. The *History of Scotland* by Bishop Lesley (afterwards translated into Latin), the *Memoirs* of Sir James Melville, and the *Tractates* of Ninian Winzet, though of no special literary excellence, are all the works of men alive to the great questions that moved the world of their time. Of all the Scotsmen of this period, however, the greatest literary genius was George Buchanan, who by the grace of his Latin poetry and his equal skill in prose gained a reputation second to no writer in Europe. In Buchanan's vernacular writings also, the *Admoni-*

tioun and *The Chameleon*, we have the most skilfully wrought Scottish prose that has come down to us. As a scholar of singular attainments, though of no distinctive literary genius, Andrew Melville may also be mentioned as one among many examples of Scotsmen who profited to the utmost by the new studies of the Revival of Learning.

For the 17th century Scotland has but one distinguished poet to show—William Drummond of Hawthornden (1585–1649). In other departments of literature there were many able workers, but none of whom it can be said that their work is of very high order in its kind. During this century also Scotland was absorbed in questions that lay at the roots of the national life, and till these questions should be finally settled a collective intellectual movement, such as is necessary to a great literature, was a moral impossibility. The union of the crowns and the removal of the court in 1603 had likewise for the time an injurious effect in weakening the national spirit, which in the 15th century had been so potent an inspiration. Thenceforward the Scottish language gradually gave way before the standard English, and it is a significant fact that Scotland produced nothing of literary importance in its own dialect till the appearance of Allan Ramsay's *Gentle Shepherd* in the following century. As regards its achievement in literature during the 17th century, therefore, Scotland may be very briefly disposed of.

With Drummond of Hawthornden may be named as poets Sir William Alexander (Earl of Stirling) and Sir Robert Ayton, though neither produced work that deserves a place in a British anthology. In Drummond, however, we have a poet the distinction of whose character and genius has made him one of the interesting figures in literary history. Poor as was the beginning of the century in poetry, the latter half is poorer still, since it boasts not one name that deserves even a passing mention. As continuing the tradition in Latin poetry so brilliantly initiated by Buchanan may be noted the *Delitiae Poetarum Scotorum*, a collection of Latin poetry written by Scotsmen. Among its contributors Arthur Johnston merits special mention as the Scotsman of the period who after Drummond gave proof of the finest literary gift. In history the best work was done by David Calderwood and Archbishop Spottiswoode during the first half of the century, and by Sir James Dalrymple and Bishop Burnet in the second half. Against the brilliant list of English divines for this period Scotland can only show as its two best known Samuel Rutherford and Archbishop Leighton—the latter, however, a writer of such fine suggestions that Coleridge could speak of him as a Christianised Plato. As miscellaneous writers holding a place apart Sir Thomas Urquhart, the translator of the first three books of Rabelais, and Robert Barclay (1648–90), author of the *Apology for the Quakers*, close the list of the most distinguished names in Scottish literature during the 17th century.

Far different is the literary record of Scotland for the 18th century. Due proportion guarded, it may be safely said that during this period she was surpassed by no country in Europe in brilliant initiative and in solid contribution in every field of intellectual activity. The mere enumeration of the more important names in each department shows that this statement is no exaggeration.

Of the crowd of poets who wrote in the vernacular two stand out pre-eminently as the representatives of their fellows. In the first half of the century Allan Ramsay in his *Gentle Shepherd* produced a work which, in virtue of its intrinsic quality, and as the only example in its kind, is in its own degree a British classic. Robert Burns, born

the year after Ramsay's death, is the greatest natural force in the imaginative literature of the 18th century, and it is the supreme tribute to his genius that his poems have made classic the dialect in which he wrote. Two poets who wrote in English also call for special notice in virtue of the fresh impulse of thought and feeling which they communicated to the poetry not only of Britain but of Europe. In his *Seasons* James Thomson (1700–48) gave expression to certain aspects of man's relation to nature which freshened the sources of English poetry and on the Continent influenced notably, among others, Jean-Jacques Rousseau. As perhaps the first to strike the dominant note of Romanticism James Macpherson (1738–96), the 'translator' of the pseudo-Ossianic poems, is rightly regarded as one of the literary forces of his century. In history David Hume (1711–76) and William Robertson (1721–93), both writing before Gibbon, gave a new character and aim to the treatment of the past, and by their insight, philosophic breadth, and literary skill made an era in the science of human affairs. As has been already said, it is the ruling instinct of the Scottish mind to busy itself with the mysteries that lie at the heart of things, and in the 18th century we have signal illustration of the fact. In the line of philosophic thinkers it is sufficient to name Hume, Reid, and Adam Smith to indicate the far-reaching importance of Scottish thought and speculation during the period we are considering. From Hume's disintegrating scepticism dates an epoch in metaphysical science, the extraordinary development of modern German thought resulting by natural recoil from his main position. As the founder of what is distinctively known as the Scottish philosophy Thomas Reid had in France an even more direct and potent influence than Hume in Germany. Of Adam Smith's *Wealth of Nations* it is enough to say that by the consenting opinion of Europe it is one of the epoch-making books in man's history. As masters in their own department, Smollett and James Boswell likewise deserve to be named even in the most cursory account of British letters.

The time has not yet come when the literary forces of the 19th century can be reckoned with the same precision as in the case of the centuries that preceded it. Of Scotland, however, it may be safely said that the literary succession of the 19th century is not unworthy of its brilliant predecessor; and it may also be added that all the work of the highest order contributed by Scotsmen to the imperial literature bears the unmistakable stamp of its national origin. In the two greatest literary Scotsmen of the century, Scott and Carlyle, the distinctive genius of their country cannot be missed. While the work of Scott has its elements of universal interest, in its initial inspiration, in its recurrent moods it is one in nature with the Scottish soil and the Scottish race. In Carlyle we have in ungovernable force that emotion in the presence of the mystery of things against which, as he has himself told us, Scott likewise had all his life to do battle, and which, as we have seen, may be regarded as the deepest and most constant note of the Scottish character and genius.

In the foregoing sketch only writers of the first importance have necessarily been mentioned; but such names as the following can hardly be left unnoticed in the briefest account of the literature of Scotland. For the 18th century Miss Jean Elliot, Mrs Cockburn, Lady Anne Barnard, John Skinner, and Robert Fergusson as writers of Scottish verse; and John Home, Henry Mackenzie, Lord Hailes, and Dr Adam Ferguson as writers in standard English, may be specially named. In the

19th century there has been no lack of poets in the vernacular—among the best known being Robert Tannahill, James Hogg, Allan Cunningham, William Tennant, William Laidlaw, and William Motherwell. Thomas Campbell, Joanna Baillie, Professor Wilson, and Professor Aytoun, as poets; George Chalmers, Malcolm Laing, John Pinkerton, Dr M'Crie, Patrick Fraser Tytler, Sir Archibald Alison, and John Gibson Lockhart, as biographers and historians; Dugald Stewart, Dr Thomas Brown, Sir James Mackintosh, Sir William Hamilton, and Professor Ferrier, as philosophers; and John Galt, Professor Wilson, John Gibson Lockhart, Miss Ferrier, and Michael Scott, as novelists, represent the main contribution of Scotsmen to English literature, living authors being left out of account.

See the introductions to the different volumes issued by the Scottish Text Society; David Irving, *Lives of the Scottish Poets and Lives of Scottish Writers*; Dr John Ross, *Scottish History and Literature to the period of the Reformation* (1884); T. F. Henderson, *Scottish Vernacular Literature* (1898); the various histories of English literature; and in this work the articles on the authors named, as well as those on more recent Scottish writers, such as Mrs Oliphant, George Macdonald, William Black, Andrew Lang, and R. L. Stevenson.

Scotland Yard, in Whitehall, being the headquarters of the metropolitan police, is believed to have received its name from a palace there in which kings of Scotland and their ambassadors occasionally lodged. New Scotland Yard, the police headquarters since 1890, is on the Thames Embankment.

Scots Greys. See DRAGOON.

Scots Guards is the name of a well-known regiment of Guards (q.v.) in the British army. But the name has most national interest as that of the Scottish force which served the kings of France. The alliance of the Scots and the French, never, perhaps, very cordial and spontaneous on either side, lasted, nevertheless, for a very long period, and was maintained by common interest and reciprocal benefits, and is still distinctly traceable in the Scottish language, laws, and institutions. This alliance originated and developed in the persistent efforts of the Edwards and their successors to subdue both France and Scotland to the English crown. In no outward fact, however, does this alliance appear more conspicuously and interestingly than in the history of the Scots Guards or Scottish Archers in France, extending over 400 years, from 1418 till 1830. All Scotland and all Europe is familiar with the vivid picture of that theme presented by Walter Scott in *Quentin Durward*, in *Le Balafre*, in the veteran Lindsay, and in the other living figures of that romance, which is mainly based on fact.

In the distracted, almost hopeless, state to which Henry V. of England reduced France in the time of Charles VI. the Scotch archers, who then began to flock thither in large numbers by way of La Rochelle, the only port at that time not yet in possession of the English, distinguished themselves as the staunchest element in the French forces, as the rallying centre of a new army. From 7000 to 10,000 landed in 1419 under the command of the Earl of Buchan. The great victory of Charles VII. at Baugé on 22d March 1421, celebrated in the French court by a whole month's rejoicings, was the achievement of Scotch valour. In that engagement the Duke of Clarence was unhorsed by Sir John Swinton, and had his death blow dealt him by the Earl of Buchan, who was rewarded with the highest military office in France—that of Constable. At Verneuil in 1424 the Scots fought to the last with stubborn determination, but the English gained a bloody victory. Soon after this the Scottish gentlemen were constituted the king's

special bodyguard, and Archibald, Earl of Douglas, who had come over from Scotland at the invitation of the king, was created Duke of Touraine. Of the fifteen companies of men-at-arms, the beginning of a standing army, formed by Charles VII. two were composed exclusively of Scotsmen—'Les Gendarmes Ecossois' and 'La compagnie Ecossoise de la Garde du Corps du Roi.' Subsequently Louis XII. solemnly recognised 'that the institution of the Scots Men-at-arms and the Scots Life-guards was an acknowledgment of their services and their great loyalty and virtue.' To the league against his father the Dauphin (afterwards Louis XI.) tried in vain to gain over the Scots Guards, and after his own accession to the throne Louis XI. rewarded their constancy by increased pay and privileges. And assuredly he had no cause to regret his favour towards them, for on two occasions he had them to thank for his personal safety; the first time, after the drawn battle of Monthléry, when 'the Scots Guards, considering the danger the king was in, took his majesty, who had been in arms all day without eating or drinking, and carried him safe to the castle of Monthléry;' the second time, when Louis XI. would have fallen in the furious night sortie of the Liégeois against the besieging forces of France and Burgundy but for the valiant defence of the Scots Guards. In the field of Seminara, when the French cavalry were *cutbute* and the Italian rear-guard had fled, the Scots still stood their ground, refusing to fly or surrender, and preferring to be hewn down, as they were to the number of 400. In the wars of Charles VIII., Louis XII., and Francis I. the Scots took a leading part.

After Scotland became Protestant the alliance with France naturally declined. Yet in the war of Richelieu with the Spanish monarchy we find, besides the Scots men-at-arms under Lord Gordon, the regiment of the *Gardes Ecossoises*, Sir John Hepburn's famous regiment, Forbes's corps of infantry and cavalry, and Colonel Douglas' regiment—all purely Scottish; and under Louis XIV. the Scots continued to take precedence of the rest of the army, heading the French in all the great battles of that reign, Minden, fought on 1st August 1759, being the last in which they figured. After this time the regiments, though they retained the Scottish name, were recruited mainly by French youths; and at the Revolution Scots guards and men-at-arms were, of course, disbanded. Reinstated again in their old privileges, they finally disappeared with the old monarchy in 1830.

See Father William Forbes-Leith, S.J., *The Scots Men-at-Arms and Life-guards in France* (2 vols. 1882).

Scots Money. See POUND, WEIGHTS AND MEASURES.

Scott, a great Border house whose pedigree has been traced back, somewhat dubiously, to one Uchtred Filius Scoti, or Fitz-Scott, a witness to David I.'s charter to Holyrood Abbey (1128), and thereafter to Richard Scot of Murthockston in Lanarkshire (1294), the cradle, however, of the race having been Scotstoun and Kirkurd in Peeblesshire. Anyhow, we find them possessors of Buccleuch in the lonely glen of the Rankle Burn, Selkirkshire, in 1415, and of Branxholm, near Hawick, from 1420-46 onwards. The then Sir Walter Scott fought for James II. at Arkinholm against the Douglases (1455), and was rewarded with a large share of the forfeited Douglas estates; and at subsequent periods his descendants acquired Liddesdale, Eskdale, Dalkeith, &c., with the titles Lord Scott of Buccleuch (1606) and Earl of Buccleuch (1619). Among them were two Sir Walters, one of whom fought at Melrose (1526), Ancrum (1544), and Pinkie (1547), and in 1552 was slain in a street

fray at Edinburgh by Kerr of Cessford, whilst the other was the rescuer of Kinmont Willie from Carlisle Castle (1596). Francis, the second earl (1626-51), left only two daughters—Mary (1647-61), married at eleven to the young future Earl of Tarra, and Anna (1651-1732), married at twelve to James, Duke of Monmouth (q.v.), who took the surname Scott, and was created Duke of Buccleuch. After his execution in 1685 his duchess, who had borne him four sons and two daughters, retained her title and estates as in her own right. She afterwards married Lord Cornwallis. Her grandson Francis succeeded her as second duke, and through his marriage in 1720 with a daughter of the Duke of Queensberry that title and large estates in Dumfriesshire devolved in 1810 on Henry, third Duke of Buccleuch (1746-1812), the pupil of Adam Smith, and a great agricultural improver. Walter Francis, fifth Duke (1806-84), was the founder of Granton, and owned in Scotland 676 sq. m.—an area larger than that of half of the sovereign states of the German empire. The Harden branch of the Scotts (represented now by Lord Polwarth) separated from the main stem in 1346; and from the Harden branch sprang the Scotts of Raeburn, ancestors of the greatest of all that great line, Sir Walter.

See Sir William Fraser, *The Scotts of Buccleuch* (2 vols. 1879); and Mrs Oliver, *Upper Teviotdale and the Scotts of Buccleuch* (1887).

Scott, DAVID, R.S.A., a painter of distinct originality and great imaginative power, was born in Edinburgh on the 10th or 12th of October 1806. He was a grave, silent boy, fond of drawing; probably a copy of Blake's 'Illustrations to the *Grave*' was not without effect in influencing the especial direction of his art. He studied in the Trustees' Academy, under Andrew Wilson, and was apprenticed to his father as a line-engraver. The impetus towards original work, however, was too strong to be resisted, and he determined to devote himself to painting. In 1828 he exhibited his first picture, 'The Hopes of Early Genius dispelled by Death,' in the Royal Institution, Edinburgh; and in the following year he was admitted a member of the recently formed Scottish Academy. The poetical subject of 'Adam and Eve singing their Morning Hymn' dates from 1829; and in 1831 he produced his vigorous personification of 'Nimrod the Mighty Hunter,' and his rendering of 'The Dead Sarpedon borne by Sleep and Death.' In the same year he published six etched plates, 'The Monograms of Man,' a series of profound symbolical inventions, and designed his twenty-five 'Illustrations to the *Ancient Mariner*,' etched and published in 1837, which seize with a wonderful force and intensity the weird conceptions of Coleridge's great poem. In 1832 he visited Italy, and remained in Rome for fifteen months, studying the old masters, and painting 'The Vintage,' now in the National Gallery, and other works. His impressions of the art of Italy were embodied in a series of papers published in *Blackwood's Magazine* in 1839-41. In his twenty-eighth year he returned to Edinburgh, and, amid much discouragement from the almost complete want of popular sympathy or interest in his work, he produced his 'Alchemical Adept (Paracelsus) Lecturing' (1838), now in the National Gallery of Scotland; 'Queen Elizabeth at the Globe Theatre' (1840); and 'The Traitor's Gate' (1841), one of the quietest, most impressive, and entirely satisfactory of his paintings. The following year saw the completion of 'Vasco da Gama encountering the Spirit of the Cape,' a colossal gallery work, over 16 feet in length, now in the Trinity House, Leith. Meanwhile the artist's health had been failing, and the want of appreciation had been chilling him to the

heart. Year by year his life became more withdrawn and saddened, and he died before he had reached the age of forty-three, on the 5th of March 1849. His forty designs to the *Pilgrim's Progress*, executed in 1841, were published in 1850, and eleven of his remarkable and daringly imaginative Astronomical Designs, drawn in 1848, were engraved in an edition of Professor J. P. Nichol's *Architecture of the Heavens* (1850). In spite of their frequently hurried execution and consequent faults of detail, Scott's works, on their technical side, have much of the large and powerful draughtsmanship and of the rich and dignified colouring that characterise the productions of the old masters. Their highest value, however, lies in their imaginative quality, in their power and originality as inventions. In his own words, Scott 'always judged painting by its sentiment, by its mental bearing, and thought most of new spheres of meaning.'

See the Memoir by his brother W. B. Scott (Edin. 1850); Selections from his Works, edited by his brother (Glasgow, 1866-67); and the monograph by the present writer (Edin. 1884).

His brother, **WILLIAM BELL SCOTT**, painter and poet, was born at St Leonards, Edinburgh, September 12, 1811, and was educated at Edinburgh High School. He studied art both at Edinburgh and London, settled in London in 1836, but exhibited only twenty pictures from 1840 down till 1869. The subjects of these were mostly historical or poetical. From 1843 till about 1858 he lived at Newcastle, in charge of the government school of art there, and down till 1865 he acted as one of the South Kensington examiners. His most important work in painting was the series of eight large pictures illustrative of Northumbrian history at Wallington Hall, completed later by eighteen pictures devoted to Chevy Chase in the spandrels. He produced a similar series, illustrating *The King's Quair*, on the walls of a newel staircase at Penkill Castle, near Girvan. Here he died, November 22, 1890. He began early to write poetry, and published *Hades, an Ode* (1838); *The Year of the World* (1846); and the more important *Poems of a Painter* (1854). Later volumes were the carefully selected and revised *Poems* (1875), and the genial and delightful little volume of a hundred short pieces, *A Poet's Harvest Home* (1882). To the literature of art he contributed a *Memoir of David Scott* (1850), *Half-hour Lectures on Art* (1861), *Albert Dürer* (1869), and *The Little Masters* (1879) in the 'Great Artists' series. See the Autobiography edited by Professor Minto (1892).

Scott, SIR GEORGE GILBERT, architect, was born on 13th July 1811, at Gawcott, Buckinghamshire, of which his father, son of Thomas Scott, the commentator, was perpetual curate. His education was neglected, but he had a good drawing-master; and his love of old churches suggested his being articled to a London architect (1827-30). His first start in life was as a designer of workhouses (1835); in 1838 he married a second cousin, Caroline Olfrid (1811-72), who bore him five sons, two of whom became architects; and soon after he built the first of several cheap and nasty churches. His 'awakening,' by the Cambridge Camden Society and an article of Pugin's, was in 1840-41; and thereafter, as a leading spirit of the Gothic revival, he built or restored 26 cathedrals, 9 abbey and 2 priory churches, 1 minster, 474 churches, 26 schools, 5 almshouses, 23 parsonages, 57 monumental works, 10 college chapels and 16 colleges, 27 public buildings, 42 mansions, &c. The Martyrs' Memorial at Oxford, St Nicholas' at Hamburg, St George's at Doncaster, the new Government Offices, Albert Memorial, and Midland Terminus in London, Preston town-hall, Glasgow University, the chapels

of Exeter College, Oxford, and St John's College, Oxford, and the Episcopal cathedral at Edinburgh may be specified; but countless other notices of his work are scattered throughout this work under the different towns. He was elected an A.R.A. in 1855, an R.A. in 1861; held the professorship of Architecture at the Academy; and was knighted in 1872. He died 27th March 1878, and was buried in Westminster Abbey.

See his *Personal and Professional Recollections* (1879), and an article in the *Builder* for 6th April 1878.

Scott, J. R. HOPE. See HOPE-SCOTT.

Scott, MICHAEL, a mediæval sage, who is said to have been astrologer to Kaiser Frederick II. (1194-1250), and to have translated for him, through the Arabic, some of the works of Aristotle, with Averroes' commentaries. His translation was apparently used by Albertus Magnus, and seems to have been one of the two familiar to Dante (see Jourdain, *Traductions Latines d'Aristote*; and the *Academy*, January 1892, p. 14). Dante, who died in 1321, alludes to him in the *Inferno* (canto xx., 115-117) in a way which proves that his fame as a magician must already have spread over Europe; and he is also referred to by Albertus Magnus and Vincent of Beauvais, and this really is all that we know of him. Dempster (1627) may be right in maintaining that 'Scotus' was the name of his nation, not of his family, in which case he would be probably an Irishman; but by Bœce (1527) he was boldly identified with a Sir Michael Scott of Balwearie, near Kirkcaldy, in Fife, who went on two embassies to Norway in 1290 and 1310. Camden, again (1580), asserts that he was a Cistercian monk of Holme Cultram in Cumberland; and Satchells, that in 1629 he had examined at Burgh-under-Bowness a huge tome which was held to be his *grimoire*. In Border folklore the 'wondrous wizard' of Sir Walter's *Lay* is credited with having 'cleft the Eildon Hills in three, and brilled the Tweed with a curb of stone;' and his grave is of course shown in Melrose Abbey. Nay, the 'Jingler's Room' in Oakwood Tower, near Selkirk, is pointed out as his, though Oakwood dates only from the 16th century. See monograph by J. Wood Brown (1897).

Scott, MICHAEL, author of *Tom Cringle's Log*, was born in Glasgow, 30th October 1789, and, after attending some classes at the university, went to seek his fortune in Jamaica. He spent a number of years in the West Indies, but in 1822 established himself in business in Glasgow, where he died, 7th November 1835. In 1829 he published anonymously in *Blackwood's Magazine* the brilliant serial story, *Tom Cringle's Log*, which, like *The Cruise of the Midge*, another of his numerous contributions to 'Maga,' has been often republished separately.

Scott, ROBERT. See LIDDELL.

Scott, THOMAS, commentator, was born the tenth of a grazier's thirteen children at Braytoft, in Lincolnshire, February 16, 1747. He studied hard in spite of drawbacks as a surgeon's apprentice and farm labourer, and received priest's orders from Bishop Green of Lincoln in 1773. He became curate of Weston Underwood, and in 1780 succeeded as curate at Olney the famous John Newton, whose characteristic Calvinistic theology he had already imbibed. In 1785 he became lecturer to the London Lock Hospital, and in 1803 was preferred to the rectory of Aston Sandford in Bucks, where he died, April 16, 1821. His *Force of Truth* (1779) has great autobiographic interest, and *Essays on the Most Important Subjects in Religion* (1793) long enjoyed and deserved celebrity, but his name is best remembered by his *Bible, with Explanatory Notes* (5 vols. 1788-92; 5th and best

ed. 6 vols. 1822). The prospectus of the 1856 edition stated that already £500,000 had been paid by purchasers for copies of this work, which is beyond doubt a remarkable monument of sound learning and exegetical sagacity.

His complete Works, including sermons and treatises doctrinal and controversial, were edited by his son, the Rev. John Scott (10 vols. 1823-25), who also published a Life, partly autobiographical (1822).

Scott, SIR WALTER (created a baronet 1819), the greatest of Scottish men of letters, and probably the best beloved author who ever lived, was born in the College Wynd of Edinburgh on Aug.

Copyright 1882, 1887, and 1900 in the U. S. by J. S. Lippincott Company.

16, 1771. His father, Walter Scott, was a Writer to the Signet; his mother's maiden name was Anne Rutherford, daughter of Dr John Rutherford, professor of Medicine in the University of Edinburgh. Scott thus sprung from the professional middle classes, but on both sides he came 'of gentle blood.' When he blazoned his quarterings on the roof of the entrance-hall of Abbotsford three shields of the sixteen had to be left blank, through a difficulty about the pedigree of the Rutherfords of Hunthill. Nevertheless, he came of the best blood on the Border, Scotts, Swintons, and Rutherfords. His great-grandfather was the grandson of Auld Wat of Harden, who married the Flower of Yarrow in 1567, and whose son again married Muckle Moud' Meg of Elibank. The facts of Scott's history are too universally known to be dwelt upon at length. A recent ingenious writer has tried to show that genius is a 'sport' or accidental variety of the consumptive and nervous temperament. It is certain that the first six children of Scott's father and mother died between 1759 and 1766. Locks of their hair, still glossy and golden, lay in Sir Walter's great desk, in his study at Abbotsford. Of the other six children only two, Walter and Thomas, left issue; the present descendants of Sir Walter Scott are the children of the Hon. Mrs Maxwell Scott, daughter of Mrs Hope-Scott, who again was the daughter of Sir Walter's daughter Sophia, who married Mr John Gibson Lockhart. The mother of Sir Walter survived all her children except the poet and Mr Thomas Scott. Scott himself, though one of the strongest men of his time, with a larger biceps, the Ettrick Shepherd tells us, than any man of the Rough Clan, nearly died in infancy 'in consequence of his first nurse being ill of a consumption.' At eighteen months he was suddenly affected with fever in teething, and lost the power of his right leg. In his third year he was sent to his grandfather's farm at Sandyknowe, where he was taught, not without difficulty, to read, and learned and shouted the ballad of *Hardyknute*. For about a year and a half he was at Bath, then returned to George Square, in Edinburgh, where he astonished Mrs Cockburn (a Rutherford of Fairniee, and author of *The Flowers of the Forest*) by his infant genius. Still lame, he was taken to Prestonpans (aged eight), where he met a veteran named Dalgetty and Mr George Constable, from whom (and from himself) he drew Monkbarons, and heard of Falstaff. Thence he returned, 'a grandam's child,' to George Square, where he lived, always reading and repeating ballads and poetry. In 1779 he was sent to the High School of Edinburgh, where he suffered from the senseless Scottish system of giving 'removes' each year, and from the coteries formed in large classes. He amused the boys with tales; he was ready to fight, 'strapped to a board,' as he was lame; he made game of Burns's friend, the blackguard dominie, Nicol; he fought in bickers with Greenbreeks; he wrote some English verse; he learned some Latin from Dr Adam, the rector or head-master. His schooling was inter-

raptured by a visit to Kelso, where he had the misfortune to become intimate with the Ballantynes. In Edinburgh the blind and venerable Dr Blacklock instructed his poetical taste, and he had his one famous meeting with Burns. He left the High School with a great knowledge of all that he had not been taught, but at Edinburgh University he did not improve his Latin, and, like St Augustine, he declined to learn Greek. His account of the studies of Waverley contains his regrets for wasted time, and his autobiography expresses his grief that he had turned away from Greek, 'considering what that language is, and who they were who employed it in their compositions.' Meantime his lameness was never cured, though he could walk thirty or forty miles in the day. His sweetness of temper did not suffer, as Byron's did from an infirmity which after all was not so great as to prevent Byron from bowling for Harrow. But Scott had not, like Byron, to feel that, but for this one defect, he would have been a perfect model of beauty. Withred hair, an upper lip of unusual length, a brow like a tower, and rugged Border features, he had no temptation, as Byron had, to vanity. Yet a lady has left her evidence that 'young Walter Scott was a comely creature.' About 1785-86 he entered his father's 'office,' the weary 'office' which, like some fabled monster, gapes for the boys of Edinburgh. Here, at least, he learned to cover paper at such a pace as never man did, and in a hand which could put some seven hundred words on one side of a sheet of foolscap. He studied Scots law sedulously, though his long fishing and antiquarian rambles made his excellent father (described in *Redguntlet*) fear that he would never be better than 'a gangrel scrape-gut.' As a lawyer's clerk, superintending an eviction, he first entered the Highlands, where he already knew Invernahyle, of the '15 and the '45, and many another veteran, whose legends appear in his novels. In Edinburgh he won friendships which only ended with life, and, in the heat of youth, according to his own account, he was at least sufficiently convivial. Of all his friends the world best knows William Clerk of Eldin, the original of Darsie Latimer in *Redguntlet*. Even now, it seems, the romance of his life had begun, and he loved the lady whom he loved till the end. 'This was the early and innocent affection to which we owe the tenderest pages, not only of *Redguntlet*, but of the *Lay of the Last Minstrel* and of *Rokeby*. In all of these works the heroine has certain distinctive features, drawn from one and the same haunting dream of his manly adolescence.'

In the autumn of 1796 that dream had gone where dreams go, but it endured where dreams endure, in the heart. On October 12, 1796, one of his friends, who knew the story, wrote, "'Men have died and worms have eaten them, but not for love.'" I hope sincerely that may be verified on this occasion.' Scott did not die, only his heart, as his *Journal* records, was broken for two years, then 'handsomely pieced,' 'but the crack will remain till my dying day' (*Journal*, December 18, 1825). '*Humana perpersi sumus*,' he adds, in his *Journal*, towards the end of his life. A short poem, *The Violet*, is almost the only direct allusion to this affair in his works. Not wholly unconnected with his hopes as a lover was his first publication, rhymed versions of ballads by Bürger (October 1796). The poems were admired, but 'proved a dead loss.' The spring of 1797 was spent in yeomanry drill. In July Scott made a tour into Tweeddale, and met David Ritchie, the Black Dwarf. Thence he wandered to Gilsland, where he first saw Miss Charlotte Margaret Carpenter, a lady of French extraction, but of English education. They soon became

engaged, and were married at Carlisle on Christmas Eve 1797. Though not a regular beauty, Mrs Scott had large dark eyes, and an engaging air, with plenty of gaiety and sense. Hogg describes her as 'a brunette with raven hair and large dark eyes, but, in my estimation, a perfect beauty.' The marriage, founded on sincere affection, was happy, though some of Scott's friends feared that the successes which left him unharmed might turn the head of Mrs Scott.

Already (1792) Scott had made his first raid into Liddesdale, and every year till 1798 he repeated it, gathered legends, studied characters like Dandie Dinmont, and 'was making himself,' as Shortreed said. His country home was a cottage at Lasswade, agreeably described by Mr R. P. Gillies in his *Recollections*. Scott made M. G. Lewis's acquaintance, wrote for a collection of Lewis's *Glenfinlas* and the *Eve of St John*, and translated Goethe's *Goetz von Berlichingen*. At the end of 1799, after the death of his father, he was appointed sheriff of Selkirkshire. In hunting for ballads he made the acquaintance of Hogg, of Leyden, and of his dear friend and occasional amanuensis, William Laidlaw. In 1800 he suggested to James Ballantyne that he should remove from Kelso to Edinburgh. At the same time he announced that he would give Ballantyne the printing of *The Border Minstrelsy*. The first two volumes appeared in 1802. In the autumn of that year, on Lady Dalkeith's suggestion, he began what he meant for a ballad. It became *The Lay of the Last Minstrel*, the first, perhaps the best, of his long poems. It was printed by Ballantyne in Edinburgh. The foundations of Scott's triumph and discomfiture were laid. The *Lay* made him at once the most popular author of the generation, and his share in the Ballantyne printing business proved his ruin. From the moment that he entered as the secret but only moneyed partner into that business he was never free from financial complications. For these, and all the evil they wrought, it would be unjust to lay all the blame either on the Ballantynes, on Constable, or on Scott. Sir Walter was the last to shirk his own share of the responsibility. Perhaps an accountant can make sense of the controversy, in three pamphlets, between Mr Lockhart and the representatives of the Ballantynes (1838-39). To an ordinary reader it seems clear that Scott hoped to make money by the business of printing, and that he also had 'a kindness like an elder brother's love' for the Ballantynes. It appears quite certain that John Ballantyne, when he entered the firm with no capital, complicated it by his ambition as a publisher, and by a sanguine temper which would not face nor state difficulties. On the other hand, Scott had a century of literary inventions, editions and the like, which were often started to benefit poor working men of letters, but which nearly always failed, except when he himself was the editor. Thus the publishing business was overwhelmed with unsaleable 'stock.' Both Ballantynes were undeniably extravagant. John was recklessly so. Scott himself bought land, always at a price beyond its value, he bought curiosities, his hospitality was more than princely, his generosity was unstinted; he was the providence of poor literary men, and the guardian genius of his neighbourhood. Yet he has been too severely blamed for profusion. Up to 1821 his purchases of land had cost about £30,000, while his official income (as Clerk of Session and Sheriff) had been £1600 a year, 'and he had gained as an author £80,000.' Abbotsford is not 'a wide domain'—far from it—and the house was so far from being a palace that Mr Hope-Scott found it necessary to build a large additional wing thereto. The ruin came not so much from personal extravagance as through

business conducted by London connections of Constable's house, in the wildest way, by 'bank accommodation' and bills, eternally renewed. James Ballantyne's own time was much occupied in the correction of Scott's proof-sheets rather than in attention to the details of his commerce. The value of his criticisms has been overestimated; his remarks on the proof-sheets of *Redgauntlet* are inept, and it cannot be said that he was a careful master-printer. Constable's own visionary character added to the complexities, and at last the crash came. Every one was in fault, every one was intoxicated by success. There is no more reason to doubt the uprightness of James Ballantyne than of Sir Walter, who finally paid his debts with his life. Admirers of Lockhart regret his tone towards the Ballantynes. To him it is clear they had ever been distasteful. He was as fastidious as Scott was almost over-tolerant, and the mere presence of the brothers must have been odious to him. But both had, with all their social defects and commercial demerits, a touching affection for Sir Walter.

We have anticipated the financial tragedy of Scott's life, or rather we have sketched its history from the moment when it began. Scott's prosperity never had a sound commercial basis. He was never really free from anxiety about money. How his sagacity and uprightness endured these bonds is a psychological mystery. In 1804 Scott, as sheriff of Selkirkshire, removed from Lasswade to Ashestiel, a small house beautifully situated on a wooded 'brae' above the Tweed, about four miles from the influx of the Ettrick. Had he been able to purchase Ashestiel, Abbotsford might never have risen from the swamps of 'Clarty Hole.' Early in 1805 the *Lay* was published, and met a deserved success. Scott now busied himself with articles in the *Edinburgh Review*, with his edition of Dryden, and with the commencement of *Waverley*. The early chapters did not please a friend, probably Erskine, and it was not completed till 1813-14. In 1806 Scott was appointed Clerk of Session, and withdrew from the bar. He discharged the duties for some years without the emoluments, which went to his predecessor in the office. In 1806 *Marmion* was begun. The plot is partly based on perfectly fictitious documents, foisted on Scott by Mr Surtees of Mainsforth. He never discovered the fraud. *Marmion* appeared early in 1808. A review, a most quibbling and unfair review, of it was written by Jeffrey for the *Edinburgh*. This attack, and the whiggery of the *Edinburgh*, caused Scott to break off his connection with that serial, and to busy himself in starting the *Quarterly*. Jeffrey did not injure *Marmion*, and its popularity outdid even that of the *Lay*. Scott, who feared to take another 'scourging crop' of verse off the soil, now occupied himself with editing Dryden, Swift, and other classics. He quarrelled with Constable (the publisher of the *Edinburgh*), or rather with his partner, Mr Hunter, and in January 1809 he tells Southey that 'Ballantyne's brother' (John) 'is setting up here as a bookseller, chiefly for publishing.' Ballantyne was to be in alliance with Mr Murray, but this arrangement did not last, and the publishing business only added to financial complications. In 1810 the *Lady of the Lake* was finished, and over-crowned even Scott's former triumphs. A Highland poem had long been in his mind, alternating with the scheme of a Highland romance in prose. Scott now visited the western isles, and schemed out *The Nameless Glen*, afterwards called *The Lord of the Isles*. He also reconsidered *Waverley*, but seems to have made no progress with it. In 1811 he received at last the salary of his clerkship, and came into a legacy of £5000. Now, too, he bought

his first farm, and began to turn the cottage on it into a mansion. The year 1811 saw him busy with *Rokeby*, which proved a comparative failure. *Childe Harold* had appeared; popularity had selected Lord Byron for its new idol. For a wonder, Scott did not rate *Childe Harold* much above its merits, but he entered into a friendly correspondence with Byron. He had never been much galled by *English Bards and Scotch Reviewers*. In 1813 (after *Rokeby* and the *Bridal of Triermain*) he declined the laureateship in favour of Southey. In 1814 he finished his *Life of Swift*, and published *Waverley*, writing the last two volumes in three weeks. *Waverley* took the world by storm, and Scott, who did not acknowledge the authorship, might well suppose he had found the purse of Fortunatus. The cold reception of *The Lord of the Isles* did not discourage him, and in January 1815, by way of a holiday, he began *Guy Mannering*, 'the work of six weeks at Christmas time.' It was published by Messrs Longman, but, with rare exceptions, Constable, with whom Scott had been reconciled, published the rest of his *Waverley* cycle. From this point space does not serve to retell the oft-told tale of Scott's amazing fertility. In 1817 a violent illness showed him that even his strength was mortal, but no malady clouds *Rob Roy* or *The Heart of Midlothian*. In 1819 a return of his complaint endangered his life, and in paroxysms of agony he dictated *The Bride of Lammermoor*, which, when printed, he read as the work of a stranger. He did not remember a line of it. His health was in part re-established; he opened a new vein of gold in *Ivanhoe*, but failed to please his readers with *The Monastery*.

If it is na weel bobbit
We'll bob it again,

he said. Novels poured from his pen, society flocked to Abbotsford, he seemed to Miss Edgeworth 'the idlest man alive.' Yet he never neglected his official duties; he toiled like a woodsman in his plantations, and he entertained all comers. As he said of Byron, 'his foot was ever in the arena, his shield hung always in the lists.' He managed the king's reception in Edinburgh, he heard cases at Selkirk, he took part in raising volunteer corps, he conducted an enormous and distracting correspondence, he cared for the poor with a wise beneficence, he had a great share in starting the Edinburgh Academy, he presided at the councils of the new gas company, he began the *Life of Bonaparte*, and still the novels flowed on. In 1825 he commenced his *Journal*, and for all that followed the immortal pages of that sad and splendid record must be consulted. *Woodstock* was in hand when the commercial crash came. Scott bore it like a stoic. From that hour all the energy not needed for public duties went into literature. He sometimes toiled for fourteen hours a day, led on by the hope of paying every penny of his debts. His labour cleared them, though not in his lifetime. Before his wearied eyes and worn brain the mirage of his complete success used to float at intervals, and who could grudge him these dreams through the ivory gate! It is needless to repeat the tale of his last days, his desolation when his publisher, Mr Cadell, disapproved of *Count Robert of Paris*, the insults heaped on him by the Jedburgh radical mob, his last voyage, his continued work at *The Siege of Malta*, his return home, his death. Few out of all who have read Lockhart or the *Journal* can have studied these chapters with tearless eyes. It is said that on the last morning of his life consciousness returned. He asked his nurse to help him to the window; he gave one last look on Tweed and said, 'To-night I shall know all.' That night he was 'Heaven's latest, not least welcome guest,' September 21, 1832.

In a brief record of his life it is impossible duly to estimate Scott, as an author or as a man. The greatness of his heart, the loyal affection and kindness of his nature, are at least as remarkable as his astonishing genius. There is only one voice as to his goodness. He was the most generous, the most friendly, the most honourable of men. In no relation of life did he fall short of the highest excellence. The magnetism (as we may call it for want of a better word) of his personality endeared him not only to mankind, but to the lower animals. Dogs, cats, and horses took to him at once. He was even persecuted by the affection of grotesque friends, pigs and chickens. He is one of the few who retain, after death, this power of making us love those 'whom we have not seen.' Nor was he less sagacious, in all affairs but his own, than he was sympathetic. As a man of letters he was more than generous, far from being envious, he could hardly even be critical, and he admired contemporaries in whom the judgment of posterity has seen little to approve. In his lifetime the Whigs, as Whigs, did not love him. He was a Tory. With a sympathy for the poor, which showed itself not only in his works, but in all his deeds, and in all his daily life, he believed in subordination. All history showed him that equality had never existed, except in the lowest savagery; and he could not believe in a sudden reversal of experience. His tastes as a poet also attached him to the antique world. His ideal was, perhaps, a feudalism in which every order and every man should be constant to duty. Absentee landlords he condemned as much as callous capitalists. He had seen the French Revolution, he had witnessed various abortive 'risings' in the west country, and his later years were saddened by apprehension of a *Jacquerie*. He hated the mob as much as he loved the people, his own people, the kindly Scots. He was a sturdy Scotchman; but, says Lockhart, 'I believe that had any anti-English faction, civil or religious, sprung up in his own time in Scotland, he would have done more than any other living man could have hoped to do to put it down.'

As a writer it is a truism to say that, since Shakespeare, whom he resembled in many ways, there has never been a genius so human and so creative, so rich in humour, sympathy, poetry, so fertile in the production of new and real characters, as the genius of Sir Walter Scott. To think of the *Waverley* novels is to think of a world of friends, like the crowd whose faces rise on us at the name of Shakespeare. To say this is to say enough, but it must be added that scenes as well as people, events as well as characters, are summoned up by his magic wand. There is only one Shakespeare, however, and he possessed, what Scott lacked, every splendour and every glory of style. Of both men it might be said that 'they never blotted a line;' but the metal flowed from the furnace of Shakespeare's brain into many a mould of form, all magical and immortal in their beauty. Scott 'never learned grammar,' as he said, and his style is that of an improviser. Its recklessness, and occasional flatness, he knew as well as any of his critics. But again and again, in published work, as in unpublished letters, he owns himself to be incapable of correcting, and impatient of the labour of the file. In proofs he corrected freely, but seldom to improve the style. It is often lax, and even commonplace; it rarely approaches distinction. It is at its best, absolutely perfect indeed, in his Scotch dialogue. Nor was he more careful of his plots. In the introduction to the *Fortunes of Nigel* he shows us exactly how he worked, incapable of laying down the lines of a plot, and sticking to them, following always where fancy led him, after Dugald Dalgetty, or Bailie Nicol Jarvie.

Delay, painstaking, would not have made *him* a more finished writer, and would have deprived us of many a *Waverley* novel. Every man must do his work as he may: speed was Scott's way. The only real drawback to his unapproached excellence, then, is this congenital habit of haste, this quickness of spirit, which, as Lady Louisa Stuart said, made him weary of his characters long before his readers were weary. Yet his genius triumphs in his own despite, and what he wrote for the amusement of a generation is fashioned for immortality, living with the fiery and generous life of his own heroic heart. Scott's poetry suffers more from his 'hasty glance and random rhyme' than his prose, because from poetry more exquisite finish is expected. That finish is only to be found in his lyrics, the freshest, most musical, most natural and spirited of English verses. In his metrical romances he has spirit, speed, ringing cadences, all the magic of romance, all the grace of chivalry. Since Homer no man has written so much in Homer's mood, so largely, so bravely, with such delight in battle. But 'the grand style' is absent, save in the more inspired passages. Scott's lays are lighted with the Border sun, now veiled in mists, now broken with clouds: we are not here in the wide and luminous ether of Homer and of Hellas.

Wild as cloud, as stream, as gale,
Flow forth, flow unrestrained, my tale!

he exclaims, in lines addressed to Erskine, conscious of his fault, but impenitent. His fame must suffer in some degree from his own wilfulness, or, rather, from the incurable defect of a genius which was rich, but not rare; abundant, but seldom fine. It may suffice for one man to have come nearer than any other mortal to Shakespeare in his fiction, and nearer than any other mortal to Homer in his verse. His influence on literature was immense. The Romantic movement in France owed nearly as much to him as to Shakespeare. Alexander Dumas is his literary foster-child, and his only true successor. To him also is due the beginning of a better appreciation of all ancient popular antiquities, and a more human understanding of history.

The best source for information about Scott's life is, necessarily, Lockhart's biography (2d and best ed., 10 vols., 1839). It has been supplemented by the *Journal* (2 vols., 1890), and by the *Familiar Letters* (2 vols., 1893). The *Ballantyne Humbug* and the *Refutation* may be studied, by people who must study them, in various editions of 1838-39. There is much interesting matter in Mr R. P. Gillies' *Recollections of Sir Walter Scott* (1837), and some amusing anecdotes in Hogg's *Domestic Manners and Private Life of Sir Walter Scott* (1834), though the Shepherd is a garrulous and graceless witness. Mr Carruthers' *Abbotsford Notanda* contains a few facts worth noting, and so does the Catalogue of the Centenary Exhibition. The Catalogue of the Abbotsford Library is a valuable index to his studies, and there are letters of some importance in *Archibald Constable and his Literary Correspondents* (1873). In 1872 Mr Hope-Scott published a reprint of Lockhart's condensed version of the Life, with a prefatory letter to Mr Gladstone. An interesting parallel between Homer and Scott is in Jebb's *Introduction to Homer* (1887).

Scott's works, especially the novels, have been translated into almost every civilised tongue, and he has had imitators in all languages. There are several French translations, of varying merit. In German the best are those associated with the names of Hermann (new ed. 1876) and Tschischwitz (1876); the Life by Elze (1864) is notable. See also the articles in this work on Abbotsford, Dryburgh, Ballantyne, Laidlaw, Lockhart, Hope-Scott, Ballad, Novels, and Romanticism.

Scott, W. BELL. See SCOTT (DAVID).

Scott, WINFIELD, an American general, was born near Petersburg, Virginia, 13th June, 1786. He was educated at William and Mary College,

studied law, and was admitted to the bar at Richmond in 1807. Feeling, however, greater aptitude for military life, he obtained a commission as captain of light artillery in May 1808. At New Orleans he was court-martialled for disrespectful remarks about his commanding officer, and suspended for a year. When war was declared against Great Britain in 1812, Scott, being made lieutenant-colonel, was ordered to the Canadian frontier. Crossing the Niagara River in October, he fought at Queenstown, and was taken prisoner, but was exchanged after three months. In May 1813 he was wounded at the capture of Fort George, and in July 1814 at Lundy's Lane; from this battle his commission as major-general was dated. The attempts to invade Canada proved failures, but Scott's personal achievements were regarded by his countrymen as redeeming features in the record.

During the ensuing years of peace Scott framed the 'General Regulations' for the army, and introduced the French system of tactics. In various local troubles his tact in preventing outbreaks was shown, especially during the Nullification excitement in South Carolina in 1832, and in the dispute about the boundary of Maine in 1839. He succeeded to the chief command of the army in 1841. In 1847 General Scott was given the command of the army for the invasion of Mexico; and on 9th March, with about 12,000 troops, he invested the city of Vera Cruz. After a heavy bombardment, the city and the strong castle of San Juan d'Ulloa capitulated on the 26th. Scott then hastened to the tablelands, defeated Santa-Anna at the pass of Cerro Gordo, and captured Jalapa and Puebla. Here from May till August he was obliged to wait for and drill reinforcements. When he resumed the march the battles of Contreras and Churubusco opened the highway to the city of Mexico, but a vain attempt to negotiate a treaty caused some weeks' delay. On 13th September the castle of Chapultepec was carried by storm; Santa-Anna fled from the capital, and Scott entered in triumph on the 14th. Here he remained until the following February, when the treaty of peace was signed. On this war General Scott's fame rests; he boldly claimed that his campaign had been 'successful as to every prediction, plan, siege, battle, and skirmish.'

Scott had in politics belonged to the Whig party, and in 1852 was its candidate for the presidency, but was easily defeated, owing both to the disintegration of the party and to his own blunders as a politician. In 1855 the rank of lieutenant-general was revived in his favour. Scott was always a firm supporter of the Union, and in the crisis of 1860-61 remained true to his allegiance even when his native state seceded. Though crippled by the infirmities of age, he retained nominal command of the army until November 1861. He died on 29th May 1866, at West Point, and was buried there. Scott was a man of imposing presence, 6 feet 4 inches high. Though undeniably vain and pompous, he was a sincere patriot and of unblemished integrity. His military genius was evidently adequate for a grander field than that in which it was exercised. But his fame has been obscured by the glare of the civil war, in which the officers trained under him had greater opportunities to display their powers. His Memoirs, published in 1864, unfortunately rather emphasised his vanity than vindicated his fame. The biographies written by others are of little value; his own Memoirs are elucidated by General E. D. Keyes's *Fifty Years of Observation* (New York, 1884).

Scottish Philosophy. Scotsmen taught philosophy in Paris and other foreign universities during the middle ages and as late as the 16th

century, and in some cases they returned to academic positions in their native land. When it is added that David Hume, the greatest name which Scotland has contributed to philosophy, is not included in the Scottish school, it will be apparent that the designation is not merely a mark of nationality, but expresses definite doctrines, or at least a definite tendency, in philosophy. The school may, for all practical purposes, be said to take its rise in the revulsion headed by Reid (1710-96) against the conclusions of the great sceptic. Antiquarian research has sought to place the foundation of the school earlier, in the teaching, for example, of Gershom Carmichael, who was professor in Glasgow from 1694 to 1729, or George Turnbull, Reid's teacher at Aberdeen, who lectured from 1721 to 1748. Francis Hutcheson, who succeeded Carmichael in Glasgow, and lectured from 1729 to 1746, is more frequently mentioned as the founder of the school, but he has a place rather among the succession of English moral philosophers, while the two other names are too obscure to be of any real account. Reid's answer to Hume appeared in 1764 under the title *An Enquiry into the Human Mind on the Principles of Common Sense*. Hence the current but somewhat misleading designation of Reid and his followers as the Common Sense (q.v.) school, which seems to imply an appeal from philosophical conclusions to the unreasoned verdict of ordinary consciousness. No doubt a certain warrant for this view of the Scottish philosophers may be found in certain passages of Reid himself, and still more in the diatribes of the lesser men, like Beattie and Oswald, who joined in the outcry against Hume. But common sense meant to Reid simply the common reason of mankind, as constituted by certain fundamental judgments which are expressed in the very structure of human language, and which are intuitively recognised by the mind as true. Reid's answer to Hume thus consists in traversing his reduction of experience to unconnected ideas. He attempts to show by a deeper analysis of experience that the having of ideas, or rather of knowledge, implies certain primitive or fundamental judgments as irreducible elements. This constitutes his attack upon what he calls 'the ideal theory,' that is to say, upon the presuppositions which he finds common to Descartes, Locke, Berkeley, and Hume; and in this, its most philosophical aspect, his theory may be compared with Kant's vindication of the categories as elements necessary to the constitution of the simplest experience. The weakness of Scottish philosophy has lain in its tendency to treat these rational elements as isolated intuitions. The reiterated appeal to 'the testimony of consciousness' is a short and easy method of disposing of an opponent, but it is apt to leave the opponent unconvinced. The natural dualism or natural realism which forms such an outstanding feature of Scottish philosophy asserts, against subjective idealism, that the object or the non-ego is given in knowledge along with the subject. But this important epistemological position degenerates too often into a crude metaphysical dualism of mind and matter as two heterogeneous substances.

Scottish philosophy has not produced anything like a metaphysical system, but its inductive method of procedure has led to a large amount of valuable psychological observation both in the intellectual and moral sphere of mental activity. This is mainly what we find in Dugald Stewart (1753-1828), accompanied by a power of persuasive eloquence which made philosophy a force and a tradition in the national life. Dr Thomas Brown (1778-1820), his successor in the Edinburgh chair of Moral Philosophy, was led by his acute psychological analysis so far in the direction of English

associationism that he can hardly be counted a continuator of the school. The most eminent successor of Reid and Stewart was Sir William Hamilton (1788-1856), who endeavoured to combine the traditional Scottish doctrine with the negative results of the Kantian critique of knowledge. Apart from his contributions to psychology and logic, his philosophy is in the main an assertion of the relativity of human knowledge, and the impossibility, therefore, of reaching a coherent metaphysical view of the universe. This position, however, has been disclaimed by M'Cosh and others as savouring too much of agnosticism, and as inconsistent with the original position of Scottish philosophy in regard to our immediate knowledge of mind and matter. Scottish philosophy has had a wide influence not only in Scotland and America, but also in France, through Cousin and his 'spiritualistic' followers.

See M'Cosh, *The Scottish Philosophy from Hutcheson to Hamilton* (1874); and the Balfour Lectures on *Scottish Philosophy*, by the present writer (1885).

Scotus. See DUNS SCOTUS, ERIGENA, SCHOLASTICISM.

Scranton, the fourth city of Pennsylvania, and capital of Lackawanna county, is on the Lackawanna River, 144 miles by rail NW. of New York. It lies in an important anthracite basin, and is a busy railway centre. Its trade in coal and mining supplies is enormous; and it has car and carriage factories, and great iron and steel manufactories, turning out locomotives, boilers, machinery, stoves, and edge-tools. Scranton is well built, its streets wide, with many handsome buildings, including among its scores of churches a cathedral. It was founded in 1840, and became a city in 1856. Pop. (1860) 9223; (1880) 45,850; (1890) 75,215; (1900) 102,026.

Screamer (*Palamedea*), a genus of birds of rather doubtful affinities, probably most nearly allied to the *Anseres* (ducks and geese). The bill is rather short, conical, curved at the extremity; there is a bare space around the eyes; the toes are long; each wing is furnished with two strong spurs. There are three species, sometimes referred to two genera—*Palamedea* and *Chauna*. The Horned Screamer, or Kamichi (*P. cornuta*), inhabits swamps in Brazil and Guiana, and feeds on the leaves and seeds of aquatic plants. It is of a blackish-brown colour, nearly as large as a turkey, and has somewhat the appearance of a gallinaceous bird. It receives its name from its loud and harsh cry. From the head, a little behind the bill, there rises a long, slender, movable horn, for which no use has been conjectured. The spurs of the wings are supposed to be useful in defence against snakes and other enemies.—The Crested Screamer (*Chauna* or *Palamedea chavaria*) is a native of Brazil and Paraguay, the head of which has no horn, but is adorned with erectile feathers. The plumage is mostly lead-coloured and blackish. The wings are armed with spurs.

It is very capable of domestication, and is sometimes reared with flocks of geese and turkeys, to

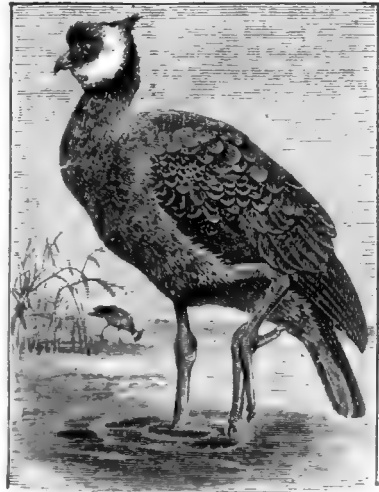

Crested Screamer (*Chauna chavaria*).

defend them from vultures, being a bold and powerful bird. Very closely allied to this is the Derbian Screamer (*C. derbiana*).

Screen, in Architecture, an enclosure or partition of wood, stone, or metal work. It is of frequent use in churches, where it shuts off chapels from the nave, separates the nave from the choir, and frequently encloses the choir all round. Such choir-screens are sometimes much ornamented, the lower part being solid, and the upper very often perforated. The rood-screen (see **ROOD**) is that on which most labour is usually bestowed. It derives its name from the rood or cross which stands, or in churches now Protestant once stood upon it. The rood screen usually forms the division



Rood-screen in Harberton Parish Church.

between the nave or transept and the choir. It has generally an ornamental gateway in the centre.

In Catholic churches it may have an altar at each side, and is frequently a structure of some size, with a staircase leading to the roof-loft on the top, where the cross or crucifix stands conspicuous at the entrance to the choir. The loft is also used for certain religious functions and ceremonies. In England many beautifully carved screens in stone, enriched with pinnacles, niches, statues, &c., remain, such as those of York, Lincoln, Durham, &c.; and specimens in wood, carved and painted, are common in parish churches, that at Harberton, near Totnes, which is represented in our illustration, being one of the finest in the kingdom. In France the screen round the choir is sometimes the subject of beautiful sculptures, as at Amiens and Paris. In halls of castles and mansions there was usually a wooden screen at one end to separate the entrance-door and a passage from the hall. Over this was a gallery. The term 'screen of columns' is also applied to an open detached colonnade.

Screw. Under ROTATION it is pointed out that the most general displacement which a rigid body can experience may be represented by a screw motion about and along a definite axis. The kinematic characteristic of screw motion is easily studied by help of any ordinary screw working in its nut. We may fix the nut and consider the motion of the screw; or fix the screw and consider the motion of the nut. In either case we find a certain translation associated with a proportional amount of rotation. The ratio of the translation to the associated rotation is called the *pitch* of the screw. In an ordinary single-threaded screw the practical measure of the pitch is the distance between the threads, and is simply the translation for one complete rotation. In dynamics it is more scientific to take the pitch as the translation for a rotation through the radian or unit angle (see CIRCLE). The ratio of the scientific to the practical pitch is the same as the ratio of the circumference of a circle to its radius. The smaller the pitch, the less is the translatory motion for a given rotation; and when the pitch is made zero, the screw motion is reduced to a pure rotation. On the other hand, the larger the pitch, the greater is the translation for a given rotation; so that a screw of infinite pitch corresponds to a pure translation. Thus screw motion includes all possible kinds of motion, translation and rotation being limiting cases.

Dynamically, screw motion is said to be produced by a *wrench*, which is the most general quantity of the force type. When the screw motion is reduced to translation, the wrench becomes force in the usual sense of the word; and couple, which produces rotation, is the other limiting case of wrench. The simplest conception of a wrench is obtained from the combination of pushing and twisting needed to bore holes with a gimlet.

The screw is a very important element in machinery. In itself, however, it is not complete, being only half of the *screw-pair* or elementary mechanism to which it belongs. The complete mechanism is well illustrated by the combination of screw and nut. By making the pitch zero, we pass to the one limiting case known as the *turning-pair*; and by making the pitch infinite we get the other limiting case—viz. the *sliding-pair*. These three combinations form the simple elements of all machines.

One of the most important uses of the screw (as in the screw-press) is to apply or sustain a large pressure in the direction of its axis by means of a comparatively small couple acting about its axis. We shall suppose the couple to be applied by a force, F , acting at the end of a lever attached to the screw; and that the result is a thrust, P . If

a is the arm of the lever, and p the pitch, the principle of work (see ENERGY) gives us the relation $Fa = Pp$. Hence the smaller the pitch the greater the pressure exerted by the screw for a given couple acting round its axis. The pitch is diminished by making the thread of the screw finer. But, as this also makes it weaker, we see that there must be a practical limit to increasing the advantage of the screw in this way. So far we have neglected friction, which must, however, be considerable in all screw-pairs because of the great pressures existing between the opposed faces of the threads of the screw and nut. The power applied, Fa , must, therefore, be greater than the effective work done. In some cases, when the pitch is small, the efficiency, or ratio of useful work done to work expended, may be reduced to one-third. If the pitch is very large the action of the screw may be reversed, the driving force being the thrust, P , and the resistance the couple, Fa , opposing the rotation of the screw. In most cases the pitch is too small for reversal, the couple brought into play by the friction always being sufficient to prevent motion. It is this non-reversibility that gives the screw its peculiar virtue in holding together parts of a frame or machine. For the screw-propeller, see SHIP-BUILDING, page 404.

Screw Bean. See MEZQUITE.

Screw-nails, called in the trade 'wood screws,' are made from mild steel and iron; or from brass, copper, and zinc, when others would be destroyed by rust. Wood screws were in use long before the year 1760, when the brothers Wyatt obtained a patent for cutting screws by machinery. Before 1817, wood screws, being nearly all forged and then shaped by hand, were very expensive; but at that time a patent was granted to John Colbert, a German watchmaker, who made the first automatic machinery for this purpose. In the year 1854 a greatly improved machine was introduced from America, which may be said to have revolutionised screw-making. These machines are complicated, and expensive in first cost and also to keep in operation. The wire is supplied to the heading-machine, which cuts off a piece, and a blow from a die stamps a head on it. It is then turned and nicked, after which, in a worming-machine, a cutter passes several times along the blank and forms the thread and gimlet point. One person can attend to several of these machines. Considerable success has been attained in rolling the threads on screw blanks. Two reciprocating plates, or revolving discs, are made from hard steel, and grooved at an angle; the screw blank is rolled between them under great pressure, receiving the reverse impression of the grooves which form the thread. The annual consumption of wire for making wood screws in England amounts to 9000 tons. They are principally made in Birmingham, and one firm alone can produce 150,000 gross weekly.

Screw Pine (*Pandanus*), a genus of plants of the natural order Pandanaceæ, natives of the tropical parts of the east and of the South Sea Islands. Many of them are remarkable for their adventitious roots, with large cup-like *spongioles*, which their branches send down to the ground, and which serve as props. Their leaves are sword-shaped, with spiny edges, and are spirally arranged in three rows. In general appearance, when unbranched, they resemble gigantic plants of the pine-apple, whence their popular name. *P. odoratissimus* is a widely-diffused species; a spreading and branching tree of 25 feet high, much used in India for hedges. It grows readily in a poor soil, and is one of the first plants to appear on newly-formed islands in the Pacific. The male flowers

are in long spikes, the female flowers in shorter branches. The flowers are frequently gathered before expanding, and boiled with meat. Their delightful and very powerful fragrance has made the plant a favourite everywhere. Oil impregnated with the odour of the flowers, and the distilled water of them, are highly esteemed East Indian perfumes. The seeds are eatable; and the fleshy part of the drupes, which grow together in large heads, is eaten in times of scarcity, as is the soft white base of the leaves. The terminal buds are eaten like those of palms. The spongy and juicy branches are cut into small pieces as food for cattle. The leaves are used for thatching, and their tough longitudinal fibres for making mats and cordage. The roots are spindle-shaped, and are composed of tough fibres; they are therefore used by basket-makers; and in Japan they are also used as corks. More valuable as a fibrous plant is an allied species, *P. sativus* or *P. vacca*, the *Vacca* of Mauritius, which grows to a height of about 30 feet, but, from continual cropping of its leaves, is usually dwarfed to 6 or 10 feet. The fibres of its leaves are used for making the *Vacca bags*, which rival in cheapness and usefulness the gunny-bags of India. The leaves are cut every second year. Immediately on being cut off the leaves are split into fillets, which are nearly an inch broad at the base, but taper to a point, and are 3 or 4 feet long. The aerial roots of the *vacca* are so fibrous as to be used for making paint-brushes for coarse purposes.

Scribe (Heb. *sofer*), among the Jews, originally a kind of military officer, whose business appears to have been the recruiting and organising of troops, the levying of war-taxes, and the like. Later the Hebrew name *sofer* seems to have been especially bestowed on a copyist of the law books (Gr. *grammateus*). After the exile, under Ezra, apparently the copyist became more and more an expounder of the law (Gr. *nomodidaskalos*). In Christ's time the name had come to designate a learned man, a doctor of the law. Christ himself recognises them as a legal authority (Matt. xxiii. 2); they were the preservers of traditions, and formed a kind of police in the Temple and synagogues, together with the high-priests; and the people revered them, or were expected to reverence them, in an eminent degree. They were to be found all over the country of Palestine, and occupied the rank and profession of both lawyers and theologians. Their public field of action was thus probably threefold: they were either assessors of the Sanhedrim, or public teachers, or administrators and lawyers. Many of these teachers had special classrooms somewhere in the Temple of Jerusalem, where the pupils destined to the calling of a rabbi sat at their feet. The calling of a scribe being gratuitous, it was incumbent upon every one of them to learn and to exercise some trade. Those scribes who were not eminent enough to rise to the higher branches of their profession, to enter the Sanhedrim, to be practical lawyers, or to hold schools of their own, occupied themselves in copying the Book of the Law or the Prophets, in writing phylacteries, contracts, letters of divorce, and the like. Much of the Halacha, Haggada, and Mishna was due to them. As a rule they were Pharisees (q.v.), and, in their zeal to keep the law pure from any foreign influence, even Chasidim (q.v.). Amongst famous scribes are to be reckoned Hillel, Shammai, and Gamaliel.

See **JEW**, **PHARISEES**, **EXEGESIS**, **MISHNA**, **TALMUD**; also the histories of the Jews by Ewald, Graetz, and others; and Schürer's *History of the Jewish People in the Time of Jesus Christ* (Eng. trans. 1886-90).

Scribe, AUGUSTIN EUGÈNE, a French dramatic writer, son of a wealthy silk-mercer of Paris, was

born in that city on 24th December 1791, and died there on 20th February 1861. Although educated for the legal profession, his whole life was given to the 'manufacture' of stage-pieces of all kinds. His first play that can be identified was a failure, in 1811, and it was not until 1816 that he had any success to boast of. From that time, however, his productions were so greatly in demand by theatrical managers that he established a sort of dramatic manufactory, in which numerous *collaborateurs* were constantly at work under his supervision. His plots are interesting and his dialogue light and sparkling; and not a few of his pieces have been adapted for the English stage. As literature they have little value. The best known are *Le Verre d'Eau*, *Adrienne Lecouvreur*, *Une Chaîne*, and *Batailles de Dames*. Scribe also wrote various novels, and composed the *libretti* for a considerable number of well-known operas, including *Masaniello*, *Fra Diavolo*, *Robert le Diable*, *Les Huguenots*, *Le Prophète*, and *L'Africaine*. His *Œuvres Complètes* were published in 76 vols. in 1874-85. See **Life** by Legouvé, one of his assistants (1874).

Scriblerus. See **ARBUTHNOT**.

Scribner, CHARLES, publisher, was born in New York City, 21st February 1821, graduated at Princeton in 1840, and in 1846 joined in founding the publishing firm of Baker & Scribner. His partner died soon after, and the firm became Charles Scribner & Co. *Hours at Home*, first issued in 1865, in 1870 was merged in *Scribner's Magazine*, which was sold by the firm in 1881, and rechristened the *Century Magazine*. Charles Scribner had died in 1871 (August 26), and the firm in 1879 became Charles Scribner's Sons; and these in 1887 began a new *Scribner's Magazine*, in addition to their large publishing (as distinguished from printing and publishing) business.

Scrivellos. See **IVORY**.

Scrivener, FREDERICK HENRY AMBROSE, a distinguished New Testament critic, was born at Bermondsey in Surrey, September 29, 1813, and had his education at St Olave's, Southwark, and Trinity College, Cambridge. For some time assistant-master at Sherborne, he was head-master of Falmouth School from 1846 to 1856 (holding part of the time the perpetual curacy of Penwerris), and rector of Gerrans from 1861 till 1876, when he was presented to the vicarage of Hendon and made a prebendary of Exeter. One of the New Testament revisers from the beginning, he received a Civil List pension of £100 in 1872, the St Andrews LL.D. in the same year, and the Oxford D.C.L. in 1876. His *Plain Introduction to the Criticism of the New Testament* (1861) was at once admitted to the rank of a standard authority. Among his other books are *Bezae Codex Cantabrigiensis* (1867), *Cambridge Paraphrase Bible* (1870-71), *Six Popular Lectures on the New Testament Text* (1875), *Codex S. Ceaddae Lat. Eccl. Cath. Lich.* (1887). He died at Hendon, October 26, 1891.

Scrivener's Palsy, another name for **Writer's Cramp**. See **CRAMP**.

Scrofula is a term whose significance has varied much at different periods and in the usage of different writers. In its widest sense at the present day scrofula may be held to connote a disturbed condition of nutrition characterised by the occurrence of inflammatory or hyperplastic processes of a specific nature (see **GERM THEORY**) in the various tissues of the body. The tissues most frequently affected are the lymphatic glands, joints, bones, skin, and mucous membranes. The affection occurs most characteristically in the young subject. The older physicians (Hippocrates, Celsus) restricted scrofula practically to

an inflammatory swelling of the *lymphatic glands*, more especially about the neck. Though frequent attempts were made to widen its significance so as to include supposed kindred processes in other structures, the old view remained dominant both in lay and medical parlance till recently. But the discovery in many so-called scrofulous manifestations of the presence of the *Bacillus tuberculosis*—the essential cause of tuberculosis (see TUBERCLE, CONSUMPTION)—has gradually modified the older conception and led to a recognition of the identity or at least the close relation existing between scrofula and tuberculosis. Hence many pathologists nowadays regard the tubercle bacillus as the one essential cause of so-called scrofula, and hold the latter (when used in the more limited sense of Hippocrates) as synonymous with a *localised tuberculosis*. Strong evidence may be advanced in favour of this view. Other pathologists regard the scrofulous tissue as a pretubercular manifestation, and suppose that the depraved structures afford a suitable soil or *nidus* on which the tubercle bacillus, whenever it obtains access, flourishes and multiplies, giving rise to tuberculosis proper. This subject will therefore be found more fully treated under Tubercle. Scrofula is synonymous with struma.

This disease for centuries was thought capable of being cured by the touch of a king, and it was claimed that this power was of English growth, commencing with Edward the Confessor, and descending only to such foreign sovereigns as could show an alliance with the royal family of England. But the kings of France claimed the gift, and it was certainly practised by Philip I., although he was allowed to have lost the power through his immorality. Laurentius, physician to Henry IV., claims that the power commenced with Clovis I., and says that Louis I. added to the touch the sign of the cross. He tells us also that Francis I. even in captivity preserved the power. In France it did not fall completely into disuse till 1776. William of Malmesbury is the first to mention the gift of healing in England and to attribute it to that most miserable of saints, Edward the Confessor. From his time down to Henry II. there is no account of the practice, but it reappears under Henry II., John, Edward II., Edward III., Richard II., Henry IV., V., VI., VII., and VIII., its truth guaranteed by grave and credible writers like Archbishop Bradwardine, Sir John Fortescue, and Polydore Virgil. Henry VII. was the first to institute a particular service of ceremony on the occasion of the touching; that used in Queen Anne's time will be found in the contemporary Prayer-books. In Henry's reign also the presentation of a piece of gold was first generally introduced, usually the angel-noble; but after the reign of Elizabeth the size of the coin was reduced for the sake of economy. James I. and Charles I. both touched, and we are told that the latter sometimes gave as his touch-piece silver instead of gold. But the practice reached its greatest height under Charles II., who even touched 260 persons at Breda before crossing to England, and we learn from the *Charisma Basilicon*, the third part of the *Adeno-chiuradologia* (1684) of the royal surgeon John Browne (1642-1700), that no fewer than 92,107 persons were touched between 1600 and 1682. Yet we learn from the Bills of Mortality that more persons died of scrofula during this period than any other, the evil having greatly increased during the king's absence. Browne's work is the best contemporary account of the rite that we possess. It is interesting that Sir Thomas Browne does not allude to the royal gift of healing, although there are allusions in his domestic letters to the practice of touching and to his granting the

ordinary certificate as a physician. James II. also touched for the evil, but William III. put an end to the practice. Anne renewed it, and we read how on March 30, 1714, she touched 200 persons, among



Touch-piece (time of Queen Anne).

them Samuel Johnson, whom, however, she did not heal. With the accession of the House of Brunswick the practice entirely ceased, but it seems that the Pretenders for some time attempted to maintain it, and we are told that the prince Charles Edward touched a child at Holyrood in 1746, which was healed within 21 days after. In 1748 the nonjuror historian Thomas Carte lost his subsidy from the Common Council of London for a note in the first volume (December 1747) of his *History of England* to the effect that a man had been cured of the king's evil by the touch of the Pretender at Avignon in November 1716. We find frequent allusions to the practice in Pepys and Evelyn, and indeed it was for centuries an article of popular belief, so that we need not wonder at the credulous warmth of Heylin, Sergeant-surgeon Wiseman, and Jeremy Collier. See T. J. Pettigrew, *On Superstitions connected with Medicine and Surgery* (1844).

SCROFULOUS or Tuberculous Diseases occur similarly in cattle, sheep, pigs, and less frequently in horses and dogs. See at CONSUMPTION the section on consumption in the lower animals.

Scroggs, SIR WILLIAM, synonym for an unjust, venial, and brutal judge, became Chief-justice of the King's Bench in 1678, and was specially notorious for cruelty and partiality during the trial of the unfortunates accused of complicity in the alleged Popish Plot (see OATES). In 1680 he was impeached by the Commons, but removed from office by the king on a pension. He died in 1683.

Scroll, an ornament of very common use in all styles of architecture. It consists of a band arranged in convolutions, like the end of a piece of paper rolled up. The Greeks used it in their Ionic and Corinthian styles, the Romans in their Composite; and in mediæval architecture, and all styles which closely copy nature, it is of constant occurrence as in nature itself.

Scrope, a famous family of the north of England that produced, amongst others, Richard le Scrope, Chancellor in 1378 and 1381-82; Richard Scrope, Archbishop of York, who joined in the conspiracy against Henry IV., and was beheaded at York in 1405; and Lord Scrope of Bolton, Warden of the West Marches under Queen Elizabeth.

Scrope, GEORGE POULETT, geologist, was born in London in 1797, and was educated at Harrow and Cambridge, and on his marriage in 1821 exchanged his own name, Thomson, for that of his wife's family. He made studies of volcanic phenomena at Vesuvius, in central France, and elsewhere, and expounded his views in *Considerations on Volcanoes* (1824) and *Geology of the Extinct Volcanoes of Central France* (1827; 2d ed. 1872). As member of parliament for Stroud from 1833 to 1868 he became famous as a writer of pamphlets

in the interests of the agricultural labourer. A Fellow of the Royal Society and other learned associations, he died 19th January 1876.

Scrophulariaceæ (also called *Scrophularineæ*), a natural order, chiefly herbaceous and half-shrubby plants. The order is a very large one, containing almost 2000 known species, which are distributed over the whole world, both in cold and warm climates. Acridity, bitterness, and astringency are prevalent characteristics, and many species are poisonous. Mucilage, resinous substances, and essential oils are also products of many of the species. Some are root parasites. Some are admired and cultivated for their flowers; some are used medicinally. *Digitalis* or *Foxglove*, *Calceolaria*, *Mimulus*, *Mullein*, *Antirrhinum* or *Snapdragon*, *Gratiola*, *Scrophularia* or *Figwort*, *Veronica* or *Speedwell*, and *Euphrasia* or *Eyebright* are familiar examples. Very different from these humble herbaceous plants is *Paulownia imperialis*, a Japanese tree, 30 to 40 feet high, with trunk two or three feet in diameter, and flowers in panicles, about as large as those of the common foxglove; the tree is hardy in the milder parts of England, and is a beautiful ornament of shrubberies from London southwards.

Scrub. See AUSTRALIA, Vol. I. p. 589.

Scruple (Lat. *scrupulum*, 'a small, sharp stone') was the lowest denomination of weight among the Romans, and with them denoted the 24th part of an ounce (*uncia*), or the 288th of a pound (*libra*). As a measure of surface it was also the 24th part of the *uncia* (see OUNCE). In Apothecaries' Weight a scruple contains 20 Troy grains, is the third part of a drachm, the 24th of an ounce, and the 288th of a Troy pound. See WEIGHTS AND MEASURES.

Scudéry, MADELEINE DE, an interminable French novelist, was born at Havre in 1607, her father of Provençal origin. Left an orphan at six, she received a careful education from an uncle, and, still young, came up to Paris, where she soon became a notable figure in the brilliant society of the Hôtel Rambouillet. She was plain, if not ugly, thin, dark, and long-faced, full of vanity and prudishness, a 17th-century Madame de Genlis plus virtue, as Sainte-Beuve styles her. But blue-stocking as she was she had a woman's heart, and loved after the fashion of her heroines, with an exalted and chaste affection, the ill-favoured but learned Pellisson, in whom she had inspired a passion. Her half-crazy brother Georges (1601-67) left the service in 1630 to devote himself to literature, and, being gifted with fatal facility, posed as a rival of Corneille, and wrote many pieces long since securely forgotten. To Christina of Sweden he dedicated one poem, *Ataric*, of 11,000 verses. A kind of swashbuckler among men of letters, he wrote prefaces that read like cartels of defiance to any who had the temerity to doubt his genius. His sister used to help him in his writing, and Tallemant ascribes to her the entire responsibility of *Ibrahim ou l'illustre Bassa*, a romance in four large volumes, which he signed and published in 1641. Similarly *Artamène ou le Grand Cyrus* (10 vols. 1649-53) and *Clélie* (10 vols. 1654-60) both bore the name of Georges de Scudéry, although he contributed only the framework of the two, that is to say, the part which is the worst in both. Mlle. de Scudéry lacked real invention, and took her figures from her acquaintance and from the society of the day, travestying them as Romans, Greeks, Persians, or Carthaginians—thus, she has half-painted herself as Sapho in vol. x. of the *Grand Cyrus*. Victor Cousin discovered a key (1857) which named all the figures definitely, as *Artamène* for Condé, *Mandane* for Mme. de Longue-

ville, *Parthénie* for Mme. de Sablé, &c. But she had real skill in polished conversation, and, in later days when her stories had gone out of fashion, she reproduced ten volumes (1680-92) of these taken from her novels. Madame de Sévigné writes her daughter, 'Mlle. de Scudéry has just sent me two little volumes of conversations; it is impossible that they should not be good, now that they are not drowned in a great romance.' The *Grand Cyrus* is one of the masterpieces amongst the *romans de longue haleine*, as their order has been felicitously named, but a modern reader seldom strays far into its 15,000 pages. The incidents follow in the most helpless monotony and lack of verisimilitude, but the naiveté of the reflections completely disarms the critic. The virtuous authoress prided herself on her ability to fathom all the depths of love without having sounded them in her own experience, and the famous 'Carte de Tendre' in *Clélie, histoire Romaine*, is a fantastic but pretentious attempt to construct an analysis and guide to the whole kingdom of Love. It was not an invention of Mlle. de Scudéry, but due to the collaboration of the superfine ladies and gentlemen who frequented her Saturdays. She lived till the age of ninety-four, respected and honoured to the last, dying at Paris, 2d June 1701. The etherealised sentiment of her novels had already wearied the world, but the death-blow waited to be dealt by the hand of Boileau. Cousin calls her, but not happily, 'a sort of French sister of Addison.' As a woman it should not be forgotten to her honour that her brave devotion to friends like Mme. Longueville and Fouquet survived their fall; and none could ever be an object of indifference to the world of whom Madame de Sévigné could write, 'In a hundred thousand words I could tell you but one truth, which reduces itself to assuring you, Mademoiselle, that I shall love you and adore you all my life; it is only this word that can express the idea I have of your extraordinary merit. I am happy to have some part in the friendship and esteem of such a person. As constancy is a perfection, I say to myself that you will not change for me; and I dare to pride myself that I shall never be sufficiently abandoned of God not to be always yours.'

See Victor Cousin, *La Société Française au Dix-septième Siècle* (1858); Sainte-Beuve, *Causeries du Lundi*, vol. iv.; André Le Breton, *Le Roman au Dix-septième Siècle* (1890); and chapter iii. of Amelia Gere Mason's work, *The Women of the French Salons* (1891).

Scudo (Ital., 'shield'), an Italian silver coin corresponding to the Spanish Piastre (q.v.), the American Dollar (q.v.), and the English Crown (q.v.). It was so called from its bearing the heraldic shield of the prince by whose authority it was struck, and differed slightly in value in the different states of Italy, the usual value being about four shillings.

Sculling has two senses, a river sense and a sea sense. In its fresh-water acceptation sculling is the propulsion of a boat with a pair of sculls or light oars by one man (see ROWING). Among seafaring men, however, to scull is to drive a boat onward with one oar, worked like a screw over the stern.

Sculpin, a name given to the Dragonet (q.v.), and also in the United States to various marine species of *Cottus* or Bull-head—notably to *C. octodecimspinosus* and *C. scorpius*; the 'Daddy-Sculpin' being *C. grœnlandicus*.

Sculpture has been practised in all ages and by all races. There is no savage so untutored but can scratch a rude design upon a flat surface (the beginning of relief) or fashion a stone into the rugged semblance of a god. There are still

preserved the rough experiments of palæolithic man, which in character and expression fall but little short of the misshapen images of archaic Greece. Such backward races as to-day remain in the state of barbarism from which the more highly developed emerged countless centuries ago still aim at the innocent realism of prehistoric times. But these furtive attempts have naught in common with art; their interest is anthropological; and the present article treats of sculpture as it has been pursued by craftsmen with a certain control of their material and a consciousness of the effect it is theirs to produce. The sculpture of India, for instance, is merely fantastic; its preoccupation is religious rather than artistic. When viewed in relation to the great stream of tradition which connects the work of Rodin or Gilbert with the colossal figures of Egypt, it is but a shallow backwater. But from the time when the great Sphinx was set up at Gizeh until yesterday a countless succession of men have expressed their ideals in clay, bronze, marble, and other more or less stubborn substances, with a deliberate intention and tutored sense of dignity or beauty which entitle them to be revered as artists and their works to be treasured as masterpieces. With their achievement we are alone concerned; the ingenious scratchings of the savage—whether ancient or modern—and the fantasies of the Oriental mystic are for the curious to consider.

The material of sculpture is as various as the methods of its treatment. Wood, marble, basalt, granite, bronze, gold, and ivory are but a few of the substances which have been fashioned into beautiful and stately forms. Here at once we discover one determining element of style. An artist who works in porphyry or granite cannot express his fancy with freedom. A largeness and dignity is forced upon him by the rigid substance upon which he has chosen to work. So we find in the works of ancient Egypt a severe and monumental repose which would be out of place in figures of a modest size and more malleable material. It has ever been the supreme merit of the sculptor perfectly to adapt his means to his end. The Greeks of the 5th century expressed in marble the most beautiful lines and shapes which the material could suggest. Where there was no place for common or familiar ideas all was simple and restrained. On the other hand, the artists of Tanagra, working in the ready and pliant medium of terra cotta, did not venture beyond a scale and a technique which, though perfectly consonant to their purpose, have the grace and elegance of the masterpiece in little. The sin of taste which renders the bulk of modern sculpture vain and of base effect is ignorance of the material's limitations. The Italian of to-day who esteems marble the most apt substance for the presentation of lace-frills and waistcoats wrecks his craft upon the reef of cleverness. The artist does not carve and slash his marble as though it were paper, nor does he break up its surface into a thousand furrows as though it were putty; but, still within the bounds of taste and knowledge, he gives to his work a breadth and simplicity which are at war neither with art nor with nature. Indeed the problem of sculpture may be defined as the translation of the forms of the visible world into the language suggested by the material employed. Many of the grandest sculptures that time has spared were composed to fill certain spaces in wall or pediment. Their purpose being thus decorative, it follows that there is another force by which the artist is controlled. The variety of pose and contour which distinguish the Elgin marbles was suggested by the varying depth of the pediment they were destined to adorn. So also the flowing harmony of the Parthenon frieze pro-

ceeds from the subtlest adaptation of the design to the space. It is only necessary to contrast the masterpieces of Greek art with the outrages upon taste which have defaced Westminster Abbey since the 18th century to recognise how much beauty depends upon a sense of fitness. Realism, in brief, though the final aim of savage art, is but a snare to the artist in bronze or marble. To represent chosen aspects of animal forms which are in discord neither with their material nor with the site they occupy, this is the end of the sculptor, and in its attainment a sense of beauty must always conquer the interest of facts, a respect for tradition must forbid the play of ingenious artifice.

The Egyptians, as they were the first, were also the most prolific sculptors. Their temples and palaces were covered with reliefs; innumerable statues of gods and heroes stood upon their plains. The Sphinx (q. v.), which M. Maspero places many centuries before Menes—who flourished some 4000 years before Christ—is the product of an art already mistress of her resources. There is not a tentative touch in this noble monument; it is not an experiment like the seated figures from Branchidæ, which only preceded the efflorescence of Greek sculpture by a few centuries, but a work as finished in its grand impassiveness as the Theseus (so called) of the Parthenon. But Egyptian art, as it seems perfect in the beginning, knew no progress but decay. Its purpose was consistently the same. It did not advance, like Greek sculpture, from naïveté to accomplishment, from hieratic restraint to artistic enfranchisement. The school of Memphis is already a school of the decadence. And yet its artists are still for the most part bound in the chains of hieratic tradition. Their seated figures are always posed in the attitudes sanctioned by custom, the elbows firmly planted against the sides, the hands set forward upon the knees. Their reliefs also are stiff and archaic. While they display a knowledge of anatomy and an observation of the human figure in action, the head and legs are presented in profile, while the upper part of the body faces the spectator. This peculiarity was the result not of incompetence, but of a fierce conservatism. The reliefs, the figures of which either project from the ground or are depressed beneath it, were always coloured: indeed polychromy was invariable when the material was not naturally veined or coloured. But excavations at Boulak have shown that under the Memphis dynasty, despite the influence of the ancient school, realistic portraiture was practised with amazing success. Such a figure as the wooden *Sheik-el-beled* (see Vol. IV. p. 236) is neither stately nor beautiful, yet there is little doubt that it is a speaking likeness; and so much may be said for a dozen masterpieces treasured at Boulak. The first Theban school, which flourished from the 10th to the 16th dynasty, drew its inspiration from the school of Memphis. The same respect for tradition, the same interest in portraiture were piously preserved. Indeed Egyptian art clung to the ideals of grandeur and formality until the advance of Greece introduced a fresh science and a fresh civilisation. By its very austerity no less than by its balanced union of observation and convention the sculpture of Egypt displays a grandeur and impressiveness which it shares with no other manifestation of art. Its hybrid colossal and monstrous deities, hewn out of the stubbornest material, are still noble in spite of their ugliness; and that even the formal Egyptian was not incapable of representing graceful types the portrait of Menephtah and Queen Taia remain to show. And yet from the classical period the Sphinx alone survives (see figures in the article EGYPT, and at Vol. I. p. 22).

Assyrian sculpture, which grew out of the ruder art of Chalkæa, like Egyptian, knew neither progress nor development. Its earliest monuments date from the 12th century B.C., but the magnificent series of reliefs in the British Museum are not earlier than the 9th and 8th centuries, and they display the inflexible characteristics of the most ancient period. The kings and viziers, who figure in the reliefs, conform to an invariable type. The monarch is recognised by his square-cut beard and jewelled tiara. He is often represented, like the figures of Egyptian reliefs, partly fronting the spectator, partly in profile. There is no attempt at portraiture, not a suggestion of naturalism. But in the treatment of animals the Assyrian allowed himself complete freedom. The lion-hunts are masterpieces of observation and execution. The finest reliefs prove that even before the matchless frieze of the Parthenon there were artists who could model the horse with animation and understanding. The Assyrians delighted also in hybrid forms; the portals of their palaces were guarded by colossal winged bulls with human heads, admirable specimens of which may be seen at the British Museum from the palace of Sargon (721-705 B.C.). Assyrian art in fine, despite its many conventions and inveterate symbolism, lacked the grandeur and the nobility of Egyptian sculpture. On the other hand, the artists of Assyria display a sense of life and movement, especially in their treatment of animals, unknown before them (see figures at Vol. I. pp. 517, 519, 633).

The origins of Greek sculpture are still in dispute. Some there are who would have us believe that the art which culminated in Phidias derived directly from Egypt or Assyria; others assert that it was autochthonous. The question does not admit of a positive answer. That the archaic Greeks were influenced by the art of the Orient is incontestable, but it seems no less certain that, the influence being superficial, Greek sculpture followed a natural course of development. In the treasure-house at Mycenæ are certain scabbards and sword-hilts of eastern design, if not of eastern workmanship, and there is no reason why the Phœnicians, the bagmen of antiquity, should not have carried these precious wares to Argolis. The famous Lion-gate, too, is Assyrian in character, and many examples of primitive Greek art are conspicuously Oriental. But both history and common sense are opposed to the view that the early masters of Selinus or the authors of the primitive Apollo statues (so called) owed a direct debt to Egypt. It has been pointed out that Egyptian art, when we first meet it, was finished and complete; its ideal was attained in obedience to hieratic laws. The sculptors of archaic Greece were too naïve to be the mere imitators of a classical style. Their aim was realism, so far as their limited resources and control of marble or bronze would carry them. The early history of Greek art is shrouded by the Greeks themselves in a veil of legend. With characteristic anthropomorphism the ancient critics were wont to represent each epoch in the development of art by a purely mythical hero. The Cyclopes, the Telchines, Dædalus, Butades, and Kore, to whom the invention of modelling is ascribed, are one and all very pretty fictions. Even Rhœcus and Theodoros, the inventors of bronze-casting, and Glanceus, who invented the soldering of iron (*σιδήρον κόλλησεν*), are names and no more. Indeed it is impossible until a comparatively late period to connect extant works with the name of their authors. When we examine the archaic monuments, such as the earliest metopes of Selinus, which are as old perhaps as 600 B.C., we find a style awkward and ingenuous even to barbarity. While the figures of Perseus and

Medusa front the spectator, the feet are planted from left to right, and the mason, so far from aiming at symmetry of design, was doubtless content with a vague semblance of humanity. The seated figures from Branchidæ, which may be as late as 540 B.C., are merely blocked out, and the seated Athena, ascribed to Endœus (550 B.C.), gives no promise of the golden age which followed less than a century later. The celebrated Lycian reliefs, known as the Harpy Tomb, mark a distinct step in advance. There is charm and dignity in their stiff elegance and beautiful drapery; and yet are they not still marred by the clumsy ingenuousness of the true primitive? At Athens art was born late and lived a brief, if brilliant, life. Nor is the *stèle* of Aristocles much better than an archaic experiment; though the relief of a woman stepping into a chariot, which may have been a metope of the Hecatompedon, has at least the suggestion of freedom and mastery. There exists a group of statues—called Apollo—which were fashioned in obedience to the same convention. They are rigid and clumsy in handling; the arms are fixed firmly to the side; and yet the surface is treated with breadth and simplicity, and there is an unmistakable Hellenism in the flow of the lines. That of Orcomenus is probably the most ancient, and may date from the 7th century; the most advanced in style is the so-called Strangford Apollo—now in the British Museum—which is doubtless not much older than the Ægina pediments.

The marble statues which adorned the gable-ends of the temple of Athena at Ægina, and are now the chief ornament of the Glyptothek at Munich, form the first great monument of Greek art which has come down to us. Each pediment represented the struggle of two opposing forces over a dead warrior. Though there is an archaic touch in the spare proportions and rigid attitudes of the figures, they are evidently the work of a master who understood his craft, and it is possible that the stern handling and the archaic smile were deliberate. The author is unknown. The eastern pediment is freer, and possibly later than the western, and the historians have ascribed it to Onatas, a sculptor whose name is preserved in the texts. But there is not a shred of definite evidence, and we can only describe these fine statues as the best specimen of Greek sculpture half a century before the advent of Phidias. The style of Myron and Polyclethus is known to us only by copies; that of Kalamis not at all, unless the Choiseul-Gouffier Apollo (so called) be a copy of his famous Apollo Alexikakos. All three were older contemporaries of Phidias, and concerning them all the ancient critics waxed eloquent. If we may believe a hundred epigrams, Myron aimed at realism and illusion rather than at beauty. His disc-thrower has been celebrated through all the ages, although, if the copy be accurate, Quintilian described it accurately as *distortum et elaboratum*. Polyclethus, on the other hand, was a true academic, and would have imposed a canon on the world. The well-known *Doryphorus* and *Diadumenus* are copies of his works; and though we may not determine therefrom his technique, we may at least realise the square proportion to which he bade his contemporaries conform.

In Phidias the art of sculpture culminated. Born at the most fortunate moment of the world's history, the artist of the Parthenon was a worthy contemporary of Sophocles and Plato. To his personal genius must be ascribed the marvellous efflorescence of art which conferred a unique glory upon the 5th century B.C. Cupidity and barbarism have effaced the monumental Chryselephantine (q. v.) figures of Athena and Zeus, which antiquity

esteemed his masterpieces. The bronze colossus—Athena Promachos—no longer stands upon the Acropolis to strike fear into the heart of invading Goths. But the sculptured decorations of the Parthenon have been preserved, though not unhurt by time, for our admiration. In style there is a profound difference between the metopes, which are marked by a dry archaism, and the magnificent works which are still the supreme expression of the art. Maybe the metopes preceded the rest by some years, and there is at least a mastery and sureness in their handling which separates them by a long interval from the Æginetan sculptures. But the frieze and such groups from the pediments as have survived the shocks and explosions of history are the work of a hand and brain balanced and complete. Here breadth, simplicity, and finish unite; there is ever an exquisite quality of surface; plane is related to plane with amazing subtlety; the accidental is rigidly excluded; nature and the convention of the art are happily blent; a sense of dignity, beauty, and control is everywhere apparent; not only is each figure perfect in itself, but each is perfectly adapted to the space it fills; the structure of the pediment compelled the sculptor to set his figures in exquisitely varied pose, so that the composition of the groups—which represented episodes in Athena's career—was at once flowing and coherent. The march of the frieze—a procession in the Pan-athenaic festival—is as large and stately as its details are exquisite (see Vol. IV. p. 293). Phidias (q. v.) is to-day, as at his advent, incomparably the greatest sculptor of the world; and his school handed on the torch he had given into their hands. The restrained elegance of the Caryatides of the Erechtheum, the graceful Victories, with their beautiful draperies, which adorned the temple of Nike Apteros, the refined grandeur of a dozen *stelæ*, the charming movement of the Phigalian frieze, are the outcome of Phidias' serene example. The sculptured figures of the temple of Zeus at Olympia, the shrine of the gold and ivory statue, are an interlude in the history of art. Legend in ascribing the east pediment to Paeonius (the author of the famous Nike), the west to Alcamenes, is almost certainly false; and, if judgment may be based upon style, these figures are earlier in date than the Parthenon. The so-called Neo-Attic school marks the decadence. Still beautiful in their decay, the works of Scopas (390-350), and of Praxiteles, his contemporary, have already declined from the austere and classic style of Phidias. Their works lack something of the repose and impartiality which distinguish the masterpieces of the Parthenon. Though both produced an immense quantity of works, we know little else than copies and the ancient texts can tell us. The one undoubted work of Praxiteles which still remains to us is the Hermes, discovered at Olympia in 1877; while the handiwork of Scopas may be seen in the sculptures of the Mausoleum. To the same period perhaps belong the incomparable Venus of Milo (see MELOS), and the grave Demeter of Cnidos now in the British Museum. Lysippus, the court sculptor of Alexander, followed with his new canon of small heads and jimp figures, and then the school of Pergamum, beginning the revolt against Attic repose, inflicted an irremediable injury upon the art of sculpture. The school of Rhodes, with its much bepraised Laocoon (q. v.), the school of Tralles, with its impossible Farnese bull, completed the glory of the un-sculpturesque. The capital of art was then shifted from Athens to Rome, and the industrious band of *Greculi aurientes* fashioned for us the excellent if uninspired copies to which we owe so much of our knowledge of Greek sculpture. To catalogue

their names were superfluous; they were not wont to sign them themselves. But they preserved for future ages such admirable works as the Amazon and the Doryphorus; and if the Apollo (q. v.) Belvedere and the Venus de Medici have since been monstrously overrated, their authors are not to blame. Lastly, mention must be made of Pasioteles, who, in the time of Pompey, made a determined effort—like the Pre-Raphaelites of England—to revive an archaic style, and even succeeded in establishing a school.

And then the art of sculpture suffered eclipse. In the early centuries of Christianity the attempt to model the human form was condemned as idolatrous, and such poor barbarous experiments as were made may be passed over in silence. In the 6th century a revival was inaugurated at Byzantium, and flatterers compared a monument erected by Justinian in 534 A. D., in honour of a victory over the Persians, to the masterpieces of Phidias. But the Christian spirit invading, Byzantine sculpture, truly the very lees of classicism, must needs take refuge in an elaborate symbolism. The use of gems and precious metals gave a certain splendour to the best examples of Byzantine art, and its influence was universal. No country in Europe escaped it, and until the 12th century its reign was undisputed. In the Gothic period sculpture was, as it were, rediscovered. Commonly somewhat rude and barbarous, often resigned to a vigorous realism, it was not an art deliberate and complete as was the sculpture of the Greeks. Its conventions grew up with its growth, and save in France it was rarely emancipated from the fetters of experiment. In England such monumental sculpture as belongs to the Gothic period is undistinguished and maladroit. William Torell's Queen Eleanor (13th century) will serve as an example as well as another, and the sculptured decoration of Henry VII.'s chapel at Westminster shows the Gothic style as it was before the Renaissance reached England. In France there is another tale to tell. The manifold figures which adorn the cathedrals of Chartres and Rheims, though Gothic in spirit, were produced under the influence of classical art. Their freedom and simplicity is a complete contrast to the barbarous productions of the previous century. However, there is no difficulty in the supposition that the French artists of the 13th century were familiar with Roman art, and to this acquaintance with a good school they owed their superiority both to their predecessors and to their contemporaries in other parts of Europe. The 14th and 15th centuries were a period of decline; the northern spirit gained a complete ascendancy, and with the exception of the works of Claus Sluter, which may be studied at Dijon, there is little to note before the Renaissance. Germany escaped from the thraldom of Byzantium in the 12th century, but she produced little work in the Gothic period that is either beautiful or sculpturesque. Not until the 15th century, when Syrlin, Dürer, and Wohlgemut practised wood-carving, is there any notable advance. To Adam Kraft (1430-1507) a feeling of beauty and rhythm was denied. His figures are square and squat, his drapery is arranged after the German method in stiff, hard-cornered folds. The Visscher family—Peter Visscher (1455-1529) was the greatest—made no conspicuous progress. They were still true to the Gothic ideal, and though their best work, such as Peter Visscher's portrait of himself, displays a bluff realism, it was based upon an inartistic convention and possessed no vital inspiration.

In Italy the classical tradition did not die, and such Gothic sculpture as the Italians produced was either of foreign origin or tintured strongly with a feeling of classicism. Niccolo Pisano, who

was born in 1205, was a devout student of classical models. In much of his work the two styles were ingeniously blent—in the pulpit at Pisa, for instance—and he was profoundly influenced by Roman sarcophagi. Nicolo's son, Giovanni, followed in his father's steps, and, though still a primitive, conferred fresh glory upon the Pisan school, which the ingenious Orcagna (born 1329) brought to an end. Giacomo della Quercia (born 1374), the author of the celebrated Fonte Gaja at Sienna, marks the transition from the old to the new, from the middle ages to the Renaissance. A student of nature, he only half understood the possibilities of the great revival, but his design for the gate of the baptistery at Florence (1401) was placed next in order after the designs of Ghiberti and Brunelleschi, and therefore he may be said to have heralded the re-birth of art. In Italy, where the Goth had never dominated, the Renaissance was a development rather than a revolution. The spirit had always been the same, and Ghiberti (born 1381), the first master of the new school, may hardly be called an innovator. His famous gates at Florence occupied the larger part of his life. The first was begun in 1403; the second was not finished until 1452. The work is marked by a snavity of line and a certain elegance in individual figures. But it is entirely pictorial; the design is rarely thought out with reference to the necessities and limitations of the art of sculpture, and there is scarce a panel in either gate that is not overcrowded with figures.

In 1386 was born Donatello, by far the greatest sculptor of the 15th century. Endowed richly with the artistic temperament, learned in all the new learning, Donatello was also an indefatigable observer of nature and a master of design. His work is Greek in the best sense; large, simple, and restrained. He did not, like Ghiberti, overstep the limits of his art; he did not, like Michelangelo, a man of far rarer genius, use sculpture to express the passions of a violent brain. Content to aim at perfection in his art, he produced a series of masterpieces, which for feeling of rhythm, sense of proportion, and architectural adaptation may scarce be matched save in the golden age of Athenian sculpture. Simplicity of plane, breadth of style, harmony of line, dignity of pose—these are the qualities which confer everlasting distinction on his St George, his equestrian statue of Gattamelata, and his incomparable reliefs. Michelangelo (1475–1564) has been discussed at length under his own name, and no more need be said of him here than that his gigantic personality has dominated the modern world; that his knowledge of the antique was so profound, his technical mastery so complete, that nothing save restraint was impossible to him; that he produced a series of extraordinary masterpieces in paint and marble; and that he founded a school which, beggared of his genius, did but exaggerate his more obvious faults. Luca della Robbia, the author of the 'Singing Boys' (1399–1482), is better known as the inventor of the famous Robbia ware than as a sculptor; while Benvenuto Cellini (1500–71), though he modelled the Perseus, is chiefly eminent as goldsmith and swashbuckler. The school of Michelangelo culminated in that most accomplished craftsman and mediocre artist Lorenzo Bernini (1598–1680), whose love of exaggerated forms and fantastic devices rendered his indubitable talent of no avail, though the unbounded influence which he exerted upon his contemporaries easily compassed the triumph of lawlessness and vulgar taste. Meanwhile the influence of the Renaissance was felt throughout Europe. In the 16th century, while Goujon imitated Cellini in France, Torrigiano in-

spired the English with an admirable taste in decoration, and Adrian de Vries reproduced in Germany the unchastened vigour of Giovanni da Bologna. In the 17th century there followed a universal decadence. Bernini's theatricality bore abundant fruit. Coyzevox, Clodion, Adam, the Coustous, Pigalle, and the rest, in spite of their eminent talent, always suffered from lack of repose and the lust of effect. Yet are they by far the most distinguished sculptors of the 17th century. In England nothing memorable was produced save the still-life of Grinling Gibbons (q.v.; 1648–1721); while Andreas Schlüter (1662–1714) best represents the art as it was pursued in Germany. The flamboyant style lived through the first half of the 18th century. A group of foreigners—Roubiliac, Scheemakers, and Rysbrack—practised their trade in England with a certain success. But the one great artist of the age was a Frenchman, Jean-Antoine Houdon (1741–1828). This distinguished artist, despite his education, avoided on the one hand the dry frigidity of effete classicism, on the other the cheap ingenuity of the imitators of Bernini. A naturalist, he never surrendered the dignity of his art to catch a fleeting resemblance. Above all he was from first to last a sculptor. His modelling is always large and simple; and though in his bust of Glück he attempted to reproduce the texture of a mottled skin, he was justified by the event. He was the greatest portrait-sculptor of his own or indeed of any age; he invented the type of Molière, and the great men of the great age live today as he created them. And then came Canova (1757–1822), who drove sculpture back into an antique channel. Neglecting the achievement of the Renaissance, he revived the Græco-Roman style with an insipid triviality, which has been a law to several generations of industrious workmen. In England Gibson, Macdowell, Chantrey, Wyatt, and a hundred others proceeded from Flaxman and the new classic school. In France Chaudet, Pradier, and Rude (by far the most accomplished of them all) neglected Houdon for Canova. Thorwaldsen, relying upon this false example, built up an amazing reputation, which is already shattered. A tasteless imitation, an incapacity to observe, a flabby modelling mark out the achievement of the whole school as a warning to sculptors, and serve to prove that salvation never came by an unthinking adherence to a dead tradition. The 19th century, however, has revolted against Canova and all his works. In Alfred Stevens, the author of the superb monument to the Duke of Wellington, who to a profound study of Michelangelo added an unfeeling sense of decoration, England found her greatest sculptor and the present generation has witnessed a sudden efflorescence. The France of to-day is also singularly rich in sculptors. Barye, the greatest *animalier* of modern times, belongs to a past generation, but, amid a mass of sculpture which is wholly unsculpturesque, the works of Dalou, Guillaume, and Rodin are evidence of a revival. M. Auguste Rodin exercises the most powerful influence. An artist of markedly individual talent and a master of technique, he would claim Donatello as his exemplar, but he has carried the art of sculpture further than the Florentine.

See Schnaase, *Geschichte der Bildenden Künste*, and Lübke's *History of Sculpture* (Eng. trans.); for Egyptian sculpture, Maspero's text-books; for Greek sculpture, Overbeck's *Geschichte der Griechischen Plastik*, Brunn's *Geschichte der Griechischen Künstler*, Murray's *History of Greek Sculpture*, and the works by Collignon (vol. i. Paris, 1892) and Furtwängler (1894; trans. 1895). W. B. Scott's *British School of Sculpture* will be found useful, as also Enéric David's *Histoire de la Sculpture Française*. For Italian sculpture the reader may refer to Mr C. C. Perkins's handbooks. See also the monographs cited in the articles on the great sculptors in this work.

Sculptured Stones, a general name given in Britain to a class of monuments of the early Christian period, many of them being mere unheavened stones, with sculpturings of rude inscriptions, or symbols, or ornamental designs, corresponding in style and patterns to the illuminated decorations of Celtic manuscripts of the Gospels. The rude stones erected for memorial purposes in pagan times (unless under Roman influence) are uninscribed and unornamented (see under **STANDING STONES**). The sculptured stones of Britain may be divided into two classes—those that are simply incised and those that bear sculpture in relief, the former being the earlier method. Sculptured stones of the incised or earlier class may be subdivided into two sections, inscribed or uninscribed, irrespective of their bearing symbols and ornamentation. The advantage of this division is that the inscribed monuments can be arranged in chronological order by their paleographical characteristics, and the uninscribed examples bearing similar symbols and ornamentation to those found on the inscribed examples will follow the same sequence. We know from paleographical data that the earliest lapidary inscriptions in Britain are in Roman capital letters, and that the minuscules, or small letters, do not make their appearance till about the 6th century. Hence we have a means of dividing the inscribed stones into an earlier and a later group according as they are written in capitals or minuscules, while those that are mixed or partly in capitals and partly in minuscules will represent the middle or transition period. But many of the inscribed monuments bear inscriptions which are written in a character peculiar to the British Isles, and known as Ogam (q.v.). Sometimes the Ogam inscription is associated with an inscription in Roman letters on the same stone, sometimes the monument bears an Ogam inscription only. In the latter case it is frequently associated with sculptured ornamentation in relief of the most advanced type, and therefore we have another means of dividing the inscribed stones into two groups, one of which is demonstrably later than the other. Of these four groups, which are (1) inscribed in Roman capitals only; (2) inscribed in Roman letters and in Ogam, or bilingual and biliteral; (3) inscribed in Ogam only; and (4) inscribed in Roman minuscules or small letters, the first and second have their chief development in Wales, and the third and fourth in Ireland.

Of the first group of sculptured stones there are sixty in Wales, twenty-three



Fig. 1.—The Cat Stane.

found in association with ancient ecclesiastical sites, and some bear also incised crosses of the

earliest known type. A well-known example is the Cat Stane near Kirkliston, Midlothian (fig. 1), which stands in a cemetery of early Christian graves, and bears the inscription, IN [H]OC TUMULO JACIT VETTA F[ILII] VICTI. One of a group of three at Kirkmadrine in Wigtonshire commemorates two priests, Viventius and Mavorius, probably of the church founded there by St Ninian in the 5th century. The greater purity of the forms of the letters and the style of the Latin of the inscriptions of this group indicates their closer proximity to the period of the Roman occupation. The characteristic of the second group of inscribed stones is that they bear two inscriptions, one in the Latin language and in Roman letters (capitals as a rule), and the other in the vernacular in Ogam letters, one inscription being always an echo of the other. Of these bilingual monuments there are eighteen in Wales, two in England (both in Devon), two in Ireland, and one in Scotland, at Newton of Garioch in Aberdeenshire. Two examples will show the general character of their inscriptions. One in Pembrokeshire has, in debased Latin capitals, SAGRANI FILI CVNOTAMI, reading from the top of the stone downwards on one face, and on one edge the answering inscription in Ogam letters, SAGRANI MAQI CVNOTAMI, *maqi* being the usual form in these inscriptions for son. Another in Carmarthenshire reads in Latin AVITORIA FILIA CVNIGNI, while the answering Ogam has AVITORIGES INIGINA CUNIGNI—*inigina* standing for daughter, and answering to the modern Gaelic *ingen*, as *maqi* answers to *mac*. The third group of inscribed monuments, those bearing Ogam only, lies chiefly in Ireland, where there are 186 examples. There are only twenty-two in Britain, of which twelve are in Scotland, six in Wales, and four in England. Twenty-three of the Irish examples are associated with early forms of the cross incised on the same stone. In Scotland six occur on stones bearing crosses or Celtic ornamentation of a late type, and in Wales six are on stones bearing incised crosses. From their nature these Ogam inscriptions are peculiarly difficult to decipher; but when the reading is clear they are usually of the same brief character as the bilingual inscriptions of the group previously described. The fourth group of inscribed monuments comprises those in minuscules or small letters of the Roman alphabet, chiefly in the forms of those letters adopted by the Irish scribes. Of such inscribed stones there are about 260 in Ireland, forty-two in Wales, twelve in England, and only three or four in Scotland. The largest group in Ireland is in the ancient cemetery of Clonmacnois, where there are over eighty examples, many of which can be dated by the names of the persons commemorated. They are chiefly undressed slabs laid flat on the graves, and incised sometimes with the inscriptions only, sometimes also with crosses, and more rarely with Celtic ornamentation. Of the names which can be identified from the Irish annals four belong to the 7th century, six to the 8th, twenty-eight to the 9th, eighteen to the 10th, and the same number to the 11th century. The earliest bear nothing but the inscriptions and plain crosses. Ornamentation does not begin to be added till the 9th century. In Ireland the inscriptions are usually in the vernacular, with the formula *oroid do*— and its contractions, or *oroid ar anmain*— and its contractions, meaning 'pray for —' or 'pray for the soul of —'. In Wales, however, the inscriptions of this group are usually in Latin. Though the majority of these stones are sepulchral monuments, others have been erected for different purposes, commemorative or terminal, to mark the boundaries of church lands or sanctuaries. In the Anglo-Saxon parts of Britain the inscribed stones bear

inscriptions in Anglian runes, and in the Isle of Man and the northern and western isles of Scotland, colonised from Scandinavia, the inscriptions are in Scandinavian runes. The monuments with Anglian runes are chiefly sepulchral slabs of small size, incised with a cross and the name of the deceased. In a few cases, however, they are great commemoration crosses, covered with sculptured ornamentation, and bearing elaborate inscriptions. The finest of these crosses are at Bewcastle (q.v.) in Cumberland and Ruthwell (q.v.) in Dumfriesshire. The shaft only of the Bewcastle cross remains, 14½ feet in height; the Ruthwell cross measures 17½ feet in height. Both are so similar in design and in style of ornamentation that they must be attributed to the same period. Both have long runic inscriptions—that on the Ruthwell cross being associated with a series of inscriptions in Roman capitals descriptive of the scriptural scenes carved on the panels of its two broad faces, while the runes are on the borders of the long panels on the sides of the cross, enclosing scrolls of foliage. They contain twenty-one lines of an Anglo-Saxon poem—'The Dream of the Holy Rood'—which was not known to exist in any other form until a South Anglian version was discovered in a manuscript at Vercelli in 1823, and attributed to Cynewulf, though Professor Stephens of Copenhagen maintains that a line of runes on the top of the cross, now obliterated by exposure, gave the authorship to Cædmon. The inscription on the Bewcastle cross is less legible, and has been read as recording its erection in honour of Alcfrith, king of Northumbria, in the 7th century, though the opinion is gaining ground that the dates of both these crosses must be placed considerably later than his time.

The monuments included generally under the name of the sculptured stones of Scotland are for the most part uninscribed. But they are profusely decorated (as will be seen from the annexed figure



Fig. 2.—Sculptured Stone at Nigg.

of one of the most ornate, at Nigg in Ross-shire), and their chronological place in the general group

of the early Christian monuments of Britain falls to be determined partly from the relations of their general system of ornamentation to that of the illuminations of the Celtic manuscripts of the Gospels of the 7th to the 10th and 11th centuries, and partly by the characteristics of the few inscriptions they do bear. Taken by themselves, they exhibit peculiar characteristics, which show that, although they form part of the general group which is peculiar to the British Isles, they have been affected by strong local influence. They present a peculiar set of symbols, not one of which is known to have occurred beyond the Scottish area, while the special form of the erected cross-bearing slabs, and the partiality to the representation of conventional beasts as part of their decoration, distinguish them from the English, Welsh, and Irish groups. The Scottish sculptured stones, of which over 370 are known, are divided into three varieties: (1) rude undressed pillar-stones or oblong boulders incised with unexplained symbols; (2) erect shaped slabs of headstone form, sculptured generally in relief, with a cross on one face and figure subjects and symbols on the other; and (3) high crosses with figure subjects and Celtic



Fig. 3.—Symbols on the Sculptured Stones of Scotland.

ornamentation similar to those of the cross-bearing slabs, but without the symbols. The rude pillar-stones of the first variety occur chiefly along the eastern side of Scotland from the Firth of Forth to the Orkney and Shetland Isles, being most numerous in the district between the Tay and the Spey. Outlying examples, however, occur as far south as Dumfriesshire and as far west as the outer Hebrides. The unexplained symbols incised on these stones are more easily represented than described. Those of most common occurrence are represented in fig. 3. Some of these are arbitrary symbols, to the development and meaning of which there is no clue. Others—such as the serpent, and the mirror and comb—are representations of existing objects, apparently used with a symbolic meaning. Some of the arbitrary symbols occur also on silver ornaments of the same period. On stones of the second variety, sculptured in relief, and presumably of later date, these symbols are associated with well-known symbols of the Christian faith, such as the cross and the fish, and with the ornamentation so characteristic of the illuminated pages of Celtic manuscripts of the Gospels. The figure subjects on the stones of this variety are partly scriptural and mostly related to the general cycle of early Christian symbolism. Among the scriptural subjects are the Temptation of our First Parents by the Serpent, Daniel in the Den of Lions, the Destruction of Pharaoh's Host in the Red Sea, the Raising of Lazarus, Jonah disgorged by the Whale, the Virgin and Child, &c. Along with these are hunting scenes, including the chase of the stag, wild boar, &c., and groups of animals evidently taken from the Bestiaries of the early middle ages, a species of natural history spiritualised, in which the characteristics of the various animals, real and fabulous, were set forth as symbolising the spiritual condition of man as related to the

scriptural plan of salvation (see **BESTIARY**). Of the third class of sculptured stones, the high crosses, there are but few in Scotland, and they are nearly all characterised by the presence of scriptural subjects. There are no data by which the age of the stones of the first variety, bearing only the incised symbols peculiar to Scotland, can be estimated. But there seems no reason for assigning to them a higher antiquity than that of the inscribed stones of the first and second classes, which seldom bear ornamentation or symbols, except the early form of the cross. The style of the ornamentation of the second variety, sculptured in relief and arranged in panels, is similar to the decoration of the illuminated Celtic manuscripts of the Gospels of the period ranging from the 7th to the 10th century. The third variety, consisting of high crosses with pure Celtic ornamentation, may range from the 10th to the 12th century. This form of monument—a high cross—with local variations and a remarkable development of foliage-ornamentation common to the recumbent sepulchral slabs of the same district, continued in the West Highlands from the 13th to the 16th century.

See *Stuart, Sculptured Stones of Scotland* (Spalding Club, 1856-67); *Westwood, Lapidarium Wallie* (1879); *Stokes, Christian Inscriptions in Ireland* (1878); *Anderson, Scotland in Early Christian Times* (1881); *Romilly Allen, Early Christian Symbolism* (1887); and *Monumental History of the Early British Church* (1889). See also the article **CEP-MARKINGS**.

Scurf. See **PITYRIASIS**.

Scurvy, or **SCORBUTUS**, is a disease characterised by a deprived condition of the blood. In consequence of this morbid state of the blood there is great debility of the system at large, with a tendency to congestion, hæmorrhage, &c. in various parts of the body, and especially in the gums. It has probably existed from the earliest times, but the first distinct account of it is contained in the history of the crusade of Louis IX. in the 13th century against the Saracens of Egypt, during which the French army suffered greatly from it. In the 16th century it prevailed endemically in various parts of the north of Europe, and it seems only to have abated towards the close of the 18th century. It was in badly-fed armies, in besieged cities, and on board ship that its ravages were most appalling, and it is believed that more seamen perished from scurvy alone than from all other causes combined, whether sickness, tempest, or battle. For instance, only 1512 sailors and marines were killed in all the naval battles of the Seven Years' War; but 133,708 died of disease or were missing, and scurvy was the principal disease. Whole crews were prostrated by this scourge, as in the well-known case of Lord Anson's (q.v.) memorable voyage. It is now met with under similar conditions, though cases are comparatively rare (in 1873 only 19 cases were reported to the Board of Trade, in 1881 as many as 90), and also among the lower classes in large towns, navvies engaged in railway work, &c., when they confine their dietary to tea, bread, ham, salt-fish, &c., to the exclusion of fresh vegetables and meat.

The first effect of the disease is generally a decline in the general health, and the patient becomes depressed, is easily fatigued, and has a peculiar sallow complexion. After a variable period the more characteristic symptoms appear, the chief of which are hæmorrhages and sponginess of the gums. The hæmorrhages closely resemble those of *Purpura* (q.v.), and occur into and under the skin, where they give rise to red or purple discolorations which change colour like the marks of bruises; into the muscles and other deeper tissues, where they cause brawny swellings; and into

internal organs or cavities. Hæmorrhage also frequently takes place from the mucous membranes of the nose and alimentary canal. The affection of the gums is still more characteristic, and is rarely absent, except in the very young or very old, who are without teeth. The gums are swollen, discoloured, detached from the teeth, and bleed extremely easily, while the breath becomes very fetid. This condition sometimes precedes but often follows the occurrence of hæmorrhage in other situations.

The cause of scurvy is now well known to be an improper dietary, and particularly an insufficient supply of fresh vegetable food. The disease is never known to have occurred in any one who had eaten freely and habitually of such articles of diet. Even preserved vegetables, if kept in a juicy condition, prevent the occurrence of the disease. In the absence of vegetables abundant fresh meat and in a less degree milk are antiscorbutic. But the most efficient protective if fresh vegetable food is not attainable is lemon or lime juice; and the constant use of the latter during long voyages undoubtedly prevents the occurrence of scurvy when it would otherwise be inevitable. It is more apt to affect those who are deprived of fresh air and sunlight, are mentally depressed, and have had their health enfeebled by previous disease. In what way the deprivation of fresh vegetables acts on the blood to produce scurvy is as yet unknown. Dr Garrod's theory, that the element wanting is a sufficient supply of potash salts, is not generally accepted; for it has never been proved that potash salts by themselves are sufficient to prevent the disease.

Although the virtues of lemon-juice in scurvy were known in England as far back as 1636, when John Woodhall, Master in Surgery, published *The Surgeon's Mate, or Military and Domestic Medicine*, this invaluable medicine was not made an essential element of nautical diet till 1795, the author of the change being Sir Gilbert Blane (q.v.). The effect of this official act may be estimated from the following numbers. In 1780 the number of cases of scurvy received into Haslar Hospital (a purely naval hospital) was 1457, while in 1806, as also in 1807, there was only one case. Many naval surgeons of the present day have never seen a case of the disease. The potato possesses almost equally great antiscorbutic properties, and fortunately potatoes when cooked are as active as when taken raw. Dr Baly (1814-61), to whom we are indebted for this discovery, states that 'in several prisons the occurrence of scurvy has wholly ceased on the addition of a few pounds of potatoes being made to the weekly dietary.' For the cure, as for the prevention of the disease, the diet is by far the most important agent; lime, lemon, or orange juice should be given freely. Sometimes the condition of the mouth prevents the administration of potatoes and other vegetables; but when possible they should be given freely. Washes of chlorate of potash, tannin, or Condy's fluid should be used for the gums; if they are severely affected solid nitrate of silver may be applied to them with advantage.

Scurvy-grass (*Cochlearia*), a genus of plants of the natural order Crucifera, having small white flowers and many-seeded pouches. They are annual or biennial, rarely perennial plants; of humble growth, with branched smooth stems, smooth simple leaves, and terminal racemes of flowers. They have an acid, biting taste, containing the same pungent volatile oil which is found in horseradish, and are valued for their antiscorbutic properties. Common Scurvy-grass (*C. officinalis*) is sometimes a foot high; the root-leaves are

stalked and heart-shaped, the pouches globose, ovate, or elliptical. It is a variable plant, and some of the other species described by botanists are probably not essentially different. They possess the same properties. Scurvy-grass is very common on the shores of Britain, growing both on rocks where there is little soil and in muddy places. It is also found on high mountains. It is a very widely distributed plant, and, being found on the shores of almost all temperate parts of the world, has often been of great benefit to sailors in times when the modern precautions against scurvy at sea were unknown.

Scutage, or ESCUAGE (Lat. *scutum*, 'shield'), a pecuniary fine or tax sometimes levied by the crown in feudal times as a substitute for the personal service of the vassal.

Scutari (Italian or Levantine form of the Turkish *Üsküdar*), (1) a town of Asiatic Turkey, on the eastern shore of the Bosphorus, immediately opposite Constantinople, of which it is considered a suburb. It is built on the slopes of a hill, and bears a great resemblance to the Turkish capital, though its streets are wider. It contains several handsome mosques, bazaars, and baths, a royal seraglio, and a college of howling dervishes, and manufactures silks and cotton fabrics and leather goods. It has long been famed for its extensive cemeteries, adorned with magnificent cypresses, the chosen resting-place of many of the Turks of Constantinople from attachment to the sacred soil of Asia. The population is variously estimated at from 40,000 to 60,000. During the Crimean war the enormous barracks built by Sultan Mahmud on the southern outskirts of the town were occupied as barracks and hospital by the English troops, and formed the scene of Miss Nightingale's labours. On the cliffs bordering the Sea of Marmora stands a marble obelisk marking the site of the densely-filled English burial-ground. A white tower (90 feet high) near the shore, now used as a lighthouse, is known as Leander's Tower (see HERO). Scutari is the rendezvous and starting-point of caravans and travellers for the interior of Asia Minor. It occupies the site of the ancient *Chrysopolis*; and about two miles to the south lies the village of Kadiköi, the ancient *Chalcedon*.

(2) A town of European Turkey, situated at the southern end of the Lake of Scutari, in Northern Albania, 16 miles from the Adriatic, with which it is connected by the river Bojana. It is overlooked by an old Venetian citadel on a commanding height, has manufactories of arms and cotton goods, and carries on a considerable trade, especially in wool and skins. Pop. 25,000, of whom one-third are Greek Christians. They have here a cathedral and a bishop.

Scylla and Charybdis, according to the Homeric legend, were two sea-monsters who dwelt on opposite sides of a narrow sea-strait. Scylla possessed twelve feet, six long necks and mouths, each with three rows of sharp teeth, and barked like a dog. Charybdis thrice every day sucked down the water of the sea, and thrice threw it up again; she dwelt under a cliff on which grew a conspicuous fig-tree. Ulysses passed between these voracious monsters, and Scylla snatched six seamen from his ship. There are other versions of the myth. In later times the names were applied to a couple of 'races' or rapids in the Strait of Messina, Scylla being the one next the Italian shore. From the supposed difficulty of navigating the strait without getting into the one or the other of these dangerous spots arose the proverbial 'To shun Charybdis and fall into Scylla.' But the dangers of these 'races' have been very greatly exaggerated.

Scythe. See REAPING.

Scythians, a nomad race of Asia known to the ancient writers. The name bore two significations, meaning (1) the Scythians proper or Scolots, (2) all the nomad tribes (Sacæ, Sarmatians, Massagætæ, Scolots) who dwelt in the steppes from what is now Hungary to the mountains of Turkestan. Some modern authorities believe them (the Scythians proper) to have been of Mongolian origin; but the evidence for their having been Aryans, akin to the Sarmatians and to the Thracians, is growing steadily stronger. They inhabited the vast treeless plains that stretch from the Danube north-east and east to the Volga, were nomads, keeping herds of horses, cattle, and sheep, lived in tent-covered wagons, fought with bows and arrows on horseback, made drinking-skulls of the heads of their slain enemies, were filthy in their habits, never washing, and worshipped without images various gods like those of the Aryan Greeks. From the Greek colonies established north of the Euxine they learned something of the arts of civilisation; one of their kings, Anacharsis (q.v.), even went to Athens to learn at the feet of Solon. In the 7th century B.C. the Scythians (i.e. some of the nomad races of the steppes) invaded Media, and were only got rid of after ten years' occupation by Cyaxares making all their chiefs drunk at a banquet, and then slaying them. About the same period (626) certain fair-haired men from the north invaded Palestine and Egypt; these have been identified with the Scythians, and were the same, in all probability, as the riders and bowmen of whom the prophet Jeremiah speaks (chap. iv.-vi.). In 515 Darius crossed the Hellespont and went north over the Danube into the country of the Scythians (Scolots); but the difficulties and dangers of the wholly unknown country compelled him to retreat, suffering heavy losses. Shortly after the middle of the 4th century the Scythians (Scolots) in Europe were subdued and in great part exterminated by the Sarmatians. The Scythians of Asia, however, after about 128 B.C. overran Parthia (Persia), routed several Parthian armies, and levied tribute from the Parthian kings. They founded also in the east of the empire the kingdom of Sacastane, so that that part of Asia was long known as Indo-Scythia. During the first century before and the first century after Christ hordes of Scythians, having overthrown the Bactrian and Indo-Greek dynasties of Afghanistan and India (125-25 B.C.), invaded Northern India; and there they maintained themselves with varying fortune for five centuries longer. Their kings were warm supporters of northern Buddhism; indeed an attempt has been made to show that Buddha was of Scythian descent. The Jats of India, and the Rajputs, have both been assigned the same ancestry. Greek influence told strongly on the Scythian conquerors; Greek was even used as the official language of several dynasties in Bactria and the Punjab.

See Rawlinson's and Sayce's editions of Herodotus; Mahaffy, *The Greek World under Roman sway* (1890); Fressl's *Skytho-Saken* (1886); Krause, *Tuisko Land* (1891); Zeuss, *Die Deutschen und ihre Nachbarstämme* (1837); Neumann, *Die Hellenen im Skythenlande* (1855); Müllenhoff and Cano, *Die Skythen* (1871).

Sea. All primitive peoples appear to have experienced a feeling of dismay when they braved the dangers of the sea. The great majority of the civilised nations of antiquity took but little interest in the physical phenomena of the ocean. The few facts that were known with reference to the sea were limited to maritime nations like the Phœnicians. Among the learned men of antiquity two views were held with reference to the distribution of land and water. The Homeric school—to which Eratosthenes and Strabo belonged—regarded the old world as a single island surrounded by the

ocean. The Ptolemaic school, on the other hand, looked on the Atlantic and Indian Oceans as enclosed seas like the Mediterranean, and held that the east and west points of the known world approached so close to each other that a ship sailing from Spain might easily reach the eastern coasts of Asia. This mistaken notion led, fourteen centuries after Ptolemy, to the discovery of America by Columbus. The discoveries of Columbus, Vasco da Gama, and Magellan, during the thirty years from 1492 to 1522, added a hemisphere to the chart of the world. These voyages doubled at a single bound all that was previously known of the surface of the globe, and in a special manner enlarged our knowledge of the sea. Down to the time of the *Challenger* and similar recent scientific expeditions all our knowledge of the sea might, literally speaking, be called superficial; it was limited to the upper layers of oceanic waters and to the shallower depths surrounding continents and islands. Owing to the recent introduction of improved apparatus and methods, the most profound depths of the ocean have been examined with precision and success, so that we now possess a large amount of definite information concerning the physical and biological conditions of all regions of the ocean.

Area.—The waters of the sea cover about 143,259,300 sq. m., or about five-sevenths of the surface of the earth. The areas of the main divisions of the ocean are estimated as follows:

	Sq. miles.	Per cent.
Pacific (from Arctic Circle to 40° S.).....	58,100,000	40.54
Atlantic (" " " ").....	30,150,000	21.04
Indian (southern boundary 40° S.).....	18,100,000	12.63
Southern (from 40° S. to Antarctic Circle).....	27,300,000	19.05
Arctic (within the Arctic Circle).....	5,000,000	3.49
Antarctic (within the Antarctic Circle)....	4,650,000	3.25
	143,300,000	100.00

Depth.—The solid globe or lithosphere, viewed as to its superficial aspect, may be regarded as divided into two great planes: one of these corresponds to the dry land or upper surface of the continental masses, and occupies about two-sevenths of the earth's surface; the other, corresponding to the abyssal regions of the ocean, is depressed over 2½ miles below the general level of the continental plane, and occupies about four-sevenths of the earth's surface. The transitional area, uniting these two planes, forms the sides or walls of the ocean basins, and occupies about one-seventh of the earth's surface. The depressed regions of the globe, represented by the ocean basins, are filled with sea-water up to within about 375 fathoms (2250 feet) of the general level of the continents, the average depth of the water in the ocean basins being on the other hand about 2080 fathoms (12,480 feet). Were the solid crust of the earth to be reduced to one uniform level by removing the elevated continental masses into the depressed abyssal areas, the surface of the earth would then be covered by a universal ocean or hydrosphere with a depth of about 2 miles. This depth of 2 miles below the present sea-level has been called by Dr Mill the mean sphere level. The average depths of the main divisions of the ocean are:

Pacific Ocean.....	2500 fathoms.	Southern Ocean.....	2200 fathoms.
Atlantic ".....	2300 "	Antarctic ".....	630 "
Indian ".....	2800 "	Arctic ".....	630 "

The greatest depth recorded is 5155 fathoms, in the South Pacific (1896), near the Kermadec Islands; the *Challenger* sounded in 4475 fathoms, in the North Pacific, north-west of the Caroline Islands. In the South Pacific a depth of 4428 fathoms was found just south of the Friendly Islands, and 4170 fathoms off the west coast of Chili. In the Atlantic the greatest depth is 4561 fathoms, off Porto Rico, West Indies. Ross records a sounding in the Antarctic Ocean where he found

no bottom at 4000 fathoms. By far the larger portion of the sea-floor lies between the depths of 1000 and 3000 fathoms, equal to nearly 78 per cent., while about 17½ per cent. is found in depths less than 1000 fathoms, and about 4½ per cent. in depths greater than 3000 fathoms. The bulk of water in the whole ocean is estimated at 323,800,000 cubic miles.

Temperature.—The temperature of the surface-waters of the ocean varies from 28° F. in the polar regions to 85° or 86° in equatorial regions. In many places the surface-layers are subject to great annual changes due to the seasons and the direction of the wind. The temperature of the water at the bottom of the ocean over the abyssal areas ranges from 32.7° F. to 36.8° F. In some large basins separated from each other by low ridges the temperature may differ to the extent of one or two degrees, but the temperature is apparently constant at any one spot throughout the year. The great mass of the ocean consists of cold water—i.e. of water below 40° or 45° F.; at a depth of little over half a mile the water in the tropics has generally a temperature below 40° F. In the open ocean the temperature usually decreases as the depth increases, the coldest water being found at the bottom. In enclosed or partially enclosed seas, cut off by barriers from the great ocean basins, the temperature remains uniform from the height of the barrier down to the bottom; for instance, in the Mediterranean the temperature is about 56° from 200 fathoms down to 2000 fathoms; in the Sulu Sea, 50.5° from 400 fathoms to 2500 fathoms; in the Celebes Sea, 38.6° from 800 fathoms to the bottom in 2600 fathoms. In regions where there are heavy rains, or where rivers pour fresh water into the sea, alternating layers of colder and warmer water have been observed within a hundred fathoms from the surface.

Circulation.—The circulation of oceanic waters is maintained by the action of the prevailing winds on the surface-layers. In the oceanic areas the prevailing winds are governed by the large anticyclonic areas situated towards the centres of the North and South Atlantic and North and South Pacific. The winds blow out from and around these anticyclonic areas. For instance, in the southern hemisphere the warm salt water of the tropical regions is driven to the south along the eastern coasts of South America, Africa, and Australia, till on reaching a latitude of between 50° and 55° S. it sinks on being cooled, and spreads slowly over the floor of the ocean to the north and south. A similar circulation takes place in the northern hemisphere, although much modified by the peculiar configuration of the land-masses; for instance, the cold salt water at 30° F. which occupies the deeper parts of the Arctic basin is largely made up of the dense Gulf Stream water, which sinks to the bottom on being cooled in the Norwegian Sea. The water evaporated from the sea-surface is borne to the land-masses and condensed on the mountain-slopes. It is estimated that over 6500 cubic miles of this water is returned to the sea by rivers annually, bearing along with it a burden of soluble salts and earthy matters in suspension; in this way the ocean has in all probability become salt in the course of ages. The saltiest waters are found in the regions of greatest evaporation; for instance, in the Red Sea, Mediterranean, and in the trade-wind regions of the great ocean basins. It has been shown that by the action of off-shore winds cold water is brought up from the deep sea to supply the place of the surface-water carried seawards off the west coast of Africa and America, and off Cape Guardafui on the east coast of Africa; and the absence of coral-reefs off these coasts is believed to be due to the great range and variation in the temperature of the water

thus produced. The present writer has shown that a similar vertical circulation takes place in the lochs of the west of Scotland.

Composition of Sea-water.—It is probable that every element is in solution in sea-water; the great majority are, however, present only in exceedingly minute traces. If the average density of sea-water be taken at 1027, pure water being 1000, then the following would represent the composition of 1000 cubic centimetres of sea-water :

Sodium chloride.....	28.9080
Magnesium chloride.....	4.0568
Magnesium sulphate.....	1.7665
Calcium sulphate.....	1.3425
Potassium sulphate.....	0.9193
Magnesium bromide.....	0.8809
Calcium carbonate.....	0.1257
Water.....	989.7073

1027.0000

Each base is probably in combination with each acid, so that there are really sixteen salts altogether from the mixture of the four bases and four acids. The total amount of sea-salts may vary greatly in different samples of sea-water, but it has been shown by hundreds of carefully conducted experiments that the ratio of the constituents of sea-salts is nearly everywhere constant, with one significant exception, that of lime, which is in slightly greater proportion in the water from the deeper parts of the ocean basins. Owing to the constant circulation in the ocean, the gases of the atmosphere, which are everywhere absorbed at the surface of the sea, are carried down to the greatest depths, and thus living organisms may flourish throughout the whole extent of the ocean. Nitrogen remains at all times and places nearly constant; not infrequently the proportion of oxygen is much reduced in deep water, owing to the processes of oxidation and respiration. Carbonic acid free or loosely combined is abundant, and plays a most important rôle in the economy of the ocean, combining with and rendering soluble normal carbonates of lime and magnesia to solution in the form of bicarbonates. Water, as is well known, is but slightly compressible, and almost any substance that will fall to the bottom of a tumbler of water will in time fall to the bottom of the deep ocean. Still the compressibility of water must not be neglected in oceanographical questions. In the deeper parts of the ocean the pressure amounts to four or five tons per square inch; hence, in an ocean with a depth of 5 miles, were the action of gravity suddenly to cease, the ocean waters would rise 500 feet above their present level from expansion. There is evidence of very extensive chemical action on some regions of the sea-floor, and it has been suggested that this action is much intensified by the great pressure in the deeper parts of the ocean. It is probable, however, that all the reactions here alluded to may be accounted for by the decomposition of organic substances on the seabed in the presence of the sulphates in sea-water, and the long periods of time to which the materials on the sea-bed have been exposed to the action of sea-water in regions where there is a slow rate of deposition.

Life.—The colour of pure sea-water is a light shade of blue; it has, however, frequently various shades of green and brown, owing to the presence of organisms and matters in suspension. It has been definitely established that life in some of its many forms is universally distributed throughout the ocean. It has long been known that marine plants and animals abound in the shallow waters surrounding continents and islands. Algae disappear from the sea-bed at depths between 100 and 200 fathoms, but a great abundance of animals have been procured in the greater depths. A

Challenger trawling in a depth of over a mile (1000 fathoms) yielded 200 specimens of living animals belonging to 79 species and 55 genera. A haul in about two miles (1600 fathoms) yielded 200 specimens belonging to 84 species and 75 genera. A trawling in about three miles depth (2600 fathoms) yielded 50 specimens belonging to 27 species and 25 genera, not counting Protozoa. Even in depths of over four miles fishes and animals belonging to all the chief invertebrate groups have been procured. The term 'Benthos' is now used for all the animals and plants which live attached to or creep over the bottom of the ocean, 'Plankton' being the term for all the plants and animals which live in, and are carried along by the currents of the ocean. In the great body of oceanic waters life is most abundant in the surface and sub-surface waters down to about 100 fathoms. Pelagic algae, such as diatoms and oscillatoria, are abundant in this region, and are the principal and original source of food for many pelagic and nearly all deep-sea animals. In the intermediate depths of the ocean life though present is less abundant. Within a few hundred fathoms of the bottom life again becomes more abundant, crustaceans and cuttle-fish being especially numerous. A very large number of the organisms which belong to the pelagic Plankton, such as diatoms, radiolaria, foraminifera, and molluscs, secrete silica or carbonate of lime to form their shells and skeletons: these in falling to the bottom after the death of the organisms make up a large part of the marine deposits in many regions of the ocean.

Deposits.—The explorations of the *Challenger* and other expeditions have resulted in a great extension of our knowledge of marine sediments, especially of those now forming in the deep sea. All marine deposits may be divided into two classes—viz. those made up principally of the debris from the solid land of the globe, laid down in greater or less proximity to the shores of continents and islands, called 'terriginous' deposits, and those in which this continental debris is nearly or quite absent, laid down in the abyssal regions of the ocean, called 'pelagic' deposits. Commencing with the former, there are first the littoral and shallow-water deposits, forming around the land-masses from the shore down to a depth of about 100 fathoms, consisting of sands, gravels, and muds derived almost entirely from the disintegration of the neighbouring lands. The littoral deposits, laid down between tide-marks, cover about 63,000 sq. m., and the shallow-water deposits, between low-water mark and 100 fathoms, about 10,000,000 sq. m. Proceeding seawards from an average depth of about 100 fathoms, the deposits gradually change in character, the proportion of land detritus decreasing, while the remains of oceanic organisms increase in abundance, until at a considerable distance from land and in comparatively deep water the terrigenous deposits pass insensibly into truly pelagic deposits. The terrigenous deep-sea deposits—i.e. those formed at depths greater than 100 fathoms—may be briefly summarised as follows:

Blue Mud, the most extensive, is grayish or bluish in colour, with usually a thin reddish upper layer, and is characterised by the presence of fragments of rocks and mineral particles coming from the disintegration of the land, of which quartz is the principal species; the remains of marine organisms may be present in varying proportions, increasing with depth and distance from the land. Blue mud is found along the coasts of continents and continental islands, and in all enclosed and partially enclosed seas; in some places, as in the Yellow Sea, but notably off the coast of Brazil, the mud may be of a red colour from the large

amount of ferruginous matters brought down by the rivers, and it is then called Red Mud. Blue mud is estimated to cover about 14,500,000 sq. m. of the earth's surface—4,000,000 in the Arctic, 3,000,000 in the Pacific, 2,500,000 in the Antarctic, 2,000,000 in the Atlantic, 1,300,000 in the Indian, and 1,500,000 in the Southern Ocean. Red mud covers about 100,000 sq. m. off the coast of Brazil.

Green Mud and Sand are similar to the blue muds, but are characterised by the presence of the mineral glauconite in isolated grains or in small concretions; the dead shells of calcareous organisms are usually filled with the glauconite, which gives the green colour to the deposits. The sands occur in the shallower water nearer the coast, and in them the grains are larger than in the muds. These deposits are found usually off high and bold coasts where no very large rivers enter the sea; for instance, off the east coast of Australia, off South Africa, and off the west coast of North America. Green mud and sand cover about 850,000 sq. m.—300,000 in the Atlantic, 250,000 in the Pacific, 150,000 in the Indian, 90,000 in the Southern, and 60,000 in the Antarctic.

Volcanic Mud and Sand are deposited around the oceanic islands of volcanic origin, and the name is derived from the presence of fragments and particles of volcanic rocks and minerals, which are larger and more numerous nearer the islands, when the deposit is called a sand, becoming smaller and mixed with a larger percentage of pelagic organic remains in the deeper water farther removed from the coast, when the deposit is called a mud. Volcanic mud and sand cover about 600,000 sq. m.—300,000 in the Pacific, 200,000 in the Atlantic, and 100,000 in the Indian Ocean.

Coral Mud and Sand occur similarly around the oceanic coral islands and off those coasts and islands fringed by coral-reefs, and are characterised by the greater or less abundance of coral fragments from the reefs. The sands are found in the shallower water nearer the reefs, as in the case of the volcanic sands. Coral mud and sand cover about 2,557,000 sq. m.—1,417,000 in the Pacific, 760,000 in the Atlantic, and 380,000 in the Indian Ocean.

Of pelagic deposits there are five types, four of organic origin, receiving their designations from the distinctive presence of the remains of calcareous or siliceous organisms, the fifth and most extensive being of inorganic origin.

Globigerina Ooze is so called from the presence of the dead shells of pelagic Foraminifera, those belonging to the genus *Globigerina* predominating, which live in the surface and sub-surface waters of the ocean, being especially abundant in tropical regions, and the shells of which after death fall to the bottom and there accumulate in moderate depths. The percentage of carbonate of lime in the deposit due to these shells and other calcareous fragments varies from 30 to over 90, and there is usually an admixture of minute mineral particles and remains of siliceous organisms. The depth at which *Globigerina* ooze is found varies from less than 500 to over 2500 fathoms, the average depth being about 2000 fathoms; but there is a marked difference between a sample collected in comparatively shallow water near land and one from deep water towards the central regions of the ocean basins, the point of union being the presence of a considerable proportion of carbonate of lime shells. *Globigerina* ooze covers about 49,520,000 sq. m.—17,940,000 in the Atlantic, 11,300,000 in the Pacific, 10,560,000 in the Southern, and 9,720,000 in the Indian Ocean.

One of the facts brought out by recent oceanographical researches is the gradual disappearance of these calcareous shells from the deposits of the

deep sea with increasing depth in regions where they may appear to be equally abundant at the surface. In depths of over 3000 fathoms these shells are rare, and often there is not a trace of carbonate of lime even in lesser depths, the *Globigerina* ooze being then replaced by one of the other kinds of pelagic deposits.

Pteropod Ooze resembles *Globigerina* ooze in all respects, except that there is a greater abundance of the dead shells of pelagic Mollusca, such as Pteropods and Heteropods; it is usually found in lesser depths than the *Globigerina* ooze. Pteropod ooze covers about 400,000 sq. m. in the Atlantic.

The names applied to these oozes are not intended to convey the idea that they are wholly made up of the organisms indicated by the names, or that these organisms form a preponderating proportion, for no deep-sea deposit can be said to be strictly homogeneous. Neither is there a sharp dividing line between the various kinds of deposits; they merge insensibly the one into the other. Often it is difficult to locate a sample, one or other of the names being equally applicable.

Diatom Ooze is distinguished by the presence of numerous remains of siliceous organisms, principally Diatoms, though fragments of siliceous Sponge spicules and Radiolaria and Foraminifera are rarely absent. It is found in the Antarctic and Southern Oceans and also in the north-west Pacific. Diatom ooze covers about 10,880,000 sq. m.—10,000,000 in the Southern, 840,000 in the Antarctic, and 40,000 in the Pacific.

Radiolarian Ooze in like manner contains a varying proportion of siliceous remains, in this case principally Radiolaria and their fragments. Calcareous organisms and mineral particles are nearly always present in both these oozes, being usually more numerous and the mineral particles larger in the Diatom ooze than in the Radiolarian ooze, which latter generally occurs in greater depths than the former. The *Challenger's* deepest sounding, already mentioned, brought up a typical Radiolarian ooze, and it is found in the deeper water of the central Pacific and Indian Oceans. Radiolarian ooze covers about 2,290,000 sq. m.—1,161,000 in the Pacific, and 1,129,000 in the Indian Ocean.

Red Clay occupies nearly the whole of the deeper abysses of the ocean, occurring in its most characteristic form in the central regions of the Pacific, far removed from continental land. It is of a reddish or chocolate colour, due to the presence of the oxides of manganese and iron. Fragments of calcareous organisms are sometimes tolerably abundant in the shallower depths, but in a typical red clay there is usually not more than a trace of carbonate of lime. Siliceous remains are generally present, and there is a small proportion of minute mineral particles of volcanic origin, principally derived from disintegrated pumice. Mineral particles of secondary origin, arising from the decomposition of volcanic debris, are associated with the red clay, and in some regions of the central Pacific isolated crystals and spheroidal groups of phillipsite of secondary origin formed *in situ* make up a considerable quantity of the deposit. Concretions of manganese and iron are very characteristic of the red clays, and may be of all sizes, sometimes a large quantity of the size of marbles, and sometimes the size of potatoes, being procured. These concretions are formed around various nuclei, such as sharks' teeth, earbones of whales, and pieces of pumice. The *Challenger* sometimes procured over one thousand sharks' teeth and sixty earbones of whales in a single haul. The presence of the remains of vertebrates, some of them belonging to extinct species lying alongside others belonging to existing species, as well as the formation of

manganese nodules and zeolitic crystals *in situ*, and the presence of metallic and chondritic spherules of cosmic origin, appear to indicate that the red clay accumulates at a very slow rate. Red clay covers about 51,500,000 sq. m.—37,230,000 in the Pacific, 5,800,000 in the Atlantic, 4,350,000 in the Southern, and 4,120,000 in the Indian Ocean.

See the articles in this work on the Arctic, Antarctic, Atlantic, Pacific, and Indian Oceans; those on the Red Sea, Dead Sea, &c.; also CHALLENGER EXPEDITION, GULF STREAM, GEOGRAPHY, PHOSPHORESCENCE, POLAR EXPLORATION, SAND, SOUNDING, STORMS, TIDES, WAVE, WIND, WRECK.

THE SOVEREIGNTY OF THE SEA.—Blackstone lays it down that the main or high seas are part of the realm of England, as the Courts of Admiralty have jurisdiction there. But the law of nations, as now understood, recognises no dominion in any one nation over the high seas, which are the highway of all nations, and governed by the public law of the civilised world. Such a right has, however, long been claimed over the four seas surrounding the British Isles. It was strongly asserted by Selden, and denied by Grotius, and measures were taken to vindicate the right in the reign of Charles I. The Dutch claimed the supremacy of the seas in Cromwell's time, but were worsted by Blake (q.v.). Every nation has undoubtedly a right to the exclusive dominion of the sea within a certain distance from the shore, now fixed at three miles. This right of lordship includes the right to free navigation, to fishing, to taking wrecks, the forbidding passage to enemies, the right of flag, of jurisdiction, &c. By the law of England the main sea begins at low-water mark; and between low and high water mark the common law and admiralty have a divided jurisdiction, one on land when left dry, the other on the water when it is full sea. The right of seal-fishing in the Behring Sea has been the subject of lengthened diplomatic controversy and arbitration between the United States and Great Britain (see SEAL). For inshore fishery regulations, see FISHERIES. See further INTERNATIONAL LAW, BLOCKADE, ENEMY, NEUTRALITY, SEASHORE; also RULE OF THE ROAD.

Sea Anemone. See ANEMONE. In like manner for Sea-bream, Sea-otter, &c., see BREEM, OTTER, &c.

Sea-bass, a name applied to some perch-like marine fishes—e.g. *Cynoscion nobilis*, an important food-fish on the western coasts of North America; *Pogonias chromis*, abundant off the coasts of Carolina, Florida, and the Gulf of Mexico; *Centropristis fulvus* and *atrarius*, along the eastern coasts of North America.

Sea-bat (*Platax*), a genus of Teleostean fishes allied to the Pilot-fish, and included among the Carangidae or horse-mackerels. The name refers to the very long dorsal, anal, and ventral fins.

Sea-beaches. See BEACHES.

Sea-bear. See SEAL.

Sea-birds, PRESERVATION OR PROTECTION OF. See WILD-FOWL.

Sea-blubber. See JELLY-FISH.

Sea-Buckthorn, or SALLOW-THORN (*Hippophaë*), a genus of the natural order Elaeagnaceæ, consisting of large shrubs or trees with gray silky foliage and entire leaves. They have dioecious flowers: the perianth is tubular, becomes succulent, encloses an acheneum, and forms an acid fruit. There is but one known species, *H. rhamnoides*, sometimes called the Sea-Buckthorn, a large thorny shrub or low tree, a native of parts of the sandy seacoasts of England and the continent of Europe, which is found also throughout great part of Tartary. It is sometimes planted to form hedges near

the sea, growing luxuriantly where few shrubs will succeed. The berries are orange-coloured, and are



Sea-Buckthorn (*Hippophaë rhamnoides*): a, branch of the female plant, in fruit; b, branch of male plant, in flower.

gratefully acid. They are used for making fish-sauce, jellies, and condiments in some places.

Seabury, SAMUEL, the first Bishop of Connecticut, was born in that state, at Groton, 30th November 1729, graduated at Yale in 1748, studied medicine for a year at Edinburgh, and received deacon's and priest's orders in England in 1753. For some time he was a missionary of the S. P. G.; in 1757 he was promoted to the 'living' of Jamaica, Long Island, and ten years later to that of Westchester, New York. The Whigs, however, prevented his ministering, and once imprisoned him for six weeks at New Haven. He then removed to New York, where he made his medical knowledge contribute to his support, acted as chaplain of the King's American Regiment, and wrote a series of pamphlets which earned for him the special hostility of the patriots. In 1777 Oxford made him D.D. On 25th March 1783 the clergy of Connecticut met at Woodbury and elected Seabury bishop; and for sixteen months he waited vainly in London for consecration, the archbishops, though personally favourable, being timid and indisposed to move without the sanction of the civil authority. On 14th November 1784 he was consecrated in the upper room of a house at Aberdeen by Bishops Robert Kilgour, Arthur Petrie, and John Skinner, of the Scottish Episcopal Church, whose connection with the state had been severed nearly a century before. Bishop Seabury's jurisdiction embraced (by consent) Rhode Island as well as Connecticut, and he acted also as rector of St James's Church, New London. In 1792 he joined with three bishops of the English succession in consecrating a fifth, Bishop Claggett, through whom every American bishop derives from Seabury and the Scottish Church. Seabury's further services included the securing to the episcopate of its proper share in the government of the church, and the restoration of the oblation and invocation to the Communion Office (from the Scottish Office). He died 25th February 1796. See his *Life and Correspondence*, by Dr E. E. Beardsley (Boston, 1881; Lond.

'Eminent English Churchmen' series, vol. iii. 1884). The Seabury Centenary was celebrated in Aberdeen (October 7) and at St Paul's Cathedral (November 14) in 1884.

Sea-cat. See WOLF-FISH, CHIMERA.

Sea-cow. See MANATEE, RHYTINA.

Sea Cucumber. See HOLOTHURIANS.

Sea-devil. See DEVIL-FISH.

Sea-eagle. See EAGLE, OSPREY.

Sea-elephant. See ELEPHANT-SEAL.

Sea-fan. See GORGONIA.

Seaford, a small and ancient watering-place on the Sussex coast, 3 miles E. of Newhaven by rail. It was a dependency of the Cinque Port of Hastings in the 15th century; and when it was disfranchised in 1832, had long been notorious for electoral corruption. Of late it has grown in size and prosperity. Pop. (1851) 997; (1891) 2425.

Seaforth, LOCH, an arm of the sea, 14 miles long, on the east side of the island of Lewis-with-Harris (q.v.) in the Hebrides, which long gave the title of Earl (attainted in 1716) to the family of Mackenzie.

Sea-fox. See FOX-SHARK.

Sea-grape (*Ephedra*), a genus of shrubby plants of the natural order Gnetaceae, closely allied to the Conifers, and sometimes called Joint-firs. The most notable is *E. distachya*, a small shrub very abundant in southern Russia, which produces sweetish mucilaginous berries, in some pharnacopœias called *Uva maritima*, which are eaten by the Russian peasants. In medicine they are regarded as astringent, and are used in putrid fevers and agues. The young tops of the shoots are also astringent.—The name of sea-grapes is also given to the grape-like clusters of eggs laid by *Sepia* and some other cuttle-fish.

Sea-grass, a name for Grasswack (q.v.).

Seagull. See GULL.

Seaham Harbour, a seaport in the county of Durham, 6 miles S. of Sunderland. Founded in 1828 by the Marquis of Londonderry, it communicates by railway with neighbouring collieries, and has every facility in the way of docks and quays for the shipment of coal. There are also bottle-works, blast-furnaces, an iron-foundry, and chemical works, a seamen's infirmary (1849), and the Londonderry literary institute (1853). Pop. (1851) 3538; (1891) 8856.

Sea-hare, a name given to the genus *Aplysia* of nudibranch Gasteropods. See GASTEROPODA.

Sea-hedgehog. See GLOBE-FISH.

Sea-hog. See PORPOISE.

Sea-holly. See ERYNGO.

Sea-horse. See HIPPOCAMPUS, WALRUS.

Sea-kale (*Crambe maritima*; see CRAMBE), a perennial plant with large roundish sinuated sea-green leaves, found on the seashores in various parts of Europe, and in Britain. The blanched sprouts have become a very favourite esculent in Britain. It is commonly forced in the winter months in dark sheds or pits heated with fermenting manure or leaves, or with hot water circulating in pipes. The plants when to be treated thus are reared annually from cuttings of the roots or from seed; the latter is sown in March in rows 18 inches asunder, the seed being dropped, three or four together, at 15 inches apart, the seedlings to be thinned to one at each point. The cuttings are dibbled into the ground at the same distances apart, and by liberal cultivation they are quite strong enough to be forced the following winter. Of course the roots are lifted when to be forced in this way, and are thrown away afterwards. When they

are to be blanched in the position in which they grow the rows are planted at 3 feet by 2 feet apart, the plants are covered with pots or boxes, which are also covered with leaves, tan, spent hops, or mildly fermenting manure. Plantations treated in this way last for several years. Darkness is essential to the proper blanching of the sprouts.

Seal (Lat. *sigillum*, Fr. *seau*), an impression on wax or other soft substance made from a die or matrix of metal, a gem, or some other material. The stamp which yields the impression is sometimes itself called the seal. In Egypt seals were in use at an early period, the matrix generally forming part of a ring (see GEM, RING). Devices of a variety of

sorts were in use at Rome, both by the earlier emperors and private individuals. The emperors, after the time of Constantine, introduced *bulles* or leaden seals, and their use was continued after the fall of the western empire by the popes, who attached them to documents by cords or bands. On the earlier papal seals are monograms of the pope; afterwards the great seal contained the name of the pope in full and a cross between the heads of St Peter and St Paul, while the papal privy-seal, impressed not on lead but on wax, known as the *Seal of the Fisherman*, represents St Peter fishing. In the 9th and 10th centuries we find Charlemagne, the Byzantine emperors, and the Venetian doges occasionally sealing with gold, and we have an instance as late as the 16th century of a gold seal appended to the treaty of the Field of the Cloth of Gold, between Henry VIII. and Francis I.

The most complete series of royal seals is that of the kings of France, beginning with the Merovingian dynasty. Seals were not much used in England in Anglo-Saxon times, but they came into general use after the Norman Conquest. The earliest regular great seal is that of Edward the Confessor, modelled on the contemporary French pattern. On the royal great seals was the king in armour on a caparisoned horse galloping, his arms being shown on his shield after the period when arms came into use; and the reverse represented the king seated on a throne. The great seals of Scotland begin with Duncan II. in the end of the 11th century, and have also for subject the king on horseback; the counterseal, with the seated figure, being used first by Alexander I., and the earliest appearance of the arms of Scotland being on the seal of Alexander II. In both countries there were also the privy-seals with the royal arms only.

Ecclesiastical seals first appear in the 9th century, and attained great beauty in the 13th and 14th. They are of the pointed oval form known as *Vesica piscis*, and have for subjects a figure of the bishop, sometimes of the Trinity, the Virgin, or a patron saint, seated under an elaborate architectural canopy. The arms of the bishop are often added.

Under the Norman monarchs of England sealing became a legal formality necessary to the authentication of a deed; and from the 13th century onwards the seals of all persons of noble or gentle



Sea-kale
(*Crambe maritima*).

birth represented their armorial ensigns. The seal was generally appended to the document by passing a strip of parchment or a cord through a slit in its lower edge; and the ends being held together, the wax was pressed or moulded round them a short distance from the extremity, and the matrix impressed on it. Occasionally the seal was not pendent, but the wax was spread on the deed. The coloured wax with the impression was sometimes imbedded in a mass of white wax forming a protective border to it. In England a seal is still an essential to all legal instruments by which real

estate is conveyed; but since subscription has also become necessary the practice of sealing has degenerated into a mere formality. The custom was gradually introduced of covering the wax with white paper, on which the impression was made, and latterly wafers have been considered a sufficient substitute for seals. In Scotland, where sealing is not now required (see DEED), every freeholder was obliged by statutes of Robert III. and James I. to have his seal of arms; and among the Scottish armorial seals of the 14th and 15th centuries are some of wonderful beauty of execution. In most of



Great Seal of William the Conqueror.

the states of the American union neither wax, wafer, nor anything corresponding to a seal is required for deeds.

The use of corporate seals by towns and boroughs dates as far back as the 12th century. The earlier corporate seals bear the town gates, city walls, or some similar device; the use of corporate arms did not begin till the later half of the 14th century. The study of mediæval seals is of great importance and interest in connection with many branches of archæology, including heraldic and genealogical investigations. Seals are still customarily appended to various kinds of formal and official documents, ecclesiastical, academic, masonic, &c.

The *Great Seal*, the specific emblem of sovereignty, is appended only to the most important class of public documents, such as writs for summoning parliament, treaties, and official acts of state. A new one is made for each new sovereign (or on occasion of a change of arms or style), the old one being solemnly broken. The original custodian of the English seal was the Lord Chancellor (q.v.), but by-and-by the seal was frequently put into the charge of a special official called the Lord Keeper (q.v.). Since 1757 the Chancellor is the only keeper of the Great Seal; though the seal may be put into Commission, and entrusted for the time to Lords Commissioners. It was long a rule that the Great Seal should not be used for any document without prior authority under the Privy-seal (see below). When in 1642 the Lord Keeper (Littleton) joined Charles I. at York, he carried the Great Seal with him; whereupon the parliament (illegally, no doubt) ordered a new one to be made. Charles II. had one made for himself after his father's death. James II. on his flight threw the Great Seal into the Thames opposite Lambeth, but it was soon recovered. At the union with Scotland it was provided there should be only one Great Seal for Great Britain; but a

seal is provided to be used in Scotland for grants concerning offices, commissions, and private rights in that kingdom only. This seal is commonly called, for brevity, the Great Seal of Scotland, and is now held *ex officio* by the Secretary of State for Scotland. No special provision was made after the union with Ireland.

The *Privy-seal* is the seal appended to grants which are afterwards to pass the Great Seal, and to documents of minor importance which do not require the Great Seal. The officer who has the custody of the Privy-seal was at one time called the Keeper, and afterwards the Lord Privy-seal. The Lord Privy-seal is now the fifth great officer of state, and has generally a seat in the cabinet. His office is conferred under the Great Seal during pleasure. Since the reign of Henry VIII. the Privy-seal has been the warrant of the legality of grants from the crown, and the authority for the Lord Chancellor to affix the Great Seal. Such grants are styled letters-patent, and the office of the Lord Privy-seal is one of the departments through which they must pass to secure their validity. Until recently all letters-patent for the grant of appointments to office under the crown, of patents of invention, charters, naturalisations, pensions, creation of honours, pardons, &c. required to pass from the Signet Office to the Privy-seal Office, in the form of Signet bills, verified by the Signet Seal and superscription; and on the Privy-seal being attached to them they were forwarded to the Lord Chancellor, by whom the patents were completed in the office of the Great Seal. By the Act 47 and 48 Vict. chap. 30, it is now unnecessary for any instrument to be passed under the Privy-seal, a warrant under the royal sign-manual duly countersigned being sufficient authority for passing any instrument under the Great Seal. There is a Privy-seal in Scotland, which is used to authenticate royal

grants of personal or assignable rights. Rights such as a subject would transmit by assignation are transmitted by the sovereign under the Privy-seal. Several other minor seals are still in use in Scotland; the Quarter Seal, known also as the Testimonial of the Great Seal, pertaining to the Director of Chancery; the Signet, mainly used in initiating proceedings in the Supreme Court; and various Seals of Court.

See also the articles BULL, GEM, RING, DEED; and A. B. Wyon, *Great Seals of England* (1888).

Seal, the name commonly applied to all the Pinnipedia except the Morse or Walrus (q.v.). The Pinnipedia have many of the essential characters of the Carnivora (dogs, cats, lions, bears, &c.), in which order they are, therefore, classified. They may accordingly be described as carnivorous mammals adapted to a marine existence. They are not, however, so completely marine as the Cetacea, but pass part of their lives and perform certain functions—viz. the reproductive—on shores or on ice-fields. The structural peculiarities of the Pinnipedia are the following: The brain-case is smooth and rounded, the face small and short. The supraorbital processes are largely developed. The external ear is wanting altogether or very small. The skin is well covered with hair, which takes the form of fur in some species. The limbs are modified to form paddles for swimming, but still are capable of use in climbing out of the water and moving somewhat clumsily on land. The upper divisions of the limbs are shorter than the lower, and do not project beyond the skin of the body. There are five toes on each limb, and all are united together by strong webs extending to the extremities. The inner toe of the fore-foot is largest, the rest gradually decreasing, while in the hind-foot the inner and outer toes are both very long, and the intermediate ones somewhat shorter. The nails are straight, and may be reduced in number or wanting. The incisor teeth are pointed, and vary in number in the different genera. The molars and premolars are similar, and have not more than two fangs. There is a short, small tail, which is united beyond its middle to the hind-legs by the skin. The toes, particularly those of the hind-feet, are capable of being spread out very widely in swimming, so as to give great propulsive power.

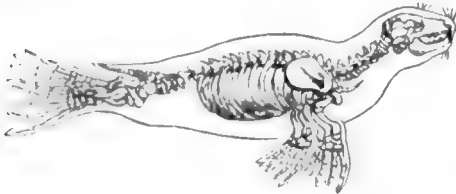

skeleton of Seal, with outline of the figure.

The movements of seals in the water are very rapid and graceful; on land they are very peculiar, even the fore-feet in the Phocidæ being little used, but the body contracted by an upward bending of the spine, and so thrown forward by a succession of jerks; in which way, however, a seal makes its escape very rapidly from an assailant. The flexibility of the spine in seals is very remarkable, and depends on the very large intervertebral cartilages, formed of fibrous concentric rings. The muscles, which are connected with the spine on all sides, are of great strength. Seals have a remarkable habit of swallowing large stones, for which no probable reason has yet been conjectured. Their stomachs are very often found to be in part filled with stones. The stomach is quite simple; the

gullet (*œsophagus*) enters it at the left extremity; the cæcum is short, the intestinal canal long.

The respiration of seals is extremely slow, about two minutes intervening between one breath and another, when the animal is on land and in full activity. A seal has been known to remain twenty-five minutes under water. Their slowness of respiration, and power of suspending it for a considerable time, is of great use, as enabling them to pursue their prey under water. The fur of seals is very smooth, and abundantly lubricated with an oily secretion. There is in some species an inner coating of rich fur, through which grow long hairs, forming an outer covering. Another adaptation to aquatic life and cold climates appears in a layer of fat immediately under the skin—from which *Seal Oil* is obtained—serving not only for support when food is scarce, but for protection from cold, and at the same time rendering the whole body lighter. The nostrils are capable of being readily and completely closed, and are so whilst the seal is under water; and there is a similar provision for the ears; whilst the eye, which is large, exhibits remarkable peculiarities, supposed to be intended for its adaptation to use both in air and water. The face is provided with strong whiskers, connected at their base with large nerves. Seals produce their young only once a year; sometimes one, sometimes two, at a birth. Not long after their birth the young are conducted by the mother into the sea. Many of the species are polygamous. Terrible fights occur among the males.

Seals are very much on their guard against the approach of man where they have been much molested; but where they have been subjected to no molestation they are far from being shy, and approach very close to boats or to men on shore,

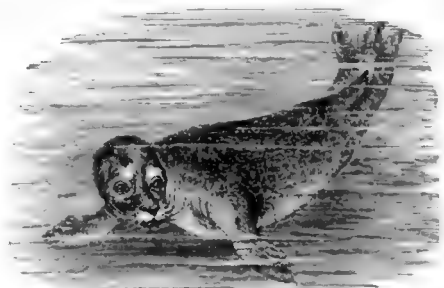

Common Seal (*P. vitulina*); attitude when swimming.

as if animated by curiosity. They are much affected by musical sounds. A flute is said to attract seals to a boat, where they have not learned caution from sore experience; and the ringing of the church bell at Hoy, in Orkney, has very often caused the appearance of numerous seals in the little bay. Seals possess all the five senses in great perfection. The common seal and some of the other species are very intelligent; but there is considerable difference in this respect among the species. The common seal and some others have often been tamed, and are capable of living long in domestication if freely supplied with water. They become very familiar with those who attend to them, are very fond of caresses and of notice, recognise their name like dogs, and readily learn many little tricks, of which advantage has been taken for exhibitions.

Seals, excluding the walrus, are divided into the two families Phocidæ, which have no external ears, and Otariidæ, which possess distinct though small representatives of these organs. The Otariidæ are, however, considered by modern



SEALS ON THE BEACH, ST. PAUL ISLAND, ALASKA.

specialists to be more closely related to the Walrus (*Trichecidæ*) than to the Phocidæ, notwithstanding the great tusks and peculiar dentition of the former. The Otariidæ, like the walrus, are capable of standing on all four legs, the hind-limbs being turned forward in walking on land, while in the Phocidæ the hind-limbs are trailed behind both on shore and in the water, and cannot be used to support the body when the animal is on land. The Earless Seals are commonly supposed to be monogamous, and, excepting the Sea-elephants, exhibit little difference in size between the sexes. They bring forth their young on shore or on ice-floes, but do not resort to special breeding-places nor remain for any length of time out of the water. The Eared Seals (the Phocidæ), on the other hand, are polygamous, and resort with invariable regularity to particular breeding-grounds, where they remain for months till the calves are able to travel; then they all depart and become pelagic for the rest of the year. The males are much larger than the females. The Common Seal (*Phoca* or *Callocephalus vitulina*) occurs on British coasts, and extends southward to the Mediterranean. It is common on the north-western shores of Europe and eastward along the arctic shores. It is very common in Greenland and on the arctic shores of North America, its southern limit on the western side of the Atlantic being New Jersey. On the east side of the Pacific it extends from southern California to Behring Strait, and probably occurs also on the western shores of the North Pacific. This species is always found on shores and not on ice-floes. It is hunted in Newfoundland and Greenland for its skins, which are much valued, though the covering is hair, not fur, and for its oil and flesh; but its numbers are not very great. The Harp-seal (*P. groenlandica*), so called from a crescent-shaped

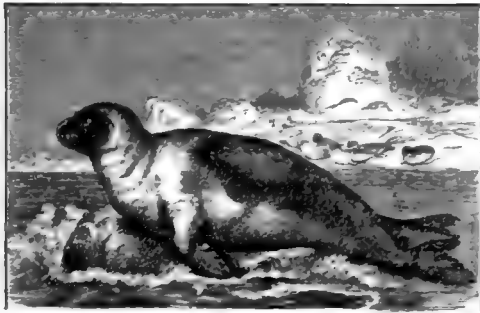

Harp-seal (*Phoca groenlandica*).

dark stripe on each side of the back in the adult, ranges through the arctic regions of the Atlantic, and is said to occur also in the North Pacific, in Kamchatka. It is very abundant in Newfoundland and Greenland, and numerous on the arctic coasts of Europe—e.g. Finmark, Spitzbergen, and Nova Zembla. This species is very gregarious, and breeds on ice-floes in spring. Enormous numbers are killed annually for the sake of their oil and skins. The Harp-seal has been taken on British coasts. It grows to 8 or 9 feet in length, but its ordinary length is about 6 feet. The Bearded Seal (*Phoca barbata*) is another species of the North Atlantic which occurs on British coasts; it reaches 9 or 10 feet in length. The Ringed Seal (*P. hispida*) also occurs as a straggler on British shores, but normally lives on the arctic shores of both hemispheres. It is not of great commercial value, but is highly prized by the Greenlanders and Eskimos, who depend largely on its skin, oil, and flesh. It is a small species. Seals occur in large numbers in the Caspian and Aral Seas, where

they are regularly hunted by the Cossacks. The species of this region is distinguished under the name *P. caspica*. Another species, *P. siberica*, occurs in Lake Baikal, which consists of perfectly fresh water, and is situated at a great elevation above sea-level. *Halichoerus grypus*, the Gray Seal, is confined to the coasts of Europe, occurring on the shores of Scandinavia, Ireland, and Scotland; it reaches a length of 8 feet. In Denmark, since 1890, an effort has been made to exterminate the seals, in the interests of the fisheries, and a reward of three kroner per head paid for all killed (810 in the first ten months).

The distribution of the Phocidæ extends to the tropics, *Monachus albiventer*, called the Monk Seal, inhabits the shores of the Mediterranean, and of Africa as far south as Madeira. Another species of the same genus, *M. tropicalis*, exists in the West Indies, where it was formerly abundant, though now rare. *Cystophora cristata*, the Crested or Hooded Seal, has a remarkable dorsal dilatation of the nose, which can be inflated with air or depressed as the animal pleases; when distended, it extends backwards towards the top of the head. This species has the same geographical range as the Greenland or Harp Seal, but is not so numerous or so highly valued. Allied to the Crested Seal is the great Sea-elephant, which owes its name to its size and to the elongation of its nose, which forms a short curved proboscis. The males of this species reach a length of 20 feet, while the females never much exceed 10 feet. The Sea-elephant or Elephant-seal (q.v.; *Macrorhinus leonina*) lives on the antarctic islands and ice-fields, and is hunted for its blubber and skin. Another species of Sea-elephant (*M. angustirostris*) occurs in the northern hemisphere, having been formerly abundant on the coasts of California and western Mexico; it is now scarce. Other species of Phocidæ in the antarctic regions, called Sea-leopards, are *Stenorhynchus leptoniz* and *Leptoniz weddellii*.

The second family of Pinnipedia commonly called seals, the Otariidæ, are frequently distinguished as Sea-lions and Sea-bears, names corresponding to differences in their hairy covering; the former carry only long coarse hair, while the latter have in addition a short and soft, delicate fur, beyond which the coarse hairs project. It is this fur which, under the name of seal-skin, is so highly valued in commerce. Sea-lions are sometimes distinguished

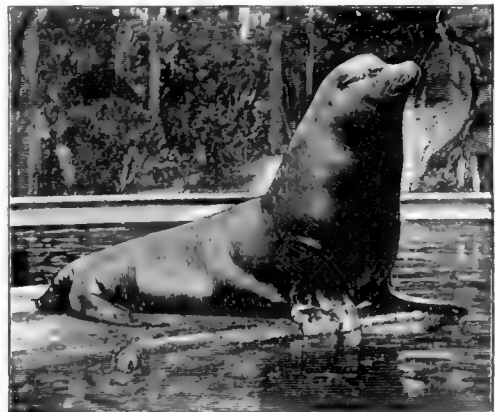

Sea-lion (*Otaria stelleri*).

(From a Photograph by Gambier Bolton F.Z.S.)

as hair-seals, and Sea-bears as fur-seals; but the former name would apply equally well to all the Phocidæ.

The Otariidæ are about equally represented in

the arctic and antarctic regions. By Dr J. E. Gray a large number of genera were distinguished, but recent students of the species unite them under one or two genera. The Sea-lions are as follows: *Eumetopius (Otaria) stelleri*, the Northern Sea-lion, inhabits both shores of the Northern Pacific from California and Japan northwards, and breeds on the Aleutian and other islands in the Behring Sea. The male is about 16 to 18 feet in length, and the female about half that size. *Otaria jubata*, the southern Sea-lion, inhabits the west coast of South America, the islands in the neighbourhood of Cape Horn, and the Falkland Islands. *Zalophus Gillepsii*, the Californian Sea-lion, is considerably smaller than *E. stelleri*.

Of the Fur-seals there are two genera, one belonging to the northern hemisphere, *Callorhinus*, the other to the southern, *Arctocephalus*. Of the former there is but one species, the celebrated northern Fur-seal, *Callorhinus ursinus*, which during 1885-92 became the subject of such complicated diplomatic controversy between the United States, the British Empire, and European nations. This seal is entirely confined to the North Pacific, no fur-seal existing in the North Atlantic. The habits of the northern fur-seal have been very thoroughly investigated by Henry W. Elliott, an American naturalist. This species breeds annually on two of the Pribylof Islands in the Behring Sea, and on two of the Commander Islands farther west, and it breeds nowhere else. The seals arrive on these islands in June and July, the males in the former month, the females in the latter, and they leave them with their young about the middle of September, not returning till the following year. During the breeding time they remain on the low-lying land bordering the sea. In 1870, after the transfer of Alaska from Russia to the United States, the Pribylof Islands were leased by the United States government to the Alaska Commercial Company for twenty years, and this company also rented the Commander Islands from Russia. The company were allowed to take not more than 100,000 seals from the Pribylof Islands per annum, and the seals killed were exclusively young males, not breeding males or any females. The company paid to the government \$50,000 per annum as rent, and in addition a tax of \$2 on each skin shipped from the islands. The value of fur-seal skins shipped from the territory and sold in the London market during the first twenty-three years of American occupation is reported to have reached nearly \$33,000,000. In 1890 a new lease of the islands under similar conditions was granted to the North American Fur-sealing Company. Formerly, in the earlier part of the year, the vast herds of these seals, on their way to the breeding-grounds, passed the coast of the state of Washington and British Columbia, and were there hunted at sea by the Indians. But British and American schooners now employ the Indians, and kill very large numbers. The schooners, both of these and of other European nations, also pursue the seals in Behring Sea. It was the attempt of the United States government to assume exclusive rights over the Behring Sea which gave rise to the diplomatic controversy. The killing of the seals in the ocean has developed to such an extent that it is feared the careful regulation of the slaughter on the breeding islands will not be sufficient to prevent the extermination of the species. In 1880 the total number of fur-seal skins taken by the pelagic hunting was 19,150, valued at \$172,350, but the number had increased to 43,779 in 1890. In the summer of 1891 the British government and that of the United States agreed to submit the dispute to arbitration and to send a joint commission of experts to the seal islands to examine into the question, the killing of

seals being meanwhile strictly limited. The court of arbitration, comprising representatives from Britain, United States, France, and Sweden and Norway, met at Paris in 1893, settled the questions in dispute, and agreed upon a series of articles regulating the seal-taking. The principal species of fur-seals in the Antarctic Ocean are the following: *Arctocephalus nigrescens* may be said to belong to the South Pacific, though it extends also into the South Atlantic. At the beginning of the 19th century this species was abundant on nearly all the islands off the west coast of South America from Cape Horn to the equator, and was killed in large numbers at Juan Fernandez, Mas-a-Fuera, St Felix, St Ambrose Islands, and the Galápagos. It was also abundant at the South Shetlands, Falkland Islands, South Georgia, Sandwich group, Kerguelen, and Heard Island. But at the present time these seals have been exterminated in most of these places, and are scarce in the remainder. Some are still obtained at the South Shetlands; and on Lobos Island at the mouth of the La Plata there is a small 'rookery,' protected by the government of the Argentine Republic. Fur-seals were also formerly abundant on islands off the west coast of Africa from the Cape of Good Hope northward. The seal in this region has been distinguished as a separate species under the name *Arctocephalus pusilla*. It is almost extinct at the present day. Fur-seals were also abundant formerly on Stewart's Island, Antipodes Island, and others to the south-east of New Zealand, but are now scarce. The skins of the fur-seal was at first imported into England for tanning, the wool and hair being scraped off together. It was in 1796 that Thomas Chapman invented a method for 'extracting by the root the whole of the inconceivable quantity of coarse hair that grows intermingled amongst the fur on the skin of the South Sea seal.'

A brief survey of seal-hunting as an industry is necessary to supplement the few indications given in the above account of the species. The largest 'seal-fishery' in the North Atlantic is that of the ice-fields to the east of Newfoundland and Labrador. The vessels engaged in this industry almost all belong to Newfoundland, some being sailing-ships and some steamers. There are somewhat more than a hundred vessels fitted out every year for seal-hunting. The season begins about the middle of March, and lasts for about two months. The crews land on the ice, and kill the young seals which are not old enough to escape easily by clubbing them with a 'gaff,' and then take off the skins, with the fat adhering to them, and carry them to the ships. The annual catch is about 500,000, valued at £425,000. The skins used for leather, and the oil made from the fat, are among the most important exports of Newfoundland. Seal-hunting on the West Greenland coast is mostly carried on by natives, and the meat, skins, and oil used for their own consumption. Fleets of sealers from Great Britain, Germany, and Norway annually visit the neighbourhood of Spitzbergen and Jan Mayen. The industry at Nova Zembla and in the White Sea, as well as in the Caspian, is carried on by Russian subjects. The hunting of southern fur-seals and sea-elephants in the antarctic was formerly more extensively carried on by American and English vessels than it is now. The method here is to land men on the islands when the surf allows, the vessels returning afterwards to take them off with their booty. The animals are killed with club and knife, or with the rifle. At the present day the total product from the antarctic regions is only a few thousand skins and barrels of oil. The fur-seal hunting in the North Pacific has already been mentioned. On the Pribylof and Commander Islands only the young

males up to six or seven years of age, called 'holluschickie,' are killed. These young males are not allowed by the older males to breed, and they haul up on shore occasionally apart from the breeding-grounds. The native servants of the company drive them from the sea to killing-grounds near their villages, and slaughter them by blows on the head with clubs. The 'pelagic' sealers have of course a different method. The Indian hunters leave the schooners in boats, and paddle up to the seals as they sleep at the surface of the sea, and spear them. The barb of the spear is loose, and attached to a line, so that the seal cannot escape or be lost: if the animal is not killed by the spear, he is hauled in when exhausted, and clubbed on the head. This mode of hunting is, as before mentioned, carried on off the coasts of Washington and British Columbia and northwards to Behring Sea.

Sealed Orders, in the Navy, are orders which are delivered to the commanding officer of a ship or squadron sealed up and only to be opened after the ship or squadron has put to sea, and proceeded to a certain point previously designated. When it is considered necessary to despatch a ship or squadron on any secret service, in order to prevent the destination and the object of the expedition becoming known the commanding officer is sent to sea under sealed orders. These orders may be sent direct from the Admiralty, or may be given by any senior officer. The officer who has to act under them is generally directed to proceed a certain distance out to sea, or to a certain latitude and longitude, before he breaks the seal and acquaints himself with the orders in question; he himself equally with others under his command thus putting to sea in ignorance of his destination or the nature of the service to be performed.

Sea-lemon. See DORIS.

Sealing-wax. Before the composition of ordinary sealing-wax was known in Europe coloured beeswax was used for sealing letters and for attaching the impressions of seals to documents. Sealing-wax with Lac (q.v.) as the principal ingredient was probably first made in India or China, since it is only in these and neighbouring countries that the lac insect is found. Beckmann states that the use of sealing-wax made of lac was apparently very common among the Portuguese about the middle of the 16th century. The best red sealing-wax consists of shellac from 5 to 6 parts, Venice turpentine 3 to 4 parts, vermilion 3 to 4 parts, to which is frequently added $1\frac{1}{2}$ part of magnesia, chalk, or gypsum, or a mixture of some of these. Inferior but still fairly good kinds have a considerably less amount of shellac and vermilion in their composition. Parcel-wax is made of shellac 3 parts, common resin 7 parts, turpentine $5\frac{1}{2}$ parts, chalk and gypsum together $3\frac{1}{2}$ parts, and either vermilion 3 parts, or red-lead 6 parts. Bottle-wax is often made of pine-resin, turpentine, chalk, and some colouring matter; but it is very brittle unless about 10 per cent. of shellac is added.

In making sealing-wax the shellac and other materials are carefully melted in metal pans, and quickly stirred to prevent heavy colouring matter such as vermilion from falling to the bottom. The melted sealing-wax is then poured into metal moulds to form it into sticks, which are removed when cold. By one method the sticks are polished by spreading them on a table and passing a red-hot bar of iron over them. Another way is to hold them into a stove, and in either case till the surface just begins to melt. Sealing-wax is made in various colours, the finer qualities, however, being most largely in red. White,

until recently, was chiefly coloured by subnitrate of bismuth, but a special kind of white-lead is now employed. Black is made by the addition of lampblack or vine-black to the other materials. For brown, umber is added; for blue, artificial ultramarine or Berlin blue; for green, Berlin blue and chrome-yellow; for yellow, either chrome-yellow (which will not stand a high heat) or ochre. For common wax some cheaper colouring materials are used, such as baryta for a white. Aniline colours have been tried for sealing-wax with some promise of success.

Sea-lion. See SEAL.

Seal Islands, a name for Lobos Islands (q.v.).

Sealkote. See SIALKOT.

Sea-margins. See BEACHES.

Sea-mat (*Flustra*), a very common genus of Polyzoa (q.v.), various species of which are among the commonest objects in the wrack of the seashore. The colonies are somewhat seaweed-like, but all over the flat leaf-like growth may be seen the minute chambers in which the individuals lived. The texture is horny, whence another common name—hornwrack. Those found on shore are usually dead, having been torn from their natural moorings on rocks, seaweed, or marine animals. Fresh specimens have a characteristic musky odour.

Seamen are technically those persons, below the rank of officer, who are employed in navigating decked vessels on the high seas. See CREW, CRIMP, DESERTION, NAVY.

Sea-mew. See GULL.

Sea-mouse (*Aphrodite*), a genus of Chaetopod worms, well represented by *A. aculeata*, the common British species. This worm has a compact oval body, 4 to 6 inches in length by 1 to 2 in breadth, and is thickly covered with silky hairs, whose structure is such as to produce brilliant iridescence. Along the back these hairs form a matted feltwork, protecting a double row of flat plates, in part respiratory.

The ventral appendages, by means of which the sea-mouse creeps along the floor of the sea, bear bundles of very strong bristles. The head bears tentacles and eyes. Internally the animal is remarkable on account of the very much branched character of the gut. The home of the sea-mouse is at the bottom of fairly deep water, but storms often throw them ashore.

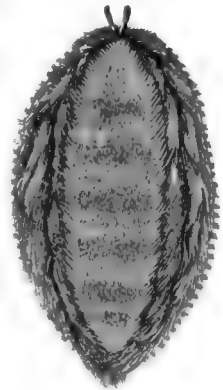

Sea-mouse
(*Aphrodite aculeata*).

Sea-nettle. See ACALEPHÆ.

Sea-owl, a name for the Lumpsnucker (q.v.).

Sea-pen, a name sometimes applied to Pennantula (q.v.), sometimes to the chitinous, quill-like structure which lies along the posterior surface of the squid and some related cuttle-fish.

Sea-pie. See OYSTER-CATCHER.

Sea-pike (*Centropomus undecimalis*), an edible American fish, occurring on the Florida and Texas coasts. The genus includes several somewhat pike-like fishes, at home in the warm American seas, though often thriving in fresh water. In reality they are allied to the perches, not to the pikes. On British coasts the term sea-pike is sometimes applied to the garfish or Belone.

Sea-pink. See THRIFT.

Sea-porcupine. See DIDON.

Search-light. See NAVY, Vol. VII. p. 421.

Search-warrant, an authority granted to an officer of police, empowering him to enter premises and to search for and seize property. In England such warrants seem to have been illegal at common law; they were first permitted by statute for seizing stolen goods in 1782. Under acts now in force a justice of the peace may grant warrants to search for stolen goods, false coin, forged bank-notes, &c.; he may also give a warrant to search any place where there is reasonable cause to suspect that an explosive substance or machine is concealed for a felonious purpose.

The right of searching ships on the high seas indisputably belongs to belligerents (see ENEMY, CONTRABAND, NEUTRALITY). The right claimed by England to search United States ships for British subjects on board, with a view to impress them into the British naval service, was one of the causes of war in 1812; and the right of search for slaves on board suspected slave-traders was repeatedly a source of difficulty. The case of the *Trent* (q.v.) in 1861 nearly led to war between Britain and the United States.

The proper officers have a right to search the persons of apprehended thieves, &c.; and custom-house officers are entitled to search for smuggled goods, not merely ships but all persons on board them or who land from them. But any person may insist, before being searched, on being taken before a magistrate or superior custom-house officer and raise the question whether there is reasonable suspicion that he has smuggled goods about him.

Sea-robin, a common American name for fishes of the genus *Prionotus*, which represents in America the European gurnards (*Trigla*).

Sea-scorpion. See FATHER-LASHER.

Sea-serpent, the name given to gigantic animals, presumably of serpentine form, which have been frequently described by sailors and others, and which are believed by many naturalists to exist in the sea-depths, especially in tropical oceans. The question of the existence of a sea-serpent has long formed one of the knotty problems of zoological science. But it seems reasonable to conclude that there exists a certain basis for the supposition that huge undescribed marine forms do exist in the sea-depths, and that the most reliable tales of sea-serpents take origin from appearances of such animals. Of such tales possessing a warrantable basis of fact, and emanating from authoritative sources, that of Captain M'Quhae is one of the best known. This account was published in 1848. Captain M'Quhae commanded H.M.S. *Dredalus*, and encountered the serpentine form in 24° 44' S. lat. and 9° 20' E. long., and therefore in the South Atlantic Ocean, near the Tropic of Capricorn, and not very far from the coast of Africa. It was not, as in other cases, in bright and fine weather, but in dark and cloudy weather, and with a long ocean swell. The animal was swimming rapidly, and with its head and neck above water. Captain M'Quhae in his report to the Admiralty describes it with confidence as 'an enormous serpent, with head and shoulders kept about 4 feet constantly above the surface of the sea;' and he adds: 'As nearly as we could approximate by comparing it with the length of what our maintop-mast-yard would show in the water, there was at the very least 60 feet of the animal *à fleur d'eau*, no portion of which was, to our perception, used in propelling it through the water, either by vertical or horizontal undulation. It passed rapidly, but so close under our lee-quarter that had it

been a man of my acquaintance I should have easily recognised his features with the naked eye; and it did not, either in approaching the ship or after it had passed our wake, deviate in the slightest degree from its course to the south-west, which it held on at the pace of from 12 to 15 miles per hour, apparently on some determined purpose. The diameter of the serpent was about 15 or 16 inches behind the head, which was without any doubt that of a snake; and it was never during the twenty minutes that it continued in sight of our glasses once below the surface of the water; its colour a dark brown, with yellowish white about the throat. It had no fins, but something like the mane of a horse, or rather a bunch of seaweed, washed about its back.' Regret has been very naturally expressed that Captain M'Quhae did not bestow a shot on it. Figures prepared from a sketch by him were published in the *Illustrated London News* of 28th October 1848. About the same time the testimony of another witness, Lieutenant Drummond, appeared, and was found to differ in some important points from the account of the animal given by Captain M'Quhae and the figures published with his approbation, particularly in ascribing a more elongated form to the head, in the mention of a back-fin, whereas Captain M'Quhae expressly says that no fins were seen, and in a lower estimate of the length of the portion of the animal visible. Lieutenant Drummond's words are: 'The appearance of its head, which with the back-fin was the only portion of the animal visible, was long, pointed, and flattened at the top, perhaps 10 feet in length; the upper jaw projecting considerably; the fin was perhaps 20 feet in the rear of the head, and visible occasionally; the captain also asserted that he saw the tail, or another fin about the same distance behind it; the upper part of the head and shoulders appeared of a dark-brown colour, and beneath the under jaw a brownish white. It pursued a steady and undeviating course, keeping its head horizontal with the water, and in rather a raised position, disappearing occasionally beneath a wave for a very brief interval, and not apparently for the purposes of respiration. It was going at the rate of perhaps from 12 to 14 miles an hour, and when nearest was perhaps 100 yards distant. In fact, it gave one quite the idea of a large snake or eel.' Lieutenant Drummond's account is the more worthy of regard, as it is derived from his log-book, and so gives the exact impressions of the hour, whilst Captain M'Quhae's was written from memory after his arrival in England. Sir Richard Owen thought the animal was a gigantic seal; a supposition, however, which does not at all agree with the description given.

In 1875 a battle between a sea-serpent and a whale was viewed from the deck of the *Pauline* of London, Captain Drevar, when proceeding with a cargo of coals from Shields to Zanzibar. When the *Pauline* reached the region of the trade-winds and equatorial currents she was carried out of her course, and after a severe storm found herself off Cape San Roque, where several sperm-whales were seen playing about her. While the crew were watching them they suddenly beheld a sight that filled every man on board with terror. Starting straight from the bosom of the deep, a gigantic serpent rose and wound itself twice in two mighty coils round the largest of the whales, which it proceeded to crush in genuine boa-constrictor fashion. In vain did the hapless whale struggle, lash the water into foam, and even bellow, for all its efforts were as nothing against the supernatural powers of its dreadful adversary; whose strength may be further imagined from the fact that the ribs of the ill-fated cetacean were distinctly heard cracking one

after the other with a report like that of a small cannon.

Of no less a ship than H.M. yacht *Osborne* the captain and officers in June 1877 forwarded an official report to the Admiralty containing an account of a sea-serpent's appearance off the coast of Sicily on the 2d of that month. 'The time was five o'clock in the afternoon. The sea was exceptionally smooth, and the officers were provided with good telescopes. The monster had a smooth skin, devoid of scales, a bullet-shaped head, and a face like an alligator. It was of immense length, and along the back was a ridge of fins about fifteen feet in length and six feet apart. It moved slowly, and was seen by all the ship's officers.' This account was further supplemented by a sketch from the pencil of Lieutenant W. P. Hynes of the *Osborne*, who to the above description adds that the fins were of irregular height, and about 40 feet in extent; but, 'as we were passing through the water at 10½ knots, I could only get a view of it "end on."' It was about 15 or 20 feet broad at the shoulders, with flappers or fins that seemed to have a semi-revolving motion. 'From the top of the head to the part of the back where it became immersed I should consider about 50 feet, and that seemed about a third of the whole length. All this part was smooth, resembling a seal.' These instances are but examples of the many cases in which narratives of the most circumstantial character have been recorded regarding the appearance of serpentine animals, usually in tropical seas.

As will readily be admitted, the chief point at issue is that of the zoological determination of the forms reported to have been seen. Gigantic cuttle-fishes, now proved to have a veritable existence, might in many cases imitate an elongated marine form, swimming near the surface of the sea. It is by far the most plausible theory of sea-serpent existence to suppose that most of the animals described are really giant cuttle-fishes of the *Loligo* or squid type. These creatures may attain a length of 40 feet or more inclusive of their tentacles, and as they swim along the surface of the sea backwards the tail-fin might well be mistaken for a serpentine head and its fin or ridge, while the tentacles and wash produced by the animal's movements would impart an exaggerated length to the body. Even the incident already described in the case of the *Pauline* might be explicable on the theory that giant cuttle-fishes attacked the whales, and that the so-called serpents were really the arms or tentacles of the squids. As regards the *Pauline* case, it may be remarked that the latitude in which the incident occurred was one most unlikely for any sea-snakes to be found. Certain fishes, too, such as the Basking Shark (*Selache maxima*), would also under certain circumstances appear as unusual marine forms; and, as the present writer has pointed out, the well-known Tape-fishes (*Gymnetrus banksii*) and other Ribbon-fishes would very accurately reproduce the features of a marine snake, especially when these fishes, as sometimes happens, have grown to an immense size. The marine snakes or Hydrophidæ of the Indian Ocean would also serve to personate the 'great unknown' if unusually large. It seems certain that in the immense development of ordinary marine animals may be found a probable clue to the sea-serpent mystery. Mr P. H. Gosse entertained the notion that it might be possible to explain certain sea-serpent stories on the theory that some of the gigantic marine reptiles with whose fossils we are well acquainted might still be in existence in the sea-depths, and occasionally make their appearance at the surface of the ocean. Cases of mere serpentine appearances assumed by certain animals are not to be

confused with cases in which a single animal has presented a serpentine aspect. Flocks of the birds known as shags swimming close to the water's edge might personate a sea-serpent swimming along the top of the water; but a flock of birds would have been readily detected by Captain M'Quhae, and by many other observers who have beheld the unknown form from a relatively near distance.

Apart altogether from these historical or semi-historical examples, the sea-serpent has had continuous existence in folklore everywhere, whether among the Eskimo, Fijians, Japanese, Icelanders, Basques, Red Indians, or Chinese. The notion is natural and easy of belief, and the human desire for wonders is sufficient to account for any belief.

See C. Gould, *Mythical Monsters* (1886); F. S. Bassett, *Legends and Superstitions of the Sea* (Chicago, 1886); J. Gibson, *Monsters of the Sea* (1886); an article in the present writer's *Leisure-time Studies* (1884); and Oudemans, *The Great Sea-Serpent* (1893).

Seashore, or land bordering on the sea, belongs partly to the crown, and the public have certain rights in relation thereto. The soil or property in the foreshore (land between high and low water mark) is vested in the crown, and the limit on the land side is defined to be the medium line of high-water of all the tides in the course of the year, or the height of the medium tides in each quarter of a lunar revolution during the whole year. But though the crown is *prima facie* the owner of the seashore, the owner of the adjoining manor has sometimes a grant of it, and he may prove this grant by ancient use—such as gathering seaweed, &c. The public have a right to walk on that part of the shore vested in the crown, but they have no right to trespass on the adjacent lands in order to get at the shore, so that it is only where a highway leads to the shore, or the public land from seaward, that the right can be made available. Thus it has been decided that the public have no legal right to trespass on the adjoining lands in order to get to the shore for the purpose of bathing. The public have a right to fish on the seashore if they get legal access to it, and may take all floating fish, but not oysters or mussels which adhere to the rock, if the soil belongs to an individual. The public have no right to gather seaweed or shells, though, as regards the latter, it is of so little consequence that nobody prevents them. Nor have fishermen a right to go on that part of the seashore which is private property to dig sand for ballast, or to dry their nets, or similar purposes, though in a few cases local customs permitting a limited class of persons (e.g. the fishermen of a township) to exercise such rights have been held valid. In Scotland the right to the seashore is also vested in the crown; when a crown grant gives land bounded by the seashore, this is held to give to the grantee the foreshore also. See Stuart A. Moore, *History and Law of the Foreshore* (3d ed. 1888); and BEACHES (RAISED), DENUDATION, DERELICT, DRIFT, SAND, UPHEAVAL.

Sea-sickness is a variety of vomiting deserving of special notice. It is often preceded by premonitory symptoms, which appear almost immediately after a susceptible person is exposed to the motion of rolling water in a vessel or boat, and are as distressing as the vomiting itself. Amongst these symptoms may be mentioned vertigo and headache, with a peculiar feeling of sinking and distress about the pit of the stomach. Vomiting, however, in general, soon comes on, accompanied with convulsive heaving of the stomach, and such an indescribable feeling of prostration as to render the patient utterly regardless of what is going on around him, and almost indifferent to life. Moreover, pallor and cold sweat are commonly present

with disturbance of the action of the bowels, usually constipation, but occasionally diarrhœa. The susceptibility to this troublesome affection varies extremely in different persons. Some never suffer from it, others only on their first voyage, and others, again, like Nelson, in every fresh voyage they take; with some it continues but a few hours, while others suffer almost continuously throughout a long voyage. In the great majority of cases the sickness disappears in a few days, unless the weather be very boisterous. It almost always ceases on landing, although more or less giddiness may prevail for some hours. Though a very distressing malady it is rarely serious, but sometimes is so severe and prolonged as to prove fatal. Infants and aged persons are supposed to possess a comparative immunity from sea-sickness, while as a general rule women suffer more than men. According to Dr Althaus, persons with a strong heart and a slow pulse generally suffer little from sea-sickness, while irritable people, with a quick pulse and a tendency to palpitation, are more liable to be affected; and he thus accounts for different liability of different nations to this affection; 'for, as a rule, the French and Italians being of a more irritable temper suffer most from the disorder, the Germans less, and the English least.'

The primary cause (or rather condition) of sea-sickness is the motion of the ship; and the *pitching* of a vessel, or alternate rising and falling of the bow and stern, is especially apt to produce it. It is less felt in large and heavily ballasted vessels, because the movements referred to are least perceptible in them. Other more or less regularly repeated oscillatory movements produce a precisely similar condition in some people; the motion of a swing or a toboggan in particular. Some suffer in a railway journey, especially when sitting with their backs to the engine; while a few individuals are so intensely susceptible that even a short drive in a carriage or omnibus is enough to induce nausea and vomiting.

The mode in which such causes produce sea-sickness has been much discussed; but it is now generally believed to be by a reflex disturbance of the nervous system, induced by the unusual and violent stimulation of the sensory organs concerned in the maintenance of the equilibrium of the body, particularly the semicircular canals (see EAR) and the eyes, and also of the viscera, particularly the stomach. This is not inconsistent with the view of Dr Chapman, who gave much attention to the subject, and held that the motions of the vessel cause the accumulation of an undue amount of 'blood in the nervous centres along the back, and especially in those segments of the spinal cord related to the stomach, and the muscles concerned in vomiting.' He accordingly believed that the only scientific and really effective remedy for this disorder must be one which has the power of lessening the amount of blood in the whole of the nervous centres along the back, and this can be done by lowering the temperature of the spinal region by the local application of ice. For a description of Dr Chapman's 'spinal ice-bags' (which may be obtained from any respectable surgical instrument-maker), and for the method of applying them, we must refer to his work *On Sea-sickness* (1864). They have undoubtedly proved of great value in many cases. Another method of treatment, which is less difficult to employ and sometimes gives good results, is to make the sufferer breathe deeply and regularly, timing the respirations by the watch at about fifteen to the minute.

Those who are susceptible to this distressing affection and have not the opportunity of trying the ice-bags, may, at all events, diminish the sever-

ity of the vomiting by assuming, and as long as possible retaining, the horizontal position as nearly as possible in the centre of the ship's movement, and keeping the eyes closed. Compression of the abdomen by means of a broad tight belt sometimes gives relief. Fresh air and light diet are undoubtedly of great importance. A little arrow-root, flavoured with brandy or sherry, is usually a kind of food that will most easily remain on the stomach, when the severity of the symptoms is abating. The maintenance of the surface temperature, by warm blankets and hot bottles if necessary, should be attended to. The application of a mustard poultice or stimulating liniment to the epigastrium is often useful. Sucking or swallowing small lumps of ice also tends to diminish the tendency to vomiting. As soon as possible the sufferer should go on deck, and try to move about; if this can be done the nervous system undoubtedly becomes more quickly accustomed to the unwonted conditions under which it is placed.

With regard to drugs, no specific has been discovered, nor is it likely that there ever will be. But something can often be done by medication both before and during a voyage. First in importance are purgatives. The bowels should be freely relieved the day before the voyage begins, and should never be allowed to become constipated. The administration of a tonic (e.g. Easton's syrup) for a few days before starting is also useful; and regular doses of the bromides, commenced just before going on board, sometimes diminish the intensity of the malady. When it has set in, chloroform (a few drops on a piece of sugar), opium, chloral may do good; and cocaine, nitrite of amyl, nitroglycerine, and antipyrin, drugs more recently introduced, have all been strongly recommended. But with all such remedies disappointment is only too common.

See Dr T. Dutton. *Sea-sickness* (2d ed. 1891); and a small monograph by Rosenbach (Berlin, 1891).

Seaside Grape (*Coccoloba uvifera*), a small tree of the natural order *Polygonaceæ*, a native of the West Indies. It grows on the sea-coasts, and receives its name from the bunches of its violet-coloured fleshy calyx which envelop the nuts or seeds. The fleshy part is pleasantly acid, and is eaten with or without sugar; it is esteemed astringent and antidiarrhetic; is used in making refreshing drinks. The extract of the wood is extremely astringent, and is sometimes called Jamaica Kino. The wood itself is heavy, hard, durable, beautifully veined, and capable of taking a fine polish.

Sea Slug. See HOLOTHURIANS.

Sea-snakes (Hydrophiidæ), very venomous marine snakes, inhabiting the tropical parts of the Indian and Pacific Oceans, especially about the East Indian Archipelago, and between China and Australia. The body is compressed behind, and the tail is often markedly paddle-shaped; the ventral scales are very slightly if at all specialised; the nostrils are valved, and lie on the tip of the snout; the eyes are small, and most of the sea-snakes are very blind and helpless when taken out of the water; the fangs are like those of cobras, and the venom is very virulent. The sea-snakes feed on fishes, which they kill almost instantly with their poison and swallow head foremost. They are themselves preyed upon by sharks and rays. They not unfrequently attain a length of eight feet, but are not large enough to be mistaken for 'sea-serpents.' All are viviparous. Among the common forms are species of *Hydrophis* and the yellow-bellied *Pelamys bicolor*, while the genus *Platurus* is in several ways half-way between the typical Hydrophiidæ and the terrestrial Elapidæ.

Seasons. In the article EARTH the motions of the earth on which the changes of the seasons ultimately depend are explained. The chief cause of the greater heat of summer and cold of winter is that the rays of the sun fall more obliquely on the earth's surface in the latter season than in the former (see CLIMATE). Another concurrent cause is the greater length of the day in summer, and of the night in winter. Within the tropics the sun's rays have at no time so much obliquity as to make one part of the year very sensibly colder than another. But the zone of equatorial calms in which rainfall is practically continuous is shifted northward when the sun moves northward in the northern summer, and is similarly shifted southward in the southern summer. As the wet-zone swings to and fro, following the sun, the regions it traverses experience alternate wet and dry seasons. Those regions lying near the mean position of the wet-zone have thus two wet and two dry seasons in the year, the regions near its extreme positions having one wet and one dry season. Wet and dry seasons are also produced by the Monsoons (q.v.), themselves due to the relative seasonal change of temperature between land and sea (see also RAIN). In the temperate regions of the globe the year is naturally divided into four seasons—*Spring, Summer, Autumn, and Winter*. In the arctic and antarctic regions spring and autumn are very brief, and the natural division of the year is simply into summer and winter, the winter being long, and the summer short; and this is very much the case also in regions of the temperate zones lying near the arctic and antarctic circles. In subtropical regions the distinction of four seasons is, in like manner, very imperfectly marked. Conventionally (as in almanacs) it is assumed that each season commences at the equinox or solstice—e.g. that in the northern hemisphere spring commences at the vernal equinox about March 20, and summer at the summer solstice on June 21, although this is popularly spoken of as 'Midsummer Day'; and the 'summer months' in common English parlance include May, June, and July, winter being November, December, and January, and spring and autumn accordingly. Practically our division of the seasons depends more on seedtime and harvest than on the extremes of annual heat and cold. The greatest heat of summer is reached a considerable time after the summer solstice, the period when the sun's rays are most nearly vertical, and the day is longest. The greatest cold of winter in like manner occurs after the winter solstice—the period when the day is shortest, and the sun's rays are most oblique. The reason in the former case is that as summer advances the earth itself becomes more heated by the continued action of the sun's rays; in the latter, that it retains a portion of the heat which it has imbibed during summer, just as the warmest part of the day is somewhat after mid-day, and the coldest part of the night is towards morning. The four seasons of temperate regions are distinguished by the phenomena of plant-life, such as the budding, blossoming, fruit-bearing, and leafless repose of deciduous trees. Associated with these annual changes there are modifications of structure and function adapted to the seasonal variation of climate in different localities. Similar habits of hibernation (q.v.) or of change in the thickness and colour of fur or feathers are found in the animals of regions where the seasons are sharply contrasted in climate. The intellectual superiority of the races inhabiting temperate regions is in part traceable to the constant necessity for forethought in providing for the regularly recurring season of winter when natural resources cease to be available.

Sea-spider. See PYCNOGONIDÆ; and for the Spider-crab, CRAB.

Sea-squirt, a popular name for any of the Ascidiæ (q.v.); also called Sea-perch, Sea-pear, Sea-pork, &c.

Sea-surgeons (Acronuridæ), a family of spiny-rayed Teleostean fishes, living in tropical seas, especially near coral-reefs. The name refers especially to the members of the genus *Acanthurus*—characterised by a lancet-like spine which lies ensheathed on each side of the tail, but can be erected as a formidable weapon.

Sea-swallow. See TERN.

Seathwaite, a valley and hamlet at the head of Borrowdale (q.v.) in Cumberland, remarkable for its heavy rainfall. See RAIN.

Sea-trout, a popular name for various species of the genus *Salmo*, but especially for the common *Salmo trutta* (see SALMON).

Seattle (pron. *Se-at'tel*), capital of King county, Washington, is on Elliott Bay, an arm of Puget Sound, 18 miles by rail N. of Tacoma. The residence streets run up the slope of a hill, with the business portion built on the level ground at the foot, stretching along the excellent harbour, with its many wharves. Seattle owes its phenomenal growth to the development of the state lumber trade, of which it is the chief seat. Over 1000 vessels of about 1,000,000 tons enter and clear the port annually, carrying away coal and timber. Shipbuilding and a busy fishery are also carried on. There are cable and electric tramways, and the town possesses a university. In 1889 a terrible fire destroyed the whole business portion—sixty blocks—with the wharves, and cost nearly \$10,000,000; but within a year 265 new buildings, mostly of iron and stone, besides sixty wharves, with a frontage of 2 miles, were erected. Pop. (1880) 3533; (1890) 42,837; (1900) 80,671.

Sea-unicorn. See NARWHAL.

Sea-urchins (*Echinoidea*), a class of Echinoderms. In the more typical genera, such as *Echinus*, the body is symmetrical and nearly globular; others, such as *Spatangus*, are heart-shaped; and others, such as *Clypeaster*, are shield-shaped and flattened. In all cases the body is walled in by continuous plates of lime, which, though capable of independent growth, are rigidly connected, except in Echinothuridæ, which have plastic shells, as the extinct Palæo-echinoidea seem also to have had.

In a typical sea-urchin, such as *Echinus esculentus* or *Strongylocentrotus lividus*, the body is a

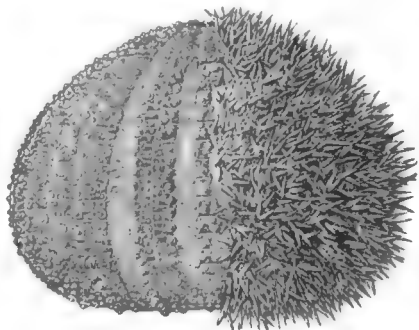

Fig. 1.—Common Sea-urchin (*Echinus esculentus*), one-half with spines removed.

slightly flattened sphere, covered with movable spines. The food-canal begins in the middle of the lower surface, and ends at the opposite pole in the

middle of an 'apical disc,' which consists of a central plate surrounded by five 'ocular' and five 'genital' plates. The ocular plates bear eye-specks; the genital plates bear the openings of the genital ducts, but one of the five is modified as a madreporic plate through which fluid enters and leaves the water-vascular system. From pole to pole extend ten meridians—each a double row of calcareous plates which fit one another firmly. Five of these meridians—in line with the ocular plates—are known as ambulacral areas, for through holes in their plates the locomotor tube-feet are extruded; the other five meridians, alternating with the former and in line with the genital plates, are called inter-ambulacral areas, and bear spines, not tube-feet. The bases of the spines fit over ball-like knobs, on which they are moved by muscles. There are also two peculiarly modified forms of spines—the minute pedicellariæ, with three snapping-blades mounted on a soft stalk, and small globular spheridia which seem to be sensitive to chemical changes in the water. The pedicellariæ have been seen removing pieces of seaweed and the like from the surface of the shell. In front of the mouth project the tips of five teeth which work against one another, grasping and grinding small particles. They are fixed in five large sockets, and along with fifteen other pieces form 'Aristotle's lantern,' a complex, somewhat lantern-like masticating mill, of which Aristotle took notice. The limy skeleton is formed in the mesoderm, and outside of it there is a delicate ciliated ectoderm with a network of nerve-fibres and some ganglion cells. Inside the shell, lining the spacious body-cavity, there is again ciliated epithelium.

The nervous system consists of a ring around the mouth, with a radial branch up each ambulacral area, and of the superficial network. The tube-feet, pedicellariæ, and spines are all under nervous

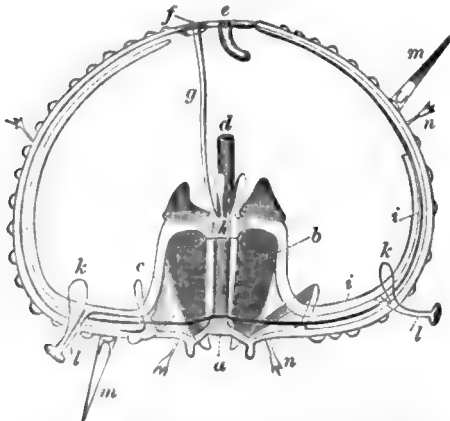

Fig. 2.—Diagram showing the Anatomy of Sea-urchin (after Huxley):

a, mouth; b, teeth of Aristotle's lantern; c, muscles which work the lantern; d, food canal; e, end of food canal; f, madreporic plate; g, stone canal; h, circular water vessel; i, radial water vessel; k, ampulla; l, tube-foot; m, spine; n, pedicellaria.

control, while the eye-specks, the spheridia, and the tube-feet adjoining the mouth are especially sensitive. The alimentary canal passes through Aristotle's lantern, coils round the inside of the shell, and ends in the apical disc. The body-cavity contains a fluid with floating brown cells apparently of some significance in respiration.

The water-vascular system is of use in locomotion, and perhaps also in excretion. From the apical madreporic plate a 'stone canal' extends through the body to a circular vessel round the upper end

of the lantern; this circular vessel gives off five radial vessels, from which the tube-feet are supplied. When filled with fluid the tube-feet become tense and are pressed against the surface of the rock; when the fluid flows back they adhere firmly, and the sea-urchin drags itself towards the attachment. There is a blood-vascular system, but it is difficult to trace. Respiration seems to be discharged in part by the body-cavity fluid, in part by ten hollow outgrowths on the area round about the mouth.

The sexes are separate and resemble one another. The reproductive organs are five spongy masses lying beneath the apical disc. The eggs are fertilised externally by spermatozoa wafted from another sea-urchin; and the free-swimming larva out of which the adult develops, as in other Echinoderms, by a remarkable indirect metamorphosis, is called a Pluteus, and has a quaint form, a little suggestive of a many-legged painter's easel. A few sea-urchins—e.g. *Hemiaster*—carry their young about with them among their spines.

Most sea-urchins live off rocky coasts; not a few shelter themselves in holes in the rocks; many deep-sea forms are known. Most are very sluggish, moving slowly by means of their tube-feet, in some cases slightly helped by their spines, in other cases perhaps hindered. They feed in part on seaweeds, mostly on organisms and organic matter found in mud and other deposits. Many look as if they were falling victims to their constitutional tendency towards the deposition of lime, for there is hardly any part of the body which may not become limy, and in some of the flattened forms the body-cavity is much restricted by cross beams of lime.

Among other Echinoderms, the Echinoids may be placed near Asteroids (starfishes) on the one hand, and near Holothuroids (sea-cucumbers) on the other, while they have without doubt affinities with the extinct Cystoids, which occupy a central position among the classes. The sea-urchins are often classified as follows:

1. PALAEO-ECHINOIDEA.—Extinct forms, apparently with plastic shells, occurring first in Lower Silurian rocks.
2. DERMOSTICHA.—Regular and symmetrical forms, such as *Echinus*, *Strongylocentrotus*, *Cidaris* (with very long spines), *Diadema* (with numerous diffuse eyes), *Cyanosoma urens* (with poisonous spines), *Echinothuridæ* (with flexible shells).
3. CLYPEASTROIDEA.—Shield-shaped and often flattened forms, with the end of the food-canal outside the apical disc—e.g. *Clypeaster*.
4. PETALOSTICHA.—Heart-shaped forms, with excentric mouth, without masticating organs, with the end of the food-canal away from the apical disc, with irregular ambulacral areas—e.g. *Spatangus*.

The ovaries of *Echinus esculentus* are sometimes eaten, but otherwise the sea-urchins hardly come into touch with human life.

Seaweeds, a general and popular term applied to a vast collection of lower plant-forms growing on the seacoast from high-water mark (or a little above that limit) to a depth of from 50 to 100 fathoms (rarely deeper), and all belonging to the sub-class of the Thallophyta, to which the name *Alge* has been given (see *ALGÆ*). Any detailed treatment of the organisms included under the term would be impossible within the limits of a short article like the present. It must suffice, on the one hand, to indicate the chief variations in structure and life-history of typical representatives, and on the other to refer briefly to the more important points in the distribution and classification of the group. The short bibliography appended will supply a guide to the very extensive literature of the subject.

An examination of an average shore-belt exposed at ebb-tide reveals the fact that this area may be roughly divided into four regions: (a) a zone at and above high-water mark, characterised by the

predominance of filamentous and encrusting, often inconspicuous, forms, exhibiting a bluish-green colour when examined under the microscope; (b) a zone from near high-water mark to half-tide level, occupied chiefly by algae of a bright grass-green tint; (c) from half-tide level to low-tide mark, where the majority of the plants are olive-brown in colour; and finally (d) from near low-water mark to depths never exposed by the lowest ebb, where the preponderance of forms are of a distinctly red colour. Although not a few shores exhibit these zones fairly clearly, it must be remembered that, owing to the nature of the shore, the character of the tides, and the absence or presence of large influxes of fresh water, the zoning is not always clearly defined. For instance, the uppermost zone of blue-green forms is most likely to be met with on low-lying coast-lines where the seashore proper merges gradually into brackish marshes and muddy pools, such as, for example, the estuaries of the Dee and Mersey, or of the Clyde near Dumbarton. Grass-green forms are most plentiful on shelving rocky shores; whilst on such steep rocky shores as those of the fjords of the west coast of Scotland olive-brown seaweeds form the prevailing vegetation right up to high-water mark. It must be also borne in mind that certain species of algae are invariably found in regions of the littoral area not characteristically occupied by the majority of forms of a similar hue. Thus the common dwarf species, *Pelvetia canaliculata*, closely allied to the familiar bladder-wrack (*Fucus vesiculosus*), belongs to the olive division of seaweeds, and yet is invariably found at or even above high-water mark. Tangle (*Laminaria digitata*), also an olive seaweed, is, on the other hand, a deep-water form only exposed at low tides, whilst the genus *Struvea*, one of the pure-green algae, may be dredged from 30 fathoms. Very many red algae are found under cover of the olive forms between tide marks, whilst some have their habitat at or above high-water mark. For example, two species of the genus *Rhodochorton* form a crimson velvety pile on rocks from half-tide level to far above high-water mark, and another and easily recognisable form, *Catenella opuntia*, grows on the lee side of rocks which are seldom touched by the flood-tide.

It is worthy of note that the classification of seaweeds into four groups according to colour is strikingly supported by the morphology and life-history of the forms so brought together. This fact becomes all the more remarkable when it is remembered that colour among higher plants is in very few cases of even specific value in classifica-

tion. The blue-green algae are known as Cyanophyceæ, the pure-green as Chlorophyceæ, the olive as Phæophyceæ, and the red as Rhodophyceæ. (By some authors the lower members of the first two groups are classed together under the name of Protophyceæ.) All possess the green colouring matter chlorophyll, but in the blue, olive, and red forms additional colouring matters (phycocyanin, phycophæin, and phycocerythrin) are present to a greater or less extent, masking the pure-green tint so well seen in the Chlorophyceæ. It is impossible in the present state of our knowledge to dogmatise on the precise value of these additional pigments, but we cannot be far wrong in saying that they are associated with the modification of the intensity or quality of sunlight, and aid or protect the chlorophyll in the peculiar and vitally important duties which it performs in the nutrition of the organism (see CHLOROPHYLL). It has been ascertained that certain rays of the solar spectrum are more efficient than others in the work of assimilation, and it is worthy of note that these rays are precisely those which are first intercepted in the passage of sunlight into sea-water. Our ignorance of the important physiological problems involved may be estimated when we place against this explanation the fact that Kjellman in his exploration of the flora of the Arctic Sea found that algae grew and reproduced at a mean temperature of -1° C. and during the long and dark arctic night of three months' duration.

Turning from the bathymetric distribution of seaweeds to their surface distribution, we find here also many interesting and difficult problems. In the first place the medium in which seaweeds live is of a more uniform temperature than that to which land plants are exposed, although against this we must place the fact that seaweeds are more susceptible to fluctuations of temperature. Whilst ocean currents are undoubtedly the chief agents in the transport of the marine flora, long tracts of deep ocean must prove serious barriers to the migration of littoral species. It is scarcely necessary to point out that continental areas, hotter and colder regions of the sea, and long stretches of sandy shore must also act as barriers to possible migration. The effects of such barriers are well seen in comparing the floras of the tropical Atlantic and of the Indian Ocean, the north and south temperate Atlantic, and the eastern and western shores of the same great ocean. From the following table (abstracted from Murray's paper on the 'Distribution of Marine Algae,' *Trans. Biol. Soc. Liverpool*, vol. v. p. 164) it will be seen that,

	Arctic Sea.		West Indies.		Australia.		Algae common to							
	Gen.	Spec.	Gen.	Spec.	Gen.	Spec.	Arctic Sea and West Indies.		West Indies and Australia.		Arctic Sea and Australia.		All three regions.	
							Gen.	Spec.	Gen.	Spec.	Gen.	Spec.	Gen.	Spec.
Rhodophyceæ ..	44	104	85	444	151	743	21	18	70	79	22	6	17	5
Phæophyceæ	42	92	25	112	52	209	9	4	19	21	11	8	6	1
Chlorophyceæ ...	19	54	30	187	34	149	8	8	15	32	5	7	5	6
Protophyceæ....	6	9	10	45	18	31	4	0	5	3	4	0	4	0
Aggregate ..	111	259	150	783	255	1132	42	30	109	135	42	21	32	12

taking three principal regions into consideration, the Arctic marine flora consists of 259 species belonging to 111 genera, the West Indian region possesses 788 species and 150 genera, the Australian 1132 species in 255 genera, and that nevertheless only 17 genera and 5 species of Rhodophyceæ, 6 genera and 1 species of Phæophyceæ, 5 genera and 6 species of Chlorophyceæ, and 4 genera and no species of Protophyceæ are common to all.

The structure, life-history, and classification of the lower algae (both fresh-water and marine) having been dealt with in the article *Algae* (q.v.),

there is left for treatment the two higher groups—viz. Phæophyceæ and Rhodophyceæ. It will be most in accordance with the aim of the present article to sketch very briefly the main lines of classification, and to select a few typical examples for more detailed notice.

The Phæophyceæ include all the olive-brown seaweeds found on our shores, and are subdivided according to their methods of reproduction into three chief series—viz. (a) the Phæosporææ, represented by such forms as *Ectocarpus*, *Cutleria*, *Sphacelaria*, and the giants among seaweeds,

Laminaria, Macrocystis, and Lessonia; (b) the Fucaeae—e.g. Fucus, Ascophyllum, Pelvetia, &c.; and (c) the Dictyotaceae—e.g. Dictyota and Padina. The members of the Phaeosporeae have a most



Fig. 1.—*Ectocarpus confervoides*:
A portion of the thallus with multilocular sporangia ($\times 10$).

varied vegetative form. Many are filamentous and branched, such as *Ectocarpus* and *Sphacelaria*, some are tubular and unbranched, as *Asperococcus* and *Scytosiphon*, or tubular and branched—*Chordaria*. Others are ribbon-shaped—e.g. *Cutleria*; not a few are membranous and encrusting—e.g. *Ralfsia*; whilst *Laminaria* forms large expanded



Fig. 2. Laminariaceae:
A, *Laminaria digitata*, var. *stenophylla*; B, C, *L. digitata*, var. *cloustoni*; D, young form of B (all much reduced). (After Luc. sen.)

resemblance to the sieve tubes of Phanerogams, whilst the small cortical cells exhibit that inter-communication of protoplasm which is of so great physiological importance in the higher plants.

Both sexual and asexual methods of reproduction are known to occur, though not as yet in all genera. Vegetative propagation by gemmae is also not uncommon. The asexual reproductive organs are in the form of unilocular sporangia, the contents of which are transformed into zoo-

spores, small motile cells furnished with two flagella each, and capable after a period of activity of longer or shorter duration of settling down and forming new plants. The sporangia either are developed externally on the thallus or are the terminal cells of short branches. They are frequently collected in groups (*sori*), and are accompanied by sterile filaments. The sexual organs are multilocular sporangia (*gametangia*), of diverse form, each loculus giving rise to a single motile cell somewhat like a zoospore. These cells conjugate in pairs, the product (*zygote*) behaving in a precisely similar manner to the zoospore. Although in most of the Phaeosporeae the zoogametes are morphologically indistinguishable, interesting gradations may be observed in some genera where the zoogametes are differentiated into male and female cells. *Cutleria* is especially interesting in this respect, as the female gametes are much larger than the male gametes, and come to rest before conjugation with the still motile male cell.

The Fucaeae are characterised by having distinctly differentiated sexual organs with non-motile ova and motile fertilising cells. The ova are formed within the swollen cells (*oogonia*) which arise from the wall of flask-shaped cavities (*conceptacles*), and are accompanied by unbranched hairs. The fertilising cells, antherozoids or sperms, are produced in ovoid terminal cells of branched hairs (*antheridia*), which likewise arise from the walls of similar conceptacles. In *Fucus platycarpus* both ova and sperms are formed in the same conceptacle; in most Fucaeae, however, they are formed on different plants. Asexual



Fig. 3.—*Fucus platycarpus*:
A portion of the thallus showing receptacles ($\times \frac{1}{2}$) (After Thuret.)

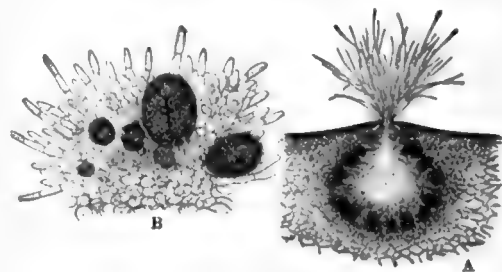

Fig. 4.—*Fucus platycarpus*:
A, vertical section through a conceptacle; B, portion of the wall of a conceptacle, showing oogonia in various stages of development, and antheridia. (A, $\times 20$; B, $\times 150$.) (After Thuret.)

multiplication is unknown. The group includes such well-known genera as *Fucus*, *Halidrys*, and *Pelvetia*, with branched leathery fronds, the tips of whose branches become transformed into receptacles for the reproductive organs, and *Himantalia*, with a button-shaped thallus, from which arise the long strap-shaped reproductive branches characteristic of that genus.

The Dictyotaceæ are an aberrant group of Phœphyceæ with distinct affinities to the Rhodophyceæ. They resemble that group in having non-motile spores produced in fours in sporangia which are clustered in sori over the surface of the frond (Dictyota) or along the midrib. The sexual organs are in the form of antheridia and oogonia. The male organs produce non-motile fertilising cells resembling the pollinoids of the Rhodophyceæ, though Johnson (*Jour. Linn. Soc. Bot.*, vol. xxvii. p. 467) considers that possibly the pollinoids of Dictyopteris may be ciliated like those of Cutleria. The oogonia are arranged in sori, each containing one ovum. In both Fucaceæ and Dictyotaceæ fertilisation is external.

The Rhodophyceæ (Florideæ) form a very large assemblage of most varied vegetative form, and every possible shade of red from a purple black to brilliant pink. The root may be a branched mass, a plate, or a disc attached to mud, other algæ, or rock, whilst the fronds are filamentous, membranous, crustaceous, or calcareous. The asexual organs consist of sporangia whose entire contents in some genera escape as a single non-motile spore. In the majority, however, each sporangium contains four non-motile spores. The sporangia are solitary or grouped in sori, and often sunk in the tissue of the frond or in special branches. The sexual organs are antheridia and procarpia. The antheridia are generally modified terminal branches or special areas in the thallus (of the more succulent forms), from which are derived short rod-like fertilising cells, here called pollinoids. The female organ is a procarp, whose structure varies in complexity in the different orders of Rhodophyceæ. In the simplest condition it recalls



Fig. 5.—*Griffithsia setacea* (one-half natural size). (After Thuret.)

forms, popularly classed as 'seaweeds' by seaside visitors and sold as such after being fancifully tinted, are in no respect related to the forms we have been considering, but really belong to the zoophyte division (Hydrozoa) of the animal kingdom.



Fig. 6.—*Odonthalia dentata* (one-third natural size).

the female organ of Coleochaete, and consists of a rounded cell with a long filamentous apical portion, the *trichogyne*. In higher members of the series the trichogyne is separated from that portion of the procarp from which the products of fertilisation (*carpospores*) are derived by one or more intermediate cells, the *trichophore*, and the basal part itself may become multicellular, all or only some of the cells of which produce the pro-

ducts of fertilisation. Fertilisation is effected by fusion of a pollinoid with the trichogyne, the immediate result being the formation of a cluster of cells, the carpospores, derived from the fertile cells of the base.

These carpospores may form a mulberry-like mass (Nemalion), or be enclosed by a loose involucre of filaments (Griffithsia), or by an ovoid capsular investment with a terminal pore (Polysiphonia). In others again the collection of carpospores (cystocarp) is completely enclosed within a thick-walled spherical sac (Plocamium), or may be sunk in the tissue of the frond (Dumontia). The Rhodophyceæ embrace a large number of orders, the representatives of several of which form well-known objects of interest on the seashore. The best known of these perhaps are Carrageen (*Chondrus crispus*), Dulse (*Rhododymenia palmata*), and Laver (*Porphyra laciniata*). The genera Callithamnion, Delesseria, Nitophyllum, Plocamium, and Odonthalia are well known to collectors for the beauty of their fronds. In concluding this article it may be of interest to point out that the vast collection of feathery plant-like



Fig. 7.—*Corallina officinalis*, a calcareous seaweed (natural size).

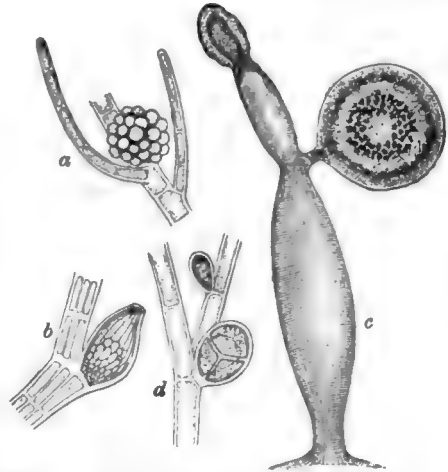

Fig. 8.—Reproductive Organs of the Rhodophyceæ: a, cystocarp of *Spermothamnion turneri*; b, cystocarp of *Polysiphonia urcolata*; c, cystocarp and antheridium of *Catenella opuntia*; d, tetrasporangium of *Callithamnion tenuissimum*.

forms, popularly classed as 'seaweeds' by seaside visitors and sold as such after being fancifully tinted, are in no respect related to the forms we have been considering, but really belong to the zoophyte division (Hydrozoa) of the animal kingdom.

For British Seaweeds, see Harvey, *Phycologia Britannica*; Gray, *British Seaweeds*; Landsborough, *Popular History of British Seaweeds*. General and Systematic: Agardh, *Species, Genera, et Ordines Algarum*; Thuret, *Études Phycologiques*; Bornet et Thuret, *Notes Algologiques*; Hauck, *Die Meeresalgen*; Reinke, *Atlas Meeresalgen*; Falkenberg in Schenk's *Handbuch der Botanik*; Schmits, *Untersuchungen über die Befruchtung der Florideen*.

Sea-wolf. See WOLF-FISH.

Sebastian, king of Portugal (q.v.), a grandson of the Emperor Charles V., perished at the fight of Alcazar in Algeria, warring against the Moors, on 4th August 1578. Soon after the battle doubt was thrown upon his death, and impostors, pretending to be the chivalrous young king, began to crop up—first (in 1584) an adventurer, the son of a poor Portuguese potter, who was nicknamed, half in derision, half in raillery, the King of Penamacor; then came Matheus Alvares, a sort of brigand-insurgent; then in 1594 a Spanish cook of Madrigal in Castile. None of these people were taken seriously. A fourth impostor found more credence, one Marco Tullio Catizzone, a Calabrian, who first made his pretensions known at Venice in 1598. He was hanged at San Lucar in Spain in September 1603. The strongest support of these successive impostors was the undying belief of the common people of Portugal that their popular hero, Sebastian, would some day reappear. The belief grew particularly strong in 1807-8 during the French occupation of Portugal. And even so late as 1838 it was used as a rallying-cry by a party of insurrectionists amongst the Portuguese Brazilians. See M. D'Antas, *Les fauz Don Sébastien* (1866).

Sebastian, St., a martyr of the early church, was a native of Narbonne. Under Diocletian he became a captain of the prætorian guard, and secretly a Christian. It coming to the ears of Diocletian how Sebastian personally encouraged those who were being led out to death for being Christians, the emperor had his captain tied to a stake and shot to death by archers. But they did not wholly kill him; a pious woman, Irene by name, took him away, and tended his wounds. As soon as he was recovered Sebastian boldly faced the tyrant, and upbraided him for his cruelty. Diocletian then ordered him to be beaten to death (288) with rods. He is a protector against plague and pestilence, and is specially honoured on 20th January. His first martyrdom—a young and handsome soldier bristling with arrows—was a favourite subject for the Italian religious painters, as Mantegna, Veronese, and Domenichino.

Sebastiani, FRANÇOIS HORACE BASTIEN, COUNT, marshal of France, was born November 10, 1772, at Porta d'Ampugnano, a village near Bastia, in Corsica. Entering the French army in 1789, he became one of Napoleon's most devoted partisans, and advanced rapidly. He fought at Marengo, executed some important diplomatic service in Turkey in 1802-3, after which he became general of brigade, and was wounded at Austerlitz. In 1806 he was again deputed to Turkey, this time to break the alliance of the Porte with Russia and England. His mission was successful, and Turkey declared war upon the allies. Thereupon the English fleet forced a passage through the Dardanelles, and cast anchor before Constantinople. Sebastiani, however, speedily put the coast batteries in a state fit for action, and got several small gunboats afloat. But the deposition of the sultan and the treaty of Tilsit put an end to the French intrigues in Turkey, and Sebastiani was recalled (June 1807). He subsequently commanded the fourth French army corps in Spain, and distinguished himself in the Russian campaign of 1812 and at Leipzig. On the exile of Napoleon to Elba he gave in his adherence to the Bourbon government, but joined his old master on his return. After the revolution of 1830 he held for brief periods the portfolios of naval and foreign affairs, and the embassies to Naples and London, but was more distinguished for his elegance and graceful demeanour in the Parisian salons than as a politician or administrator. He was made a marshal of France in 1840, and died at Paris, July 20, 1851.

Sebastiano del Piombo, Italian painter, whose family name was LUCIANI, and who got his nickname 'Of the Seal' (*Piombo*) because at the accession of his patron, Giulio de' Medici, as pope (Clement VII.) in 1523 he was given the office of sealer of papal briefs. He was born at Venice in 1485, and learned the art of painting from Giovanni Bellini and Giorgione. After painting a St Chrysostom for the church of that saint in Venice, Sebastiano was taken to Rome by Agostino Chigi (q.v.) about 1512. He helped to decorate Chigi's palace of Farnesina with frescoes illustrating classical mythology, and by his excellence as a colourist won the esteem and friendship of Michelangelo. The two seem then to have worked in conjunction, Sebastiano carrying out in colour designs and drawings made by Michelangelo. Amongst the fruits of this artistic partnership three pictures at least are of the highest rank—viz. 'The Raising of Lazarus' (in the London National Gallery), and a couple of scenes from the last days of Christ (in the church of St Peter in Montorio at Rome). Sebastiano, who possessed no great powers of invention, excelled also as a portrait-painter. The best specimens of his skill in this particular line embrace portraits of Pope Clement VII., Andrea Doria, two members of the Colonna family, Sebastiano himself, Cardinal Pole, and a lady as St Agatha. An indolent man and a dilatory, Sebastiano did little painting after his appointment as papal seal-keeper; yet he invented a method of painting on slate and stone. He died at Rome in 1547.

Sebastopol, or SEVASTOPOL, a Russian seaport and fortress, is situated near the south-west extremity of the Crimea, on the southern side of one of the finest natural harbours in the world, $\frac{1}{2}$ miles long from east to west and $\frac{1}{4}$ mile across. The place is celebrated for the long siege of the allies during the Crimean war of 1854-55. The town and harbour were defended by several forts and batteries, mounted by 700 guns in all, some of heavy calibre. The forts were of immense strength, built of limestone faced with granite, on which artillery was found to make but little impression. On the land side, with the exception of a slight loop-holed wall extending partially round the western side, the town, previous to the siege, was entirely undefended; but the earthworks and fortifications then successively extemporised by the genius of General Todleben kept the armies of France and England at bay for eleven months, from October 1854 to September 1855. The place sustained repeated bombardments until the capture of the Malakoff and Redan works, on September 8, 1855, at length forced the Russians to evacuate the lines and retire to the north side. The town was completely ruined; the docks and forts still standing were blown up by French and English engineers, and by the treaty of Paris (1856) were not to be restored; but the restrictions were removed by the abrogation of the neutrality of the Black Sea by the Conference of London (1871). Since the siege the town has been in great part rebuilt, but at first grew slowly. Since 1885 the Russian government has restored the fortifications and reconstructed the docks. Sebastopol is again the naval port for the Black Sea fleet; and since 1899 the commercial port is transferred to Feodosia or Kaffa (q.v.). Before the closing of the commercial port, the value of imports (largely cotton and coal) was in some years over £1,000,000, and the exports (grain) £3,000,000; but the totals fluctuated somewhat violently, owing to customs regulations and good or bad harvests. Pop. (1897) 50,710, exclusive of a garrison of 12,000. Sebastopol was founded on the site of a Tartar village immediately after the Russian conquest of the

Crimea in 1783, under the orders of the Empress Catharine II. The promontory on which it stands was originally colonised by Greeks from Heraclea, in Asia Minor, and became known as the Heracleotic Chersonese.

See CRIMEAN WAR; Kinglake's *Invasion of the Crimea*, Hamley's *War in the Crimea* (1891), Todleben's *Vertheidigung von Sebastopol* (4 vols. Berlin, 1864-72), and Leo Tolstoi's vivid description of the siege in *Sebastopol* (Eng. trans. 1890).

Sebenico (Slav. *Sibenik*), a picturesque town of Austrian Dalmatia, stands on a landlocked bay of the Adriatic, 43 miles by a branch-line of railway NW. of Spalato. The chief ornament of the place is its cathedral, built all of stone, in 1430-1555. The style is Italian Gothic. Three forts and walls on the land side defend the city. Fishing is carried on, and there is some trade in wine and olive-oil. Pop. 6858. It was a favourite place of residence of the kings of Croatia, was made the seat of a bishopric in 1298, and repulsed a siege by the Turks in 1647. See Jackson's *Dalmatia* (vol. i. 1887).

Sebillot, PAUL, an eminent French folklorist, was born at Matignon, in the department of Côtes-du-Nord, February 6, 1843. After his studies at the communal college of Dinan, and a course of law at Rennes, he came to Paris to become a notary, but soon abandoned the pen for the pencil. The pursuit of his art carried him to Saint-Brieuc and Pont-Aven, and many an out-of-the-way corner of Brittany, and opened up to him stores of old-world lore in which he was to find the main interest of his life. From 1870 to 1883 he exhibited in the Salon as many as twenty pictures, but he gradually abandoned art for folklore, and made his name widely known by a series of admirable books. He succeeded to Henri Martin's seat in the Commission for Megalithic Monuments, became *chef du cabinet* at the ministry of Public Works, and was nominated Chevalier of the Legion of Honour in July 1889. He edited the *Revue des Traditions Populaires* from its foundation (1885), and acted as general secretary to the Congrès International des Traditions Populaires at Paris in 1889.

Among his works are *Contes Populaires de la Haute-Bretagne* (3 series, 1880, 1881, 1882); *Littérature Orale de la Haute-Bretagne* (1881); *Traditions et Superstitions de la Haute-Bretagne* (2 vols. 1882); *Contes de Terre et de Mer* (1883); *Gargantua dans les Traditions Populaires* (1883); *Le Blason Populaire de la France* (with H. Gaidoz, 1884); *Contes des Provinces de France* (1884); *Coutumes Populaires de la Haute-Bretagne* (1885); *Légendes, Croyances, et Superstitions de la Mer* (2 vols. 1886, 1887); besides Bibliographies of the folklore of Brittany, Alsace, Poitou, Auvergne, and France d'Outre-mer, and a host of papers on Breton language and folklore.

Secale. See RYE.

Secant. See TRIGONOMETRY.

Secchi, ANGELO, astronomer, was born at Reggio, 29th June 1818, and trained as a Jesuit, became professor of Physics at Washington, United States, and in 1850 at the Collegio Romano, and director of the Roman observatory, where he laboured till his death, 26th February 1878. His chief discoveries were in the region of spectrum analysis and solar physics; and, besides some 300 papers, he published in French *Le Soleil* (1870), and in Italian *L'Unita delle Forze Fisiche* (1869) and *Le Stelle* (1877).

Secession. See UNITED PRESBYTERIANS; also UNITED STATES.

Seckendorff, VEIT LUDWIG VON, statesman and theologian (1626-92), studied at Strasburg, and served successively the princes of Saxony and Brandenburg, being chancellor of the university of

Halle at his death. He is best known for a Latin compendium of church history (1664), and a work, *De Lutheranism* (1688), in reply to Maimbourg.—His nephew, FRIEDRICH HEINRICH (1673-1763), was distinguished as a field-marshal and diplomatist in the Austrian service, and was made a Count of the Empire.

Secker, THOMAS, Archbishop of Canterbury (1758-68), was born at Sibthorpe, Nottinghamshire, in 1693, the son of a Dissenter of independent means, who wished him to enter the ministry of his own communion. In 1716, however, the son turned to medicine, which he studied at London and Paris, ultimately taking his doctorate in physic at Leyden in 1721. Meanwhile, urged by his old schoolfellow, Joseph Butler, he had decided to take Anglican orders; in 1722 he graduated B.A. at Oxford, and in that and the following year he was ordained deacon and priest. His preferments were Houghton-le-Spring (1724), Ryton and a prebend at Durham (1727), chaplain to the king (1732), St James's, London (1733), Bishop of Bristol (1735), of Oxford (1737), Dean of St Paul's, for which he resigned the living of St James's (1750), and the primacy (1758). He was a wise, kindly, hard-working bishop, and a notable preacher in his day. He died 3d August 1768. See the *Review of his Life*, by Beilby Porteus (5th ed. 1797; originally prefixed to a posthumous edition of his sermons, &c. 1770).

Second is the sixtieth part of a minute, whether of time or of angular magnitude; formerly seconds having been distinguished as *minuta secunda*, from minutes or *minuta prima*. See CIRCLE, DEGREE, DAY.

Second Advent. See ADVENTISTS, MILLENNIUM.

Secondary, in Geology. See PETROGRAPHY, MESOZOIC.

Seconding is an arrangement by which officers of the British army, when extra-regimentally employed, become supernumeraries in their regiments, and have their places filled by others, so that the service may not suffer. Thus, a captain appointed adjutant of yeomanry, militia, or volunteers is placed upon the seconded list for the five years during which his appointment lasts. His place in the regiment is filled up, but his name (in italics) remains in its usual place in the *Army List*, his promotion goes on, and he is brought back at the end of his employment as soon as a vacancy occurs in his proper rank.

Second-sight, a gift of prophetic vision, long supposed in the Scottish Highlands and elsewhere to belong to particular persons. The most common form it took was to see the *uraith*, *fetch*, or shadowy second self of some person soon to die, often wrapped in a shroud, or attended with some other of the special circumstances of death or burial. Of course the prophetic character may easily enough have been a mere additional assumption, the time of occurrence of distant events being apt to be confused with the time of hearing of them. In the popular mind everywhere the mystery of death, and the instinctive human longing to believe in a continuity of conscious spiritual life and sympathy, have generated a belief in the probability of an appearance coinciding with, or soon succeeding, the death of an individual; and from this the step is easy to a belief in the possibility of similar appearances before death, in order to foreshadow or forewarn. For, if the appearance be admitted as a probability, it is not difficult to take a further step and attribute to it the function. For what more natural than to suppose that, just as the affection for a dead friend survives the separation of the grave, so the affections of the disembodied

spirit or apparitional ghost-soul should continue to cling to the persons loved on earth, and that he should seek by every possible means to give them forewarnings of things soon to happen? And what agents more natural than those gifted souls that stand between the living and the dead, who have attained clearness of spiritual vision by rising above the bondage of sense, through lonely meditation and inner communion with things unseen? Such are the seers to whom the gift of second-sight was once attributed in the Highlands; and we find, as was to be expected, that most often they were reputed men of severe and virtuous life, who would gladly have lost their faculty if they could, and indeed were often sorely troubled in their minds as to whether it was not something that had come from the devil and not from God. In Aubrey's account we read of one who besought the presbytery to pray for him that he should be relieved from this burden, and how after special supplication and confession it was taken from him. Among the Covenanters too the gift of special foresight and prophecy was one vouchsafed to men like Peden, eminent for holiness and spiritual elevation. The gift seems not to have descended by succession, although this is stated to have been the case in Skye before the gospel reached it, and there was long a persistent belief that it belonged to the seventh son of a seventh son; according to some it appears in special cases to have been capable of being communicated from one person to another. Martin in his *Description of the Western Isles of Scotland* (1703) gives a full account of the second-sight, with a classification of the special visions usually seen, which is conveniently summarised in the seventh chapter of Defoe's well-known *Life and Adventures of Duncan Campbell* (c. 1680-1730), the deaf and dumb soothsayer, who inherited the faculty from his Lapland mother. With regard to the difficult question of the determination of the time between the sight and the fulfilment, we read here that if an object was seen early in the morning the event would be accomplished a few hours afterwards; if at noon, the same day; and if at night, the accomplishment would take place weeks, months, and sometimes years afterwards, according to the time of night the vision was beheld. The appearance of a shroud was an infallible prognostic of death, and the nearness or remoteness of the event was judged by the amount of the body that was covered by the ghastly sheet; if it was not seen above the middle, a delay of a twelvemonth might be hoped for; but if it ascended high towards the head, the mortal hour was close at hand. The reader will remember the splendid artistic use made of an analogous notion to this by Rossetti in *The King's Tragedy*. The vision makes such a lively impression upon the seers, continues Martin, that they neither see nor think of anything else except the vision, as long as it continues; the eyelids of the seer are rigidly fixed, and the eyes continue staring until the object vanishes. Sir Walter Scott has put the second-sight to fine use in *Waverley*, *The Legend of Montrose*, and elsewhere.

The gradation of symbolical appearances we have mentioned strikes the imagination and gives something like a system to the supernatural phenomena. But if we turn to the cases related we find no such regular order and exactness. The evidence is vague and confused, and the incidents are often of the most trivial character, the revelations, apparently mere subjective hallucinations, commonly made to poor illiterate men, predisposed from their conditions of life to melancholy and superstition. Moreover, one standing weakness is that such predictions may force their own fulfilment, and the indefiniteness of the time provides a convenient

loophole of escape for the conscience. As we see in the popular notions about dreams, there is a besetting snare of a tendency unconsciously to antedate the later impression and to read back details into the dream. Even contradictory dreams are forced to the required interpretation on principles of implied symbolism or even of mere conventional and completely irrational explanation; and similarly we find unrecognised apparitions capable of symbolic explanation, as a black dog appearing before a death, phantasmal lights, and the like, as well as weeping, the screech of the *banshee*, &c., in the region of sounds. Again, coincidences, really due to pure accident, account for much; and still more the invariable leaning of the primitive mind to false analogies and to confound the *post hoc* with the *propter hoc*. The savage and the enthusiast alike think in the same vicious circle; what he believes he therefore sees, and what he sees he therefore believes.

Stories of second-sight meet us also in the actual world of history. We find it in the story of Wallace and Bruce; again in the famous vision that Thomas the Rhymer had of the death of Alexander III. at Kinghorn; associated with the tragic fate of James I.; and in the unheeded warning given to the Scottish nobles before going to find their fate at Flodden. A Scottish seer is said to have foretold the unhappy career of Charles I., and another the violent death of Villiers, Duke of Buckingham. In 1652 Sir George Mackenzie, afterwards Lord Tarbat, wrote a minute account of its manifestations, addressed to the celebrated Robert Boyle, which is published in the correspondence of Samuel Pepys. Aubrey throughout life had strong interest in the superstition, and has recorded not a few examples. Next came Martin's copious description, then the Rev. John Fraser's *Authentic Instances* (1707), and in 1763 the ambitious but poor and credulous *Treatise on the Second Sight* by Theophilus Insulanus. A fresh revival of interest in the subject took place after the publication of Dr Johnson's memorable *Journey to the Hebrides* (1775). Johnson was naturally superstitious, and would willingly have believed in the possibility of messages from the other world. But his love of truth was too strong to be satisfied with the evidence, and he confessed that he never could 'advance his curiosity to conviction, but came away at last only willing to believe.' On one occasion Boswell tells us he laid down a sound canon for such questions, incapable to be shaken: 'We could have no certainty of the truth of supernatural appearances unless something was told us which we could not know by ordinary means, or something done which could not be done but by supernatural power; that Pharaoh, in reason and justice, required such evidence from Moses; nay, that our Saviour said: "If I had not done among them the works which none other man did, they had not had sin." As we have seen, spectral sights may be caused by dreams, and every night so many are dreamed that some must come true; morbid conditions of mind or body may account for many more; not to speak of accidental optical illusions, or the workings of an abnormally vivid imagination. And again, from the other side, we may say that it is hardly a compliment to the idea of a divine providence to suppose that special miracles are wrought to announce the marriage or death of a Highland peasant, the wreck of a boat, the winner of a race, or the arrival of a stranger in a remote island of the Hebrides. Nothing wiser on this question generally has been written than Mrs Henry Sidgwick's paper, 'On the Evidence for Premonitions,' in the *Proceedings of the Society for Psychological Research* for December 1888. She defines premonitions as predictions, foreshadowings, or warnings of coming events,

which afford, if believed, a knowledge of the future greater than that which human beings could obtain by exercising their faculties on the facts before them; and her conclusion is that the evidence at present collected does not seem sufficient to warrant a conclusion in favour of these. The whole of the first-hand cases up till that time before the Psychological Society amounted to 240, about 66 per cent. of these being dreams, thus falling far short both in quantity and quality of the evidence for *telepathy*. Setting aside the two-thirds dreams, she classifies the remaining third as follows: (1) Visual hallucinations—persons or objects seen when nothing was really there; (2) auditory hallucinations—voices or other sounds heard when, according to the belief of the percipient, there was no real natural sound; (3) verbal predictions, as by fortune-tellers; (4) non-externalised impressions of various kinds—namely, ideas of more or less definiteness, mental visions, mental voices, and motor impulses. See the articles ANIMISM, APPARITIONS, DIVINATION, DREAMING, and MAGIC.

Secret, DISCIPLINE OF THE. See DISCIPLINA ARCANI.

Secretary-bird, also called SECRETARY-FALCON, or SERPENT-EATER (*Serpentarius reptilivorus*), a genus of birds of prey, which has been variously placed by naturalists among the Falconidae and the Vulturidae, but must certainly be constituted into a distinct family, Gypogeranidae. The legs are very long, as in the Grallæ, to some members of which group it shows other points of affinity. The tibiae are completely feathered, but the tarsi and toes are destitute of feathers. The tarsi are covered in front with long, large scales. The toes are armed with sharp claws; but they are short, and the feet are not formed for grasping. The hind-toe is very short. The neck is much longer and the whole form of the bird more slender than in the Falconidae. The tail is very long. The best-known species is an inhabitant of the arid plains of South Africa.



Secretary-bird (*Serpentarius reptilivorus*).

It is about three feet in length; the plumage bluish gray. It has an occipital crest of feathers without barbs at the base, which can be raised or depressed at pleasure, and the name 'Secretary' was given to it by the colonists at the Cape of Good Hope from their fancied resemblance to pens stuck behind the ear. It feeds chiefly on reptiles of all kinds, which it devours in great numbers, and is so highly valued on account of the constant war which it wages against serpents that a fine is inflicted in the Cape Colony for shooting it. It fearlessly attacks the most venomous serpents,

stunning them with blows of its wing, or seizing and carrying them into the air to such a height that they are killed by the fall. It uses its feet also to overpower its prey, striking violent blows with them. Small serpents are swallowed entire; the larger ones are torn to pieces. The secretary-bird is most frequently seen in pairs, or solitary. It is tamed as a protector of poultry-yards, but if not sufficiently fed is apt to help itself to a chicken or duckling. An attempt has been made to introduce this bird into Martinique in order to reduce the number of venomous serpents in that island.

Secretary of State, an ancient and important office in the government of England. The oldest record of its existence is in the reign of Henry III., when John Maunsell is described as 'secretarius noster.' Prior to the Restoration the holder of this office was generally styled the 'king's chief (or 'principal') secretary'; he had the custody of the king's signet, and discharged his duties with the assistance of four clerks. Two secretaries are said to have been first appointed towards the close of the reign of Henry VIII. The office, always one of influence, gradually grew in importance. On the Union of 1707 Anne added a third secretary of state for Scotland, which office, however, was soon done away with. In the reign of George III. there were at first but two secretaries; for a time there was a third for America, but his office was abolished by statute in 1782. While the secretaries were two in number both equally directed home affairs; to the one were committed the foreign affairs of the northern, to the other of the southern department. Irish affairs belonged to the province of the elder secretary.

There are now five principal secretaries of state, who are respectively appointed for home affairs, foreign affairs, war, the colonies, and India. They are all appointed by the sovereign by delivery of the seals of office, followed by the issue of a patent under the great seal, and they are always members of the Privy-council and of the cabinet. Though each has his own department, he is considered capable of discharging the duties of the others; a member of the House of Commons if removed from one secretaryship to another does not thereby vacate his seat. Not more than four secretaries or under-secretaries of state may sit at one time in the House of Commons.

The Secretary of State for the Home Department has the charge of the maintenance of the internal peace of the United Kingdom, the security of the laws, and the administration of justice so far as the royal prerogative is involved in it. He provides for the suppression of riots. He has the ultimate supervision of all that relates to prisons and criminals; and numerous statutory powers have been given him regarding police, sanitary matters, the regulation of labour, &c. He is responsible for the exercise of the prerogative of mercy; application for pardon or commutation of sentence forms no small part of the work imposed on the Home Secretary. All patents, licenses, dispensations, charters of incorporation, commissions of the peace and of inquiry pass through his office. He recommends persons to the sovereign for civil knighthood, and is empowered to grant certificates of Naturalisation (q.v.) to foreigners. He is the organ of communication between the cabinet and the viceregal government of Ireland, for which he is responsible, and is informed of and advises all the graver measures adopted in that country. His patronage is very considerable, including the nomination to a large number of judicial offices. Among his powers is that of examining and committing for trial persons charged with offences against the state, a function which, though its legality has been called in question, has been often exercised.

The Secretary of State for Foreign Affairs is the responsible adviser of the crown in all communications between the government and foreign powers. He negotiates treaties, either directly with the foreign ministers resident in the country, or through the British ministers abroad. It is his duty to inquire into the complaints of British subjects residing in foreign countries, to afford them protection, and to demand redress for their grievances. The Foreign Secretary recommends to the sovereign all ambassadors, ministers, and consuls to represent this country abroad. He grants Passports (q.v.) to British subjects travelling abroad.

The Secretary for the Colonial Department has the supervision of the laws and customs of the colonies and dependencies (except India), watches over their interests, apportioning the imperial troops necessary for their defence or police, appoints governors, and sanctions or disallows laws reserved for his consideration by colonial governors. The responsibilities of the colonial office in regard to the greater colonies have been much decreased by the extension of responsible government (see COLONY).

Each of these secretaries of state is assisted by two under-secretaries of state—one permanent, while the other is a political officer dependent on the administration in power.

The Secretary of State for India, whose office dates from the abolition in 1858 of the double government of India by the Court of East India Directors and Board of Control, has the same control over the government of India which was formerly exercised by these bodies, and countersigns all warrants and orders under the sign-manual relating to India. He is assisted by an under-secretary, who is also a member of the legislature and loses office with the cabinet, and by a permanent under-secretary and assistant-secretary, as also by a council of fifteen members, over whom he presides. Every order sent to India must be signed by the secretary, and all despatches from governments and presidencies in India must be addressed to the secretary.

The Secretary of State for War has the superintendence of all matters connected with the army, assisted by the commander-in-chief, and is responsible for the amount of the military establishment. He prepares for the royal signature and countersigns commissions in the army, and recommends to the sovereign for the order of Knighthood of the Bath. Down to the Crimean war there was also a Secretary-at-war, a high officer of the ministry, who had the control of the financial arrangements of the army, and was the responsible medium for parliamentary supervision in military affairs. He was quite independent of the Secretary of State and of the military authorities.

The Chief-secretary to the Lord-lieutenant of Ireland and the Secretary for Scotland do not rank as secretaries of state, though they may be members of the cabinet. For a full account of the secretarial departments, see Todd's *Parliamentary Government in England* (2d ed. 1891).

In the cabinet of the United States there is one Secretary of State, who is specially charged with foreign affairs.

Secretary of the Navy, now called the Secretary to the Admiralty, is the conventional title of the parliamentary secretary to the Board of Admiralty. This post is conferred on a ministerial supporter in the House of Commons, in which when the First Lord of the Admiralty is a peer he is the exponent of naval policy; and he is also mainly responsible for the financial administration of the service. He changes of course with the ministry, of which he is a subordinate member, and receives a salary of £2000 a year. There is

also a permanent secretary, generally a naval officer, who holds office for life, and receives £1700 a year. He is responsible for the discipline of the Admiralty Office. This appointment is of long standing, and was held by the celebrated Samuel Pepys.

Secret Chambers were mostly of post-Reformation construction, designed as 'priest's holes,' or hiding-places for 'trafficking mass-priests,' in the days when to say mass was either high-treason or felony. They might also, of course, conceal Jacobite or other conspirators; and that of Danby Hall, the seat of the Scropes, was found, on its rediscovery about 1800, to contain arms and saddlery for forty or fifty troopers, stored up, it would seem, against some intended rising. Brother Nicholas Owen, S.J., *alias* 'Little John,' who with Father Garnet (q.v.) was arrested at Hindlip Hall, and who is termed 'that useful cunning joiner of those times,' was a chief contriver of these secret chambers, and after his capture 'was divers times hung upon a Topcliff rack in the Tower of London to compel him to betray the hiding-places he had made up and down the land.' They were oftenest formed in the thickness of a wall, and the entrance to them might be through a panel, behind a hinged picture, beneath a hearth-stone, up a chimney, &c. About a century since at Irlham Hall, Lincolnshire, it was noticed that one of the chimneys of a cluster was unblackened, and it proved to be really a shaft to give light and air to a priest's hole, the entrance to which was gained by removing a single step between two servants' bedrooms. You then come to a panel, with a very small iron tube let into it, through which any message could be conveyed to the occupant. This panel removed, a ladder of four steps leads down to the secret chamber, which is 8 feet long, 5 broad, and just high enough to stand upright in. Another at Ingatestone Hall, the old seat of the Petres, is 14 feet long and 10 high, but only 2 wide; this contains an old chest for vestments. How cunningly these chambers were contrived may be seen in the fact that at Hindlip the minutest search was made ten whole days in vain, till Garnet came forth himself, forced by want of fresh air, not of food, for marmalade and other sweetmeats were lying by him, and 'broths and warm drinks had been passed to him by a reed through a little hole in a chimney that backed another chimney into a gentlewoman's chamber.' Smugglers during the 18th century had sometimes secret chambers of a sort, for the storage of 'run' goods, at farm-houses a few miles inland; nay, so late as 1860 one such was used for illicit malting in a Suffolk village, till the excise officer detected its whereabouts by pouring water over the floor above. But for the last *historical* instance of their use we must look abroad, to Nantes, where in 1832 the Duchess de Berri (q.v.), a corpulent lady, was, with two gentlemen, roasted out of a secret chamber at the back of a fireplace, after sixteen hours' patient endurance.

The following is a list of some of the best-known secret chambers, arranged under counties in alphabetical order, with the date sometimes of the erection of the mansion (not necessarily, of course, of the priest's hole) or of its demolition, and with the names of traditional occupants: *Berkshire*, Lyford; Milton, near Abingdon; Watcomb. *Bucks*, Dinton (regicide Mayne). *Berwick*, Bemersyde. *Cambridge*, Sawston. *Cheshire*, Bollington; Lyme Hall, near Disley. *Cornwall*, Bochym. *Cumberland*, Netherhall, near Maryport. *Derby*, Bradshaw Hall, near Chapel-en-le-Frith; Hallam. *Durham*, Bishop Middleham (in which a 'teetotaler drank himself to death with brandy,' Southey's *Commonplace Book*, 4th series, 354). *Essex*, Ingatestone (temp. Henry VIII.). *Forsfar*, Glamis Castle (the Toad-headed Monster). *Gloucester*, Bourton-on-the-Water (demolished 1834). *Hants*, Hinton-Ampner; Mapledurham, Moyles Court (*Lady Lisle's*

house); Titchborne. *Hereford*, Treago. *Herts*, Knebworth (1553, demolished 1811). *Lancashire*, Ashes, at Goomargh; Borwick; Lowstock Hall, in Bolton parish (demolished 1816); Lydiate; Mains Hall, in Kirkham parish (Cardinal Allen); Speke Hall; Widnes House, near Warrington; Stonyhurst (in great tower). *Leicester*, Long Clawson. *Lincoln*, Irnham Hall (c. 1500); Kingerby Hall; Upton. *Middlesex*, Canonbury Tower, Islington; Cromwell House, Highgate; White Welles House. *Monmouth*, Raglan Castle. *Norfolk*, Oxburgh House, *Northants*, Burghley House; Harrowden. *Northumberland*, Netherwitton (Lord Lovat?); Wallington Hall. *Notts*, Workop Manor (burned 1761). *Oxford*, Broughton Castle; Chastleton; Minster Lovel (Lord Lovel, Sinnel's adherent, starved to death here, 1487, and skeleton found in 18th century?). *Pembroke*, Carew Castle (temp. Henry I.). *Shropshire*, Boscobel (Charles II.); Pitchford; Plowden; White Ladies (Charles II.). *Somerset*, Trent Manor House (Charles II.). *Stafford*, Moseley Hall (Charles II.). *Suffolk*, 'Ancient House,' Ipswich (1567; Charles II.?). *Sussex*, Coldham Hall; Melford Hall. *Surrey*, Benton; Ham House, at Weybridge (1610, hiding-places shown to Evelyn by Duke of Norfolk); Sanderstead Court; Sutton Place, near Guildford (temp. Henry VIII.). *Sussex*, Ashbourne Place (Bishop Juxon); Cowdray (Lord Montague); Parham; Pax Hill, near Cuckfield (built by Andrew Boorde, q.v.); Slindon; Street Place; West Grinstead. *Warwick*, Congleton Court; Compton-Wyniates (c. 1520). *Wills*, Heale House, near Amesbury (Charles II.; visited by Dr Johnson, 1783). *Worcester*, Arniscott Manor House, near Shipston-on-Stour (George Fox the Quaker); Birsmorton Court (14th century; Sir John Oldcastle); Harborough Hall; Harvington; Hindlip Hall (eleven hiding-places, now demolished; see above); Little Malvern Court. *Yorkshire*, Abbey House, Whitby; Danby Hall, near Bedale; Dinsdale; the Grove, Leyburn; the 'New Building,' near Kirkby Knowle; Red House (Henry Slingsby).

See *Notes and Queries* for 1855-56 and 1879-85, *Chambers's Book of Days* (i. 433, 1869), and two articles in *Chambers's Journal* for Dec. 1883 and Oct. 1886.

Secretion is a vital process in which certain cells of the body form within themselves definite products, which accumulate and are usually discharged. The cells specialised for secreting are called glandular, and many are often united to form a Gland (q.v.). The definite products formed by the activity of the glandular cells are called secretions, this term being applied both to process and products. All the digestive juices, the silk of silk-worms, the webs of spiders, the wax of bees, the nectar of flowers, and the like, are secretions. They are formed by the activity of the living matter from materials derived from the blood, or, when there is no blood, from the supplies of food which otherwise reach the glandular cells. They are discharged sometimes by a slow outpouring comparable to filtration through the free surface of the cell, sometimes by the more or less complete rupture of the cell. The process of secretion is usually periodic, intervals of quiescence alternating with those of activity. See GLANDS, PHYSIOLOGY, DIGESTION. For the secretion of plants, see VEGETABLE PHYSIOLOGY.

Secret Service Moneys, in the widest sense of the term, include all funds placed at the disposal of ministers of state, to be expended at their discretion without giving an account. In the 18th century large sums were paid for secret service out of the king's civil list; these moneys were used chiefly for the purpose of bribing members of parliament. In 1782 Burke carried his scheme of financial reform; the amount to be paid from the civil list was limited to £10,000, and ministers expending secret service money were required to make a declaration that they had done so in accordance with the intentions of parliament. In 1886 the matter was further considered, and an act was passed under which the payment authorised by the law relating to the civil list was discontinued.

All moneys required for secret service are now included in the estimates; a sum of £35,000 has been voted on this account for some years past. The declarations required by Burke's Act are sufficiently stringent to prevent any gross abuse; there is no ground for the suggestion, still occasionally made, that secret service moneys are used in paying the election expenses of ministers. Almost all governments have some fund of which no public account is given; and all secret expenditure is naturally viewed with suspicion by the representatives of the taxpayers. See SPY.

Secret Societies, in some form or other, have existed in all ages of the world's history, not only amongst nations with well-organised systems of social and public life, but also amongst races that have never advanced beyond the elementary stages of social organisation. Religion and politics are the departments of human activity in which such societies have most prevailed; though they have also been formed for judiciary, scientific, civil, social, and even criminal purposes.

In the ancient world many of the more influential religions had their Mysteries (q.v.), the ceremonies connected with which were generally performed in secret, and only in the presence of those who had been duly initiated. These inner and more secret groups of priests and initiated worshippers existed in association with the worship of Mithras in Persia, of Orpheus and Dionysus in Greece, at Eleusis and elsewhere, of Osiris and Serapis in Egypt, and of the Great Mother (Cybele) in Phrygia. The main objects which these exclusive coteries had before them were of course various: in some cases the intention was to render the sacredness and binding force of religion all the stronger over the hearts and imaginations of men; in others to preserve the 'holy things' from the profanations and familiarities of the vulgar throng; in others to enrich the temple or shrine; and in yet others the ruling motive seems to have been solely the wish to keep in a few hands the power that invariably attaches itself to the priestly office. The followers of Pythagoras formed what was in many respects a secret religious society, though philosophy and political doctrine took a foremost place in their teachings. The Druids are often represented as practising secret rites, handed down through certain of the priests; but upon this matter the evidence is shadowy in the extreme. Amongst the Jews there proceeded from out of the Pharisees the puritanical Essenes (Chasidim), who for the purpose of living a holier life formed themselves into what were virtually religious clubs, characterised by many features common to exclusive religious societies. The Essenes were the forerunners of the Jewish Cabbalists (see CABBALA), who professed a secret system of theology and philosophy associated with mystic practices, and of the Christian Gnostics, who formed exclusive sects based on initiation and esoteric teaching (see GNOSTICISM). The lineal successors of these last were the various mediæval sects of Cathari (q.v.), most of whom invested their teaching and their worship with many features of mystery. In the Roman Catholic Church the office of the Inquisition deserves to be called a secret society, and so does the order of the Jesuits, especially in respect of its methods; though in both cases the secrecy was due to political rather than to strictly religious causes. The Knights Templars (q.v.) towards the close of their history as a distinct order seem in several cases to have lapsed into the practice of secret rites and belief in certain secret doctrines. The Druses hold a peculiar place as the inheritors of a national religion which is jealously exclusive both in doctrine and ritual.

The Rosicrucians (q.v.) and the Freemasons

(q.v.) are perhaps the best known of the secret societies that have cultivated something like social aims. The former had their origin in the 17th century, and directed their attention to the discovery of such things as the philosopher's stone and the elixir of life, to the exorcism of spirits, and such-like pursuits. Speculative Freemasonry does not go further back than the 18th century; its professed objects are philanthropic and moral. There are associations similar in character to it in Tahiti and others of the Pacific Islands, and amongst the Foulah and the Negroes of Sierra Leone and the adjacent parts of Africa. The celebrated *Vehmgerichte* (q.v.) or secret courts of Westphalia arose in a time of great public confusion, and made it their business to maintain that order and respect for the law which it should have been the concern of the emperor and his associates to have secured and preserved. There existed in Sicily from the 12th to the 18th century an organisation (the Beati Paoli) very similar to the *Vehmgerichte*. On the other hand, there have been numerous associations of a secret kind formed for criminal purposes, and for mutual assistance against and in defiance of the laws of the land; the Assassins in Persia and Syria, the Thugs in India, the Camorra, the Mafia, and the Decisi (c. 1815) in Italy, the Chauffeurs in France (who arose during the religious wars and were not suppressed until the Revolution), and the Garduna in Spain (formed after the wars against the Moors; suppressed in 1822) may be instanced.

The Illuminati (q.v.), the authors of a movement that grew up in Germany in the end of the 18th century, united political and religious ends, and may be said, summarily, to have aimed at realising the ideals of the French Revolution. The following century was wonderfully prolific in political secret societies. Italy was literally honeycombed with them during the years she was struggling for her independence; the best known was that of the Carbonari (q.v.; see also MAZZINI). At the same time there were similar societies, with similar revolutionary or democratic or constitutional aims, in other countries of Europe, as the Burschenschaft and Landsmannschaft societies in Germany, the Associated Patriots in France, the Comuneros in Spain, the Hetairia in Greece, the Society of United Slavonians and the Decabrists in Russia, the Polish Templars, and the associations known as Young Germany, Young Italy, Young Poland, Young Switzerland. The German Tugendbund (q.v.) was hardly a secret society in the proper sense of the term. Nearly all the political revolutions that took place in France during the course of the 19th century were greatly fomented by secret societies, especially the revolution of 1848. Here too should be mentioned the Omladina, a movement having for its headquarters Servia and Belgrade, and for its objects the establishment of a republican pan-slavic confederation. The most momentous movements of a socio-political tendency that have sprung up on the Continent, and spread to some extent to England, are those of the Nihilists (see NIHILISM), the Anarchists, and various sects of Socialists (cf. INTERNATIONAL).

Ireland has been the breeding-ground of political societies directing their efforts against the English rule, or against one or the other of the two religious bodies in the island (Protestants and Roman Catholics), though motives arising out of agrarian distress have generally played an important part in the agitations these societies have set agoing. The White Boys, the Oak Boys, Right Boys, Peep o' Day Boys (see RIBBONISM), the United Irishmen, the Fenians, the Land League movement fostered by Mr Parnell (q.v.), are all well-known cases in point; see also ORANGEMEN.

There are perhaps no peoples in the world who favour secret societies more than the Chinese and the inhabitants of the United States. But whilst the objects of these associations in the former country are mostly political, in the latter they are predominantly social. The most powerful organisation of this nature in China—indeed its ramifications extend to all parts of the world where Chinamen are allowed to settle—is the Tien-ti Hwuy (Union of Heaven and Earth), which presents many features analogous to Freemasonry, such as secret signs, solemn initiation ceremonies, peculiar observances, and so forth; but its principal object seems to be the overthrow of the existing Manchu dynasty and the restoration of the last Chinese dynasty of the Ming. The White Lily is very wealthy and very strict in its rules, and its members are popularly accredited with the possession of magical powers. But about the real purposes of this, as of most other secret societies that exist amongst the Chinese, our information is exceedingly scanty. The Society of the Elder Brethren, which is, generally speaking, a combination of the most lawless elements of the population in the central provinces (Honan to Hunan), proclaims a fanatical hatred to all foreigners, including the Manchus. Secret societies of all kinds, and for nearly all conceivable purposes, are found in the United States, from the Vigilance Societies (q.v.), formed in the western states for the preservation of public order, to the Phi Beta Kappa and similar associations in the colleges and universities. The Danites, the Knights of Labour, the Ku-Klux Klan, the Molly Maguires (see these articles) may be instanced among notable organisations of native growth; the Mafia (q.v.) and some European societies have also extended their ramifications hither.

See C. W. Heckethorn, *Secret Societies of all Ages* (2 vols. 1874), where other books are quoted; T. Frost, *Secret Societies of the European Revolution* (1876); L. de la Hodde, *Secret Societies of France* (Philadelphia, 1856); F. H. Balfour, *Waifs and Strays from the Far East* (Lond. 1876), and a paper by him in the *Journal of the Manchester Geographical Society* (January 1892); and *Harper's Magazine* (September 1891).

Secret Writing. See CRYPTOGRAPHY, INK.

Secole. See BENARES.

Sector, in Geometry, is a portion of a circle included between two radii and the intercepted arc of the circumference. The area of a sector is equal to that of a triangle whose base is equal in length to the intercepted arc, and whose perpendicular height is equal to the length of the radius.

Secularism is the term applied to a system of ethical principles advocated from about 1846 by the present writer. It is a new form of Free Thought seeking human improvement by the instrumentality of material means; and it aims to substitute the piety of usefulness for the usefulness of piety, and to treat error as a defect of knowledge rather than a defect of right intention. It takes as its axiom that what is best for humanity will command the approval of the author of humanity; what is 'best for humanity' being determinable by reason, tested in this life by the experience of this life. Experience teaches that science is the providence of man. Science teaches that improvement and progress can be surely attained by the wise use of material agencies. Material agencies act by causation—the law alike of nature and mind. Causation in will shows that, if men can be induced to pursue that conduct which is most useful, habit will render it the most agreeable. Causation in opinion implies that error can only be eradicated by the eradication of its cause. False ideas can only be extirpated by true ideas.

Hence the social aim of Secularism is to establish those material conditions in which, as far as forethought can compass them, it shall be impossible for a man to be deprived or poor. Morality of conduct—the main thing in this life—is determined by its conduciveness to the welfare of others as well as ourselves. This utilitarian rule has this advantage, that, while the strongest faith may co-exist with the greatest ignorance, utilitarian morality can only begin with intelligence, and the morality will be on the whole the greater the wider intelligence becomes.

Since the Secularist's profession is that mankind can be largely improved by well-devised *material* means, it belongs to him to inculcate a sense of responsibility for the condition of the world, so far as his exertions or influence can extend. The theological mind cares mainly for the souls and little for the social welfare of others. The Secularist holds that Truth and solicitude for the social welfare of others are the proper concern of a soul worth saving. Only minds with goodness in them have the merit of future existence in them; minds without veracity and generosity die; the element of death is in them already. The majority of people conduct life by believing what they wish, not by conforming to what they know—an easy, loose, pleasant kind of faith which commands many followers; belief without inquiry and action without the sense of social responsibility are always popular. He who undertakes the duty of selecting his principles protects himself from hereditary error. Every step towards reasoned truth implies thought, investigation, patience, courage, and accountability.

But to acquire truth thought must be free, un-intimidated by any threat or penalty, legal, spiritual, or social; if inquiry must end in a prescribed conclusion or the inquirer perish everlastingly, no one but a fool would inquire at all. Unless men regard truth as higher than consequence thought must be sterile. Even inquiry, with whatever courage conducted, would be sterile without the right of free publicity of the results; the publication of new truth is the duty of the thinker, and his silence or supineness is a social crime. The free search, the free publicity, the free criticism, and free action of opinion are necessary secular conditions—conditions which have never been insisted upon as necessary to spiritual life. Though these conditions are used by science they are not claimed by it, being outside its province. Secular-minded thinkers alone have formulated and vindicated these conditions.

A main object of Secularism is to establish morality on grounds independent of Christianity, for so long as morality is supposed to have but that foundation it will not be influential on those who reject or do not accept Christianity. There is unquestionably a vast outlying class in every European country, and still more in India, who are without the pale of Christianity. Secularism is intended for these, and for all who deem theology indefinite, inadequate, undesirable, or unreliable. The object of Secularism is to afford these classes a knowledge of principles addressed to their common reason and intelligence, by an appeal to principles of a secular nature, common to humanity in every state and clime. The reality of Deity and a future state, being indeterminable by the experience of this life, are not secular questions; Atheism and Theism are alike without the means of demonstrating their own truth, and, though they may be subjects of personal belief, cannot be secular tenets—provable by experience. What is incapable of proof is usually decided by desire, and is without the conditions of uniformity or certitude. Morality, which

fulfils the conditions of the highest religion, is attainable irrespective of belief in things outside this world. The uses of the universe are no more dependent upon the knowledge of its origin than the uses of a habitation are dependent on the knowledge of its architect.

Secularism does not ask to be esteemed a Christian system as Christianity is commonly accepted, but an ethical system. So far as Christianity is moral Secularism has common ground with it; but its reasons for being moral are not Christian reasons, but human considerations alone. Christianity attaches salvation to belief; Secularism seeks it in conduct. Christianity holds that inquiry must end in faith. Secularism teaches that regardless of consequences it should end in truth, and maintains intelligent sincerity to be sinless—not errorless, but without guilt. The doctrines of eternal perdition for honest dissent, of the natural depravity of man, of the wilfulness of an uncaused will, and of delivrance by prayers are immoral, discouraging, and traitorous; and secular controversy on the moral tendencies of these tenets is alone useful as advancing and vindicating secular ideas. Upon questions of miracles, prophecy, genuineness or inspiration of Scripture Secularism troubles itself little. If miracles are good it is a pity they have ceased; morality needs no inspiration. Precepts have no force unless corroborated by experience, and it is ill with men when they take authority for truth, instead of truth for authority.

Secularism does not say there is no light or guidance elsewhere, but maintains that there is light and guidance in secular truth, whose conditions and sanctions exist independently, and act independently. Secular knowledge is that kind of knowledge which is founded in this life, which relates to the conduct of this life, conduces to the welfare of this life, and is capable of being tested by the experience of this life. Mathematics, botany, chemistry, political economy are secular subjects of instruction; Secularism includes the education of the conscience. If a sum in arithmetic is wrong it can be proved by a new way of working it; if a medical recipe is wrong the effect is discoverable on the health; if a political law is wrong this is sooner or later apparent in the disaster it brings with it; but if a theological belief is wrong we must die to find it out.

Secularism is separateness and does not confuse together distinct things. By repute there are two worlds—the unknown and known. The interpreter of the unknown is theology; the interpreter of the known is experience, which teaches the uses of this world. Since mankind would perish if all were called upon to agree upon the authorship of the world before using it for the purposes of life, the Secularist forbids no opinion and gives none on a matter beyond his knowledge. He does not undertake to say whether nature is the outcome of intellect, or intellect the outcome of nature. He believes that there is no religion higher than truth, and that the reverence of that which is honest, and just, and compassionate exalts humanity; that manliness is self-helping and not mendicant, and vexes not the ears of the All-Wise with capricious supplications. Secularism seeks to create independent thinkers in all parties, and its adherents are content when their advocacy induces others in religious, social, and political movements to follow in the path of reason, experience, and material improvement.

See the following works by the present writer: *Principles of Secularism* (1855), *Secular Review* (1876), *Present Day* (1886), *Trial of Theism accused of obstructing Secular Progress* (1868). See also AGNOSTICISM.

Seculars. See CLERGY.

Secunderábad. See HYDERABAD.

Securite, the name of a flameless explosive, a granulated yellow powder understood to be a combination of ammonium nitrate and one of the benzol derivatives.

Security, in legal language, means a right conferred on a creditor which makes him secure or certain to recover what is due to him. Security may be given by setting aside some part of the debtor's property to answer the creditor's claim; for the modes in which this may be done, see PAWN-BROKING and MORTGAGE. 'Securities for money' is a very wide term, including the shares, stocks, and debentures of public companies, &c. See Cavanagh's *Law of Money Securities* (2d ed. 1885) for a compendious account of the English law relating to the subject. And see the articles CAUTION, GUARANTY.

Sedalia, capital of Pettis county, Missouri, 188 miles by rail W. of St Louis. It has large railway-shops, flour-mills, and manufactories of woollens, machinery and agricultural implements, wagons, furniture, and soap. Pop. (1890) 14,068.

Sedan, a town and frontier fortress of France, dept. of Ardennes, stands on the Meuse, 64 miles by rail NE. of Rheims. Colbert founded here cloth-factories, the fabrics of which have a European reputation; some 10,000 workmen are employed in this industry and its branches. Various branches of metal-working are carried on, and there is an active trade in wool. Pop. (1872) 13,807; (1891) 20,138. The fortress, or rather the citadel, capitulated to the Germans in 1815; but Sedan is chiefly noted for the surrender (September 2, 1870) of Napoleon III. and an army of 86,000 men, with all their accoutrements and baggage, to the Germans in the Franco-German war. The fortress was dismantled after 1875. Marshals Turenne and Macdonald were born here. Previous to its incorporation with France (1642) it was the capital of an independent principality (that of the Counts de la Marck and later dukes of Bouillon) and a Protestant stronghold. Its industrial prosperity was largely due to the influx of Huguenots; and at its theological seminary, famous until the revocation of the Edict of Nantes, notable Scotsmen such as Andrew Melville taught.

Sedan Chair, a portable covered vehicle for carrying a single person, borne on two poles by two men. The name is derived from the town of Sedan, where this species of conveyance is said to have been invented. The Duke of Buckingham used one in the reign of James I., a proceeding which gave general offence, it being made matter of public remark that this royal favourite used his fellow-countrymen to do the work of beasts. In September 1634 Sir Sanders Duncombe got a letter patent, granting him the sole right and privilege for fourteen years to use and let for hire within London and Westminster 'covered chairs' to prevent the unnecessary use of coaches; according to Evelyn he got the notion from Naples. Sedan chairs were largely used during the greater part of the 18th century, being found very well adapted for transporting persons, in full dress, to public and private entertainments. Not only were there numerous public conveyances of this kind in London and all considerable towns, but the owner of every large mansion had his private sedan handsomely fitted up. In Edinburgh at the close of the 18th century sedan chairs were far more numerous than hackney coaches, and were almost all in the hands of Highlanders. Sedans are perhaps hardly yet quite extinct, having been in use in London so late at least as 1830, at Winchester as 1851, at Peterborough and Edinburgh as 1860, at Genoa as 1882, at Newcastle as 1885,

and at Bury St Edmunds as 1890. Sedan chairs have also been employed as ambulances for conveying sick persons to hospitals.

Sedatives are substances or measures which exert a depressing effect on any part of the body. They are called pulmonary, nervous, gastric, cardiac, &c. sedatives according to the special part of the organism on which they exert their effects. They are employed to relieve pain, and to relieve over-activity and hyper-excitability of any organ or system. They embrace a very large number of commonly used medicines.

Sedbergh, a town in the West Riding of Yorkshire, on the Rawthey, 45 miles by rail NW. of Skipton. It has a Norman church and a grammar-school (1551) of high repute, where Sedgwick was educated and Hartley Coleridge was a master. Pop. of township, 2374. See the Rev. W. Thompson, *Sedbergh, Garsdale, and Dent* (Leeds, 1892).

Sederunt. See ACTS OF SEDERUNT.

Sedge. See CAREX.

Sedgefield, a town of Durham, 9 miles NW. of Stockton, with a cruciform Early English church and a grammar-school. Pop. of township, 2601.

Sedgemoor, a marshy district in the middle of Somersetshire, 5 miles SE. of Bridgwater, was the scene of the fight between 4000 soldiers of King James II. and 8000 of the undisciplined followers of the Duke of Monmouth, on 6th July 1685; the latter were defeated, with the loss of a thousand slain on the battlefield and several hundreds more in the subsequent pursuit and in the executions that followed. The account of the fight in Macaulay's *History* should be read, and also the description in Blackmore's *Lorna Doone*.

Sedgley, a town of Staffordshire, 3 miles S. of Wolverhampton, with coal-pits and ironworks. Pop. (1881) 14,874; (1891) 14,961.

Sedgwick, ADAM, for more than fifty years Woodward professor of Geology at Cambridge, was born at Dent in Yorkshire in 1785, graduated from Trinity College, Cambridge, in 1808, and for the next ten years lectured as a Fellow of his college. He was then elected professor of Geology (1818); and in the following year, on the foundation of the Cambridge Philosophical Society, he was chosen one of its secretaries. For many years he took an active part in the discussions of the Geological Society of London, of which he was president in the years 1829 to 1831. Most of his writings were couched in the form of papers contributed to the *Transactions* of these two societies. His best and most successful labour was expended upon the investigation of the paleozoic and crystalline rocks; and his longest work was a dissertation on *British Palæozoic Rocks and Fossils* (Lond. 1851-52). Along with Murchison (q.v.) he made a systematic study of the geology of the Alps, and of the Devonian system in England. Although he did admirable service in establishing geology on a thoroughly scientific basis, Sedgwick was in other regards firmly rooted in distinctively conservative ideas: he made a trenchant attack upon *The Vestiges of Creation* in the *Edinburgh Review*, and put himself in strong opposition to Darwin's *Origin of Species*. He was canon of Norwich Cathedral from 1834, and for some years held the office of vice-master of his college. His death occurred at Cambridge, on 25th January 1873. In 1890 appeared 2 vols. of his *Life and Letters*; in 1891 it was resolved to build at Cambridge a Sedgwick Memorial Geological Museum.

Sedimentary Rocks. See GEOLOGY, p. 152.

Sedition, a general name given to such offences against the state as fall short of treason. In the law of England it is not a strictly technical word.

Writing, publishing, or uttering words tending to excite subjects to insurrection, though not urging them to rebellion or total subversion of the government, come under the denomination of seditious libel, and seditious meetings or assemblies are punishable as misdemeanours. The crime consists in the intention to excite disaffection against the sovereign, the government, or the administration of justice, or to excite the sovereign's subjects to attempt, *otherwise than by lawful means*, the alteration of any matter in church or state by law established, or to promote ill-will and hostility between different classes of such subjects.

In Scotland sedition is distinguished from Leasing-making (q.v.), in so far as the object of the latter is to disparage the private character of the sovereign, while the former crime is directed against the order and tranquillity of the state. The punishment of sedition, formerly arbitrary, is now restricted to fine and imprisonment. See Lord Cockburn's *Trials for Sedition in Scotland* (2 vols. 1888).

Sedley, SIR CHARLES, courtier and poet, was born at his father's seat at Aylesford, Kent, in 1639, a maternal grandson of the famous Sir Henry Savile. He was educated at Wadham College, Oxford, repaired to court at the Restoration, and soon became notorious at once for debauchery and wit. Later he sat in parliament for New Romney, retired from court, and joined the party of William at the Revolution, out of *gratitude* to James, who had seduced his daughter, and made her Countess of Dorchester. 'Since his majesty has made my daughter a countess,' said he, 'it is fit I should do all I can to make his daughter a queen.' Johnson's line, 'And Sedley cursed the form that pleased a king,' has kept alive the memory of this sordid amour, but it is worth noticing that the daughter, speaking of what attracted the king, decries her own beauty with something of her father's wit: 'It cannot be my beauty, for he must see that I have none; and it cannot be my wit, for he has not enough to know that I have any.' Sedley survived till 1701. He left six plays, among them *The Mulberry Garden* and *Bellamira*, but what little fame remains to him now rests solely on a few songs and *vers de société*. It is enough to name three, 'Phillis, men say that all my vows;' 'Ah, Chloris, that I now could sit;' 'Love still has something of the sea,' to make good a claim to unusual gracefulness of fancy and mastery of form. Even his licentiousness does not wear the open grossness of the age.

Seduction, in English law, means the act of decoying away a servant or member of a family from his or her duty; in a narrower sense it includes offences against the chastity of women, where the offender accomplishes his purpose by persuasion, not by force. It is not a criminal offence unless the facts are such as will support a charge of Rape (q.v.) or Abduction (q.v.). No action can be maintained by a woman who is seduced, however basely or deceitfully the seducer may have acted; but a master or mistress may sue in respect of loss of service caused by the seduction. If a father or mother can make out loss of service, damages can thus indirectly be recovered for the seduction of a daughter; and it is the inveterate practice of juries to give 'exemplary damages' in such cases, if the conduct of the defendant has been heartless or dishonourable. The rule of law is most irrational: a rich man, whose daughter occasionally makes his tea, can recover damages if she is seduced; a poor man, whose daughter is in a situation away from home, cannot. In Scotland the woman can sue in her own name if deceit has been used; but the diffi-

culty of showing that the deceit was the only cause of the injury prevents such actions from being common. Redress is sometimes obtained by an action for breach of promise of marriage or (in Scotland) by an action of declarator of marriage; and the father of an illegitimate child can be compelled to maintain it.

Sedulus. See HYMN, Vol. VI. p. 46.

Sedum, a genus of plants of the natural order Crassulaceae, having the calyx in four to eight (usually five) deep segments, which often resemble the leaves, the same number of spreading petals, twice as many stamens, and four to eight (usually five) ovaries, each with a nectariferous scale at the base. The species are numerous, with succulent, often roundish leaves, and pretty, star-like flowers. Many of them grow on rocks, whence the English name Stone-crop. They are natives of the temperate and cold parts of the northern hemisphere; some are British. They have no important uses; some are refrigerant, others are acrid. Among the British species are *S. telephium*, popularly called Orpine, sometimes used as a diuretic, and *S. acre*, the most common, whose brilliant yellow flowers adorn the tops of old walls, the debris around quarries, &c. Many of the dwarf-growing species are employed in the now popular style of flower-gardening called 'carpet-bedding.'

Seed. In the higher plants, which are called Phanerogams because of the conspicuousness of their flowers or reproductive organs, the egg-cell lies within an Ovule (q.v.), and after fertilisation grows into an embryo plant, with one or two primary leaves—all before separation from the parent plant. What is separated, to begin in favourable conditions a new and independent life, is a seed, which may be defined as a ripe ovule containing an embryo plant. So distinctive of the Phanerogams is this mode of reproduction by seeds, that they are often and conveniently called Spermatophytes or Seed-plants.

From the article OVULE the reader will understand how the seed is formed, how a mass of tissue—the nucellus—borne by the carpellary leaf contains a female spore or 'embryo-sac,' whose nucleus divides into a female nucleus or oosphere (which will develop into an embryo if fertilised) and a number of other nuclei of minor importance. The fertilised oosphere, within the embryo-sac, imbedded in the nucellus, and surrounded by the coats of the ovule, develops into an embryo plant, and the whole structure is called a seed.

Structure of the Seed considered in relation to the Growth and Germination of the Embryo.—The segmented egg-cell within the embryo-sac gives rise to the embryo and to a 'suspensor' which moors it. The figure on p. 300 shows somewhat diagrammatically the embryo moored to the top of the embryo-sac by the suspensor; the base of the embryo next the suspensor is the region from which the radicle or young root will spring; the depressed apex at the opposite pole of the embryo is the region from which the plumule or young stem will shoot forth; the two sides form the young cotyledons or seed-leaves.

The embryo is the essential part of the seed; the other structures are subsidiary to its nurture, protection, and germination. Of these other parts of the seed the stored food material is of great importance, for after separation from the parent the embryo grows and sends out its rootlet, and pushes up its stem and expands its delicate leaves, in great part on the strength of what nutritive material it or the seed contains. This nutritive material, or 'albumen' as it is often called, out of which the first new parts of the young plant will be in great part built up, is formed after fertilisation—the physio-

logical conditions are not understood—and is disposed within the seed in three different ways in relation to the embryo. It may lie in the cells of the nucellus, around but not within the embryo-sac,

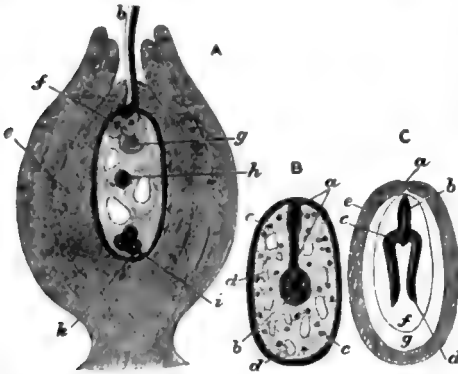

Diagram showing general structure of Seed (from Parker's *Elementary Biology*):

- A, section of ovule; b, pollen-tube; c, nucellus; f, accessory cells or synergids; g, ovum or egg-cell; h, central nucleus of embryo-sac; i, antipodal cells of embryo-sac; k, embryo-sac.
 B, embryo-sac, showing a, suspensor; b, embryo or segmented ovum; c, nuclei; d, vacuoles.
 C, section of a seed, showing a, the micropyle; b, embryo with embryonic root; c, embryonic stem; d, cotyledons; e, external seed-coat; f, endosperm; g, perisperm.

as in the seeds of bananas and ginger; then we call it perisperm. Or it may lie in more intimate relation to the embryo, within the embryo-sac (where a median nucleus seems to bear some relation to its formation), as in the seeds of wheat and castor-oil; then we call it endosperm. Sometimes there may be both endosperm and perisperm, as in water-lilies. But in many cases there is neither endosperm nor perisperm, all the food material being stored within the embryo itself—in its cotyledons—as in the pea and wallflower, apple and almond. Such seeds are somewhat confusedly called ex-albuminous.

The food materials, which are so often and by no means accurately summed up in the term albumen, vary in different kinds of seeds, but in a general way we may say that they consist of starchy, fatty, and proteid substances in varying proportions. In the development of animals they have their analogue in the yolk, and the analogy is especially true of the endosperm which is formed within the embryo-sac. But this analogy cannot be pressed, and it is perhaps more important to notice that the three ways in which the nutriment occurs—in the nucellus (perisperm), in the embryo-sac (endosperm), and in the embryo itself—form an intelligible series. The perisperm, which is least common, occurs in the nucellus—an outgrowth of the carpel—i.e. in the sporangium of the sporophyte generation (see FLOWER, FERN, OVULE). The endosperm occurs in the embryo-sac, has its centre in a central nucleus (formed from the fusion of two of the eight nuclei into which the primary spore-cell divides), and is therefore included in the prothallium of the gamophyte generation. Lastly, and most frequently, the nutrition may be stored within the embryo which results from the fertilisation of the egg-cell of the gamophyte.

Structure of the Seed considered in relation to the Protection of the Embryo.—As the embryo plant is a delicate structure, and as its separation from the parent plant is attended with vicissitudes, for the seed may be blown or carried into unfavourable conditions, and as most of the seeds which are liberated are not at once ready to germinate, it is

important that the life of the embryo should be protected. This necessary protection is supplied in various ways. Around the ovule a double investment usually grows, and part of this investment is modified as the husk of the seed. The modification becomes marked as the seed grows ripe, as it begins to be ready for separation from the parent, as its supply of water begins to fail, as its vitality becomes more dormant; in fact the modification, which is a most useful one, is in part a necessary result of the physiological conditions of seed-ripening. In the modified husk it is generally possible to distinguish a thin, relatively unimportant internal tegmen from an outer, thicker, resistant testa. This testa may be leathery or woody, fleshy or gelatinous, smooth or hairy; it is variously adapted for the protection of the enclosed embryo. We may compare it to the shell or case which often surrounds the animal embryo. There is usually some relation between the nature of the seed-coat and that of the pericarp which surrounds the whole fruit; for in indehiscent fruits with tough walls (as in achenes and nuts) the seed-coat remains thin, while in dehiscent fruits the seed-coat is usually thick and hard. See GEOGRAPHICAL DISTRIBUTION.

Apart from the husk, the ripe seed is sometimes marked by a growth from its base or stalk. This is called the aril, and may be hairy as in willows and poplars, fleshy as in *Euonymus*, peculiarly shredded as in the mace of *Myristica aromatica* or nutmeg. When the growth from the base or from the funiculus of the seed is all on one side, it is called a caruncle, as in *Chelidonium majus*, *Viola tricolor*, and *Ricinus communis*. The outer surface of a liberated seed may also bear a mark at the place (hilum) where it separated from the funiculus; this is well seen in the common bean. Sometimes also a small opening or depression (*ciatricula*) persists as a remnant of the micropyle or aperture by which the pollen-tube passed between the coats of the ovule. In many cases the region marked by an external scar, corresponding to hilum or to micropyle or to both, is of special importance, the tissue of the seed-coat being modified so as to act as a sponge through which water soaks in to the embryo within. Many of the hard coats of seeds have, instead of this special sponge, numerous minute canals perforating their dense substance.

Structure of the Seed considered in relation to Seed-scattering.—Already in the article FRUIT reference has been made to adaptations which secure the dispersion of the seeds. Oftenest the dispersion depends upon the fruit, which may burst violently so that the seeds are scattered, or may be juicy and palatable so that it is eaten by birds and other animals, the indigestible seeds being in this way carried far and wide. Sometimes the fruit and the seed are virtually though not technically the same, as is the case in thistle-down, in which each little winged fruit borne about by the wind contains a single seed. Sometimes, however, the seeds themselves are borne about by the wind, as in willows and poplars, willow-herbs (*Epilobium*), cinchona, *Aclepias syriaca*, &c. The hairs which serve as parachutes to the seeds of poplars, willows, and the like are accessory growths outside the seed; a similar rich growth of cottony hair is characteristic of *Gossypium* and *Eriodendron*. It should also be noted that in many cases the seed is adapted to anchor itself, for the surface is often ridged or peaked, as in *Hyoscyamus*, *Papaver*, *Nigella*, or becomes glutinous in moist places, as in flax and some species of *Plantago*.

For further details as to the structure of seeds, consult morphological works such as Sachs's *Text-book of Botany*; for further details as to seed-scattering and the like, see

Kerner's *Pflanzenleben*, vol. ii. (Leip. 1891); for hints as to the practical study of seeds, see Strasburger's *Practical Botany*, trans. by Hilhouse (2d ed. 1889).

Vitality of Seeds.—Although the seed is a complex structure, it is usually able to remain for weeks, months, or even years in a state of dormant life hardly distinguishable from death except in its power of reawakening. We usually say that a seed is ripe at its separation from the parent plant, but this ripeness is not coincident with readiness to germinate. Sometimes indeed, as in the sheaves of corn in a wet season, the seeds may germinate before they leave the parent plant; those of ephemeral plants usually germinate as soon as they are scattered. In most cases, however, seeds are not ready to germinate until after they have remained for some time dormant. The seed of the mistletoe is ripe in autumn, but it does not germinate until April or May of the following year; that of *Draba verna* requires ten or eleven months of quiescence; that of *Euphorbia cyparissias* remains under ground from four to seven years; that of *Euphorbia exigua* is said to lie dormant for nine years. In some cases the reason of the prolonged postponement of germination is to be found in the hardness and thickness of the husks which surround the seeds, and in the slowness with which water seems able to penetrate into the dense cells; and it is likely that time is also required for ferments which the seeds contain to do their work of preparing the reserve food material for use in germination.

Seeds vary greatly in their powers of retaining their life. Those of the willows and poplars are peculiarly short-lived; unless they land in moist places they usually die in a few days. 'Seeds rich in ferment quickly lose their power of germinating. Ripe acorns will not germinate after a year, nor coffee-beans after six months. Nor do those which are rich in oil survive nearly so long as those whose reserve-products consist mainly of starch.' There is no doubt that carelessly-made experiments have given rise to a much exaggerated estimate of the powers of retaining vitality which seeds possess. Thus, we often hear of mummy wheat which has germinated after many centuries; but this assertion has not been substantiated. Indeed, modern experiments with the seeds of cereals show that they lose their vitality after ten years at most, and usually much sooner. Those of leguminous plants may, however, survive for several decennia. The vitality of seeds is also illustrated by the fact that some dry seeds can survive very high and very low (100° C. and -120° C.) temperatures. As to the real state of the protoplasm inside those seeds which remain so long without either living or dying, we are not yet in a position to make definite statements (see J. Wiesner's *Biologie der Pflanzen*, 1889).

Uses of Seeds.—As seeds are often rich in starchy, fatty, and proteid substances, their importance as food is very great. Those of cereals and leguminous plants are especially valuable; and the seeds of hazel, chestnut, cocoa-nut, *Chenopodium Quinoa*, *Bertholletia*, *Pinus cembra*, and many others are also edible. Others, such as mustard and nutmeg, furnish spices; many others, such as linseed, almonds, cocoa-nut, castor-oil plant, yield oil; cotton-wool surrounds the seeds of *Gossypium*, &c.; vegetable ivory is the dense endosperm of *Phytelephas*. Some seeds are rich in stimulants, as in coffee and kola plants; many, such as *Strychnos nux vomica* and *Physostigma*, yield drugs.

Seeland (Dan. *Sjælland*). See ZEALAND.

Seeley, SIR JOHN ROBERT, K.C.M.G. (knighted in 1894), was born in London in 1834, the third son of the publisher, Robert B. Seeley (1798-1886). He was educated at the City of London School, and

at Christ's College, Cambridge, and graduated in 1857 first (equal with three others) in the first class in the classical tripos. Next year he became a Fellow of his college, later a lecturer there, then at his old school, but in 1863 was professor of Latin in University College, London, in 1869 of Modern History at Cambridge, with a fellowship at Christ's in 1882. *Ecce Homo* appeared anonymously in 1865, and excited an extraordinary commotion in the religious world in England, which was startled almost as much by its consummate literary excellence and its spiritual reverence as by the absence of the supernatural element. As a study of the human character of Jesus it still stands unrivalled. It was followed in 1882 by *Natural Religion*, a work hardly less valuable, though less known. He died 14th January 1895.

Other, and acknowledged, works of Seeley's are *English Lessons for English Readers*, in collaboration with Dr E. A. Abbott (1869); *Lectures and Essays* (1870); an edition of *Livy*, Book I. (1871); *Life and Times of Stein: or Germany and Prussia in the Napoleonic Age*, a work that has satisfied even German scholars (3 vols. 1879); *The Expansion of England* (1883); *A Short Life of Napoleon the First* (1885); and *Growth of British Policy* (1892; new ed. with *Life by Prothero*, 1895); *Introduction to Political Science* (1896)—besides many important contributions to magazines.

Segesta, or EGESTA, an ancient city in the north-west corner of Sicily, said to have been founded by the Trojans, was allied with the Carthaginians in 410 B.C., was conquered by the Syracusan Greeks in 307, and, again Carthaginian, revolted in 206 to the Romans, who greatly favoured it. The place suffered much from Saracen attacks, and now shows nothing but fine ruins, including a theatre and a great Doric temple. There are hot springs near the site, which was 6 miles from the sea, the present Castellamare representing what was the harbour of Segesta.

Segesvár (Ger. *Schässburg*), a town of Transylvania, on the Great Kokei, 60 miles by rail N.E. of Hermannstadt, consists of an upper and a lower town. Pop. 8788, who weave cotton and linen. Here on 31st July 1849 the Hungarians were defeated by the Russians; Petöfi is believed to have been amongst the slain.

Segovia, an old city of Spain, stands at the northern foot of the Sierra de Guadarrama, 32 miles NNW. of Madrid. It occupies a rocky eminence 3300 feet above sea-level, is surrounded by ruinous walls with round towers, and consists of narrow uneven streets, with old, quaint, and stately houses, and numerous parish churches and convents. The fortress or castle is perched on the west extremity of the rocky height, and was originally Moorish, but has been gradually restored since its destruction by fire in 1862; its towers and windows command magnificent views. The cathedral (1521-77) is one of the finest specimens of Late Gothic in Spain. The grand aqueduct, built in the time of Trajan, is a very fine example of Roman architectural work. It consists of two rows of arches, the one resting upon the other, some 2600 feet long and 102 feet high. Wool-scouring and the manufacture of paper, pottery, and cloth are languidly carried on. Pop. (1887) 14,399. Segovia was a place of importance during the time of the Romans, and was frequently the residence of the kings of Castile and Leon. Charles I. of England lodged at the castle, September 13, 1623, and supped on 'certaine trouts of extraordinary greatness.' The unresisting town was sacked in 1808 by the French.—The province of Segovia has an area of 2714 sq. m. and a pop. (1887) of 154,457.

Segu, or SEGU-SIKORO, an important trading town of western Africa, stands on the Niger (here

called the Joliba), 400 miles SW. of Timbuctoo. It was formerly the capital of a large native state, which has lost power under the successive conquests of the Toucouleurs, the Bambarra, and the French (1890). The traders are chiefly Arabs. Pop. 36,000. See Gravier, *Voyage à Segou* (1887).

Ségur, the name of a French family, originally of Guienne, distinguished both in arms and letters, as well as for its sufferings in the Huguenot cause. Its most famous members were the following: HENRI FRANÇOIS, Comte de Ségur (1689-1751), an able French general in the war of the Austrian succession. His son, PHILIPPE HENRI, Marquis de Ségur-Ponchat (1724-1801), fought in the Seven Years War, became marshal in 1783, and outlived in his retirement the stormy scenes of the Revolution. The eldest son of this Philippe Henri was LOUIS PHILIPPE, Comte de Ségur d'Aguesseau (1753-1830), for five years ambassador at the court of St Petersburg, and a great favourite with Catharine II. He served in the American war of independence, hailed the great Revolution with delight, and, stranger still, retained in extreme old age that love of liberty that marked his early years—the last act of his life was a eulogium on the revolution of July. As a writer Ségur exhibits in fine perfection the national graces of style and spirit. Among his numerous writings are: *La Politique de tous les Cabinets de l'Europe* (1793); *Histoire de Frédéric-Guillaume II.* (1800); *Histoire Universelle* (1817); *Galerie Morale et Politique* (1817-23), a delightful work; *Mémoires* (1825-26). His chief works fill 33 vols. (1824-30). He left two sons, OCTAVE and PHILIPPE PAUL, the latter of whom (1780-1873) was a general of the first empire, took part in the fatal expedition to Russia in 1812, and wrote the story of the campaign, *Histoire de Napoléon et de la Grande Armée pendant l'année 1812* (2 vols. 1824). The work has had an immense success, and has been translated into almost all the languages of Europe. Other works were: *Lettre sur la Campagne du Général Macdonald dans les Grisons* (1802); *Histoire de Russie et de Pierre le Grand* (1829); *Histoire de Charles VIII.* (1835); *Histoire et Mémoires, 1789-1848* (1873).

There is a Life by Taillandier (Paris, 1875); see also Sainte-Beuve's *Portraits Littéraires*, vol. ii.

Seidlitz Powders (so named from the village of Seidlitz or Sedlitz in northern Bohemia, where there is a spring of natural aperient mineral-water with similar constituents) are composed of 120 grains of tartrate of soda and potash and 40 grains of bicarbonate of soda reduced to powder, mixed and enclosed in a blue paper, and 38 grains of powdered tartaric acid in a white paper. The contents of the blue paper are dissolved in from half a tumbler to a tumbler of water, and those of the white paper are then stirred in. The mixture should be taken while the effervescence from the liberation of the carbonic acid is still going on. These powders act as an agreeable and mild cooling aperient. If a stronger dose is required, either an increased quantity of the powder may be used, or a little sulphate of magnesia (about a drachm) may be added.

Seine, one of the four chief rivers of France, rises on the slope of the plateau of Langres, north-west of Dijon, and flows north-westward, with many windings, past Troyes, Fontainebleau, Melun, Paris, St Denis, St Germain, Mantes, Elbeuf, and Rouen, through a total course of 482 miles, and pours its waters into a wide estuary of the English Channel, on which stand the ports of Harfleur, Havre, and Honfleur. It is navigable for boats from Marcilly, 350 miles from its mouth, and since 1890 the canalisation of the Seine has been one of two projects (the other a ship-canal)

for connecting Paris with the Atlantic (see PARIS, p. 767). The Seine drains an area of 30,000 sq. m.; receives the Aube, Marne, and Oise from the right, and the Yonne, Loing, Essonne, and Eure from the left; and is connected by canals with the Somme, Scheldt, Meuse, Rhine, Saône, and Loire. Works for keeping open a navigable channel through the estuary, which is liable to silt up, were commenced as far back as 1848, and were continued for more than twenty years. In consequence of these engineering works 28,000 acres of land have been reclaimed, and vessels of 2000 tons, drawing 20 feet of water, can get up to Rouen. Moreover a canal has been constructed to give Havre connection with the Seine at Tancarville, so that vessels using this channel can avoid the uncertainties of the deeper estuary. See L. F. Vernon-Harcourt, 'The River Seine,' in *Proc. Inst. Civil Engineers* (1886), and the beautiful engravings in *The Seine and Loire* (Turner's *Rivers of France*) published in 1886.

Seine, the metropolitan dept. of France, completely enclosed by the dept. of Seine-et-Oise, is a portion of the former province of Ile-de-France, and derives its name from its principal river, the Seine. One-sixth of its area is covered by the city of Paris (q.v.), and the rest is thickly studded with the suburban villages of the capital—Boulogne, Puteaux, Clichy, Montreuil, &c. It is at once the smallest and the most populous dept. in the republic: its area is 185 sq. m.; its pop. in 1876 was 2,410,849, and in 1891, 3,141,595. From south-east to north-west it is traversed for 37 miles by the windings of the Seine, which receives the navigable Marne at Charenton and the Bièvre at Paris. The surface is marked by undulations and low hills, the highest, Mont Valérien and Mont Bicêtre, reaching 650 feet. The scenery—of which the woods of Verrières, Meudon, and Saint-Cloud, together with those of Vincennes and Boulogne, transformed into parks, and watered by artificial rivers and lakes, are perhaps the most striking features—is wonderfully charming. A network of canals and railways, the latter converging in the capital, afford easy means of transit in any direction. The soil is not naturally fertile, but, owing to the skill of the farmers and gardeners, who obtain abundant supplies of manures from the metropolis, the country around Paris and its suburbs has been rendered remarkably productive. The culture of vegetables and fruits for the markets of Paris is one of the most important branches of husbandry. Enormous quantities of mushrooms are cultivated in the ancient quarries of Paris near Montrouge, and in the catacombs beneath the city. Quarries of gypsum and freestone abound, and are productive. Manufacturing industry is very active and extensive, but is principally concentrated in Paris and its suburbs. The arrondissements are Paris, St Denis, and Sceaux.

Seine-et-Marne, a dept. in the north of France, is bounded on the W. by the dept. of Seine-et-Oise, and forms a portion of that wide basin in the middle of which stands Paris. Area, 2214 sq. m.; pop. (1891) 356,709. The dept. is drained by the Seine and its tributaries (Yonne and Loing) and the Marne and its tributaries (Ourcq, Petit Morin, and Grand Morin). The surface is broken into a series of plateaus separated by valleys. Timber is grown in every part; and among the forests is that of Fontainebleau. The soil is generally fertile. Wheat, oats, potatoes, beet-root, and fodder crops are the chief productions. Building-stone, gypsum, clay, sand, and peat are extracted in large quantities. The manufactures are very varied, and embrace paper, sugar, porcelain and glass, spirits, flour, books, gloves, and other branches. The cheeses of Brie are well

known, and so are the roses of Provins. The white grapes of Fontainebleau have a European reputation. The capital is Melun, and the arrondissements are Melun, Coulommiers, Fontainebleau, Meaux, and Provins.

Seine-et-Oise, a dept. in the north of France, encloses the metropolitan dept. of Seine. Area, 2163 sq. m.; pop. (1891) 628,590. The principal rivers are the Seine and its tributaries the Oise, Marne, Essonne, Bièvre, Epte, &c. The surface is pretty level on the whole, but the country is charmingly diversified by picturesque valleys and great forests. Vast quantities of wheat, oats, potatoes, beet-root, and fodder crops are produced; and there are several fine varieties of stone and clay. There are numerous branches of manufacture, the most important being porcelain (at Sèvres), paper, cotton, silk, and woollen stuffs, iron goods, sugar, spirits, books, chemicals, laces, fringes, &c. The dept. is divided into the arrondissements of Versailles, Corbeil, Etampes, Mantes, Pontoise, and Rambouillet, and the capital is Versailles.

Seine-Inférieure, a maritime dept. of northern France, formed out of the old province of Normandy, and bounded on the N. and W. by the English Channel. Area, 2330 sq. m.; pop. (1891) 839,876. The Seine flows through the southern districts; but a number of important though small streams flow north-west across the dept. and fall into the Channel. The hills of Caux extend from east to west, and to the south of them are rich pasture-lands, watered by the Seine and its affluents. The coasts are formed of chalk-cliffs, varying in height from 200 to 400 feet. This dept. is one of the most flourishing in all France, having many manufacturing establishments (cotton and woollen stuffs, dyeworks, cloth, flax, shipping, foundries, sugar-refineries, tobacco, chemicals, &c.), a large trade from Havre, Rouen, and Dieppe, and much prosperous farming (cheese, butter, cattle, wool). Cider is extensively made. The coast-fisheries are valuable. On its coast are the favourite seaside resorts of the Parisians—Fécamp, St Valéry, Tréport, Dieppe, and others. The arrondissements are Dieppe, Havre, Rouen, Neufchâtel, and Yvetot. The capital is Rouen.

Seine-net. See FISHERIES, Vol. IV. p. 647.

Seir, MOUNT. See EDM.

Seisin, or SASINE. See FEOFFMENT, INFEEFMENT.

Seismometer is an instrument for measuring shakings, tremors, and tiltings of the earth (see EARTHQUAKE). In its earlier and ruder forms it was merely a seismoscope or seismograph, and its indications or records could not be interpreted quantitatively. Such, for example, is Babbage's bowl of treacle, in which the liquid, tending by inertia to remain steady as the bowl moves with the ground, leaves a high tidal mark as an evidence of the earthquake. Probably, but by no means certainly, such an instrument would indicate the direction of the largest motion occurring in an earthquake. It could not, however, record the succession of oscillations that make up the shock, or give really comparative records of different earthquakes. Similar limitations exist in all forms of liquid seismoscopes, such as Mallet's and Palmieri's, in which mercury moving in glass tubes forms the 'steady body.' A complete seismometer must, indeed, be capable of recording the entire earthquake motion in time, so that the amounts and rates of motions in all directions can be readily estimated from the records. The practical realisation of such an instrument we owe to the labours of Ewing, Gray, and Milne, who, working simultaneously and more or less in concert, brought to

bear upon the problem of Japanese earthquakes a rare combination of scientific knowledge and mechanical skill. Gray and Milne's Seismometer (see *Philosophical Magazine*, 1887) is perhaps the most complete of its kind, and is identical in principle with Ewing's Bracket Seismometer, which was the earliest instrument constructed for recording on the same sheet both the horizontal and vertical motions of small earthquakes. In these instruments there are three weights suspended by brackets, so that each has somewhere within it a 'steady point' with reference to one of the three directions, N. and S., E. and W., up and down. To these weights suitable levers are attached, which trace out on a smoked surface any desired magnifications of the relative motions of the earth and the corresponding steady points. Thus we obtain records of the three components of an earthquake motion; and from these the whole motion can be reconstructed and a model made of the complex motion of an earth particle, as has been done by Professor Sekiya of Japan. When the vertical motion is large, so that the earth's surface is thrown into distinct waves, these bracket seismometers fail to act as such. The precise meaning of a 'steady point' may be best obtained from consideration of a long pendulum with a heavy bob. We may suppose a pencil fixed to the bob and bearing lightly upon a sheet of paper resting on the ground. In an earthquake the ground moves, and with it the pendulum support. But the pendulum bob, because of its inertia, remains steady during the first motion, of which, consequently, we get a tracing on the paper. The subsequent tracing is a combination of the real earthquake motion and the slow swing of the pendulum itself. To get a perfectly steady point we should have to use an infinitely long pendulum. By a combination of an inverted unstable pendulum with an ordinary stable pendulum of convenient size, the stability may be reduced to neutrality, and a very satisfactory steady point obtained. This plan, first suggested by Principal Forbes, is very effectively realised in Ewing's Duplex Pendulum Seismometer. The record is a superposition of the whole horizontal motion, and gives definitely little more than the maximum displacement in direction and magnitude. For earth tremors and earth tiltings much more delicate instruments are needed than have been described. Of these Bertelli's Tromometer is the best known. For large and disastrous earthquakes the havoc wrought is the only seismoscope that can be depended upon.

Seistan, or **Hamoon**, LAKE, a large, irregularly-shaped, shallow lake or swamp in the west of Afghanistan, close to the frontier of the Persian province of Khorassan, a division of which province (mainly steppe) is named Seistan after it. The lake is not a single expanse of water, but is divided into three depressions. Great part of the area is generally dry; but, as the basin has no outlet, when the Helmund (q.v.) and its other feeders are in flood this lake regularly overflows its boundaries, fertilising large tracts of country.

Sejanus. See TIBERIUS.

Selachoidel. See CARTILAGINOUS FISHES.

Selaginella, a genus of heterosporous cryptogams, closely allied to the so-called Club-moss (see LYCOPODIACEÆ), with some 350 species—many of them cultivated in conservatories.

Selangor, a state of the Malay Peninsula, which since 1874 has been under British protection. It lies between Malacca and Perak, has an area of 5000 sq. m. and a pop. (1890) of 140,000, including many Chinese; contains rich deposits of tin; and grows tapioca, rice, and sugar. The capital is Kuala Lumpur, which is connected by rail (22

miles) with Klang, the principal port of the state, on the Klang River.

Selborne, a pleasant Hampshire parish of 12 sq. m. and 1200 inhabitants, 5 miles SSE. of Alton station and 20 E. of Winchester. Gilbert White (q.v., 1720-93) has made it for ever famous by his *Natural History of Selborne* (1789). 'The Wakes,' the ivied house where he was born and died, still stands, though added to; the church, where he lies, was restored in 1877. Nothing remains of an Augustinian priory (1232).

Selborne, ROUNDELL PALMER, EARL OF, was born at Mixbury Rectory, Oxfordshire, November 27, 1812, and had his education at Rugby and Winchester and at Trinity College, Oxford. His course was exceptionally brilliant; he carried off the Chancellor's prize for Latin verse (1831), the Newdigate (1832), the Ireland scholarship (1832), took a classical first-class in 1834, was elected to a Magdalen fellowship, and took both the Chancellor's prize for the Latin essay (1835) and the Eldon Law scholarship. He was called to the bar at Lincoln's Inn in 1837, and became a Q.C. in 1849; sat for Plymouth in the House of Commons from 1847 till 1852, and again from 1853 till 1857; became Solicitor-general in 1861 under Palmerston, being at the same time knighted and returned for Richmond; and was Attorney-general from 1863 till the fall of the Russell government in 1866. His inability to accept Mr Gladstone's whole Irish Church policy prevented his accepting the Chancellorship in 1868, but he succeeded Lord Hatherley in 1872, and was created Baron Selborne. The year before he had represented the government as counsel before the Arbitration Court at Geneva. Selborne was ever active as a reformer in legal procedure, and his reign will remain memorable from the fusion of law and equity effected by his Judicature Act (1873). He fell with his party in February 1874, but returned to the woolsack in May 1880, and sat till the dissolution of 1885. He was raised to the rank of Earl of Selborne in 1882. He found himself unable to accept Mr Gladstone's Irish policy, and therefore in February 1886 declined a third term of office. Chairman of the Oxford University Commission, he was made D.C.L. (1863), and was Lord Rector of St Andrews University in 1877. His *Book of Praise* (1863; 9th ed. 1892) is an admirable collection of hymns. Other books are *Notes on some Passages in the Liturgical History of the Reformed English Church* (1878), *A Defence of the Church of England against Disestablishment* (1886), and *Ancient Facts and Fictions as to Churches and Tithes* (1888). He died 4th May 1895. See his *Memorials* (2 vols. 1896).

Selby, a market-town in the West Riding of Yorkshire, on the right bank of the Ouse, 15 miles S. of York and 20 E. of Leeds. The great cruciform parish church, measuring 283 by 59 feet, was the church of a mitred Benedictine abbey, founded in the 12th century by Hugh, sheriff of Yorkshire. It exhibits every style from Norman to Perpendicular; lost its south transept by the fall in 1690 of the central tower (mainly rebuilt twelve years later); and has undergone much restoration since 1873. Other edifices are a Roman Catholic church (1859), St James's Church (1868), and a modern market-cross. The river is navigable for vessels of 200 tons; and there is also a considerable carrying trade by railway and canal. Selby has manufactures of flax, ropes, leather, beer, &c., besides boat-building and brick-making. It is the traditional birthplace of Henry I. (1068), and in the Great Rebellion was recaptured from the royalists by Fairfax (1644). Pop. (1851) 5109; (1891) 6022. See W. W. Morrell's *History of Selby* (1867).

Selden, JOHN, an illustrious English scholar and jurist, was born at Salvington near Worthing in Sussex, in December 1584, studied at Hart Hall, Oxford, for three years, and then removed, first to Clifford's Inn, London, and afterwards to the Inner Temple, to study law. It was here that his great learning began to attract attention, and won for him the friendship of Camden, Usher, Sir Robert Cotton, and Sir Henry Spelman. As a conveyancer and chamber-counsel he acquired wealth, yet found time for studies at once profound and wide in range. Selden wrote his first treatise, relating to the civil government of Britain previous to the Norman Conquest, and entitled *Analecton Anglo-Britannicon* (1606), when only twenty-two years of age. In 1610 appeared his *Jani Anglorum Fœcies Altera* (Eng. trans. 1683), giving an account of the common and statute law of English Britanny to the death of Henry II., and also *The Duello, or Single Combat*, a history of trial by battle; and in 1614 was published his *Titles of Honour*, still an authority. Three years later appeared his erudite work on the Syrian gods, especially in their connection with the Old Testament, entitled *De Dis Syriis Syntagmata Duo*. His *History of Tithes* (1618) demolished their *divine right*, and brought down upon his head the fulminations of the clergy, much more noisy than convincing. Fortunately for his assailants the Privy-council suppressed the book and forbade him to reply. In 1621 Selden suffered a brief imprisonment for advising the parliament to repudiate King James's doctrine that their privileges were originally royal grants; in 1623 he was elected member for Lancaster, in 1626 for Great Bedwin, and in 1628 for Ludgershall, both in Wilts, and henceforward till his death he took a considerable part in public affairs.

He was sincerely attached to the cause of the parliament, and as sincerely opposed to the views of the court party and the king, but he was above all things a constitutional lawyer, and derived his ideas of the rights of the subject from the history of the nation, and not from religious fanaticism or metaphysical considerations. Still he 'loved his ease,' as Clarendon says, and so let things be done without protest of which he did not approve. In 1628 he helped to draw up the Petition of Right, and the year after he was committed to the Tower with Eliot, Holles, and the rest. After eight months' rigorous imprisonment, he was transferred to the Marshalsea, but soon after was released through the favour of Laud, whereupon he retired to Wrest in Bedfordshire, the seat of the Earl of Kent. In 1640 he was chosen member of the Long Parliament for the university of Oxford; and now, when the struggle between the king and the nation began to point towards the fatal rupture, he was suspected of not being zealous enough by such as were themselves perhaps over-zealous. Already in 1635 he had dedicated to the king his *Mare Clausum* (an answer to the *Mare Liberum* of Grotius and the Dutch claims to fish off the British coasts), and there is evidence that Charles personally looked on him with favour. Selden was one of the committee of twenty-four appointed to draw up a remonstrance, and at this point his path first diverged from that of Hyde, yet without their friendship being impaired. He opposed vigorously the policy that led to the expulsion of the bishops from the House of Lords, and finally to the abolition of Episcopacy. Yet he adhered in the main to the cause of the parliament, driven by the complete arbitrariness of the king's later measures. He took no direct part in the impeachment of Strafford and voted against the Attainder Bill, and, though he furnished precedents for the measures taken against Laud, had no share in his prosecution.

He sat as a lay-member in the Assembly of Divines at Westminster (1643), and perplexed his clerical colleagues sadly with his irony and his learning. Soon after he was appointed keeper of the rolls and records in the Tower. In 1644 he was appointed one of the twelve commissioners of the Admiralty, and elected master of Trinity Hall at Cambridge, which office he declined. In 1646 he subscribed the Covenant, and the year after the sum of £5000 was voted to him by parliament in consideration of his services and sufferings. In 1647 he was appointed one of the university visitors, and always used his influence to moderate the tyranny of his fanatical colleagues. One of his last public acts was to join in the last effort for a reconciliation between the king and the parliament. After the execution of Charles, of which it is certain he strongly disapproved as both unlawful and inexpedient, he took little share in public matters; and when requested by Cromwell to answer the *Eikon Basilike*, he refused. His death occurred at Whitefriars, November 30, 1654, and he was buried in the Temple Church, London. His last years he had spent in the house of Elizabeth, dowager-countess of Kent, with whom, between her husband's death in 1639 and her own in 1651, the intimacy had been so great as to colour Aubrey's statement that they were privately married. He left about £40,000; his 8000 books were given by his executors to the Bodleian. The principal writings of Selden, besides those already mentioned, are: *Marmora Arundeliana* (1628); *De Successionibus in Bona Defuncti secundum Leges Eboracorum* (1634); *De Jure Naturali et Gentium, juxta Disciplinam Eboracorum* (1640), a work more learned than critical, like most of Selden's biblical productions, who thought far too much of the opinions of the Rabbins; *Uxor Ebraica*; and *De Synedriis et Prefecturis Juridicis Eboracorum* (1650 et seq.); besides a great variety of posthumous tracts and treatises, of which the most famous, and also the most valuable, is his *Table-talk*, recorded and published by his amanuensis, Richard Milward, in 1689 (ed. by Singer, 1847, and by Reynolds, 1892). Of this Coleridge says, with some exaggeration, however: 'There is more weighty bullion sense in this book than I can find in the same number of pages of any uninspired writer.' Selden's best character stands in the gallery of Clarendon, who adds excellently: 'His style in all his writings seems harsh, and sometimes obscure; which is not wholly to be imputed to the abstract subjects of which he commonly treated, out of the paths trod by other men, but to a little undervaluing the beauty of a style, and too much propensity to the language of antiquity; but in his conversation he was the most clear discourses, and had the best faculty in making hard things easy and present to the understanding, of any man that hath been known.' Selden's works were collected and published at London in three folio vols. (1726).

See Singer's Biographical Preface, Dr John Aikin's *Lives of Selden and Usher* (1811), and G. W. Johnson's *Memoir* (1835). The Selden Society was founded in 1887 for promoting the study of English legal history.

Selection. See DARWINIAN THEORY, SEXUAL SELECTION.

Selectmen. See MASSACHUSETTS.

Selene, the Greek moon-goddess, a daughter of Hyperion and Theia, and sister of Helios (the Sun) and Eos (the Dawn). As sister of Helios or *Phoibos* ('shining') she had the name of *Phaëbe*, and latterly was identified with Artemis, though the identification was never quite exact, as Artemis always retained her reputation for chastity, while Selene had fifty daughters by her

lover Endymion and several by Zeus. She is represented by the poets as a lovely woman with long wings and a golden diadem, riding across the heavens in a chariot drawn by two white horses, cows, or mules. See *Ueber Selene und Verwandtes*, by W. H. Roscher (1890).

Selenga, a river (740 miles) of Mongolia and Siberia, flowing by three arms into Lake Baikal. It is navigable from May till October for 200 miles from the Chinese frontier, and steamers and lighters ply on it.

Selenite (Gr. *Selēnē*, 'the moon'). This name is given to the transparent variety of Gypsum (q.v.). It occurs in distinct crystals belonging to the oblique or monoclinic system, or in folia. It is usually white (colourless), but sometimes it is tinged with red, yellow, green, gray, &c. Selenite is soft, easily cut, and capable of being split into very thin plates. These are much used in polarising apparatus (see POLARISATION). Selenite is a comparatively common mineral, although it rarely occurs in large quantities. Finely crystallised specimens are found at Bex in Switzerland, in Sicily, and at different places in the United States. There is a magnificent group of crystals of this mineral in the British Museum from Reinhardtsbrunn in Gotha. In Nova Scotia, where, in the vicinity of Oxford, near River Philip, there are vast deposits of gypsum (large quantities of which are sent to the United States), selenite is found abundantly. At Petitcodiac, New Brunswick, where extensive deposits of gypsum also occur, there is a vein of nearly pure selenite one mile long and eight feet wide. Selenite, being a pure form of gypsum, is used for making the finest kind of plaster of Paris. Plates of selenite are said to have been used by the ancients for some of the purposes for which we use glass.

Selenium (sym. Se; at. wt. 79) is an element having two forms. In the *vitreous* form, at ordinary temperatures, it is a solid of a dark-brown colour, and when broken presents a conchoidal vitreous fracture; thin splinters of it are, however, of a dark-red tint when seen by transmitted light. It is tasteless and inodorous, a non-conductor of electricity. Its specific gravity is 4.28; its melting-point is 217° C., and its boiling-point 700° C. When selenium is very slowly cooled from the fused condition its appearance is quite different; the structure being *granular or crystalline* (sometimes called 'metallic'). Crystalline selenium is of a dull leaden colour; it is very opaque to light even in thin films; its specific gravity is 4.8, its melting-point 206° C., and its boiling-point 680° C. It is a conductor of electricity at ordinary temperatures. Its resistance to the passage of an electric current diminishes up to the point of fusion, but suddenly increases as the selenium becomes liquid. Another property of crystalline selenium, which has recently given it a new interest, is that it is remarkably sensitive to light; and its electrical resistance varies very much according to its exposure to light, being much less in the light than in the dark. It was in virtue of this property that the experiments were made which led in 1880 to the discovery of the Photophone (q.v.). The vapour of selenium is inodorous and deep yellow; it is 164 times as heavy as hydrogen at 1400° C.; this corresponds nearly to the molecular formula Se₂. When heated in the air selenium does not very readily take fire; but it is combustible, and burns with a blue flame, while a portion of it is volatilised in red fumes. The products of combustion are oxide of selenium and selenious anhydride, SeO₂.

Selenium is of rare occurrence in nature; it is chiefly found as a selenide in combination with lead, silver, copper, or iron; but it has also been

discovered in sulphur, and in certain sulphides of iron. It forms with oxygen a suboxide and a binoxide (SeO_2 , selenious anhydride); and as it forms also a selenic acid, $\text{H}_2\text{SeO}_4 + x \text{aq}$, the existence of a selenic anhydride SeO_3 is inferred, though it has not been isolated. With hydrogen selenium forms seleniuretted hydrogen, or hydroselenic acid, H_2Se . Selenium was discovered in 1817 by Berzelius, in the refuse of a sulphuric-acid manufactory. He named it selenium (Gr. *selēnē*, 'the moon'), because in many respects it resembled tellurium (from Lat. *tellus*, 'the earth').

Seleucia, the name of several ancient cities in Syria, Pisidia, Pamphylia, Cilicia, Caria, and Mesopotamia, founded during the earlier existence of the dynasty of the Seleucidae (q.v.). Of these two were especially distinguished. (1) SELEUCIA PTERIA, founded by Seleucus Nicator, a few miles north of the mouth of the Orontes in Syria, was the seaport of Antioch, and became of great importance during the wars between the Seleucidae and the Ptolemies for the possession of Syria. It rapidly declined under the Roman dominion. The ruins have been fully explored and described in modern times by Pococke (*Observations on Syria*) and Chesney (*Royal Geographical Society's Journal*, vol. viii.). The remarkable tunnel of 1088 yards in length, which was excavated out of the solid rock and formed the only communication between the city and the sea, and the remains of its triple line of walls, citadel, temples, amphitheatre, necropolis, &c. attest the former importance and splendour of the city. (2) SELEUCIA ON THE TIGRIS was also built by Seleucus Nicator, on the west bank of the Tigris, 40 miles (according to Strabo 33) north-east of Babylon, which was despoiled to supply materials for the construction of the new city. Situated in a district of great fertility, and commanding the chief trading routes of Assyria, Babylonia, and western Persia, it rapidly rose to wealth and splendour, supplanted Babylon as the capital of the eastern portion of the Seleucid monarchy, and when in the acme of its greatness contained a population of more than 600,000. When the Seleucid empire fell before the Romans the fate of Seleucia was sealed. It was partly burned by Trajan (116 A.D.) and in 165 was completely destroyed by Avidius Cassius.

Seleucidae, the dynasty of kings to whom fell that portion of Alexander the Great's Asiatic conquests which included Syria, a large portion of Asia Minor, and the whole of the eastern provinces (Persia, Bactria, &c.). The founder of the dynasty was SELEUCUS I., surnamed Nicator, who in the second partition of Alexander the Great's empire obtained Babylonia, to which, with the aid of Antigonus, he subsequently added Susiana; but a quarrel having arisen with that powerful chief, Seleucus took refuge in Egypt (316 B.C.). The course of events, however, allowed him to return to his satrapy in 312; his re-entry into Babylon marked the beginning of the *era of the Seleucidae*. Having recovered Susiana, he conquered Media, and extended his power to the Oxus and Indus. In 306 he assumed the regal title; and four years afterwards he joined the confederacy of Ptolemy, Lysimachus, and Cassander against Antigonus, and obtained the largest share in the conquered territories of that ruler, a great part of Asia Minor and the whole of Syria falling to him. Towards the close of his reign he gained by war the rest of Asia Minor, but was assassinated (280) by one of his own officers. Seleucus cherished the ambition of building up a second empire equal in extent to Alexander's, and he pursued with great zeal the plan of 'Hellenising' the East, by founding numerous Greek and Macedonian colonies in various parts

of his dominions; he also built numerous cities, several of which—as Antioch in Syria and Seleucia on the Tigris—rose to be among the most populous and wealthy in the world. In the reign of his feeble grandson, ANTIOCHUS II. (260–246), Bactria was lost and the foundations were laid of the kingdom of Parthia. His son, SELEUCUS II. (246–226), surnamed Callinicus, was greatly beset by Ptolemy of Egypt, by his own brother, and by the Parthian prince, but managed to hold his own with some difficulty. The glories of Seleucus I. were revived in the second son of Seleucus II., ANTIOCHUS III. (q.v.), 'the Great,' who was the first of the Eastern 'great kings' of Iran to come into collision with the Romans. His second successor was his own able son, ANTIOCHUS IV. (q.v.), Epiphanes (I.; 'the Illustrious'), who conquered Coele-Syria and Palestine from the Egyptians, but withheld his hand from Egypt at the bidding of the Romans. He practised atrocious cruelties on the Jews, whose religion he endeavoured to root out in favour of the Greek religion; but the heroic resistance of the Maccabees (q.v.) completely foiled his project. He died in a state of raving madness, which was attributed by his subjects to his sacrilegious crimes, and so they in derision converted his surname into Epimanes ('the Madman').—The succeeding rulers were for the most part a set of feeble and incompetent sceptre-holders, none of whom was able to delay the gradual disintegration of the empire. Babylonia, the original centre of their power, was conquered by the Parthians in the reign of Demetrius II. (146–125). From that time the Seleucidae were restricted to Syria, until that region was taken from them by Ptolemy and converted into a Roman province (65 B.C.).

Self-defence. See ASSAULT, MANSLAUGHTER.

Self-denying Ordinance, a measure carried through parliament in 1645 by the influence of Cromwell and the Independents, by means of which generals who were either less efficient or but half-hearted in the cause were removed from the command of the army. After Manchester's lack of energy at the second battle of Newbury (October 27, 1645) Cromwell had determined upon a change of tactics, and attacked Manchester in parliament, but he soon found the more sweeping measure a better means towards his ends. The Lords threw out the measure, whereupon the Commons proceeded to form a New Model Army under Sir Thomas Fairfax as general-in-chief. The Lords now passed the measure with some alterations and called on all existing officers to resign. Thus Essex, Waller, and Manchester were got rid of, while Cromwell was specially reappointed to the command of the cavalry as lieutenant-general.—For a similar measure, but one suicidal to good government, in the history of the French Revolution, see MIRA-BEAU, and ROBESPIERRE.

Selim I., Sultan of Turkey, son of Bajazet II., was born in 1467, and dethroned his father by the aid of the Janizaries, 25th April 1512. Then he caused his father, brothers, and nephews to be put to death. This gives the key to his character—warlike, energetic, unscrupulous, and fanatical. In 1514, after massacring 40,000 Shiites, he declared war against Shah Ismail of Persia, whom he defeated at Chaldiran in the neighbourhood of Tabriz; but a spirit of disaffection breaking out in his army, he was compelled to content himself with this success, which gave him possession of the provinces of Diarbekir and Kurdistan. In 1517 he conquered the Mameluke rulers of Egypt, and annexed that country, Syria, and the Hejaz. Moreover he won from the Abbaside calif, then living as a spiritual prince at Cairo, the headship of the Mohammedan world, the title of imam, and the standard of the

Prophet, and gained possession of the sacred cities of Mecca and Medina. He also laid the foundation of a regular marine, constructed the arsenal of Pera, chastised the insolence of the Janizaries with savage severity, and laboured to ameliorate, by improved institutions, the condition of the various peoples he had conquered. He died 22d September 1520, while planning an expedition against Rhodes. Strange to say, this savage fanatic was a lover of literature, and even himself cultivated the poetic art. He was succeeded by his son, Solyman (q.v.) the Magnificent. For other sultans named Selim, see TURKEY.

Selinus, an ancient Greek colony in the western end of Sicily, now represented by ruins close to the modern Castelvetro. It was founded by Dorians about 628 B.C., conquered by the Carthaginians in 409, and utterly destroyed by them in 249, the inhabitants being deported. The most notable ruins still extant are six great Doric temples.

Seljuks, a division of the Ghuzz confederacy of the Turkish tribes, who were settled on the Jaxartes and in Transoxiana in the 11th century, when they became converts to Islam. Togrul Beg, grandson of a chief named Seljuk (whence the name of the several successive dynasties), severely crippled the empire of Ghazni (1040), and then turning westwards conquered all Persia. Ten years later he marched upon Bagdad, to the assistance of the Abbaside Calif (q.v.), a mere *fainéant* sovereign, who existed by the favour and protection of a powerful family of the Shiite faith. The head of this family (the Bowides) was, however, the master rather than the protector of the calif. Him Togrul seized and supplanted; and, being of the orthodox Sunnite faith, he was nominated by the calif 'Commander of the Faithful.' Dying in 1063, Togrul was succeeded by his nephew Alp-Arslan. This sovereign wrested Syria and Palestine from the rival Fatimite calif of Egypt, and in 1071 defeated the Byzantine emperor Romanus Diogenes, and captured him. The price of his release was a heavy ransom and the cession of great part of Anatolia or Asia Minor to the Seljuk. Alp-Arslan was stabbed by a captive enemy in distant Turkestan (1072), and was succeeded by his son Malik Shah. His reign is chiefly remarkable for the enlightened rule of his grandvizier, Nizam ul-Mulk, the schoolfellow of Omar Khayyam (q.v.), the poet, and of Hassan ibn Sabbah, the founder of the Assassins (q.v.). This statesman founded a university at Bagdad, an observatory, and numerous schools and mosques, and with the help of his old friend Omar Khayyam revised the astronomical tables and introduced a new era, the Jelalian. After the death of Malik (1092) the extensive empire began to break up into smaller kingdoms. But already during his lifetime, and even that of his predecessors, powerful tributary princes had ruled over separate provinces in Syria (see NUR ED-DIN and SALADIN), in Kerman (beside the Persian Gulf), and in Asia Minor. During the first half of the 12th century the most powerful of these provincial rulers was Sinjar, who governed Khorassan, with Merv for his capital. He spent his life fighting against the Ghaznevids, against the Turkestan chiefs, and latterly against the Mongols. But a stronger and more immediate interest attaches to the province of Syria and that of Asia Minor, or Rum, as the Seljuks preferred to call it. It was the rulers of these two provinces or kingdoms who persecuted the Christian pilgrims and so provoked the Crusades (q.v.), and it was the rulers of the same two kingdoms against whom the crusaders of Europe principally fought. The capital of Rum was fixed at Iconium (Konieh) in the first

half of the 12th century. This dynasty reached the acme of its power under Kaikavus (1211-34), who ruled over nearly the whole of Asia Minor and extensive territories in Mesopotamia and northern Persia. During the reign of his son Kaikhosran II. the poet Jelal-ed-Din Rumi flourished and the various orders of dervishes arose; and at the same time the Mongols began to threaten the eastern borders of the state. Indeed from about 1243 the real sovereign power of that part of Asia was in the hands of the Mongol chiefs, Hulagu and his successors, until the rise of the Ottoman princes. These last, Turks like the Seljuks, had retreated westwards before the all-conquering Mongols about the middle of the 13th century, and at the end of it they entered the service of the Seljuk ruler of Asia Minor. After that the name Osmanli or Ottoman soon superseded that of Seljuk as the appellation of the Turkish rulers and ruling classes in Asia Minor. And out of the Ottoman supremacy grew the empire of Turkey (q.v.). The Seljuks, however, had centuries before, whilst they were still settled in Transoxiana, lost a good many of their peculiarly Turkish characteristics and had become 'Turkomans,' i.e. 'Like the Turks;' and with their conversion to Islam they also adopted the Perso-Arabian civilisation and customs, though still retaining their own language as well as using those of the peoples they had conquered.

See De Guignes, *Histoire des Huns*, &c. (4 vols. 1756-58), and the German translation (by Vullers, 1838) of Mirkhond's Persian *History of the Seljuks*.

Selkirk, a Scottish royal burgh, the county town of Selkirkshire, on an eminence 400 to 619 feet high, that flanks the right bank of Etrick Water, 6½ miles S. by W. of Galashiels by a branch-line (1856) and 40 SSE. of Edinburgh. The county buildings (1870), the town-hall (1803), with a spire 110 feet high, and the statues of Scott (1839) and Mungo Park (1859) are the chief features of the place, with the beautiful grounds of the Haining House. The 'souters of Selkirk' were long famous for their 'single-soled shoon;' but to-day the staple manufacture is that of tweeds, which dates from 1835. With Hawick and Galashiels Selkirk returns one member since 1868. Pop. (1831) 1880; (1861) 3695; (1891) 6397. About 1113 Earl David founded at *Schelechyrc* ('kirk of the shiels') a Tironensian abbey, which as David I. he removed about 1126 to Kelso (q.v.). The story of the eighty Selkirk men who marched to Flodden (1513), but of whom one only returned, bringing a captured pennon, dates, according to Mr Craig-Brown, only from 1722. Mr Andrew Lang is a native.

Selkirk, ALEXANDER. See JUAN FERNANDEZ.

Selkirk, EARL OF. See DOUGLAS, MANITOBA.

Selkirk Mountains, an outlying range of the Rocky Mountains, in British Columbia, extending southwards from about 52° N. lat. to near the United States frontier. The range contains enormous glaciers, and is the home of bears, big-horn sheep, the Rocky Mountain sheep, &c. One pass-valley (Rogers') has been reserved as a national park. The Canadian Pacific Railway climbs over the mountains at a point 4300 feet above the sea. See W. S. Green, *Among the Selkirk Glaciers* (1890), who describes what he saw of the range as 'a perfect Alpine paradise.'

Selkirkshire, an inland county in the south of Scotland, bounded by Peebles, Edinburgh, Roxburgh, and Dumfries shires. Measuring 28 miles by 17, it has an area of 260 sq. m. or 166,524 acres, of which barely one-seventh is under crops. Silurian in formation, and drained by Etrick and Yarrow Waters to the Tweed, it is a pastoral region, of grassy rounded hills—Minchmoor (1856 feet), Dun Rig (2433, the highest), Etrick Pen

(2269), and eight others exceeding 2000 feet above sea-level. Sheep-farming (over 160,000 head) is an important industry; and the manufactures are confined to the two towns of Selkirk and Galashiels. The Duke of Buccleuch is chief proprietor, holding about three-fifths of the whole county. Since 1867 Selkirkshire has united with Peeblesshire to return one member. Pop. (1801) 5388; (1851) 9809; (1871) 14,005; (1891) 27,353, of whom 6937 were in Selkirk, and 17,367 in Galashiels. Smaller than Middlesex, and than all but six of the thirty-three Scotch counties, Selkirkshire yet contains within its narrow bounds almost all the old Forest of Ettrick; St Mary's Loch; the whole course of the Yarrow; the vale of Ettrick, where the 'Shepherd' was born and lies buried; the birthplaces, too, of Laidlaw and Mungo Park, of the 'Flower of Yarrow' and Alison Cockburn; Ashiesteel, where Scott wrote *Marmion*; the scenes of the ballads of 'The Douglas Tragedy,' 'The Dowie Dens,' 'The Outlaw Murray,' and 'Young Tamlane;' the battlefield of Philiphaugh; and the ruins or sites of the castles and peel-towers of Newark, Dryhope, Tushielaw, Oakwood, and Buccleuch. See the articles *ETTRICK, YARROW, PHILIPHAUGH*; and T. Craig-Brown's *History of Selkirkshire* (2 vols. 1886).

Sellar, WILLIAM YOUNG, was born at Morvich near Golspie in Sutherland, February 22, 1825, and educated at Edinburgh Academy, of which at fourteen he was head-boy. He next went to Glasgow University, from which he passed at seventeen, a Snell Exhibitioner, to Balliol College, Oxford. He graduated with a classical first-class, in 1850 was elected to a fellowship at Oriel, next acted as assistant-professor at Durham, Glasgow (1851-53), and St Andrews (1853-59), filled for four years the Greek chair at St Andrews, and was elected in 1863 to the Latin chair at Edinburgh, which he retained till his death near Dalry in Galloway, 12th October 1890. He made his name widely known by his learned and brilliant book, *The Roman Poets of the Republic* (1863; revised and enlarged, 1881), which was followed by *The Roman Poets of the Augustan Age—Virgil* (1877), and *Horace and the Elegiac Poets* (1892), the latter edited from his papers by his nephew, Mr Andrew Lang, with a brief memoir prefixed. Of the last volume—the completion of his task—the part treating of Ovid alone is unfinished. The whole forms a noble *corpus* of criticism on the greatest poets of Rome, marked by full knowledge, insight at once keen and sympathetic, and a fine dignity of style—a quality in modern days too rare.

Selma, capital of Dallas county, Alabama, on the Alabama River, and at the intersection of a number of railways, 165 miles by rail NNE. of Mobile. It has a large trade in cotton, and possesses ironworks, cotton-factories, steam planing-mills, car-works, &c. Pop. (1890) 7626.

Selsey, or SELSEA, a village of 900 inhabitants, on a flat and dreary but fertile peninsula on the Sussex coast, 7 miles S. of Chichester. Here in the middle of the 7th century the cathedral church of the South Saxons was founded by Wilfrid of York; and Selsey was the see of a succession of twenty-two bishops, till in 1079 the seat of the bishopric was transferred to Chichester by Bishop Stigand. The sea has made great encroachments on the peninsula, which ends in Selsey Bill; and the site of the old cathedral is now submerged.

Seltzer Water (Ger. *seltzerwasser*) takes its name from the village of Nieder-Selters near Limburg, in the Prussian district of Wiesbaden, where several springs, in one basin, yield 5000 cubic feet an hour of this sparkling and effervescent mineral water. Its chief ingredients are carbonic acid, bicarbonate of sodium, and common salt. It acts

as a mild stimulant of the mucous membranes and as a diuretic, and is applied in chronic disorders of the digestive, respiratory, and urinary organs. It is much used as a beverage and as a table-water by those suffering from liver complaint, and in hot climates and seasons. Some three million jars or bottles of this famous water are exported yearly to all quarters of the world. The spring was discovered early in the 16th century, but was at first little prized. Artificial Seltzer Water is extensively manufactured both on a large scale and for domestic use. See *AERATED WATERS, MINERAL WATERS*.

Selwyn, GEORGE, wit, was born of a good old Gloucestershire family on 11th August 1719, and was educated at Eton and Hertford College, Oxford, whence, after making the grand tour, he was expelled in 1745 for a blasphemous travesty of the Eucharist. He entered parliament for a pocket borough in 1747, and, siding generally with the court party, was rewarded with several sinecures; in 1751 succeeded his father in the Matson property; and for the best part of half a century led the life of a man about town, dozing in the House, gaming pretty deeply, corresponding much, and haunting executions. He often visited Paris, where he had the *entrée* of the best and the highest society, whilst at home his chief intimates were the Duke of Queensberry, Horace Walpole, 'Gilly' Williams, and Lord Carlisle. Grown at last 'like the waxwork figure of a corpse,' he died penitent at his house in Cleveland Row, London, on 25th January 1791. He left £33,000 to Maria Fagniani, and the residue of his fortune to 'Old Q,' who disputed with him the paternity of that future Marchioness of Hertford.

See Jesse's delightful *George Selwyn and his Contemporaries* (4 vols. 1843), and the review thereof in Hayward's *Lord Chesterfield and George Selwyn* (1854).

Selwyn, GEORGE AUGUSTUS, bishop, was born 5th April 1809. He was educated at Eton and at Cambridge. He rowed in the first inter-university boat-race (1829), and was a great pedestrian and swimmer, athletic powers found very serviceable in after life. In 1841, while curate of Windsor, he was consecrated first and only bishop of New Zealand and Melanesia—now divided into seven sees. On the voyage out he studied Maori and navigation, so that he could preach to the natives in their own tongue on his arrival, and could steer his own vessel on his missionary voyages. He visited every portion of his huge diocese before setting about his great work of organising it. A visit to England in 1854 brought back John Coleridge Patteson, afterwards the martyred bishop of Melanesia, to whose see Bishop Selwyn's second son was consecrated in 1877. In 1867 Bishop Selwyn attended the first Pan-Anglican Synod at Lambeth, and against his own inclinations was appointed Bishop of Lichfield—the see of the Black Country—where upon his initiative the first Diocesan Conference in which the laity were duly represented met in 1868, and where he died 11th April 1878. A devoted churchman, with love to God and loyalty to his sovereign and his archbishop as his guiding principles, he thought no duty too humble, no act of kindness too trifling, and no work to which he was sent too difficult to undertake. Possessing in a special degree the gift of organisation, and always regarding himself as 'a man under authority,' he expected the same soldier-like obedience from those under him. He did much to make Lichfield the life-giving, spiritual heart of the diocese, and so fulfil his high ideal of the cathedral system.

See *Life* by Rev. H. W. Tucker (2 vols. 1879) and (more popular) *Life* by Rev. G. H. Curteis (1 vol. 1889). For Selwyn College, see *CAMBRIDGE*, Vol. II. p. 670.

Semaphore (from *sēma*, 'a sign,' and *pherō*, 'I bear') was the name applied to the system of telegraphy in use before the application of the electric current. Semaphores were invented by Richard Lovell Edgeworth in 1767 (cf. p. 91 of his *Memoirs*, ed. 1854), but were first regularly established by the French in 1794 as a plan for conveying intelligence from the capital to the armies on the frontier. In the following year Lord George Murray introduced them in England; and by their means the Board of Admiralty were placed within a few minutes of Deal, Portsmouth, or Plymouth. These semaphores consisted of towers built at intervals of from 5 to 10 miles on commanding sites. On the top of each tower was the telegraph apparatus, which at first comprised six shutters arranged in two frames, by the opening and shutting of which in various combinations sixty-three distinct signals could be formed. In 1816 Sir Home Popham substituted a mast with two arms similar to many of the present railway signals. The arms were worked from within the tower by winches in the lookout room, where a powerful telescope in either direction constantly commanded the mast of the next station. If a fog set in at any point on the route the message was delayed; otherwise when a sharp lookout was kept the transmission was very rapid. For instance, the hour of one by Greenwich time was always communicated to Portsmouth when the ball fell at Greenwich; the semaphores were ready for the message, and it commonly passed from London to Portsmouth and the acknowledgment back to London within three-quarters of a minute. Each station was in the charge of a naval officer—usually a lieutenant—with one or two men under him. To save the cost of this establishment the Deal and Plymouth lines fell into disuse soon after the peace of 1815; and the superior advantages of the electric telegraph being incontestable, the Portsmouth line sent its last message on the 31st December 1847, and in this capacity the semaphore closed its career of usefulness for ever. Railway signals are, however, a form of semaphore. See RAILWAYS, p. 558, and, for the semaphore used for communicating with ships, SIGNALLING.

Semecarpus, a genus of polypetalous trees, of which the *S. Anacardium* is the Marking-nut Tree of India, a deciduous tree growing in the sub-Himalayan tract. An ink much used in that country for marking cotton cloths is obtained from the acrid juice of the pericarp of the fruit. Lime-water is added to improve the ink. The fleshy cup of the ripe fruit is eaten raw, but it is better when roasted. Bird-lime is made of the fruit in its green state. The wood also contains an acrid juice which causes swelling and irritation, in consequence of which the timber is not put to any use.

Semele. See DIONYSUS.

Semendria, a fortress of Servia, stands on the right bank of the Danube, 26 miles S.E. of Belgrade. Here the Turks defeated the Hungarians in 1411. The place was taken by storm by Prince Eugene in 1717. Pop. 6578.

Seminoles, a tribe of American Indians, originally (1750) a vagrant branch of the Creeks, whose name Seminole signifies 'wild' or 'wanderer.' In 1817 they joined with the Creeks and some negroes who had taken refuge with them, ravaged the white settlements in Georgia, plundering plantations, and carrying off slaves, whom they refused to surrender. General Jackson was sent to punish them, and his expedition hastened the negotiations which ended in the cession of Florida to the United States (1819). By a treaty of 1823 the Seminoles, who numbered some 4000, gave up most of their lands for an annuity, and agreed to return fugitive slaves; but in 1832, to satisfy the settlers, the

chiefs were deluded into signing a treaty agreeing to the removal of the whole tribe west of the Mississippi. This treaty was repudiated by the tribe at the instigation of Osceola (q.v.), one of their chiefs; and a war commenced against a handful of savages which lasted seven years, and cost hundreds of lives and millions of dollars. In the end the remains of the tribe were removed to the Indian Territory, where (except some 200 who are still left in Florida and some few in Texas and Mexico) all the Seminoles are now settled; they number 3000, receive an annuity of \$25,000, have eight churches, besides government schools, and are under the training of Presbyterian missionaries.

Semipalatinsk, a province of Asiatic Russia, stretching northwards from Lake Balkash to the provinces of Tobolsk and Tomsk. It embraces outliers of the great Altai and other lofty chains of central Asia, rising to 10,000 feet, and enclosing between them wide stretches of steppe-land. The principal river is the Irtysh, which flows north-westwards to the Obi. The climate ranges between wide extremes, and the whole region is undergoing desiccation. Area, 183,145 sq. m.; pop. (1897) 685,197, mostly Kirghiz. The chief town, Semipalatinsk, standing on the right bank of the Irtysh, is an important trading centre for that part of Asia. Pop. 17,820.

Semi-Pelagianism. See PELAGIUS.

Semiramis, wife of Ninus, mythical founder of Nineveh according to Ctesias and the Greek historians. A daughter of Dereto the fish-goddess, she was exposed in infancy, but miraculously fed by doves, then brought up by Simmas a shepherd, whose name she took. Onnes, one of the king's generals, charmed by her beauty, married her, but she won the heart of the king himself by her heroic capture of Bactra, whereupon her husband had the loyalty to make away with himself. Ninus soon died, leaving Semiramis to reign gloriously for forty-two years, conquering in Persia, Libya, Ethiopia, unsuccessful in India alone. At the end of this time she left the throne to her son Ninyas and disappeared, thereafter to be worshipped as a divinity. The story is most probably borrowed from some Median epic. The name of the mighty queen survived in place-names, and was familiarly attached to the great works of antiquity, as the hanging gardens of Babylon. Many things in her story, and such points of detail as her personal beauty and her voluptuousness, point to an identification with the great Assyrian goddess Astarte (q.v.). See Lenormant, *La Légende de Semiramis* (Brussels, 1873).—The Semiramis of the North was a name not inappropriately applied to Catharine II.

Semiretchinsk, a province of Asiatic Russia, having East Turkestan on the S.E., Ferghana on the S.W., and Lake Balkash on the N., is a mountainous region, being crossed from east to west by the Ala-tau and Thian-Shan Mountains, whose peaks run up to 16,000 feet. Between them lies the mountain-lake of Issyk-kul. In the north of the province there are level tracts, partly fertile, partly barren sand. The climate is temperate; earthquakes occur—e.g. at Vyernyi (pop. 11,584), the chief town. Area, 147,298 sq. m.; pop. (1897) 758,258, of whom 595,000 are Kirghiz and 44,000 Russians; they are mostly engaged in pastoral pursuits, rearing large herds of horses, camels, and sheep.

Semites, a convenient name given by J. G. Eichhorn in 1787 to a group of nations closely allied in language, religion, manners, and physical features, who are mostly represented in Genesis x. as descended from Shem, a son of Noah. Their habitat is Abyssinia, Arabia, Palestine, Phœnicia,

Syria, and the countries of the Euphrates and Tigris. Into those lands, according to one theory which is supported by Lenormant and others, there had preceded them an immigration of Cushites of the Hamitic race, who, proceeding from central Asia, occupied not only the lands that afterwards became Semitic, but also the Nile valley. Their Hamitic language and civilisation the Semites are said to have adopted. In language the Semites do show some affinity with the Berbers and the inhabitants of the Nile valley, and Genesis x. does, for political and geographical or other reasons, distribute the sons of Ham and Shem in a peculiar manner. But the increasingly prevalent theory is that not less than 4000 years B.C. the Semites migrated as nomadic tribes, probably from Arabia, into Mesopotamia. There they found a Turanian population dwelling in cities built of brick, under the regular government of priest-kings, skilled in the use of metals, using the cuneiform mode of writing, and comparatively far advanced in literature and culture. The hold of the Semites upon Shumir, the lower, more fertile, and more thickly inhabited part of the Euphrates valley, was not at first so strong as upon Accad, the upper part. In 3800 B.C. the Semitic adventurer Sharrukin usurped the kingdom of Accad. In Elam also the Turanian population was early overpowered by the intruding Semites, who came to form the upper strata of society. In 2280 B.C. the Semite Khudur-Nankhundi of Elam invaded and conquered Shumir and Accad, founding the Elamite line of princes; and about 2200 B.C. one of his successors, Khudur-Lagamar (Chederlaomer), carried his conquests as far as Palestine (see Genesis xiv.). These painful and oppressive impulses, and probably others like them, seem to have occasioned emigrations of many Semites. Some proceeded towards the north-west, reached the Mediterranean Sea, founded Sidon, Tyre, and other cities, and became known afterwards as Canaanites or Phœnicians. Later from Ur went others in the same direction, settled behind the Phœnicians, and were afterwards known as Israel. Others went northwards and built cities which developed into the empire of Assyria. While the Semites were in Mesopotamia they used the Turanian language in their public documents until they attained the ascendant in political power; and when afterwards they used their own language they continued to use the Turanian cuneiform mode of writing. The Turanian religion also was adopted by the Semites, and mixed with what religion their own primeval tribal religion or totemism had developed into. This amalgamation was consummated by Sharrukin II. of Accad about 2000 B.C.

The Semites as a race have a fine physical organisation, are mentally quick, clever, but not inclined to change, and not persistent in progress. They have been distinguished by a brilliant imagination and love of the beautiful; but have not shone in philosophy nor in science. Their literature has neither epic nor dramatic poetry worth notice. Almost their only arts are the sculpture of Assyria, the exquisite glass and pottery, and the textile fabrics and embroidery of the Phœnicians. Impatient of restraint, the Semites have not by political aptitude welded together themselves or others into large, compact, and enduring commonwealths. They have made their mark on the world in the Phœnician commerce, which visited even the Atlantic shores of Spain and France and drew tin from Britain; in the Phœnician colonies, which, dotting all the coasts and many islands of the Mediterranean Sea as far as Cadiz, and the coast of Asia as far as India, dispensed manufactures, improved primitive navigation, stimulated industry, trade, and ingenuity,

and radiated the light of material civilisation; in the Carthaginian empire within Europe and Africa; in the exploits of Hannibal; in the dissemination of alphabetic writing, whereof the Phœnician form was the mother of the European and of most Asiatic alphabets, while the alphabet of the great Sabeian kingdom, or of the great and still more ancient Minean kingdom in Arabia, is apparently the oldest of all alphabets hitherto discovered; in the Babylonian and Assyrian empires; in the Hebrew Bible and the Jewish religion; in the New Testament and the Christian religion; in the Koran and the Mohammedan religion; in the Mohammedan conquests and empire; and in the preservation of culture thereby during the dark and middle ages.

SEMITIC LANGUAGES, the languages spoken by the Semitic nations. One characteristic feature of them is triconsonantal roots from which by prefixed or affixed letters, but mostly by internal vowel changes, the other words are formed. Thus in Arabic *katāba* = 'he wrote,' *kātib* = 'a scribe,' *kitāb* = 'a book,' *maktūb* = 'an epistle.' Another characteristic feature is that, though personal pronouns are affixed to nouns, verbs, and prepositions, there is an almost total absence of compound nouns, adjectives, and verbs. Thus, while in Arabic *beiti* = 'my house,' *gatalahu* = 'he killed him,' *minhā* = 'from her,' there are no such compound words as pro-motion, dread-ful, grati-fy. Other characteristic features are a verb with two tenses, and the simple structure of sentences, which are mainly formed by juxtaposition of clauses helped by *and*. Semitic languages have a much closer family likeness than the Indo-European, and show a large proportion of common words. The most highly developed, and on the whole the most characteristic, probably also the oldest of the group, is Arabic, which, with its ancient Sabeian and Minean dialects of southern, western, and northern Arabia, and with Ethiopic, forms the southern division of Semitic languages, marked by the use of 'broken plurals,' in which the consonants of the singular are preserved, while the vowels are as much altered as possible. Thus from the Arabic *kitāb*, 'a book,' comes the plural *kūtūb*. Another mark is the universal use of *a* before the third radical letter of the active preterites; thus Arabic has *gatala*, *agatala*, for which Hebrew has *gittēl* and *hittil*. Another mark is the distinction between the Arabic *sād* and *dād*, which are united in the Hebrew letter *tsade*.—HEBREW, though a characteristically Semitic speech, shows many marks of linguistic decadence; ancient Hebrew is a more modern type of language than modern Arabic.—PHŒNICIAN differs little in grammar and dictionary from Hebrew. In the African territory of Carthage this language was spoken 400 years after the Christian era; a century before that era in Phœnicia itself it yielded to Aramean or to Greek. Our only examples of it are a few corrupt sentences in the *Panulus* of Plautus, and inscriptions, most of which date from the 4th century B.C. or later, few belonging to the preceding three centuries.—MOABITIC, as the Moabite Stone of the 9th century B.C. shows, was Hebrew.—ARAMEAN had its home in Aram of Damascus and Aram of Mesopotamia. It was the language of Assyria from early times, as we may see in 2 Kings xviii., and of Babylonia, even while Assyrian was used there for official purposes. It was the official language of the provinces of the Persian empire west from the Euphrates. Its western branch was the language of Palmyra and of the northern part of the Arabian kingdom of the Nabatheans, and is seen in the biblical books of Ezra and Daniel, where it has been erroneously named Chaldee. Later developments of this branch are the officially recognised Targums by Onkelos on

the Pentateuch, and Jonathan on the Prophets, which were finally edited and fixed in the 4th or 5th century A.D. in Babylonia. Somewhat later are some Midrashes, the Jerusalem Targums, and the Jerusalem Talmud. Of the 4th or 5th century are Palestinian translations of the Gospel.—SAMARITAN is another branch of western Aramæan, written in a Hebrew alphabet older than the Captivity, and spoken about 432 B.C. by an Aramæan people with Israelitish blood in them, who were desirous of conforming in speech as in religion to the Hebrew usage of northern Palestine. Arabic soon expelled western Aramæan after the Mohammedan conquest, though a faint echo of it still lingers in the Anti-Libanus. The Babylonian Talmud shows the common eastern Aramæan of Babylonia from the 4th to the 6th century. The language of the Mandæan sect resembles it. In the 2d century the Edessan dialect of Aramæan, which we call SYRIAC, began to be the language of eastern Christendom for all purposes; but for popular use it was slowly supplanted by Arabic after the Mohammedan conquest, becoming a dead and almost entirely ecclesiastical language. In the mountain regions of ancient Assyria Aramæan is still represented by several local dialects among Christians and even Jews.—ASSYRIAN, so called by us moderna because discovered by us in Assyria, is more correctly named BABYLONIAN. It is written in the difficult, cumbrous, and inadequate cuneiform character received from the Turanian natives. It shows scarcely any sign of a preterite tense. In popular use it early gave way to Aramæan.—ETHIOPIC, a sister tongue to Arabic, in some respects resembles more closely Hebrew and Aramæan even in the most ancient form of the language known to us.

For more detailed information as to the several Semitic peoples and their languages and literatures, see ALPHABET, ARABIA, ASSYRIA, CARTHAGE, ETHIOPIA, HEBREW LANGUAGE, JEWS, PHENICIA; MOHAMMED, KORAN, CALIF, &c. Semitic scholars are Gesenius, Ewald, Halévy, Fürst, Lane, Dozy, J. de Goeje, Dillmann, P. de Lagarde, Land, Delitzsch, Haupt, Strassmaier, Menant, Oppert, George Smith, Rawlinson, Lenormant, Chwolsohn, Renan, Nöldeke, Hommel, Fleischer, Rödiger, A. B. Davidson, Robertson Smith, Wright, Payne Smith, Badger, Sayce, Salmoné, Wüstenfeld, Socin, Kautsch, Böttcher, Petermann, Nestle, W. H. Green, Driver, Cheyne, Schrader, Schröder, Wellhausen, Baethgen. The 'Records of the Past' give many valuable translations of ancient writings. See Wright's *Comparative Grammar of the Semitic Languages*, edited by Robertson Smith (1890).

Semler, JOHANN SALOMO, one of the most influential German theologians of the 18th century, was born 18th December 1725, at Saalfeld in Thuringia, and educated at Halle. After editing for a year the Coburg official *Gazette*, and lecturing on philology and history at Altdorf for six months, he was in 1752 appointed professor of Theology at Halle, where he taught with great success. He died at Halle on 14th March 1791. For many years he enjoyed a wonderful popularity as a teacher, and exercised so wide and profound an influence as pioneer of the historical method that he has been called the 'father of Biblical Criticism.' Yet, of course, he contributed little to the science; his chief merit is to have pointed out the way and indicated the right methods to those who came after. He was distinctively a rationalist, and one of the most influential in emancipating theology from the fetters of tradition. But he sincerely believed in revelation; and he lost favour through his opposition to the *Wolfenbüttel Fragments*, and his adverse criticism of the 'naturalism' or extreme rationalism of Bahrtdt. Both friends and enemies found it difficult to reconcile his defence of revelation with his own critical freedom. In insisting on

the distinction of the Jewish and Pauline types of Christianity he (possibly influenced by the deists Toland and Morgan) clearly anticipated a main position of the Tübingen school. As a thinker he was deficient in philosophical consistency and breadth of view; and as a writer he possessed no literary skill or grace. He wrote a vast number of books; but none is of much value at the present day. The more important were *Apparatus ad liberalem Veteris Testamenti Interpretationem* (Halle, 1773), *Abhandlung von freier Untersuchung des Kanons* (4 vols. 1771-75), *De Dæmoniacis* (1760), *Selecta Capita Historiæ Ecclesiasticæ* (3 vols. 1767-69).

See his own *Lebensbeschreibung* (1781-82); Schmid, *Theologie Semlers* (1858); Tholuck, in his *Vermischte Schriften*; and for the influence of the Deists, an article by David Patrick on 'English Forerunners of the Tübingen School' in the *Theological Review* for 1877.

Semliki, a river of equatorial Africa, flowing north-east into Albert Nyanza. It was discovered by Stanley in 1888.

Semlin (Hung. *Zimony*), a frontier town of Hungary, stands on a tongue of land at the junction of the Save and the Danube, on the right bank of the latter, opposite Belgrade. It contains the ruined castle of John Hunyady, who died here. The town is the great seat of the Turco-Austrian transit trade, and the principal quarantine station for travellers from the Balkan states. Pop. 11,836, mostly Servians. See Kinglake's *Eothen*.

Semmering, a mountain on the borders of Styria and Austria, 60 miles SW. of Vienna, and 4577 feet above the sea, over which the Vienna, Gratz, and Trieste Railway has been carried by a series of ingenious engineering contrivances. The railway, built in 1850-53 at a cost of £2,000,000, sweeps up the steep face of the mountain in many curves, and descends its southern slope, after having passed through 15 tunnels and numerous galleries, and crossed 16 viaducts. It extends from Gloggnitz on the north to Mürrzuschlag on the south, a distance of 25 miles, traversed by quick trains in 1 hour and 37 minutes; by slow in 2 hours 17 minutes. The greatest elevation is reached at 2940 feet in the Semmering tunnel (4692 feet long). The steepest gradient for any distance is 1 in 40.

Semmes, RAPHAEL (1809-77). See ALABAMA.

Semnopithecus, the genus of monkeys to which the Entellus Monkey (q.v.) belongs.

Semolina, an article of food consisting of granules of the floury part of wheat. The name semolina is often applied to the larger sizes of 'middlings' made in the process of flour-milling (see MILL), and these products are sometimes sold under the name semolina in the granular state after thorough cleaning, instead of being ground into flour. Semolina is chiefly used for making puddings and soups.

Sempach, a small town of Switzerland, 9 miles by rail NW. of Lucerne, on the east shore of the lake of Sempach. Under its walls Leopold, Duke of Austria, with 4000 men, was met on 9th July 1386 by the confederated Swiss to the number of 1500. The nature of the ground being unfitted for the action of cavalry, the horsemen (1400 in number) dismounted, and formed themselves into a solid and compact body, which was at once charged by the Lucerners; but the wall of steel was impenetrable, and not a man of the Austrians was even wounded, while many of the bravest of the Swiss fell. But, as the legend runs, Arnold von Winkelried, a knight of Unterwalden, seized with a noble inspiration, rushed forward, grasped with outstretched arms as many pikes as he could reach, buried them in his bosom, and bore them by his weight to the earth. His companions rushed over

his body into the breach thus made, slaughtered the armour-encumbered Austrian knights like sheep, and threw the remainder into the utmost confusion and dismay. The result was a decisive victory for the Swiss, who thus asserted their independence, and finally broke the efforts of the Austrian dukes to subdue them. The anniversary of this great victory is still celebrated by religious solemnities on the field of battle.

Semper, KARL, naturalist, was born at Altona on 6th July 1832, studied at Kiel, Hanover, and Würzburg, and, after travelling in the Philippines and South Sea Islands, became professor of Zoology at Würzburg. He has written on the Philippines, on several problems of comparative anatomy, and *The Natural Conditions of Existence as they affect Animal Life* (trans. 1880).

Sempervivum. See HOUSE-LEEK.

Sempringham. See GILBERTINES.

Sen, KESHUB CHUNDER, an Indian religious reformer, was born at the village of Garifa (Gouripore) in Bengal, on 19th November 1838, and received an education partly English, partly Hindu. About 1858 he was attracted by the Brahmo Somaj (q.v.), and soon afterwards began the work of his lifetime, a steady endeavour to promote the religious regeneration of his countrymen. In 1866 he founded the more liberal 'Brahmo Somaj of India.' After a visit to England in 1870 he organised in Calcutta several schemes of charitable philanthropy on the lines of what he had seen in England. In 1878 a schism broke out in his church, caused by his own autocratic temper, and by his leanings to mysticism. His last years were years of controversy, waning influence, and disappointment; and he died on 8th January 1884. See Max-Müller, *Biographical Essays* (1884).

Senaar. See SENNAAR.

Sénancour, ÉTIENNE PIVERT DE, author of *Obermann*, was born at Paris in November 1770. In a sickly and secluded boyhood he read eagerly, especially travels; at fifteen entered for four years the Collège de la Marche; and here devoured Malebranche, Helvétius, and the 18th-century philosophers, losing his faith completely in the process. At nineteen, with the connivance of his mother, he left home to escape the course at Saint Sulpice required by his imperious father, turned his steps to the lake of Geneva, the next year at Fribourg married a young girl who did not long survive, lost his patrimony through the Revolution, but returned to Paris about 1798, and thereafter made a modest living by his pen, eked out with a pension granted by Louis-Philippe on the recommendation of Thiers and Villemain. He died at Saint-Cloud in February 1846, asking that on his grave might be placed these words only: *Eternité, deviens mon asile*. His fame rests securely on three books: *Réveries sur la Nature primitive de l'Homme* (1799), *Obermann* (1804), and *Libres Méditations d'un Solitaire Inconnu*. In the first book we see the student of Rousseau weighed down by the absorbing dogma of necessity, full of aversion for all human society, returning to his ideal in the patriarchal nomad, the vegetative instinct, and the primordial sensations of man. In *Obermann* his hero travels in the Valais, next to Fontainebleau, and again to Switzerland, writing his thoughts the while in letters to a friend. Here the atheism and dogmatic fatalism of the *Réveries* have given place to universal doubt no less overwhelming. Nowhere is the desolating 'maladie du siècle' more effectively expressed than in this book, which, with affinities enough to Chateaubriand and Madame de Staël, is yet completely original in its inwardness, its sincerity, the deli-

cate feeling for nature it exhibits, and the melancholy eloquence of many of its passages. 'Though he may be called a sentimental writer,' says Matthew Arnold, 'and though *Obermann*, a collection of letters from Switzerland treating almost entirely of nature and of the human soul, may be called a work of sentiment, Sénancour has a gravity and severity which distinguish him from all other writers of the sentimental school. The world is with him in his solitude far less than it is with them; of all writers he is the most perfectly isolated and the least attitudinising. His chief work, too, has a value and power of its own, apart from these merits of its author. The stir of all the main forces, by which modern life is and has been impelled, lives in the letters of *Obermann*; the dissolving agencies of the 18th century, the fiery storm of the French Revolution, the first faint promise and dawn of that new world which our own time is but now more fully bringing to light—all these are to be felt, almost to be touched, there. To me, indeed, it will always seem that the impressiveness of this production can hardly be rated too high.'

Sénancour was neglected in his day, but he has found fit audience in George Sand, Sainte-Beuve, and, amongst ourselves, Matthew Arnold, whose two elegies, *In Memory of the Author of Obermann* and *Obermann Once More*, are known to all lovers of English poetry.

See Sainte-Beuve's two essays in *Portraits Contemporains*, vol. i.; and the *Corahill Magazine*, vol. xlv.

Senate, the deliberative assembly of the Roman people (see ROME, Vol. VIII. p. 789). In modern republics, as in France (q.v.) and the United States (q.v.), the senate is the upper chamber of the legislature. The governing body of universities usually is the senate (see UNIVERSITIES).

Sendai, a town on the east coast of the mainland of Japan, 220 miles NNE. of Tokyo by rail. Pop. (1890) 90,231.

Seneca, ANNÆUS SENECA (prænomen unknown), a Spaniard from Corduba (Cordova), was born about 54 B.C., and, having come to Rome as a youth, studied eloquence under Marullus. We next find him again in Spain, married to Helvia, by whom he had three sons—Novatus, Lucius Annæus, and Mela (father of Lucan the poet). About 3 A.D. he returned to the capital a second time to busy himself with rhetoric, till, under Tiberius, he sought his native country once more, and died there, 39 A.D. He was a great admirer of Cicero. With much of the antique Roman fibre, he had moral ballast enough to steer clear of the excesses on which contemporary rhetoricians made shipwreck. Besides a historical work, now lost, he wrote in later life *Oratorum et Rhetorum Sententiæ; Divisiones; Colores*; ten books of 'Controversiæ,' of which the first, second, seventh, ninth, and tenth are complete, the remainder surviving only in extracts; and one book of 'Suasoriæ'—the whole, fragmentary as they are, of high importance for the history of Roman rhetoric. The best edition is that of H. J. Müller (Prague, 1887), while Sander's *Sprachgebrauch des Rhetors Annæus Seneca* (1880) is of special value to the student of Latin style.

Seneca, L. ANNÆUS, son of the preceding, also a native of Corduba, was born about 4 B.C., and carefully educated for the bar, under his father's eye, in Rome, where, in Caligula's reign, he narrowly escaped the death to which that emperor, jealous of his enlightened liberalism, had destined him. After years of exclusive devotion to philosophy and rhetoric, he entered the Curia, but, 41 A.D., lost the favour he had won with Claudius by

getting involved, through the emperor's infamous wife Messalina, in a state-trial which ended in his banishment to Corsica, whence he did not return till after an exile of eight years. Entrusted by Agrippina with the education of her son Nero, he acquired over the youth an influence as strong as it was salutary, and, having already at Agrippina's instance become prætor, he was, at that of Nero (now emperor), made consul, 57 A.D. His high moral aims and intellectual gifts, possibly through defect of the courtier's tact, gradually incurred the aversion of the rapidly deteriorating emperor, who at length came to regard him with jealousy and hatred. He has been taxed by imperial apologists, but unjustly, with vanity and ambition—more plausibly, perhaps, with love of wealth and the power it brings. His wealth, accumulated under Nero's profligate extravagance, excited, it is said, the rapacity of the emperor, whose sinister designs he anticipated by offering to refund it, with the exception of a pittance on which he proposed to retire. These overtures Nero rejected, whereupon, under pretence of illness, he withdrew from the public gaze. An attempt on Nero's part to poison him having failed, he was drawn into the Pisonian conspiracy, accused, convicted, and condemned. Left free to choose his mode of death, he elected to open his veins, and gradually succumbed to syncope, 65 A.D. His second wife, Pompeia Paulina, who wished to die with him, and actually had her own veins incised for the purpose, survived him a few years.

A noble, upright character, Seneca was yet the object of calumnious detraction—to such a degree that the utmost caution is necessary in passing judgment on him. In philosophy he inclined to the Stoic system, though not indisposed to engraft upon it the tenets of the Epicurean school. But his moral independence is an outstanding feature in his voluminous *dicta*, which, often profound, are always sharply and distinctly reflected in the steel-mirror of his style. Earnestness and self-abnegation are their most memorable note, especially in their inculcation of man's duty to himself and to his neighbour. The relations of his teaching to Christianity have recently evoked a number of treatises, attempting to prove his correspondence, if not personal association, with the apostle Paul, his contemporary in Rome. The points of divergence, however, between him and the teacher of the Gentiles are more numerous than the points of coincidence (see the Dissertation in Lightfoot's Com. on Philippians). His writings, apart from much that has been fathered on him, include three books *De Ira*; three consolatory pieces addressed to his mother Helvia, to Polybius, and to Marcia (*De Consolatione*); treatises *De Providentia*, *De Animi Tranquillitate*, *De Constantia Sapiens*, *De Clementia (ad Neronem Cæsarem)*, *De Brevitate Vitæ (ad Paulinum)*, *De Vita Beata (ad Gallionem)*, *De Otio aut Sessu Sapiens*; seven books *De Beneficiis*; 124 *Epistulæ ad Lucilium*, comprising free speculations on philosophical questions of every kind, in which his characteristic powers appear to special advantage; a scathing satire on the Emperor Claudius, in the form of a parodied apotheosis (*Apocolocyntosis sive Ludus de Morte Cæsaris*); finally, seven books *Questionum Naturalium*, addressed to Lucilius the Younger—the only surviving Roman treatise on physics, if not the first in Latin literature (of the same compass at least). It reveals a decidedly exacter and wider knowledge and a sounder critical faculty than the later work of the elder Pliny.

Seneca had also a poetical side, if we may accept as his the epigrams (mainly referring to his banishment) and the eight tragedies (*Hercules Furens*, *Thyestes*, *Phædra*, *Edipus*, *Troades*, *Medea*, *Ag-*

memnon, and *Hercules Cætus*, along with two scenes from a *Thebais*) usually comprised among his *opera omnia*. These are imitations of Greek models, and are distinguished by great mastery of style, vigorous imagination, and keenness of psychological insight. But their purely rhetorical, eminently undramatic, character unfits them for the stage, if indeed they were ever intended for it. In versification they are 'correct' to a fault, till the monotony of their cadences becomes as wearisome as their declamatory strain.

Of editions of his prose writings that of Gronovius (1661-82), of Ruhkopf (1797-1811), and, best of all, that of Fickert (1842-45), still hold their place, while some of his special treatises have been carefully edited by Koch and Vahlen, and by Gertz. His tragedies may be most conveniently read in the editions of Gronovius (1661-81), of Schröder (1728), of Bothe (1819 and 1822), of Peiper and Richter (1867), and of Leo (1878); *Minor Dialogues*, translated by A. Stewart (1889). See also a paper by H. A. J. Munro on Peiper and Richter's edition in the *Journal of Philology*. A striking portrait of the philosopher-statesman at Nero's court, especially in relation to his assumed association with St Paul, is given in Mr Hugh Westbury's novel, *Acté* (1890).

Seneca Falls, a post-village of New York, on the Seneca River, 10 miles from the lake and 41 miles by rail WSW. of Syracuse. The river falls 50 feet here, and the place contains a number of mills, foundries, and manufactories of steam fire-engines, pumps, &c. Pop. (1890) 6116.

Seneca Lake, one of a range of narrow lakes in the western part of the state of New York. It is 36 miles from north to south, 2 miles in average width, and 530 feet deep. Steamboats ply daily from end to end.—For the Seneca Indians, from whom the lake takes its name, see IROQUOIS.—Senega (q.v.) is a form of the same word.—Seneca Oil is an old name for Petroleum (q.v.).

Senecio, the most numerous genus of the great natural order Compositæ, having a hairy pappus, a naked receptacle, and a cylindrical involucre of linear equal scales, with a few smaller scales at their base. The species are annual, perennial, and half-shrubby plants, natives chiefly of the temperate and cold parts of the world, the half-shrubby species being from the warmer latitudes. Eleven species are reckoned as British, and commonly known as Groundsel (q.v.) and Ragwort (q.v.). *S. Saracenicus*, probably not a true native of Britain but introduced in the middle ages, has undivided lanceolate leaves, and was once in repute as a vulnerary. The Fireweed of North America is *S. hieracifolius*. It receives its popular name from its appearing abundantly wherever a part of the forest has been consumed by fire. Many species of Senecio have a strong, disagreeable smell. A few are rather ornamental as flowers; see CINERARIA.

Senefelder, ALOYS. See LITHOGRAPHY.

Senefte, or SENEFE, a town in the province of Hainault, Belgium, 27 miles by rail S. by W. of Brussels, with a pop. of 3438, is the centre of a district in which manufactures of pottery and glass are extensively carried on, but is chiefly notable as the battlefield on which William of Orange (III. of England) was defeated after a bloody contest by the Great Condé, 11th August 1674. Here, too, on 2d July 1794 the French general Marceau defeated the Austrians.

Senega, or SNAKE ROOT, is the dried root of *Polygala Senega*, used as a cure for snake-bites in America. See MILKWORT.

Senegal, a river of West Africa, has two main sources, the Bafing which flows north from the plateau of Futa-Jallon, and the Bakhoy which comes from the south-east, the country of Buré, not

far from the north bank of the Joliba (Niger). These streams meet at Bafulabé, 700 miles from the coast, and from there the united Senegal flows north-west, west, and south-west, and reaches the Atlantic some 10 miles below St Louis. For three months of the year (July-October) boats drawing 20 feet can get up to Kayes, 40 miles below Bafulabé. The channel is, however, in those higher reaches greatly obstructed by falls and 'narrows,' and in its lower course it is studded with numerous low, flat islands. Although the river is navigable all the year round for about 200 miles up, it is not so serviceable to navigation as it might be because of a formidable bar that lies across its mouth. The difficulties of the navigation are in part overcome by a railway along the left bank of the river, between Kayes and Dioubéba, a place 25 miles beyond Bafulabé, and the French are continuing the line to Bamako on the Niger, which is only about 320 miles distant from Kayes.

SENEGAL, a French colony in West Africa, consisting of various posts, towns, and territories situated on both banks of the river Senegal, as St Louis, Dagana, Médine, Bafulabé, &c. The population does not exceed 135,500. The administrative districts of the colony are under a governor. For further particulars, see SENEGAMBIA.

Senegambia, a territory subject to France, situated on the west coast of Africa and embracing the colony of Senegal proper and various protected states, as Cayor and Salum (along the Atlantic), Danga, Banibuk, Bundu, and others lying between the Atlantic Ocean and the Senegal and Gambia rivers—the word 'Senegambia' (not used by the French) is compounded of the names of these two rivers. Until 1890 Senegambia included the region known as the 'Rivers of the South' (Casamance, Casini, Nunez, Pongo, and others), and certain districts on the Gold Coast; but at the date quoted the more southerly region (Rivières du Sud) was placed under a separate lieutenant-governor, who resides at Konakry on the Dubreka, and the Gold Coast districts were divided into two distinct and independent colonies, the Gold Coast districts and the Bight of Benin districts. On the other hand, farther north, the French claim the Atlantic coast southwards from Cape Blanco to the mouth of the Senegal; whilst inland they have extended their authority over Futa-Jallon, Beledugu, and Macina as far as the Joliba (Niger). These several protected states of the interior are generally called collectively the French Soudan, and are administered by an officer under the governor of Senegal. Moreover in virtue of recent treaties—e.g. with Great Britain in August 1890—the vast expanse of the Sahara south of Algeria and Tunis, right up to the Niger, and to a line drawn eastwards from Say on that river to Barraua on Lake Tsad, is recognised as being within the French 'sphere of influence;' and in 1894 France worked her way down the Niger to Timbuctoo. South of the Niger also she has fairly begun to establish herself, for in 1889 Captain Binger proclaimed in agreement with the native chiefs a protectorate over the Kong states, an immense area stretching almost down to the Gulf of Guinea, from 8° 30' to 12° N. lat. Thus the territory claimed by France in this part of Africa extends from Tunis to Sokoto and the Gulf of Guinea, and from the Atlantic and the frontier of Morocco to Lake Tsad. The only interruptions to the continuity of this vast area are the British colonies of Gambia and Sierra Leone, Liberia, certain Portuguese territories of no great extent, and the numerous small colonies belonging to different European powers on the Guinea coast.

Of this gigantic territory France actually occupies little more than the colonies of Senegal, 'Rivers of

the South,' and the two groups on the Gold Coast. These are estimated to have a total area of 165,000 sq. m. and a total pop. of 200,000. The people belong for the most part to the Foulah and Mandingo tribes of Negroes, and are in part Moslems, in part fetich-worshippers. The 'French Soudan' has an area of probably 50,000 sq. m. and an estimated pop. of nearly 300,000. The principal geographical feature in these united regions is the plateau (2000 to 4000 feet) of Futa-Jallon, from its valleys issue many rivers that flow (e.g. the Gambia) west and south-west to the Atlantic, north to the Senegal, and east and north-east to the Joliba (Niger). The villages of the natives are chiefly planted beside these various watercourses. Ground-nuts, gums, india-rubber, timber (including 'Senegal ebony;' see DALBERGIA), and other wild products constitute the bulk of the exports, which reach an annual value of £662,000 (three-fourths to France). The imports (textiles, liquors, and food-stuffs) are valued at £1,120,000 (nearly half from France). St Louis (q.v.) is the principal town in these colonies. The French first settled in this part of Africa about the beginning of the 17th century; but the settlements (more than once captured by the English and again restored) languished until the appointment of General Faidherbe as governor in 1854. He began a most vigorous line of action, subdued the Berber chiefs who prevented the French advance inland, and annexed their territories. This policy was pursued in the same spirit by subsequent governors; districts were annexed and protectorates proclaimed with extraordinary celerity, though the two powerful chiefs Ahmadou and Samory occasioned them a great deal of trouble during the years 1887 to 1890.

See *Senegal et Niger* (an official publication, Paris, 1884); Faidherbe, *Le Soudan Français* (Lille, 1881-85); *Annales Sénégalaises* (1886); and *Bull. Soc. de Géographie* (1891).

Seneschal (Old French; from the same roots as the Gothic *sins*, 'old,' and *skalks*, 'a servant;' compare *marshal*), a functionary in the household of the Frankish kings corresponding to what in England and Scotland was designed 'steward,' usually rendered into Latin as *senescallus*.

Senigallia. See SINIGAGLIA.

Senior, NASSAU WILLIAM, political economist and 'prince of interviewers,' was born on 26th September 1790, at Compton in Berkshire, the eldest son of the vicar of Durnford, Wilts, and from Eton passed to Magdalen College, Oxford, where in 1812 he took a distinguished first-class in classics. In 1819 he was called to the bar at Lincoln's Inn; during 1825-30, and again during 1847-62, was professor of Political Economy at Oxford; in 1832 was appointed a Poor-law commissioner; and from 1836 to 1853 was a Master in Chancery. He travelled much, and wrote much for the *Edinburgh Review* and other leading periodicals, his twenty works including, besides treatises on political economy, *Biographical Sketches* (1863); *Essays on Fiction* (1864); *Historical and Philosophical Essays* (1865); *Journals, Conversations, and Essays relating to Ireland* (1868); *Journals kept in France* (1871); *Conversations with Distinguished Persons during the Second Empire* (4 vols. 1878-80); and *Conversations and Journals in Egypt and Malta* (1882). He died 4th June 1864.

Senlac. See HASTINGS.

Senlis, a very ancient town of France, dept. of Oise, 33 miles NNE. of Paris. Its older portion is surrounded by walls, flanked by towers, which date from Roman times. The cathedral, a small edifice, with a striking bell tower, is a beautiful example of early Gothic (begun in 1155); Senlis ceased to be a bishop's seat in 1801. Here was

signed on 23d May 1493 a treaty between Charles VIII. of France and the Emperor Maximilian I. There still exist the ruins of an old royal castle. Pop. 7111.

Senna is the dried leaflets of several species of *Cassia*, various preparations of which are used in medicine as purgatives. Two sorts are recognised in the British Pharmacopœia—viz. Alexandrian senna and Tinnivelly senna. The Alexandrian senna leaves are chiefly obtained from *Cassia acutifolia*, while the Tinnivelly senna leaves are yielded by *Cassia angustifolia*. Alexandrian senna is chiefly grown in Nubia and Upper Egypt, and is imported in large bales from Alexandria. It is often adulterated largely with the flowers, pods, and leaves of *Solenostemma Argel*. Tinnivelly or East Indian senna resembles Alexandrian senna in odour and taste. The leaflets are, however, larger and finer, 'about 2 inches long, lanceolate, acute, unequally oblique at the base, flexible, entire, green, without any admixture.' The rounder leaves of the *C. obovata* are also used in medicine, and are sometimes mixed with the other kinds.



Cassia obovata.

The active principle in senna is a glucoside, which has been named cathartic acid, and which is closely allied to chrysarobin and the purgative principle in rhubarb; there are also other substances which impart to senna its peculiar odour and taste, as well as a variety of sugar. The different pharmaceutical preparations of senna act as moderately active cathartics, but tend to cause griping. To obviate this, and to disguise the nauseous taste of the drug, they are all made up with a number of carminative and flavouring substances. The active principles in senna are excreted in the urine, which is coloured a deep yellow, and by the milk, which is rendered purgative. The official preparations comprise the *confec-tion of senna* (dose 60 to 120 grains), the *infusion of senna* (dose 1 to 2 fluid oz.), the *syrup of senna* (dose 1 to 4 fluid drachms), the *tincture of senna* (dose 2 to 8 fluid drachms), and the *compound mixture of senna* or 'black draught' (dose 1 to 1½ fluid oz.). Compound liquorice powder consists largely of senna. The dose of senna itself is 10 to 30 grains.

BLADDER SENNA (*Colutea*) is a genus of shrubs of the natural order Leguminosæ, sub-order Papilionacæ, having pinnated leaves, red or yellow flowers, and remarkably inflated pods, whence the English name. One species (*C. arborescens*) is common in shrubberies in Britain. It is a native of the south of Europe, and is found on the active of the crater of Mount Vesuvius—almost the only plant that exists there.

Sennaar (properly *Sennar*, sometimes also *Senaar*), a city of the Eastern Soudan, stands

on the Blue Nile, about 160 miles SSE. of Khar-toum. Pop. 8000. It is the chief town of a dis-trict lying between the Blue and the White Nile, which was made an Egyptian province in 1820, but fell to the Mahdi in 1884. An account of the disastrous expedition of Hicks Pasha into this province in 1883 will be found in Colonel the Hon. J. Colborne's book, *With Hicks Pasha in the Soudan* (1885), and in Major Wingate's *Mahdism and the Egyptian Sudan* (1891).

Sennacherib, an Assyrian king, son of Sargon, reigned 702 to 681 B.C. The chief events of his reign are enumerated under Assyria (q.v.). He was the originator of great public works, as the embankment of the Tigris, the making of canals, watercourses, and the erection of a gigantic palace at Nineveh.

Senonian. See CRETACEOUS SYSTEM.

Sens, an old town of France, dept. Yonne, stands on the right bank of the Yonne, 70 miles by rail SE. of Paris, and is still surrounded with its ancient walls. Its principal ornament is the Gothic cathedral of St Stephen, built in 1122-68, but restored twice or thrice since. It has splendid portals, fine stained glass, and two large bells; in its treasury are preserved the vestments of Thomas à Becket. There are also the palace and ancient public offices of the archbishop, and a town museum. The chemist Thénard was born in the place. Pop. (1891) 13,942. See Vaudin, *Les Fastes de la Senonie* (Paris, 1882).

Sensation may be defined as the change in consciousness which results from the transmission of nervous impulses to the brain. Such impulses may be generated within the nerves themselves (but only in diseased conditions), or may be produced by stimuli applied to such parts of the body as are provided with nerves. Such nerves are often styled sensory or afferent. It must be remembered, however, that afferent impulses are constantly being carried to the brain from all parts of the body, resulting in motor and other acts necessary to our life, without exciting any sensation at all. It is through our sensations that we gain our knowledge of the external world, and of the state of our body. The means by which these are produced are the elaborate nervous mechanisms developed in connection with the various senses of smell, sight, hearing, taste, touch, temperature (or heat and cold), pain or general sensibility, the muscular sense, and those of hunger and thirst. While we have obtained a certain amount of knowl-edge of the nature of a nervous impulse resulting in muscular movement, the same cannot be said of a sensory nervous impulse. We cannot measure the rate of its transmission along the nerve; we have absolutely no notion of the change, if it is legitimate to employ such a term, by which a sensory nervous impulse becomes transformed into a sensation; we as yet know imperfectly at what part of the brain this transformation takes place, or by what paths the sensory impulses travel towards the brain. It has long been known, how-ever, that if the posterior division of the bundle of nerve fibres constituting that part of the cerebrum which is termed the internal capsule (see BRAIN) is destroyed a complete loss of sensation on the opposite side of the body results. This has led to the investigation of the posterior part of the cerebrum, to which these fibres more specially pass, for 'centres,' the destruction of which would in-volve loss of the various forms of sensibility. The results are as yet conflicting. It is generally agreed that the 'centre' for sight is in the inner side of the occipital lobe; but there is in the angular con-volution another centre in which visual sensations probably undergo a further elaboration. Above the

corpus callosum there lies a long convolution, the gyrus fornicatus, the removal of which produces complete loss of tactile sensibility of the opposite half of the body; but in the 'motor area' there are probably other centres, as this is rarely diseased without the production of peculiar modifications of sensation. The centre for hearing has been located in the upper convolution of the temporal lobe, that for smell and taste on the anterior end of the temporal lobe. An exhaustive consideration of the difficulties of the problem will be found in Foster's *Text-book of Physiology*.

Each of the special senses has its own peculiar end-organ: the special endings of the olfactory nerves in the upper part of the septum of the nose for that of smell; the retina in the eyeball for sight; the rods of Corti in the cochlea for hearing; the taste bulbs and the fibrils in the fungiform papillae in the tongue for taste; and the Pacinian corpuscles and the special ramifications of the cutaneous nerves in the epidermis for touch. The integrity of these and of the special non-nervous apparatus with which they are connected is necessary for the production of a sensation. Thus, the transparent media of the eyeball, and the rods and cones of the retina are all essential to the production of a visual sensation. In proportion as they are abnormal, the sensation is imperfect. Further, each end-organ can be thrown into action only by certain kinds of stimuli, and the nerves in connection with them convey those impulses only which give rise to their own special varieties of sensation. The retina can only be stimulated by waves of light, never by those of sound, and the optic nerve if stimulated directly can give rise to visual sensations only. This law holds good also for the cutaneous nerves, there being reason to believe that the end-organs for touch are not the same as those for temperature. It is probable even that there are separate nerves for the perception of heat and of cold. All parts of the end-organs are not equally sensitive or capable of being similarly affected by the same kind of stimulus. Thus, the same substance may appear sweet at the anterior part and bitter at the posterior part of the tongue. The retina is most sensitive at the yellow spot, while the various colours are perceived over areas which differ considerably. Tactile sensibility varies exceedingly. The points of a compass can be felt as double at a distance of about $\frac{1}{15}$ part of an inch at the tip of the tongue, of $\frac{1}{5}$ of an inch on the front of the tip of the forefinger, but only at a distance of more than $2\frac{1}{2}$ inches on the back.

The muscular sense is that by which we are made aware of the position of any part of the body, by which we gauge the amount of movement necessary to affect any object or to overcome any resistance. Many authorities deny the existence of such a special sense altogether, and believe that it is merely a form of ordinary tactile sense. But that this is not so is frequently illustrated in a disease of the spinal cord, locomotor ataxy, in which there is, when the eyes are shut, a more or less complete absence of knowledge of the position of the limbs and of the power of regulating their movements, although the cutaneous tactile sensibility may be quite normal. It would appear likely that the nerve endings connected with this sense are situated in the muscles, tendons, and joints, and that these are stimulated by changes in movement and mutual pressure in these structures.

The sensation of pain (or general sensibility) is produced when pressure on a part, or when the temperature of a body applied, exceeds certain limits. What was at first a sensation of touch, or of heat or cold, becomes replaced by a painful sensation. It is very difficult to be certain whether there are

special end-organs for the reception of such impressions. It is quite beyond doubt that the olfactory, optic, auditory, and gustatory nerves do not transmit painful impressions, and it might be supposed that the analogy would hold in the case of the senses of touch and temperature. It is found in some cases of disease that the prick of a pin may be felt as a touch one or two seconds before it becomes painful. But this is open to the explanation that the delay in the latter case may take place in the spinal cord owing to a different path of conduction rather than to a difference in the time that it takes to stimulate the end-organ. Painful sensations may result from excessive stimulation of a sensory nerve at any part of its course, which would seem to point in favour of the non-existence of special end-organs. With regard to the paths by which these various impulses reach the brain, we know (if we except the fifth cranial and the vagus nerves) that they reach the spinal cord by the posterior roots of the spinal nerves, and that those impulses which produce tactile, thermal, and painful sensations for the most part (though this has recently been questioned) travel up the side of the cord opposite to that at which they entered, but their exact course is not certainly determined. The path for the muscular sense-impulses is by many regarded as lying in the posterior columns of the same side (see SPINAL CORD).

Within the medulla oblongata the obscurity as to the upward sensory conducting tracts is even greater than in the cord, not only in the case of the senses above mentioned, but also of the sense of hearing and taste. It is probable that the paths are not continuous, but are frequently interrupted by nerve cells, through the agency of which the nervous impulses undergo successive elaborations before reaching the cerebral cortex. The evidence for the existence of special upward conducting strands in the spinal cord, and the connections of these, are fully considered under the article SPINAL COLUMN AND SPINAL CORD.

See Landois and Stirling's *Physiology* (for details of investigations in various senses); Quain's *Anatomy* (for end-organs and nervous apparatus); Foster's *Physiology* (for general consideration of the problems involved). See also TASTE, NOSE, EYE, VISION, PERCEPTION, NERVOUS SYSTEM, PSYCHOLOGY, Vol. VIII. p. 474.

Sensitive Plant, a name commonly given to certain species of *Mimosa* (see MIMOSEÆ), on account of the peculiar phenomena of Irritability (q.v.) which their leaves exhibit in their collapse when touched or shaken. Numerous species of *Mimosa* possess this property, and, indeed, most of the species in a greater or less degree; but those in which it is most conspicuous are humble herbaceous or half-shrubby plants. They have leaves beautifully divided, again and again pinnate, with a great number of small leaflets, of which the pairs close upwards when touched. On repeated or rougher touching the leaflets of the neighbouring *pinnæ* also close together, and all the *pinnæ* sink down, and at last the leaf-stalk itself sinks down, and the whole leaf hangs as if withered. If the stem is shaken all the leaves exhibit the same phenomena. After a short time the leaf-stalk rises, and the leaflets expand again. On account of this curious and interesting property some of the sensitive plants are frequently cultivated in our hothouses. They are generally treated as annuals, although capable of longer life. *M. sensitiva*, one of the best-known species on the continent of Europe, is a native of Brazil, with prickly stems and leaf-stalks, and small heads of rose-coloured flowers. *M. pudica* is the species most commonly cultivated in British hothouses; it is a branching annual growing from 1 to 2 feet high. *M. casta*, *M. pudibunda*, *M. palpitans*, and

M. viva are also among the most sensitive species. See the section on the movement of plants at PLANTS; also Dr G. Haberlandt, *Das reizleitende Gewebesystem der Sinnpflanze* (Leip. 1890).

Sensorium, the supposed centre of sensation or seat of the soul, once believed to be some spot in the brain. See BRAIN, PINEAL GLAND, SENSATION.

Sentinel, Sentry (from the Lat. *sentire*, 'to feel or perceive,' through the Ital. *sentinella*), a soldier or sailor marine at a point with the duty of watching for the approach of an enemy, or guarding the gun-park, camp, magazine, or other locality. When an army is in the field its front and flanks are protected by 'outposts.' These consist of a chain of pickets (some fifty men each), covered in front by the sentries they throw out, and assisted in rear by other bodies called 'supports.' Each picket would furnish two to four double sentry posts, so that no portion of ground along the front is unwatched. These double sentry posts must be visible to one another and to other sentries (single) who, posted over the piled arms of each picket, report their signals. Sometimes groups of three to six men, one watching, the rest lying down, are used instead of the double sentries. If attacked, sentries fall back on the pickets, and with them retire upon the supports. Each is entrusted with the 'parole' or countersign, and no person, however exalted in position, may approach or pass him without giving that as a signal. As the safety of the army depends upon the vigilance of the sentries, the punishment for sleeping when on sentry-duty on active service is death.

Sentis. See SÄNTIS.

Senussi (*Senūsiya*), a Moslem confraternity of austere and fanatical doctrines, which has done much to unite the Mohammedan population of North Africa in hostility and resistance to foreign and infidel influences. Mohammed es-Senussi ('of the Senus mountains'), from Mostaganem in Algeria, became famous about 1830 in Fez for his sanctity. After performing the Haj to Mecca he founded a convent at Alexandria, but was excommunicated by the Sheikh ul-Islam and settled in the Libyan Desert, first near Bengazi in Barca, and then at Jerabub or Jaghub near the oasis of Siwa. Here he established a prosperous college, and here in 1860 he died, being succeeded by his son, who claimed to be the promised Mahdi (q.v.), though his manifestation was to be postponed till 1892. The confraternity has ramifications all over North Africa, especially in Tripoli, Fezzan, and Gadames. The French have come into contact with them; their agents have repeatedly stopped European travellers; and after the death in 1885 of the Egyptian Mahdi, from whom they had carefully held aloof, they acquired additional influence in the Soudan. See Wingate, *Mahdism and the Egyptian Sudan* (1891); A. Silva White, *From Sphinx to Oracle* (1898).

Seoni, a town in the Central Provinces of India, half-way between Nagpur and Jabalpur on the great Deccan road. Pop. 10,203.—There is a smaller Seoni (pop. 7100) 35 miles SW. of Hoshangabad.

Seoul, or SÖUL, the capital of Corea, stands on the river Han, 75 miles from its entrance into the Yellow Sea and 57 miles from its port Chemulpo (q.v.). It lies in a natural basin, amongst granite hill-ranges, and is surrounded with walls. The streets are very narrow and very dirty, and the houses beggarly in the extreme. The city includes several wide, desolate squares. The royal palace and its adjuncts cover 600 acres of ground. Silk, paper, tobacco, mats, fans, and similar commodities

are the principal products of native industry. Pop. 150,000; including extensive suburbs, 300,000.

Sepal. See CALYX, FLOWER.

Separate Estate. See HUSBAND AND WIFE.

Separation of married persons is either judicial or voluntary. If the parties enter into a deed or other arrangement to live separate, this is called a voluntary separation, and in general the legal rights of the parties are not altered, except that if the wife is provided with maintenance she has no longer an implied authority to bind the husband. And though voluntary separation is not encouraged by courts of law, yet effect will be given frequently to deliberate contracts of this kind entered into between the parties. Formerly the intervention of a trustee was in all cases necessary, but now an arrangement made directly between husband and wife is enforced by the English courts. In the United States the law of several states confers the right to contract, to maintain actions, &c. on a married woman who, for good cause, is living apart from her husband. See Stimson's *American Statute Law*; see also JUDICIAL SEPARATION.

Sephardim. See ASHKENAZ.

Sepharvaim. See BABYLONIA.

Sepia, a brown pigment used as a water-colour. It is prepared from the dark-brown colouring matter of the ink-bag of a few species of Cuttle-fish (q.v.), particularly *Sepia officinalis*, which, though chiefly fished for in the Adriatic and Mediterranean, is also found in British seas. The pigment from the dried ink-bags is dissolved in a solution of ammonia or soda and then precipitated by neutralising the alkali with hydrochloric acid, the precipitate being afterwards washed and dried. An ounce of the natural pigment will darken several thousand ounces of water. *Sepia* excels all other water-colours in the ease with which its tints can be evenly put on paper with a brush. It is much used by itself for sepia drawings, and also in combination with other colours for various subdued tints. It is, however, not suitable for oil-painting. *Sepia* is permanent when not exposed to sunshine. Strange to say, the pigment from the ink-bags of fossil cuttle-fish possesses the same colour and character as that from recent species. An 'Indian ink' is sometimes made from sepia. This substance appears to have been used both as an ink and a pigment by the ancients.

Sepoy, corrupted from the Persian *sipahi*, 'a soldier,' denotes a native Hindu soldier as distinguished from a European (white) soldier (*gora*).

Seps. See SKINK.

Septaria are ovate, flattened nodules of argillaceous limestone or ironstone, internally divided into numerous angular fragments by reticulating fissures radiating from the centre to the circumference, which are filled with some mineral substance, as carbonate of lime or sulphate of barytes, that has been infiltrated subsequent to their formation. The fissures have been produced by the cracking of the nodule when drying. They are largest and most numerous in the centre, and gradually decrease outwards, showing that the external crust had first become indurated, and so, preventing any alteration in the size of the whole mass, produced wider rents as the interior contracted. The radiating figure and the striking contrast between the dark body of argillaceous limestone or ironstone and the more or less transparent sparry veins when the nodule is cut and polished have caused them to be manufactured into small tables and similar objects. Calcareous septarian nodules are extensively employed in the manufacture of cement. As they are composed of clay, lime, and iron, they form a cement which hardens under water, and

which is known commercially as Roman cement, because of its properties being the same as a famous hydraulic cement made of ferruginous volcanic ash brought from Rome. Such septaria occur in layers in clay deposits, and are quarried for economical purposes in the clays of the London basin. Large numbers are also dredged up off Harwich, which have been washed out of the shore-cliffs by the waves. The septarian nodules of the Carboniferous strata consist generally of clay ironstone, and are sometimes employed in the manufacture of iron. The nodules generally contain a scale, shell, plant, fruit, coprolite, or some other organic substance, forming the nucleus that has apparently excited the metamorphic action which withdrew from the surrounding clay the calcareous and ferruginous materials scattered through it, and aggregated them around the fossil.

September (Lat. *septem*, 'seven') was the seventh month of the Roman calendar, but is the ninth according to our reckoning (see CALENDAR). The Anglo-Saxons called it *gerst-monath*, 'barley-month.'

Septembrists, the perpetrators of the atrocious September massacres in the prisons of Paris, which went on continuously for six days and five nights, September 2-7, 1792. Every violent movement in the history of Paris during the fever of Revolution was a counterpart to some menace or disaster on the frontier, and the immediate occasion of this crowning atrocity was the reaction of panic at the capture of Longwy and Verdun by the Prussians. It assured the political power of the Commune and controlled the elections to the Convention. Las Cases tells us that Napoleon found himself able to suggest apologies for the atrocity in the exigencies of the moment. M. Taine gives the number of victims as follows: 171 at the Abbaye, 169 at La Force, 223 at the Châtelet, 328 at the Conciergerie, 73 at the Tour-Saint Bernard, 120 at the Carmelites, 79 at Saint-Firmin, 170 at Bicêtre, 35 at the Salpêtrière; among them 250 priests and the Princess de Lamballe. See DANTON, MARAT, and ROBESPIERRE.

Septennial Act. See PARLIAMENT, p. 776.

Septicæmia. See GERM, PYÆMIA.

Septuagesima. See QUINQUAGESIMA.

Septuagint (Gr. *σβ*; Lat. *Septuaginta*, LXX., Alexandrian Version), the most ancient translation of the Old Testament, important as the version used by Christ and the apostles, and as the chief surviving witness to the purity of the text of the Hebrew Scriptures. It derives its name from the story of its origin, first told in the *Letter of Aristeas*, which purports to have been written by a Greek of Alexandria at the time of the events to which it refers. Aristeas relates how King Ptolemy Philadelphus (284-247 B.C.), when engaged in making a collection of the laws of all nations for the great Alexandrian library, was advised by his librarian, Demetrius Phalereus, to have the Jewish Scriptures translated into Greek; how the king sent an embassy to Jerusalem to request the help of the wise men of Israel; how seventy-two learned Jews (six out of each tribe) came to Alexandria and were sent to labour in the seclusion of the Island of Pharos; and how, in seventy-two days, they dictated to Demetrius the librarian a translation of the whole Scriptures, which soon became the authorised Bible of the Greek-speaking Jews. This story is a mixture of truth and romance. It is certain the Alexandrian version was the work of Hellenistic Jews. It is highly probable that it was a product of the great literary activity of the age of Ptolemy II. It is probable that the translation was begun at the king's instigation. It is

possible that the king's aim was not the satisfaction of a pressing want among his Jewish subjects, but simply the gratification of personal curiosity. But the picturesque details of the story—the embassy to Jerusalem, the choice of seventy-two translators, the seventy-two day's sojourn on Pharos, and so on—are purely mythical. Internal evidence shows that the translators—who were certainly numerous—were not Palestinian but Egyptian Jews. And it can be demonstrated that they were not a public body meeting and deliberating daily for a short period, but private individuals working independently in different ages. Where there are many different styles of work and many degrees of excellence, we make the inference that there were many independent workmen; and nothing is more striking than the want of uniformity in the LXX. Some of the workmen were evidently more competent than others, some more conscientious. Some aimed at exact translation, some at writing good Greek. Some liked to condense, some to expand. Infinite care seems to have been bestowed upon the Pentateuch. The translators of the Psalms and the Prophets were hardly equal to their difficult task. Some books, such as Ecclesiastes, Canticles, and Chronicles, are rendered into extremely Hebraic Greek. Others, such as Job and Proverbs, of which the Greek is excellent, must be regarded as paraphrases rather than translations.

Taking these things into account, one is prepared to find in the LXX. numerous small deviations from the received Hebrew text, due partly to the unskilfulness, partly to the arbitrariness of some of the translators. But there are divergencies of a more important kind. The books are differently arranged. In some books the order of the chapters is quite different. Additions and omissions are alike frequent. Occasionally, as in the books of Job, Esther, and Daniel, the Greek text contains whole chapters for which there is no equivalent in Hebrew. These variations offer an interesting problem for solution. How are they to be accounted for? They cannot be regarded as mere mistakes or caprices of the translators. They seem clearly to indicate that the Hebrew text which formed the basis of the LXX. was not the text that has come down to us—that the LXX. is the translation of an ancient text which has been lost; as such it is invaluable. It may be used as practically a second, independent text of the Old Testament. It cannot indeed be trusted implicitly. As a translation it has blemishes, and in the course of transmission many corruptions have crept into the text. But with all drawbacks it is of immense service in textual criticism. It not only establishes the general accuracy of the Massoretic text, but supplies the means of solving many of the difficulties of that text.

The LXX. has also close and important bearings upon the New Testament. The historical links of connection between them are as follows: Ptolemy's gift of the LXX. to his Jewish subjects was gladly accepted. It soon began to be used in the synagogues. Before long it found its way from Egypt into Palestine, and by the time of Christ it had almost entirely superseded the original Hebrew text. Thus it became the Bible of Christ and the apostles. Not only was it the source from which the authors of the New Testament drew almost all their quotations, but it created the very language in which they wrote. The Egyptian Jews who adopted the Greek language never adopted Greek ideas; they modified the language to suit their own ideas; they gave a new content to many important words. Thus there arose a dialect which was Greek in form but entirely Semitic in spirit. The LXX. stereotyped that dialect, and

the evangelists and apostles spoke and wrote it. Thus the LXX. is the key to the language of the New Testament. This fact is only now beginning to be duly appreciated. The great mistake of New Testament students has been to assume that the language of the New Testament is essentially that of classical Greek. It is never safe to assume that a word in the New Testament has its classical meaning. It is nearly always safe to assume that it has the meaning which it bears in the LXX.

The principal MSS. of the LXX. are the Alexandrian codex in the British Museum, the Vatican codex in Rome, and the Sinaitic (defective) in St Petersburg. The chief editions are the Complutensian (1514-17), the Aldine (Venice, 1518), the Sixtine (Rome, 1587), Reineccius (Leip. 1730), Parsons and Holmes (Oxford, 1798-1827), Tischendorf (Leip. 1850), Swete (Cambridge, vols. i. and ii., 1887-91). Important contributions have been made to the study of the LXX. in recent years by Lagarde, Wellhausen, Hatch, and others. Much, however, remains to be done before a satisfactory critical edition can be produced.

The Old Testament Apocrypha (q.v.) consists of books and parts of books in the LXX., and not included in our Hebrew Bibles. For other versions of the Hebrew, see BIBLE (Vol. II. p. 122). AQUILA, HEXAPLA, ORIGEN, POLYGLOT. The first part of a Concordance to the LXX., by Hatch and Redpath, appeared in 1891.

Sepulchral Mound. See BARROW, BURIAL, CAIRN.

Sepulveda, JUAN GINES, a Spanish historian, was born at Pozo-blanco, in the neighbourhood of Cordova, about 1490, studied first at Cordova and Alcalá de Henares, and went to Bologna in 1515, where and at Rome he became acquainted with the most celebrated savants of Italy and Spain. In 1536 he returned to Spain as historiographer to Charles V. and preceptor to his son, afterwards Philip II. After living successively in Valladolid, Cordova, and Madrid, he was made a canon of Salamanca. In that town he died on 23d November 1574. He won a reputation as the champion of humanism against the prevailing scholasticism. His principal work is entitled *Historia Caroli V.*, published with a biography and Sepulveda's other works by the Madrid Academy in 4 vols. in 1780. His other works include a Life of Albornoz, a History of the Reign of Philip II., and a History of Spain in the New World.

Séquard. See BROWN-SÉQUARD.

Sequence. See HYMN, Vol. VI. p. 46.

Sequestration, the Scotch legal term for Bankruptcy (q.v.).—In English law sequestration is a prerogative form of process, by which commissioners are empowered to take possession of the property of a person who is in contempt. There is also a special form of sequestration issued against a clergyman, by which the bishop is commanded to sequester the profits of the debtor's benefice to answer the plaintiff's claim. On sequestration the bishop is required to appoint a curate and assign him a stipend.

Sequin (Ital. *zecchino*, from *zecca*, the name of the Venetian mint), a gold coin of Venice, equivalent to the gold Ducat (q.v.).

Sequoia, a small genus (two species) of evergreen coniferous trees belonging to California. *S. gigantea*, better known in Britain as *Wellingtonia*, in other countries as *Washingtonia* and *Gigantabies*, is the 'Mammoth Tree' of California. *Sequoia* is a Latinised form of the name of the famous Cherokee chief, Sequoyah (see CHEROKEES). The mammoth tree, which is surpassed in height only by the Eucalyptus (q.v.) of Australia, was discovered by Douglas in 1831, though its existence

was recorded by Menzies in 1796; it was introduced into Britain in 1853 by Lobb. The tree, though found at elevations varying from 4000 to 7000 feet above sea-level, affects only sheltered valleys, in which it occurs in groves intermixed with other trees. The most remarkable of these groves is in Calaveras county; only less remarkable is that of Mariposa near the Yosemite Valley. The 'Mammoth Grove' of Calaveras consists of from 90 to 100 trees of gigantic proportions. One of the most notable is named 'Mother of the Forest.' It rises to the height of 327 feet, but is dead and barkless, though it girths 75 feet near the base. The bark, about 18 inches thick, was removed in sections by Mr G. L. Trask to the height of 116 feet (causing the



Fig. 1.—*Sequoia gigantea*—the 'Three Graces.'

death of the tree), and fitted up as it came from the tree in the Crystal Palace, Sydenham, to illustrate the proportions of the mammoth tree; this erection was destroyed by fire in 1866. Near by the 'Mother' lies prostrate the trunk of the 'Father of the Forest,' which girths at the ground 110 feet. In falling the trunk had broken over at the height of 300 feet. At that point the girth is 40 feet, and taking the average taper of the surrounding trees, this dead giant may reasonably be computed to have exceeded 400 feet at the time of its fall. Inside the fallen trunk there is a tunnel 35 feet long, and from 8 to 10 feet high. The 'Pioneer's Cabin,' a cavity in the trunk of another giant in this grove, is large enough to accommodate a numerous party at dinner. The 'Three Graces' (see fig. 1), growing within a few feet of each other, became famous for their symmetry and beauty; they attain almost equally to the height of 265 feet. The age of these larger specimens is variously estimated at from 2000 to 3000 years; such estimates, however, based as they are on the enumeration of the concentric rings of the trunk, are not to be implicitly relied upon, particularly in the case of evergreen trees. The timber of the mammoth tree is reddish in colour when matured, non-resinous, and inodorous, the fibre short, porous, and brittle; it is not regarded as durable. In Britain, when planted in rich alluvial soil in well-sheltered positions, it is found to rival the Larch or any of the more rapid growing timber-trees in the production of timber in a given time. The tree is hardy enough to resist the severest frost likely ever to be experienced in Britain, but will not endure wind, especially that from the north and east. There are several varieties in commerce, the result of cultivation—viz. *S. g. pendula* and *S. g. aurea*, which cannot be said to be in either case improvements on the faultless cone-like symmetry of growth which characterises the typical form. *S. sempervirens*, the other species, is the Redwood or Bastard-tree of the Californian

settlers, a handsome tree also of gigantic proportions. Though apt to assume a rusty appearance in winter in Britain, the effect of wind, the tree is perfectly hardy, and grows with great rapidity when planted in good soil and in sheltered



Fig. 2.

a, twig of *Sequoia gigantea*, with cone; b, *Sequoia sempervirens*, with male inflorescence; c, cone of latter.

places. The timber is light, beautifully grained, and durable, but splits with remarkable facility; so that though very useful to the Californian settlers for fences, &c., it is not good for purposes of carpentry. Both species are prized as ornamental trees, and no collection of choice conifers can be regarded as complete without them. See CONIFERÆ.

Sequoyah. See CHEROKEES.

Seraglio, an Italian word meaning 'enclosure' (from *sera*, 'a bolt'), once used in English for any enclosure such as the Jews' Ghetto at Rome, but now restricted to mean a harem or suite of women's apartments, apparently from a confusion with the similar but totally distinct Persian (and Turkish) word *serai*, 'a king's court,' 'palace,' also 'a caravanserai.' The Seraglio (*eski serai*, 'old palace'), the ancient residence of the sultan at Constantinople, stands in a beautiful situation, where Stamboul juts farthest into the Bosphorus, and encloses within its walls a variety of mosques, gardens, and large edifices, the chief of which is the Harem (q.v.). It is not now the residence of the sultans; see CONSTANTINOPLE.

Seraievo. See BOSNA-SERAI.

Seraing, a town of Belgium, 4 miles by rail SW. of Liège, stands on the right bank of the Meuse, and is connected by a handsome suspension bridge with the village of Jemeppe. It is the seat of a colossal manufactory of steam-machinery, locomotives, &c., which was established by an Englishman, John Cockerill (q.v.), in 1817 in the old summer palace of the bishops of Liège. On his death in 1840 the concern passed into the hands of the John Cockerill Society. It now employs some 12,000 workpeople in hundreds of machine-shops, furnace-yards, forges, boiler-works, coal-mines, and other branches. In this establishment were made the first locomotive used on the Continent (1835), the machinery for boring the Mont Cenis tunnel, and the great lion on the field of Waterloo. Pop. (1827) 2000; (1881) 28,385; (1890) 33,912.

Serampur, a town of India, built in the European style, and extending a mile along the right bank of the Hooghly, 13 miles by rail N. of Calcutta. Paper and mats are manufactured. It was at one time a Danish settlement, but was transferred by purchase to the British in 1845. It is celebrated for the labours of the Baptist missionaries Carey, Marshman, and Ward. Pop. 35,959.

Serang. See CERAM.

Sereno, MATHIÈRE, an Italian novelist, was born at Patras in Greece, on 7th March 1856, the

daughter of an Italian political refugee and a Greek lady. She was brought up partly in Greece, partly in Italy, and began her literary career in 1878 by writing tales and sketches for various journals. Her fame was established in 1881 and 1883 by two ambitious romances, which, whilst giving evidence of her study of French models of the realistic school, revealed also her own high talents of observation and description. Her best books are those dealing with various phases of Neapolitan life, as *Cuore Inferno* (1881), *Fantasia* (1883; Eng. trans. 1891), *Le Leggende Napoletane*, *Riccardo Joanna* (1886), and *All' Erta Sentinella* (1889, a collection of stories). Her *Piccole Anime* is a charming book about children, written for grown-up people who love the little ones. She has also written sympathetically of young girls and young women in the collection of stories entitled *Il Romanzo della Fanciulla*, and in *Telegraf dello Stato* and other books. In 1887 she undertook the editorship of the influential and widely-read journal *Il Corriere di Napoli*.

Seraphim, celestial beings on either side of the throne of Jehovah, seen in prophetic vision by Isaiah, and by him alone (vi. 2-6). They have each six wings, two of which cover their faces in awe of the divine glory, and two cover their feet—an oriental sign of reverence—as the cherubim do their bodies (Ezek. i. 2), while the two remaining outspread wings support them. They hover above on both sides of the throne like two semicircular choirs, worshipping Him that sits on the throne in an uninterrupted antiphonal song. The tradition of the church, which took its rise from Dionysius the Areopagite, represents them as at the head of the nine choirs of angels, the first rank being formed by the seraphim, cherubim, and throni. The cherubim of Ezekiel are three-fourths in animal form, and the writer of the Apocalypse gives animal forms to three of the four *ζῶα* ('beasts'; R.V., 'living creatures'), which are six-winged like the seraphim of Isaiah (Rev. iv. 7, 8); the seraphim thus appear, apart from what was human-shaped in them, necessarily to be represented as winged dragons; for the serpent lifted up by Moses is called *Saraph* (Num. xxi. 8), as is the flying dragon in xiv. 29. The name thus involves the idea of burning, and it is worth noting at least that Driver and Riehm see in the *cherub* of the original extra-Israelite representation the personified thunder-cloud, and in the *seraph* the personified serpent-like lightning.

Seraphine, a keyed musical instrument in which the sounds were produced by the action of wind on free vibratory reeds. It was the precursor of the Harmonium (q.v.).

Serapis, or SARAPIS (also found as *Osorapis*), the Greek name of an Egyptian deity, introduced into Egypt in the time of Ptolemy I. or Soter, and really a combination of the Greek Hades and Egyptian Osiris. He was not an Egyptian, but the Greek deity, with some Egyptian characters super-added; and his temple was not admitted into the precincts of Egyptian cities, finding favour only in the Greek cities founded in Egypt. It is said that forty-two temples were erected under the Ptolemies and Romans to this god in Egypt. His resemblance to Osiris consisted in his chthonic or infernal character, as judge of the dead and ruler of Hades. The god had a magnificent temple (the *Serapeum*) at Alexandria, to which was attached the celebrated Library; another at Memphis, in the vicinity of the cemetery of the mummies of the Apis, which was excavated by Mariette in 1850; and another temple at Canopus. It appears that he represented or was identified with the Hesiri Api, or Osorapis, the 'Ostrified' or 'dead Apis,' who was also invested

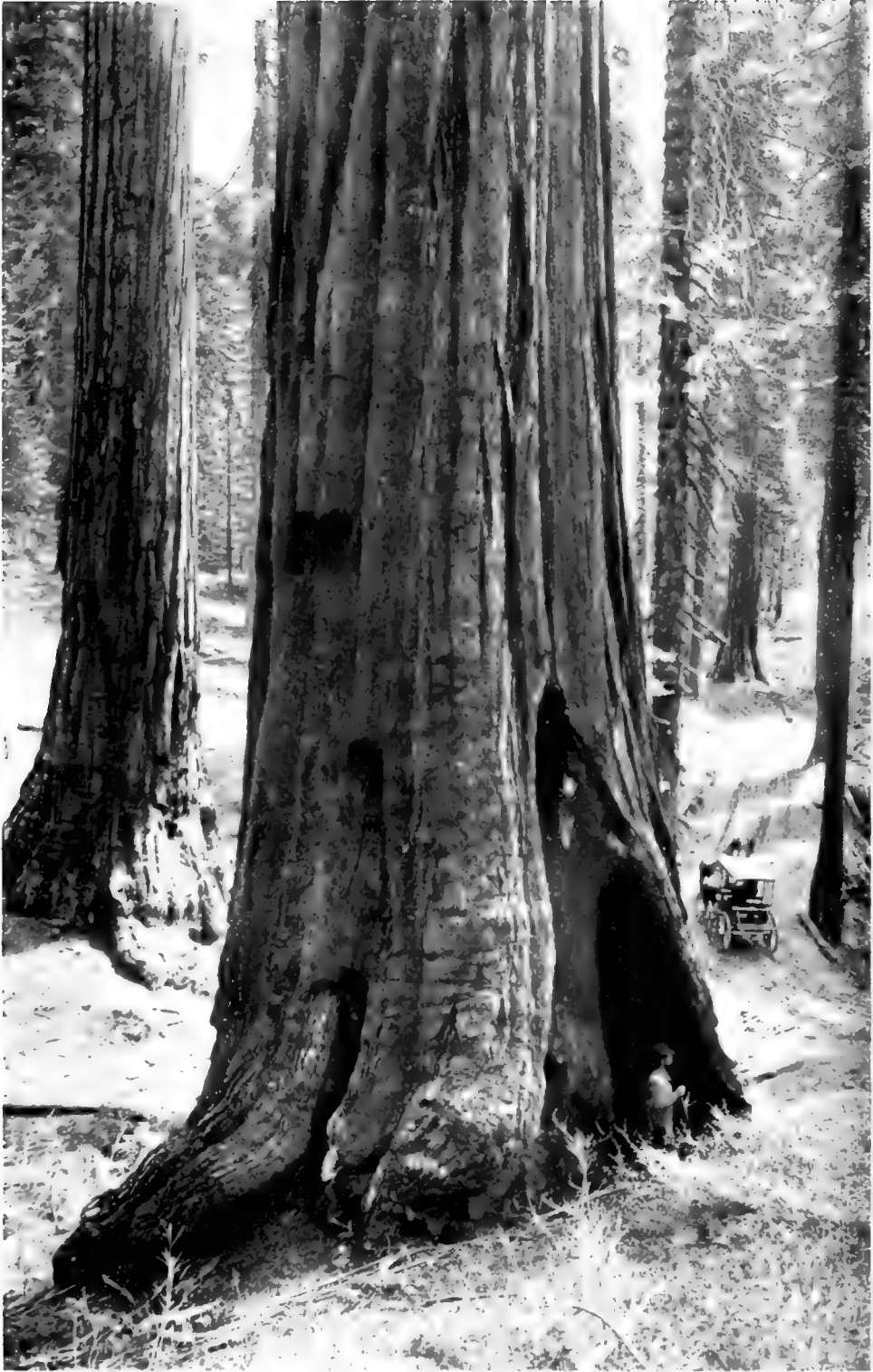

SEQUOIA GIGANTEA. BIG TREES, MARIPOSA GROVE, CALIFORNIA.

with many of the attributes of Osiris. The worship of Serapis, introduced into Egypt by the Ptolemies, subsequently became greatly extended in Asia Minor; and his image, in alliance with that of Isis and other deities, appears on many of the coins of the imperial days of Rome. In 146 A.D. the worship of the god was introduced into the city of Rome by Antoninus Pius; but it was not long after abolished by the senate, on account of its licentious character. A celebrated temple of Serapis also existed at Puteoli (see POZZUOLI), near Naples, and the remains of it are still seen. In Egypt itself the worship of the deity subsisted till the fall of paganism, the image at Alexandria continuing to be worshipped till destroyed, 398 A.D., by Theophilus, archbishop of that city. Busts of Serapis are found in most museums, and his head or figure engraved on certain stones was supposed to possess particular mystic virtues.

Seraskier, the name given by the Turks to the commander-in-chief of the army or to the minister of war.

Serbs. See SERBIA.

Serenade (Ital. *serenata*), originally music performed in a calm night; hence an entertainment of music given by a lover to his mistress under her window—especially in Spain and Italy.—A piece of music characterised by the soft repose which is supposed to be in harmony with the stillness of night is sometimes called a serenade, more usually a Nocturne (see MUSIC, Vol. VII. p. 358).

Sereth, an affluent of the Danube, rises in the south of the Austrian crown-land of Galicia, runs southward through almost the whole length of Moldavia, and joins the Danube just above Galatz, after a course of nearly 300 miles.

Serf (Lat. *servus*, 'a slave'), the term usually given to the villeins of mediæval Europe, and to the unfree peasants of Russia. The *serf* was distinguished in a general way from the *slave* by being attached to the land and having certain definite rights, whereas the *slave* was the absolute chattel of his master. But serfdom falls to be treated as part of the subject of Slavery (q.v.).

Serge, a kind of twilled worsted cloth which has a wide range of quality, strength, and thickness. The surface of the fabric is not smooth like that of a milled woollen cloth. Serges are generally dyed a dark blue or black, and good qualities are very durable. Clothes made of serge have been much worn both by men and women of late years.

Sergeants, or SERJEANTS (through the Fr., from Lat. *serviens*, 'serving'), are non-commissioned officers of the army and marines in the grade next above corporal. They overlook the soldiers in barracks, and assist the officers in all ways in the field. They also command small bodies of men as guards, escorts, &c. The daily pay of a sergeant varies from 2s. 4d. in the infantry to 3s. 4d. in the horse artillery (see also NON-COMMISSIONED OFFICERS). There are three sergeants and one colour-sergeant in each company of infantry. Each troop of line cavalry has also three sergeants and one troop sergeant-major. In the Household Cavalry the corresponding non-commissioned officers are called corporals of horse (four per troop) and troop corporal-major. In the Royal Horse Artillery there are six sergeants per battery and one battery sergeant-major, whose pay is 4s. 4d. per day. A regimental sergeant-major is a warrant officer on the staff of a battalion of infantry, regiment of cavalry, or corresponding body of troops. The daily rate of pay varies from 6s. in the horse artillery to 5s. in the infantry. Unlike the sergeants, the sergeant-major does not

command any particular portion of the corps, but generally superintends the whole of it, and in respect of discipline, &c. is the assistant of the adjutant. There is a separate article on COLOUR-SERGEANT. For the Quartermaster-sergeant, see QUARTERMASTER; for Sergeant-drummer and Sergeant-trumpeter, see BAND.—In ancient times the rank of sergeant was considerably more exalted. In the 12th century the sergeants were gentlemen of less than knightly rank, serving on horseback. Later the sergeants-at-arms were the royal body-guard of gentlemen armed *cap-à-pie*.

Sergeanty. See GRAND SERGEANTY.

Sergipe, a maritime state of Brazil, the smallest in the republic, but the second in density of population (31 per square mile), is bounded on the N. by the São Francisco, which separates it from Alagoas, and on the W. and S. by Bahia. Area, 7370 sq. m.; pop. (1890) 461,307. The shores are low and sandy, the interior mountainous. The east part is fertile, well wooded, and produces sugar and cotton; the western plateaus are devoted principally to the rearing of cattle. The capital is Aracajú, with a small port and 5000 inhabitants.

Sericite. See MICA.

Series, in Algebra, is the sum of a set of terms formed according to some definite law. For example, let n be any integer, and $\phi(n)$ a definite function of n . Then, by giving n the successive values 1, 2, 3, &c., and forming the corresponding functions $\phi(1)$, $\phi(2)$, &c., we are able to construct the series $S = \phi(1) + \phi(2) + \dots + \phi(m)$, where m is the highest value of n that is to be involved. If $\phi(n)$ is simply a multiple of n , we get an Arithmetical Progression (q.v.), viz. $a + 2a + 3a + \dots$. Again, if $\phi(n)$ is of the form a^n , we get a Geometrical Progression (q.v.), viz. $a + a^2 + a^3 + \dots$. These simplest cases of series are considered under their special headings, and shall not be again referred to except by way of illustration.

It is evident that if a finite number of terms be taken, and if no term has an infinite value, the series itself will have a finite and determinate value. We may suppose, however, that no limit is to be assigned to the number of terms that are to be taken—in other words, that the highest value (m) of n is to be larger than any assignable quantity. We thus get a series with an infinite number of terms. But it does not follow that such an Infinite Series, as it is called, has necessarily an infinite value. Consider, for example, the Geometrical Series $1 + \frac{1}{2} + \frac{1}{4} + \frac{1}{8} + \frac{1}{16} + \dots$ to infinity. Draw a line ABC equal in length to two



units. AB (= 1) will represent the first term of the series; the second term may be represented by BD, the half of BC; the third by DE, the half of DC; and so on indefinitely. It is evident that, however far we may go, we shall always fall short of C by an amount equal to the last bit added on. Thus

$$1 + \frac{1}{2} + \frac{1}{4} + \dots + \frac{1}{2^n} = 2 - \frac{1}{2^n}$$

But by taking n large enough we may make $1/2^n$ as small as we please. Hence the value of the Infinite Series is 2.

It will be seen that the terms in this series approach zero indefinitely, while the sum approaches a definite limit. Any series in which the latter condition is satisfied is called a Convergent Series. In all convergent series the former condition just stated must also be satisfied. But it does not follow that a series whose successive terms approach zero indefinitely is necessarily convergent. For example, the series $1 + \frac{1}{2} + \frac{1}{3} + \frac{1}{4} + \dots$

$\frac{1}{2} + \dots$ to infinity has not a finite value, is not convergent, although its infinite term is zero. Such a series is divergent, and cannot be summed to infinity. To prove this throw the series into groups of terms, the first group being the first term, the second the next *two*, the third the next *four*, the fourth the next *eight*, and so on. Thus the fifth group will consist of sixteen terms, beginning with $\frac{1}{16}$ and ending with $\frac{1}{32}$. Each of these fractions is greater than $\frac{1}{32}$ or $\frac{1}{2^5}$; so that their sum is greater than sixteen times this quantity or $2^4/2^5$ or $\frac{1}{2}$. Hence, if we go as far as m groups, the series will be greater than $1 + \frac{1}{2^m}$. Thus by taking m large enough we can make the sum as large as we please. The series is divergent and cannot be summed. We may, however, by simply changing the algebraic sign of every alternate term, obtain a series which is convergent—viz. $1 - \frac{1}{2} + \frac{1}{4} - \frac{1}{8} + \dots$ to infinity. That this series has a finite sum may be made evident graphically thus: Take AB equal to unity; this is the first



term. Move back half-way to C; this gives the second term *minus* one-half. Move forward to D, where CD is one-third; then back to E, where DE is one-fourth; and so on indefinitely. It is clear that we shall ultimately oscillate through diminishing ranges about some point between C and B; so that the sum of this series is less than 1 but greater than $\frac{1}{2}$. The series, in fact, is the Napierian logarithm of 2, and has the value .69315... A series like that just given, which is convergent only when the signs of the successive terms differ according to some definite rule, is usually called *semi-convergent*. A series which converges when all its terms have the same sign is said to be *absolutely convergent*. Sir G. B. Stokes long ago distinguished them as *accidentally* and *essentially* convergent, a terminology which seems in many respects superior to that in common use.

It is important to have a test of convergency; and the most useful test is to take the ratio of two consecutive terms, and consider what value this ratio approaches as we take the terms higher and higher. This ratio is called the ratio of convergency; if it is ultimately less than unity the series is convergent; if greater than unity, divergent. This test, however, gives no information when the ratio is ultimately unity. As an example, consider the exponential series:

$$1 + x + \frac{x^2}{1.2} + \frac{x^3}{1.2.3} + \frac{x^4}{1.2.3.4} + \&c.$$

Here the ratio of the $(n+1)$ to the n th term is $x/(n+1)$, which is ultimately zero, since whatever value x may have n can be taken as large as we please, so that the ratio may be made smaller than any assignable quantity. As is well known, the value of this series is e^x , where e has the value 2.71828... (see LOGARITHMS). Convergent series are of indispensable service in the calculation of logarithms and trigonometrical functions and in many important physical applications. Not a few of their properties were consequently known to the earlier analysts; but it is to Cauchy (1827) that we owe the foundation and partial development of the modern theory of convergence. Dirichlet, Abel, Gauss, De Morgan, Bertrand, Kummer, Du Bois-Reymond, and others have ably supplemented Cauchy's work. A very complete introduction to the whole subject is given in Chrystal's *Algebra* (vol. II.). There also will be found a discussion of certain parts of the subject which we can only name, such as oscillating series, double series, infinite products, reversion of series, and the like.

See CIRCLE and TRIGONOMETRY for some particular cases of series.

Seringagar. See SRINAGAR.

Seringapatam (properly *Sri Ranga Patanam* = 'City of Vishnu'), the capital of Mysore state in Southern India from 1610 to 1799, is built on an island in the Kaveri, 10 miles N.E. of the city of Mysore. The island is three miles long and one broad; at its western end stands the fort, surrounded by strong walls of stone, and enclosing the palace of Tippoo Saib and the principal mosque. Outside it are the garden in which was built the mausoleum of Tippoo and his father, Hyder Ali, and Tippoo's summer palace. The fort was besieged by Lord Cornwallis in 1791, and again in 1792. On the last occasion the terms dictated by the British to Tippoo were very severe. A British army appeared before the walls again in 1799, and on the 3d May of that year the fort was stormed and Tippoo slain in the vicinity of his own palace. Pop. 150,000 in Tippoo's day; 32,000 in 1800; and now 10,000, most of whom live at the suburb of Ganjam, the ancient city being now in a very ruinous condition.

Seringham (*Srirangam*), a town in the Madras Presidency, on an island in the Kaveri, 11 miles W. of Trichinopoly, with a pop. of 21,632. The place is noted for its great temple of Vishnu, a vast complex of halls and gopuras (colossal gateways) built on no very regular plan, but enclosing so large an area that most of the houses of the town are within the temple walls. Notable is one 'hall of a 1000 columns' (960 really), 450 feet long by 130 wide.

Serjeant-at-Arms, in the English Court of Chancery, is the officer who attends upon the Lord Chancellor with the mace, and who executes by himself or deputies various writs of process directed to him in the course of a Chancery suit, such as apprehending parties who are pronounced to be in contempt of the court. A similar officer attends on each House of Parliament, and arrests any person ordered by the House to be arrested.

Serjeant-at-Law used to be the highest degree of barrister in the common law of England. The degree is of great antiquity, and formerly a barrister could only be appointed after being of sixteen years' standing. Formerly, also, they had exclusive audience in the Court of Common Pleas. The proper forensic dress of serjeants was a violet-coloured robe with a scarlet hood, and a black coif, represented in modern times by a patch of silk at the top of the wig. A serjeant was appointed by a writ or patent of the crown. The Chief-justice of the Common Pleas recommended the barrister to the Lord Chancellor, who advised the crown. The degree of serjeant was entirely honorary, and merely gave precedence over barristers; and when he was appointed he was rung out of the Inn of Court to which he belonged, and thereafter joined the brotherhood of Serjeants, who formed a separate community. By ancient custom the common-law judges were always admitted to the order of serjeants before sitting as judges, but this practice was abolished in 1874. The society of Serjeants Inn was dissolved not long after, and the order is now extinct; a few surviving serjeants retain the title. See the article COIF; Pulling's *Order of the Coif* (1884); and Worbyde's *Eminent Serjeants-at-Law* (1869).

Sermons. See PREACHING.

Serous Fluids, various fluids occurring in the animal body, are arranged by Gorup-Besanez under three heads: (1) Those which are contained in the serous sacs of the body, as the cerebro-spinal fluid, the pericardial fluid, the peritoneal fluid, the pleural fluid, the fluid of the

tunica vaginalis testis, and the synovial fluid; (2) the tears and the fluids existing in the eyeball, the amniotic fluid, and transudations into the tissue of organs; (3) morbid or excessive transudations, such as dropsical fluids, the fluids occurring in hydatids, and in blebs and vesicles on the skin, and transudations from the blood in the intestinal capillaries, as in cases of intestinal catarrh, cholera, or dysentery. All these fluids bear a close resemblance to one another, both in their physical and chemical characters. In so far as relates to their physical characters they are usually clear and transparent, colourless or slightly yellow, of a slight saline, mawkish taste, and exhibiting an alkaline reaction with test-paper. They possess no special formal or histological elements, but on a microscopic examination blood-corpuscles, cells of various kinds, molecular granules, and epithelium may occasionally be observed in them. The ordinary chemical constituents of these fluids are water, fibrin (occasionally), albumen, the fats, animal soaps, cholesterol, extractive matters, urea (occasionally), the same inorganic salts which are found in the serum of the blood, and the same gases as occur in the blood.

Serous Membranes. There are six of these membranes in the human body, two being median and single, while two are double and lateral. They are the pericardium and the peritoneum, with the two pleuræ and tunicae vaginales testis. They are all closed sacs, with one exception; and each sac or continuous membrane consists of two portions—a parietal one, which lines the walls of the cavity, and a visceral or reflected one, which forms an almost complete coating or investment for the viscera contained in the cavity. The interior of the sac contains a small quantity of fluid, usually merely enough to moisten the contiguous surfaces and thereby enable them to glide easily upon each other. With regard to their structure, it is sufficient to state that they consist essentially of (1) endothelium; (2) basement membrane; (3) a stratum of areolar or cellular tissue, which constitutes the chief thickness of the membrane, and is the constituent on which its physical properties are mainly dependent. This layer is more liable to variation than the others, and one of the most common alterations is an augmentation of the yellow fibrous element, by which an increased elasticity is given to the membrane, which is thus better adapted for distention, and for a subsequent return to its original bulk. The situations in which this augmentation is found are, as Dr Brinton (*Cyclopædia of Anatomy and Physiology*, vol. iv. p. 524) has pointed out, in exact conformity with this view: in the peritoneum, which lines the anterior abdominal wall and covers the bladder, it attains its maximum; in the detached folds of the mesentery, in the costal pleuræ, and in the suspensory ligament of the liver it is still very prominent; while on the posterior wall of the belly, and in serous membranes covering the heart, liver, &c. it is almost absent. For some of the principal serous membranes, see the articles PERICARDIUM, PERITONEUM, PLEURISY, and RESPIRATION (Vol. VIII. p. 660).—Synovial membranes (q.v.) present many points of similarity to serous membranes.

Serpent, a bass musical wind-instrument entirely obsolete except in a few continental churches. It is said to have been invented by a French priest at Auxerre in 1590. It consists of a tapered tube 8 feet long, built of wood and covered with leather, and twisted about like a serpent, whence the name. It is sounded through a cupped mouthpiece like that of the bass Trombone (q.v.). It had originally six holes for three fingers of each hand, but in its later years had keys added. The

form of its bore and the material of which it is made give it a tender and soft tone which is very effective in certain kinds of music, but its difficulties and the uncertainty of its intonation have led to its disuse.

Serpentine, a mineral composed of silica and magnesia in almost equal proportions, with about 13–15 per cent. of water, and a little protoxide of iron. Serpentine occurs generally massive; never in crystals, save as pseudomorphs; colour some shade of green, also red and brownish yellow; has a smooth but sometimes greasy feel; is soft enough to be scratched with calcite. Precious Serpentine, or Noble Serpentine, is of a rich, dark-green colour, hard enough to receive a good polish, translucent, and sometimes contains imbedded garnets, which form red spots, and add much to its beauty. It is a rare mineral. It occurs at Baireuth in Germany, in Corsica, at Portsoy in Banffshire, in the Shetland Islands, &c. It is generally found along with foliated limestone associated with schistose rocks. The ancient Romans used it for pillars and for many ornamental purposes; and vases, boxes, &c. are still made of it, and much prized. The ancients ascribed to it imaginary medicinal virtues. *Marmolite* is a scaly, foliated serpentine; *Chrysotile* is a delicately fibrous variety, with a silky lustre, often met with as veins in ordinary serpentine. *Common Serpentine* is a rock rather than a mineral. It often occurs in winding irregular veins; hence the name serpentine. It is generally green or red, the colour being sometimes uniform, at other times mottled, spotted, streaked, veined, or clouded. It occurs not only in veins, but forming irregular sheets and masses, and is usually associated with crystalline schists and granitoid eruptive rocks. The mineral serpentine is always a product of the chemical alteration of other minerals; and there is reason to believe that most of the masses of serpentine are highly altered igneous rocks which were rich in olivine or peridotite. Many peridotites are proved to have been altered into serpentine. Concerning the origin of some of the serpentines associated with the crystalline schists there is still much uncertainty.



Serpent.

Serpents (Lat. *serpere*, 'to creep'), the more formal and old-fashioned term for all members of the genus Ophidia, more popularly known as Snakes (q.v.), under which heading the general characters and classification of the Ophidians are treated, as also snake-charming.

SERPENT-WORSHIP is one of the most ancient and wide-spread forms of primitive religion, and still exists amongst many savage peoples. The characteristic change of skin is easily associated with notions of resurrection and immortality; but it does not appear that the familiar notion of the serpent as a personification of evil is anything like universally spread, although we do find it early in the Apophis-serpent of the Egyptian Hades, represented on mummy-cases, as well as in the wicked Aji Dahaka of the Zoroastrians, which bears so close a relation to the subtle Serpent of Eden. The worship of Moses' brazen serpent in the days of Hezekiah (2 Kings, xviii. 4) shows that the idea was familiar to the Semitic mind. Serpent-worship appears prominently in early Indian Buddhism; we see traces of it in the great serpent which defended the citadel of Athens, fed

every month with honey-cakes; in the Roman *genius loci*, which was usually supposed to assume this form; and in the kindly offices between men and snakes so common in European folk-tales. Among the Zulus certain harmless green or brown snakes which come fearlessly into the houses are thought to be *amatongo* or ancestors, and may often be identified by some scar or mark such as the man bore in life. Serpents are by many peoples regarded as common incarnations of deities, whether ancestral or other, such as the rattlesnake worshipped in the Natchez temple of the Sun; the serpent-symbol of the healing deity *Æsculapius*, in whose temple huge tame snakes were kept; the Phœnician serpent with its tail in its mouth, perhaps originally a mere mythic world-snake like the Scandinavian Midgard-worm, but in later ages adopted as an emblem of eternity. Nothing in the history of serpent-worship is more remarkable than its Christian revival, or rather survival, among the mystic vagaries of Gnosticism—the Ophites trained their tame snakes to coil themselves round the eucharistic bread. Snake-worship again comes into close touch with the doctrine of Totemism, and we see how the Sanskrit *nāga* ('serpent') has given the name to a race of snake-worshippers who claim descent from ancestral snakes. On no people has the mystery of the serpent (Prov. xxx. 19) weighed more than upon the Red Indians. It has given its name to rivers, like the Kennebec (Algonkin) and the Antietam (Iroquois); among the Dakotas, Shawnees, and Sacs the words for *spirit* and *snake* are similar; the Algonquins think the lightning an immense serpent, and the Caribs speak of the god of the thunderstorm as a mighty serpent. The Ojibways dread to kill a rattlesnake, and if they find one in their path they beseech it to go away and spare them and their families; the same worship was found among the Cherokees and many other tribes, as well as in the strange snake-dances practised among the Zuñis. In Mexico many sculptured images of serpents are found, almost vying in size and splendour with those found in India. The Vandoux of Hayti (q.v.) is a special case of serpent-worship.

See Ferguson's *Tree and Serpent Worship* (1868); Gubernatis, *Zoological Mythology* (1874) for its facts; E. B. Tylor's *Primitive Culture* (1871); also ANIMAL-WORSHIP, BEAST-FABLES, OPHITES, TOTEM, &c.

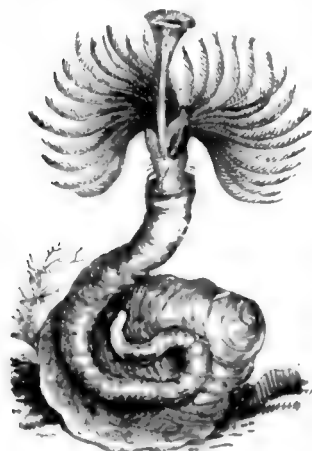

Serpula contortuplicata (with expanded gills), on the back of an Oyster-shell.

calcareous tubes fastened to shells and rocks in the sea, or even to other animals, such as crabs.

Serpukoff, an ancient Russian town, 57 miles by rail S. of Moscow, on the Nara, 3 miles from its confluence with the Oka. It contains a cathedral (1380), and is a place of considerable commercial and industrial importance, manufacturing chiefly cottons, woollens, leather, paper, furniture, and earthenware. Pop. 24,000. It was formerly a fortress protecting Moscow on the south.

Serpula, a genus of sedentary Chaetopod worms, living in twisted

From the mouth of the tube the head of the worm is stretched out into the water, and bears numerous exquisitely coloured gills and a stopper or operculum which closes the mouth of the shell when the head is retracted, and seems also to help in respiration. The colour of the gills is in great part due to the blood which is seen through the thin skin. The food consists of minute organic, and especially vegetable, particles, which are wafted into the mouth by the cilia on the gills. The process by which the worm makes its tube of lime is not clearly understood; it is interesting to observe that in situations where the light comes in one definite direction the calcareous tubes point that way. Several species of *Serpula* are common on British coasts, and large forms of this genus and of nearly related genera are common in warmer seas.

Serrano y Dominguez, FRANCISCO, DUKE DE LA TORRE, a Spanish statesman, was born at Anjonilla in Andalusia on 18th September 1810, and pushed himself to the front in the war against the Carlists. Having gained an intimate place in the favour of the dissolute Queen Isabella, he made the most of his influence and played an active part in the dismal political changes of that sovereign's reign, sometimes being in arms against the ministers of the day and sometimes himself holding the highest administrative posts of the kingdom. He was by profession a liberal, and for some years (1854-66) lent faithful support to O'Donnell. On the overthrow of O'Donnell's government by Narvaez Serrano was banished, but returning two years later (in 1868) he defeated the queen's troops, and, having driven her away into France, became the chief ruler (as regent) of Spain until the accession of Amadeus of Savoy (1870). He waged successful war against the Carlists both in 1872 and in 1874. During the greater part of this latter year he was again at the head of the government, until he resigned the power into the hands of Alfonso XII. He was ambassador at Paris in 1883-84, and died at Madrid on 26th November 1885.

Serres, OLIVIA. See OLIVE (PRINCESS).

Sertorius, QUINTUS, one of the ablest Roman commanders in the later ages of the Republic, was a native of Nursia, in the country of the Sabines. He began his military career in Gaul, and fought (105 B.C.) in the disastrous battle on the Rhone in which the Roman proconsul, Q. Servilius Cæpio, was defeated by the Cimbri and Teutones, and took part in the splendid victory at Aquæ Sextiæ or Aix (102 B.C.), where Marius annihilated the same barbarians. On the breaking out of the sanguinary struggle between the party of the nobles under Sulla and the popular party headed by Marius (88 B.C.), he espoused the cause of the latter, though he could not respect Marius himself. For morally Sertorius was much superior to the military adventurers of his time; and the impression we have of him from Plutarch's picturesque biography is that of a valiant, resolute, honest, and stubborn Roman, such as was commoner in the 3d than in the 7th century of the Republic. None of the Marian generals held out so long or so successfully as he against the victorious oligarchy. He fought in conjunction with Cinna the battle at the Colline Gate, which placed Rome at the mercy of the Marians. But he took no active part in the bloody massacres that followed; on the contrary, he slew 4000 of Marius' cut-throat slaves who had committed the worst excesses. On the return of Sulla from the east (83 B.C.) Sertorius, finding it impossible to act in concert with the other military leaders of his party, went to Spain, where he continued the struggle in an independent fashion. At first he was unable to maintain his ground, and was obliged to put to

sea. In the Mediterranean and in Morocco he led an adventurous life, sometimes fighting against the partisans of Sulla, sometimes mixing in the quarrels of native chiefs. But his fame grew, and at length he was invited back to Spain by the Lusitani; and from them and Roman refugees he formed troops who successfully defied the power of Rome for eight years or more. Sulla sent army after army against him commanded by such men as L. Domitius Ahenobarbus, Q. Metellus Pius, and young Pompey; but none of them was a match for him and his methods of guerilla warfare. The contest was at last terminated by the assassination of Sertorius in 72 B.C. The assassins were all Romans, men proscribed by Sulla, who were fighting under Sertorius. The chief of them was Perperna, who was jealous of his chief, and cherished ambitions of his own. Sertorius seems to have aimed at establishing a strong, stable government in Spain: he created a senate of 300 members from amongst the Romans of his party, and founded a school at Osca (Huesca) for the education of the sons of the Spanish chiefs.

But jealousies broke out between the Spaniards and the Romans, and the sternness of Sertorius changed to cruelty and tyranny. But when at the height of his power he was regarded with almost superstitious veneration by the Lusitanians, and the feeling was enhanced by the fact that the great commander was constantly followed about by a tame fawn.

Sertularia, a common genus of Hydroids, in which the branched horny investment of the plant-like colony forms a sessile cup around each polyp. The polyps are arranged in a double row, and the colony is attached to stones, shells, seaweeds, and the like. Among the hydrothece or cups surrounding the polyps or nutritive zooid larger pear-shaped capsules or gonothecæ occur, within which the reproductive elements are formed from special generative zooids. Unlike many Campanularians and Tubularians, the Sertularian hydroids never liberate medusoid reproductive individuals or zooids. See HYDROZOA, and Hinck's *British Hydroid Zoophytes* (2 vols. Lond. 1868).

A Sertularian Colony
(natural size).

rounding the polyps or nutritive zooid larger pear-shaped capsules or gonothecæ occur, within which the reproductive elements are formed from special generative zooids. Unlike many Campanularians and Tubularians, the Sertularian hydroids never liberate medusoid reproductive individuals or zooids. See HYDROZOA, and Hinck's *British Hydroid Zoophytes* (2 vols. Lond. 1868).

Serum. See BLOOD.

Serval (*Felis Serval*), one of the smaller Felidæ,



Serval (*Felis Serval*).

a native of South Africa, the *Boschkatte*, or Bush-cat, of the Cape Colony. It is about two feet in

length, exclusive of the tail. The serval is a beautiful animal, yellowish with black spots, the lower parts white with black spots. The fur of the serval is in great request, and is known to furriers as that of the *Tiger Cat*.

Servant. See MASTER AND SERVANT.

Servetus, MICHAEL, or MIGUEL SERVETO, a theologian and physician, was born at Tudela in Navarre in 1511, though he stated that he was born at Villanova near Lerida, and from about 1535 always styled himself Michael Villanovanus. His father sent him to study law at Saragossa and at Toulouse. His interest in theological discussions was awakened whilst he was yet a student, and having gone to Italy (1530) in the company of Quinaña, confessor to Charles V., he passed on from there into Germany, and came into contact with Luther, Ecolampadius, Bucer, and others of the Reformers. But his own views, especially in respect of the Trinity—he denied that there are three Persons in the Trinity and refused to acknowledge the eternity of the Son, and in other respects professed tenets similar to those of Socinius (q.v.)—were in discord both with those of the Reformers and the authoritative teaching of the Roman Catholic Church. The essay in which he propounded his speculations—*De Trinitatis Erroribus* (1531)—provoked considerable discussion. In 1536 he began to study medicine at Paris, and after a few years of wandering settled down to practise at Vienne (1541). Four or five years later he began to correspond with Calvin, and in spite of Calvin's openly avowed enmity wished to visit him at Geneva. At length, having secretly reprinted (1553) his collection of theological tracts, he was betrayed, and denounced, it is alleged at the instance of Calvin, to the inquisitor at Lyons. He was arrested, but managed to escape from prison; yet rashly venturing into Geneva he was again arrested, and after a trial of more than two months was burned alive (27th October 1553), the day after sentence was pronounced, at Champel near Geneva. As a scientific inquirer he is best known by a popular book on syrius and by his demonstration of the pulmonary circulation of the blood.

See CALVIN; Tollin, *Charakterbild Michel Servet's* (1876), *Das Lehrsystem M. Servet's* (3 vols. 1876-78), and other books; Trechsel, *Die Protestantischen Antitrinitarier vor F. Socin* (1839); Pünjer, *De M. Serveti Doctrina* (1876); and Willis, *Servetus and Calvin* (1877), which, however, must be used with very great caution.

Servia, a kingdom of the Balkan Peninsula, bounded N. by the Danube, separating it from Hungary, W. by the Drina, separating it from Bosnia, S. by Turkey, and E. by Bulgaria and Roumania, the Danube flowing between Servia and the last named. It is a compact territory, with an area of 18,754 sq. m., measuring 140 miles from east to west by 110 from north to south. The surface is on the whole mountainous. There are, however, few well-defined mountain-chains, except along the frontiers, where also the highest peaks occur—e.g. the Kapaonik Mountains (6382 feet) in the south-west; but there are a great number of isolated mountain peaks and mountain groups, clothed in many parts with fine forests (12 per cent. of the total area) of oak, beech, walnut, chestnut, and other trees, and parted by fertile valleys, which afford excellent pasturage to numerous herds of cattle and sheep. The districts next Bulgaria and Bosnia are more wild and difficult than the central parts, through which passes the principal highway of the country, the valley of the Morava, stretching south-south-east from the Danube. Servia is essentially an agricultural country. Of the total area 58½ per cent. is set apart for cultivation, the principal crops being wheat, maize, and other cereals, and

grapes for wine (annual production 2½ million gallons). Nearly 12 per cent. of the total is, however, uncultivated or lying waste. The extensive mountain pastures have been already mentioned. Fruit trees exist in very great abundance, especially plums (annual crop 25,000 tons), which are dried and exported to a value between £250,000 and £500,000 a year, and from which also the brandy of the Servians (*slovovitza*) is extensively made. Large herds of swine are fed on the acorns of the oak forests, and then driven into Hungary (mostly to Pesh) to be sold. Great numbers of cattle and sheep are kept, the former being exported to the value of nearly £250,000 annually. The remaining exports of consequence embrace wheat and other cereals (£150,000 to £430,000 annually), hides, wine, wool, timber, cordage, and sheep. The total exports for the six years ending 1890 averaged £1,589,000 annually. The imports consist principally of cottons, woollens, salt, timber, iron, steel, and other metals, hides, sugar, coffee, glass, paper, tobacco, machinery, &c., and range from £2,067,800 (1886) to £1,862,440 (1897). In addition to this there is a rapidly growing transit trade (£29,000 in 1887 and £633,760 in 1896). By far the greater portion of the foreign trade of Servia is in the hands of Austria-Hungary, and is concentrated at Belgrade, the capital of the country. But a little is done by Nisch, the chief town of southern Servia, by rail (since 1889) through Salonica (q.v.). The manufacturing industry is still in its infancy, though the government are trying to encourage it by the system of monopolies. There are, however, now in operation flour-mills, breweries, brick-works, cooperages, sawmills, and factories for making cloth, paper, tobacco, and gunpowder. Clothing and carpets are made by the women in their own homes. The country is naturally rich in minerals, though they are not extracted to anything like the extent they might be; nevertheless coal, lignite, quicksilver, lead, silver, antimony, copper, and oil shales are mined. Along the valley of the Morava passes part of the chief railway line connecting Vienna with Constantinople. This, together with three or four short branch-lines, gives to Servia a total of 334 miles of railway.

The Servians are a well-built, stalwart race, proud and martial by temperament, with a warm love of home and country, of dance and song, hospitable, brave, and energetic, but at the same time quick-tempered and prone to violence. They are a primitive people, cling to old customs and beliefs, and are thoroughly democratic in their institutions. The most striking feature of their social life is the family community or *Zadruga*. The farms are all small in size, and the agriculture is backward and primitive. There are no paupers, no asylums, no 'homes' in Servia. Pop. (1884) 1,901,736; (1898) 2,384,205, including some 150,000 Romanians, 34,000 Gypsies, and 25,000 of other nationalities. Besides these there are some 250,000 Servians (Serbs, Sorbs) in Montenegro, 1,300,000 in Herzegovina, and 2,350,000 in Austria-Hungary. The people of Servia belong to the Greek Catholic Church. The highest authority of the Servian church is the national synod, consisting of the Archbishop of Belgrade (metropolitan of Servia) and the bishops of Nisch and Zica. Education does not reach a very high standard, and is not generally diffused, although attendance at the primary schools is free and compulsory. Besides a university (at Belgrade) with less than 300 students, there are a military academy, a theological seminary, an agricultural, a commercial, and some technical schools. The elementary schools number over 900, and are attended (1893-94) by about 77,000 children.

Servia is a constitutional and hereditary mon-

archy. The king or the regency acts as the sole executive, through eight ministers (for Foreign Affairs, War, Finance, Justice, Interior, Political Economy, Public Works, Religion and Education), who are responsible to the nation. The legislative power is vested in the king and the National Assembly. This last, called the *Skupshchina*, consists of deputies elected by the people every third year, one for every 4500 voters in each province. Besides this body there is a senate of sixteen members, eight chosen by the king and eight by the National Assembly; this body acts as a permanent state council. On extraordinary occasions four members are returned by every constituency instead of one. The national income in 1898 was £2,752,980, the expenditure £2,752,902, and in the same year the public debt amounted to £16,381,500. The army, armed from 1892 with the Männlicher rifle, embraces all men capable of bearing arms between the ages of twenty and fifty, divided into three classes: the regular army with a total war strength of 160,000, the first reserve of 126,000, and the second reserve of 66,000. The French (metrical) system of weights and measures is in use, and the coinage system of the Latin union, though the 'franc' is called *dinar*, and is divided into 100 *paras*.

See Gopcević, *Serbien und die Serben* (1888); Loveleye, *The Balkan Peninsula* (Eng. trans. Lond. 1887); E. de Borchgrave, *Le Royaume de Serbie* (Brussels, 1883); Kanitz, *Serbien* (Leip. 1868); Denton, *Servia and the Servians* (Lond. 1862); and the consular reports on the trade of Servia.

HISTORY.—The Servians emigrated from the slopes of the Carpathians to the regions now called Servia, Bosnia, and Herzegovina in the year 638, and not long afterwards accepted Christianity in the form adopted by the Eastern or Byzantine Church. The rulers of the people during the following four hundred years were powerful feudal lords, of whom now one, now the other, exercised the chief authority. Sometimes they were in subjection, in whole or in part, to the Byzantine emperors; but all through they steadily strove for the preservation of their independence, and in the long run successfully withstood the power of Byzantium, as well as resisted the unceasing attacks of the Bulgarians. Like most Eastern Christians, the people cherished an unconquerable aversion to the Latin Church and its head, the pope; and from the last years of the 12th century the Servians elected their own archbishop. A chief, Stephen Nemanya by name, founded the Rascian dynasty in 1159, and under his successors Servia pushed her way into the front rank amongst the Balkan states. The greatest ruler of this dynasty was Stephen Dushan (1336-56), who after subjugating Bulgaria, Macedonia, Albania, and the greater part of the peninsula, conceived the ambitious design of welding Servia, Bulgaria, and Byzantium into an empire strong enough to resist the assaults of the Osmanli Turks. But he died before he could carry out his plans. Under his feeble son and successor the great nobles divided the power amongst them, and consequently weakened the country. This favoured the aggressive advance of the Turks, who routed the chief Vukashin on the Maritza in 1371, and Prince Lazar at Kossovo, on the celebrated 'Field of the Blackbirds,' in 1389. By this last fight, which figures very prominently in the national ballads, the independence of Servia was virtually lost: she was made tributary to the sultan, and gradually became a pashalik of the Ottoman empire, though hopes of freedom were revived for a time by the great successes of the Hungarian captain and ruler Hunyady and the Albanian chief Scanderbeg in the middle of the 15th century.

During the next three hundred years the Turkish rulers, supported by the ruthless janizaries, ground down the unhappy people, and subjected them to almost every kind of injustice and barbarity: many of the chief families were exterminated, 200,000 persons were carried off as slaves, and in 1691 several thousands left their country for good and settled in Hungary. The people who remained behind were little better than serfs, and every seven years their boys were taken from them to be brought up in the Moslem faith and forced into the corps of the janizaries. The victories of Prince Eugene brought about the peace of Poscharevatz (1718), by which Serbia was ceded to Austria; but Austria had to restore it to the sultan twenty-one years later. At length the exasperated people, goaded to desperation, rose in 1804 under the leadership of Kara George, a stalwart and determined, though morose, swine-owner, a rich man and a man of influence, who by 1807 effectually drove the tyrannical janizaries out of the country, and stormed and took possession of Belgrade and the other fortresses. The struggle before its conclusion had taken on the character of a racial and religious war, Christian Servians against Mohammedan Turk. In 1809 and 1810 the Turks made determined efforts to recover their hold upon the country, and did overrun the districts east of the Morava; but with the assistance of the Russians they were at length beaten off again. By the treaty of Bucharest, which Russia made with Turkey, it was decreed that the sultan's troops should regarrison the fortresses, but that the Servians should govern themselves in respect of all internal affairs. But the Turks refused to observe these terms, and in 1813 assailed Servia on both sides with such vigour that Kara George fled to Austria and the enemy recovered the country. Turkish oppression again provoked an uprising of the people in 1815; they chose as their leader Milosh Obrenovich, a herdsman, who in a single campaign expelled the enemy, except the garrisons in the fortresses. This man was henceforth the leading spirit in the struggle of the Servians for independence. In 1817 he caused his rival Kara George, who had returned, to be assassinated, and was himself proclaimed chief ruler of Servia. In 1829 the Ottoman government at last formally agreed to the provisions of the treaty of Bucharest, and in the following year recognised Milosh as hereditary prince of Servia. But his rule was arbitrary and despotic, and in 1839 he was compelled to abdicate in favour of his son Milan (died same year). Before he abdicated the Turkish minister of Foreign Affairs and the Russian ambassador at Constantinople had drawn up a constitution, curtailing the power of the prince and giving much authority to a senate of the nobles. Milan's brother and successor, Michael (1839-42), was driven out of the country by a rival faction, who elected Alexander, son of Kara George, as their prince. Alexander leaned to Turkey and to Austria rather than to Russia, whose czar regarded himself as the rightful 'Protector of Servia,' and by this policy and his incapacity he lost the sympathy of his people and provoked many enemies about him. In 1859 he was compelled to abdicate, his successor being the aged exile, Milosh Obrenovich.

On his death, less than two years later, the chief power passed to his son Michael, who had been expelled in 1842. Under his rule a new era began for harassed Servia; the animosities of faction were smoothed away, the supremacy of the law was successfully vindicated and maintained, the national spirit was encouraged and foreign interference minimised, the national militia was organised, armed, and trained, and the country began

to move forward along the path of progress and prosperity. In 1867 Michael procured the departure of the last Turkish garrisons from Servian soil, namely those of Belgrade, Shabatz, and Smederevo; all the others had been withdrawn in 1862. On 10th June 1868 Prince Michael was assassinated in the park of Topshidere near Belgrade, by partisans of the rival Kara George faction. He was succeeded by Milan IV., a grandson of Yephrem, brother of the heroic Milosh. The most notable events during the reign of Milan (1868-89) were the framing of a new constitution, which placed all real power in the hands of the prince and a freely elected national assembly of the people; a war against Turkey (1876), in which the Servians were routed, and only escaped punishment through the intervention of Russia; participation in the Russo-Turkish war of 1877-78, whereby Servia gained her complete independence, and in addition the districts of Nisch, Pirot, and Lescovatz; the proclamation of the prince as king Milan I. on 6th March 1882; war with Bulgaria (1885), in which the Servians were defeated by Prince Alexander (of Battenberg), ruler of Bulgaria, at Slivnitsa and at Pirot, and were again saved by foreign intervention, this time that of Austria-Hungary; the quarrel between King Milan and Queen Nathalie, a Russian, their divorce (1888), and King Milan's abdication (1889) in favour of his son Alexander (born 14th August 1876).

See Ranke, *History of Servia* (Eng. trans. Lond. 1853), and *Serbien und die Türkei im 19ten Jahrhundert* (Leip. 1879); E. L. Mijatovic, *History of Modern Servia* (Lond. 1872); René-Taillandier, *La Serbie au XIX^e Siècle* (1875); Kallay, *Geschichte der Serben* (Pesth, 1877); and compare É. de Laveleye, *Balkan Peninsula* (Eng. trans. Lond. 1887); Denton, *Servia and the Servians* (Lond. 1862), and W. Miller, *The Balkans* (1896).

LANGUAGE AND LITERATURE.—The language of the Servians belongs to the southern division of the Slav tongues, and has for its nearest congeners Bulgarian, Slovenian, and Russian. Although somewhat influenced by Turkish, it is the softest tongue of all in the southern division, has a complete grammar, and readily lends itself to poetic composition. The dialect spoken by the Croats is precisely the same as that spoken by the Servians; but whilst the latter use the Cyrillic (Russian) alphabet, the former employ the Latin. The people of Montenegro and Bosnia speak Servian.

The earliest productions in Servian date from the 12th century, and consist of monkish chronicles and letters; in the 13th and 14th centuries various lives of the saints and kings, and annals, were written by Stephen Nemanya, St Sava, Archbishop Daniel, and others. But perhaps the most interesting production of this period is the collection of laws (*Zakonik*) made in 1349, when Stephen Dushan was king. Then came the battle of Kosovo and the long period of Turkish oppression, and during all that time there was no Servian literature except annals. But the language was not wholly uncultivated. From the end of the 15th down to the end of the 17th century a vigorous school of writers in Servian, or Croato-Servian, flourished at Ragusa (q.v.) on the Adriatic. It was not, however, a purely national literature, but was strongly influenced by Italian culture. The literary productions of the Ragusa epoch were nearly all in verse, chiefly lyrics (modelled after the Italian love-poems), poetic dramas (sacred and profane), epics, and eulogies. The greatest writers were Gundalich (1588-1638), author of the epic *Osman*, which celebrates the war of 1621 between Poland and Turkey; Julius Palmotich (1606-57), a writer of dramas, songs, and epics, most of these last clever imitations of foreign models; Marulich (1450-1524 or 1528), author of the poetic *History*

of *St Judith*; Cubranovich (died 1550), author of a celebrated masque, *The Gipsy Girl*; Menečich-Vlahovich (1457-1501) and Drzich (died 1510), who both excelled in love-poems; Lucich (1480-1540), the 'father' of the Ragusan drama; Vetranich-Cavcich (1482-1576), who wrote several mystery-plays; Naljeskovich (1510-87), author of pastorals, comedies, and love-poems; Jorjich (1676-1737), who wrote (like some others of the above mentioned) in Latin, Italian, and Servian, in the last-named tongue chiefly didactic and religious poetry; and Kacich-Miosich (1690-1760), a very popular writer of songs with a good deal of the ring of the national poetry in them.

When the Servians began to awaken, towards the middle of the 18th century, to a renewal of their national life, their literature began to revive at the same time. The man who did most to bring about this revival was Vuk Karadžich (1787-1864): he made the first collection (in 1814-15) of the national songs of the Servians, the greatest literary treasure they possess, encouraged education, codified the laws, collected the fairy-tales and proverbs of his people, translated (1847) the New Testament into the Servian vulgar tongue, effected after a hard struggle a reform of the orthography, prepared a grammar and a dictionary of Servian, and in fact converted the vulgar tongue into a literary language. The best edition of Vuk's *Servian Folksongs* appeared in 6 vols. (1841-66). Several of these have been translated into English by Sir J. Bowring (*Servian Poetry*, 1827) and Lord Lytton (Owen Meredith, *Serbski Pesme*, 1861), neither of remarkable merit, and in another collection by Mrs Mijatovics (*Kosovo*, 1881); into German by Mrs Robinson or 'Talvj' (*Volklieder der Serben*, 1853); and into Swedish, very well done, by Runeberg (1833). These national songs are the product of different periods and of different, mostly unknown, authors. Their chief themes are the deeds of the national heroes and the occurrences of domestic life. The former class are written in a uniform metre of ten-syllabled trochaics, and are recited to the accompaniment of a simple one-stringed lute. The metre of the second class is varied; they are generally sung by a youth and a maiden. Vuk Karadžich was worthily seconded in his efforts to rekindle the intellectual life of his people in the spirit of patriotic love by Obradovich (1739-1811), who like his compatriot travelled much in south-east Europe, but unlike him was a learned man and a linguist; he spent the whole of his life labouring for the enlightenment of his people. One of the greatest names in modern Servian literature is Milutinovich (1791-1847), who wrote poems, an eulogy on Servia (*Serbianka*, 1826), a *History of Montenegro* (1835), a *History of Servia, 1813-15* (1837), and published a collection of national songs. Raich (1726-1801), who wrote a good *History of the Servian People* (1794-95); J. Popovich (1806-56), the author of lyrics and historical dramas; Lazarevich, who wrote one of the best of Servian dramas (*Vladimir and Kosara*, 1829); J. Subotich (1817-86), author of *Stephan Dechanski* (1846), which has caught the spirit of the national poems; Radichevich (1724-1853), who has been called 'the Servian Burns,' and Prince Peter II. (1813-51) of Montenegro, the two most celebrated lyrists of modern Servian literature; and the Croat Preradovich (1818-72), author of popular lyrics and epics, are the remaining writers of note. Towards the middle of the 19th century an attempt was made on the western side of the Balkan Peninsula to create a sort of revival of the Ragusan period. The centre of the new movement was Agram, and its leader Dr Ljudevit Gaj (1809-72). Its strongest feature was an aggressive sympathy with the Pan-Slavist agitation. The language in which the

writers of this school composed was the Croato-Servian dialect, but printed in Latin characters; it was, however, renamed Illyrian, chiefly for ethnological and political reasons. Besides Gaj the most important writers of this school were Vraz (1810-51), author of some beautiful lyrics; Vukotinovich, who wrote lyrics and historical tales; Bogovich, from whose pen came dramas, poems, and historical novels; Ivan Mazuranich, whose *Death of Ismail Agha*, the 'epic of hate,' is one of the most popular poems in Servian; and the poets Tomasich and Trnski. Kukuljevich-Sakeinski is the author of poems, dramas, stories, and very valuable historical records of the southern Slavs. Danichich (1825-82) was a first-rate philologist. Jagich and Novakovich have each written a good *History of Servian Literature*. The chief literary organ is the *Glasnik*, published at Belgrade since 1847. In 1880 the Agram Academy began a *Critical Servian Dictionary*.

See an article in the *Westminster Review* for April 1878; Pypin and Spasovich, *Geschichte der Slavischen Literaturen* (vol. i. 1880); A. Dozon, *L'Épopée Serbe* (Paris, 1888); and Mijatovics, *Servian Folklore* (Eng. trans. by Denton, 1874).

Service (*Pyrus domestica*, the *Sorbus domestica* of many botanists; see PYRUS), a tree of rarely more than 30 feet in height, with leaves and flowers like the Rowan Tree (q.v.), but the former downy beneath. It is by many held to be merely a variety of the rowan produced by cultivation—the chief distinction between the two is in the fruit, which in the service is much larger than in the rowan, and shaped like a small pear. The service has found a place in British floras solely on the strength, it appears, of a single tree having been found in the forest of Wyre near Bewdley, which in all probability had been planted where it stands. On the continent of Europe and in Russian Asia it appears in company with the rowan. It is more cultivated in Italy, Germany, and France than in Britain. The tree is of very slow growth and attains a great age. The timber is valuable, very heavy, fine-grained, and susceptible of a high polish, possessing a strength and durability which particularly adapt it for some purposes of the machine-maker. It is used also for making mathematical rulers, &c. The name Wild Service is given to an allied species, *Pyrus torminalis*, also called the Sorb, a common native of the middle and south of England and of the middle and south of Europe—a small tree with a spotted fruit considerably larger than that of the common hawthorn, which, like the fruit of the true service, becomes mellowed and pleasant by keeping, and is regularly brought to the market in many parts of Europe. Large quantities are brought to London from Hertfordshire. The dried fruit is used in some places as a cure for diarrhoea. The wood is highly valued. It is hard and tough, yellowish white, with brownish-red and dark-brown streaks.



Service Tree (*Pyrus domestica*),
branch in flower:
a, fruit, showing section.

Service, MUSICAL. The musical arrangements of a full cathedral service in the Church of England are usually as follows: The introductory prayers of morning and evening service, up to the conclusion of the Lord's Prayer, are sung in monotone. The versicles and responses before the Psalms, after the Creed and Lord's Prayer, and the Litany are sung to the plain-song adapted to them by Marbeck from the equivalents in the Catholic Directory, with some traditional variations; the responses are, however, usually sung in harmony, either in the festal form by Tallis, with the plain-song mostly in the tenor, or in the everyday or ferial form, in simpler harmony. The remaining prayers are sung in monotone, with plain-song inflections and endings. The *Venite* (Psalm xc.) and Psalms of the day are sung antiphonally to appropriate chants, of which many different collections are in use. Various collections of anthems are also found in different churches. The Canticles (*Te Deum*, &c.) are sung sometimes to chants, but usually to special settings by the various English writers from Tallis downwards; the term 'service' is used as denoting a complete set of music for these parts of the ritual, and is distinguished by the composer's name and the key. An ordinary Morning Service consists of settings of the *Te Deum* and *Jubilate*, or its alternative the *Benedictus*. The *Benedicite* is seldom sung. An Evening Service contains settings of the *Magnificat* and *Nunc Dimittis*, or more rarely of their alternatives the *Cantate Domino* and *Deus Misereatur*. A Communion Service includes choral settings of the *Kyrie Eleison* (the response after each of the Ten Commandments), the Nicene Creed, the *Sanctus* and the *Gloria in Excelsis*, and recent composers add the Doxologies before and after the Gospel, the *Sursum Corda*, the *Agnus Dei*, and the *Benedictus*. The style of music of a service (in the latter restricted meaning) varies very considerably with the different periods to which the composers belong. Among the most eminent of these are Thomas Tallis (c. 1515-85), Orlando Gibbons (1583-1625), John Blow (1648-1708), Henry Purcell (1658-95), William Croft (1677-1727), William Boyce (1710-79), Thomas Attwood (1765-1838), and Samuel Wesley (1766-1837). The style of the last has been largely followed by the innumerable modern writers, many of high excellence. See the collections of Boyce, Arnold, Rimbault, and Ouseley, containing also biographical notices. There are also what are known as Chant Services, the music of which is a free form of chant, of which the well-known 'Jackson in F' is a hackneyed example. See also Stainer's *Cathedral Prayer-book* (Novello).

Servile Wars. See ROME, Vol. VIII. p. 790, and SPARTACUS.

Servites, the common name for the order of the 'Religious Servants of the Holy Virgin,' founded in 1233 by seven Florentine merchants, who soon removed to Monte Senario, 9 miles from the city. They adopted the rule of St Augustine, with many modifications, receiving papal sanction in 1255; and in 1487 Innocent VIII. bestowed on them all the privileges of the other mendicant orders. Before the death of the founders there were 10,000 members of the order. In England there were no houses before the Reformation, but there is now one in London, with a branch at Bognor, and three convents of Servite nuns. The habit is black.

Servitude is a burden affecting land or other heritable subjects, by which the proprietor is either restrained from the full use of his property or is obliged to suffer another to do certain acts upon it, which, were it not for that burden, would be competent solely to the owner (Erskine, *Inst.* II. ix. 1).

The name is borrowed from the Roman law, and most of the rules regulating this class of rights in the countries of western Europe are derived more or less directly from the same source. In the Roman law, as now, servitudes are either predial or personal. Predial or real servitudes are those constituted over one subject or tenement in favour of the proprietor of another subject or tenement. It is only as owner of the property that a person enjoys the predial servitudes accessory thereto; and when the property is transferred the servitudes pass along with it. The tenement in respect of which the servitude is enjoyed is called the dominant tenement, and its owner the dominant owner; while the tenement in or over which the right is exercised is called the servient tenement. There is thus always a right on the one side and a corresponding obligation on the other. The term servitude in Scotland is used equally to express the right and the obligation; but the term Easement (q.v.), which is the nearest English equivalent, more generally expresses only the right. Personal servitudes, on the other hand, are those constituted over any subject in favour of a person in his own right, and not as owner of another subject. In Scotland the only rights that have been classed under this head are the different kinds of usufruct or liferent. Real or predial servitudes, which are really the only proper servitudes, were divided in Roman law into urban and rural—the former including all servitudes connected with buildings wherever situated, the latter all those relating to land uncovered by buildings, whether situated in town or country. Rural servitudes comprise rights of road or way, of driving cattle to water, of pasturage, of fuel, feal and divot, as well as several minor rights of bleaching or of taking away sea-ware, stone, slate, sand, or gravel from the ground of the servient subject. Urban servitudes comprehend such rights as eavesdrop or stillicide, support, and light, air or prospect. Both Scots and English law have taken from the Roman law another division, very useful in practice, of servitudes or easements into two principal classes, which are termed positive and negative. By a positive servitude the dominant owner is entitled to perform some act, affecting the servient tenement, which, but for the servitude, the servient owner could have prohibited; thus, all the rural servitudes above mentioned are positive. By a negative servitude the owner of the servient tenement is prohibited from the exercise of some natural right of property—as where he is prevented from building on his own land to the obstruction of light.

Positive servitudes are constituted by grant, recorded or unrecorded, where the consent of the party burdened is expressed in writing, holograph or tested; or by prescription—i.e. by acquiescence in the use of the servitude for forty years. A servitude acquired by prescription is, however, limited by the measure or degree of the use had by him who prescribes. Positive servitudes may also be constituted by implied grant; e.g. in the case of a severance of one property into two distinct properties, such servitudes as are necessary for the convenient and comfortable enjoyment of the respective properties are held to be granted by implication. Negative servitudes, on the other hand, can be constituted only by a formal written grant.

In all servitudes the benefit is confined entirely to the dominant tenement; but the owner of such tenement must exercise his rights *civiliter*, and in the way least burdensome to the servient tenement. The servient proprietor must do nothing to diminish the use or convenience of the servitude; and the dominant proprietor is entitled to access

for doing, at his own cost, any work which may be necessary for the proper use or preservation of the servitude. Servitudes are extinguished by express release or the renunciation of the right in a holograph or tested writing; by implied release, as the extinction of either the dominant or servient tenement; by the two tenements being merged into the property of one person; or by nonuser, prolonged for the prescriptive period, so as to imply abandonment. See EASEMENT.

Servius, a commentator on Virgil and one of the most intelligent of the Latin 'grammatici', lived at Rome about 400 A.D. But much of what is ordinarily cited as his work is by later hands.

Servius Tullius, the sixth king of Rome (q.v., Vol. VIII. p. 781, 787).

Sesame, an annual herbaceous plant of the genus *Sesamum*, natural order Bignoniaceæ, sub-order Pedaliaceæ, a sub-order characterised by wingless seeds, and placentæ with woody lobes attached to the inner wall of the fruit. The calyx of *Sesamum* is five-parted; the corolla irregular five-parted; the stamens four, two longer than the others, and a rudimentary fifth stamen; the capsule is oblong, almost four-celled, two-valved, many-seeded. The species most worthy of notice is *S. indicum*, sometimes identified with and sometimes distinguished from *S. orientale*, a native of India. Sesame is cultivated throughout the East from Egypt to Japan for the sake of the seeds, which yield by expression *gingili-oil*. The oil is used in cookery—as a substitute for butter in the same way as olive-oil—for lighting, and for the purposes of lubrication. It is inodorous, has a sweet taste, and keeps for years without becoming rancid. In Egypt and Arabia it is preferred to olive-oil. It is used in connection with medicine. Egyptian women consider it the best of cosmetics and the most perfect preservative of the hair. Nine pounds of the seeds yield two quarts of the sweet oil. The sweet oleaginous seeds are used in some countries, as in Central Africa, for making a kind of hasty-pudding. The oil-cake, mixed with honey and preserved citron, is an oriental luxury. The leaves of Sesame abound in a gummy substance, which they readily impart to water, making a rich bland mucilage, which is used in the southern parts of the United States (where it is grown a little) as a demulcent drink. Sesame is sometimes called *til-seed*.

Sesamoid Bones are small bones met with in the substance of tendons in the neighbourhood of certain joints. They derive their name from their resemblance to grains of sesame. In the human subject the patella is the best example; and besides it they are commonly met with on the palmar aspect of the joint which unites the metacarpal bone of the thumb with the first phalanx, and in the corresponding position in the great toe, there being two in each position, and their object to increase the leverage of the short flexor muscles of the thumb and great toe. They are much more numerous in the great majority of mammals than in man.

Sesostris, the Greek name of a celebrated Egyptian monarch, whose name has passed into the series of those conquerors who have almost achieved universal empire. According to the Greek legendary history, Sesostris at the head of a large army invaded Libya, Arabia, Asia (penetrating farther east than Darius), Europe, Thrace, and Scythia, leaving a colony at Colchis on his return. In the south he subdued Ethiopia, and, placing a fleet on the Red Sea, conquered the adjacent isles, and extended his dominions to India itself. He brought back with him large numbers of captives, who were employed on public works,

the building of temples, and the construction of canals and mounds. Memorials of his reign were left as steles or tablets in the conquered countries; Herodotus saw some in Palestine, which in reality are supposed to have been the tablets of Rameses II. Sesostris is said to have grown infirm and blind after a reign of thirty-three years, and to have ended his days by his own hand. There has always existed the greatest divergence of opinion amongst historians as to the identity of Sesostris. Herodotus places his reign long before that of Cheops of the 4th dynasty. Dicaearchus makes him rule 3712 B.C., and is followed by Aristotle and other authors. Bunsen supposes that there were more than one monarch of this name, and that one was a king of the 3d dynasty, another a king of the 12th dynasty. Lepsius conjectures that his exploits are confused reminiscences of Sethos I. and Rameses II. of the 19th dynasty—the most reasonable explanation.

Sessa, a city of Southern Italy, 32 miles NW. of Naples, has a fine cathedral, a theological seminary, a technical college, and ruins (amphitheatre, baths, &c.) of the ancient *Suessa Auruncorum*. On its hills was grown the famous Falernian wine of the Romans. Pop. 5319.

Sessions. See JUSTICE OF THE PEACE, QUARTER SESSIONS, COURT OF SESSION.

Sestertius, a Roman coin, was the fourth part of the *Denarius* (q.v.), and thus contained at first $2\frac{1}{2}$ *ases* or *libræ*. The symbols for it were indifferently HS or IIS, the former being only a modification of the latter, which expresses two units and S for the additional half-unit (*semis*). In the Latin classics the phrase *sestertius nummus*, or merely *nummus*, is frequently employed to denote this coin. When the denarius was made to contain 16 *ases* the relation between it and the sestertius was preserved, and the latter from that time contained 4 *ases*. Till the time of Augustus, when the relation of the denarius to the *as* was changed, the sestertius was worth fully 2d., but after this about an eighth less. *Sestertium* (before Augustus = £8, 15s. sterling) came to be used as if a neuter singular for 1000 sesterces; but with a numeral adverb attached, as *decies sertertium*, was used to signify 100,000 sesterces. It was the 'money of account' (never a 'coin') used in the reckoning of large sums. HSX = *decem millia sestertium*: HSX̄ = *decies sestertium*.

Sestos. See ABYDOS.

Sestri Ponente, a suburb of Genoa, $3\frac{1}{2}$ miles to the west, has shipbuilding-yards, machine-shops, and manufactures of tobacco, leather, &c., and in the neighbourhood alabaster mines. Pop. 10,686.

Sethites, or SETHIANS, a division of the Ophites (q.v.), described by Hippolytus, and so called either from the part played by Seth in their cosmogony or from the fact that their doctrines were taught in a book bearing the name of Seth.

Seton, in Surgery, is an artificially produced sinus or channel, through which some substance—e.g. a skein of cotton or silk, or a long flat piece of india-rubber or gutta-percha—is passed so as to excite suppuration, and to keep the artificially formed openings patent. (The term is, however, very often employed to designate the inserted material.) Setons are established in the subcutaneous tissue of the body (1) as counter-irritants, or (2) to act as a drain on the system at large. For the purposes of counter-irritation setons are usually inserted in the neighbourhood of the affected parts; but when intended to act as a drain on the system at large—e.g. in threatened head-affections—the nape of the neck is the part always selected. The operation is very simple. A longitudinal fold of skin over the spines of the cervical vertebræ is raised by the

fingers from the deeper structures, and is transfixed by the seton-needle rather obliquely, so that one of the openings shall be rather more dependent than the other. The needle must pass somewhat deeply through the subcutaneous tissue, as if it passed immediately beneath the skin the latter would probably slough over the whole track of the wound. The inserted material should be smeared with oil, and may be allowed to remain undisturbed for four or five days, till there is a free discharge of matter, after which a fresh portion should be drawn daily through the wound. The word *seton* is derived from the Latin *seta*, 'a hair,' because hairs were originally employed as the inserted material. Indeed at the present day it is the custom of many of the nomadic tribes of central Asia to insert a hair into the heels of their prisoners, which lames them to such an extent as to prevent their escape.

Sette Comuni. See VICENZA.

Setter, a breed of dog employed in shooting, where he fills the same vocation as the pointer. The setter is divided into three varieties—the English setter, the Gordon setter, which is native to Scotland, and the Irish setter. There was also at one time a variety known as the Welsh setter, but it is now extinct, and probably never differed widely from the English setter. As early as the 16th century the then Duke of Northumberland owned a dog trained by himself to set game, an idea soon followed by others. For many years, however, the spaniel or any other suitable dog



Setter, 'Heather Grouse.'

was selected to train to the habit of setting game; and it is not until the beginning of the 19th century that any reliable record of a distinct breed of setting dogs can be found. The English setter is bred from the spaniel probably by crossing with the pointer. Though at one time setters were known of nearly all colours, at the present time the English setter is generally white with red markings, or ticked with black spots known as a 'blue Belton.' The late Mr Laverack of Manchester was greatly instrumental in placing the breed on its present basis; he founded a distinct strain, known as Laverack setters, all bred from one brace of dogs, a strain which has become widely diffused. The Gordon setter was founded by the Duke of Gordon about 1800, by crossing the existing setter with a collie bitch which had been trained to set. The Gordon was originally a black, tan, and white dog, though white has gradually disappeared from the breed. The Gordon setter should now be a rich and glossy black marked with tan on face, chest, and legs. The origin of the Irish setter is unknown, and it is hard to say where the peculiar blood-red colour was obtained. In conformation the three varieties differ very slightly, though the Irish setter is a lighter and

more leggy dog than the others. The setter should be a smart and active dog, not built on too heavy a scale; chest very deep, though not wide; shoulders sloping back; and with good strong legs and feet. Each variety of the setter has its admirers, and it is an undecided question which is the best, or if any of them are superior to the pointer. Though the setter can endure much more fatigue and hard weather than the pointer, yet he is more headstrong and requires repeated breaking. The Irish setter is the chief sinner in this respect, but is a splendid dog when properly broken.

Settle, a little gray town in the West Riding of Yorkshire, on the Ribble, and at the base of the Castlebergh cliff (300 feet), 43 miles N.W. of Leeds. Dr Birkbeck was a native. Pop. of parish, 2213.

Settle, ELKANAH, was born at Dunstable, 1st February 1648. He entered Trinity College, Oxford, at eighteen, but soon betook himself to London, to make a living by his pen. In 1671 he made something of a hit by his tragedy of *Cambyses*, and the Earl of Rochester and others, to annoy Dryden, loudly hailed him as the superior genius of the two. Rochester got his next tragedy, *The Empress of Morocco*, played at Whitehall by the lords and ladies of the court, and in this way a great run was secured for it when it came before the public. In the insolence of success the author printed along with it a Preface, in which Dryden was severely assailed. In his great satire, *Absalom and Achitophel*, Dryden scourged him with his scorn, and so gave him immortality, if only as a shrieking ghost. Having no real strength of talent, Settle speedily relapsed into obscurity. By writing as poet for the city verses for pageants and festivities, and producing pieces to be acted in the booths of Bartholomew Fair, the some-time rival of Dryden was fain to eke out a wretched subsistence. In his destitute age he was admitted to the Charterhouse, where in 1723 he died, and his works followed, if indeed they did not predecease him.

Settlement, in English law, includes any deed, will, or other instrument by which successive interests are created in the same property, the use or income being given to one person, while the corpus of the property is preserved for his successor. A will is revocable in its nature; a settlement made by deed is irrevocable unless it contain an express power of revocation. See the articles DISPOSITION, ENTAIL, ESTATE, LAND LAWS, HUSBAND AND WIFE; in the last of which the distinction between ante-nuptial and post-nuptial settlements is explained. In Scotland the term settlement includes any general will or disposition to take effect after death. In the United States settlements other than marriage settlements are little in use; and marriage settlements are of less importance, most of the states having long since adopted the principle of the married women's property act. A person is said to have a settlement in a parish when by residence or otherwise he has acquired a claim to be relieved out of the rates if destitute; see POOR-LAWS, p. 315.

Settlement, ACT OF. See ELIZABETH (Queen of Bohemia).

Setubal (called by the English ST UBES), a seaport of Portugal, stands on the north side of the Bay of Setubal, 17 miles by rail SE. of Lisbon. The harbour is protected by five forts. The town owes its importance chiefly to its trade in wine, sea-salt, and oranges, though fishing is carried on with considerable activity. Setubal is the old Roman *Cetobriga*. In 1755 it suffered severely from the earthquake that devastated Lisbon. Pop. 14,798. Pilgrimages are made to the monastery of Arrabida, with its neighbouring stalactite cave. The poet Boccage (see PORTUGAL, p. 341) was born at Setubal.

Sevastopol. See SEBASTOPOL.

Seven was frequently used as a mystical and symbolical number in the Bible, as well as among the principal nations of antiquity, the Persians, Indians, Egyptians, Greeks, and Romans. The origin is doubtless astronomical, or rather astrological—viz. the observation of the seven planets and the phases of the moon, changing every seventh day (see WEEK). As instances of this number in the Old Testament, we find the Creation completed within seven days, whereof the seventh was a day of rest kept sacred; every seventh year was sabbatical, and the seven times seventh year ushered in the jubilee year. The three *Regalim*, or pilgrim festivals (Passover, Festival of Weeks, and Tabernacles), lasted seven days; and between the first and second of these Feasts were counted seven weeks. The first day of the seventh month was a 'Holy Convocation.' The Levitical purifications lasted seven days, and the same space of time was allotted to the celebration of weddings and the mourning for the dead. In innumerable instances in the Old Testament and later Jewish writings the number is used as a kind of round number. In the Apocalypse we have the churches, candlesticks, seals, stars, trumpets, spirits all to the number of seven, and the seven horns and seven eyes of the Lamb. The same number appears again either divided into half ($3\frac{1}{2}$ years, Rev. xiii. 5, xi. 3, xii. 6, &c.), or multiplied by ten—seventy Israelites go to Egypt, the exile lasts seventy years, there are seventy elders, and at a later period there are supposed to be seventy languages and seventy nations upon earth. To go back to the earlier documents, we find in a similar way the dove sent out the second time seven days after her first mission, Pharaoh's dream shows him twice seven kine, twice seven ears of corn, &c. Among the Greeks the seven was sacred to Apollo and to Dionysus, who, according to Orphic legends, was torn into seven pieces; and it was particularly sacred in Eubœa, where the number was found to pervade, as it were, almost every sacred, private, or domestic relation. On the many ancient speculations which connected the number seven with the human body and the phases of its gradual development and formation, its critical periods of sicknesses—partly still extant as superstitious notions—we cannot here dwell. The Pythagoreans made much of this number, giving it the name of Athene, Hermes, Hephaistos, Heracles, the Virgin unbegotten and unbetting (i.e. not to be obtained by multiplication), Dionysus, Rex, &c. Many usages show the importance attached to this number in the eyes not only of ancient but even of our own times, and it is hardly necessary to add that the same recurrence is found in the folklore of every race.—The Seven Champions of Christendom are St George for England, St Andrew for Scotland, St Patrick for Ireland, St David for Wales, St Denis for France, St James for Spain, St Anthony for Italy.—The Seven Churches of Rev. i.-iii. are Ephesus, Smyrna, Pergamos, Thyatira, Sardis, Philadelphia, and Laodicea.—The Seven Deadly Sins are pride, covetousness, lust, anger, gluttony, envy, and sloth.—The Seven Principal Virtues are faith, hope, charity, prudence, temperance, chastity, and fortitude.—The Seven Gifts of the Holy Ghost are wisdom, understanding, counsel, ghostly strength or fortitude, knowledge, godliness, and the fear of the Lord.—For the Seven Free Arts, see ARTS.

Seven Bishops. These were Archbishop Sancroft of Canterbury, and Bishops Ken of Bath and Wells, Lake of Chichester, White of Peterborough, Turner of Ely, Lloyd of St Asaph, and Trelawney of Bristol, who were tried on the charge of

publishing a seditious libel, but acquitted (June 30, 1687) amid the greatest popular enthusiasm, the very soldiers cheering even within hearing of the king. Their seditious libel was none other than a petition to James II. against his injunction that the clergy should read his Declaration of Indulgence at divine service, in London on the 20th and 27th of May, in other parts of England on the 3d and 10th of June. The order was obeyed in but four out of the hundred parish churches of London, and by not one in fifty all over England. It is striking that of the Seven all became Nonjurors with the sole exception of Lloyd of St Asaph and Trelawney. See Miss Strickland's *Lives of the Seven Bishops* (1866).

Seven Dolours of the Blessed Virgin Mary. FEAST OF, a festival of the Roman Catholic Church, dating from 1423, and since 1725 celebrated on the Friday preceding Palm Sunday. The 'dolours' or sorrows of the Blessed Virgin have long been a favourite theme of Roman Catholic devotion, of which the pathetic hymn *Stabat Mater* (q.v.) is the best known and most popular expression; and the festival of the Seven Dolours is intended to individualise the incidents of her sorrows, and to present them for meditation. The seven incidents referred to under the title of 'dolours' are (1) the prediction of Simeon (Luke ii. 35; of which, indeed, the whole seven are the fulfilment); (2) the flight into Egypt; (3) the loss of the child Jesus in Jerusalem; (4) the sight of Jesus bearing the cross; (5) the sight of Jesus upon the cross; (6) the descent from the cross; (7) the entombment. The festival is now observed as a 'greater double' (see FESTIVALS). A second one, instituted by Pius VII. in 1814, falls on the third Sunday of September.

Sevenoaks, a pleasant town of Kent, on an eminence 22 miles SE. of London. It has a Perpendicular church with some interesting monuments, the Walthamstow Hall (1882) for 100 daughters of missionaries, and a grammar-school founded in 1432 by Lord Mayor Sir W. Sennocke, incorporated by Queen Elizabeth, and reconstituted as a first-grade modern school in 1877, at which Grote and Bishops Christopher and Charles Wordsworth were educated. Knole, the magnificent seat of Lord Sackville, is close by. It was mainly built between 1460 and 1608 by Archbishop Bourchier and Thomas Sackville, first Earl of Dorset, and has a park of 1000 acres, 5 miles in circumference. Pop. (1861) 3171; (1891) 7514.

Seven Sleepers, the heroes of a celebrated legend, which is first related in the West by Gregory of Tours in the close of the 6th century (*Miraculorum Liber*, c. 92), but the date of which is assigned to the 3d century, and to the persecution of the Christians under Decius. According to the story, during the flight of the Christians from the persecution, seven Christians of Ephesus took refuge in a cave near the city, where they were discovered by their pursuers, who walled up the entrance in order to starve them to death. They fell instead into a preternatural sleep, in which they lay for nearly 200 years. This is supposed to have taken place in 250 or 251; and it was not till the reign of Theodosius II. (447) that they awoke. They imagined that their sleep had been but of a single night; and one of the seven went secretly into the city to purchase provisions, and he was amazed to see the cross erected on the churches and other buildings. Offering a coin of Decius in a baker's shop he was arrested, his startling story not being believed until he guided the citizens to the cavern where he had left his comrades. The emperor heard from their lips

enough to convince him of the life beyond the grave of the dead, whereupon they sank again to sleep till the resurrection. Gregory explains that his story is of Syrian origin—it is widely current in the East, and was adopted by Mohammed (*sur.* xviii.), who even admits their dog Kitmer also into Paradise. The Roman Catholic Church holds their festival on June 27. The names usually given are Maximianus, Malchus, Martinianus, Dionysius, Joannes, Serapion, and Constantius. Paulus Diaconus (8th century) locates a similar story in Germany, and Rydberg makes out a good case that the myth is of Teutonic origin intimately connected with the return of the dead Balder and of the other dead men from the lower world, with the idea of resurrection and the regeneration of the world, but possibly enough first Christianised in Syria or Asia Minor. The seven sons of Mimer awakening from their long sleep at the blast of Heimdal's trumpet to take their part in the final struggle of the universe is a close parallel to the seven saints of Ephesus. Both in Germany and Sweden the seven sleepers are connected with the weather—if it rains on their day rain will follow for seven weeks together. They are supposed also to take especial care of sailors. See Koch, *Die Siebenschläferlegende* (Leip. 1882); and Rydberg, *Teutonic Mythology* (Eng. trans. 1889).

Seventh-day Baptists. See SABBATH, p. 60.

Seven Wise Masters, the most common title given to a famous mediæval collection of stories, grouped round a central story, the history of which is almost the most important among the problems of storiology. The leading story itself is briefly as follows: A young prince is born in answer to prayer as the only son of the aged king Kúrush, and the astrologers foretell a great danger overhanging his fate at twenty. At seven years he is entrusted to masters, but at thirteen he has not learned anything. The sages then recommend Sindibád as the best master, but for six and a half more years the young prince studies under him uselessly, and at nineteen and a half he has still learnt nothing. The king again assembles the wise men, and Sindibád offers to teach the prince everything in six months or forfeit his life. He now shuts himself up with his pupil, who this time succeeds to his master's satisfaction. Before bringing him back Sindibád consults the stars, and sees that the prince will die if he should speak before seven days. Sindibád therefore hides himself, and the prince at court is found to be dumb. One of the king's women now tempts him as the wife of Potiphar did Joseph, and in the fury of disappointed rage accuses him to the king of an attempt on her virtue. The king condemns him to death, whereupon the seven viziers resolve to intercede to stay his execution. The first goes to the king, and by two tales against women obtains the suspension of the execution for that day. Next day the woman by a tale of contrary character obtains a confirmation of the sentence; but a second vizier again procures a suspension by two tales; and so on till the end of the seventh day when the prince is free to speak. He now comes to the king attended by the sages and by Sindibád, whereupon the woman is duly punished, and the king, after seeing proof of his son's wisdom, gives him his throne and retires into solitude to serve God.

Of variant versions there are two principal groups, the Eastern and the Western, the first including all the texts in Eastern languages, and some more or less free translations from Oriental texts; the other including the *Dolopathos*, the *Historia Septem Sapientum*, the *Erasto*, and many others. The Oriental texts have so many elements in common that they obviously spring from one book as a

common basis, of which they are more or less faithful translations, at different epochs and in different literatures. The Western texts, though derivable from the Eastern, show great divergencies alike in the fundamental story and in the tales inserted in it. The real cause of this is that in the Western cases oral tradition has transmuted the contents.

The earliest version of a *Book of Sindibád* is found in Arabian writers of the 10th century. The more important Eastern versions are the following: (1) The *Syntipas*, a Greek text translated from the Syriac by Michael Andreopolus during the last years of the 11th century (ed. by Dr A. Eberhard in vol. i. of *Fabulæ Romanenses Græce Conscriptæ*, Leip. 1872). A Syriac text was found by Rödiger, and has been edited, with a German translation, by Dr Baethgen (Leip. 1879). (2) The Hebrew version entitled *Parables of Sandabar* (*Mischle Sandabar*), translated from the Arabic, probably in the first half of the 13th century. There is a German translation by Sengelmann (Halle, 1842), a French by Carmoly (Paris, 1849). (3) The *Sindibád-Námeh*, an unedited Persian poem, written in 1375. (4) The eighth night of the *Tátt-námeh of Nachehebi*, a Persian poet who died in 1329. Of this there is a German translation by Professor Brockhaus (Leip. 1845). (5) *The Seven Viziers*, an Arabic text, forming part of some redactions of the *Thousand and One Nights*, of uncertain age, but not ancient. (6) An ancient Spanish translation of an Arabic text existing in a 15th-century codex—the version closest to the *Syntipas*. It was first printed by Comparetti in his *Ricerche intorno al Libro di Sindibád* (Milan, 1869; Eng. trans. of Comparetti's study and the old Spanish text, Folklore Society issues, 1882).

Western versions exist in the most perplexing variety and number—Latin, French, Italian, Catalan, Spanish, English, German, Dutch, Icelandic, Swedish, Danish, Polish, Russian, Hungarian, and Armenian. The *Dolopathos* is a French metrical version supposed to have been made by Herbert in the reign of Louis IX. from the Latin romance of Jean de Haute-Seille, *Historia de Rege et Septem Sapientibus*. This Latin text (*Johannis de Alta Silva Dolopathos*) was edited by Oesterley (Strasb. 1873); other Latin versions varied widely. A French metrical version was printed by Keller (Tüb. 1886); *Li romans de Dolopathos*, by Ch. Brunet and A. de Montaignon (1856); two prose versions of the *Sept Sages de Rome*, by Gaston Paris (1876). An English prose version soon followed (middle of 16th century) under the title of the *Seven Wise Masters*, and about the same time a Scotch metrical version by John Rolland of Dalkeith. One English metrical version was printed by Henry Weber (1810), another by T. Wright for the Percy Society (1845). Among Italian versions we have a 13th-century translation from a French prose version, printed by Professor A. d'Ancona (*Il Libro dei Sette Saggi di Roma*, Pisa, 1864); the latest is the 16th-century book, *I Compassionevoli Avvenimenti di Erasto*. German versions begin with the metrical rendering of 1412 by Hans v. Büchel, *Diocletianus Leben*, edited by A. Keller (Quedlinb. 1841). A second and anonymous poetical version is given in Keller's *Altddeutsche Gedichte* (Tüb. 1846). The prose *Volksbuch* was first printed in the 15th century, and will be found in Simrock's collection. See Professor Mussafia, *Beiträge zur Litteratur der sieben weisen Meister* (Vien. 1868); Dr Marcus Landau, *Die Quellen des Dekameron* (2d ed. 1884); and W. A. Clouston, *The Book of Sindibád*, from Pers. and Arab. (1884).

Seven Wise Men, the collective designation of a number of Greek sages, whose moral and social experience, according to the ancients, was embodied in certain brief aphorisms. Their names, as usually given, and their characteristic aphorisms are as follows: Solon of Athens—'Nothing in excess'; Thales of Miletus—'Suretyship brings

ruin; 'Pittacus of Mitylene—'Know thine opportunity; 'Bias of Priene in Caria—'Too many workers spoil the work; 'Chilon of Sparta—'Know thyself; 'Cleobulus, tyrant of Lindus in Rhodes—'Moderation is the chief good; and Periander, tyrant of Corinth—'Forethought in all things.'

Seven Wonders of the World were in ancient times reckoned to be the Pyramids of Egypt, the Hanging (i.e. terraced) Gardens of Semiramis at Babylon, the Temple of Diana at Ephesus, the Statue of Jupiter at Athens by Phidias, the Mausoleum, the Colossus at Rhodes, and the Pharos of Alexandria. This cycle of seven wonders originated among the Greeks after the time of Alexander the Great, and they were described in a special work by Philo of Byzantium, which has been edited by Orelli (1816).

Seven Years' War. THE, was the third, and by far the longest (1756-63) and most terrible, of the contests for the possession of Silesia (q.v.). During the two former wars the Empress Maria Theresa had been too much engrossed in maintaining her claims to the Austrian dominions to offer any very effective resistance to the aggression of Frederick the Great of Prussia; but after emerging triumphantly from that contest she began to concert measures for the recovery of her lost province. Frederick, however, with his usual astuteness, foresaw her purpose and resolved to anticipate her. Accordingly in August 1756 he made a sudden advance upon Dresden with 60,000 men; and, when the elector refused either to side with him or to promise strict neutrality in the coming struggle, he shut up the Saxon army (17,000 strong) between Pirna and Königstein. An Austrian army, commanded by Marshal Browne, advanced to relieve the Saxons, but was met by Frederick at Lobositz (October 1), and driven back into Bohemia. The Saxons then surrendered (October 14), and were mostly incorporated with the Prussian army, whilst their country was treated by Frederick, in the absence of the elector, who fled to Poland, as a conquered province. This action on the part of Frederick thoroughly roused his enemies, and made them rapidly perfect their alliances; so that, when the second campaign began in the following year, the Prussian king was opposed by 100,000 Russians, more than that number of French troops, and by armies raised by Sweden and the empire. His own armies, including 40,000 Hanoverians, English, and Hessians, numbered less than 200,000. In April Frederick, leaving a corps of 24,000 under Schwaldt to oppose the Swedes and Russians, invaded Bohemia and managed to shut up the Austrian army under Duke Charles of Lorraine in Prague; but Marshal Daun headed another army for the Duke's release, and inflicted a crushing defeat upon Frederick at Kolin (June 18). Meanwhile a large French army under Marshal d'Estrées advanced into Hanover, defeated the incapable Duke of Cumberland at Hastenbeck (July 26), and intimidated him into disbanding, by the Convention of Closter-Seven, the whole of his army excepting the Hanoverians. Another French army under Soubise effected a junction with the Imperialists under the Prince of Hildburghausen in the direction of Saxony; but Frederick turned and smote them at Rossbach, and after half an hour's fighting put them completely to rout. This diversion left the victorious Austrians unopposed, and they soon made themselves masters of Silesia and Breslau. Frederick, however, taught them what stuff he was made of by defeating an Austrian army three times as numerous as his own at Leuthen (December 5), and thereby recovered Silesia. These victories induced the Russians to vacate the province of East Prussia,

which they had seized after defeating Lehwaldt at Grossjägerdorf (August 30). The English government, rejecting Cumberland's engagements of Closter-Seven, raised another army for 1758 and put it under the leadership of Duke Ferdinand of Brunswick, who effectually held his own against the French, and even drove them out of Westphalia and beyond the Rhine, defeating them at Krefeld (June 23) and Minden near Frankfort (August 1, 1759). The king of Prussia had in the spring of 1758 pushed into Bohemia, but could make no headway before he was called back northwards to meet the Russians, who had invaded Brandenburg. He defeated them in a desperate battle at Zorndorf (August 25). At this time Frederick's brother, Prince Henry, was being hard pressed in Saxony by Daun with superior forces, and the king, the Russians being in rapid retreat for Poland, sped back to his help. Daun, however, contrived to take Frederick completely by surprise, and gave him a terrible beating at Hochkirch (October 14). Nevertheless, before the end of the year the Prussians were again in possession of Saxony.

The fourth campaign (1759) in the east of Prussia was altogether disastrous to the Prussians. The king was not able to carry out his desire of hindering the conjunction of his enemies, the Russians and Austrians, first through the defeat of his general Wedell near Züllichau (July 23), and then through his own terrible losses against the allied armies at Kunersdorf (August 12). Three months later Daun compelled a Prussian force under General von Finck to capitulate at Maxen in the south of Saxony, and thereafter established himself in that country. With greatly diminished strength, an exhausted treasury, a desolated territory incapable of affording either men or supplies, and gloomy forebodings of the final issue, though with unfaltering resolution never to yield, Frederick prepared for the fifth campaign (1760). His army in Prussia, now reduced to 90,000 men, mostly foreigners and raw recruits, was still further diminished by the capture of Fouqué with 8000 men in Silesia, followed by Marshal Loudon's conquest of that province, though by the brilliant victory of Liegnitz (August 15) Frederick successfully prevented the Austrians and Russians from uniting their forces. In spite of this his strength was now becoming ominously insufficient for the task he had set himself; the Russians and Austrians captured and plundered Berlin (October 1), the Swedes came down from the north, and Loudon closed in upon the king from Silesia. But he fell with incredible fury upon Daun at Torgau in Silesia (November 3), slew 12,000 of his men and took 8000 more prisoners, and by the retreat of the Austrians was once more left in possession of Saxony. In the following year (1761) the French were again worsted by Duke Ferdinand at Villinghausen (July 15). In Silesia Frederick as usual attempted, but in vain, to prevent the Austrians from joining the Russians, and only found relief when scarcity of provisions compelled the Russians to retreat to Poland. Loudon, however, captured Schweidnitz, whilst farther north the Russians and Swedes drove the Prussians out of Pomerania. To add to Frederick's difficulties, all subsidies from Britain were stopped by the Earl of Bute after George II.'s death, and Prussia was utterly at the end of her resources of all kinds.

But suddenly the death of the czarina Elizabeth (January 5, 1762) freed him from one of the most powerful of his enemies. At the same time the new czar (Peter III.) induced Sweden to retire from the war. Thereupon Frederick took up the contest with renewed vigour; on July 21 he stormed the

Austrian entrenchments at Burkersdorf, and, following up this success, routed Daun at Reichenbach (August 16) and took Schweidnitz (October 9), thus recovering Silesia. Contemporaneously with these events his brother, Prince Henry, by a series of fortunate manoeuvres possessed himself of the passes of the Erzgebirge, and overthrew the imperial forces at Freiberg (October 29). In the west the Duke of Brunswick still held his ground gloriously against the French, routing them at Wilhelmsthal (June 24), capturing Cassel, and recovering the whole of Hesse. France now gave up a contest from which she had gathered nothing but military disgrace, and concluded treaties with Britain and Prussia; and towards the end of the year the minor German states also withdrew from the coalition. Maria Theresa was now left alone, and, Austria being exhausted as well as Prussia, was compelled, sorely against her will, to conclude the peace of Hubertsburg (February 15, 1763; England made peace with France by the treaty of Paris on the 10th), which finally acknowledged Frederick as the lord of Silesia.

This long and desperate struggle cost Europe a million lives, and prostrated the strength of almost all the powers who had engaged in it. It made no change in the territorial distribution of Europe, but it increased tenfold the moral power of Prussia, and gave its army a prestige which it retained till the battle of Jena. But outside of Europe, in North America and India, it brought about a new epoch. According to Parkman, it crippled the commerce of France and blighted her colonial power; it gave England the mastery of North America and India, and made her the first commercial nation.

See Carlyle's *History of Frederick the Great*; Frederick II., *Histoire de la Guerre de Sept Ans*; and histories by Auchenholz (11th ed. 1879), the officers of the Prussian General Staff (8 vols. 1827-47), Maslowski (Russian account; Ger. trans. Berlin, 1888 *et seq.*), Longman (in 'Epochs of History' series), and H. Lloyd (2 vols. Lond. 1781-90); also the article FREDERICK II. And for America and India, see Parkman, *Montcalm and Wolfe* (1894); Seeley, *The Expansion of England* (1883); and the articles CANADA, CLIVE, COLONY, HAWKE, INDIA, WOLFE.

Severalty. An estate in severalty is held by one owner, without being joined with others having common interests, as opposed to Coparcenary (q.v.), Joint-tenancy, and Tenancy-in-common. In the Indian legislation of the United States land in severalty is that allotted to individuals which was once held by the tribe. In English law a contract of several persons is joint and not several—i.e. one cannot be sued separately, but they must all be sued together—unless the words 'we jointly and severally promise' are introduced into the contract, promissory-note, &c. In Scotland the general rule is the reverse; in a *conjunct* contract each is liable for the whole.

Severn (Lat. *Sabrina*), one of the most important and beautiful and, after the Thames, the largest of the rivers of England, rises, 1500 feet above sea-level, from a chalybeate spring on the eastern side of Plinlimmon, 12 miles west of Llanidloes, in Montgomeryshire, North Wales. Flowing eastward from its source to Llanidloes, to which town it retains its original British name of Hafren, it afterwards flows north-east past Newtown (465 feet) and Welshpool to the eastern boundary of Montgomeryshire, then east-south-east past Shrewsbury and Bridgnorth in Salop, and finally southward through Worcester and Gloucester, in which last it begins to form the estuary that merges in the Bristol Channel (q.v.). It is navigable for barges to Welshpool in Montgomeryshire, 180 miles from its mouth. Its entire

length is 210 miles (though the distance from source to mouth as the crow flies is only 80), and it drains an area of more than 6000 sq. m. The chief affluents of the Severn are the Teme and the Upper and Lower Avon on the east, and the Teme and Wye on the west. A canal 18½ miles long, and navigable for vessels of 350 tons, extends from Gloucester to the upper portion of the estuary of the river, and thus materially shortens the navigation of its lower course; and in the summer of 1891 works were undertaken, to cost £30,000, for the improvement of the navigation to Worcester. The Montgomery Canal extends from Welshpool to Newtown, and other canals establish communication between the Severn and the Thames, Trent, Mersey, and the other important rivers of the middle districts of England. In some of the reaches below Gloucester, especially near Newnham, the tide, which flows with great velocity, produces from the peculiar configuration of the estuary a bore (locally termed *hygre*) or wave sometimes 5 or 6 feet high, which not infrequently overwhelms lighters navigating the river. The railway twice crosses the estuary—near Berkeley by a viaduct (1879), 1194 yards long, and near Chepstow by a tunnel (1873-85), 4½ miles long.

Severn. JOSEPH (1793-1879), an artist chiefly known as the faithful friend of Keats (q.v.). From 1861 to 1872 he was British consul at Rome. See Sharp, *The Life, Friendships, and Letters of Joseph Severn* (1892).

Severo, CAPE. See CHELYUSKIN.

Severus, L. SEPTIMIUS, a Roman emperor and a soldier of great vigour and courage, was born of equestrian rank, near Leptis Magna in Africa, 146 A.D. He became prætor at Rome in 178, and was at length appointed to the command of the army in Pannonia and Illyria. After the murder of Pertinax (193) he was proclaimed emperor at Carnutum, and promptly marched upon Rome, where the puppet Julianus had by purchase obtained the imperial purple. His arrival before Rome was the death-signal for Julianus; and after taking vengeance on the murderers of Pertinax, converting his most formidable rival, Clodius Albinus, into an ally by creating him Cæsar, and distributing an extravagant largess to his soldiers, he marched against his second rival, Pescennius Niger, and conquered him at Issus (195). A glorious campaign in the East, and the three years' siege and capture of Byzantium, were followed by a desperate struggle with his jealous rival, Clodius Albinus, whom, after an obstinate conflict near Lyons, he conquered (197). After the usual games to the degenerate citizens of Rome and largesses to the troops, Severus returned to Asia, accompanied by his sons Caracalla and Geta, had the most brilliant success in the campaign of 198 against the Parthians, and took and plundered their capital, Ctesiphon. He returned to Rome in 202, and gratified the popular taste by the exhibition of shows of unparalleled magnificence, also distributing another extravagant largess to the citizens and prætorians. A rebellion in Britain drew him thither in 208, and at the head of an immense army he marched, it is said, to the extreme north of the island, encountering enormous hardships. To secure to some extent the natives of South Britain from the incursions of the Meate and Caledonians, Severus repaired or partially built the wall which is often called after him, and died soon after at Eboracum (York), 4th February 211. Some recent authorities believe that the wall has as much right to bear his name as that of Hadrian; see HADRIAN'S WALL, and G. Neilson's *Per Lineam Valli* (Glasgow, 1891).—For the emperor ALEXANDER SEVERUS, see that article.

Sévigé, MADAME DE, the queen of letter-writers, and one of the most charming figures in the literature of France, was born at Paris of an ancient Burgundian family, February 6, 1626. Her maiden name was Marie de Rabutin-Chantal, and she was the second and only surviving child of her parents. Her father's mother had entered a convent under the advice of Saint Francis de Sales, became founder of the Order of the Visitation, and was afterwards canonised. When the child was but one year old her father fell fighting against the English at Ré; a few years later her mother followed, leaving her to be brought up at Livry by her maternal uncle, the Abbé de Coulanges, the 'Bienbon' of her life-long affection. She received a careful education under Ménage and Chapelain, and learned Latin, Italian, and Spanish. From her childhood she saw clearly the whole comedy of life, and all her days she was 'une grande dévoreuse de livres'—history, Virgil, Plutarch, Tacitus, Nicole, Montaigne, and even Rabelais. At eighteen (August 4, 1644) she married the young and handsome Marquis Henri de Sévigé, the head of an ancient family of Brittany, but unfortunately for her happiness a spendthrift and a libertine. Her daughter Françoise Marguerite was born at Paris, October 10, 1646; her son, Charles, at her famous country-house, the Rochers, in 1648. She loved her husband in spite of his infidelities and indifference; forgave him even his passion for Ninon de Lençlos, who lived to cast for a moment the same evil spell upon her son; and when he was killed in a duel by a rival in a more sordid intrigue (February 5, 1651), mourned him sincerely, yet forgot him so completely that in the long correspondence of later years with her children she does not once mention his name. Madame de Sévigé at the moment of her widowhood was but twenty-five, brilliant in her beauty and fascination; yet without hesitation she embraced that holy vocation of undivided motherhood to which she was to give such complete and exquisite expression. Her handsome figure, splendid complexion, fair, wavy hair, and brilliant eyes are spoken of by all who have described her; but her beauty was more that of expression than of feature, and she herself has told us that her nose was somewhat square, her blue eyes ill-matched (*bigarrés*). Her portraits are not satisfactory, and do not give the idea of beauty, but doubtless her charm was of that subtle kind that eludes the painter. After about a year's retirement at the Rochers she returned to society, but all the flatteries of the most brilliant court in the world failed to touch her heart. The Prince de Conti, Turenne, Fouquet the *Surintendant* of Finance, Rohan, and her cousin Bussy-Rabutin (1618-93) sighed for her in vain; and, stranger still, in the midst of that age of gilded corruption, her name remains without a stain. She was virtuous by temperament, with warmth only in the intellect, says Bussy in his malicious portrait of her; but the intended sneer recoils upon himself, as if it were no virtue for that warm heart and impulsive temperament to be virtuous! Her heart was entirely occupied by a purer love—an intense devotion to her children, and a warmth of friendship almost beyond example. For no one ever had so many and such devoted friends—no woman ever knew like her how to transform a lover into a friend. La Rochefoucauld said she fully satisfied his ideal of friendship, and Madame de la Fayette said, almost at the close, after forty years of friendship without a cloud, 'Croyez, ma très chère, que vous êtes la personne du monde que j'ai le plus véritablement aimée.' The real secret of this affection was her own goodness, which is reflected on every page of her letters;

even the follies of her friends she touches with a light hand; her wit never stings, she has a charitable interpretation for everything. Her sweet and happy temper played lightly even with sorrow and wrong-doing. She was pure in an age when purity was rare, and if she had a single fault it is that she was merely something too lenient in her tolerance. She was a genial optimist, not from general indifference, but from love, for her friendships made a real part of her existence. The graphic letters to Pomponne describing the trial of Fouquet prove a noble fidelity of heart that defies misfortune and disgrace. Some of her own letters, discovered among the fallen *surintendant's* papers and read by the king, caused for a moment much talk and scandal, in allaying which Bussy did his cousin a good service. Yet furtively he had done her a grievous wrong. Having been in difficulties about 1656 he had applied to her for a loan of 10,000 écus (£2400), but, some delay being occasioned by Bienbon's desire to look into the securities, he took offence, found the money from the Marquise de Montglas, and, during the enforced solitude of a short banishment to his country-house for some scandalous impieties, wrote a few satirical sketches of the courtiers for the amusement of this mistress—the *Histoire amoureuse des Gaules*. In this unclean company a cruel and lying description of Madame de Sévigé was inserted, and when the book was printed at Liège (1665), without Bussy's knowledge, she had the mortification to find herself in the mouths of all the scandal-mongers of the day. Bussy was arrested on the 17th April, imprisoned in the Bastille for thirteen months, and sentenced to banishment from Paris for seventeen years. It needed only to be unfortunate to ensure the sympathy of Madame de Sévigé, and the reconciliation, which was complete by 1668, perhaps left the repentant Bussy, says Mesnard, 'with a more tender and serious feeling than he had ever experienced in his life before.' She herself invented the word *Rabutinage* to express the family ties and the common sympathy which substantially bound the two together.

Meantime her daughter had grown up with a beauty, if not a personal charm, that far surpassed her mother's, and Madame de Sévigé's heart was filled with joy at the sensation made by 'the prettiest girl in France' on her first appearance at court in the winter of 1662-63. In January 1669 she married François Adhémar, the Comte de Grignan, then Lieutenant-général of Languedoc, but ere the close of the year, of Provence—an office which obliged him at once to leave Paris. He had been twice married already, was thirty-seven, of ancient race, honourable in his life and dignified in manners, but he was overwhelmed in financial difficulties which were yet to cause much trouble to Madame de Sévigé. The great grief of her life was this separation from her much-loved daughter, but it is mainly to it that we owe those letters extending, with intervals of union (longest as well as most frequent between 1677 and 1688) over the twenty-five years until her death. Bussy and Saint-Simon say that the daughter lacked heart, and it is at least certain that she was proud, shy, and uncommunicative to the outer world. But she really loved her mother, and never failed, except when ill, to write to her twice a week throughout all the years of separation. It is unfortunate for her that these letters have been destroyed, and probably also, as Sainte-Beuve suggests, her mother has harmed her somewhat in our eyes by praising her too much. She seems cold by contrast with her mother's overflowing affection, but it is impossible in the nature of things that so much love as Madame de Sévigé's

could have been lavished without forcing a return. Her love was accompanied by all the doubts and fears that are the characteristic marks of another form of human emotion; and its exceptional intensity cannot be understood unless we remember how it came to fill her heart at a moment when the dear illusion of a husband's love had been rudely shattered for ever. 'Vous ne comprenez point encore trop bien l'amour maternel: tant mieux, ma fille, il est violent,' she writes. Its iteration has deterred many a reader at the outset, as it long did so fine and sympathetic a spirit as Edward FitzGerald. Yet he lived to take her altogether to his heart, and he thus ends a letter with a personal touch of pathos worthy of herself: 'I sometimes lament I did not know her before; but perhaps such an Acquaintance comes in best to cheer one toward the End.'

At fifty her splendid health was first shaken at the Rochers by a violent fit of rheumatism; thereafter till the close her only troubles were her son-in-law's vast expenditure and ever-increasing debts, and one by one the deaths of her dearest friends. Her life wore itself away in a round of duties at Paris, at the Rochers, and in visits to the country-houses of her friends and to her daughter in Provence. Nothing in her was more wonderful than her adaptability of disposition; she is happy alike by the bedside of a sick friend, in her drives with Madame Scarron, soon to be virtual queen of France, in the society of the court, and alone under the dense leafage of her park at the Rochers. One thing only we would have had otherwise than it is, but it would be a complete anachronism to ask for more sympathy than she has to show for the miserable Breton peasants under the cruel campaign of 1675. Her son Charles had some follies which cost money, before his marriage (1683); but he stands out an attractive figure enough, generous and warm-hearted, content with an unequal half of his mother's heart. Bienbon died in 1683; Bussy and Madame de la Fayette in 1693. Her letters grow sadder as she begins to find herself alone, yet some of the latest stand among the first in literary value. She never grew old, for her heart retained its warmth; yet she lived to see son and grandson married, and after nursing her daughter through a tedious illness was herself attacked by smallpox, and died calmly and without fear, 18th April 1696.

Madame de Sévigné's twenty-five years of letters to her daughter reveal the inner history of the time in wonderful detail, but the most interesting thing in the whole 1600 (one-third letters to her from others) remains herself. She was genuinely religious without superstition, a strong sympathy with Port-Royal manifest throughout; she had read widely and gained much from conversation, and she had lived in the time of Pascal, Molière, Racine, Bossuet, and La Rochefoucauld. Still more, she possessed the great natural gifts of a solid understanding and strong good sense. But it needed the warm touch of affection to make all these qualities live, and to give her letters the freedom, the rapidity, the life of spoken words. Hence her sparkling wit, her swiftly changing emotions, her unstudied yet admirable phrase, clear, firm, and natural, the tenderest sentiments and gayest flights of fancy ever expressed with unflinching grace and the indefinable charm of style. Her imagination, warmed by sympathy and love, realises the conditions of those to whom she writes, and enables her to enter into the thoughts of others, as well as to reflect as in a mirror the world around herself. Yet over all there is a gravity and reserve characteristic of that stately and ceremonious age. She never once *thous-and-thees* anybody; a certain dignity remains even in the most intimate relations. The perfection of her

letters was from the first moment recognised, and the question has often been asked did that piquant grace of detail, that charming variety in the repetition of the same thoughts, cost her pains. No doubt she knew she wrote well, however little she thought of fame, yet this knowledge did not exclude sincerity, and she must have written fast to have written so much.—'Je fais de la prose avec une facilité qui vous tue,' she says. And she does not write alike to all people; to Bussy and the sprightly Mme. de Coulanges there is a little restraint; to her daughter it is heart to heart, now private affairs and prattle about her neighbours, now matters of state and the graver questions of life and death, written with swift-flowing pen for her eye alone. We may love Madame de Grignan only for her dear mother's sake, yet we owe to her an inestimable debt of gratitude, for it was her care that preserved the precious letters of Madame de Sévigné, and bequeathed them to the endless affection of posterity.

The earliest of her letters that were published were those to Bussy, printed in his *Mémoires* (1696-97). The first edition of the *Lettres* was printed in 1726 by Bussy's son, the Abbé de Bussy, to whom her granddaughter Pauline (Madame de Simiane) had given transcripts of the originals. A more complete edition, authorised by the family, was the final one of those edited by the Chevalier Marius de Perrin (8 vols. 1754). Further editions were innumerable—three only need be mentioned, those of the Abbé de Vauxcelles (1801), Gouville (1806), and M. de Monmerqué—an abiding monument of patient industry (10 vols. 1818-19). The final edition is, however, that in the 'Grands Écrivains de la France,' begun by M. de Monmerqué, and finished by A. Régnier, Paul Mesnard, and E. Sommer (14 vols. 1865-67; vol. i., with Mesnard's life; vols. xiii.-xiv. a Lexique by Sommer), especially as supplemented by Ch. Capmas in *Lettres inédites de Madame de Sévigné* (2 vols. 1876). See Walckenaer, *Mémoires touchants la Vie et les Ecrits de Madame de Sévigné* (5 vols. 1842-52; vol. vi. by Aubenas, 1865); the Comtesse de Puliga, *Madame de Sévigné, her Correspondents and Contemporaries* (2 vols. 1873); the admirable studies by Miss Thackeray in 'Foreign Classics' (1881) and Gaston Boissier in 'Les Grands Écrivains Français' (1887), as well as those by Combes (1885) and Valléry-Radot (1888); Léon de la Brière's *Madame de Sévigné en Bretagne* (2d ed. 1882); and Saporta's *La Famille de Madame de Sévigné en Provence* (1889). See also Sainte-Beuve's *Portraits de Femmes, Causeries du Lundi* (vol. i.), and *Nouveaux Lundis* (vol. i.); E. Scherer's *Études sur la Litt. Contemp.* (vols. ii. and iii.), and chapter 6 of Amelia Gere Mason's *Women of the French Salons* (1891).

Seville, one of the most famous of Spanish cities, stands on the left bank of the Guadalquivir, 62 miles (95 by rail) N. by E. of Cadiz, and is connected with a large suburb (Triana) on the right bank by an iron bridge (1848). It has had two periods of great splendour in its history, first as the capital of a Mohammedan emirate, and later in the 16th and 17th centuries as the headquarters of Spanish painting and the chief port of Spanish commerce; and it is now rapidly recovering a good deal of its former commercial prosperity, the river Guadalquivir being navigable for large vessels (of 16 feet draught) up to the city. Until quite recently Seville had the appearance of a picturesque Moorish town—the streets narrow, tortuous, and shady, the houses built round handsome court-yards and gardens, the squares studded with fountains. But during the last few years the city has been greatly modernised by the clearing away of the narrower quarters to make room for wide straight streets and modern houses and shops. Only a few fragments now remain of the former circular city wall, which was adorned with sixty-six towers. The water-supply was formerly brought from Alcalá de los Panaderos by an old Roman aqueduct of 410

arches, but this has been superseded by new water-works constructed by Englishmen in 1883. The greatest ornament of the city is the vast Gothic cathedral, built in 1401-1519 on the site of a Moorish mosque. It is one of the largest in Europe, and contains valuable paintings by Murillo (a native of Seville), Valdés Leal, De Vargas, and other masters; magnificent Flemish stained glass of the 16th century; one of the largest organs in the world; the tombs of King Ferdinand III. of Castile, Ferdinand the son of Columbus, and other notabilities; and much most excellent artistic work in bronze, wood-carving, and sculptured work. Close beside the cathedral stands the beautiful Campanile (q.v.) or bell-tower called Giralda, 275 feet high, two-thirds of it built by the Moorish Abu Jussuf Jakub in 1196; the upper part, with its beautiful open work, dates from 1568. The Giralda has twenty-two sweet-toned bells. Both cathedral and tower were seriously damaged by an earthquake in 1884. Another of the glories of Seville is the Alcazar, or Moorish royal palace, begun in the end of the 12th century, and considerably enlarged and beautified by Peter the Cruel; its halls and gardens are surpassed only by those of the Alhambra. Amongst the other interesting buildings and public institutions of the city must be mentioned the House of Pilate built by a Spanish nobleman in 1533 in imitation of the reputed palace of Pilate in Jerusalem; the museum, with masterpieces by Murillo, Zurbaran, Pacheco, Valdés Leal, Herrera, and other artists of the Seville school, as well as by Velasquez (also a native of Seville); the charity hospital, with fine pictures by Murillo and Valdés Leal; the exchange, built by Herrera in 1585, sheltering the valuable archives of the Americas; the university, which was founded in 1254, though the present buildings were erected in 1567; the palace (1697) of the archbishop; the Palace of San Telmo, founded as a naval college by Columbus' son, but now a palace of the Duke of Montpensier; the bull-ring, which can accommodate 18,000 spectators, being exceeded in size by that of Madrid only; and numerous churches.

There is considerable manufacturing industry, especially in the production of cigars (a royal factory employing 4000 work-people), iron, machinery, pottery, cannon, silks, cottons, and various minor commodities. An average of 1295 vessels of 327,650 tons burden enter the port every year, and of this total fully one-third is Spanish and about one-fifth British. The imports, which consist principally of chemicals, timber, textiles, petroleum, machinery, coal, metals, spirits, fish, haberdashery, tinplate, and furniture, average £1,152,900 per annum in value; the first two items make up nearly one-half of the total. The exports, consisting chiefly of lead, quicksilver, wine, copper, oranges, olives and olive-oil, and corks, range from £708,900 (1889) to £1,043,973 (1888). Pop. (1878) 133,938; (1887) 143,182. This city was the Roman *Hispalis*, a place of trade in those days. Here two provincial synods of the church were held, in 590 and 619, and a Spanish council in 782. From 712 to 1248 the city (*Ishbilis*) was an important Moorish town, usually the seat of an emir, in more or less close dependence on the califs of Cordova. When Ferdinand III. of Castile captured it (1248) about 300,000 Moors abandoned the place, and it was a century or two before it began to recover. Its second period of prosperity gradually closed in as Cadiz rose into importance. Seville was the seat of the Spanish government in 1808-10, and suffered severely from Soult's troops in 1810.—The province has an area of 5428 sq. m. and a pop. (1887) of 543,944.

Sèvres, a small town of France, dept. Seine-et-Oise, 10½ miles SW. of Paris by rail, is celebrated

for its manufacture of artistic porcelain (see POTTERY), an industry carried on under state control since 1756. The Sèvres vases are of great value and are known the world over. Painted glass and mosaic are also made. See the illustrated *Soft Porcelain of Sèvres*, with Historical Introduction by E. Garnier (£8, 8s.; Lond. 1891). The Porcelain Museum contains a large and curious collection of articles in china and earthenware from all parts of the globe. Pop. 7506.

Sèvres, DEUX-, a dept. in the west of France, formed chiefly out of the ancient province of Poitou. Area, 2315 sq. m.; pop. (1891) 354,282. It takes its name from two rivers of the same name, the Sèvre-Niortaise, which flows west into the sea, and the Sèvre-Nantaise, an affluent of the Loire. The northern portion is taken up with the woody plateau of Gâtine. In other parts the soil is fertile, yielding large crops of wheat, oats, barley, potatoes, beet-root, colza seed, wine (nearly 3 million gallons annually), and vegetables. The mules and cattle are celebrated. Coal is mined, and there are good quarries of freestone. The principal industries are in cloth, leather, linen, spirits, flannel, &c., but not to any very great extent except in the first named. The arrondissements are Niort, Bressuire, Melle, and Parthenay. Niort is the capital.

Sewage, the materials conveyed by sewers. A sewer under the existing sanitary acts is a duct or channel used for conveying away the sewage of two or more houses, as distinguished from a

drain, which is the duct or channel for the drainage of one house only. *Sewerage* is the term applied to the system of pipes and culverts and their appendages by which sewage is conveyed from populous places. Sewage is composed of the refuse matter other than the dry solids and vegetable debris collected in towns. It consists of the liquid and solid excrements of men and animals; the washings from the streets and slaughter-houses; the waste waters used in cleansing operations; the contents of baths and the organic liquid refuse from some manufactories, together at times with a quantity of rainfall.

In the separate system of sewerage it is assumed that the rainfall, as far as possible, shall be kept separate from the ordinary sewage that is produced in towns and villages. In order to entirely separate rainfall from sewers two systems of drains are requisite for every house, and as a result of the expense the separate system is rarely carried to this extent; but as much rainfall is excluded from the sewers as conveniently can be separated. In recent years it has been the practice, except in very crowded districts, to carry out the separate system, and generally the old sewers and channels, more or less found in all towns, are utilised for conveying away the rainfall falling upon the district, while a new system of sewers is provided for the express purpose of rapidly removing the sewage proper with a portion of the rainfall that cannot be conveniently excluded from the sewers. In streets of great traffic, however, it is found that the liquids flowing from the surface of the roads are as foul as the foulest sewage, and consequently there is no reason why this foul liquid should not be passed directly into the sewers. There are other districts (e.g. Longton) in which there exist connections between the sewers for conveying the rainfall and those for conveying the foul water, with a connection so arranged that the small and impure rainfall should pass into the sewers proper, while the larger rainfalls leap over the opening into the sewer and pass by the surface-water system to some stream in the neighbourhood.

Copyright 1892, 1897, and 1900 in the U. S. by J. B. Lippincott Company.

The effect of rain upon sewers even under the separate system requires a very much larger provision to be made for the conveyance of rainfall than for the sewage proper, as the sewers are affected by the rate at which rain falls, and not by the given amount which falls in a day. Under the ordinary rule of thumb calculations the sewers should only admit a quantity not exceeding a quarter of an inch in twenty-four hours, which has been shown to be totally inadequate, and serious flooding has arisen in consequence. Rainfalls in London have been recorded at a rate exceeding 300 cubic feet per minute per acre. On an average of four years' observations made at Croydon it has been found that whenever it rains so as to affect the sewers the rain falls at the rate of 4 cubic feet per acre per minute; and rains have been known to increase the average flow of sewage by over thirteen times its ordinary normal volume. It is therefore important in all systems of sewerage to determine the exact area that shall contribute rainfall to the sewers. In districts of considerable area the rate at which sewers are affected by rain is very much less than in smaller districts of limited area, as in the case of large districts the distant rainfall has to traverse a considerable length of sewer before it arrives at the outfall. The abrupt increase of the flow in the sewer may cause sewer-air to be discharged. But long experience has now firmly established the fact that the water-carriage system of removing sewage is superior on the whole to all other systems.

If the sewers are liable to decay or to leak there is danger of the ground upon which houses are built being fouled; hence comes pollution of the ground-water and the outbreak of various diseases. The bricks used in the construction of all sewer-works should be as impervious as possible, and as a rule no bricks should be allowed to be used in the sewer-work in which the absorptive capacity for water exceeds 12 per cent. of their weight. The materials used in the jointing of brick sewers should also be of the most permanent character, and no other material except Portland cement mortar has yet been discovered which will stand the chemical action of sewage upon it. The smallest sewers are as a rule made of glazed stoneware pipes having various forms of joints. In some, especially wet districts, cast-iron pipes jointed with lead are used to form the sewers. No material should be used in the construction of sewers which will not allow of contraction and expansion by change of temperature. In the case of house-drains the changes of temperature are much more considerable than in the case of sewers, as often in house-drains boiling water may at one period be passing through and at another melted snow. These changes of temperature affect the stability of all sewer-work, and tend to pull it to pieces. The joints therefore should be of such a character if possible as not to present too much resistance, and should be parallel, so that if the pipes move by contraction or expansion the joint will not open more at one point than at another. The ordinary socket joint when properly made is found to be one of the best joints for either sewers or drains.

The size of sewers must depend upon the population, the volume of sewage, and the fall which can be given to them. The average dry-weather volume of sewage in most towns can be taken roughly at 30 gallons per head per day. In some places, however, it is very much less, in others considerably exceeded. The dry-weather sewage is made up by the volume of the water-supply of the district, to which may be added in districts with a wet subsoil a varying amount of leakage into the sewers. There is a daily fluctuation in the flow through sewers. Within a mile of the

point of production of the sewage the volume in one hour of maximum flow is at the rate of three times that of the average flow during the whole twenty-four hours, and as a rule one-half the sewage flows away in from six to eight hours per day.

In order to make sewers self-cleansing, either by the natural flow of sewage through them or by artificial means of flushing, they should in the case of small circular sewers or sewers of less than 10 inches diameter never be laid with a less inclination than would give a velocity of 3 feet per second through them; circular sewers above 10 inches diameter and up to 24 inches internal diameter should always be laid at a slope that will give a velocity of flow of not less than $2\frac{1}{2}$ feet per second; and in large sewers the rate of inclination should be such as to give a velocity of not less than 2 feet per second. In house-drains the rate of inclination ought to be such that the flow should not be less than 4 feet per second. This means that a pipe 1 foot in diameter should not have a less inclination than 1 in 160. The proper inclination of any smaller size of pipe or drain to give a velocity of 4 feet per second will be found by multiplying 160, which expresses the proper inclination for a 1-foot sewer, by the diameter of the sewer in feet. For instance, a drain which is 6 inches or $\frac{1}{2}$ foot in diameter would require to have an inclination of 1 in 80 to give the desired velocity. To give a velocity of 3 feet per second multiply the diameter in feet by 275; thus a 9-inch sewer = $\cdot 75$ feet should, to give it a velocity of 3 feet per second, have an inclination of $275 \times \cdot 75 = 206$ or 1 in 206. When the velocity required is $2\frac{1}{2}$ feet per second, then multiply the diameter in feet of the sewer by 386; thus a sewer 2 feet in diameter will require to have an inclination of $386 \times 2 = 772$ or 1 in 772. When the velocity required is 2 feet per second the number to multiply the diameter of the sewer will be 584. A sewer therefore, 3 feet in diameter, would require to have an inclination of $584 \times 3 = 1752$ or 1 in 1752, or practically 3 feet per mile fall, to give it the required velocity of 2 feet per second. Where sewers cannot have a proper inclination so as to render them self-cleansing with the ordinary flow of sewage through them, flushing operations are required. These consist either of the sudden admittance of a large volume of water into the sewer, or what is termed sectional flushing, by means of penning back the sewage in sections—i.e. by erecting a dam in the sewer and allowing sewage to accumulate behind it, suddenly removing the dam and allowing it to flush out the lower section of the sewer.

All sewers require to be ventilated. But it is by no means necessary to admit currents of air through sewers for the purpose of ventilation; for it may be taken for granted that the admittance of so much pure air into the sewer at one point of its course means the expulsion of so much foul air at another point. All that is required for the purpose of ventilation of sewers is a series of vents so as to allow the air to escape where it is apt to be compressed by either an increase of flow in the sewers or an increase of temperature; and to allow air to be admitted just as freely when the tendency is, for the flow in the sewers to subside and so create air-space.

The simplest and probably one of the best means of ventilating the sewers is by means of pipes carried up to a sufficient altitude above the level of the houses. In no case should any pipe have direct connection with the houses themselves, nor should a rain-water pipe be used for the purpose of ventilation, as these pipes may be blocked by rain when most required for ventilation. Ventilating pipes should be free from all obstruction and

interference, and should be independent of other pipes and connections with the sewers. Openings at the levels of the streets have been largely used for ventilators on the score of cheapness, though they are generally a source of complaint at some periods of the year as being a serious nuisance. Sometimes the ventilating gratings of sewers in streets are protected by means of charcoal air-screens, as strongly urged by Dr Stenhouse; and when such screens have been adopted and are so constructed as not to interfere with the free ingress and egress of air from the sewers, they have been found of great advantage, and have immensely reduced the nuisance and probable danger arising from an unprotected street sewer grating.

To secure a sufficiency of fall for the sewers in order to make them self-cleansing it may be necessary to divide a town into a number of sections; smaller sewers with rapid falls convey the sewage with rapidity to a number of different points, and at these points it may be pumped away. Several methods for the automatic pumping of the sewage have been introduced, such as the hydraulic system, the vacuum system of Berlier and Liernur, and the compressed air system of Shone.

The disposal of sewage is a most important point, since crude sewage may no longer be discharged into the fresh-water streams of the country. Sewage-irrigation has been very largely adopted as a means of purifying the sewage, though the expected returns from the manuring elements applied to the land have been realised in only a very few instances. The sewage-farms of Berlin, however, have been very successful, from engineering, sanitary, and economic points of view, and waste-lands have been made to yield large quantities of garden products. But only in cases where it is not absolutely necessary to purify the sewage at all times by its application to the land can it be said to be remunerative, owing to the difficulties which local authorities have in acquiring land for this purpose, and the large sums of money to be paid by way of purchase, often with a considerable contribution for consequential damages arising from some supposed injury to adjoining lands. Nor are the climatic conditions in Britain favourable to the continual application of liquid manures to land. Wherever, however, sewage can be applied or not as required, as in Craigtinny Meadows at Edinburgh, it has been found to produce large and valuable crops of grass well suited for the feeding of cattle. In the case of Croydon, where sewage-irrigation has been carried out more with a view to effect the purification of the sewage, it has been found to have answered every purpose excepting that of making a profit. Here the crude sewage, after having the solids screened from it by means of a revolving screen, actuated by the flow of the sewage, passes on to the land and thence, after its purification, into the river Wandle—a river so small that the flow of sewage forms a very large percentage of the total flow, and yet valuable as a trout stream. The fact that the effluent sewage is passed into it without injury to the fisheries speaks well for the capability of a suitable soil to effect the purification of sewage.

Where Irrigation (q. v.) is adopted for the purpose of purifying sewage, if the land has considerable inclination, the irrigation is usually laid out on the catchwork plan or with contour carriers one above another which shed the sewage on the space below. If the land has a gentle fall, then the sewage is best distributed over it on the pane and gutter system,—gutters are cut down in the direction of the fall of the land at distances from half a chain to a chain apart, and from these the sewage is thrown on to the intervening land by means of stops, which are removed from time to

time. In the case of very flat land the ground is laid out upon the bed system—i.e. the sewage is brought upon the top of a sloping bed and falls down to a gutter at the bottom of the slope of the bed. In sewage-irrigation works, when purity of effluent is desired, it will be found advisable to so lay out the land as to be able to pick up the effluent sewage which has passed over one area, and to pass it a second, or even a third time, over another plot of land, so as to ensure that no liquid has passed away without being purified.

Another method of purifying sewage is by intermittent filtration through land—i.e. the land is laid out in plots to form a filter, which must be effectually drained, and the sewage, being placed upon a particular plot, is allowed to filter through the land to the drains below. The filtration area is so arranged that the plots are used intermittently or in succession, and in this way a limited area of land may be made to purify a very considerable volume of sewage; the more porous the land, the more sewage it will purify. By this intermittent action a considerable degree of purity is secured in the effluent sewage, and a suitable crop may be grown upon the surface of such filters. Intermittent filtration areas are in common use in connection with most irrigation farms so as to avoid as far as possible the application of the sewage to large areas of land in the winter and at other times when the land is under crop not suited for the application of large volumes of sewage. At the works for the Croydon rural district at Merton, and for the Kingston rural district at Esher in Surrey, the whole of the sewage is treated by intermittent filtration, and these works are typical representatives of this system. In the former case the sewage is applied in its raw state after simple subsidence to remove the solid matters in suspension; and in the latter case the sewage is chemically treated before its application to the land.

It has been found that the purification of sewage, whether by irrigation or intermittent filtration through land, is entirely due to a small organism discovered by Messrs Schlesing and Muntz in connection with the Paris Sewage Farm. This microbe has the power of converting nitrogenous matter into nitric acid; and investigations made by Professor Warrington at the laboratory of Sir John Bennett Lawes and Dr Gilbert at Rothamsted show that it is mostly to be found in surface-soils (see NITRIFICATION). It is not found at any depth below the surface. Messrs Schlesing and Muntz showed experimentally that if the soil containing the nitrifying organism was chloroformed the organisms were rendered inactive, and in this state sewage could pass through the soil without purification, but nitrification and purification was resumed when the organism woke up. Since this discovery it has been shown that artificial filters may be built of suitable soils and other porous materials which allow the ready admittance of atmospheric air, so that large volumes of sewage may be dealt with upon limited areas. At the works of the Friern Barnet Local Board at New Southgate, the sewage of upwards of 5000 people per acre has from 1885 till 1892 been effectually filtered and purified after chemical treatment by being passed through artificial filters; and during the whole of the time these filters have been in operation they have not had a particle of material removed from their surface. Experience shows, however, that these filters can be put out of order by paralysing the action of the nitrifying organism by giving them an excessive dose of chemicals in the sewage.

Experiments made by the State Board of Health of Massachusetts on intermittent filtration tend to show that coarse sand when used intermittently is

capable of purifying 60,000 gallons of sewage per acre per day, and produce an effluent as chemically pure as most drinking-waters. The sewage, however, used in these experiments is much more dilute than sewage in England, as 100 gallons represent the sewage of a single individual per day. Other modes of filtration have been also very successfully used for the purification of sewage—for instance, a sand filter in which there is introduced a layer of mineral substance composed of magnetic oxide of iron combined with carbon, or what is now called polarite, but which was called by Mr Spencer, its discoverer, magnetic carbide of iron. It is now manufactured by carbonising in a retort the materials composing a bed of shale found in the coal-measures of South Wales. This material, like Spencer's magnetic carbide of iron, is shown to have remarkable properties in purifying sewage or other liquids containing organic substances. Filters of this character, however, require constant cleansing, as however perfectly a chemical process may be applied, sewage still contains a certain amount of flocculent matter which tends to clog the surface of the filter-bed. The area of a polarite filter required for the purification of sewage after chemical treatment is comparatively small, as a superficial yard may be trusted to purify in a properly prepared and aerated filter 500 gallons per day.

Chemical Treatment, used either separately or in combination with both natural and artificial filtration, or in connection with some sewage-irrigation works, requires a certain amount of tank space, so arranged as to secure the precipitation of matters separated from the sewage. As a rule, sewage is alkaline, and if it is treated with further alkali in excess, such as with lime, it tends to coagulate certain albuminous substances present; also the lime tends to combine with the carbonic acid contained in the sewage, or held in excess in the waters which go to make up the sewage. The consequence is that a carbonate of lime is precipitated as a flocculent deposit, forming a sort of net, which entangles and drags down other suspended impurities to the bottom of the precipitating tank.

In other cases both an alkaline and an acid chemical are used. It should be noted that there is hardly an earthy salt that has not been used in connection with the processes of precipitating sewage; the salts of alumina, iron, lime, magnesia, potash, soda, silica, zinc have all been used, either by themselves or in combination with each other. When an alkali and an acid salt are used for precipitating sewage, such as lime and sulphate of alumina, the lime should be first added as a milk of lime to the alkaline sewage, which tends to increase its alkalinity. The sulphate of alumina dissolved in water or sewage is subsequently added, and the alumina itself is precipitated as an insoluble hydrated oxide of alumina, which drags down impurities with it; while the lime combines with the sulphuric acid of the sulphate of alumina and forms a sulphate of lime, which goes away as solution in the effluent, so that the total solids in solution in the effluent are in excess of those in the sewage. Of all the precipitating processes the lime process is the only one in which there is less solid matter in solution in the effluent than in the original sewage, and, combining cheapness with efficiency, more work is got out of it for a given expenditure than by any other process. Lime effluents, however, unless passed over or through land or artificial filters, are as destructive to fish life as decomposing sewage, and therefore should not be turned direct into any stream in which injury is likely to arise to the fisheries.

Sewage Sludge is the semi-liquid substance that is deposited in tanks, whether by mere sedimentation in preparing the sewage for its application to

land, or by its chemical treatment and clarification; and the disposal of this sludge is often a difficult problem. If not already in a state of decomposition, it is very likely soon to be highly offensive from that cause, and if exposed in an inhabited neighbourhood would soon prove to be an intolerable nuisance. Sludge is a difficult material to handle, as when it leaves the tanks not less than 90 per cent. of it is water. In some instances it is pumped direct on to land and at once covered over with soil; in others it is left on the surface of the land, not without risk of nuisance, until a large part of its moisture has either evaporated or filtered into the ground, when it is dug in. In some cases the sludge is mixed with other refuse of towns, and burned in destructors. In one case it is taken by steam hopper barges out to sea and cast away, as being the least expensive method of its disposal. By far the most effectual way of disposing of the sludge is to pump it into filter-presses. In this way it is rendered portable, and becomes free from nuisance, as sufficient water does not remain in the mass to render it offensive and liable to decomposition, and what does remain is soon partly evaporated. By pressing, about five and a half tons of crude sewage direct from the tanks are reduced to one ton of pressed sludge, containing about 50 per cent. of moisture. Pressed sludge is just about as valuable as farm-yard manure, and its sale in some places realises something, and partly defrays the cost of pressing.

London sewage is discharged by two outfalls—viz. Barking on the north and Crossness on the south, into the river Thames, which divides the metropolis into two distinct drainage areas. The sewage on the north side is chemically treated and sludge removed before the clarified effluent is discharged into the Thames. On the south side of the Thames similar sewage-works were constructed in the years 1892-94. On the north side of the Thames there is a population of about 2,900,000, and the dry-weather flow of the sewage is roughly estimated at about 100,000,000 gallons per day. The sewage first receives lime in the form of lime-water at the rate of 3·7 grains of lime per gallon of sewage, and subsequently lime sulphate at the rate of 1 grain per gallon of sewage. In hot weather, however, the sewage receives further treatment, and a small quantity of permanganate of soda is applied to the sewage, usually about 1000 tons of permanganate being used in the course of a season. The sludge produced at the existing sewage-works at Barking, on the north side of the Thames, is about 21,000 tons per week, of which 91 per cent. is water. After getting rid of a portion of the water, the remainder is pumped into steam hopper ships specially constructed, and is conveyed down the Thames and out to sea, where it is discharged, this mode of disposal being found the cheapest method.

For many years the sewerage systems of American cities were modelled on European methods; but experience showed that the conditions on which these were based—as to rainfall, for instance—differed so much from those of America, that of late the special needs of each particular case have been more carefully studied. Chicago, Memphis, and various summer-resorts may be mentioned as cases where local conditions have largely modified the methods of sewerage employed.

House-drainage.—However perfectly the sewers of a town may be constructed, however safely the sewage may be disposed of, yet if care has not been taken in the design and construction of the works necessary for the drainage of each individual house very little sanitary benefit may accrue. And in any case direct evils are almost certain to follow bad house-drainage work. All house-drains, while

rapidly carrying away from the house all liquid refuse, faecal, and other matters, must be so constructed as to preserve the site of the habitation from being polluted and prevent the entrance of any sewage-air into the house. As a rule it is now required that every house-drain connected with a public sewer shall have an intercepting trap placed between the house and the sewer. This trap serves the purpose of cutting off the direct connection between the house and the sewer, so that if the house-drainage works are imperfectly carried out the intercepting trap will at least prevent the air of the public sewer entering the house. The intercepting trap also forms an opening at the lower end of the house-drain by which air can enter the drain. All house-drains require to have separate and independent ventilation by means of either the soil-pipe or some special pipe at the head of the drain, and its branches carried up to a point somewhere near the top of the house; but it must not terminate near the eaves or a window or the top of a

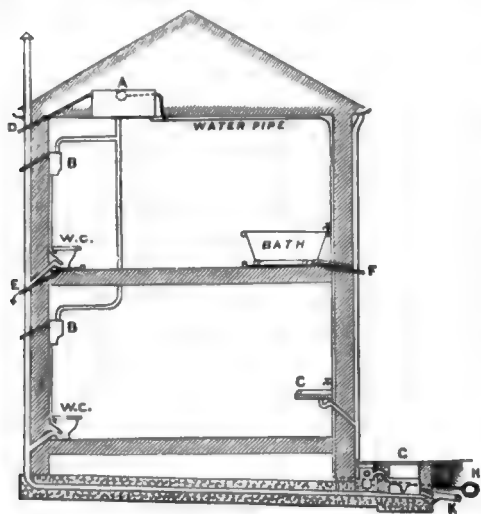

Fig. 1.

A, supply cistern; B, B, flushing cisterns for water-closets; C, scullery sink; D, overflow pipe from cistern; E, F, waste-pipes from safes under water-closet and bath; G, open grating; H, water-main; K, to sewer.

chimney, for at all these points at certain periods there are direct air-currents into the house which would carry the foul air from the ventilating pipe into the habitation.

The apartment for the water-closet in a private house should be well lighted and ventilated. A window should always be provided, which should open to the external air, and should be carried up to near the ceiling of the apartment. It is also desirable that air-bricks should be built into the external walls, both at a level with the floor and near the ceiling. In large dwellings, and public buildings, such as hospitals, workhouses, and hotels, it is desirable that the water-closets should be separated from the main building, and be approached by a corridor with doors at either end, and having thorough ventilation, so as to cut off the direct communication of the closets from the rest of the building. Such an arrangement will, in a severe winter climate, need special provision for heating the apartments.

Fig. 1 gives an illustration of a section of a house constructed in accordance with the sanitary requirements of the Model Bylaws of the Local Government Board. Fig. 2 shows the arrangement adopted in the case of houses in streets,

showing the position of the intercepting trap and air opening at the kerb of the street. With reference to the sinks and baths of houses, the simplest way of dealing with these appliances is to allow the

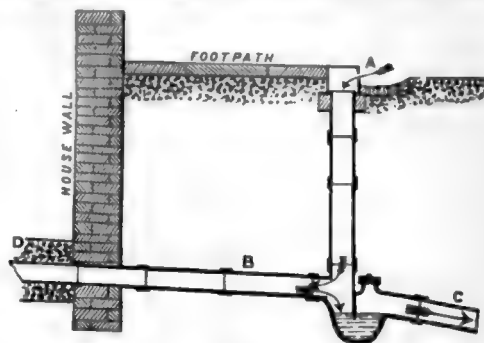

Fig. 2.

A, air-inlet in kerb; B, 4-inch drain; C, to sewer; D, concrete.

pipes to pass through the external wall, and to discharge on the top of a trapped gully outside the building, as shown in fig. 3.

The old pan closet, the invention of Bramah, is a most intolerable nuisance and source of danger if admitted into a house. This form of closet has been so generally recommended by plumbers and others whose interest it has been to foist it upon the public that a description of it is desirable. It consists of a moving pan at the bottom of a basin, which is worked from the handle of the closet, and a receiver, against the sides of which the contents of the pan are projected every time the handle of the

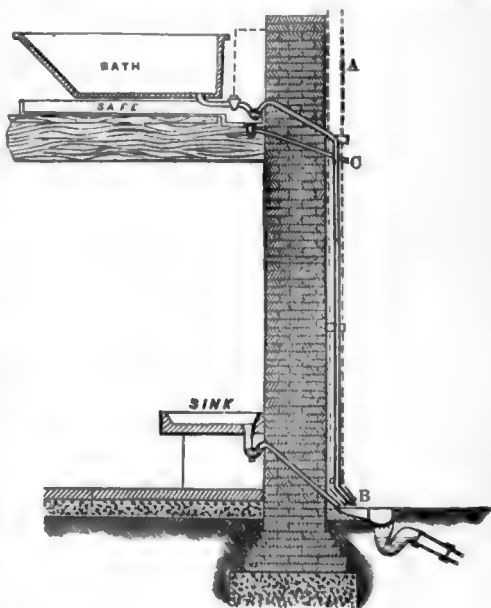

Fig. 3.

A, rain-water pipe disconnected below; B, bath and sink waste-pipes disconnected; C, overflow from safe under bath.

closet is raised, the consequence being that the walls of the receiver get plastered over with faecal matter, which, decomposing, generates noisome gases. These gases being confined in the space between the water seals of the pan and that of the D-trap at the bottom, when the closet is used and the contents of the pan are discharged into the

receiver, a portion of the noisome gas escapes at once into the atmosphere of the apartment in which the closet is located, and very often pervades the air of the habitation.

This is a form of water-closet that never should, under any circumstances, be used, and, as it is expensive both in first cost and in maintenance, it is difficult to understand how it is that it still finds a place in the houses of the people. The D-trap which is used in connection with this pan closet should also be prohibited.

The valve water-closet is also largely used. It has a valve at the bottom of the basin, and it differs but slightly in principle from the pan closet. In this form of closet there is not so much space between the valve and the trap as in the pan closet. It is, however, difficult to maintain the valves water-tight, and, on the other hand, it is

an expensive article, and nothing like so perfect a sanitary appliance as some cheaper forms of closet.

The ordinary hopper closet is one of the simplest, cheapest, and most sanitary devices, and when furnished with an adequate flushing-cistern is one of the best and sweetest appliances which can be used in houses. This is shown in fig. 4. The flush-out closet (fig. 5) is a closet which has been largely used in recent years. It has some objections in consequence of the faecal matters being spread out over a large area and but imperfectly covered with water, and the tendency of the flush water to break up the faecal matters deposited in the basin, which gives rise to effluvia when the closet is used.

Trough closets are largely used where numbers of people congregate together, as in clusters of cottages, workhouses, mills, and barracks. An ordinary form of closet or latrine is shown in fig. 6. This is cleaned by a flushing-tank which fills up slowly with water, and discharges rapidly by siphon action. The provision of urinals, lavatories, and water-closets for public use is a matter of necessity in most towns, and lately in large towns these conveniences have been constructed in chambers below the street level, which are approached by a flight of steps.

In the case of detached houses and cottages where there are no sewers it is often a difficult matter to know how to deal with the liquid refuse produced, including the chamber slops and waste water. Probably, in the majority of cases, the best

mode of dealing with these matters is by application to the garden by throwing them on the surface, or into an open trench freshly cut for the purpose, and as far from the habitation as possible. Means have also been provided in some rural districts to distribute these waters by a series of underground agricultural drain-pipes laid about 1 foot below the surface, and intermittently charged by a gully having an intermittent discharge by means of a siphon connection with the drain. Where waters are distributed in this way in retentive soils a lower set of agricultural drains laid at a depth of

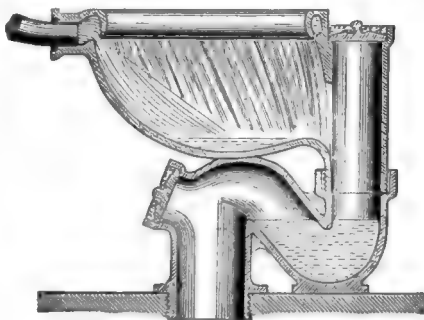

Fig. 5.

about 4 feet should be provided for collecting the drainage after purification in passing through the land. The success of this mode of disposal, however, largely depends upon the nature of the ground.

Cesspools.—Wherever it is necessary to construct a cesspool for the retention of sewage, it should be in such a position with reference to the water-supply as not to foul (in case the cesspool leaks) any well used as a source of water supply. As all underground waters move in particular directions, the cesspool should invariably be on the lower side of the source of water-supply. It is absolutely necessary that cesspools should be built of good materials, and made perfectly water-tight with Portland cement, otherwise pollution of the ground and ground water is sure to arise, the evil conse-

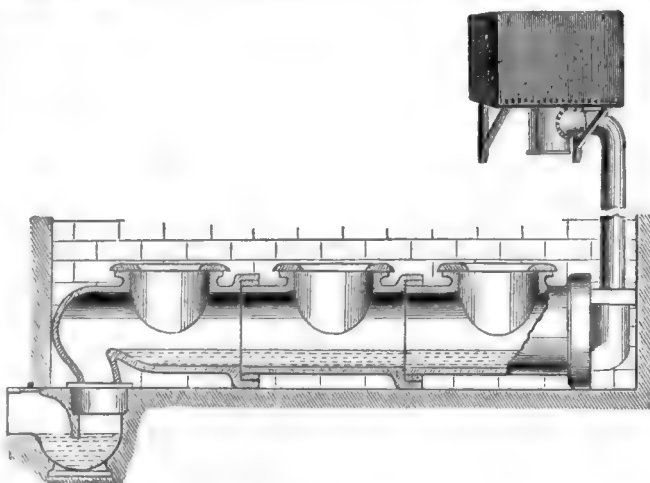

Fig. 6.

quences of which may spread for unlimited distances in the direction of the moving ground water. Cesspools also require to be properly ventilated,

and they should be so located that in emptying them it should not be necessary to carry their contents through any dwelling-house or building in which persons are employed.

In some towns and districts there seems to have been a great prejudice about admitting the faecal matters of the population into the sewers, and in such districts various forms of dry conservancy have been adopted. The Middenstead appliance is one in which the faecal matters of the population are mixed more or less imperfectly with ashes and garbage. Formerly these middensteads had the adjoining ashpit uncovered, and still in many places they remain uncovered. A great improvement was effected when it was made a necessity that the ashpit should be roofed over to prevent the rain percolating into the vault below. A still greater improvement has been attained by insisting that the floor of the chamber should be located above the level of the surface of the ground; that the ashes should be properly distributed over the

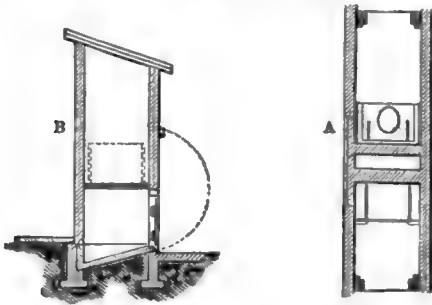

Fig. 7.

faecal matter; and that the space should not be greater than to hold the contents of one week's supply, or about 8 cubic feet in capacity. An illustration of this is shown in fig. 7; A represents the plan of a pair of closets of this description, and B a section of the closet. In no case ought a privy to be under the roof of the dwelling-house, and the least distance it should be from an inhabited building is 6 feet. It has been clearly shown that in some large towns in which this middenstead system is very largely adopted it leads to a very high death-rate amongst the inhabitants, especially amongst the children, and cannot compare for health or cheapness with the water-carriage system.

The Pail system has also been largely adopted in some towns for receiving the faecal matter only of the population. The pail is usually placed below the closet seat. Where the pail system is in use the whole of the interior surrounding the pail should be flagged, asphalted, or cemented. The floor of the chamber should be kept above the ground level, and the contents of the receptacle should not exceed 2 cubic feet, and it should be removed at least once a week. An arrangement by which the sifted dust from the ashes is passed into the pail, so as partially to effect its deodorisation, is also very useful in detached houses. All these appliances of dry conservancy, however, only deal with part of the polluting matter produced by the population; the rest finds its way to the sewers, and the sewage is found to be none the less offensive because a part of the faecal matter has been kept out of the sewers. And the collection and manufacture into manure of all the matters that are collected in towns has only resulted in a dead loss to the authorities of every town that continues to maintain these systems.

The Earth-closet system is the invention of the

Rev. Henry Moule, vicar of Fordington, Dorset. It consists of the application of earth to the deodorisation of faecal matters, and is a valuable system in its proper place; but it cannot compare in efficiency with the water-carriage system in a town in which there are sewers. In detached houses, however, and country places, and in some public buildings it has proved to be an exceedingly valuable adjunct to other sanitary appliances. The first requirement for the successful working of the earth system is that earth of a loamy character, perfectly dry and finely sifted, should be used.

Earth-closets are of two varieties, those with fixed receptacles and those with movable receptacles. For the interior of the house the latter only should be used. In earth-closets outside the dwelling the materials may be allowed to accumulate in a dry vault for three months without any injury or annoyance, provided sufficient suitable dry earth was originally used in the closet. It is found that faecal matter when mixed with sufficient dry earth is completely disintegrated, and together with paper entirely disappears in the course of a few days, and that no decomposition takes place during the process. In the case of closets with movable receptacles they should be emptied every week. Apparatus for supplying the earth should be fitted and form part of the closet, and should be made self-acting. No slops should be thrown into an earth-closet.

The quantity of dry earth required in England for use in the earth-closet is about 2½ lb. per head per day, which is about five times the weight of the faecal matter that is collected in those towns in which the pail system is in operation; so that the volume of earth required is large in proportion to the matter dealt with; and it is difficult to procure and expensive to carry in the case of a large population. Of course the earth after removal is from an agricultural point of view more valuable than before use, but, unfortunately, it does not produce a manure of a high class. The earth in an outside

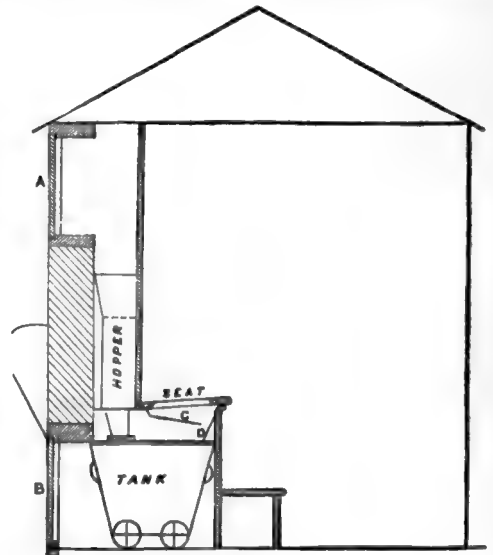

Fig. 8.

A, door-opening for filling hopper; B, door for emptying tank; C, shield; D, slide.

earth-closet may be used several times over, provided it is dried each time before use; and this adds to the value of the manure and reduces the cost of earth. Fig. 8 represents a form of earth-closet

which is actuated from the movement of the seat of the closet, and in which the earth after admixture with the faecal matter is retained in a tank on wheels which can readily be removed and replaced with another tank when required. The objection to the earth-closet is that it necessitates heavy double carriage of the materials, and that it only deals with part of the refuse produced. From a sanitary point of view, however, it is clearly superior to any other method of dry conservancy.

Pneumatic Systems of Sewerage.—The Liernur system, the oldest pneumatic system of sewerage, is the invention of Captain C. T. Liernur, and is in operation in some continental towns, especially in Holland; but there is no town at present in which the entire sewage of the whole town is treated on this system. The Liernur system consists in aiding the withdrawal of the faecal matters from the habitation with the assistance of air-pressure. Under this system, at some convenient central place, works are erected, and steam or other power is provided which gives motion to an air-pump which keeps certain air-tight receivers exhausted or partially exhausted of air, and these receivers communicate by means of air-tight iron pipes with various convenient stations throughout the district that is to be served by this system. From these latter stations other iron pipes branch off into the streets, and with these pipes the individual houses are connected by means of iron pipes with a valve on each house-drain, which is controlled from outside the house by the persons in charge of the system. The closet within the house is a truncated conical vessel with a bent pipe at the bottom, looking like a trap, but which is used for receiving and storing the faecal and other matters deposited in the closet. A partial vacuum being maintained in the pipes of the system, it is obvious that if the valve at the street front of the houses is suddenly opened the atmospheric pressure acting on the matters collected in the bent tube at the bottom of the closet and in the pipes between this point and the valve will be withdrawn and a large volume of air will be carried into the pipes, which will continue so long as the valve is open and a partial vacuum is maintained. The Liernur system, from a sanitary point of view, is little better than the pail system; and, in spite of the value put on the manure, it is, when compared with a proper system of sewers and water-carriage, very expensive. All the pipes and fittings must be constructed of iron, and it does not deal with the whole of the sewage, so that a system of sewers is requisite for dealing with the greater part of the waste waters. In all the pneumatic systems the large volume of foul air exhausted from foul pipes, and again liberated into the atmosphere, is a source of very considerable danger to health.

The Berlier system, which has been partially adopted in Paris, is similar to the Liernur system, except that the discharge from the house into the vacuum-pipes in the street is automatic in its action. The same objections apply to this as to the Liernur system.

The Shone system is another pneumatic system, used simply for raising sewage from one level to another higher level. In this system, instead of a vacuum being used, air above atmospheric pressure is directly applied to the liquid sewage contained in an iron vessel called an ejector, and the direct pressure of the air forces the sewage out of the ejector to the required altitude. Under this system the town is usually drained on the separate system of water-carriage to a number of convenient points at which there are ejectors. The air used for transmitting the requisite power is compressed at some convenient

point, and is distributed through iron pipes to the various ejector stations to be used as required. The Shone system is ingenious, but very expensive, both in first cost and to maintain at work, and it has the sanitary disadvantages, in common with other pneumatic systems, of liberating foul air into the atmosphere. It has, however, been adopted by the authorities of several small English towns, and is in operation at the Houses of Parliament.

The Hydraulic Sewage System.—This is a system that has for its object the local pumping of sewage at several points within a district, and raising it to a higher level. In this case the district may be divided into a number of separate areas, and at some convenient central position in each area an automatic hydraulic pumping-station is established, to which the sewers of the district gravitate. In this system a power-station is provided just as in the various pneumatic systems, and at this station steam or other power is employed, this power being transmitted throughout the district to the various automatic stations by water at high pressure. At the power-station the water is pumped into an accumulator, which is a cylinder weighted to the requisite pressure, riding on a ram, through the centre of which the water enters the cylinder, and the cylinder rises and falls as it is more or less filled with water. From this accumulator pipes are carried to the various automatic pumping-stations throughout the district. The automatic hydraulic engines at the various local stations are simply direct-acting pumping-engines, in which the high-pressure water gives motion to a piston within a cylinder, and this in turn works a pump directly attached to it. The automatic engines are controlled by a float in such a way that when there is sewage to pump it is pumped just as fast as it flows from the sewers, and when the flow of the sewage declines the hydraulic engine stops until the supply of sewage is replenished. In the transmission of the power, water under a pressure of 700 lb. per-square inch or more is used; and the great advantage of the system over any pneumatic system arises from the fact that a large amount of power can be distributed with little loss. For the friction of water, unlike air, in passing through pipes does not increase with the pressure; there is just as much loss in transmitting water at 10 lb. pressure per square inch as at 1000 lb. per square inch through a pipe of the same size, and consequently the actual percentage of loss at the higher pressure is very small. Another great advantage of water over air is that there may be any number of variable altitudes to which the sewage is raised without loss of power, as it is only a question of grading the size of the cylinders of the automatic hydraulic engines to adapt them to any lift. High-pressure water can also be stored in an accumulator ready for urgent work without increase of pressure, and without the loss that arises when it is attempted to store air in a receiver for use. Again, the water that has been used for transmitting the power is used for the purpose of flushing the sewers, as it may be distributed to automatic flush-tanks. This saves the cost of buying water for the purpose of flushing the sewers; generally the water so applied, if it had to be purchased, would involve a greater expenditure than the whole cost of transmission of the power. The water used for transmitting power may be the purified sewage or subsoil water, and if the latter source is adopted the result of taking it from the ground and so reducing the water-level is a further great gain from a sanitary point of view.

The hydraulic system of pumping is more economical at work than any other system, and it occupies less space than any other apparatus.

Two engines of this kind, capable of raising together 1½ million gallons per day, can be accommodated in a chamber of 9 feet in diameter, which can be constructed wholly below a public road; and its existence would be unsuspected, as the engines are noiseless in their action and require very little attention. The system has already been adopted and is at work in the districts of Friern Barnet, Esher, Thames Ditton, Long Ditton, and Margate, and is being adopted by the authorities of other towns both in Britain and in other countries.

The Electrical System of Sewerage.—This system, sooner or later, is likely to come into operation in towns, for the purpose of automatically pumping the sewage. It has already been successfully used in pumping water in mines, and it has been shown to give more than double the duty that can ordinarily be secured by the use of air under pressure; so that there is no reason why, in towns in which electric lighting has been employed, the same apparatus may not be used to transmit power for the purposes of the automatic pumping of the sewage. For an electric or other plant is only really economical when it works continuously up to nearly its full power; and as sewage pumping is most required in the daytime and electric lighting at night, by combining the two this would be effected and a certain economy would result. Electricity has already been applied experimentally to the purification of sewage, combining a chemical precipitating process with oxidising properties that have been shown to purify sewage.

See, of English works, Krepp, *The Sewage Question* (1867); Corfield, *Treatment and Utilisation of Sewage* (1870; 2d ed. 1887); Scott Burn, *Sanitary Science* (1872); Burke, *Sewage Disposal* (1872); *Sanitary Engineering*, by the present writer (1873; new ed. 1878); Eassie, *Sanitary Arrangements* (1874); Slagg, *Sanitary Work* (1876); Robinson and Melliss, *Purification of Water-carried Sewage* (1877); Carpenter, *Preventive Medicine* (1877); Bailey Denton, *Sanitary Engineering* (1877); books on plumber-work by Hellyer (1877) and Buchan (1880; 2d ed. 1889); Galton, *Healthy Dwellings* (1880); Robinson, *Sewage Disposal* (1882; 2d ed. 1888); Bouldin, *Sanitary Engineer's Handbook* (1885; 2d ed. 1892); Reeves, *Bad Drains* (1885); Putnam, *House Drainage* (1886); Isaac Shone, *Drainage of the Houses of Parliament* (1887); Santo Crimp, *Sewage Disposal Works* (1890). Of American works, see Waring, *Sanitary Drainage* (1876-91); Baylis, *House Drainage* (1879); Adams, *Sewers and Drains* (1880); Philbrick, *American Sanitary Engineering* (1881); Gerhard, *Drainage and Sewerage* (1884-90); Baumeister, *Cleansing and Sewerage of Cities* (1891); Cady and Pierson, *The Separate System of Sewerage* (1891). Also the article HYGIENE.

Seward, ANNA, the 'Swan of Lichfield,' was born in 1747 at the rectory of Eyam in Derbyshire, but lived from the age of seven all her days at Lichfield, where her father, himself a poet, became a canon residentiary. Dr Darwin and Mr Day were notable figures in the society of Lichfield; her dearest friend was Honora Sneyd, who married Edgeworth; Dr Johnson, like the prophet of the proverb, had more honour everywhere else than among his own people. Miss Seward only escaped a nearer connection with the lexicographer by the death of her only surviving sister Sarah on the eve of marriage with Lucy Porter's brother. Her own father died in 1790, but she continued to live as before in the bishop's palace, dear to her friends and correspondents—Mrs Piozzi, Hayley, Southey, Scott—and died 23d March 1809. She published her poetical novel, *Louisa*, in 1782; her *Sonnets* in 1799; her *Life of Dr Darwin* in 1804; but bequeathed to [Sir] Walter Scott the care of the collected edition of her poems (3 vols. 1810). Her long-winded, florid letters, on which she piqued herself even more than her poems, were collected in six volumes (1811-13). Boswell received from her 'some obliging communications concerning Johnson,' but after his

book was published quarrelled with her, accusing her of malevolence towards his hero. Her monody on Major André and an elegy on Captain Cook were thought her best poems. In the letters she is Johnsonian without strength, metaphorical beyond all measure, feeble and absurd to a degree. Horace Walpole says of her and some other harmonious virgins, 'Their thoughts and phrases are like their gowns—old remnants cut and turned.'

Seward, WILLIAM HENRY, a distinguished American statesman, was born at Florida, Orange county, N. Y., May 16, 1801, graduated at Union College in 1820, was admitted to the bar in 1822, and thenceforth made his home at Auburn. He early took an active interest in politics, and in 1827 presided over a young men's convention held at Utica to advocate the re-election of John Quincy Adams to the presidency. In 1830 he was elected, as an anti-Mason, to the state senate, where he remained four years, leading the opposition to the dominant Democratic party. In 1834 he was the unsuccessful Whig candidate for the governorship of the state of New York, but was elected to that position in 1838, and again in 1840. A noteworthy incident of his administration was a controversy with the governor of Virginia in regard to three negro seamen, whom the latter claimed as fugitives from justice, on the charge of inciting a slave to escape, and whom Governor Seward refused to surrender. Having declined a third nomination, he was engaged from 1843 to 1849 in the practice of his profession, being especially sought after in criminal and patent cases. In 1847 he defended John van Zandt, accused of aiding in the escape of fugitive slaves, and incurred obloquy by his defence of the negro murderer, Freeman, on the plea of insanity. His argument in this case was pronounced by Mr Gladstone 'the greatest forensic effort in the English language.' Mr Seward continued to give active support to his party, while at the same time making himself remarked as an opponent of the pro-slavery policy. In a speech against the admission of Texas into the Union he said: 'To maintain the slave-holding power is to subvert the constitution;' and at Cleveland, during the campaign of 1848, he told his hearers, in speaking of slavery: 'It must be abolished, and you and I must do it.' In February 1849 he was elected to the United States senate, where he served two full terms, being re-elected in 1855. He was much consulted by President Taylor, but declined to be put on any important committee lest his opinions on slavery should embarrass the administration. In 1850, while urging the admission of California into the Union, he declared that the national domain was devoted to liberty, not only by the constitution, but by 'a higher law than the constitution'—a phrase which became famous. He opposed the Compromise Bill of 1850; separated himself from those Whigs who followed President Fillmore in his pro-slavery policy; opposed the Know-Nothing (q.v.) party; and on the formation of the Republican party became one of its leaders. His speeches in the senate on the repeal of the Missouri Compromise and the admission of Kansas made a great impression, as did also an address delivered at Rochester in 1858, in which he spoke of the 'irrepressible conflict' between freedom and slavery.

In 1860 Mr Seward was a candidate for the presidential nomination, but on failing to receive it gave his hearty support to Mr Lincoln, whose cabinet he entered as Secretary of State, an office which he held through two administrations, from 1861 to 1869. The civil war, which was in progress during the first half of this period, rendered the foreign relations of the United States unusually

Copyright 1892, 1897, and 1900 by the U. S. by J. B. Lippincott Company.

delicate, especially in view of the attitude of the governments of France and Britain. In the 'Trent' affair he was obliged, in opposition to popular clamour, to admit the justice of England's claim and to advise the president that the Confederate envoys should be given up. He protested against the fitting out of the *Alabama* and similar vessels in British ports, and declared that the United States would claim from the English government indemnities for damages resulting from this breach of the obligations of a neutral power. On the subject of the French invasion of Mexico he maintained a prudent reserve, until the conclusion of the war enabled him to insist on the withdrawal of the French troops. On April 14, 1865, while confined to his bed with a broken arm and jaw, the results of a carriage accident, he was attacked and severely cut on the face and neck by an accomplice of J. Wilkes Booth. He supported President Johnson's reconstruction policy, thereby placing himself in opposition to the majority of his own party and incurring much bitter censure. In 1867 he negotiated with Russia the treaty for the purchase of Alaska. After leaving office he travelled in 1869 to California and Alaska, returning through Mexico, where he was warmly welcomed as the guest of the nation; and in 1870-71 he made a tour round the world, his narrative of which was edited and published (1873) after his death by his adopted daughter, Olive Rislew Seward. He died at Auburn, October 10, 1872. Without being a creative statesman, Mr Seward had great practical ability controlled by sound notions of truth and justice; always a party man, he was never an extreme partisan, and rather made public opinion than followed it. Strong convictions joined to a conciliatory disposition rendered him a fitting representative of the moderate anti-slavery sentiment and a worthy fellow-worker with Lincoln in preserving the Union.

See his Autobiography, continued in 1846 in a memoir by his son (1877), and to 1872 in his *Life and Letters*, by the same (2 vols. 1891); the *Life* by the same (3 vols. 1896); also Charles F. Adams's Address on his Life, &c. (1873), and the memoir by George E. Baker published with his *Works* (3 vols. 1853; 2 other vols. 1862-84).

Sewell, ELIZABETH MISSING, author of a long series of High Church novels, the daughter of a Newport solicitor, was born in the Isle of Wight in 1815. Her first novel, *Amy Herbert*, was anonymous, and edited like three or four more of her early works by her brother, the Rev. William Sewell, vicar of Yaxley. She has produced more than forty volumes, including novels and devotional works. There is an edition of her works in 11 vols. (1886). She has been a frequent contributor to the *Monthly Packet*.

Sewellel. See HAPLONDON.

Sewing-machine, a machine for sewing and stitching upon cloth, leather, and other fabrics. It is one of the most important and labour-saving inventions of the age, and is extensively used for domestic and manufacturing purposes throughout the civilised world. By its use the labour of doing the family sewing has been reduced to a minimum, a new and profitable article of merchandise, to wit, 'ready-made clothing,' created, the manufacture of shoes and various articles of merchandise greatly facilitated, and the processes of their manufacture revolutionised.

There are at the present time a large variety of sewing-machines manufactured, each adapted to the kind of work it is intended to perform, as the Family Sewing-machine, for general domestic or family purposes; the Manufacturing Machine, for manufacturing purposes; the Cylinder

Machine, for the vamping of shoes, stitching of water-hose, water-buckets, mail and travelling bags and satchels, and for leather-work generally; the 'Universal Arm Feeder Machine,' used largely in the manufacture of gloves and repairing of shoes; the Over-seaming Machine; the Carpet Sewing-machine; the Jacquard Pattern-stitching Machine; the Stay-stitch Machine; the Basting and Quilting Machine; the Button Sewing-machine; and the Button-hole Machine. Indeed the sewing-machine, in the present stage of development, is adapted to all kinds of plain or fancy sewing required, alike upon the finest and the heaviest goods. A notable specimen is the Goodyear Welt Machine, by which shoe-manufacturers are enabled to produce by machinery footwear as good as that made by hand, if not better.

The familiar family sewing-machine, as made by Wheeler & Wilson, is worked with the foot by a treadle motion, and, with its various attachments of 'hemmers,' 'fellers,' 'corders,' 'binders,' 'quilting-gauge,' &c., is adapted to all kinds of family sewing. The same machine, without the stand, is fitted up with a crank, to be operated by the hand. Sewing-machines are also run by the spring or electric motor for home use, or by steam-power in factories. Sewing-machines may be divided into classes, according to the stitch made, as the 'chain-stitch,' the 'double-loop stitch,' the 'lock-stitch,' and the 'button-hole stitch' machines.

The 'chain-stitch' machine uses but one thread, looped upon itself, by means of a curved needle or hook, beneath the cloth, which catches the thread as it is carried through the cloth in the eye of the vertical needle, and holds it until the second descent of the needle, this time through the loop thus made, which is drawn up upon the under side of the cloth as the vertical needle again rises, and so on—thus making a chain of stitches which is easily unravelled. Machines of this class are of



Fig. 1.

limited application, being better adapted for embroidering and basting than for manufacturing purposes or for general domestic use. Fig. 1. represents this stitch. The Wilcox & Gibbs is an illustration of this class of machine.

The 'double-loop stitch' is a machine using two threads, one upon each side of the fabric—the upper thread in the eye of the vertical needle above the cloth, the other in the circular needle which vibrates immediately beneath the cloth. By the descent of the vertical needle the upper thread is carried down through the cloth, where it becomes looped and interlooped with the under thread, forming a stitch which, being interlooped with the adjacent stitch, presents the appearance of three threads interlooped upon the under side of the cloth, and upon the upper side the single thread as in the 'single chain-stitch.' The 'Grover and Baker stitch' makes a strong and durable seam, but consumes a large quantity of thread, and is easily unravelled. The Grover & Baker machine, upon which this stitch was originally made, is no longer manufactured; the 'stitch' has, however, been retained in some of the more modern machines.

The 'lock-stitch' class of machines, sometimes called the 'double lock-stitch' machines, comprises fully four-fifths of all the machines now in use, and is admirably adapted for domestic and manufacturing purposes. Like the 'double-loop stitch' the 'lock-stitch' machine is a double-threaded machine, having one thread upon either side of the fabric.

The upper thread of the lock-stitch machine, passing from the spool as it is purchased and placed upon the 'spindle' or 'spool-holder' upon the arm of the machine, through the 'thread-check,' around the 'tension-pulley' or between the 'tension-discs,' through the 'thread-guide,' 'take-up,' and 'leader' (these are of various devices), finally through the eye of the vertical needle, is carried by the descent of the needle bar downward through the cloth and the loop of the under thread, and by the upward motion of the needle is again brought back through the cloth, drawing the under thread upward to the centre of the fabric, where, by a proper adjustment of the tension of the two threads, they are locked, making a perfect stitch, exactly the same upon



Fig. 2.

both sides of the cloth. Fig. 2 represents the 'lock-stitch,' than which nothing better is required for sewing. By this stitch an elastic and durable seam is made, which even the skilled operator finds difficulty in ripping. It will not unravel. Of this class of machines there is also a large variety, which may be subdivided into two classes—those using the vibratory, oscillatory, or shuttle motions, and those constructed entirely upon the rotary motion principle.

The Singer and the Wheeler & Wilson are the leading exponents of these two classes of lock-stitch machines, and are the two great competitors in the markets of the world. There are many other excellent lock-stitch machines whose names are familiar both in homes and workshops, as the Howe, Remington, Florence, Weed, Domestic, American, &c., (the last-named using a rotating shuttle), all of which make the lock-stitch in the centre of the fabric, and are constructed either upon the principle of the vibratory or oscillatory shuttle motion or upon that of the rotary motion.

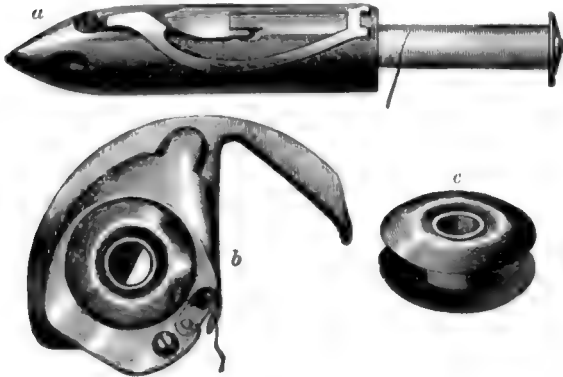

Fig. 3.

a, vibrating shuttle; b, oscillating shuttle; c, bobbin of oscillating shuttle.

Fig. 3, a, represents the vibrating or reciprocating shuttle of the Singer machine. Originally all of the Singer machines were constructed with this mechanical device for the supply of the under thread, the shuttle vibrating beneath the 'baster-plate.' The oscillating shuttle was adopted by the Singer Manufacturing Company in 1878. The loop is formed and caught by the beak of the shuttle as in the reciprocating shuttle. The

shuttle has a long beak, the object of which is to hold the loop until the needle has been lifted entirely out of the goods. While the needle is out of the goods the loop is opened by the body of the shuttle sufficiently to pass through, the thread being pulled down through the needle's eye and the opening through the goods left free for the thread to play in, a vast friction and strain upon

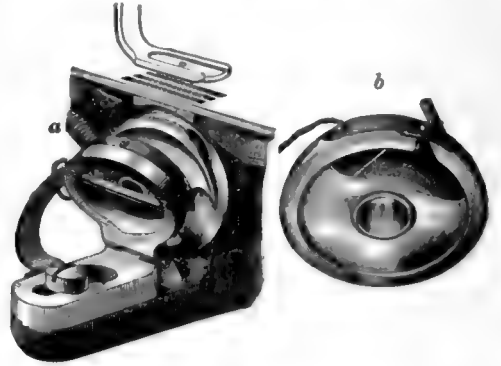

Fig. 4.

a, rotating hook, bobbin-holder with bobbin, &c.; b, bobbin and bobbin-case.

the thread being thus avoided. Fig. 4 represents the sewing device of the Wheeler & Wilson family machine, consisting of a rotating hook, formed by a disc of polished steel, with 'slot' cut in its periphery and its pointed ends curved, which being attached to the horizontal pulley shaft revolves with it, giving off from its bevelled edge at each revolution a loop, formed by the upper thread on the outer side of the needle as it descends through the 'slot.' This loop is caught upon the rotating hook and carried along with it about two-thirds of the way round, and, as it slips off and the thread is again partially drawn up by the rising needle, crosses the bobbin, catching its thread and drawing it upward, thus forming interlocking loops, which tightly drawn form the stitch. The bobbin is perfectly free, is neither pivoted nor placed upon an axle, but is fitted in a concave holder upon the outer side of the rotating hook and revolves in the opposite direction from the hook, thus securing a proper tension and giving off at each revolution sufficient thread for one stitch. Fig. 5 represents the sewing mechanism of the manufacturing machine of this make—'No. 12'—constructed with a view of securing the highest speed, accuracy, and economy of power consistent with the rotary motion. The bobbin is placed upon a 'stud' or 'axle' in the centre of the rotating hook, and the thread is drawn through a 'slot' in the periphery of the bobbin-case, and held securely by a spring or passed through an eyelet.

This machine is also constructed with a 'cylinder feed' specially adapted to the vamping of shoes (the vamp being stitched just as it comes from the pasting block), which is easily changed into a 'flat-bed' machine by means of an adjustable platform, adjusted over the cylinder feed; and, as represented in fig. 6, it may be constructed as a three-threaded machine, having two parallel threads which by its peculiar mechanism become interlocked alternately with the under thread, forming a zigzag stitch upon the under side and presenting two parallel rows of stitching upon the upper surface,

each row having the exact appearance of the ordinary lock-stitch. The stitching thus made can

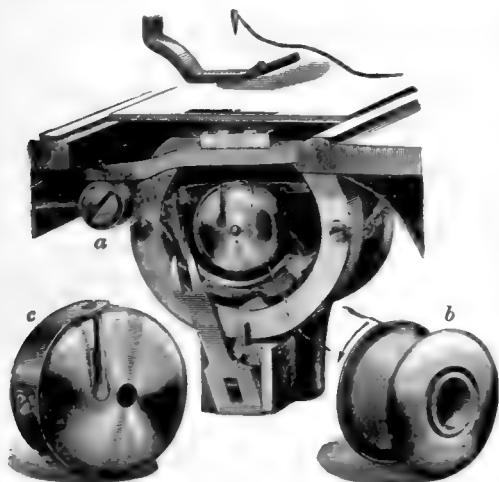

Fig. 5.

a, bobbin-holder, rotating-hook, &c.; b, bobbin; and c, bobbin.

be taken out only stitch by stitch, and is largely used upon the 'uppers' of shoes.

The German universal feed cylinder sewing-machine, a lock-stitch machine which feeds in every direction and which by its small cylindrical arm is adapted to repairing of shoes, glove manufacturing, and pocket-book manufacturing, has an automatic device attachment by which it duplicates any number of patterns of circular stitching. About $2\frac{1}{2}$ or 3 yards of thread are required to one yard of sewing for the 'lock-stitch,' being about half the quantity required by the 'double-loop stitch' machines. Some of the lock-stitch machines will make a single chain-stitch if we remove the under thread device and substitute a looper using but one thread.

The button-hole machine makes the 'whip-stitch' of the button-hole and also the 'pearl-edge stitch.' It is a wonderful piece of mechanism — impressing one as almost possessing conscious intelligence. It works automatically, cuts its own button-hole, works the button-hole before or after it is cut, cords the button-hole, and bars the end, heavy or light as required, and stops automatically when the hole is completely worked. The machine will work 6000 holes in a day, taking 1500 stitches per minute, and is capable of being used upon the

leather shoe or glove, or upon cloth of either light or heavy weight. The stitch is substantially a lock-stitch, the under thread being thrown up upon the edge of the button-hole. There are several machines of this class, and this stitch is secured by a 'button-hole attachment' adjusted to a family machine.

The Singer carpet-sewing machine is manufactured under the Joseph Hesse original base patent for straddling a carpet—supplemented by re-issue patent in 1870, also by the patents for improvement on same machine by G. Grisel in 1884 and 1885. While other sewing-machines feed the goods, this is the reverse. While the goods remain stationary, the operator, holding the machine with one hand, with the other turns the crank, which in turn moves a right and left feed-wheel in the straddling plates. These feed-wheels take hold of the carpet and force the machine forward fast or slow as the crank is turned. The stitch is made with a curved needle and looper. The machine may be operated by a lady; the carpet is secured by clamps, and a durable overseam is produced. Ingrain, hemp, Brussels, velvets, moquettes, or Axminsters are sewed with equal facility.

Machines have been invented for taking the 'back stitch, the 'basting or running' stitch, the through-and-through stitch known as the 'cord-wainer's' stitch, the over-and-over stitch; indeed every stitch used in plain and fancy needlework except the 'blind' or 'hemming' stitch.

The hemming stitch must not be confounded with 'hem-stitching,' a well-known process by which certain threads of the 'filling' of cloth are drawn, and the warp artistically wrought into clusters or groups of threads by the use of the

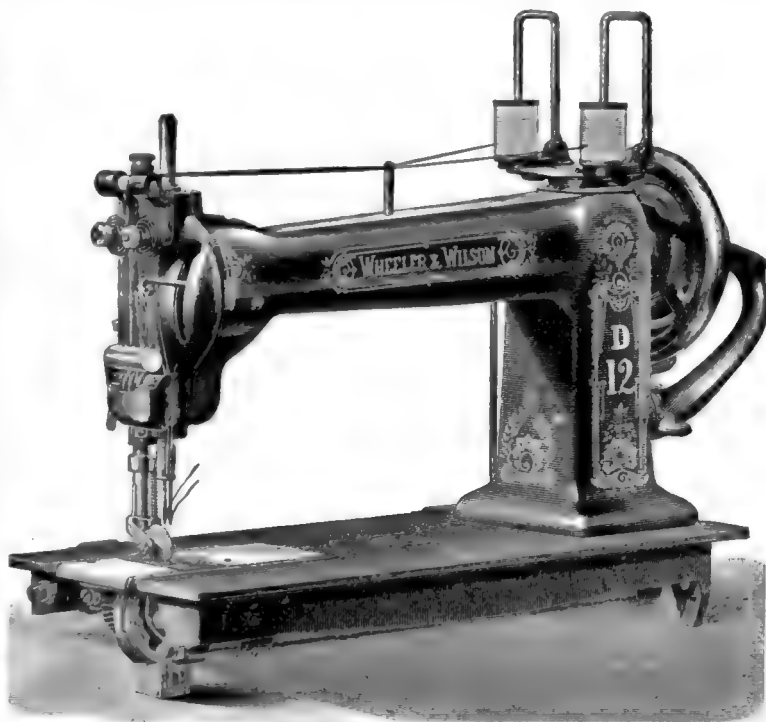

Fig. 6.—Head of Wheeler and Wilson's No. 12 fitted up with two upper threads.

needle. The hem-stitching effect is produced upon the sewing-machine by the weaving of the thread alternately through the edges of adjacent pieces of

cloth, then by the lock-stitch, sewing the threads through the centre, by stitches lengthened for the purpose of producing the effect desired. By a similar process, the skilled operator can readily produce lace in beautiful and artistic designs; and the effects of old tapestry may even be produced by the use of the sewing-machine.

History.—The idea of the sewing-machine originated in England during the 18th century, but as an invention of practical utility it is a product of the 19th century, and of the United States of America. In June of 1755 Charles F. Weisenthal patented a needle in England, having an eye in the centre, and being pointed at both ends. It was intended for hand embroidery, but was subsequently used in some of the earlier sewing-machines. Robert Alsop in 1770 patented in England a device for embroidering with one, two, or more shuttles. This was followed in 1804 by a machine, invented and patented by John Duncan, for embroidering, consisting of a large number of barbed or hooked needles set in a horizontal bar, and supplied with thread by a feeding needle. By a forward motion of this bar the needles were simultaneously carried through the fabric, and by the reverse motion were again brought back, passing through the loop of thread made by the previous stitch, thus making a "loop-stitch." This machine was subsequently improved by Mr Heilman, and extensively used for embroidery purposes.

Meanwhile, in 1790, a patent was taken out in England by Thomas Saint 'for quilting, stitching, and making shoes, boots, spatterdashes, clogs, and other articles.' This machine used a single thread, made a loop-stitch, the loops being upon the outer side of the fabric, had a perforated awl by which the hole for the needle was made, and was worked by a combination of 'cogs,' 'prongs,' 'wheels,' and 'spindles.'

In 1834 M. Thimonnier, a Frenchman, secured a patent in England for a crocheting-machine for sewing purposes, which made a loop-stitch by means of a hooked needle that had to be passed through the cloth backward and forward twice in order to make one perfect stitch. This machine improved was subsequently patented in France, and in 1851 in the United States. In 1871 Archbold and Newton secured a patent for sewing or stitching the backs of gloves, with the ornamental or tambour stitch, the tension being regulated by passing the thread over a roller covered with cloth, and by the alternate rising and falling of a bar across the thread, the latter acting as the modern *take-up*, and securing uniformity in the degree of tightness



Fig. 7.

of the thread. The *feed* was a rack-and-pinion motion by which the material secured between two metal clamps, through which were openings for the needle, was moved forward as the stitching proceeded. In 1842 J. Greenough of Washington secured a patent in the United States for a machine

for sewing shoes. This machine made the 'through-and-through' stitch, or 'shoemaker's stitch,' represented in fig. 7, using a single thread in the eye of Weisenthal's needle, *a*, the needle being drawn through backward and forward by means of pincers upon each side of the material. There was neither 'chain,' 'loop,' nor 'lock' by which the firmness and durability of the 'hand-sewed' shoe or of the ordinary 'back-stitch' for garments was secured, and hence this machine could not be adapted for general sewing. In 1843 B. W. Bean of New York



Fig. 8.

patented a machine making the 'running' or 'basting' stitch, a stitch similar to the 'through-and-through' stitch, but by quite a different device (see figs. 7 and 8, and compare) and designed for a different class of fabric. Fig. 8 represents the device used in the machine for the making of the running stitch. The needle, *a*, is long and stationary, with the eye and point at opposite ends, as in the ordinary needle for hand-sewing, and receiving a continuous supply of thread from the reel, *b*; the two small toothed wheels, *c*, are so arranged that their teeth pressing into one another crimp the two pieces of cloth, *d*, and push them forward against the needle-point, the operator drawing off the cloth from the needle at the eye end as rapidly as it is filled. This machine was extensively introduced into England, and used by bleachers, printers, and dyers for temporary basting, and for loose tacking of pieces of stuff.

The machine destined to revolutionise the sewing world and play a most important part in future industries was not yet conceived. The thought of the inventor had been centred apparently upon facilitating the embroidery of various articles of household and dress ornamentation, excepting the effort to lessen the labour of making shoes. Walter Hunt of New York is said to have constructed a machine for taking the lock-stitch in 1832 or 1834. However, to Elias Howe (1819-67), of Cambridge, Massachusetts, belongs the credit of constructing and patenting the first lock-stitch sewing-machine. Compared with the almost perfect machines of to-day, this machine was indeed a crude effort; it however formed the basis of the present lock-stitch sewing-machine, and comprised its essential features. It was patented in 1846, although possibly constructed earlier. Mr Howe combined a needle having the eye near the point vibrating in the direction of its length, though horizontally, with a shuttle device vibrating horizontally, yet so as to pass through the loop made by the thread in the needle eye being carried through the cloth, then drawn backward in the opposite direction; together with the 'sawmill carriage' 'feed motion,' and a baster-plate and projecting pins holding the cloth as in metal clamps in a vertical position while being stitched. The stitch formed by the two threads, one upon each side of the fabric, drawn in a 'double interlocked loop' in the centre of the material, presents the appearance of a single thread in regular stitches, exactly the same upon both sides of the cloth, and is essentially the lock-stitch of the more modern machine. The needle of the

Howe machine was a great invention, without which no sewing-machine is possible; improvements were, however, soon made in the 'setting' of the needle, substituting the vertical motion of the needle for the horizontal motion of the original machine, thus passing the cloth upon the table of the machine horizontally under the needle, together with a 'wheel feed motion' beneath the baster-plate, by which the cloth was moved horizontally from left to right. Subsequently the shuttle was made to describe an entire circuit instead of the former oscillating or vibrating motion. This latter improvement was made and patented by Blodgett & Heron of Boston in 1849; but while it effectively economised power, it was soon found impractical because of the un-twisting of the thread as the shuttle rotated. In 1850 Allan B. Wilson of Pittsfield patented a 'double beak shuttle,' by which a complete stitch was made at each forward and backward motion of the shuttle, which also economised power. About the same time Robinson of Boston patented a machine having two needles curved, which being threaded with short threads, one upon each side of the cloth, were passed alternately through the cloth, and the thread drawn each way, making the cordwainer's stitch. By this machine the back stitch and the basting stitch could be made.

In 1851 Mr Wilson invented and patented the 'rotating hook' device (see fig. 4), a device new in machinery and an effective substitute for the shuttle. Mr Wilson also made a most substantial improvement in his lock-stitch rotary motion machine, known as the 'four-motioned feed' or 'rough surface feed with yielding pressure,' which has since been adopted by all sewing-machine manufacturers for all flat-bed work. It consists of a horizontal slotted bar placed between the standards which support the cloth plate, with a 'feed-tongue,' which fills the slot, and is pivoted at one end, but free at the other end for an up-and-down motion. The four motions are an upward or lifting motion by which the teeth are fixed in the cloth, a forward motion by which the cloth is moved forward, a downward motion by which the teeth loose their hold upon the cloth, and a backward motion effected by a spiral spring at the other extremity of the feed-bar. The length of the stitch is determined by the play of the feed-bar. By the successive motions of this rough surface feed, the only hold upon the cloth while the needle is passing down through the cloth is the needle itself; hence the cloth may be turned in any direction by the operator without stopping the machine, an advantage which will be readily appreciated, making it possible to turn corners while sewing. In 1849 a 'chain-stitch' machine was patented by Morey and Johnson, in which the cloth was suspended from a circular baster-plate, the thread being carried through the cloth by the horizontal play of the needle. This machine was subsequently improved by J. E. A. Gibbs of Virginia, and as improved is known as the Wilcox & Gibbs machine. The double loop-stitch machine before described was invented and patented by W. C. Grover and W. E. Baker of Boston in 1852. Immediately after the Singer machine, bearing the name of the inventor, was patented. It was an improvement upon the original Howe machine, and it in turn has been improved from time to time with various patents, until, as we have seen, it is one of the leading machines. Its automatic self-adjusting belt is one of its recent patents. In 1856 Chapin secured a patent for the 'hemmer,' a device of steel consisting of a 'scroll' or 'gauge' set in a steel 'presser-foot,' by which the hem or fell is turned. It is an attachment adapted to any sewing-machine. Various patents have been secured

for the various attachments and improvements from time to time, and also for new machines adapted to special classes of work, the number in the United States alone amounting to many hundreds, and still a large number of devices for sewing-machine appliances are patented annually.

The button-hole machine was invented and patented in 1882 by Ostrom, and almost at once materially improved by Horace Doggett, a young man under twenty, by the addition of an 'automatic cutter.' This device was patented, and was subsequently purchased by the Wheeler and Wilson Company. Attachments for the working of button-holes have been patented, adapted for use upon any-sewing machine. The button sewing-machine is also a recent invention, of which there are a variety of devices patented.

Immediately after the invention of the Singer machine litigation arose between the various inventors, and terminated in 1854 in a sewing-machine combination, by which all companies united in the use of the Howe needle and the Wilson four-motioned feed, paying to their inventors a royalty. Mr Howe's royalties amounted to over \$2,000,000; Mr Wilson also amassed a large fortune from his four-motioned feed patent, which patent ran out in 1878, the last of the important original patents to run out. Immediately sewing-machines were reduced in price fifty per cent.

The sewing-machine of to-day is fitted up with an open or closed cabinet with or without drawers elaborately finished in expensive woods, the machine being of the same quality in all cases. A large amount of capital is invested in the sewing-machine manufacture, and many thousands of machines are annually made, there being from 6,000,000 to 8,000,000 now in use. The Singer Manufacturing Company is the largest manufacturing company, having factories at Elizabethport, N. J., at Kilbowie, near Glasgow, Scotland, at Vienna, and in Canada. The main factory of the Wheeler and Wilson Company is in Bridgeport, Conn., and its machines are extensively used in Great Britain and other European countries.

Sex. In all the many-celled animals, and in most of the many-celled plants, the continuance of life from generation to generation is secured by special reproductive cells which form new lives, being sooner or later separated from the body of the parent. In this specialisation of reproductive cells lies the great difference between sexual and asexual reproduction. But in the great majority of organisms the special reproductive cells are of two kinds—there are relatively large and passive ova, and relatively small and often very active spermatozoa. These two kinds of reproductive cells are mutually dependent; in most cases they die unless they unite with one another. When this union or fertilisation takes place a new life begins. But in most organisms the ova are formed in one organ, the spermatozoa in another, while in most animals, and in all the higher forms, the ova are formed by one individual (a female) and the spermatozoa by another (the male)—there being, in other words, two distinct sexes. Moreover, the males and females differ not only in their essential characteristics of producing spermatozoa and ova respectively, but they often differ very markedly in external appearance, constitution, and habits. Further, they are instinctively attracted to one another in such a way that the union of the complementary reproductive cells is secured.

It is evident then that the fact of sexual reproduction involves many distinct biological problems: (a) the formation of specialised reproductive cells; (b) the origin of two different kinds of reproductive cells—ova and spermatozoa; (c) the differentiation of distinct organs or of two distinct types of indi-

vidual for the production of these two kinds of elements; (*d*) the divergence between the sexes in secondary as well as in essential characteristics; and (*e*) the evolution of the sexual instincts which find their highest expression in the love and courtship of many of the higher animals. As the general problem of sexual reproduction is discussed in the article REPRODUCTION, and as the divergent modes of sexual reproduction are discussed in special articles, such as HERMAPHRODITISM and GENERATIONS (ALTERNATION OF), we shall confine ourselves here to the problems immediately connected with the evolution of sex.

What is the meaning of the existence of two distinct sexes? The problem may be approached in several different ways. We may, for instance, inquire whether this normal divergence of individuals into two types has any analogue among other cases of divergent variation among organisms. To some the analogy seems not far to seek. For throughout organic nature a great contrast may be read, between plant and animal, Gregarine and Infusorian, coral and jellyfish, barnacle and shrimp, coccus-insect and fly, slug and Pteropod, tortoise and lizard, reptile and bird, and even more clearly between related genera or even related species; a contrast between predominant passivity and activity, between a storing and constructive physiological habit and one which is prone to expenditure and disruption; an contrast expressible in technical language as an antithesis between a relative anabolic and a relative katabolic preponderance in the protoplasmic life of the creature. Now it may be that the difference between the sexes, between the relatively passive female and the more energetic male, is an expression of what is really a fundamental alternative in variation.

Or we may take a survey of the contrasts between the sexes, and endeavour, after making allowance for the special conditions of each case, to reach some average truth. Then we find that females tend to be larger, more sluggish, less brightly coloured and decorative, that they often have a longer life and sometimes a higher temperature; and that males, on the other hand, tend to be smaller, more energetic, more brightly coloured and decorative, and so on. Now, these characteristics, when physiologically analysed, tend to corroborate the theory that the females and males are individuals of relatively anabolic and relatively katabolic constitutions.

Again, we may approach the problem by inquiring into the physiological conditions which tend in each birth to determine whether the individual will be a male or a female. In many cases—e.g. in amphibians, birds, and mammals—the young life is for some time—usually of very short duration—potentially bisexual; it is believed that surrounding conditions, especially of nutrition, acting upon some constitutional predisposition, determine the predominance of either maleness or femaleness. It is true that we have but incomplete knowledge of this matter, but there are many facts which suggest that influences of food, temperature, &c., which favour anabolism in the parents, embryos, and young, tend to result in female offspring, while opposite factors tend to produce males. Thus by abundant and rich nutrition Jung raised the percentage of females in a brood of tadpoles from 56 to 92, and starved caterpillars tend to become male butterflies or moths. Or again, we may fix our attention on the characteristic products of the sexes—on the ova and spermatozoa. Here the difference between female and male has its fundamental and most concentrated expression. For the ova are relatively large cells, very passive, and usually rich in reserve-products, while the spermatozoa are very minute cells, usually very active, rarely with any

reserve-products. In short, the ova (like the females) are relatively anabolic, and the spermatozoa (like the males) are relatively katabolic.

We should also inquire into the beginnings of sexual differentiation among the simpler forms of life. Among the unicellular Protozoa, in which sexual reproduction in the strict sense cannot occur, there are already the analogues of males and females, as we see for instance in *Vorticella*, when a small free-swimming individual unites with a stalked cell of normal size. Very gradual among the simple plants also are the steps of sexual differentiation. But of especial importance is the genus *Volvox*—a colony of loosely united cells—in many ways related to the Flagellate Infusorians. In this globular colony division of labour is at a minimum, and individuals often occur which are quite asexual, forming daughter-colonies, without specialised reproductive cells. Others have, among the other units of the colony, special reproductive cells, which are, however, parthenogenetic, able of themselves to form new colonies. Others have special reproductive cells—ova and spermatozoa—formed within the same colony, but usually maturing at different times. Then there are colonies in which only ova are formed, and others in which only spermatozoa are formed, cross fertilisation taking place as usual. And besides these various sexual conditions other combinations often occur in the same species of *Volvox*, in which we can indeed read, and with increasing physiological knowledge will more fully understand, almost the whole story of the evolution of sex.

Finally, it must be observed that the origin of two kinds of reproductive cells which combine in fertilisation, and the specialisation of two types of individual as the bearers of ova and spermatozoa respectively, must have been of advantage in the general evolution of organisms. For, as almost every life begins in the mingling of two distinct reproductive units produced by two distinct types of individual, there is here one of the most important sources of variation and one of the most important means of securing the average stability of the species.

But we must also recognise the psychical expression of sex—the love of mates. This also has its history. Among crustaceans and insects first, in fishes and amphibians, in reptiles too, but most markedly among birds and mammals, the males are attracted to the females, and enter into relations of helpfulness with them. The relations and attractions may be crude enough to begin with, but to mere physical fondness are added subtler attractions of sight and hearing, and these are sublimed in birds and mammals to what we call love. This love of mates broadens out; it laps the family in its folds; it diffuses itself as a saturating influence through the societies of animals and of men.

See REPRODUCTION, SEXUAL SELECTION, and *The Evolution of Sex*, by Prof. Geddes and the present writer (1889), with a bibliography of the subject.

Sexagesimals. See SCALES OF NOTATION.

Sexagesima Sunday (Lat. *sexagesima*, 'sixtieth'). See QUINQUAGESIMA.

Sextant, an instrument for measuring the angular distance of objects by means of reflection. The principle of its construction depends upon the theorem that, *if a ray of light suffer double reflection, the angle between the original ray and its direction after the second reflection is double of the angle made by the reflecting surfaces.* Thus, let A and B (fig. 1) be two mirrors perpendicular to the same plane, and inclined to each other, and let SA be a ray of light, which falling upon A is reflected on B, and re-reflected in the direction BC, then

ACB is the angle between the original and finally reflected rays, and ADB is the angle between the mirrors. Now, as the angle of reflection is equal to the angle of incidence, $\angle SAF = \angle BAD$, and $\angle GBA = \angle DBC$; but $\angle EBC = \angle BAC + \angle BCA = (\angle BAD + \angle DAC) + \angle BCA = (\angle BAD + \angle SAF) + \angle BCA = 2 \angle BAD + \angle BCA$; and $\angle EBC$ also $= \angle EBD + \angle DBC = \angle EBD + \angle GBA = 2 \angle EBD = 2 \angle BAD + 2 \angle BDA$; therefore $\angle BCA = 2 \angle BDA$, which proves the truth of the theorem. The instrument of which this theorem



Fig. 1.

is the principle is a brass sector of a circle in outline; the sector being the sixth part of a complete circle, for which reason the instrument is called a sextant. Fig. 2 shows the essentials of its construction; AMN is the sector whose curved side, MIN, is the sixth part of a circle; A is one mirror wholly silvered, placed perpendicular to the plane of the sector, and on, and in line with, the limb AI, which is movable round a joint at or near A; B is the other mirror, also perpendicular to the plane of the instrument, and silvered on the lower half only, the upper half being transparent; E is an eyelet-hole or small telescope. The graduation runs from N to M (on a slip of silver, platinum, or gold let into the rim), and is so adjusted that, when the movable limb is drawn towards N till the mirrors A and B are parallel, the index which is carried at the foot of the movable limb is opposite zero on the graduation. If we suppose that this zero-point is at N, it is evident that the angle between the mirrors is equal to the angle NAI; and again, if instead of graduating from 0° at N to 60° at M, which is the proper graduation for the sixth part

part of B, and then moving the index till the image of the other object, reflected from A upon the silvered part of B, coincides with or is opposite to the first object; then the angle, read off at I, gives the angle between the objects. For additional accuracy a vernier is attached to the foot of the movable limb.

The sextant is capable of very general application, but its chief use is on board ship to observe the altitude of the sun, the lunar distances, &c., in order to determine the latitude and longitude. For this purpose it is necessary to have stained glasses interposed between the mirrors A and B, to reduce the sun's brightness. These glasses (generally three in number) are hinged on the side AM, so that they may be interposed or not at pleasure. B is the glass through which the horizon is perceived, and has hence received the name of the horizon-glass; while the other mirror, from its being attached to the index-limb, is called the index-glass.

The sextant is liable to three chief errors of adjustment: 1° if the index-glass be not perpendicular to the plane of the instrument; 2° if the horizon-glass be not perpendicular to the plane of the instrument; and 3° if, when the mirrors are parallel (which is the case when a very distant body, such as the sun or moon, is observed directly through B, and found to coincide with its image in the lower part of B), the index does not point accurately to 0°; this last is called the index-error, and is either allowed for, or is remedied by means of a screw, which moves the index in the limb AI, the latter being stationary. The first two errors are also frequently remedied by means of screws working against a spring, but in the best instruments the maker himself fixes the glasses in their proper position.—The quadrant differs from the sextant only in having its arc the fourth part of a circle, and being consequently graduated from 0° to 180°; the octant contains 45°, and is graduated from 0° to 90°; while the repeating-circle, which is a complete circle, is graduated from 0° to 720°. A common form of the sextant is the 'snuff-box' sextant, which is circular in shape, and, as it can be conveniently carried in the pocket, is the form most frequently used by land-surveyors.

The idea of a reflecting instrument, on the principle of the sextant, was first given by Hooke about 1666; but the first instrument deserving the name was invented by John Hadley (q.v.) early in the summer of 1730, and a second, and much improved form of it, was made by him a short time afterwards. Halley, at a meeting of the Royal Society, claimed for Newton the priority of invention, and in October 1730 a Philadelphian, named Godfrey, also asserted his claim as the original inventor; but that learned body decided that Newton's claim was unsupported by even probable evidence, and that Hadley's and Godfrey's inventions were both original, but that the second form (which is almost the same as the common sextant now employed) of Hadley's instrument was far superior to his first form and to Godfrey's. See works by H. W. Clarke (1885) and C. W. Thompson (1887).

Sexton (corrupted from Sacristan, q.v.) is a parochial officer in England, whose duty is to take care of the things belonging to divine worship. He is usually chosen by the inhabitants, but often also by the clergyman or the churchwardens, the mode of appointment being regulated by the custom of each parish. He sometimes also holds the office of parish-clerk. Women have occasionally been appointed sextons (e.g. at Kingston-upon-Thames, 1731; Doanybrook, near Dublin, 1845-56; and the adjoining parish of Booterstown, 1856-74). The office is a freehold office for life, except in the

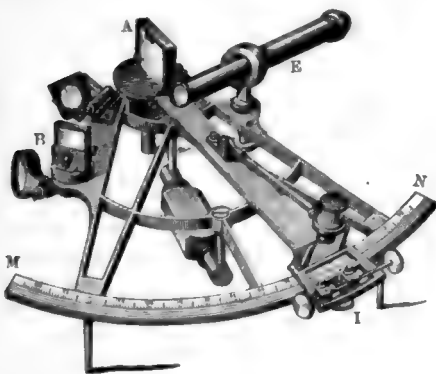

Fig. 2.

of a circle, the graduation be made from 0° to 120°—i.e. each half degree being marked as a degree, and similarly of its aliquot parts—then the angle NAI, read off by the index at I, will show at once the angle between the incident and finally reflected rays. The mode of using the sextant consists in placing the eye to the telescope or eyelet-hole, and observing one object directly through the unsilvered

new parishes under Church-building Acts; the duty is to keep the church clean, swept and adorned, to open the pews, to make and fill up the graves, and to prevent any disturbance in church. The salary is usually paid by the churchwardens, and as to amount depends on custom. In Scotland he may also be beadle or 'church-officer,' although the latter's duties are usually connected with attendance on the minister.

Sextus Empiricus, physician and philosopher, lived at Alexandria and Athens about 200-250 A.D. As physician he was a representative of the Empirics (hence his second name; see MEDICINE); as philosopher he was the chief exponent of the later Scepticism (q.v.) of the Old World, which was professedly a continuation of Pyrrhonism. In his two works still extant—the *Hypotyposes* and *Adversus Mathematicos*—he has left a prodigious battery of arguments and exceptions against dogmatism in grammar, rhetoric, geometry, arithmetic, music, astrology, logic, physics, ethics. There are monographs by Jourdain (Paris, 1858) and Pappenheim (Berlin, 1875).

Sexual Selection is a term applied by Darwin to the process of favouring and eliminating which to some extent occurs in the mating of many animals. It is a special case of natural selection, depending upon a competition between rival males, in which a premium is set upon those qualities which favour their possessors in securing mates. This competition takes two forms: on the one hand, rival males, for instance stags and gamecocks, fight with one another, and the conquerors have naturally the preference in mating; on the other hand, rival males sometimes seem to vie with one another in displaying their attractive qualities before their desired mates, who, according to Darwin, choose those that please them best.

Darwin gives the following summary of his theory: 'It has been shown that the largest number of vigorous offspring will be reared from the pairing of the strongest and best-formed males, victorious in contests over other males, with the most vigorous and best-nourished females, which are the first to breed in the spring. If such females select the more attractive and, at the same time, vigorous males, they will rear a larger number of offspring than the retarded females, which must pair with the less vigorous and less attractive males. So it will be if the more vigorous males select the more attractive and, at the same time, healthy and vigorous females; and this will especially hold good if the male defends the female, and aids in providing food for the young. The advantage thus gained by the more vigorous pairs in rearing a larger number of offspring has apparently sufficed to render sexual selection efficient.'

Where there is direct competition between males, the weakest will tend to be eliminated, either directly by death or injury in the struggle, or indirectly by diminished success in reproduction. In the same way, if a male be lacking in the qualities necessary to find a mate—e.g. in senses acute enough to find out her whereabouts—that male may remain unproductive. But there is not enough of evidence to enable us to compute how many males do remain unmated in consequence of non-success in competition.

In regard to the second aspect of sexual selection, in which the females are believed to exercise some choice, giving the preference to those suitors which have brighter colours, more graceful forms, sweeter voices, or greater charms of some kind, there is no little difference of opinion. Darwin indeed believed strongly in the female's choice, and referred to this process of selection many of the qualities which distinguish male animals. The females 'have by

a long selection of the more attractive males added to their beauty or other attractive qualities.' 'If any man can in a short time give elegant carriage and beauty to his bantams, according to his standard of beauty, I can see no reason to doubt that female birds, by selecting during thousands of generations the most melodious or beautiful males, according to their standard of beauty, might produce a marked effect.' On the other hand, Alfred Russel Wallace maintains a very different position. 'There is,' he says, 'a total absence of any evidence that the females admire or even notice the display of the males. Among butterflies there is literally not one particle of evidence that the female is influenced by colour or even that she has any power of choice, while there is much direct evidence to the contrary.' Against this, G. W. and E. G. Peckham, in their careful essay on sexual selection in spiders, state that they have in the Attidæ 'conclusive evidence that the females pay close attention to the love dances of the males, and also that they have not only the power, but the will, to exercise a choice among the suitors for their favour.' Some observers of birds are also confident that the females choose the more musical or otherwise attractive males. But again Wallace maintains that the fact that every male bird finds a mate 'would almost or quite neutralise any effect of sexual selection of colour or ornament; since the less highly coloured birds would be at no disadvantage as regards leaving healthy offspring.' In spiders, however, it seems that the more brilliant males may be selected again and again while the mating season lasts.

The theory of sexual selection is of considerable importance in a general theory of evolution. This may be illustrated in reference to the bright plumage of many birds. If we postulate successive crops of variations (which cannot at present be completely rationalised), if we acknowledge that there is really 'preferential mating' among birds (which is not readily proved or disproved), if we believe that the females are sensitive to the slight excellences which distinguish one suitor from another and that their choice of mates is determined by these excellences (which Wallace emphatically denies), then we may say that the greater brightness of male birds may have been evolved by sexual selection. This was Darwin's opinion. The brighter males succeeded better than their rivals in the art of courtship; the variations which gave them success were transmitted to the offspring; gradually the qualities were established and enhanced as secondary sexual characters of the species. But Wallace interpreted the facts quite otherwise. The relatively plain plumage of the female birds was due to natural selection, eliminating those whose conspicuousness during incubation was fatal, fostering those whose colouring was protective. Just as Daines Barrington, a naturalist still remembered as the correspondent of Gilbert White, suggested (1773) that singing-birds were small and hen-birds mute for safety's sake, so Wallace maintained that female birds had forfeited brightness as a ransom for life.

But, leaving the birds, let us take a case which seems to afford better illustration of Darwin's theory of sexual selection—that of spiders. The courtship of these animals has been observed and described by G. W. and E. G. Peckham in a manner so careful that their paper ranks as one of the most important contributions yet made to the theory of sexual selection. 'The fact that in the Attidæ the males vie with each other in making an elaborate display, not only of their grace and agility but also of their beauty, before the females, and that the females, after attentively watching the dances and tournaments which have been executed

for their gratification, select for their mates the males that they find most pleasing, points strongly to the conclusion that the great differences in colour and in ornament between the males and females of these spiders are the result of sexual selection.' It may be that the American observers have, especially in their psychological language, mingled a little imagination with their induction, but they state a strong case for sexual selection.

The conclusions drawn from the courtship of spiders are not affected by Wallace's criticism so seriously as are those which Darwin drew from the courtship of birds, and this suggests that the wisest position is one of compromise, which recognises that in some cases—e.g. spiders—the external divergence of the sexes may depend upon sexual selection, and that in other cases—e.g. birds—it may depend rather upon natural selection.

But even with this compromise it is difficult to rest satisfied. For before we can believe that attractively bright ornaments could become characteristic of males by sexual selection, or that protectively plain colouring could become characteristic of females by natural selection, we must assume that the qualities of brightness can be entailed in inheritance on the males only, and the qualities of plainness on the females only. But this fundamental assumption has not yet been justified by a sufficiently strong body of facts.

This difficulty arouses scepticism as to the thoroughness of the explanations of secondary sexual characters suggested either by Darwin or by Wallace. We are not surprised, therefore, to find Mivart's explanation of the beauty of males as the direct expression of an internal force, or Mantegazza's hints as to a physiological explanation of the sexual divergence, or Brooks's reference to 'something within the animal which determines that the male should lead and the female follow in the evolution of new breeds.' Geddes advanced further, endeavouring to interpret the secondary sexual characters as outcrops of the relative preponderance of anabolism and katabolism characteristic of females and males respectively. Gay colouring—sometimes at least due to pigmented waste products—is regarded as a characteristic expression of the predominantly katabolic or male sex, and quiet plainness is equally natural to the more anabolic females. But this theory, which seeks to rationalise the variations which Darwin simply postulated, is by no means inconsistent with a recognition of sexual selection as an accelerant directive process in the evolution of male brightness, or of natural selection as a retardative directive process eliminating disadvantageously conspicuous females.

Wallace has also in his work on *Darwinism* (1889) worked towards a rational interpretation of the variations which he was previously content to postulate as facts. For he says that 'ornament is the natural outcome and direct product of superabundant health and vigour,' and is 'due to the general laws of growth and development.' It seems to some that this mode of interpreting characters is of far-reaching importance, and that it affects not only the theory of sexual selection but that of natural selection as well.

The Peckhams do indeed deny that male spiders possess greater vital activity than the females, and they find no relation in either sex between activity and development of colour. But it must be noted that a predominant katabolic diathesis—which is, according to Geddes, the fundamental characteristic of maleness—may be true of male spiders though not expressed in greater vital activity.

We must of course be careful to distinguish that the suggestions made by Geddes, Wallace, and others as to the physiological meaning of sexual

characters have to do with primary factors in evolution—i.e. with those which originate variations—while the explanation of the differences in plumage between male and female birds, either by the theory of sexual selection (according to Darwin) or by natural selection (according to Wallace), have to do with secondary factors in evolution—i.e. with those which foster or eliminate variations. Apart from the problem of the origin of the sexual variations the central question with regard to sexual selection by preferential mating is, as Lloyd Morgan says, what guides the variation along special lines leading to heightened beauty. 'Sexual selection by preferential mating involves a standard of taste; that standard has advanced from what we consider a lower to what we consider a higher æsthetic level, not along one line but along many lines. What has guided it along these lines?'

To sum up, the problems involved in sexual selection are (1) what physiological conditions explain the secondary sexual characters which so often distinguish males and females; (2) to what extent and in what degrees of refinement does preferential mating occur; and (3) to what extent has sexual selection guided the differentiation of the sexes alike in distinctive qualities and in æsthetic sensitiveness? Before these problems can be adequately solved many more facts must be accumulated.

See SEX, DARWINIAN THEORY, EVOLUTION; Darwin, *The Descent of Man and Selection in Relation to Sex* (1871); A. R. Wallace, *Contributions to the Theory of Natural Selection* (1871), and *Darwinism* (1889); St George Mivart, *Lessons from Nature* (1876); W. K. Brooks, *The Law of Heredity* (Baltimore, 1883); P. Geddes, article 'Sex,' *Encyclo. Brit.*; P. Geddes and J. A. Thomson, *The Evolution of Sex* (1889); G. W. and E. G. Peckham, *Observations on Sexual Selection in Spiders of the family Attidæ*, *Occas. Papers, Nat. Hist. Soc. Wisconsin* (Milwaukee, 1889); C. Lloyd Morgan, *Animal Life and Intelligence* (1890-91).

Seychelles, a group of islands belonging to Great Britain, and administered by an officer (assisted by an executive council of three members and a legislative council of five) acting under the governor of Mauritius, are situated near the middle of the Indian Ocean, 600 miles N.E. of Madagascar. There are thirty larger islands and numerous smaller ones, their total area being 78 sq. m., of which 59 belong to Mahé, the largest (17 miles broad by 7 long) and most important of them. Next in size and importance come Praslin, Silhouette, La Digne, Curieuse, Bird, Frigate, and Denis. They get their French names from having been first colonised by the French in 1742, though they were known to the early Portuguese navigators. The group was captured from the French by a British ship in 1794, but was not formally ceded by treaty till 1815. The islands are mountainous, and in Mahé reach close upon 3000 feet. Coral-reefs grow round most of the islands, and the coral is used for house-building. The climate, though tropical (range of thermometer 70° to 93° F.), is tempered by the proximity of the sea, and is very healthy. The soil is fertile and vegetation luxuriant. The principal products and exports are the fibres, nuts, and oil of the coconut palm; but maize, manioc, tobacco, coffee, vanilla, cloves and other spices are grown to some extent, and vanilla, cloves, tortoiseshell, soap, and vacoa bags are exported. The exports increased in value from £27,800 in 1884 to £39,260 in 1889. The Coco de Mer (q.v.) is peculiar to Praslin and one or two more of these islands. Gigantic tortoises, and the edible black tortoise, resort to certain islands of the group. The imports, consisting chiefly of cotton, haberdashery, coal, spirits and wine, and provisions, increased from £29,960 in 1884 to

£49,900 in 1889. Victoria, the chief town on Mahé, is an imperial naval coaling station, and is visited by the Messageries Maritimes steamers and by merchant vessels for coal. Pop. of islands (1881) 14,081; (1890) 16,162—chiefly French creoles, Indian coolies, negroes, and British officials. See Horne, *Report on the Seychelles Islands* (1875).

Seymour, a city of Indiana, 88 miles by rail W. of Cincinnati, with manufactures of woollens, flour, staves, spokes, &c. Pop. (1890) 5307.

Seymour, an historic family, originally settled in Normandy at St Maur—whence the name. Coming over to England, they obtained lands in Monmouthshire as early as the 13th century, and in the 14th at Hatch Beauchamp, Somersetshire, by marriage with an heiress of the Beauchamps. In 1497 Sir John Seymour helped to suppress the insurrection of Lord Audley and the Cornish rebels, and subsequently he accompanied Henry VIII. to his wars in France, and to the Field of the Cloth of Gold. His daughter, Jane Seymour (c. 1509-37), became the wife of Henry VIII. and mother of Edward VI.; and his second son, Thomas, created Lord Seymour of Sudeley, became Lord High Admiral of England and the second husband of Henry's widow (Catharine Parr), but ended his life on the scaffold (1549). Sir John's eldest son, Edward, was successively created Viscount Beauchamp, Earl of Hertford, and Duke of Somerset, and as Protector played the leading part in the first half of the reign of Edward VI. (q.v.). The Protector's eldest son by his second marriage, being created by Elizabeth Earl of Hertford, married the Lady Catharine Grey, a grand-niece of Henry VIII., and sister of the unfortunate Lady Jane Grey—a marriage which entailed on him a nine years' imprisonment and a fine of £15,000. His grandson, who in 1621 succeeded him in the earldom of Hertford, also fell into disgrace for attempting to marry the Lady Arabella Stuart, cousin of James I.; but subsequently, playing a conspicuous part in the royalist cause in the Great Rebellion, obtained a reversal of the Protector's attainder, and in 1660 took his seat in the House of Peers as third Duke of Somerset, although the descendants of the first duke, by his first marriage, were then in existence. He died unmarried in 1671, and the ducal title ultimately passed to a cousin, on whose death it was inherited by Charles Seymour (1661-1748), known in history as the 'Proud Duke of Somerset,' a nobleman whose style of living was ostentatious and haughty in the extreme, and who filled several high posts in the courts of Charles II., William III., and Anne. He married the heiress of the Percies, by whom he had a son, Algernon, seventh duke, who in 1749 was created Earl of Northumberland, with remainder to his son-in-law, Sir Hugh Smithson, the ancestor of the present Percy line. On the death of this duke in 1750 a curious peerage case arose, the title being claimed by the descendants of the first duke by his first marriage; and the attorney-general having reported in favour of the claim, Sir Edward Seymour took his seat in the House of Peers as eighth duke. The earldom of Hertford, which became extinct in 1750, was in that same year conferred on this eighth duke's first cousin, Francis, who in 1793 was advanced to the dignity of Marquis, and one of whose great-grandsons, Sir Frederick Beauchamp Paget Seymour, admiral R.N., was in 1882 created Baron Alcester for his services at the bombardment of Alexandria.

Seyne, LA, a seaport of France (dept. Var), on the Mediterranean, 3 miles SW. of Toulon. Here are fine shipbuilding-yards, employing 2000 men, and a spacious harbour. Pop. 9340.

Sezze (anc. *Setia*), a city of Italy, situated immediately north of the Pontine marshes and 40 miles SE. of Rome, has a Gothic cathedral and ruins of a great temple to Saturn, an amphitheatre, &c. Pop. 6114.

Sfax, the second port in the regency of Tunis, is situated on the Gulf of Gabes, 150 miles S. by E. of the town of Tunis, and is surrounded by gardens and suburban villas. The Mohammedans, the Europeans, and the Jews each live in separate quarters; the French camp forms a fourth division. There is an active trade in dates, olive-oil, esparto grass, wool, fruits, sponges, &c., the port being entered by 1100 to 1600 vessels of 224,000 to 237,000 tons annually. Large quantities of fruit are grown, and cottons, woollens, and silks are manufactured. Pop. 30,000. The town was bombarded by the French in 1881, the opposition here being fierce and fanatical.

Sforza, a celebrated Italian family during the 15th and 16th centuries, the founder of which was a peasant of Cotignola, in the Romagna, by name Muzio Attendolo (1369-1424), who from a wood-cutter became a great *condottiere* and received from Count Alberigo de Barbiano the name of Sforza ('Stormer'—i.e. of cities). He speedily found himself the independent leader of a band of condottieri, and as constable to Queen Joanna II. was one of the main supports of the kingdom of Naples. His natural son, FRANCESCO SFORZA, then twenty-three, succeeded, and, as was the custom of the time, sold his sword to the highest bidder, fighting without the slightest scruple for or against the pope, Milan, Venice, and Florence. He invented an improved system of tactics, and it soon came to be taken for granted that victory was certain for the party which he supported. It was thus no great act of condescension in the Duke of Milan, the haughty Visconti, to confer upon him the hand of his only child Bianca and the succession to the duchy. Meantime Sforza took the march of Ancona from the pope (1434), added to it Pesaro (1443), and by a judicious combination of force and stratagem obtained his elevation to the dukedom of Milan (1450) after the decease of his father-in-law. He firmly established his authority over all Lombardy and several districts south of the Po, acquired the esteem of Louis XI., who gave up to him Savona and Genoa, and, after gaining the universal love of his subjects, died 8th March 1466. Though uninstructed he loved and protected letters. Unhappily his successors possessed neither his virtues nor his talents. His son, GALEAZZO MARIA SFORZA (1466-76), was a tyrant and a monster of debauchery, prodigality, and ferocity, without a single redeeming feature in his character. He was assassinated at the porch of the cathedral of Milan. His son GIOVANNI-GALEAZZO SFORZA (1476-94) succeeded, under the regency of his mother, Bona of Savoy, who held the reins of government with a firm hand. But she was forced to give up (1480) her able coadjutor Simonetta to the vengeance of her brother-in-law, Lodovico Maria, surnamed 'the Moor' from his dark complexion; and three days after Simonetta's execution the ambitious Lodovico banished her, and assumed the regency. Finding the young duke in his way, Lodovico put him and his wife, Isabella of Calabria, in prison, and was immediately threatened with attack by the king of Naples, a danger which he attempted to ward off by giving his daughter Bianca, with a dowry of 400,000 ducats, to the Emperor Maximilian I. and by stirring up Charles VIII. of France to assert his claims to Naples. Soon afterwards Duke Giovanni-Galeazzo died, poisoned, as some believe, by his uncle, 20th October 1494. LODOVICO-MARIA (1494-1500)

obtained his investiture as duke, and becoming alarmed at the rapid progress of the French in Italy he joined the league against them, and was rewarded for his perfidy by being driven from his duchy, which was seized by the troops of Louis XII. (1499). The following year he made an ineffectual attempt to regain possession, was made prisoner, and carried to France, where he died in 1510. Of great talents, but low morality, he valued astuteness more than everything else; yet his encouragement of letters and of the fine arts has preserved his name to posterity. His eldest son, MASSIMILIANO SPORZA (1512-15), regained the duchy of Milan after the reverses suffered by Louis XII., and with the aid of the Swiss steadily repulsed the various energetic attempts of the French to recover it; but after the battle of Marignano (1515) he abandoned his rights to the French for a pension of 30,000 ducats, glad to be free from the insolence and exactions of his allies and the attacks of his enemies. His brother FRANCESCO-MARIA SPORZA succeeded nominally to the Milanese after the battle of Pavia, but he was a mere puppet in the hands of Charles V., and on his death, 24th October 1535, and the extinction of the main line of the House of Sforza, the duchy was quietly swallowed up by Austria. The Dukes of Sforza-Cesarini descend from collateral branches of the family. See Ratti, *Della Famiglia Sforza* (1794).

Sgraffito, or SCRATCHED WORK, is the name given to a mode of external wall-decoration practised in Italy, and of which examples have been found in Pozzuoli near Naples, of the date of about 200 B.C. The process is accomplished by means of superimposed layers of plaster applied and operated upon in the following manner. First, the wall having been thoroughly moistened to ensure adhesion, a $\frac{3}{4}$ -inch coat of plaster is floated on, and before it is perfectly dry a $\frac{1}{4}$ -inch skin of black, red, or any other coloured plaster that will not fade is applied; when this is set and while it is still wet, a finishing coat of white plaster is added. A full-sized drawing of the design that is to be realised is then transferred to this outer coating, and the outline cut through to the second coat with a sharp instrument, and made broad or narrow according to the effect desired, and where necessary these incisions are enforced by additional lines as shading. The process is an economical mode of obtaining effect, but like 'fresco' requires to be executed while the material is moist, and therefore no more should be prepared than can be immediately operated upon. Examples of the system are to be found in the choir boys' school of St Paul's Cathedral, the inner court of the Science Schools at South Kensington, some private residences, and the interiors of some churches in England. The application of this principle of decoration is not confined to plaster, but extends also to superimposed metals and to pottery. There are 15th-century specimens of sgraffito pottery in the South Kensington Museum. The examples of house-decoration in Italy are of the 15th, 16th, and 17th centuries.

Shad (*Alosa* or *Aloa*), a genus of fishes of the family Clupeidae, differing from Clupea (the Herring, &c.) in having the upper jaw deeply notched. The teeth are very small, on the jaws only, and often wanting, at least in the adult fish. The species are numerous, inhabiting the sea, but ascending rivers to spawn. The eggs are small, heavy, and non-adhesive; but they are not buried, like those of the salmon, in the gravel of the river bottom. Shad are very like herrings in form and appearance, and on this account and their large size the British species receive from Scottish

fishermen the name of *King of the Herrings*. The herrings of extraordinary size of which the capture is sometimes reported are probably always shad. The Common Shad or Alice Shad (*A. communis*) is rather thicker and deeper in proportion to its length than the herring. It is found on the British coasts and in the lower part of some of

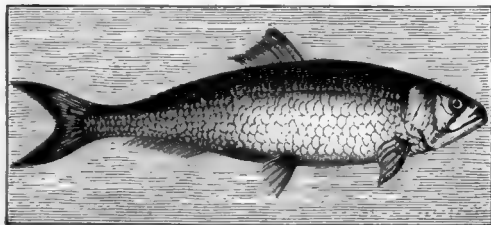

Common Shad (*Alosa communis*).

the large rivers, more abundantly in the Severn than in any other British river. It attains a length of two or even three feet and a weight of from four to eight pounds. It has no teeth. There is a single black spot behind the gills. Its flesh is of good flavour. The Twaite Shad (*A. finta*) is more plentiful on the British coasts, and is the common shad of the Thames, but the foul state of the river has now made it of very rare occurrence above London. It is smaller than the Alice shad, seldom exceeding 16 inches in length; there are small teeth in both jaws, and a row of dusky spots along each side of the body. The flesh is coarser and less esteemed than that of the Alice shad, but much used for food wherever the fish is plentiful. This species spawns later in the year than the last, and in order to permit it to deposit its spawn its capture in the Thames is prohibited after the end of June. It abounds in many of the rivers of France and other parts of Europe. A species of shad (*Alosa sapidissima*), generally weighing about four or five pounds, but sometimes twelve pounds, is very abundant during some months of the year in some of the North American rivers, as the Hudson, Delaware, Susquehanna, and St Lawrence, and is now bred successfully and in immense numbers in the United States piscicultural establishments.

Shaddock (*Citrus decumanus*; see CITRUS), a tree, which, like the other species of the same genus, is a native of the East Indies, and which has long been cultivated in the south of Europe. It is said to derive its English name from a Captain Shaddock, by whom it was introduced from China into the West Indies about 1810. It is readily distinguished from most of its congeners by its large leaves and broad-winged leaf-stalk; it has very large white flowers, and the fruit is also very large, sometimes weighing ten or even fourteen pounds, roundish, pale yellow; the rind thick, white and spongy within, bitter; the pulp greenish and watery, subacid, and subaromatic. It is a pleasant, cooling fruit, and much used for preserves. The tree is rather more tender than the orange, but with proper care is often made to produce fine fruit in orangeries in Britain. Finer and smaller than the Shaddock proper is the Pomelo (also called Pummelo, Pompelmoose, and Grape-fruit), a variety rather larger than an orange which bears its fruit in clusters. Both varieties are grown in Florida, and the pomelo is exported thence to the northern states.

Shadows, as ordinarily understood, are the result of the interception of rays of light by opaque or semi-opaque substances. Close inspection of

any shadow, whether cast by the sun or by an artificial light, shows that its margin is not clear cut. This is chiefly due to the fact that the source of light has a finite size. There must consequently exist certain regions from which the source of light appears to be only partially screened. In these regions the shadow is partial; whereas in regions from which the source of light is wholly screened by the intercepting substance, the shadow is complete. Other forms of radiant energy may be intercepted, and corresponding shadows cast. Take, for example, sound. To appreciate the existence of sound shadows we must ourselves get within the shadow, that is, we must set ourselves so that a large obstacle intervenes between us and the source of sound. In such circumstances the intensity of the sound becomes very much diminished. The deadening effect of an ordinary wall upon a sound originating at the farther side is a familiar illustration. In electrical radiations shadows also may exist, and may be made evident by suitable means. It should be remembered, however, that a substance which is opaque to one kind of radiation is not necessarily opaque to another. A stone wall is opaque to light, but is not opaque to electrical radiations of a certain kind. Again, rock-salt and glass cast no very apparent light shadows; but with radiant heat glass casts a distinct shadow, while rock-salt casts little or none. See HEAT, and LIGHT; also ECLIPSES.

Shadwell, THOMAS, a dramatic writer of some note in his day, though now only remembered as the 'MacFlecknoe' of Dryden's satire, was born in 1640 in Norfolk. He was educated for the law, but not finding it a pursuit to his mind he deserted it, and after an interval of foreign travel betook himself seriously to literature. His first comedy of *The Sullen Lovers* (1668) had great success, and he continued from year to year to entertain the town with a succession of similar pieces, a complete edition of which was published in four volumes (1720). The immortality which these must have failed to achieve for him he was fated to attain in another way. With Dryden he seems at first to have been on terms of friendly intimacy, and indeed the great poet contributed the prologue to his *True Widow*; but when Dryden flung his *Absalom and Achitophel* and *The Medal* into the cause of the court Shadwell was rash enough to make a gross attack upon him in the *Medal of John Bayes*. Dryden heaped deathless ridicule upon his antagonist in the stinging satire of *MacFlecknoe* and as 'Og' in the second part of *Absalom and Achitophel*. Though his works, hasty and careless as they are, exhibit lively talent and considerable comic force, all that the reading world now knows of Shadwell is that 'Shadwell never deviates into sense.' It was some consolation to succeed his enemy in the laureateship, which in 1688 it became necessary for Dryden to resign. He did not survive long to enjoy it, however, as in 1692 he died—of an overdose of laudanum, it is said. See FLECKNOE.

Shafites, the name of one of the four principal sects of the Sunnites (q.v.), or 'orthodox' Muslims. Its name is received from its founder, Abu Abdallah Mohammed Ibn Idris, called Al-Shāfiī, from one of his ancestors who descended from Mohammed's grandfather, Abdul Muttalib.

Shaft. See COLUMN.

Shaftesbury (locally *Shaston*), a very ancient municipal borough in Dorsetshire, 3 miles SSW. of Semley station and 22 WSW. of Salisbury. It stands on a narrow chalk ridge, and commands magnificent views over Dorset-, Somerset-, and Wiltshires. The *Caer Palladur* of the Britons, it

was made by King Alfred the seat of a famous abbey of Benedictine nuns (880), whither Edward the Martyr's body was translated in 980, and where Canute died, 1035. At the date of Domesday Shaftesbury had three mints and twelve churches, but four only remain—St Peter's (Norman) the most interesting. Till 1832 Shaftesbury returned two members, and then till 1885 one. Pop. (1851) 2493; (1891) 2122. See Mayo's *Municipal Records of Shaftesbury* (Sherborne, 1891).

Shaftesbury, ANTHONY ASHLEY COOPER, EARL OF, was born on 22d July 1621, at Wimborne St Giles in Dorsetshire, the seat of his mother's father, Sir Anthony Ashley (1551-1628), a clerk of the Privy-council. He was the elder son of John Cooper of Rockborne in Hampshire, who next year was created a baronet. His mother died in 1628, his father in 1631; and though he ultimately came into over £6000 a year, his estate was then torn and rent from him by unjust kinsmen to the tune, he tells us, of £20,000. His boyhood was mostly spent at Cashibury in Herts, Southwick in Hampshire, and Maddington in Wilts; till at sixteen, having had three tutors, he went up as a gentleman commoner to Exeter College, Oxford, where he 'not only obtained the good-will of the wiser and elder sort, but became the leader even of all the rough young men.' He left without a degree, and in February 1639 married Margaret, daughter of the Lord Keeper Coventry. She died, sore lamented by him, in 1649; and nine months later he married Lady Frances Cecil, the Earl of Exeter's sister, who also dying in 1654, in 1655 he married pious Margaret Spencer, the Earl of Sunderland's sister, who survived him till 1693. Only two sons were born to him, both by his second wife, and one of them died in childhood; but by all three marriages he largely strengthened his family connections.

Meanwhile in 1640 he had entered the Short Parliament for Tewkesbury, but he had not a seat in the Long. A royalist colonel (1643), after ten months' service he went over to the parliament, either from pique or from 'the dictates of a good conscience,' and for nine months more commanded their forces in Dorsetshire, then from 1645 to 1652 lived as a great country gentleman. In 1653 he entered Barebone's parliament, and was appointed one of Cromwell's council of state, but from 1655 he was in opposition, and in 1677 we find him claiming to have 'had the honour to have a principal hand in the Restoration.' He was one of the twelve commissioners sent to Breda to invite Charles II. home, and on the way thither met with the carriage accident which caused him a lifelong internal abscess, but which also in 1666 secured him a lifelong friend in an Oxford student of medicine, John Locke.

For his services he was made a privy-councillor (1660), and next year Baron Ashley and Chancellor of the Exchequer. He served on the trial of the Regicides; proved a diligent minister; supported the war with Holland; and after Clarendon's fall (1667), in which he had no direct share, sided with Buckingham, with whom he formed one of the infamous Cabal, and like whom he was fooled as to the Catholic clauses in the secret treaty of Dover (1669-70). He seems to have opposed the 'stop of the exchequer' (1672), which yet he justified; that same year was made Earl of Shaftesbury and Lord Chancellor (he proved a most upright judge); but in 1673, suddenly espousing the popular Protestantism, supported the Test Bill, which broke up the Cabal.

On 9th October, the Great Seal being demanded of him, he uttered one of his memorable sayings, 'It is only laying down my gown, and putting on my sword;' and, the bribe and the dukedom

rejected that were designed to purchase his submission, he ranged himself against Danby as a champion of toleration, but for Dissenters only, and figured thenceforth as a defender of national liberties, or rather, it may be, as an unscrupulous demagogue. He opposed Danby's non-resistance Test Bill (1675), and in February 1677, for his daring protest against a fifteen months' prorogation, was sent to the Tower, whence he was only released a year later on making a full submission. As early as 1674 he had feigned apprehensions of a popish massacre; and though the 'Popish Plot' was not of his forging, but Oates's, he it was that passed the base coin, using that two years' terror (1678-80) against his opponents with a ruthless dexterity that must stamp him for ever with infamy. Not even the Habeas Corpus Act (q.v.), long known as Shaftesbury's Act, is a set off against the judicial murder of Lord Stafford, his personal enemy. Still, for a while he seemed to have completely triumphed. The fall of his rival Danby was followed by his own appointment as president of Temple's new Privy-council of thirty members (April 1679), and James's dismissal to Holland by an attempt to exclude him from the succession, in favour, not of William and Mary, but of Shaftesbury's puppet, the bastard Monmouth. That monstrous proposal gave Charles II. his chance, and in October 'Little Sincerity' (as he had nicknamed Shaftesbury) received his congé; and Shaftesbury from that time onward was driven into extreme opposition, indicting James as a recusant (1680), and bringing armed followers to the Oxford parliament (1681). In the July of that year he was again sent to the Tower, on a charge this time of high-treason, and though the Middlesex Whig grand jury threw out the bill in November, and he was consequently released, arrest was again impending, with no such chance of escape. Monmouth and Russell hung back from the open rebellion to which he promised to furnish 'ten thousand brisk City boys,' and, after some weeks' hiding, he fled to Holland early in December 1682. 'Delenda est Carthago' he had quoted against the republic ten years before; 'Carthago nondum deleta' greeted him now when he landed. On 22d January 1683 the 'fiery spirit' passed away at Amsterdam, whence the 'pigmy body' was borne home for burial in the place that had given him birth.

Transcendently clever, eloquent, and winning, fairly void too of lust and venality when most men were lustful and venal, Shaftesbury yet stands condemned by the many talents committed to him. He, who might have done so much good, did so little but what was evil. Whether for or against monarchy, for or against republicanism, for or against France, for or against Holland, he was always for himself—self the dominant principle to which alone he was true. At least, if that count for praise, he was the author of party government, ever ready to make capital out of religious animosities, 'atrocities,' perjuries, forgeries, anything. After all that has been written, men seem in doubt still whether Shaftesbury was the 'pure,' 'high-minded,' and 'great statesman' that Mr Christie would make him, or, what Charles pronounced him, 'the wickedest dog in England.' ('I believe, Sir, I am, of a subject—one remembers his witty rejoinder.) Whether, again, was he a deist; and here again we have the well-known story, how one day he said to a friend, 'Men of sense are all of one religion.' 'And what religion is that?' a lady broke in; to whom, turning and bowing, he answered, 'That, madam, men of sense never tell.'

See Dryden's *Abalom and Achitophel and Medal* (1681); part iii. of Butler's *Hudibras* (1678); the

hostile *History of Burnet*, who is the chief authority for Shaftesbury's 'dotage of astrology'; the able apologetic *Life* by W. D. Christie (2 vols. 1871); the shorter, less partial study by Mr H. D. Traill in the 'English Worthies' series (1886); the article by Mr Osmond Airy in vol. xii. of the *Dictionary of National Biography* (1887); and other works cited at LOCKE and CHARLES II.

ANTHONY ASHLEY COOPER, third Earl of Shaftesbury, philosopher, was born at Exeter House, London, February 26, 1671, the grandson of the above, and son of that 'shapeless lump,' the second earl (1652-99), by Lady Dorothy Manners, daughter of the Earl of Rutland. Locke superintended his education at Clapham under a learned governess, Mistress Elizabeth Birch, who taught him to speak Greek and Latin fluently; three years at Winchester (1683-86) were not happy ones, for his schoolfellows visited on him the sins of his grandfather. With a tutor and two other lads he then travelled for three years more in Italy, Germany, and France, and on his return applied himself to study. A zealous Whig, he sat for Poole (1695-98), but ill-health compelled him to turn from politics to literature; and there is little to record in his life beyond two visits of a twelve-month each to Holland (1698-99, 1703-4), where he lived with the Quaker, Benjamin Furly, and formed friendships with Bayle and Le Clerc; his accession to the earldom (1699); his marriage (1709) to Miss Jane Ewer of Lee, for 'the satisfaction of his friends,' but to his own subsequent contentment; his removal to Naples (1711); and his death there on February 15 (4 o.s.), 1713.

His somewhat superfluous writings (Lamb hits off their style as 'genteel') were all, with a single exception, published after 1708, and were mostly collected as *Characteristics of Men, Manners, Opinions, Times* (3 vols. 1711; 2d enlarged ed. 1714). Here the 'moral realist' expounds his system, which Pope has immortalised in the *Essay on Man*, and which Mr Hunt reduces to the three main contentions, that ridicule is the test of truth, that man possesses a moral sense, and that everything in the world is for the best. An opponent of Locke, and a disciple of the 'Cambridge Platonists,' Shaftesbury found a follower in Hutcheson (q.v.), the founder of the Scottish school of philosophy. Still, like most prophets, he has had least honour in his own country, for, while there he was more attacked as a deist than praised as a philosopher, on the Continent he has attracted the attention, and generally the admiring attention, of thinkers like Leibnitz, Voltaire (who, however, ridicules his optimism in *Candide*), Lessing, Diderot, Mendelssohn, and Herder.

See Professor Fowler's *Shaftesbury and Hutcheson* ('English Philosophers' series, 1882); Hunt's *Religious Thought in England* (1870-73; new ed. 1884); Leslie Stephen's *English Thought in the Eighteenth Century* (1876); and two German monographs by Spicker (Freiburg, 1872) and Gizycki (Leip. 1875).

ANTHONY ASHLEY COOPER, seventh Earl of Shaftesbury, was born in London, 28th April 1801. From the early training of a faithful old servant, Maria Millis, the future philanthropist received his earliest and deepest religious impressions. He went to Harrow in his twelfth year, and to Christ Church, Oxford, in 1819, and took a first-class in classics in 1822, his M.A. degree in 1832; and he was made D.C.L. in 1841. As Lord Ashley he represented Woodstock in parliament from 1826 to 1830; and joining the Conservatives, then led by Lord Liverpool and Canning, he formed a close friendship with the Duke of Wellington, under whom he obtained the post of Commissioner of the India Board of Control (1828). Under Peel he was made a Lord of the Admiralty in 1834. In 1830 he married Emily, daughter of the fifth Earl Cowper

(so that he was thus a connection by marriage of Lord Palmerston); by her he had six sons and four daughters. He represented Dorchester (1830-31), Dorset (1833-46), and Bath from 1847 to 1851, when he succeeded his father as earl. Among his earliest efforts at philanthropic reform was the promotion of two bills for the Regulation of Lunatic Asylums and for the better Treatment of Lunatics (1845), which have been called the Magna Charta of the liberties of the insane. He acted as chairman of the Lunacy Commission from 1828 till his death, a period of fifty-seven years. He took much interest in the passing of an act (1840) to prevent the employment of boy chimney-sweeps. He worked unweariedly for fourteen years on behalf of a bill limiting the hours of labour of women and young persons to ten hours a day, but it was 1847 ere a Ten Hours' Bill was passed, when it so happened he was out of parliament. He would not join Sir R. Peel's administration in 1841, because that statesman refused to countenance the Ten Hours' Bill; but in 1846 he supported Peel in his proposal to repeal the Corn Laws, an action which cost him his seat for Dorsetshire. A speech in connection with his Mines and Collieries Bill (1842) was considered his greatest effort. In 1842 was passed an act for abolishing the apprenticeship in mines, and excluding women and boys under thirteen from working underground; a Printworks Act was passed in 1845; and he was chairman of the Commission of Inquiry which resulted in the passing of the Factory Acts Extension Act (1867) and the Workshop Regulation Act (1867; consolidated 1878). In 1843 he joined the Ragged School movement. Relinquishing society and all amusements, he gave the remainder of his life to other beneficent schemes, and his time and strength were exhausted by letters, interviews, chairmanships, and speeches. To mention all the religious and benevolent societies in which he was interested would be to name the most prominent and useful agencies for good of the present day. Peabody's scheme for bettering the house accommodation of industrial London sprang from Shaftesbury's efforts in the same direction. He was the adviser of Lord Palmerston in many important church appointments, and was consulted by the Queen and Prince Consort. The freedom of Edinburgh was conferred upon him in 1878, and of London in 1884. Active and vigorous to the last, he died at Folkestone, October 1, 1885. Although not a great orator, he spoke with neatness, force, and precision. In religious matters he was an out-and-out evangelical, and strenuously opposed ritualism, rationalism, and socialism when divorced from Christianity.

See his *Speeches*, with introduction by himself (1868), and Hodder's *Life and Work of the Earl of Shaftesbury* (3 vols. 1886).

Shag. See CORMORANT.

Shagreen. This term is applied to the skins of sharks, rays, and other fish included in the order Selachia, whether they are artificially prepared or not. These skins are furnished with a covering of small nodules or grains of dentine, which is of a hard nature and resists wear of the surface better than ordinary leather. In the shagreen used by cabinet-makers for smoothing wood, the grains or papillæ are sharp-pointed and closely set, but in the case of the skins of allied species these grains are comparatively flat and of different outlines. Such skins, when prepared like parchment, dyed and smoothed, present an attractive appearance, and are used for covering small caskets, boxes, cigar cases, spectacle cases, and similar articles. Shagreen was formerly a good deal employed for covering also watch cases, instrument cases, &c. The name shagreen (Persian *sāghri*, meaning the back

of a beast of burden) is also, and perhaps was originally, applied to the skins or to portions of the skins of horses, asses, and other animals prepared by unhairing and scraping them. Each piece is then stretched on a frame, and while they are still moist the seeds of a species of *Chenopodium* are sprinkled on the surface and forced in by means of the feet or of a press. The skin is then left to dry, and when the seeds are beaten out it has a pitted appearance. It is next pared down with a knife nearly to the bottom of these depressions, after which it is macerated in water till the pits swell and give the skin a pimpled appearance resembling that of a shark. A steeping in a warm solution of soda and afterwards in brine completes the dressing, and it can then be dyed. The covers of old Persian manuscripts are made of this shagreen, which is also used for horse-trappings and shoes in the East. Wood has been embossed by a process somewhat similar to the way leather shagreen is made. See EMBOSING.

Shāh (Persian, 'king,' 'monarch,' 'prince'), the general title of the supreme ruler in Persia, Afghanistan, and other countries of southern and central Asia. The sovereign, however, may, and outside of Persia frequently does, decline the title, assuming in its place that of Khān (q.v.), an inferior and more common appellation. The same title can also be assumed by the shah's sons, and upon all the princes of the blood the cognomen Shāh-zāda ('king's son') is bestowed.—For Shahpur, see PERSIA, Vol. VIII. p. 67; for Shah Soojah, see AFGHANISTAN.

Shahabad, a town of Oude, 80 miles NW. of Lucknow by rail, with a pop. of 18,510—only a third of what it was in the 16th century. In 1868 there was a savage riot here between Hindus and Mussulmans at the Moharram festival.

Shahjahanpur, a town of British India, in the North-west Provinces, stands 100 miles by rail NW. from Lucknow. It takes its name from Shah-Jehan, in whose reign it was founded in 1647. It was a hot-bed of rebellion during the Mutiny of 1857-58. Sugar is made and exported. Pop. (1890) 77,690.—The *district* has an area of 1745 sq. m. and a pop. of 856,946.

Shah-Jehan, the fifth of the Mogul emperors of Delhi, was during his father's reign employed in military expeditions against the Rajputs, the independent Mohammedan states of the Deccan, and the Afghan tribes around Kandahar. From 1623 he was in revolt against the Emperor Jahangir, his father, and was still unreconciled at the latter's death in 1627, when he was at once saluted as emperor by the nobles. The chief events of his reign were the war against the Deccan sovereigns, which resulted in the complete destruction of the kingdom of Ahmadnagar (1636), and the subjugation (1636) of those of Bijapur and Golconda; an indecisive contest against the Uzbeks of Balkh (1645-47); attempts to recover Kandahar from the Persians (1637, 1647-53), which, however, was finally lost; and a second successful war, conducted by his son Aurungzebe, against the Deccan princes (1655). But in 1658 the emperor fell dangerously ill, and his sons commenced to dispute regarding the succession. Ultimately Shah-Jehan was taken prisoner by Aurungzebe, and confined in the citadel of Agra till his death, December 1666. This emperor administered strict justice, and was an able and capable ruler, and a clever financier. The magnificence of his court was unequalled; the splendid 'peacock throne' was constructed by his orders at a cost of nearly £7,000,000, and many magnificent public buildings executed under his direction remain as monuments of his greatness. Chief of these are the superb Taj Mahal and

the lovely 'pearl mosque' at Agra (q.v.), and the palace and great mosque at Delhi (q.v.).

Shah Nameh. See FIRDAUS.

Shaikh-Othman. See ADEN, and FALCONER (ION KEITH).

Shairp, JOHN CAMPBELL, one of the Shairps of Houston, Linlithgowshire, was born 30th July 1819. He was educated at the Edinburgh Academy and Glasgow University, whence he went as Snell Exhibitioner to Oxford. There he gained the Newdigate prize for an English poem upon Charles XII., and graduated with second class honours in 1844. From 1846 to 1857 he was a master at Rugby. From Rugby he went to St Andrews as deputy-professor of Latin. In 1861 he succeeded to the Latin chair, and in 1868, upon the death of Forbes, to the principalship of the United College. In 1877 he was appointed professor of Poetry at Oxford, and reappointed in 1882. He died 18th September 1885.

Shairp was an ideal Scotsman, but with a strong appreciation of English life and thought. His patriotism was almost phenomenal. A summer spent out of Scotland he considered wasted. He explored its loneliest spots and revelled in all its historical associations. The haunts of Jacobites and of Covenanters alike fascinated him, and there are few better companions in the Borderland and the Highlands than his sketches and poems.

His character and thought were moulded by home surroundings, by love of nature and of Wordsworth (his favourite author), by life at Oxford, and by Coleridge, Scott, Keble, Newman, and Erskine of Linlathen. He found the routine work of teaching somewhat irksome, but as a professor he was suggestive, stimulating, and sympathetic. Few have enjoyed the friendship and esteem of so many distinguished men. His singularly lovable and transparent nature, his sense of duty and loftiness of aim, and his sterling unobtrusive Christian principles impressed such men as Norman Macleod, Clough, Matthew Arnold, Lord Coleridge, Archbishop Benson, Professor Veitch, Dr. John Brown, and Dean Stanley more than all his writings. It is by these, however, that his name will live. They reveal rare poetic instincts, and a keen, though kindly, critical faculty. They aim at promoting high thoughts, at quickening love of nature, at increasing interest in history, literature, and philosophy, and at suggesting at least clues to some of the deeper mysteries of life and religion. His own interest in these subjects is healthily infectious. His prose is clear, simple, and vigorous; his poetry fresh and natural, with a true ring in the lowland Scotch.

His principal works are *Kilmahoe* (1864), *Studies in Poetry and Philosophy* (1868), *Culture and Religion* (1870), *The Poetic Interpretation of Nature* (1877), *Burns* (1879), *Aspects of Poetry* (1881), *Glen Desseray* (1886), and *Sketches in History and Poetry* (1887). See Prof. Knight's *Principal Shairp and his Friends* (1888).

Shakers, the name first applied in derision to the self-styled 'United Society of Believers in Christ's Second Appearing,' a small sect which had its origin in England about the middle of the 18th century. The first leaders of this sect were James Wardlaw, a tailor, and Jane, his wife, the latter claiming to have special spiritual illumination, and to have 'received a call' to go forth and testify for the truth; she proclaimed that the end of all things was at hand, that Christ was coming to reign upon the earth, and that his second appearance would be in the form of a woman, as prefigured in the Psalms. She still adhered to many of the tenets of the Society of Friends, of which she and her husband were

members, and preached against war, slavery, profane swearing, and the taking of the legal oath. Among her followers was one Ann Lee, an uneducated girl of poor parentage, of a highly nervous organisation, a strong will, and ambitiously fond of power, who, professing to have received a spiritual baptism, with a command to go forth and preach this new gospel, began to preach in Toad Lane and the adjacent streets of Manchester. She acquired great power over her hearers, who believed in her as one filled with the Holy Ghost, and speaking with the voice of God. The preaching in the streets, accompanied with shouting, speaking of tongues, and other physical manifestations, excited much public hostility, in consequence of which James and Jane Wardlaw, Ann Lee, and her parents were fined and imprisoned in the Old Bailey Prison in Manchester upon a charge of obstructing the streets and violating the Sabbath. A professed experience of Ann Lee while in prison, in which the Lord Jesus appeared before her and became one with her in form and person, led her to be recognised by Jane Wardlaw and her followers as the female Christ—the Bride of the Lamb—in whose person Christ had come to reign upon the earth. She was henceforth styled 'Mother Ann,' and has since been recognised as the 'Head' of this new order. Her claim to be the female Christ excited only ridicule among her neighbours; hence another special revelation—that the foundations of Christ's kingdom were to be laid in America. In the following year, accompanied by her husband and five of the most prominent members of the society—four men and one woman—she emigrated to America, and settled at Niskayuna, 7 miles from Albany, New York, now Watervliet, distinguished as the parent Shaker settlement in America. Here, in their wilderness home, 'Mother Ann' established absolute community of property, the sacred duty of labour, and enforced upon her followers celibacy, which she had previously taught as becoming to 'Believers,' teaching them that no form of love could be allowed in the Redeemer's kingdom, and that men called into grace must live as the angels, with whom 'there is no marrying nor giving in marriage.' Her husband, Mr Stanley, a blacksmith, to whom she had been married in early life, and by whom she had had four children, all of whom had died in infancy, now left her; but believing herself the 'Bride of the Lamb,' she was not daunted either in purpose or faith.

Early in 1780 Joseph Meacham, a Baptist preacher, and Lucy Wright were sent from New Lebanon to Niskayuna, to seek new light, as to the way of salvation. They had both been greatly exercised in the religious revival, accompanied by physical manifestations not understood by the clergy, which had occurred the previous year in Albany and adjacent districts, and now, satisfied that in this new order they had found the key to their religious experiences, became believers in Ann Lee. The first converts to Shakerism in America, they returned home and founded a Shaker settlement at New Lebanon which still exists. The denunciations of Ann Lee against war, and her refusal to take the colonial oath, caused her to be suspected as a British spy, and as such she was for several months imprisoned at Poughkeepsie. In the spring of 1781 she started upon a missionary tour throughout the colonies, which she continued until the autumn of 1783, making a goodly number of converts and laying the foundation of future Shaker settlements. In the autumn of 1784 she died at Watervliet, having previously made over the 'headship' of the society to Joseph Meacham and Lucy Wright as representatives of the dual rule of

God, through the male and female Christ, conferring upon Lucy Wright the title of 'Mother Lucy.' Her death was a great shock to her followers, many of whom believed that she was to live in the physical form for ever upon the earth among her people. Her successors, however, taught them that like the male Christ she had cast off her dress of flesh, and withdrawn from worldly sight, but still lived among her people, visible to eyes exalted by the gift of spiritual sight. So all the saints would remain after death near and be in 'union' with the visible body of Believers, becoming their spiritual teachers. This was accepted as a new and divine revelation, and still is a vital part of the Shaker religion. Under the ministrations of Joseph Meacham and Lucy Wright ten Shaker settlements were formed and an organisation of these settlements effected, bound together by a covenant, recognising the duality of God, the divine mission of Ann Lee as the female Christ, the sacred duty of celibacy, labour, and community of property, and appointing elders and deacons of both sexes for the government of their temporal and spiritual affairs. Joseph Meacham died in 1796, after which for twenty-five years, and until her death, 'Mother Lucy' ruled as the sole head of this new order, discontinuing the title of 'Mother' for the female head of the order at her death, and appointing a successor with the title of 'Elderess,' which title is still given to the female head of the church.

According to the 1890 census there are fifteen Shaker settlements in the United States, three each in Massachusetts and Ohio, two each in New York, New Hampshire, Maine, and Kentucky, and one in Connecticut. They have ten edifices, valued at \$36,800, with a seating capacity of 5650. There are 1728 members, a reduction of nearly one-third since 1870. The value of their communistic property is about ten millions. They are the oldest communistic order in the United States, and by their success demonstrate the possibility—for a time at least—of communistic life. They have two classes of members—the 'Probationers' and 'Covenantors'; the former practically adopt the Shaker doctrines, but retain control over their own property, or, if they have given it to the community, may at any time resume control of it without interest; the latter consecrate themselves and their property to the society, never to be reclaimed by them or their legal heirs. All full members have equal rights in the community, without regard to the property consecrated, only that it is their all. Each Shaker settlement is divided into families, each family consisting of brothers and sisters, who live in the same house, sit upon opposite sides of the same table, and are presided over by an elder and elderess, their temporalities being superintended by a deacon and deaconess. They take their meals in silence, are scrupulously neat, live well but simply, employ no doctors, take no drugs, and are noted for their good gardens, flower-seeds, and medicinal herbs which they cultivate for the market. Their numbers are recruited mostly by young men and women, although occasionally married people with their children join the order. Believing that education is the right of all, they provide liberally for the education of the children left in their care. Their worship consists of vocal and instrumental music, 'dancing and making merry' followed by silent communion, and sermons which in point of devoutness, logic, and rhetorical form may fairly be compared with the sermons of the ordinary Christian churches. Their societies are united in one organisation presided over by the head elderess, assisted by the chief elder. They repudiate a priesthood, monarchy, and paid ministry, and teach that it is not Christ or Ann Lee, but the

principles of Christ which must be accepted, and that all may become Christ's by death of the generative nature and an infusion of the Christ spirit. They repudiate the atonement by blood and the resurrection of the body as 'a horrid idea,' anti-Christian and anti-scientific. They have no creed, but depend upon divine revelation, which they claim is progressive according to the needs and development of humanity. They believe that God is dual—the Eternal Father and the Eternal Mother—the heavenly parents of all beings angelic and human: that the first revelation of God to humanity was as a Great Spirit pervading all things, hence pantheistic worship; that the second revelation of God was as Jehovah; the third through Jesus, a divinely inspired man, representing God as a father; and that in 1770, the beginning of the last cycle, God was revealed in the character of the Eternal Mother—the bearing spirit of all the creation of God in divine love and tenderness—in the person of Ann Lee as the female Christ. Salvation, they teach, can only come by the death of the Adamic or generative life, by which man becomes a new order of being, able to comprehend 'the mysteries of God.' The earthly procreative relation for the purposes of reproduction is fit only for the children of this world, and carnal sexual indulgence is denounced as 'the unfruitful works of darkness.' Labour is 'a sacred and priestly duty,' and the work of the saints is by loving labour bestowed upon the earth to redeem it from the Adamic curse, which was lifted by the coming of Christ; each child born has a title-deed from God for land sufficient for its existence, and in the present advanced stage of civilisation this right is best recognised by a community of interest in the rent obtained for advantages of location, fertility, and mineral wealth. They denounce war, claiming that all disputes of individuals and nations should be settled by arbitration. They oppose the union of church and state, take no interest in governments as now constituted, loving their own country only as the favoured land of God, believing that in America the millennium is first to come when human governments, civil and ecclesiastical, will recognise the female element in harmony with the dual government of God. They make no effort to secure converts, it being a part of their religion that God will designate whom he has called to live in 'union,' and claim that instead of Shakers becoming extinct as is prophesied, and as they admit is prophetically indicated by their loss of membership, 'the first heavens and earth are passing away, and that a new heavens and new earth will be evolved out of the chaotic elements which exist in church and state humanity by the inspiration of revelation from the Christ heavens'—in other words, that the general principles of Shakerism will be established throughout the world.

ENGLISH SHAKERS was the name commonly given to a community calling themselves 'Children of God,' founded by Mary Anne Girling (born 1827), who about 1864 came to believe that she was a new and final incarnation of God, and insisting on celibacy. Founded in London, the communion grew to about 150 members, and in 1872 settled on a property purchased for them, New Forest Lodge, in the New Forest, Hampshire. Though industrious and blameless, they sank into poverty; and, unable to pay their debts, were evicted in December, 1873, and subsequently, shrunk to twenty or thirty in number, lived a miserable existence in sheds and temporary shelters. Mrs Girling, who was confident she would never die, did die of cancer, 18th September 1886, and her sect collapsed.

See Elder F. W. Evans, *The Shakers* (1859), and *Autobiography of a Shaker* (1879); Eads, *Shaker Sermons* (1879); and *The Manifesto*, the Shaker magazine.

Shakespeare, WILLIAM, the greatest of dramatic poets, was born at Stratford-on-Avon towards the close of April, 1564.

Copyright 1887, 1887, and 1900 in the U. S. by J. R. Lippincott Company.

The birthday is uncertain; tradition points to April 23, O.S., corresponding to our 5th May; on April 26 the infant was baptised. The house in Henley Street which is believed to be the birthplace may still be seen—as restored. The child's father, John Shakespeare, son of Richard Shakespeare, a Warwickshire farmer, was a fell-monger and glover, perhaps also a butcher, and certainly a dealer at times in corn and timber. In 1557 he married Mary Arden, daughter of a wealthy farmer, who on dying had left her a small estate named Asbies, with the reversion to part of another property at Snitterfield. John Shakespeare for a time prospered; in 1561 he became chamberlain of the borough, afterwards an alderman, and in 1568 high-bailiff of Stratford. The boy William was John Shakespeare's third child; two daughters born before him died in infancy. The later born children were five—two daughters, of whom one outlived the dramatist, and three sons, Gilbert, Richard, and Edmund; the last of these became an actor and died in 1607.

Although John Shakespeare was a respected burgess of Stratford, his education was small; he could not write his name. In all probability his eldest son was educated at the free school of Stratford, where beside English he would learn something of Latin, possibly even the elements of Greek. 'Small Latin and less Greek' is Ben Jonson's description of the scholarship of his great contemporary. The Greek, if any, must have been small indeed. At a later time Shakespeare seems to have acquired a little French, and possibly something of Italian. As a boy he may have seen dramatic entertainments at Stratford, for companies visited the town and performed there on several occasions from the year of his father's bailiffship onwards. In 1575 Leicester received Queen Elizabeth at Kenilworth, and it is possible that John Shakespeare may have taken his eldest son to look at the masques and mummeries; Oberon's description of the 'mermaid on a dolphin's back' (*Midsummer Night's Dream*, II. i. 148-168) has been supposed to be a reminiscence of the occasion. In 1578 the fortunes of John Shakespeare underwent an unfavourable change, and for many years pecuniary troubles pressed upon him; he mortgaged the Asbies estate, and sold his wife's reversionary interests at Snitterfield; he ceased to attend the town council; his taxes were remitted; as late as 1592 it is reported of him that he did not attend church for fear of 'processe for debt.' At what date he removed his son from school we cannot tell. Perhaps, as one tradition has it, the boy was apprenticed to a butcher; perhaps he was for a time an attorney's clerk—a conjecture founded on certain supposed allusions of his dramatic contemporary Nash, and on the fact that the legal references in Shakespeare's plays and poems are very numerous and give evidence of information which is remarkably correct. The blank in our knowledge of this period of his life is thus filled with guesses—guesses not altogether unprofitable. The worldly prudence of Shakespeare's manhood may have come to him as the lesson of these early years of trouble in his father's house. But the lesson of prudence was not learned all at once. A bond given previous to marriage between William Shakespeare and Anne Hathaway, dated November 28, 1582, was found in 1836 in the registry of Worcester. The marriage was to take place after the banns had been once asked. Anne Hathaway was the daughter of a substantial yeoman, lately dead, of Shottery in the parish of Stratford; she was eight years older than the bridegroom,

who was only in his nineteenth year; she was socially his inferior, and it is probable that she was uneducated. The marriage may have been pressed forward by Anne's friends in order that a child—Shakespeare's eldest daughter, Susanna (baptised May 26, 1543)—might be born in lawful wedlock. Mr Halliwell-Phillipps argues that the bond was not improbably preceded by a contract, which, according to the customs of the time, would have given the contracting parties the mutual rights of husband and wife, though as yet un-sanctioned by the church. The marriage was doubtless solemnised soon after the date of the bond, but where and on what day is unknown. Two years after the birth of Susanna twins were born, Hamnet and Judith (baptised February 2, 1585). These three were Shakespeare's only children. Hamnet (probably named after a Stratford friend and neighbour, Hamnet Sadler) died in his twelfth year (buried August 11, 1596); both daughters survived their father.

Three or four years, as it is believed, after his marriage Shakespeare quitted his native town. 'He had,' says his first biographer, Rowe, 'by a misfortune, common enough to young fellows, fallen into ill company, and, amongst them, some that made a frequent practice of deer-stealing engaged him more than once in robbing a park that belonged to Sir Thomas Lucy, of Charlecote, near Stratford. For this he was prosecuted by that gentleman, as he thought, somewhat too severely; and, in order to revenge that ill-usage, he made a ballad upon him. And though this, probably the first essay of his poetry, be lost, yet it is said to have been so very bitter that it redoubled the prosecution against him to that degree that he was obliged to leave his business and family in Warwickshire for some time, and shelter himself in London.' It seems likely that in essentials the story thus reported by Rowe is true, and a verse of the ballad—whether genuine or written, as is more likely, to suit the story—has been given by Oldys. In *The Merry Wives of Windsor* Justice Shallow complains of Falstaff's having killed his deer; there are 'lucres' in the Shallow coat-of-arms as in that of the Lucy family, which lucres in the Welsh parson's pronunciation become 'louses'—a play on words occurring also in the alleged stanza of Shakespeare's offensive ballad.

A tradition, which appears to have come down from Betterton and D'Avenant, relates that Shakespeare's first employment in London was that of holding at the playhouse door the horses of those gentlemen who rode to the theatre unattended by servants. 'In this office,' so Johnson received the tale from Pope, 'he became so conspicuous for his care and readiness that in a short time every man as he alighted called for Will Shakespeare, and scarcely any other waiter was trusted with a horse while Will Shakespeare could be had;' by-and-by he hired boys to wait under his superintendence, and 'Shakespeare's Boys' continued to be their name long after their master had risen to higher employment. Mr Halliwell-Phillipps holds that the story need not be set aside as an absolute fiction. The date of Shakespeare's flight to London can hardly have been earlier than 1585, and it is not likely to have been later than 1587. Mr Fleay conjectures that in the last-named year he joined Lord Leicester's players during their visit to Stratford, or soon after that visit; but tradition lends no support to the supposition that Shakespeare left his home with a view to trying his fortune on the stage. Except that we find his name joined with that of his father in an attempt made in 1587 to assign the Asbies property to the mortgagee, we know nothing for certain of Shakespeare's life from the date of his twin-children's birth until the year 1592,

when he was an actor and a rising playwright. The dramatist Robert Greene, dying in that year, addressed three of his brother-authors, Marlowe, Peele, and Nash or Lodge, in a passage of his pamphlet, *Greene's Groatsworth of Wit bought with a Million of Repentance*, warning them against the ungrateful and inconstant race of players: 'Yes, trust them not: for there is an upstart crow, beautified with our feathers, that with his *Tyggers heart wrapt in a players hide* supposes he is as well able to bumbast out a blanke verse as the best of you: and being an absolute *Johannes factotum*, is in his own conceit the only Shake-scene in a country.' The line of verse here parodied,

Oh, tiger's heart wrapt in a woman's hide,

occurs in the *Third Part of Henry VI.* and in the old play, *Richard Duke of York*, on which it is founded. Greene suggests that Shakespeare has been pilfering from a play in which he and Marlowe had each a hand. The editor of Greene's pamphlet, Henry Chettle, soon after, in his pamphlet *Kind-Harts Dream* (December 1592), made a handsome apology to Shakespeare: 'I am as sorry as if the originall fault had been my faulte, because my selfe have seene his [Shakespeare's] demeanor no lesse civill than he exelent in the qualitie he professes; besides, divers of worship have reported his uprightnes of dealing, which argues his honesty, and his facetious grace in writing, that approves his art.' From these references we infer that Shakespeare had already made himself a valuable member of his dramatic company, that he was already known as a writer for the stage, that his merit as an actor ('quality' having special reference to this) was not inconsiderable, and that as a man he was honourable in all his acts. High eminence as an actor Shakespeare did not attain, though it appears from Hamlet's advice to the players that he had a just perception of the actor's merits and defects. Rowe assures us that 'the top of his performance was the ghost in his own *Hamlet*.' It is believed that he took the part of Old Knowell in Jonson's *Every Man in his Humour*, and perhaps that of the venerable Adam in *As You Like It*.

In 1593 appeared Shakespeare's first published work, the narrative poem, written in a six-line stanza, *Venus and Adonis*. It is dedicated to the young Earl of Southampton, the poet's patron and friend, who, according to a tradition derived from D'Avenant, on one occasion proved his friendship by a large gift of money to enable Shakespeare 'to go through with a purchase he had a mind to.' *Venus and Adonis* is described by its author as 'the first heir of his invention'; it is an elaborate piece of Renaissance paganism, setting forth ideals of sensuous beauty, male and female, in the persons of the amorous goddess and of the young hunter, whose coldness meets and foils her passion. Close observation of nature and much sweetness of versification characterise the poem; the passages of dialogue are, as it were, studies in the casuistry of passion; elaborate conceits, such as few Elizabethan poets could escape from, abound. The dedication promises a 'graver labour,' and this soon followed in the *Lucrece* (published 1594). The theme of the *Venus* is here, as it were, reversed; the lawless passion of Tarquin is confronted by the ardent chastity of the Roman wife. The stanza is one of seven lines; the dedication is again to Southampton, and its words express strong and deep devotion. Both the *Venus* and the *Lucrece* became immediately popular, and were many times reprinted.

Shakespeare's earliest dramatic exercises consisted probably in adapting to the stage plays by other authors which had grown a little out of date.

Many critics have pointed to *Titus Andronicus* as an example of such work, and a tradition put on record in 1687 confirms this view. The play certainly belongs to a moment in the history of English tragedy which we may describe as pre-Shakespearian; it reeks with blood; its effects are rather those of horror than of dramatic terror and pity; if Shakespeare wrote it we must believe that he wrote it before his genius had discovered its true direction. Another of the early plays in which Shakespeare probably worked upon older material is the *First Part of Henry VI.*; some critics have held that in its construction three hands can be distinguished. However this may be, we accept it as all but certain that the play contains pre-Shakespearian work; we are pleased to think that the ignoble portraiture of Joan of Arc is not of our great dramatist's conceiving; in the Temple-garden scene (ii. 4), which tells of the plucking of the white rose and the red, we have perhaps Shakespeare's chief contribution to this drama.

We dare not say for certain at what precise date Shakespeare's career as a dramatic author began; but 1589-90 cannot be far astray. Among his earliest experiments in comedy were *Love's Labour's Lost*, *The Comedy of Errors*, and *The Two Gentlemen of Verona*; among the earliest historical dramas were the second and third parts of *Henry VI.*, *King Richard III.*, and *King Richard II.*; the first romantic tragedy (setting aside *Titus Andronicus*) was undoubtedly *Romeo and Juliet*. The evidence by which the chronology of Shakespeare's several works is ascertained or inferred with more or less probability is of various kinds, including entries of publication or intended publication in the Stationers' Registers; statements about the plays and poems, or allusions to them, or quotations from them by contemporary writers in works of known dates; facts connected with the history of dramatic companies which presented plays of Shakespeare; allusions in the plays to historical events, and quotations by Shakespeare from publications of the day. We cannot fail also to observe the growth of Shakespeare's imaginative power, his intellectual reach, his moral depth, his spiritual wisdom; with respect to each of these we must needs recognise a profound difference between the earlier and the later plays. At the same time we perceive a gradual change, or rather a group of changes, taking place in the structure of his dramatic verse. In his verse of early date the sense closes with the line far more frequently than is the case in his verse of a later period, and with this growing tendency to carry the sense beyond the line arises also an inclination or a readiness to place as the final word of the line some word such as *am, do, I* ('light ending'), or even such as *and, of, if* ('weak ending'), which precipitates the reader or pronouncer of the passage into the next following line. Thus in its structure the versification becomes more varied and freer, or, if not freer, subject to subtler and less obvious laws. It is part of the same process that Shakespeare gradually ceased from employing rhyme for dramatic purposes, and again that he allowed the decasyllabic line to pass much more frequently into one of eleven syllables ('double ending' or 'feminine ending'). These peculiarities of versification admit of statistical calculations in their process of development, and have formed the subject of much careful study among recent Shakespearian scholars.

In his early comedies Shakespeare is trying, as it were, his 'prentice hand in various experiments. *Love's Labour's Lost* (c. 1590) is perhaps his first original play; no source is known; some of the leading characters seem to be named after persons of note in recent or contemporary French



ROOM IN WHICH SHAKESPEARE WAS BORN.
Vol. IX., page 364.



SHAKESPEARE'S HOUSE, MUSEUM.
Vol. IX., page 363.

history. Learned pedantry, fantastical extravagance of speech, the affectations of amorous poetry are satirised, and the dramatist pleads against artificial restraints on conduct and pseudo-ideals and in favour of nature and healthy passion. The play was partly rewritten about 1598, when it was presented before Queen Elizabeth. *The Comedy of Errors* (c. 1591) is a lively tangle of farcical incidents; it is founded on the *Menæchmi* of Plautus, which was translated into English by Warner, but Shakespeare seems to have reached the *Menæchmi* either in the original or through some other rendering. The twin-brothers Dromio are an addition to the twin-brothers of the Latin comedy, and heighten the laughable perplexities of the play. A serious—almost a pathetic—background to the story is invented by Shakespeare, and in his *Luciana* we get a hint of some of his later beautiful creations of female character. *The Two Gentlemen of Verona* (c. 1592), a romantic love comedy, exhibits a marked advance in the presentation of character, though not in the construction of plot. There is apparently a connection between the story of the play and the story of the 'Shepherdess Felismena' in the *Diana* of George of Montemayor, a Spanish piece of Arcadian romance. Shakespeare's humour breaks forth in his portrait of the clown, Launce; Julia is the first of his charming feminine disguisers in male costume. This group of early comedies may be considered to close with *A Midsummer Night's Dream* (c. 1593-94). Hints for the play may have been taken from Chaucer, from Plutarch, from the *Diana*, and from popular superstitions; but it is essentially a new creation of the poet. No other comedy of Shakespeare has so large a lyrical element; the figures of the lovers are faintly drawn, but the exquisite fairy-poetry, and the humours of sweet bully Bottom make sufficient amends.

Meanwhile Shakespeare was also engaged on the English historical drama. In the *Second and Third Parts of Henry VI.* (c. 1592) he worked upon the basis of old plays written probably by Marlowe and Greene—possibly also Peele—and in the revision he may have had Marlowe as a collaborator. To come under the influence of that great master, Christopher Marlowe, was no disadvantage for one who could accept gains from every quarter and by the force of his genius could make them his own. In *King Richard III.* (c. 1593) he still writes in Marlowe's manner, though the play is wholly his own. As with Marlowe the protagonist everywhere dominates over the secondary characters; as with Marlowe a great criminal is made of fascinating interest, by virtue of his unity of passion and of power. The chief source from which Shakespeare derived the material for his plays from English history was the chronicle of Holinshed. The three parts of *Henry VI.* and the tragedy of *Richard III.* present a continuous view of the rise and fall of the House of York. In *King Richard II.* (c. 1594) is set forth the rise of the House of Lancaster. Here, though there are reminiscences from *Edward II.*, the influence of Marlowe is no longer supreme. The contrast between the hectic, self-indulgent, rhetorical Richard, who yet possesses a certain regal charm, and his strong adversary Bolingbroke is a fine psychological study of a kind which is essentially Shakespearian and not Marlowesque. To mould into dramatic form the tough material of history was an admirable exercise in dramatic craftsmanship. The breadth and sanity of history also tended to preserve Shakespeare from the danger of romantic extravagance, such as injures the art of other dramatists who worked chiefly on stories of crime and passion supplied by Italian romance. *King John* (c. 1595)

stands apart by its subject from both the York and the Lancaster series of plays; but in style it has something in common with *Richard II.* It is founded not so much on Holinshed as on an old play, *The Troublesome Raigne of King John*, and a comparison of his original seen in its poverty, crudity, and coarseness, with Shakespeare's creation, where everything is ennobled, purified, and refined, affords a study of no little interest in dramatic art.

In the passage which describes Oberon's vision in *A Midsummer Night's Dream* a magnificent compliment to Queen Elizabeth, 'the imperial votaress,' is introduced. Shakespeare as a member of the Lord Chamberlain's company appeared on several occasions before her majesty. In December 1594 he acted in two comedies at Greenwich Palace. On Innocents' Day of the same year the *Comedy of Errors* was presented in the hall of Gray's Inn. The playhouse in which at first he ordinarily performed was either that known as 'The Theatre' or 'The Curtain' on the Shore-ditch edge of London. From 1599 onwards he was connected with the new playhouse, 'The Globe,' which stood near London Bridge on the Southwark side, and here and in the Blackfriars Theatre (1596) his dramas were presented. His good sense and worldly prudence are remarkable; before long he became a theatrical shareholder, and had gathered sufficient wealth to purchase (1597) 'New Place,' a large house in his native town. In 1596 his father, moved perhaps by the wish of the dramatist to occupy a dignified position, applied for a grant of coat-armour, and sought, probably without success, to recover the mortgaged Asbies estate. The year was one of affliction, for in August Shakespeare's only son—Hamnet—died. Yet Stratford remained dear to the sorrowing father; he kept in close relation with his friends and former neighbours, and in 1598 was engaged in negotiating a loan for the corporation of the town. The runaway youth of ten or twelve years since was now a man of consideration and of substance. In September 1601 his father died; his mother lived until September 1608. In the year following his father's death Shakespeare bought for £320, then a large sum of money, 107 acres near Stratford, and enlarged the bounds of his New Place property. In 1605 he paid £440 for the unexpired term of the moiety of a lease of the tithes of Stratford, Old Stratford, Bishopton, and Welcombe. He did not despise small things, for we find him in 1604 proceeding for the recovery of a debt amounting to £1, 15s. 10d. With boundless empire in the realm of imagination he valued also at its real worth a foothold on this material earth of ours.

Among the earlier creations of his genius one stands apart from the rest—the tragedy of *Romeo and Juliet*. Possibly as we have it now the play is a revision dating about 1596-97 of a work written as early as 1592. It is founded in the main upon a poem, *Romeus and Juliet* (1562), by Arthur Brooke, which verifies the tale taken by the French Boisteau from the Italian of Bandello; but Shakespeare was also probably acquainted with Paynter's prose version of the story in his *Palace of Pleasure* (1567). The play has a lyrical sweetness, swiftness, and intensity such as we do not find elsewhere in its author's writings. It has many signs of early workmanship—much rhymed verse, and many conceits and over-strained ingenuities; but these last are forgotten in the high passions of joy and anguish which find expression in the tragedy. The brilliant Mercutio, the tranquil Friar, the humorous figure of the Nurse form an admirable background from which stand out the persons of the lovers—a youth and a maiden of

the south possessed by one all-absorbing emotion. It is strange that Shakespeare did not follow up this early tragedy by any play of a like kind. Near to it in the chronological order probably stands the exquisite comedy of *The Merchant of Venice* (c. 1596), which occupies a middle place between the group of Shakespeare's earliest comedies and those which lie around the year 1600. The story of the caskets and the story of the pound of flesh had probably been brought together in an old play now lost which is mentioned by Stephen Gosson in 1579; but a play of that date can have afforded only rude material on which to work. The advance in characterisation from that of Shakespeare's previous comedies is remarkable; no earlier heroine is comparable with Portia, and the gracious brightness of her figure is admirably enforced by its contrast with the dark colours in which the Jew is painted. Something was doubtless derived from Marlowe's Jew of Malta, Barabas; but Shylock, with all his passion of revenge, is human; Barabas is an incredible monster of vices. Shakespeare's mastery of comedy aids him in the historical plays which followed the *First and Second Parts of King Henry IV.* (1597-98) and *King Henry V.* (1599). In these dramas the fortunes of the House of Lancaster are followed to their glorious culmination. The turbulent years from the battle of Homildon Hill (1402) to the death of the usurping Bolingbroke (1413) supply the material for the historical portion of both parts of *Henry IV.* But interwoven with the history is that inimitable comedy of which Falstaff is hero. In the epilogue to the second part a promise is given that Falstaff shall again appear in another play in which the author will continue the story and make the spectators 'merry with fair Katherine of France.' Shakespeare found it impossible to fulfil that promise. In the heroic drama of *King Henry V.* there is no place for the fat knight. The play is inspired by the ardent patriotism, the lofty national enthusiasm of the age of Elizabeth. In the person of the king Shakespeare presents his ideal of a noble ruler of men. The material for *Henry IV.* and *Henry V.* was derived partly from Holinshed, partly from an old play entitled *The Famous Victories of Henry V.* Thus, as it were, with a trumpet-note of patriotic pride and battle-ardour Shakespeare's historical plays of England are brought to a close.

There is a tradition dating from 1702 that Queen Elizabeth commanded Shakespeare to exhibit Falstaff in love, and that in obedience he hastily wrote—in fourteen days it is said—*The Merry Wives of Windsor* (1598-99). The comedy is of special interest as a picture of middle-class English life, and may be well studied in comparison with Jonson's *Every Man in his Humour*; but the fatuous Falstaff of the *Merry Wives* is far different from the ever-detected yet never-defeated Falstaff of the historical plays. The comedy is written almost wholly in prose, and in its incidents approaches farce. It may be that it was about this time that Shakespeare adapted and enlarged the old play, *The Taming of a Shrew*, or perhaps adapted and enlarged a previous adaptation of that play by another hand. In *The Taming of the Shrew* (1507?) Shakespeare's genius shows itself chiefly in connection with the boisterous heroine, her high-spirited tamer Petruchio, and the drunken tinker of the Induction. Conjectural attempts have been made to distinguish the scenes and lines which may be ascribed to Shakespeare; but these must be accepted with reserve. The same animal spirits and intellectual vivacity which characterise the *Merry Wives* and the *Shrew* appear—but now refined and exalted—in *Much Ado about Nothing* (1598-99). The story of Claudio and Hero had probably for its original a tale of Bandello trans-

lated by Belleforest into French. The characters of Beatrice and Benedick, it is supposed, are entirely original creations of the dramatist; there is in them something of his own Rosaline and Berowne, and it was about this time that he re-handled *Love's Labour's Lost*, the play in which we make acquaintance with this earlier pair of lovers. *As You Like It* (1599) and *Twelfth Night* (1600-1) are the last of the wholly joyous comedies of this period. In the former there is indeed a simulacrum of melancholy in Jaques' affectation of that mood as a fashion; but of real gloom, of real sorrow there is not a trace. This charming pastoral comedy is dramatised from a prose tale by Shakespeare's contemporary Lodge, entitled *Rosalynde, Euphues Golden Legacie* (1590), which itself follows the *Tale of Gamelyn*, erroneously introduced as Chaucer's in some editions of the *Canterbury Tales*. In not a few scenes of *Twelfth Night* the mirth is fast and high, but the central comic figure, Malvolio, has something of dignity, almost of majesty, in his extravagant and solemn self-importance. Viola is perhaps the most charming of Shakespeare's maiden masquers in male attire; if she has not the intellectual brilliance of Rosalind, she has even more of maiden sweetness. The plot resembles that of an Italian play *Gl' Ingannati*, and it may also be found in a tale translated into French by Belleforest from Bandello. But the group of jesters and humorists with their victim Malvolio are of Shakespeare's invention.

About the year 1600-1 a change begins to develop itself in the spirit of Shakespeare's writings; his mirth becomes touched with seriousness or infected with bitterness, and soon he ceases to write comedy. Some students have supposed that this transition from a joyous to a sadder temper is connected with events which are shadowed forth in Shakespeare's *Sonnets*. The volume of *Sonnets* was not published until 1609, but Shakespeare's 'sugred sonnets among his private friends' were mentioned by Francis Meres (who gives a very important list of the poet's writings) in his *Palladis Tamia* (1598), and in the following year the *Sonnets* afterwards numbered 138 and 144 were printed in a surreptitious miscellany of verse ascribed to Shakespeare by the bookseller Jaggard, and entitled *The Passionate Pilgrim*. The 1609 edition of *Sonnets* is dedicated by the publisher T. Thorpe to 'Mr W. H.' as 'the onlie begetter of these insuing *Sonnets*.' The poems, 154 in number, form two groups—1-126 addressed to a beautiful young man of high station, 127-154 either addressed to or referring to a married woman not beautiful according to the conventional standard, of dark complexion, highly accomplished, fascinating, but of stained character and irregular conduct. The two groups are connected. Shakespeare's young friend and patron, whom he addresses in words of measureless devotion, seems to have fallen into the toils of the woman to whom Shakespeare was himself attached by a passion which he felt to be degrading, yet which he could not overcome. The woman yielded herself to the younger admirer who was socially the superior of Shakespeare. Hence an alienation between the friends, increased by the fact that the youth was now the favourite of a rival poet; but in the close all wrongs were forgotten and the friendship renewed on a firmer basis. Such is the story to be read in the *Sonnets*, if we take them, as they ought to be taken, in their natural sense. But some critics have imagined that they deal with ideal themes or may set forth a spiritual allegory. Many attempts have been made to identify the persons of Mr W. H., the dark woman, and the rival poet. The happiest guess with respect to the last is that he was George Chapman. It has been conjectured that

Mr W. H. was Henry Wriothesley, Earl of Southampton (the initials reversed), and again that he was William Herbert, the young Earl of Pembroke, who was certainly a patron of Shakespeare. An ingenious argument has been set forth by Mr T. Tyler to prove that the woman of the *Sonnets* was Mary Fitton, a mistress of William Herbert. But it is questionable whether the portraits of Mary Fitton and of Pembroke agree with the indications afforded in the *Sonnets*. In truth the persons have not yet been identified; no conjecture has any but the most insecure support; and it is not likely that the facts so long hidden will ever be revealed.

In his earliest plays Shakespeare tried his hand, as an apprentice in the craft, in many and various directions. In the English historical plays and the joyous comedy he exhibits his mastery of the broad field of human life. But as yet he had not searched the profounder mysteries of our being, nor handled the deeper and darker passions of humanity. About the opening of the 17th century, as we have noticed, a change takes place in the spirit of his creations. He still writes comedy, but the gaiety of the earlier comedies is gone. *All's Well that Ends Well* (c. 1601-2) is least happy in its mirthful scenes; it is at its best where the strong-willed heroine Helena appears, whose task is to seek after and save the unworthy youth to whom she has given her heart. Some critics have supposed that the play as we have it is Shakespeare's rehandling of an earlier version from his own pen originally entitled *Love's Labour's Won*—a play of that name being included in Meres's list of the year 1598. But this theory is incapable of verification. The story came to Shakespeare from Boccaccio through Paynter's *Palace of Pleasure*. *Measure for Measure* (c. 1603) hardly deserves the name of comedy; it is a searching of the mystery of self-deceit in the heart of a man, and the exhibition of an ideal of virginal chastity and strength in the person of the heroine, Isabella. The city life represented in the play is base and foul; the prison-scenes are ennobled by profound imaginative speculations upon life and death. It is the darkest of the comedies of Shakespeare. The subject had previously been handled dramatically in Whetstone's *Promos and Cassandra* (1578), and the same author had told the tale in prose in his *Heptameron of Civil Discourses* (1582). Perhaps it is to this date (1603) that *Troilus and Cressida* belongs, but the chronology as well as the purport of the play is perplexing. It has been suggested that different portions of the comedy were written at different dates; but here again we are in the region of conjecture. Certain passages, as, for example, Hector's last battle, are probably by another hand than Shakespeare's. The sources of the play are Chaucer's poem on the same subject, Caxton's translation from the French *Recuyles, or Destruction of Troy*, and Chapman's *Homer*. Some have even fancied that Shakespeare's design was to turn into ridicule the classical heroes of Chapman, the supposed rival poet of the *Sonnets*. But there is nowhere a nobler representative of worldly wisdom, in a high sense of the word, than Shakespeare's Ulysses. It may be called the comedy of disillusion—a kind of foil to *Romeo and Juliet*. The callow passion of the youthful hero is basely deceived by Cressida, a born light-o'-love; but in the end Troilus masters his boyish despair, and grows firm-set in his vigorous manhood. The contrast between worldly wisdom and adolescent enthusiasm is perhaps the most striking thing in the play.

Before he ceased for a time to write comedy Shakespeare had probably begun that great series of tragedies which occupied him during the opening years of the 17th century. *Julius Cæsar* (1601) and

Hamlet (1602) are tragedies in which reflection, as a motive-power, holds its own with emotion; in the later tragedies the chief characters are whirled away by passion; here they are misled by thought. In North's translation of *Plutarch's Lives* Shakespeare found admirable material for his Roman plays, and he used it as a true creative poet, and not as a mere antiquary. The Brutus of *Julius Cæsar* is an idealist dealing with practical affairs, constantly in error, yet honoured by us because his errors are those which only a man of noble nature could commit. Cæsar is represented in his decline, with many infirmities, but his presence and power are pre-eminant through the tragedy in the impersonal form of Cæsarism, which sways the spirits of men and compels the catastrophe. *Hamlet* is perhaps founded on an older play, which certainly existed, and produced a great impression on the stage about 1588-89. Shakespeare doubtless read the story, originally derived from Saxo Grammaticus, in the English prose of the *Hystorie of Hamlet* translated from the French of Belleforest. He represents, as Goethe has put it, 'the effects of a great action laid upon a soul unfit for the performance of it.' Hamlet is summoned to avenge his father's murder, but habits of speculation, an excitable emotional temperament, and an untrained will disqualify him for acting the part of a justiciary. He accomplishes his purpose at last, but as it were by chance-medley.

And now tragedy succeeded tragedy, each of surpassing greatness, and all the depths were sounded. *Othello* (c. 1604), founded on a tale given in Cinthio's *Hecatommithi*, exhibits a free and noble nature taken in the toils of jealousy, and perishing in the struggle for deliverance. The betrayer, Iago, is the nearest approach to an incarnation of absolute evil to be found in Shakespeare's plays. *King Lear* (1605) derived some of its substance from an old play on the same subject as well as from Holinshed's Chronicle; the episode of Gloucester and his sons is adapted from Sidney's *Arcadia*. The tragedy is the most stupendous in our literature; the bonds of natural affection, of loyalty, of the amity of nations, almost of the laws of nature, are broken or convulsed; but justice asserts itself in the close, and if Cordelia dies, she dies a martyr of redeeming love. *Macbeth* (c. 1606) is the tragedy of criminal ambition. The source is once again Holinshed. A theory of Messrs Clark and Wright that the play, as we have it, is disfigured by the interpolations of another dramatist—perhaps Middleton—must be regarded as of doubtful worth. The tragedy is distinguished by the unpausing rapidity of its action. In *Antony and Cleopatra* (1607) Shakespeare returns to Roman history, but here Roman manhood is sapped by the sensual witchery of the East. The most marvellous of Shakespeare's creations of female character is surely Cleopatra—Antony's 'serpent of old Nilus.' Such materials for the play as were not supplied by the poet's creative imagination he obtained from Plutarch's life of Antony in North's translation. From Plutarch also came the material for *Coriolanus* (c. 1608). The poet passes from Rome of the empire to the earlier Rome of the consuls, and from the history of a great nature ruined by voluptuous relaxation of its powers to that of a great nature ruined by self-centred pride. As the Roman wife was shown in the Portia of *Julius Cæsar*, so here is presented the Roman mother in the majestic figure of Volturnia. The series of great tragedies closes perhaps with *Timon of Athens* (c. 1607-8), but the play is only in part by Shakespeare. It describes the total eclipse of faith, hope, charity in the undisciplined spirit of Timon, who passes from an easy, indulgent optimism to a wild misanthropy.

Nowhere is Shakespeare a greater dramatic rhetorician than in some of the misanthropist's declamatory speeches. The story was taken from Paynter's *Palace of Pleasure*, and certain gleanings were added from Plutarch and from Lucian.

At this point once again a change shows itself in the spirit of Shakespeare. After passion comes peace; after the poetry of revolt comes the poetry of reconciliation; after the breaking of bonds—the bonds of the family, of the state, and even of humanity itself—come the knitting of human bonds, the meeting of parted kinsfolk, the reconciliation of alienated friends. The last plays of Shakespeare are comedies, but they might be aptly named romances, for romantic beauty presides over them rather than mirth, they have in them elements of wonder and delight, their gladness is purified and rarefied, as the happiness might be of one who has had a great experience of sorrow; the characters move amid lovely, natural surroundings; mountain and sea, the inland meadows, the island shores lend their glory or their grace to these exquisite plays. *Pericles* (1608), or rather Shakespeare's part of that play (Acts III. IV. V., omitting perhaps III. sc. ii. v. vi.), might better be named the romance of Marina, the lost daughter of Pericles. The description of the sea-storm could have come from no other hand than Shakespeare's; the scenes which tell of the recovery by Pericles of wife and child anticipate like scenes in *The Tempest*, *The Winter's Tale*, and *Cymbeline*. The story of Pericles had been told by Gower, who is introduced as 'presenter' of the play, and by Lawrence Twine in his *Patterne of Painfull Adventures* (1607); and there is a novel by George Wilkins (1608) founded upon the play. *Cymbeline* (1609) is also a tale of lost children at length recovered, and of a wife separated from her husband, but finally reunited to him. Something is derived from Holinshed, but with the historical matter is connected a story which in a different form may be found in Boccaccio's *Decameron*. *The Tempest* may have been written late in the year 1610; but it has been ingeniously argued by Dr. Garnett that Shakespeare produced it as a court-play on the occasion of the marriage of the Princess Elizabeth to the Elector Palatine, 1613, and that the enchanter Prospero is an idealised and complimentary representation of the 'wisest fool in Christendom,' King James I. No source of the play has been ascertained, but some of the characters and incidents resemble those of Jacob Ayryer's *Die Schöne Sidea*, and it is believed that this German play and *The Tempest* must have had some common original. *The Winter's Tale* (1610-11) dramatises a novel by Robert Greene named *Pandosto* (1588); that most delightful of roving rogues, Autolycus, is however a creation of Shakespeare. In *Hermione* and *Perdita* we have examples of two contrasted groups of characters represented in Shakespeare's last plays—the aged and experienced sufferers, who have been ennobled by sorrow, and the young who are ennobled by their innocence and pure joy of life.

Apart from the other historical English plays both in subject and in date stands *King Henry VIII.* (1612-13). The play is certainly in part by Fletcher, and an attempt has been made to prove that the remainder is from the hand of Massinger. But we may perhaps accept it as most likely that Shakespeare wrote the following portions: Acts I. i. ii.; II. iii. iv.; III. ii. (to exit king); V. i. The play lacks unity; it has not altogether unaptly been described by Hertzberg as 'a chronicle-history with three and a half catastrophes, varied by a marriage and a coronation pageant, ending abruptly with a child's baptism.' But there is no lack of unity in the

conception of those *dramatic persons* who interested Shakespeare—the king, Wolsey, and above all Queen Katharine, a noble and patient sufferer. Whether we have work by Shakespeare in another play partly written by Fletcher—*The Two Noble Kinsmen*—is more doubtful. Fletcher's collaborator may here have been Massinger, but there are passages which seem beyond Massinger's reach. The play is founded on Chaucer's *Knights Tale*. If Shakespeare had a hand in *The Two Noble Kinsmen* it was during the last period of his dramatic career. Not so with *Edward III.*, in parts of which some critics believe that they can trace the handiwork of Shakespeare (from king's entrance, I. ii., to end of Act II.); if he was at all concerned with that play it must have been before 1595.

At what date Shakespeare ceased to appear on the stage as an actor we cannot certainly say. He took a part in the representation of Jonson's *Sejanus* at the Globe in 1603 or 1604. In 1610 the Burbages speak of placing him with others as an actor at Blackfriars Theatre; but there are grounds for supposing that he had withdrawn from the stage at that date. In 1607 his elder daughter, Susanna, married a prosperous physician of Stratford, Mr John Hall, M.A., and early next year Shakespeare's grandchild Elizabeth Hall was born. He sold his shares in the Globe probably between 1611 and 1613; but while residing chiefly at Stratford it seems likely that he desired to possess a town residence, for in March 1613 he bought for £140 a house near the Blackfriars Theatre. In the same year the Globe Theatre was burned down while the play of *Henry VIII.* was being enacted, and it may be that stage copies of Shakespeare's plays were destroyed on this occasion. 'The latter part of his life,' says his first biographer Rowe, speaking of his Stratford days, 'was spent as all men of sense may wish theirs may be, in ease, retirement, and the conversation of his friends. . . . His pleasurable wit and good-nature engaged him in the acquaintance and entitled him to the friendship of the gentlemen of the neighbourhood.' In February 1616 his younger daughter, Judith, was married to Thomas Quiney, a vintner of Stratford. She bore three children, two of whom lived to manhood, but both died childless. Their mother lived on to the days of the Restoration of Charles II. Elizabeth Hall, Shakespeare's first-born grandchild, married Thomas Nash (1626), and secondly, Sir John Barnard (1649). She died without issue in 1670, the last descendant of the poet.

In March 1616 Shakespeare became seriously ill. A draft of his will had recently been made, and now he attached his signature to the several pages of the draft. The bulk of his worldly goods he left to his elder daughter, but Judith was given a considerable sum of money. His sister, Joan Hart, received a legacy of £50 and a life-interest in her house in Stratford. His friends in the country, certain fellow-actors, his nephews, his godson, and the Stratford poor were all remembered. To his wife he left, by an interlineation in the will, and perhaps to indulge some fancy of hers, his second-best bed; she was sufficiently provided for, without special mention, by free bench and dower. On April 23, 1616, which is supposed to be the anniversary of his birthday, Shakespeare died. According to a tradition handed down by Ward, the vicar of Stratford, his last illness was a fever contracted after a merry meeting with Drayton and Ben Jonson. Halliwell-Phillipps supposes that it is as likely to have been caused by the poison of filth and ill-drainage which hung about New Place.

On April 25 the body was laid at rest in the

chancel of the parish church, near the northern wall. On a slab which marks the spot are inscribed lines traditionally attributed to Shakespeare.

Good Friend for Iesus sake forbear
To digg the dust enclosed here;
Bleste be the man that spares thes stones,
And curst be he that moves my bones.

The removal of bones to the charnel-house was then a common practice. During the life of Shakespeare's widow—who died August 6, 1623—a monument was erected in the church, on the chancel wall hard by the grave. It was sculptured by Gerard Johnson or one of his sons. A bust of blue limestone was placed between Corinthian columns of black marble. The head is massive, the forehead lofty and domed, the face that of a cheerful, prosperous man. The poet is represented as composing his works, pen in hand. 'The effigy was originally painted in colours to resemble life. The face and hands were of a flesh colour; the eyes of a light hazel; the hair and beard were auburn. The doublet was scarlet, and the loose gown without sleeves worn over it was black.' Besides this somewhat rude portrait, we possess a portrait-print by Droeshout prefixed to the first folio edition of Shakespeare's works (1623). It is an ill-executed engraving, but is of value as confirming the features of the bust in their general characteristics. These are the only certain portraits. A death-mask, known as the Kesselstadt death-mask, presenting a remarkable and noble face, may possibly be genuine; but the evidence leaves much room for doubt. Of many alleged painted portraits that known as the Chandos portrait has found, perhaps, the widest acceptance.

The central impression which his writings and the story of his life leave upon us with respect to the man Shakespeare is that of the completeness of his humanity, and the sanity which results from such completeness. His life in the world of imagination is the widest and deepest on record; but he was not, like so many of the race of poets, indifferent to the practical, material life. He was certainly a man of strong passions; he was profoundly speculative—in the way of an imaginative thinker—with reference to the problems of the soul; but he learned to control his passions, and to master his excessive tendency to speculation; in the close, he looked down on all of human life with sympathy as from the heights; and yet he did not desert the duties of the common road on which men travel side by side.

The name of the poet may be spelt 'Shakspere,' for we have his autograph signature in that form; but 'Shakespeare,' which appears on the title-page of books which he superintended, is also correct. There is less evidence in favour of the form 'Shakspere.'

During his life from 1597 onwards several of his plays were printed in quarto (see Halliwell-Phillipps' *Outlines of the Life of Shakespeare*, vol. i., 'Lifetime editions'). After his death the first collected edition of the plays appeared in 1623, in folio, under the superintendence of his fellow-actors Heminge and Condell. It is dedicated to the brothers, the Earls of Pembroke and of Montgomery. Seventeen of the plays contained in the volume had not been published in quarto. The arrangement of the contents is under the three divisions of comedy, history, and tragedy. In 1632 this volume was reprinted (second folio), and again in 1663-64 (third folio) and 1685 (fourth folio). The 1664 issue of the third folio gives seven additional plays—*Pericles*; *The London Prodigal*; *Thomas Lord Cromwell*; *Sir John Oldcastle*, the good Lord Cobham; *The Puritan Widow*; *A Yorkshire Tragedy*; *Loocrine*. Some critics have supposed *A Yorkshire Tragedy* may possibly be by Shakespeare, or at least contain touches from his hand.

The first critical edition of the plays is that by Nicholas Rowe (1709). He made some judicious corrections of

the text, and gathered a few biographical materials, which he embodied in a brief sketch of Shakespeare's life. In 1725 appeared Pope's edition; some of his critical emendations are happy, and his preface contains admirable remarks on the Shakespearian drama. Theobald, whose edition appeared in 1733, though the object of Pope's ridicule in the *Dunciad*, was a better scholar than Pope; he collated early editions, proposed ingenious emendations, and very materially improved the text of his author. Hanmer in the 'Oxford Edition' (1744), and Warburton in his edition (1747), based on Pope's, made small advance on their predecessors. Warburton's text was severely criticised by Upton, Grey, Heath, and Edwards. The edition of Johnson (1765) is chiefly remarkable for its masterly preface; he rightly came to distrust his own skill as a conjectural emender of the text, and he was not qualified by any profound knowledge of Elizabethan literature for the task of an editor. In 1766 Steevens reprinted twenty of the early quartos, and from 1773 onwards Johnson's editorial work was ably supplemented by that of Steevens. In dealing with the text Steevens was learned and ingenious, but somewhat rash and lacking in reverence. Capell's edition (1768) is the work of a true and laborious scholar. His learned Notes, Various Readings, and the School of Shakespeare were published posthumously in 1783. Much was done by Malone to ascertain the chronological order of the plays and to illustrate the history of the English theatre. In 1780 he edited the poems of Shakespeare and the doubtful plays of the 1664 folio. His edition of Shakespeare's works followed in 1790. He was modest, faithful, learned, judicious, but unhappily was not endowed with a feeling for the beauty of verse. Variorum editions, embodying the work of Johnson, Steevens, and Malone, appeared under the editorship of Reed in 1803 and 1813, and under the editorship of James Boswell (the younger) in 1821. Towards the close of the 18th century Shakespearian critics were much occupied with the forgeries of S. W. H. Ireland. In 1796 the forger made his public confession. The criticism of Coleridge, and in a less degree that of Lamb and of Hazlitt, opened up new and better ways for Shakespearian criticism in the early part of the 19th century. Many valuable editions have been issued since the Variorum of 1821, among which may be mentioned those of Singer, Knight, Collier, Dyce, Staunton Halliwell, the Cambridge Shakespeare, the Henry Irving Shakespeare. Germany has given us the excellent edition of Delius, and America those of Grant, White, Hudson, Rolfe, and the magnificent Variorum edition of certain plays by Furness. The *Sonnets* have appeared in two annotated editions—that of the present writer and that of Tylor. The Shakespeare Society (1841-53) did much to illustrate Shakespeare's writings by reprints from Elizabethan literature; the Collier (q. v.) controversy helped to bring the society to an untimely breakdown. The New Shakspeare Society (1874 onwards) has carried on the work, and devoted itself in particular to the study of 'verse-tests' as giving indications of the chronology of the plays. A German Shakespeare Society has published annual volumes since 1865.

Concordances: Mrs Cowden Clarke's *Concordance (to the Plays)*, Mrs Furness's *Concordance to Shakespeare's Poems* (Phila., 1874), Bartlett's *Complete Concordance to the Dramatic Works and Poems of Shakespeare* (1894), Schmidt's *Lexicon. Grammar: Abbott's Shakespearian Grammar. Verse: W. Sidney Walker's Shakespeare's Versification and his Criticisms on Shakespeare* (textual notes), Bathurst's *Changes in Shakespeare's Versification. Chronology: Stoke's Chronological Order of Shakespeare's Plays. Sources: Hazlitt's Shakespeare's Library, Courtenay's Commentaries on the Historical Plays, Skeat's Shakespeare's Plutarch. Life: Halliwell-Phillipps' Outlines of the Life of Shakespeare, Fleay's Life and Work of Shakespeare. Portraits: J. Parker Norris' Portraits of Shakespeare. Criticism: Coleridge's Shakespeare Notes; Dowden's Shakespeare, his Mind and Art, and Shakespeare Primer; Hudson, Shakespeare, his Life, Art, and Characters; Gervinus, Commentaries; Lloyd's Critical Essays on Shakespeare's Plays; Mrs Jameson, Characteristics of Women; and works by Kreyssig, Ulrici, Bernhard Ten Brink, and Richard Loening. Dramatic History: Collier's English Dramatic Poetry and History of the Stage; Fleay's Chronicle of the English Drama, 1559-1642; Ward's English Dramatic Literature. Bibliography: Bohn's Bibliography, 'Shakespeare' in Lowndes's Bibliography and Allibone's Dictionary of Authors,*

Thimm's *Shakespeareana*, Mullen's Catalogue of the Shakespeare Memorial Library, Birmingham.

See also in this work the articles on Albyn, Delia Bacon, Bowdler, Boydell, Brink (Ten), Burbage, Capell, Collier, Cowden-Clarke, Delius, Drama, Dyce, Elze, Furnivall, Ulrici, S. W. H. Ireland, Johnson, Knight, Halliwell-Phillipps, Malone, Rowe, Staunton, Steevens, Stratford-on-Avon, Theatre, Theobald, Tieck, Warburton, Grant White, &c. Of the French translations the best known are those of Victor Hugo fils (1859-62) and Montégut (1868-73); of the German, those associated with the names of Wieland (in prose, 1762-66), Schlegel and Tieck (q.v., 1797-1833; new ed. by Brandl, 1896), Dingelstedt (1865-70), and Bodenstedt (1867-71; 3d ed. 1878).

Recent works on the Life by Sydney Lee (1898, who argues that the W. H. of the Sonnets was William Hall, a piratical bookseller); the critical study by G. Brandes (trans. 1898); Wyndham's edition of *The Poems* (1898); W. J. Rolfe, *Shakespeare the Boy* (1897); F. S. Boas, *Shakespeare and his Predecessors* (1896), &c.

Shale is any argillaceous rock which splits into thin laminae in the plane of sedimentation—a kind of lamination not to be confounded with the fissile structure seen in clay-slate (see SLATE). Shale is composed mainly of alumina and silica; but some shales are rich in carbonate of lime (calcareous shale), others contain much ferric oxide (ferruginous shale). Those shales which contain much quartz pass into shaly sandstone. When carbonaceous matter is abundantly present shale often passes into gas-coal, or, it may be, bituminous shale. When it is remembered that shale is of sedimentary origin, and was washed down in the form of fine silt from the land to be accumulated in lakes and quiet areas of the sea-bottom, as in estuaries, protected bays, &c., its variable composition will be readily understood. Shales are frequently highly fossiliferous—the fossils, owing to the impermeable character of such argillaceous rocks, being generally well preserved.

The importance of certain decomposing shales, through which sulphuret of iron is disseminated, for the manufacture of alum has been long known, and the quantity raised for that purpose from the Carboniferous beds of Lancashire and Lanarkshire and the Lias beds of Yorkshire is very considerable, yielding about 16,000 tons of manufactured alum annually. Shales of a similar kind are worked in France, Germany, and North America.

Bituminous shales—i.e. shales more or less rich in carbon and hydrogen—have in recent years attracted much notice as sources of oil for illuminating purposes. Two manufacturing chemists, Butler in 1833 and Du Buisson in 1845, worked patents for the extraction of paraffin from coal-tar. The process introduced by the latter in France of distilling certain bituminous shales at a comparatively low temperature was afterwards tried in England, being used for a time in distilling a Dorsetshire bituminous shale, sometimes called 'Kimmeridge coal.' From this mineral a burning oil, a lubricating oil, and a naphtha for dissolving caoutchouc were obtained. But neither in France nor in England did the attempt to make a profitable manufacture succeed: in the former country the poverty of the shales was the chief drawback; in the latter the disagreeable smell of the oil, which could not be effectually removed, prevented it from obtaining favour in the market.

On account of these failures the process fell into abeyance, until it was revived again by the success of the well-known patent of Mr James Young (see PARAFFIN), secured in 1850 for the production of paraffin and paraffin-oil from coal. With the exception of the solid paraffin, which Mr Young was the first to obtain on the large scale, and the employment of cannel coal instead of shale, the processes of Du Buisson and Young are essentially the same. This process has created a new and rapidly-

increasing branch of industry, paraffin-oil and paraffin being economically obtained by it from either cannel coal or shale of certain kinds. Some of these shales yield as much as 30 to 50 gallons of crude oil per ton. Their exploitation has called into existence many large works in the Carboniferous tracts of Scotland, as well as at various localities in England and Wales.

Owing partly to the comparative cheapness of shale, and partly also to the fact that these products are obtained from it in a state more easily purified than when they are got from coal, the use of the latter as a source of them is now almost entirely given up. In Scotland, where the manufacture of paraffin-oil is chiefly carried on, the shales used are called 'oil shales,' and there are now between 1,000,000 and 2,000,000 tons of this material annually distilled. The yield of crude oil, paraffin or burning oils, lubricating oil, paraffin scale or wax, and sulphate of ammonia in various periods of years will be found at the article PARAFFIN. In the refining process the crude oil is reduced to about one-half of its bulk before it is fit for burning. Besides the above, there is also a considerable quantity of 'coal gas' unavoidably produced, and partly wasted. But for the distance of the oil-works, this would be consumed in some of the larger Scottish towns. Shales found in the Lias and some other formations likewise yield mineral oil. See also CLAY, ARGILLACEOUS ROCKS.

Shalloon, a light worsted cloth, believed to have been first made at Châlons-sur-Marne.

Shallot, also ESCHALOT (*Allium ascalonicum*), a species of Allium—Onion—(q.v.), a native of the East, introduced into Europe by the Crusaders—from Ascalon, it is said—and much cultivated for its bulbs, which are used like those of the onion, and sometimes for its leaves, which are used like those of the chive. The leaves grow in tufts like those of the chive, but are larger. The shallot is generally propagated by the cloves, which are planted just beneath the surface of the ground, or only partially beneath it, in spring, and the crop is ready for gathering in July or August. The flavour resembles that of garlic, but is much milder. In the vineyards of Italy the shallot is naturalised.

Shaloo. See DURRA.

Shama. See CAGE-BIRDS.

Shamanism, a name applied loosely to the religion of the Turanian races of Siberia and north-eastern Asia, based essentially on magic and sorcery. Their Heaven-God Ukko is but the chief among a host of nature-spirits capable of being influenced and even forced into obedience by the spells of *shamans* or sorcerers. 'The only trace of the influence of Buddhism,' says Max-Müller, 'among the Kudic races, the Finns, Lapps, &c., is found in the name of their priests, *Shaman* being supposed to be a corruption of *Sramana*, a name applied to Buddha and to Buddhist priests in general.' The Siberian Shaman works his cures by magic, and averts sickness and death by incantations. He works himself up into a frenzy of nervous excitement, beating loudly upon his magic drum, and doubtless is usually the dupe of his own powers. Nor is his superstition any less reasonable than that of the devout Protestant who opens his Bible expecting a divine answer in the first verse on which his eye shall fall; for the latter makes the same assumption that he can compel God to give him an answer, his own faith being the condition. See DIVINATION, MAGIC, and WITCHCRAFT.

Shammai, an eminent doctor of the Jewish law at the time of Herod, head of a most important school, and supreme judge of the Sanhedrim during

the presidency of Hillel (q.v.), along with whom he is, indeed, generally mentioned, and of whom he was, as it were, the complement. Very little is known of the history of his life; but he was probably born in Palestine, and he energetically participated in all the political and religious complications of the country. There was a harshness and rigidity in his character, which contrasts most strikingly with Hillel's proverbial patience. His religious views were painfully strict, and he even tried to extend the rigour which he imposed upon himself to the youngest children; but the zealotism with which later times have charged him is not so much to be ascribed to him as to his school—'the House of Shammai.' This seems, under the adverse circumstances of the commonwealth—sedition within, and the approaching enemy without—to have developed a fanatical zeal that at times surpassed all bounds, and strongly fostered that exceptional exclusiveness which proved both the bane and the saving of Judaism. The discussions of the two rival schools, of which that of Shammai preponderated long after the master's death, turned all upon points of positive law.

Shammy, SHAMOY. See CHAMOIS, LEATHER.

Shamo, or GOBL. See ASIA, Vol. I. p. 486.

Shamokin, a borough of Pennsylvania, 188 miles by rail W. of New York, with rich mines of anthracite coal, and (1890) 14,339 inhabitants.

Shampooing. See BATH, MASSAGE.

Shamrock (Irish, *seamrog*), the national emblem of Ireland, a leaf with three leaflets, or plant having such leaves, sometimes supposed to be the Wood-sorrel (see OXALIDÆ), which unlike some of the rival claimants for the honour is certainly indigenous to Ireland. But the name is more frequently given to some species of Clover, or to some common plant of some of the nearly allied genera, as the Bird's-foot Trefoil (see BIRD'S-FOOT), or the Black Medick. It is not improbable that the name has a sort of general reference to plants with trifoliate leaves indigenous to Ireland; a perfectly satisfactory determination of the species is apparently as impossible as the attainment of botanical accuracy in regard to the emblematic thistle of Scotland. Lesser Yellow Trefoil (*Trifolium minus*) is the plant usually sold in Dublin on St Patrick's Day. The Common White Clover

in clover, though very rare in wood-sorrel)—still causes many a futile search. The shamrock is said to have been first assumed as the badge of Ireland from the circumstance that St Patrick made use of it to illustrate the doctrine of the Trinity. But the story is a late one, and is not found in any of the earlier lives of St Patrick; and so far as the theological argument is concerned, any plant with trifoliate leaves would answer the saint's purpose equally well.

Shamyl (i.e. Samuel), chief of the Lesghians and leader of the independent tribes in the Caucasus in their thirty years' struggle against all the might of Russia, was born at Aul-Himry in northern Daghestan, became a priest or mollah, and laboured with zeal and religious fervour to compose the numerous feuds of the Caucasian tribes and unite them in antagonism to their common enemy, the infidel Russians. He was one of the foremost in the defence of Himry against the Russians in 1831. In the end of 1834 he was elected 'imam,' or head of the Lesghians, and soon made himself absolute temporal and spiritual chief of the tribes of Daghestan. He at the same time introduced a change of military tactics, abandoning open warfare for surprises, ambuscades, &c., which brought numerous, and sometimes great, successes to the arms of the mountaineers. In 1839 the Russians succeeded in hemming Shamyl into Achulgo in Daghestan, took the fortress by storm, and put every one of the defenders to the sword in order to be quite certain that Shamyl should not escape. But by some mysterious means he did escape, and suddenly appeared preaching with more vigour than ever the 'holy war against the infidels.' Ten years later he again escaped from the same stronghold after the Russians had made themselves masters of it. The Russians were completely baffled, their armies sometimes disastrously beaten by their unconquerable foe, though he began to lose ground through the long continuance of the struggle and the exhaustion it naturally brought with it. During the Crimean war he was helped by the allies, who supplied him with money and arms; but after peace was signed the Russians resumed their attacks upon the Caucasian tribes with more energy, opened a road over the mountains, thus cutting off one portion of the patriots, and so compelled their submission. On April 12, 1859, Shamyl's chief stronghold, Weden, was taken after a seven weeks' siege, and his authority, except over a small band of personal followers, was wholly destroyed. For several months he was hunted from fastness to fastness, till at last (September 6, 1859) he was surprised on the plateau of Gounib, and after a desperate resistance, in which his 400 followers were reduced to 47, he was captured. He was assigned a residence at Kaluga in the middle of Russia, with a pension of £1000, and he died at Medina in Arabia in March 1871, having taken up his residence in Mecca the year previously. In faith he was a Sufi.

Shandon, ST ANNE, a church of the city of Cork (q.v.), famous for its peal of bells. It contains the tomb of 'Father Prout.' See MAHONY.

Shanghai, the most important seaport for central China, stands on an affluent of the Yangtze-kiang, about 12 miles from its mouth and 160 miles SE. of Nanking. The Chinese city, with narrow, filthy streets, is surrounded by a wall, and between it and the river lie densely-crowded suburbs. On the north of the Chinese city the French and English settlements, with broad streets, well lighted, well paved, and handsome houses and public buildings, stretch northwards parallel to the river. The English cathedral was designed by Sir G. Scott. Powerful batteries guard the river-



Lesser Yellow Trefoil (*Trifolium minus*).

(q.v., *Trifolium repens*) has had a superstitious respect attached to it from early times, and is frequently treated as the Irish shamrock; though it is believed to have been but recently introduced into Ireland, where it is not so common as in England. According to the elder Pliny, no serpent will touch it; and the luck attached to the finding 'four-leaved clover'—a leaf with four leaflets instead of three (a not very uncommon monstrosity

approach. The city lies low, and suffers greatly from dysentery, cholera, and fevers during the very hot summers. Here is the court of appeal for all the foreign consular courts of China and Japan. Shanghai has an enormous trade in tea and silks, and in cottons, woollens, opium, and metals, besides innumerable other commodities. It taps the provinces of middle China by a vast and complicated system of interlacing canals, and so gets the lion's share of the tea and silk to export. The total trade of the port, excluding the junk trade (of which no customs returns are made), has grown enormously since Shanghai was thrown open to foreign commerce in 1842; in 1890 and the years immediately preceding it the gross trade of the port was valued at an average of £37,853,000 annually, or a little more than the trade of Hull, the third port of England. Hong-kong with a trade worth £41,000,000 annually is the only port in China that surpasses Shanghai. A large proportion (£22,715,000) of the grand total of the trade of Shanghai is for goods (foreign and native) that are re-exported abroad and to other Chinese ports—i.e. for goods in transit. Native produce from the immediate neighbourhood of Shanghai is exported to the annual value of £8,746,000; this is of course in addition to the foreign and native re-exports. The actual imports reach a total of £22,036,000 (1897) for purely foreign goods (including goods from Hong-kong), and £12,293,000 for native Chinese produce. The share of Great Britain in the total trade (nearly two-thirds for imports) amounts to £8,180,000 a year; next comes the trade with Hong-kong (four-fifths for exports), with India (nearly all for exports), with Japan (two-thirds exports), and with the United States (£2,393,600, five-eighths imports). Silk and silk goods are exported to the value of £7,690,000, and tea to £2,686,000; next come raw cotton (£1,523,000), rice, sugar, paper, straw-braid, medicines, tobacco, skins and hides, native cloth, hemp, wool, wheat, oils, flower and fruit seeds, fans, and a host of minor articles. Indian tea is gradually supplanting China tea in the markets of the world, and the Chinese planters are beginning to grow cotton instead of tea. The imports of greatest value from foreign countries (including Hong-kong) are cotton goods of all kinds (£9,948,000), opium (£3,249,000); this item is steadily declining), metals, woollens, coal, kerosene oil, *bêche de mer*, edible birds'-nests, dyes, ginseng, matches, pepper, sandalwood, seaweed, timber, shark's fins, &c. The port is entered annually by some 2900 vessels of 2,700,000 tons burden; of these nearly one-half with more than half the tonnage are British, and only 900 of 710,000 tons are Chinese. Pop. (1897) 450,000 (about 3000 foreigners).

Shanklin, a watering-place on the south-east coast of the Isle of Wight, 8 miles by rail S. of Ryde. Pop. (1881) 2740; (1891) 3277.

Shannon, the largest river of Ireland, rises in the Cuilcagh Mountains, County Cavan, and falls after a course of 254 miles into the Atlantic Ocean between Loop Head and Kerry Head. Flowing south-westwards, it soon reaches Lough Allen in Leitrim; thence it proceeds through a succession of expansions—Loughs Boderg, Bofin, Forbes, Ree, and Derg—past the towns of Carrick, Athlone, and Killaloe, to Limerick. There it departs from the southerly direction it has hitherto pursued and turns westwards, forming a wide estuary some 70 miles long and 10 miles across at its seaward extremity. About 10 miles from the entrance the river narrows to about $1\frac{1}{2}$ mile in width. Outward navigation commences at Foynes, which is connected by railway with Limerick, and from which steamboats ply daily to Kilrush, Tarbert, and the intermediate stations. Vessels of 1000 tons can,

however, get up to Limerick, and small steamers to Athlone; boats ascend the river to beyond Lough Allen. Several tributaries fall into the Shannon, as the Suck and Fergus from the right, and the Inny, Brosna, Mulkear, Maigue, and Deel from the left. The main river is canalised for some distance below Athlone, and again between Killaloe and Limerick. This important system of navigation, which occupies a position almost midway between the east and west coasts of Ireland, is connected with Dublin by means of the Grand and Royal Canals.

Shanny. See BLENNY.

Shans, a number of tribes of common origin, who live on the borders of Burma, Siam, and China, to which three states they are in great part subject, though some are independent (see map at Vol. II. p. 562). They are the descendants of an aboriginal race of China; their home generations ago was in the mountainous region on the borders of the Chinese provinces of Sze-chuen and Shensi. In the course of time they have been pushed southwards. They seem to have entered the valley of the Irawadi in the 6th century B.C. The Shans and the Laos are one and the same people, and both are closely akin to the Siamese. The country the Shans inhabit may be broadly described as a succession of wide river-valleys (of the Menam, Meping, Mekok, Mekhong, &c.) separated by high ridges; on the north it climbs up to the Yunnan plateau of southern China. There are extensive and valuable forests of teak; iron, rubies, and silver are extracted, and gold, copper, coal, and petroleum are known to exist. Rice, cotton, and tobacco are the crops most extensively grown. The people are noted for chased work in gold and silver. The tribes that acknowledge the supremacy of Siam are estimated to number 2,000,000 people; at the census of 1891 it was computed that there were about the same number under British rule in Burma. The number of Shans subject to China, and the numbers of the independent tribes, are alike unknown. But equally whether tributary or independent, they are distributed amongst several states, of which the most important are Zimmé (Chieng-Mai), Kiang Hsen, Lapon, Nan, Lakhon, and Peh, tributary to Siam; Luang-Prabang, now French; Kiang Hung, Kiang Tung, Mone, Katchin, and others now incorporated in Burma. The Shans are an indolent, laughter-loving people, fond of gambling and cock-fighting, not unwarlike, though orderly and fairly trustworthy; the women have great influence, and enjoy equal freedom with the men. Slavery, however, exists, but in a mild form; and serfdom is general. The rule of the native chiefs is generally just and mild, and taxation is light. Buddhism is the dominant religion, though it is mingled with many superstitious practices. Zimmé and others of the principal towns are the seats of a very extensive transit trade between Yunnan, Tali, and the marts of southern China, on the one side, and Bangkok and the ports of Burma on the other; the traders, mostly Chinamen, bring down from Yunnan silks, iron and copper utensils, opium, straw-hats, beeswax, figured cloth, tea, and walnuts, and take back cotton, raw and woven, and European manufactured goods. There is also a large trade in the native commodities—horns and hides, ivory, cutch, gold-leaf, saltpetre, sapan wood, salt, lead, steel, betel-nuts, stick-lac, &c. Since 1881 Messrs Hallett and Colquhoun have been advocating the construction of a railway from Bangkok to Kiang Hsen, on the northern frontier of Siam, and thence to Ssumao on the Chinese border, with a branch-line of 100 miles from Maulmain in Burma. Other

alternative routes are proposed to the commercially very important provinces of southern China; the one which apparently the government of India favours is an extension of the Burman system northwards from Bhamo.

The first Shan state to rise to the level of historical importance was the Mau kingdom, the ruler of which in the 13th century conquered all Burma, the upper parts of Siam and the Malay Peninsula, and made his influence felt from Tali in China as far as Java and Cambodia. All the northern portions of this extensive empire, including Burma, were ruled by Mau princes down to 1554. Shortly after that date the tables were turned, and most of the Shan states became tributary to the emperor of Pegu. Other powerful states about the same period were Zimmé and Vien-chang. The former still exists, but subject to Siam; the latter, a Laos state, was destroyed in the 18th century. About 1774-77 Siam drove out the Burmese and Peguans, and made herself mistress of the southern Shan states, Zimmé and Vien-chang. Ruins of large cities exist in great numbers throughout the middle portions of the Shan country; they are the relics of the ephemeral capitals of different Shan states.

See Holt S. Hallett, *A Thousand Miles on an Elephant* (1890); Colquhoun, *Amongst the Shans* (1885); Cheek, *Siam and Laos* (Amer. Presb. Mission Board); Carl Bock, *Temples and Elephants* (1884); E. Aymonier's articles 'Les Tehames et leurs Religions' in the *Revue de l'Histoire des Religions* for 1891; and books quoted under SIAM.

Shan-se, a province of northern China, having the Hoang-ho on its western boundary. See CHINA.

Shapinshay. See ORKNEY ISLANDS.

Shapira. See FORGERY.

Sharebroker. See BROKER, and STOCK EXCHANGE.

Shareholder. See COMPANY.

Shari (i.e. river), the principal feeder of Lake Tsad (q.v.) or Tchad.

Shark, a common name for most of the Elasmobranch fishes included in the sub-order Selachioidei. They are voracious fishes, with two or three exceptions carnivorous, the smaller forms often eating crustaceans and molluscs, as well as fishes, to which the larger forms almost exclusively restrict themselves. They sometimes devour men who swim incautiously in warm seas. Unlike the flattened rays, the sharks usually preserve the typical fish-like form, and the gill-slits are lateral, not ventral. In most the skin is covered with minute thickly-set skin-teeth, really like those of thornbacks, but much smaller and more numerous. The teeth on the jaws are very sharp, generally triangular, and are disposed in rows. In most cases only the row on the ridge of the jaw is in use, but as this is worn away it is replaced by the next row, which is gradually moved forward. Some of the sharks are viviparous, others are oviparous. In the latter each egg is enclosed in a horny 'mermaid's purse.'

As to their distribution, sharks, though most numerous in the tropics, are represented in almost all seas, and many venture up estuaries and rivers. One species occurs in Lake Nicaragua. Many live in the open sea, and voyagers know how they follow the ships, hungrily swallowing—with little discrimination—what refuse is thrown overboard. Though few are like the Portuguese Shark (*Centroscygnus cololepis*) in living in deep water, not a few live a sluggish existence at the bottom of relatively shallow water near the shore. Many of the smaller forms are gregarious, and prey upon the shoals of herring and mackerel.

The classification of sharks has not yet been

placed on a thoroughly firm basis. Günther recognises the following families. Carchariidæ include the genus *Carcharias*, of which the Blue Shark (*Carcharias glaucus*), 12-15 feet in length, and the larger White Shark (*C. vulgaris*) are representative; the genus *Galeocerdo*, with several formidable species; the genus *Galeus*, of which the Tope

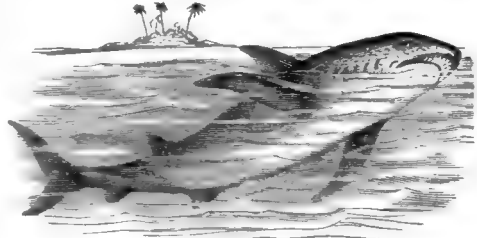

White Shark (*Carcharias vulgaris*).

(*Galeus canis*) occurs on British coasts; the genus *Zygæna*, notable for the large transverse eye-bearing lobes of the snout to which these voracious fishes owe their name Hammer-head (q.v.); the genus *Mustelus*, with small species known as 'Hounds.' In *Mustelus levis* and *Carcharias glaucus* there is a peculiar placenta-like connection between the mother-fish and the yolk-sac of the unborn young.

Lamnidæ include numerous large pelagic sharks, such as the Porbeagle (*Oxyrhina cornubica*), which frequents the North Atlantic, attains a length of 10 feet, and is said to swallow its prey whole; the Man-eater Shark (*Carcharodon rondeletii*), in all tropical and temperate seas, attaining a length of 36 feet; the Fox-shark or Thresher (*Alopias vulpes*), not uncommon around British coasts, attaining a length of 13 feet, notable for the enormously elongated upper lobe of its tail, and for its voracious attacks on herring and mackerel; the Basking-shark (*Selache maxima*), attaining a length of 30 feet, living on small fishes, often in the habit of lying passive, and like the thresher harmless to man unless attacked. The *Challenger* explorers dredged numerous large teeth belonging to some shark of the genus *Carcharodon*; as these measured 5 inches along the side and 4 across the base, there must be some larger species than *Carcharodon rondeletii* either still alive or not long since extinct.

Notidanidæ are a small family including a few tropical or subtropical sharks, sometimes called cow-sharks, and referable to the genus *Notidanus*, from which, however, some distinguish two other genera, *Hexanchus* with six gill-slits, and *Heptanchus* with seven.

Scylliidæ are a family of small sharks, usually called dog-fishes, including *Scyllium caniculum* and *S. catulus*, the common dog-fishes of British shores; *Stegostoma tigrinum*, a beautiful striped shark frequenting the Indian Ocean; and the Indo-Pacific ground-shark (*Crossorhinus*), which lurks on the bottom, and is protectively coloured.

Cestraciontidæ, a family now somewhat decadent, twenty-two of the twenty-five genera being extinct. The living forms—e.g. *Cestracion* or *Heterodontus guleatus*—are called Port Jackson sharks. The front teeth are small and sharp, those behind are flat and arranged in pavement-like rows.

Spinacidæ are a family including the small spiny dog-fishes—e.g. *Acanthias vulgaris* and *A. blainvillii* on British coasts; the voracious Greenland Shark (*Læmargus borealis*), which attains a length of about 15 feet; the Black Dog-fish (*Centroscyllium fabricii*) of Arctic seas; *Centroscygnus cololepis*, which is caught off the coasts of Portugal

from a depth of 400–500 fathoms; the Spinous Shark (*Echinorhinus spinosus*), a Mediterranean form, which seems also to live in deep water.

Rhinidae are a family represented solely by the almost cosmopolitan, somewhat ray-like, Angel-fish or Monk-fish (*Rhina squatina*).

Pristiophoridae are a family parallel to the Pristiuridae among the rays, for the genus *Pristiophorus* has its snout prolonged into a saw as in the much larger genus *Pristis*.

It seems necessary furthermore to establish a family for a remarkable Japanese shark, *Chlamydoselachus anguineus*, a somewhat eel-like animal, 6 feet long, less than 4 inches in diameter, suggestive of a sea-serpent, but more important since it seems as if it were a direct descendant of forms which flourished in Devonian times (see FISHES).

Sharks are destructive to food-fishes and to fishermen's nets, and sometimes attack man himself. On the other hand, many of the smaller forms are eaten by man; the gristly fin-rays are used in China in the making of gelatine; the livers are sometimes utilised as sources of oil; the skin of those which are thickly beset with skin-teeth was formerly much used by cabinet-makers for polishing purposes, serving, under the name of shagreen, instead of sandpaper.

Sharon, the name of an extensive tract of plain and corn-land (partly under cultivation) in Palestine, lying between the sand-dunes of the coast and the foot-hills of the interior, and extending from the neighbourhood of Carmel on the north to near Joppa. The so-called Rose of Sharon is the subject of an article.

Sharon, a borough of Pennsylvania, on the Shenango River, 71 miles by rail NNW. of Pittsburgh. Its manufactories include rolling-mills and foundries, steel and boiler works, a chain-factory, planing and flour mills, a soap-factory, and machine-shops; and coal is largely mined near by. Pop. (1890) 7447.

Sharp, a sign ♯ in Music, which, when prefixed to a note, elevates it by a semitone in the scale. See MUSIC, Vol. VII. p. 357. A double sharp × raises a note two semitones.

Sharp, ABRAHAM, a meritorious mechanist and astronomer, who, born at Little Horton near Bradford in 1653, and apprenticed to a tradesman, became a schoolmaster, and acquired a thorough knowledge of mathematics and the cognate sciences. Having also acted as exciseman and bookkeeper in a London office, he was in 1688 asked by Flamsteed to assist in mounting instruments at Greenwich Royal Observatory. There for some years he did admirable work on the instruments, perfecting hand-graduation and other processes, and making many very valuable observations; and after retiring to Horton, he continued to assist Flamsteed by his extraordinary powers as a calculator. He published tables of logarithms and a treatise, *Geometry Improved* (1717), and made observations in a small observatory fitted up by himself. He died 18th July 1742. See his *Life and Correspondence*, edited by Cudworth (1889).

Sharp, GRANVILLE, abolitionist, was the son of the archdeacon of Northumberland, and was born at Durham in 1734. He came to London, and, after studying law, obtained a post in the Ordnance Office; but this he resigned in 1777 on the outbreak of the war with America, of which he disapproved. He was the author of upwards of sixty-one publications—mainly pamphlets—on philological, legal, political, and theological subjects (the English tongue, hundreds and tithings, the definite article in the Greek Testament, Hebrew syntax and pronunciation, Melchisedek, Armageddon); but his principal writings and the main labours of his life were

in defence of the negro, and for the abolition of the slave-trade and slavery. He defended the cause of the negro Somerset, securing the decision of the twelve judges (1772) that whenever a slave touches English soil he becomes free. He was with Clarkson one of the founders of the Association for the Abolition of Negro Slavery, and assisted in the establishment of the colony of Sierra Leone for freedmen. He died in London, 6th July 1813. There is a *Life* by Hoare (1820), and a smaller one by Stuart (New York, 1836). See also SLAVERY.

Sharp, JAMES, Archbishop of St Andrews, was born at the castle of Banff on 4th May 1618, the son of the sheriff-clerk of Banffshire. Educated for the church at King's College, Aberdeen (1633–37), he afterwards visited England, and became acquainted with several eminent English divines, as Hammond, Sanderson, and Taylor. In 1643 he was appointed a 'regent' of philosophy at St Andrews, and in 1648 minister of Crail, an office which he held throughout Cromwell's ascendancy. In 1651, however, when Monk was reducing Scotland to obedience, Sharp was carried off to England with several other ministers; but he quickly regained his liberty, and for some years enjoyed the confidence of the 'Resolutioners,' or more moderate party in the church. In 1656 he was chosen by them to plead their cause in London before the Protector against the 'Protesters;' and Baillie speaks of him on this occasion as 'that very worthy, pious, wise, and diligent young man.' On the eve of the Restoration he was sent up again to London to use his utmost endeavours with Monk in favour of the Kirk of Scotland, and at Monk's suggestion he crossed over to Breda, and had several interviews with Charles II. His correspondence for some months after his return from Holland is full of apprehensions of Prelacy, 'cassock-men,' and the Service-book; but its perfidy stands revealed in his letter of 21st May 1661 to Middleton, which proves that he was then (as probably before) in confidential communication and hearty co-operation with Clarendon and the English bishops for the immediate re-establishment of Episcopacy in Scotland. The bribe was a great one, for on 16th December he was consecrated Archbishop of St Andrews, having first received Episcopal re-ordination. The supple and dexterous tool of Middleton or Lauderdale, as either gained the ascendancy, a liar and coward, and a vindictive oppressor of those he had betrayed, he soon became an object of detestation to the populace and of contempt to his employers. When in 1668 Robert Mitchell, a conventicle preacher, fired a pistol at him in the streets of Edinburgh, the bystanders suffered the fanatic to escape—only, however, to be executed ten years later on his own confession, enticed from him by an assurance of his life. At last, on 3d May 1679, on Magus Muir, twelve Fife Covenanters—Hackston of Rathillet, John Balfour of Kinloch, the rest peasants or artisans—fell in with him as he was driving with his daughter to St Andrews, and, dragging him from his coach, hacked him clumsily to death in spite of his frantic prayers. In his epitaph at St Andrews Sharp is described as 'a most pious prelate, a most prudent senator, and a most holy martyr;' but to-day even his apologists can plead little for him but that he was not licentious, that his portrait is not that of a monster of cruelty, and that he was simply an ambitious ecclesiastic of plausible and courtly manners, who may have thought that, if there must be an archbishop of St Andrews, there was no great reason why he should not be the man.

See vol. vii. of Hill Burton's *History of Scotland* (ed. 1874); O. Airy's *Lauderdale Papers* (Camden Soc. 1884); an article in the *North British Review* (1848); and two in the *Scottish Review* (1884–85).

Sharp, WILLIAM (1749-1824), an engraver, republican, and enthusiast, who was born in London, and died at Chiswick. See his Life by W. S. Baker (Phila. 1875).

Sharpe, CHARLES KIRKPATRICK, virtuoso, was born at Hoddam Castle, Dumfriesshire, 15th May 1781, and in 1798 entered Christ Church College, Oxford, where he graduated B.A. in 1802. In 1813 he fixed his bachelor home in Edinburgh (No. 93 Princes Street), and here he died in March 1851. A Scottish Horace Walpole (with a difference), he was a great collector of pictures and curios, was a clever versifier and a clever draughtsman, wrote for the *Anti-Jacobin*, contributed two original ballads to the third volume of Scott's *Minstrelsy*, and edited several club-books, but is chiefly remembered nowadays by his immense correspondence, two big volumes of which have been edited by Alexander Allardyce (Edin. 1888).

See the *Memoirs* prefixed thereto and to his *Etchings and Prose Fragments* (Edin. 1869), and a third in Mark Napier's *Memoirs of Montrose* (4th ed. 1856).

Sharpe, SAMUEL, biblical scholar, was born in London, March 8, 1799, a descendant of Philip Henry and nephew of Rogers the poet, in whose bank he worked till sixty. From an early age he took to the study of Egyptology, and his *Egyptian Inscriptions* (1836-41-56) showed creditable learning and more than creditable industry. Later books were a *History of Egypt* (1846) and a *History of the Hebrew Nation and Literature* (1869); a translation of Griesbach's text of the New Testament (1840), a revision of the Authorised Version of the Old Testament (1865), besides works on Hebrew grammar, on the chronology of St Paul's epistles, &c. Sharpe was a man of singular amiability, a Unitarian in religion, honest and painful beyond most; but his work suffered from the deficiencies in his training, the over-ingenuity natural to a self-educated man, and the lack of knowledge of the work of contemporary German scholars. He died in Highbury, July 28, 1881. See the Life by P. W. Clayden (1883).

Sharpshooters, an old term applied in the army to riflemen when skirmishing or specially employed as marksmen. Any soldier or sailor might now be called a sharpshooter under certain circumstances.

Shāstra, or SHĀSTER (Sansk. *S'āstra*, from *śā*, 'to teach'), means literally a book; but the term is especially applied to the authoritative, religious and legal, books of the Hindus.

Shat-el-Arab. See EUPHRATES.

Shaving. See BEARD.

Shaw, JACK, life-guardsmen. See PUGILISM.

Shawl (Persian *shāl*). As may almost be inferred from the simplicity of its form, this garment is of high antiquity. Even the elaborately-wrought and beautiful shawls of India and Persia have been continuously made from an early time. Sir George Birdwood (*Industrial Arts of India*) suggests that the description of rich apparel in Ezek. xxvii. 23, 24, may refer to Cashmere shawls imported into Tyre through Aden. The patterns of these shawls, but little changed in the course of centuries, are sometimes produced by weaving and sometimes by a kind of embroidery, but in either case the work is slow and tedious. Cashmere shawls are made of a very fine material called *pashm* or *pashmina*, consisting of the inner or under-wool of the shawl-goat of Tibet (see CASHMERE GOAT). This wool is separated with much care from the longer hair of the animal, and is then cleaned and spun with great delicacy into a fine thread, the best quality of which sells as high as from £2 to £2, 10s. per lb. The dyeing of the yarn

is a very important and difficult operation, almost all the colours from native dyes being permanent. Unfortunately aniline dyes were and may still to some extent be used, but they are now practically prohibited.

In the case of those shawls which have their patterns produced by needlework or embroidery the ground consists of a plain pashmina fabric, and the thread used for the pattern is of the same material. The shawls with loom-woven patterns, notwithstanding their intricate nature, are made on very rude and primitive looms. Three or sometimes four weavers are engaged at one of these looms, and instead of using shuttles they work with numerous wooden needles (each being supplied with coloured yarn), which have slightly charred ends but no eyes. The shawls are woven face downwards, and the work is carried on at the back or reverse side, on which the needles hang in rows. After the threads are worked in to suit the pattern across one line of weft, they are knotted to the warp and driven firmly into their place by the reed or comb. On an average five shawls are produced on one loom in a year, but a loom may be occupied during this period with only one shawl if it is of very fine quality and of an elaborate pattern. These shawls are, however, often woven in separate pieces and so neatly joined together that a shawl so made looks as if it had been woven in one piece.

Exceptionally fine Cashmere shawls are high in price. Mr Baden Powell (*Manufactures of the Punjab*) states that one of first-rate quality, weighing 7 lb., will cost in that country as much as £300. This price is made up of the following items: Material, £30; wages of artisans, £150; duty, £70; miscellaneous expenses, £50. But in the case of an exported shawl we must add customs duty, cost of carriage, commission to broker who manages the sale and export, something for the risk of robbery, which by some routes is great, and other incidental expenses. These shawls are, however, made as low in price as £15 for one in eight colours and of comparatively simple design.

Inferior shawls are manufactured in the Punjab by artisans who at various times have emigrated from Cashmere. They are woven at Amritsar, Ludhiana, Jalalpur, Nūrpur, and a few other places. For these the fine pashm is mixed with another kind of goat's wool called *koork* from Kerman in Persia. Shawls somewhat resembling those of Cashmere, though much less costly, are largely manufactured at Kerman itself, the *koork* of which they are made being, like the pashm from the Tibetan goat, the under-wool of the animal. But the most beautiful shawls woven in Persia are made of silk, and these too are like fine Cashmere shawls in general appearance. Both in India and Persia shawl-cloth is made into tunics and other shaped articles of dress for both men and women.

The production of shawls was until recent years a very important manufacture in France, and gave occupation to a large number of designers in Paris, who not only furnished designs for those woven in their own country—chiefly at Paris, Lyons, and Nîmes—but also for shawl-manufacturers in England and Austria, and even for some woven in Cashmere. In 1867 it was estimated that the annual value of the French shawl trade amounted to nearly a million pounds sterling. Shawls of various kinds are made at different places in England, and in past years many of these were designed in the Indian style. At Paisley in Scotland, where for many years previous to 1860 the manufacture of shawls was of great importance, the trade originated in the beginning of the 19th century. They were made of silk, wool, or cotton, either separately or in combination; but the best-known class of Paisley shawls was manufactured of fine wool

and with patterns in the style of those woven in Cashmere. As many as 8000 looms were at one time occupied in the weaving of these. Soon after the middle of the century, however, the manufacture began to decline, and for some years past no shawls of this character have been woven. Tartan shawls, but chiefly of small size, for indoor or occasional wear, are still made at several places in Scotland.

The change which has taken place during the last quarter of a century in the nature of female costume is remarkable. Tweed fabrics and other soft woollen cloths of a plain character, similar to those worn by men, have completely taken the place of the richly-patterned shawls and plaids of former days. Even in a country like Persia, where, as has been stated, shawl-stuff formed part of the attire of both sexes, the characteristic native dress, so long tenaciously adhered to, is gradually being abandoned for coats and other garments of European broadcloth. The time has at last come when the shawl-fabrics of Cashmere, which for many centuries have never ceased to charm the female world, are no longer in demand, and the art of manufacturing them is in danger of becoming lost.

A few words may be said about the patterns of Cashmere shawls, which have been placed by the

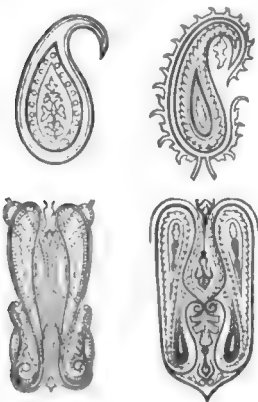

most distinguished decorative artists of modern times in the highest order of art manufacture. The most characteristic feature in a typical design is what has been usually called the 'cone' or 'pine cone,' of which a few varieties are shown in the annexed figures. It appears, however, to be really a conventional representation of a wind-bent cypress-tree, as the term *sarv*, the native name of that tree, is also applied to this pattern or

part of a pattern. The form has many modifications, one or more of which often make up the groundwork of the designs of other textile fabrics both in India and Persia, and it even appears on metal-work and papier-mâché made in Cashmere. Sometimes it is simply called the shawl pattern. It is, however, not merely the graceful outline of their ornamental devices, but also the harmonious blending of their deep-toned colours, which gives a singular charm to these exquisite productions of eastern looms.

Shawnees, a tribe of American Indians of the Algonquin family, formerly settled mainly in New York, Pennsylvania, and Ohio, but driven westward by the Iroquois. They helped the French against the English, gave trouble to the newly-founded United States, and in 1812 some bands joined the English. They afterwards removed to Missouri, Kansas, and Indian Territory.

Shen Oak, or SHE OAK. See CASUARINA. For Shea Butter, see BUTTER-TREE.

Shear-steel. See STEEL.

Shearwater, a genus of birds belonging to the petrel family, Procellariidae, included by Linnaeus in the genus Procellaria, but separated by Brisson in 1760 as the genus Puffinus. These birds vary from 8½ to 14 inches in length. The bill is rather longer than the head; the mandibles are

compressed and decurved; the nostrils open separately, not by a common tube; the wings are long and pointed; the legs are of moderate length; the tarsi are compressed laterally; the three toes in front are webbed, and the hind-toe is very small. The genus includes twenty or more species, and is cosmopolitan in its distribution. The shearwaters, however, are exclusively oceanic species. They spend most of their time on the wing, and can swim with great ease, but rarely if ever dive. They are usually silent, but at their breeding-grounds they utter soft agreeable notes. Their principal food is fish. A single white egg is laid in a hole in the ground. The species found in the British Isles are classified by Seebohm thus:

Lores and upper ear-coverts same colour as the crown.	{	Sooty Shearwater (under parts uniform brown).
		Great Shearwater.
		Manx Shearwater
		Dusky Shearwater } wing 9½ inches or under.

The Sooty Shearwater (*Puffinus griseus*) has been found on the east and south coasts of England and Ireland, and is generally distributed over the North Atlantic, but has its breeding-grounds in the southern hemisphere. The Great Shearwater (*P. major*) is common on the south coast of England, but comparatively rare on the east coast. It occurs rarely in Scotland and Ireland, and it visits the south of Greenland. Southwards it extends to Tierra del Fuego and to near the Cape of Good Hope. Nothing is known of its nesting. The Manx Shearwater (*P. anglorum*) is common round the British coasts and on the coasts of Norway

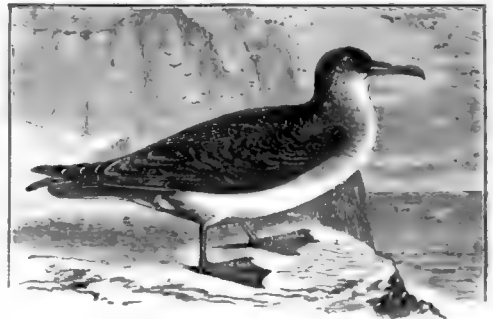

The Manx Shearwater (*Puffinus anglorum*).

and Iceland and even Greenland. Southwards it reaches the Mediterranean and the Black Sea and the Azores, Madeira, and the Canary Islands. This species is nocturnal or crepuscular in habits and dives freely. The Dusky Shearwater (*P. obscurus*) is a rare visitor to the British Isles. It frequents the Canaries, Madeira, Bermudas, Bahamas, and Barbadoes. It is a nocturnal species.

Sheathing. See SHIPBUILDING.

Sheave. See PULLEY.

Sheba. See SABEANS.

Shebeen (Irish), a term in use, especially in Ireland and Scotland, for a house where intoxicating liquors (usually whisky) are sold without a license. See LICENSING LAWS.

Sheboygan, a port, capital of Sheboygan county, Wisconsin, on Lake Michigan, at the mouth of the Sheboygan River, 53 miles by rail N. of Milwaukee. It has a good harbour, and contains foundries, tanneries, breweries, and planing-mills, and manufactures shoes, chairs, toys, &c. Pop. (1880) 7314; (1890) 16,359.

Shechem. See NABLUS.

Shechinah. See ARK OF THE COVENANT.

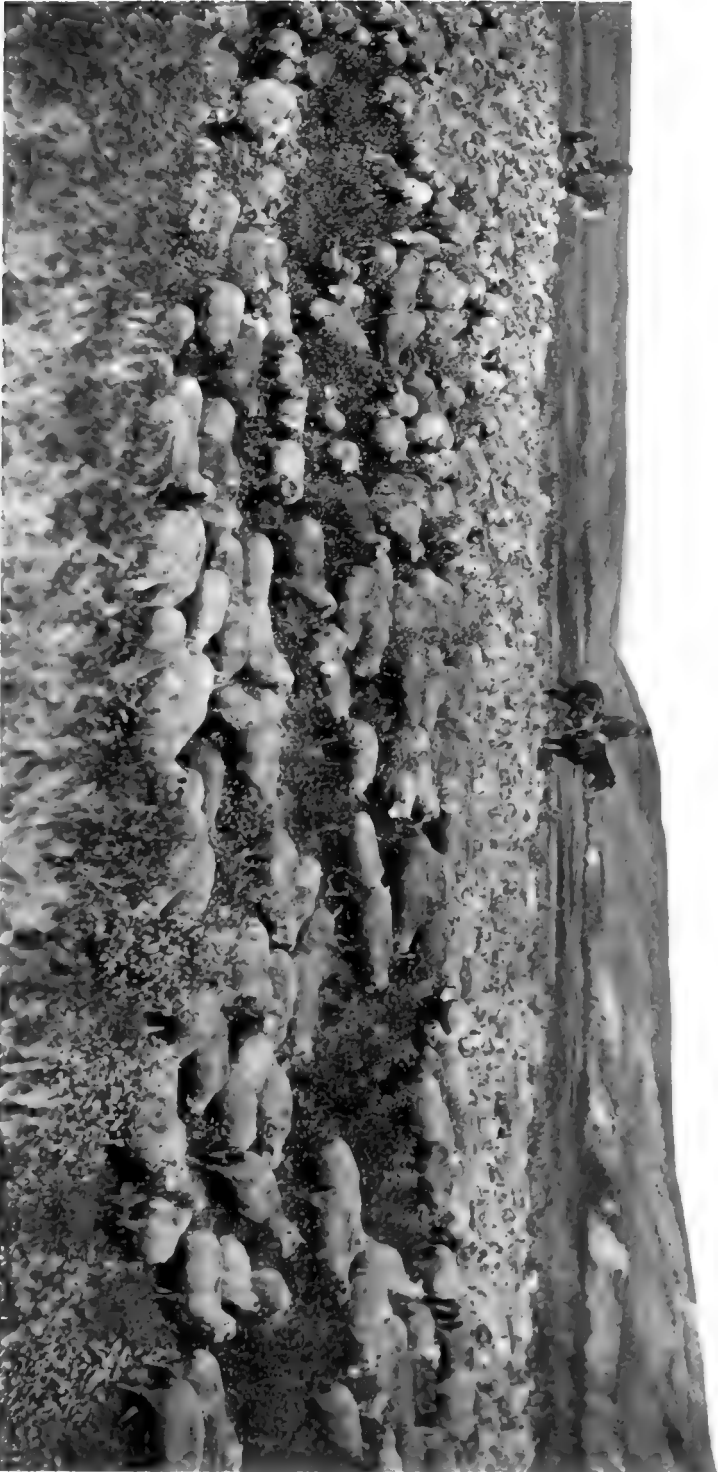

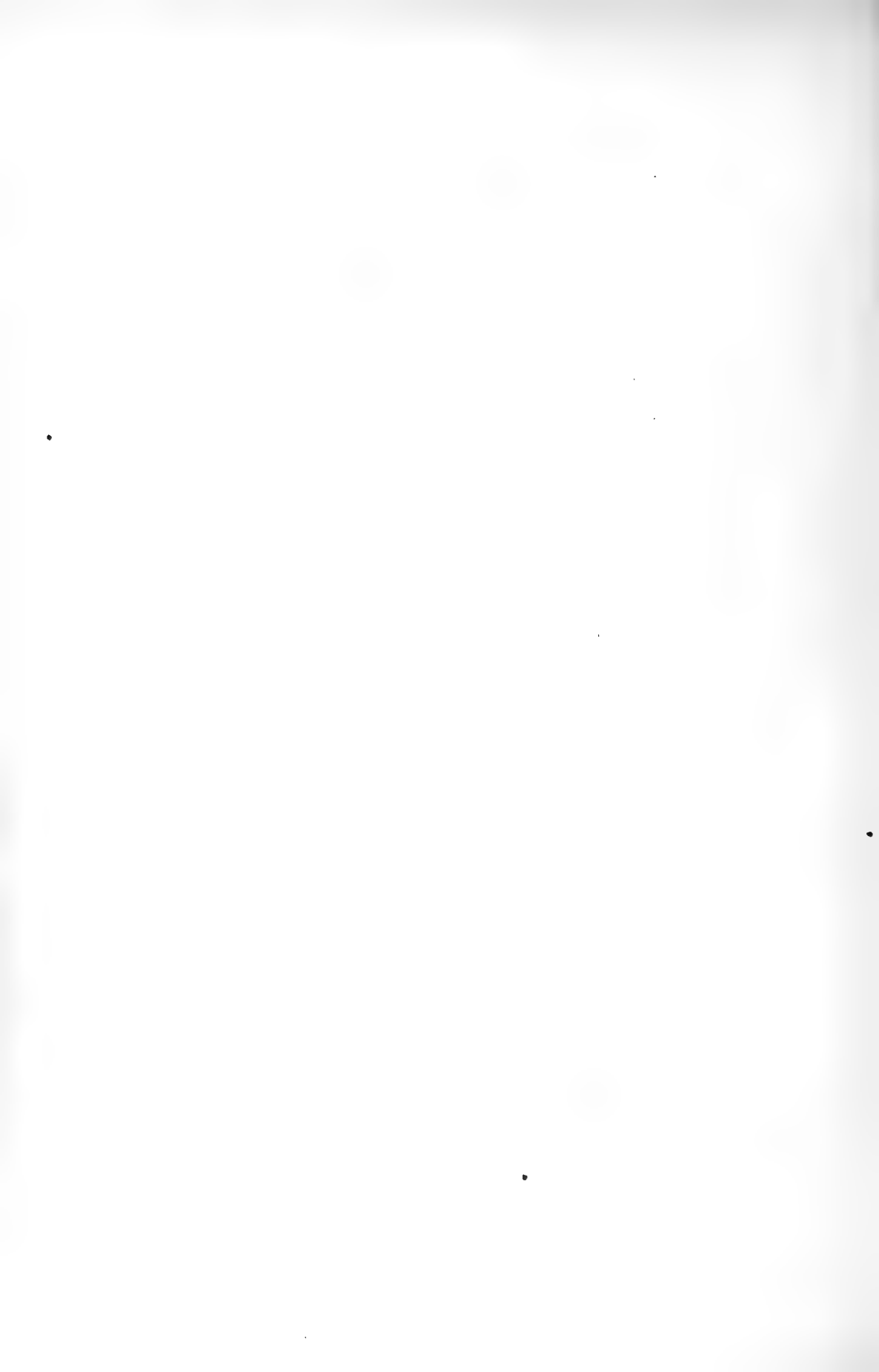

Shee, SIR MARTIN ARCHER, portrait-painter, was born at Dublin, 23d December 1770, studied under West, and as a boy of sixteen became famous as a portrait-painter. In 1788 he settled in London, where he became A.R.A. in 1798, R.A. in 1800, and President of the Royal Academy in 1830, when he was knighted. He was regarded as a rival of Lawrence, though his art was but poor and few of his portraits are now thought much of. He wrote several poems, didactic, tragic, and other; a novel; and a *Plan for the Encouragement of Historical Painting*. He died at Brighton, 19th August 1850. See the Life by his son (2 vols. 1860).

Sheehs. See SHITES.

Sheen. See RICHMOND.

Sheep (*Ovis*), a genus of ruminant quadrupeds of the family Capridæ, so nearly allied to goats that the propriety of generic distinction is very doubtful. They differ from goats in having the outline of the face more or less arched and convex; the horns spiral, sometimes very large in the males—in domestication, however, wanting in many breeds; the chin destitute of a beard; a sac or pit between the toes of each foot, lined with hair, and secreting a fatty matter. Upper incisors and canine teeth are wholly wanting: see BOVIDÆ, CAPRIDÆ. It is supposed by some that all the wild sheep existing in different parts of the world are mere varieties of one species; and it is impossible to say from which of the wild species the domestic sheep is sprung.

All the wild sheep known are natives either of mountainous regions or of dry and elevated tablelands. They are gregarious, a character which the domesticated sheep fully retains. They are generally seen in small flocks, and are not easily approached, taking refuge in flight, a sharp whistling sound emitted by one of the rams serving as an alarm to the whole flock; although they are very capable of making a vigorous defence when driven to close combat. A ram of the domestic species is indeed able to sustain a conflict with a bull, taking advantage of his far greater agility, and butting against his foe with his strongly armed forehead. A ram has been known to throw a bull on the ground at the first onset, and is always ready to defend himself and his companions against a dog. Many rams exhibit great pugnacity. Sheep differ from goats in their mode of fighting; goats rear themselves on their hind-legs, and throw themselves sideways on their adversary, to bring the points of their horns to bear; whereas sheep rush straight at each other, a mode which better suits the different style of armature of the head. Rams of the black-faced variety are especially powerful with their heads, and often at the rutting season kill each other. Their naturally strong skull is further protected in battle by heavy arched horns. A thorough ram fight is a terrifying sight. The two warriors go backwards each some fifteen or twenty yards, and then meet each other with great violence, their heads cracking loudly, and their beam-ends rising in response to the collision of heads. Ewes of this breed fight also. Sheep without horns are not usually so pugnacious as the mountain breeds.

All the wild sheep have short wool, with an outer clothing of long and nearly straight hair. But even the long hair has usually the peculiar character of wool, in that roughness of surface which gives it the property of *felting* (see HAIR, WOOL, FELT). One effect of domestication in the common sheep has been to cause the disappearance of the outer long hair, and to produce instead an increase of the length and abundance of the wool, an object of great importance to the sheep-farmer. In neglected breeds of the common sheep the two kinds of hair

or wool are very apparent. In some tropical climates the sheep loses its abundant fleece, and is covered with hair little longer than that of the ox.

Although not equal to goats in their adaptation to rocky steeps, and not endowed with such power of leaping from crag to crag, most breeds of sheep exhibit a strong disposition to seek their food in places where no animal not very agile and sure-footed could venture; and those of the domesticated breeds which retain much of their original wildness are thus adapted to situations in which otherwise the pasture would be of little value to man. In fine weather sheep ascend the heights, and in cold and stormy weather they repair to the lower grounds. In modern times it has been customary to remove the large flocks from mountainous regions to lower grounds to pass the winter; and in the fall of the year shepherds have difficulty in preventing the animals from leaving the summer pastures too early if the weather is unfavourable. On the other hand, if fine spring weather sets in before the period of removal from the winter-quarters, the flocks keep pressing towards the summering regions. Mountain sheep have favoured spots whither they go regularly over-night, and the ewes generally have choice localities to which they go to lamb. They get much attached to certain pastures, and many of them have been known to return stealthily, in the course of a few days, to their native or appreciated pastures, though removed many miles.

A very interesting species of the wild sheep is the Great Mountain Sheep (*Ovis poli*) on the Thian Shan and other lofty chains of central Asia: 12½ hands high, the horns (each some 6 feet long) forming a wide open curve. It was met with by Marco Polo (hence the technical name), but has only lately been studied or seen. The Argali (*O. ammon*), found east and north of it, is the subject of a separate article. The Moufflon (*O. musimon*) is the wild sheep of the mountains of Greece, Corsica, and Sardinia. The Rocky Mountain Sheep, or Big-horn (*O. montana*), of North America, is equal in size to the Argali, which it much resembles also in its general appearance. The flesh is of the very finest quality. The wool is very fine, and fully an inch and a half long; it is completely concealed by long hairs. The general colour is brown, paler on the lower parts; the old rams are almost white in spring. The Big-horn is found from Nebraska to the Pacific coast-ranges, and from the Rio Grande northward to 68°, and occurs in herds of from three to twenty or thirty. The Aoudad (*O. tragelaphus*), a native of the north of Africa, inhabiting chiefly the lofty parts of the Atlas Mountains, has the throat, the chest, and front of the forelegs adorned with long shaggy hair.

The Common Sheep (*O. aries*) was probably the first animal domesticated by man; Abel, the 'keeper of sheep,' brought an offering unto the Lord 'of the firstlings of his flock and of the fat thereof;' and lambs were amongst the most frequent sacrificial offerings of the Jews. The felting and weaving of wool were unquestionably among the earliest of the arts. The wool was probably at first pulled from the skin, a cruel practice which long survived in some places. Sheep-shearing is often referred to in Scripture. The leather made of the skin of the sheep is much employed in book-binding, and for making gloves. In patriarchal times the milk was much used, as it still is in some countries; it is richer than cow's milk, and the cheese made of it has a sharp taste and strong flavour, which, however, are greatly relished by some. In some mountainous parts of India the sheep is even used as a beast of burden, carrying loads of from 35 to 40 lb. up steep crags, where almost no other animal could be employed.

Those who watch sheep carefully, or keep them

as pets, find them by no means devoid of intelligence. They have, however, a stupid habit of following, without scruple, the leader of the flock; so that, when sheep are being driven across a narrow bridge, or where a fence separates the road from a precipice, if anything occur to deter them from proceeding in the proper path, and one break over the fence or parapet, more of the flock may be expected to follow, as has sometimes happened, to their utter destruction. Sheep very soon come to know the voice of the shepherd, and also the appearance as well as the bark of the shepherd's dog. Though they stand more in awe of the shepherd's voice or commands than of any other human being's, the dogs that regularly move amongst them fail to keep them in such subjection as strange ones do.

The 'rutting' is from September till the middle of December, according to the variety of sheep and the system of feeding. White-faced modern breeds have the tups early among them, and the hill flocks are later. The period of gestation is from 20 to 21 weeks. Ewes occupying sown or low-ground pastures lamb in January, February, and March, while those not so well provided for—the mountain sheep—do not drop their lambs usually till April. The ancient breeds generally have only one lamb in a season, but modern highly-fed varieties frequently have twins, occasionally triplets, but rarely more. There is at least one variety in England, the Dorset Horn breed, which produces two crops of lambs each year. Lambs intended to come early into the market are as often as possible dropped in January. Generally lambs are weaned in July and August. Weaning of breeding or store lambs, however, is a feature of modern sheep-farming; at one time it was not uncommon to see several generations persistently following the parent stem. The shearing season ranges from the 1st of May till the middle of July, according to the description of sheep, the nature of the feeding, &c. Autumn is the most common time for the 'dipping,' 'juicing,' or 'smearing' of the flocks, to kill vermin, prevent skin disease, and preserve and cultivate the wool crop.

The great object for which the ancient Britons possessed sheep before the Roman invasion was the production of wool. The demand for meat has now raised the value of mutton and lamb so much, that the farmer finds it profitable to devote much of his attention to supplying the market with these articles; and those breeds of sheep are reckoned most valuable which are most suitable for this purpose, even although the crop of the wool is inferior. When there was no food for sheep but the natural pasture, the animals could not be fattened for the market except during summer, and not until they had attained an age of three, four, or five years; whereas much of the mutton now consumed is the flesh of sheep not more than two years old, fattening being aided by turnips, mangold, other green food, oilcake, and grain.

The young branches of heath, and in lower situations the shoots of furze, often serve as food for sheep, when the supply of grass fails. Sheep delight in the short grass and peculiar herbage of hill pastures and bare downs; and the mutton produced in such pastures, and by the breeds most suitable to them, is of superior quality to that of the large fat sheep fed on richer soils. The latter are also more liable to many diseases, particularly where the ground is at all moist. Aromatic and bitter herbs are particularly relished by sheep.

The breeds of sheep are very numerous, and very different.—The Black-faced Sheep of the Highlands of Scotland and of the north of England is perhaps as near the original type as any existing breed. Both male and female have horns; those of the ram large, with two or more spiral twists, those

of the ewe much smaller, and little twisted. The face and legs are not always black. Many are speckled, and some principally white. The black-faced sheep is robust, very active, and hardy; enduring the rigours of a severe winter when sheep of most of the breeds common in Britain would perish. It survives on little food, and shifts admirably for itself in a snow-storm. The small quantity and even inferior quality of food with which a black-faced sheep will tide over a snowstorm is most surprising. So



Fig. 1.—Black-faced Ram.

great indeed is the tenacity of life in black-faced sheep that they have been known to be buried five weeks under a snow-wreath and come out alive. It has a bright, quick eye, with an expression very different from that softness which is seen in many of the breeds preferred for lower grounds and better pastures. The wool is long and coarse, and the weight of the fleece from 3 lb. to 5 lb.; but the mutton is of the finest quality; and on this account, and its hardiness, this breed is preferred to any other in many mountainous districts and on rough elevated moors.—The Welsh Sheep is much smaller than the black-faced; both sexes horned; the colour various; the mutton highly esteemed; the fleece seldom weighs 2 lb.—A very little larger breed with big bushy tail, hornless, or with short and little twisted horns, has long existed in the Shetland and Orkney Islands, its wool affording the material for the manufacture of Shetland hosiery. The Shetland and Orkney sheep are very hardy, and in winter feed much on seaweed.—Smaller than either of these, and indeed remarkably diminutive, is the hornless Breton Sheep.—The Forest Sheep of England, so called from being pastured in the royal forests, has now been supplanted by other breeds. The original forest sheep was generally small, with face and legs russet brown or gray, wild, restless, and difficult to fatten, but producing wool of fine quality.—The Dorset Sheep is one of the best of the old English upland breeds. Both sexes have small horns. The wool and mutton are of medium quality; but the ewes are remarkable for their fecundity, and the abundance of their milk—two crops of lambs being bred and reared by them each year. This breed is valued as affording a supply of early lamb for the London market.—The Ryeland Sheep has long existed in Herefordshire and some neighbouring counties of England. It is small, short-limbed, white, hornless; produces excellent mutton; and before the introduction of Merino wool its wool was preferred to every other kind for the manufacture of the finest broadcloths.—The Cheviot

Sheep has existed from time immemorial on the Cheviot Hills, and is now very widely diffused over a considerable part of England and a large extent of Scotland, being hardy and well adapted for high grounds, although it is inferior in hardiness to the



Fig. 2.—Cheviot Ewe.

black-faced. Cheviots, however, rather excel the black-faced both in size and in the value of the fleece, but require a richer pasture. Ewes are hornless, and the rams almost so. The general figure is longer than that of the black-faced sheep. They are narrow in shape, with slender forequarters and long pricked ears. The colour is white, the face and legs occasionally mottled with gray, but generally quite white. The fleece weighs from 3 to 5 or 6 lb. Great attention has for many years been devoted to the improvement of this breed.—The Leicester Sheep is another of the most valuable breeds. This breed, as it now exists, is a result of



Fig. 3.—Leicester Ram.

the skill and care of Mr Bakewell (q.v.), who, soon after the middle of the 18th century, began to make experiments for the improvement of the old Leicester sheep—a large, coarse-boned sheep, not easily fattened, and with coarse long wool, of which, however, the fleece weighed from 8 to 10 lb. The new Leicester sheep has wool moderately long, of better quality, the average weight of the fleece being about 7 or 8 lb., and is easily rendered very fat. It is naturally very broad on the back, with finely-arched ribs. The colour is white. Both sexes are hornless. The Leicester sheep is now common in all but the mountainous parts of Britain; and other breeds have been improved by crossing with it, particularly various breeds of long-woolled sheep, which



Fig. 4.—Border Leicester Ram.

have long existed in different parts of England, as those of Lincolnshire, Romney Marsh, &c. The Leicester, indeed, was the first to be submitted to improvement by a systematic system of breeding, and in the general improvement of the sheep stock of the British Isles it has played a larger part than any other breed. One of the most valuable crossed breeds is the Border Leicester.—A famous long-woolled breed is that called the Cotswold or Gloucester, the wool of which was in great esteem in the 14th and 15th centuries, bearing a higher price than any other wool. In 1464 Edward IV. sent a present of Cotswold rams to Henry of Castile; and in 1468 a similar present was sent to John of Aragon.

The Cotswold breed, however, as it now exists, has been modified by crossing with the Leicester, and produces shorter wool and better mutton than in former times.—The South Down Sheep has recently been improved with the utmost care. The colour is generally white, and the face and legs are generally brown or fawn. Black and spotted faces and legs were once common, but these are discounted now. Both sexes are hornless. The wool is short, very close,

Fig. 5.—South Down Ram.

and curled. The South Down derives its origin and name from the chalky downs of the south of England, but is now met with throughout England

and the south of Scotland.—The Shropshire sheep are large, with thick wool something like the South Down. They are hornless, and black or dun in the face and legs. They come early to maturity, but are suited only for finer climates and good keep.—The Hampshire, also hornless, is a valuable breed of sheep for fattening, matures early, and grows to a large size. It originated in a cross between the Old Wiltshire horned sheep and the Old Berkshire Knot with the South Down.—The Oxford Down, a successful blend of the Hampshire and Cotswold breeds, is a heavy, somewhat soft sheep, without horns, and capable of rapid and great development under good treatment. It is not suited to very cold and exposed situations.—The Lincoln, a cross between the improved Leicester and the native sheep of the county, is one of the best long-woolled varieties in England. The fleece of the Lincoln Sheep is long and lustrous in the staple, and often exceeds 20 lb. in weight. Other English varieties of good standing are the Suffolk Down, Devon Long-wools, Romney Marsh Sheep, the Lark and Wensleydale Sheep. The Roscommon is the principal native breed in Ireland. They are large hornless sheep, improved from the native sheep by a cross of the Leicester.

The first sheep were taken to what is now the United States in 1609, merinos not till 1801; but now 95 per cent. of American sheep are mainly of merino origin, though the breeds have not been kept pure. The principal breeds are native, Spanish, and Saxon Merinos; the New Leicesters or Bakewells; Southdowns, Cotswolds, Cheviots, and Lincolns. The Texas sheep are largely crossed with a Mexican breed, originally from the Basque provinces of Spain. Two races, originating in America, have been allowed to die out—the Smith's Island and the Otter breeds—the latter with a long body and short legs.—Sheep-raising is carried on more or less extensively in Texas, New Mexico, in the Rocky Mountain states, in the uplands of the south-west, in Ohio, and in the northern New England states.

The merino is an important breed of sheep, originally Spanish, but now widely diffused throughout Europe and North America, and constituting a great part of the wealth of Australia. The merino has large limbs, and the male has large spiral horns, which do not rise above the head; the skin of the neck is loose and pendulous; the cheeks and forehead bear wool; the fleece, which is very heavy, often in choice animals exceeding 20 lb., sometimes even over 30 lb., is fine, long, soft, and twisted in silky spiral ringlets, abounding in oil, which attracts dust, so that it has generally a dingy appearance. The fleece is sometimes black, and black spots are apt to appear even in the



Fig. 6.—Shropshire Ram.

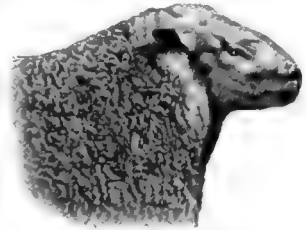

Fig. 7.—Lincoln Ram.

The first sheep were taken to what is now the United States in 1609, merinos not till 1801; but now 95 per cent. of American sheep are mainly of merino origin, though the breeds have not been kept pure. The principal breeds are native, Spanish, and Saxon Merinos; the New Leicesters or Bakewells; Southdowns, Cotswolds, Cheviots, and Lincolns. The Texas sheep are largely crossed with a Mexican breed, originally from the Basque provinces of Spain. Two races, originating in America, have been allowed to die out—the Smith's Island and the Otter breeds—the latter with a long body and short legs.—Sheep-raising is carried on more or less extensively in Texas, New Mexico, in the Rocky Mountain states, in the uplands of the south-west, in Ohio, and in the northern New England states.

The merino is an important breed of sheep, originally Spanish, but now widely diffused throughout Europe and North America, and constituting a great part of the wealth of Australia. The merino has large limbs, and the male has large spiral horns, which do not rise above the head; the skin of the neck is loose and pendulous; the cheeks and forehead bear wool; the fleece, which is very heavy, often in choice animals exceeding 20 lb., sometimes even over 30 lb., is fine, long, soft, and twisted in silky spiral ringlets, abounding in oil, which attracts dust, so that it has generally a dingy appearance. The fleece is sometimes black, and black spots are apt to appear even in the

The merino is an important breed of sheep, originally Spanish, but now widely diffused throughout Europe and North America, and constituting a great part of the wealth of Australia. The merino has large limbs, and the male has large spiral horns, which do not rise above the head; the skin of the neck is loose and pendulous; the cheeks and forehead bear wool; the fleece, which is very heavy, often in choice animals exceeding 20 lb., sometimes even over 30 lb., is fine, long, soft, and twisted in silky spiral ringlets, abounding in oil, which attracts dust, so that it has generally a dingy appearance. The fleece is sometimes black, and black spots are apt to appear even in the

most carefully bred flocks. The merino sheep fattens slowly, and owes its value altogether to the excellence of its wool. It has not been found profitable in Britain, where the production of mutton is a great part of the object of the sheep-farmer. Merinos are the main breed in Australia, sometimes variously modified by crossing with English long-woolled sheep. In New Zealand the

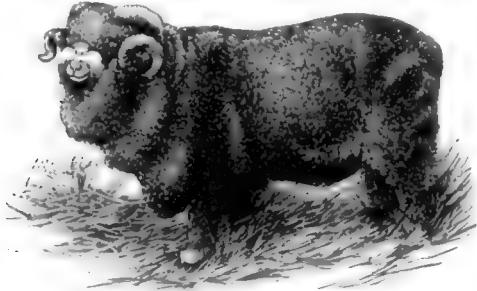

Fig. 8.—Merino Ram.

Lincoln, Romney, Leicester, and Cotswold breeds are largely represented, as they do not suffer so much from foot-rot as merinos, and their flesh of course tastes more like English mutton.

A clever Australian shearer will clip from seventy to a hundred and twenty sheep in eight and a half hours; the champion shearer of Queensland did three hundred and twenty-seven in nine hours. The Wolseley Sheep-shearer, invented in Australia, consists of a cutting wheel geared to the shaft of a small steam-turbine, which is worked by a current of steam conveyed from the boiler in an india-rubber tube. A comb moves in front of the cutter, effectually protecting the animal from injury. The shearing apparatus, made of brass and in shape similar to a small trowel, is held in the hand and guided over the body of the sheep just as is the ordinary wool shears. The shearing-machine works with great expedition and perfect safety to the sheep. It will be of great advantage where flocks are large and labourers few.

The Iceland Sheep is remarkable for very frequently having three, four, or five horns—a monstrosity found also in northern Russia.—The north of Africa possesses a breed of sheep with legs of great length, pendulous ears, and much-arched face; the wool short and curled, except on the neck and shoulders, which have a kind of mane.—India has also a hornless breed, with pendulous ears, short tail, and very fine much-curved wool.—The Broad-tailed or Fat-tailed Sheep is found in many parts of Asia, in Barbary, and is now abundant in Cape Colony. It is rather of small size, with soft and short wool. Its chief characteristic is the enormous development of the tail, by the accumulation of a mass of fat on each side, so great that the tail has been known to weigh 70 or 80 lb. The tail is highly esteemed as a delicacy, and to protect it from being injured by dragging on the ground the shepherd sometimes attaches a board to it, or even a small carriage with wheels.—The Fat-rumped Sheep of southern Tartary has a similar accumulation of fat on the rump.—The Astrakhan or Bucharian Sheep has the wool twisted in spiral curls, and of very fine quality.—The Circassian Sheep has a remarkably long tail, covered with fine long wool, which trails on the ground.—The Wallachian Sheep, common in Hungary, as well as in Roumania, is distinguished by the size and direction of its horns, which after one spiral turn rise up from the head to a great length. The wool is soft, and is concealed by long hair.

In the article AGRICULTURE tables are given on pp. 100-1, showing the number of sheep in the United Kingdom at different dates; and similar statistics are scattered up and down the work in such articles as NEW ZEALAND and UNITED STATES. The importance to Britain of foreign supplies of mutton may be gathered from the articles of FOOD and PRESERVED PROVISIONS. The rapid growth of this trade in recent years may be seen from the single fact that, whereas the trade of exporting mutton from New Zealand was in 1883 only worth £116,000, it had before the end of that decade attained a value of over £700,000. Reference should be made to the article WOOL, and for sheep diseases to the articles on Anthrax, Bot, Braxy, Fluke, Foot-rot, Murrain, Smallpox, Sturdy, &c. See works by G. S. Heatley (1884), C. Scott (1886), J. H. Steel (*Diseases*, 1890); Stephens, *Book of the Farm* (new ed. by Macdonald, 1889); Wallace, *Farm Live-stock of Great Britain* (1885; new ed. 1889), and *Rural Economy and Agriculture of New Zealand and Australia* (1891).

Sheep-dog, a name which often includes the Scottish Collie (q.v.), but which is more properly applied to the English drover's dog. The Sheep-dog or Smooth-coated Collie performs the same work for the south-country shepherd as the rough-coated for the northern one. The sheep-dog is built on more sturdy and powerful lines than the collie, but lacks the speed of the latter. His coat is short, thick, and wiry; and he is not so graceful as the collie, though possibly quite as useful. Another variety of the sheep-dog is the Bob-tailed or Moorland Collie.



Bob-tailed Sheep-dog, 'Wall-eye'd Bob.'
(From a Photograph by Gambier Bolton, F.Z.S.)

When the game-laws were more stringent farmers were only allowed to keep a dog with a docked tail, the current belief being that hares cannot be coured with success by dogs with docked tails. This treatment long continued is sometimes alleged (though doubtfully) to have made the short tail hereditary. The bob-tailed collie has a long, shaggy, and curly coat over body, legs, and head. The colour is generally a gray or grizzle. As a cattle-dog he surpasses the other varieties, and is also often used for sheep.

Sheep-louse, or SHEEP-TICK, or (in Scotland) KAID (*Melophagus ovinus*), an insect of the family Hippoboscidae, to which also the Forest Fly belongs, ranked in the order Diptera, although in this genus the wings are completely wanting. It lives among the wool of sheep, particularly of lambs, sucking the blood of the animal, and is most abundant in

the early part of summer. Where it fixes its head in the skin a round tumour is formed. The body of the insect is compressed and smooth, of a rusty colour, the head and thorax are small, the abdomen is large. The female does not lay eggs, but, like the other Hippoboscidae, hatches the egg and nourishes the larva within her own body, till it passes into the pupa state, when it is deposited, oval-shaped and shining, and fastened to the wool of the sheep. Sheep-farmers use various arsenical and carbolic washes or dips for the destruction of these parasites. The sheep-tick is not a tick proper, not being one of the Ixodidae. See TICKS.

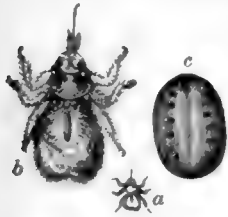

Sheep-louse (*Melophagus ovinus*):
a, natural size; b, magnified;
c, the pupa, magnified.

is not a tick proper, not being one of the Ixodidae. See TICKS.

Sheepshanks. JOHN, a munificent art-patron who left his priceless collection of pictures to the nation, was born at Leeds in 1787, and succeeded on his father's death to the management of an extensive and prosperous cloth manufacture. Retiring from business, he devoted himself to collecting the works of modern British artists, especially those of Landseer, Mulready, and Leslie. These in 1856 he presented to the nation; and his collection of over 230 oil-pictures and some 100 drawings and sketches were sufficient to furnish out three rooms at South Kensington. He died at London, 6th October 1863.—His brother, the Rev. Richard Sheepshanks (1794-1855), did valuable work as an astronomer, and in helping to restore the British standards of weights and measures, destroyed in 1834 by the burning of the Houses of Parliament.

Sheepshead (*Diplodus probato cephalus*), an American fish of the family Sparidae, allied to the perch. It occurs along the east coast from southern Florida to Cape Cod. The name refers to the shape and colour of the head, and to the teeth, which are broad blades in front and grinding molars on the sides of the jaws. The sheepsheads live near the bottom, especially about oyster and mussel beds or about wrecks, feeding on molluscs and barnacles. In the south they often ascend rivers. Except in spring, when they spawn, they live gregariously. In size they vary greatly, from 2 to 12 pounds weight. They afford good sport to anglers. The Scup or Porgie (*Stenotomus chrysops*) is nearly allied, and not very far removed is the fresh-water Drumfish (*Haplodinotus grunniens*), to which the name sheepshead is also applied.

Sheep-stealing, in England, is a felony, and by statute 24 and 28 Vict. chap. 96, sect. 11, is punishable with penal servitude to the extent of fourteen years. In Scotland it is an aggravated species of theft, and under certain old statutes was punishable by death. These statutes have been long ignored, and sheep-stealing, like other thefts, has been punished by imprisonment or penal servitude at the discretion of the judge. And by the Criminal Procedure (Scotland) Act, 1887, a capital sentence is no longer competent in the Scotch courts except on conviction of murder or murderous offences.

Sheerness, a strongly fortified seaport and royal dockyard in Kent, on the north-west extremity of the Isle of Sheppey, at the confluence of the Thames and Medway, 11 miles ENE. of Chatham and 52 E. of London by rail. It consists of four divisions, Blue-town, Mile-town, Banks-town, and Marina-town, and of these the first is within the limits of the garrison. The dockyard, dating from 1814, is one of the finest in Europe, and covers 60 acres, comprising wet and dry docks, immense

storehouses, and official residences. The harbour is usually crowded with vessels of all descriptions. At Garrison Point are the residence of the port-admiral, the telegraph, coastguard station, and barracks. The chief trade is in supplying the requirements of the employees in the various government establishments and of the shipping, and in the export of oysters from the neighbouring oyster-beds. The neighbourhood was once thought to be very unhealthy, but important sanitary works have been carried out, and there are now few towns the population of which enjoy better health. The sea-bathing is excellent. Pop. (1851) 8549; (1881) 14,286; (1891) 13,841. Sheerness was captured by the Dutch under De Ruyter in 1667, and here the mutiny of the *Nore* (q.v.) broke out in 1798.

Sheers. The elemental form of a pair of sheers consists in two spars fastened together near the top with a pulley at the point of junction, and held by a rope fastened to any convenient object, in such a position that the weight lifted hangs

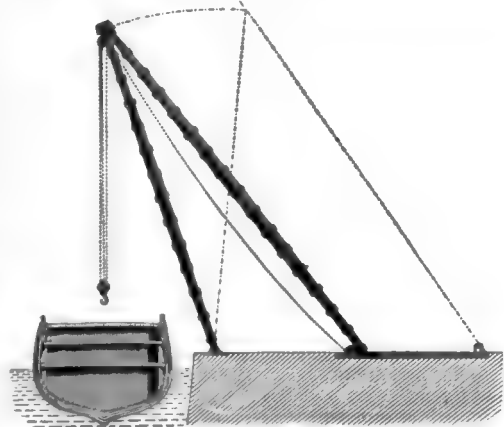

Diagram of Sheers.

nearly between the spars. This forms an easily improvised crane. An apparatus of this kind of great height and strength is used for masting vessels. In the principal dockyards there are tall permanent sheers, mounted either on the side of a masting-dock or on a floating *sheer-hulk*, often an old dismasted ship devoted to this use.

Sheffield, a municipal, parliamentary, and county borough in the West Riding of Yorkshire, in a hilly country, at the confluence of the Sheaf with the Don, 46 miles SSW. of York, 18 SW. of Doncaster, 38 S. of Leeds, 41 E. of Manchester, and 165 NNW. of London. In 1875 and the succeeding years a street improvement scheme was carried out at a cost of upwards of half a million; and now the town, generally, is well built. It possesses many fine public buildings, such as the original parish church of St Peter, supposed to have been erected in the reign of Henry I., 240 feet long by 130 feet broad; St Mary's Roman Catholic Church (1850), surmounted by a spire 195 feet high; the Albert Hall (1873), cutlery hall, corn exchange; the new market-hall, or Norfolk Market, with a roof of glass and iron, erected in 1851 by the Duke of Norfolk at a cost of about £40,000; music-hall, assembly rooms, theatres, &c. The magnificent new municipal buildings, begun in 1891, were opened by the Queen in May 1897. There are extensive botanic gardens and several fine cemeteries; many churches; numerous educational establishments, such as the Free Grammar-school,

the Wesley College (1838). The Firth College, founded in 1879 by Mark Firth (Mayor 1875), was incorporated in 1897 as University College, with arts, technical, and medical departments. The Mechanics' Institution dates from 1832. There are free and other public libraries, an Athenæum, and a Literary and Philosophical Society; and, amongst charities, an infirmary and several hospitals. Sheffield has long been noted for the manufacture of Cutlery (q.v.); and at the present day an endless variety of articles in brass, iron, and steel is produced at the many manufactories with which the town abounds, such as knives of every description, silver and plated articles, Britannia-metal goods, files, saws, &c. The introduction of the manufacture of armour-plates, railway-springs, tires, and rails, since 1871, has given a remarkable impetus to the growth of the town. Sheffield has several public parks, including the Firth Park, presented by Mr Firth, opened in 1875, and the Norfolk Park, given by the Duke of Norfolk (Mayor), opened in 1897, and two sets of public baths. Mr Ruskin founded the St George's Museum here (formerly at Walkley, but since 1890 in the town itself), in which he deposited an important collection of minerals, illuminated manuscripts, engravings, and drawings. Mr J. Newton Mappin bequeathed to the town a collection of pictures, and Sir F. T. Mappin, Bart., M.P., his nephew, has since added largely to the collection. The Mappin Art Gallery was erected by the executors of Mr J. N. Mappin at a cost of £15,000. Pop. (1821) 69,479; (1841) 111,091; (1861) 154,093; (1881) 284,508; (1891) 324,243.

Situated on the extreme southern border of Yorkshire, Sheffield has from Saxon times been the capital of a district known as 'Hallamshire,' which is composed of five contiguous parishes, and formed the manor of Earl Waltheof, who married the Countess Judith, the Conqueror's niece. A Norman family, who seem to have sprung from Lovetot, a small hamlet in Normandy near Fontenelle, became the resident proprietors of Sheffield and the adjacent parishes; and William de Lovetot founded a monastery at Worksop in 1103, and built a church at Sheffield. This family established a market, a hospital for the sick, a mill for grinding corn, and a bridge over the Don during their brief reign in Sheffield. The property descended to a female heir, whose hand was given in marriage by King Richard I. to Gerald Furnival, who had fought with his king at Acre. The Furnivals took the side of Henry III. in his contests with the insurgent barons, during which an expedition was formed against the town and castle of Sheffield, when many of the inhabitants were slaughtered, and the castle was burned in 1266. Four years after this disaster Thomas de Furnival rebuilt the castle. His son, of the same name, was the great benefactor to this town. Though much employed as a soldier against the Scots, he enfranchised his vassals, and gave them a court of justice and trial by jury. His grandson took part in the battle of Crécy; and his brother, who succeeded him, left an only daughter, who married Sir Thomas Nevil. This pair again left an only daughter, who married the great hero, John Talbot, first Earl of Shrewsbury, familiar from Shakespeare's *Henry VI.*

During the wars betwixt the rival Houses of York and Lancaster the Shrewsbury family sided with the latter, and the second earl fell in the battle of Northampton fighting for the king. His son and successor was again in arms in the same cause, but died young, and left a son, who was only five years old when he succeeded to the title and property, which he held for seventy years. This earl made Sheffield Castle a more permanent place of residence than his predecessor had done.

It was a spacious fortified building which covered four acres of ground, and fourteen acres of pleasure-grounds were attached, and stood at the northern entrance to the town betwixt the rivers Sheaf and Don. In the early part of the reign of Henry VIII. the earl built a more homelike residence about two miles from the town, in which Wolsey rested for eighteen days on his last journey (1530), and the utter ruins of which still bear the name of 'Sheffield Manour.'

The earls of Shrewsbury were amongst the very chief of the nobility of England, and the sumptuousness of living which they maintained, both at the castle and manour, was second only to that of royalty itself. Queen Elizabeth imposed on George Talbot, sixth Earl of Shrewsbury, the odious responsibility of holding Queen Mary of Scotland a prisoner in his castle at Sheffield; and this lasted, with only few and short changes of abode, during the long period of fourteen years (1572-86).

The seventh Earl of Shrewsbury left three daughters, of whom only the youngest, whose husband was Thomas, Earl of Arundel, had a child. Through this son the vast estates connected with the Sheffield property became henceforth vested in a line of descendants which has made the Dukes of Norfolk owners and lords of Hallamshire. Lord Arundel was non-resident, living much abroad, and the prosperity of Sheffield deteriorated greatly owing to the withdrawal from the local markets of all such custom as two grand mansions had hitherto afforded. Whilst the noble family maintained their loyal sentiments towards the king in the national contest, the townspeople took the popular side. In August 1644 the castle was besieged and taken by the parliamentary army, and soon afterwards a resolution was passed by the government that it should be 'sleighted and demolished.'

Sheffield henceforth became dependent upon its cutlery trade. This, as the special business of the town, had existed from the earliest times. The 'Sheffield whittle' spoken of by Chaucer in the 14th century was the common knife used for all purposes by those whose social rank did not entitle them to carry a sword. It was only the commonest cutlery that was manufactured in the town, and neither swords nor daggers nor the more modern bayonet were ever made here. The Cutlers' Company, which has now a national reputation, was founded in 1624, and the cutlers' annual feast may date from about that time, having originated in the permission granted by Earl Gilbert to the 'apron men,' or working smiths, to pull down as many deer as they could kill in the park and carry away with their hands. Up to the middle of the 18th century Sheffield was a mean place, and the cutler was a poor man; the income of £100 a year was accounted as riches. But in a century from that time, with railway approaches, the use of the steam-engine, machinery of every sort, and a variety of processes for the manufacture of steel, Sheffield had risen into the position of being the 'capital of steel' in Britain, and perhaps in the world; it was the first place at which the armour-plates to protect British war-ships were rolled, and here too are cast the steel blocks which are subsequently bored and rifled for the artillery of both services.

Till 1845 the whole town was included in one parish, having a single ancient church, with five modern churches that were merely chapels of ease. There are now thirty-seven ecclesiastical parishes, with their churches and clergy. The various Non-conformist bodies, too, have rapidly increased with the growth of population. The old dissent commenced with the ejection of the Presbyterian

clergy in 1662, of whose churches the Upper Chapel in Norfolk Street is now the lineal representative. Sheffield was first enfranchised by the Reform Bill of 1832; and by the bill of 1885 the borough was divided into five parliamentary districts, each being represented by one member. In March 1864 a new embankment, constructed for the Sheffield Water Company, at Bradfield, gave way, and let out a body of water 95 feet high from a reservoir 78 acres in extent. The destruction of life and property by this flood was unprecedented in England: 250 persons perished; mills, houses, and hamlets were swept away from their foundations, and, apart from the ruin of the Bradfield Dam, damage was done to private property to the extent of close upon £300,000. In 1893 Sheffield was constituted a city, and in 1897 her chief magistrate for the first time was entitled *Lord Mayor*.

See Joseph Hunter's *Hallamshire* (1819; new ed. by the present writer, 1869); the latter's *Sheffield, Past and Present* (1873); R. E. Leader's *Reminiscences of Old Sheffield* (1875); and *Harper's Magazine* (June 1884).

Sheffield, JOHN, DUKE OF BUCKINGHAMSHIRE, was born in 1648, and succeeded to the title of his father, the second Earl of Mulgrave, in 1658. He served in the navy against the Dutch in 1666, and commanded a ship in 1672; but subsequently joined the army. He was lord chamberlain to James II., and a cabinet-councillor under William III., who in 1694 made him Marquis of Normanby. Anne raised him to the dignities of Duke of Normanby and Duke of Buckinghamshire (1703); but for his opposition to Godolphin and Marlborough he lost all his offices. After 1710 under the Tory régime he was lord steward of the household and lord president till the death of Anne, when he lost all power, but intrigued zealously for the restoration of the Stuarts. He wrote two tragedies, a metrical *Essay on Satire*, an *Essay on Poetry* (his principal work), and some smaller poems, all of them much talked of at the time, but of little poetic value. He died 24th February 1721.

Sheffield, JOHN BAKER HOLROYD, EARL OF (1735-1821), is chiefly known as the friend of Gibbon (q.v.) and editor of his miscellaneous works. He wrote numerous pamphlets on the slave-trade, the corn laws, the navigation laws, and on commercial and agricultural questions.

Sheikh (Arab., 'elder,' 'aged person'), a title applied to the chieftain of an Arab tribe, to the principal preacher in a Mohammedan mosque, to the head of a religious order, and to a learned man or a reputed saint of Islam. The Sheikh ul-Islam at Constantinople is the head of the Mohammedan church; he is possessed of very great influence and power (see MUFTI). Sheikh al-Jebel (Old Man of the Mountain) was the name of the chief of the Assassins (q.v.).

Sheil, RICHARD LALOR, Irish patriot and orator, was born at Drumdowney, County Tipperary, 17th August 1791, son of a prosperous Cadiz merchant, who had returned to Ireland about the time that the most odious of the Catholic disabilities began to be relaxed. He passed his earliest years at his father's estate of Bellevue near Waterford, and in due time went to school, first to Kensington, then to Stonyhurst, whence he passed in 1807 to Trinity College, Dublin. Soon after this his father failed, but young Sheil was enabled through the help of friends to graduate B.A. in July 1811, and to enter Lincoln's Inn in November of the same year. He was called to the Irish bar in Hilary term, 1814. The next few years he devoted to literature, producing a series of plays, most of which proved successful in Dublin or London: *Adelaide*, or *The*

Emigrants (1814); *The Apostate* (1817); *Bellamira* (1818); *Evadne*, partly based on Shirley's *Traitor* (1819); *The Huguonot* (1819); *Montoni* (1820); and an adaptation of Massinger's play, *The Forgotten Dowry* (1824). His *Sketches of the Irish Bar*, written in conjunction with the younger Curran, appeared during 1822 in the pages of the *New Monthly Magazine* (2 vols. 1855). In 1823 Sheil joined O'Connell's Catholic Association, which was dissolved in 1825, and throughout gave the great tribune a loyal but an independent support. After the Lords threw out the Catholic Relief Bill (May 1825) he aided his chief in forming the New Catholic Association, and throughout the course of the agitation he devoted enormous labour to the preparation of those ornate and impassioned speeches, which, despite his shrill voice and feeble gestures, had often a magical effect on his audience, and many of which remain to posterity among the masterpieces of English oratory. After Catholic emancipation was gained in 1829 Sheil devoted much more of his time than before to his profession. He was returned to parliament for Milborne Port, Somerset, a pocket-borough of Lord Anglesea's, and at the dissolution of 1831 for Louth, and later he sat for Tipperary and Dungarvan. A charge brought against his honour in 1834 by Lord Althorp, that he had in private supported the Coercion Bill of 1833 while publicly opposing it, was unanimously rebutted by a Committee of Privileges. After the defeat of Repeal in 1834, which years later he described as 'a splendid phantom,' Sheil mostly supported the Whigs, and in 1838 received a commissionership of Greenwich Hospital. In August 1839 under Melbourne he became vice-president of the Board of Trade, and a privy-councillor—the first Catholic to gain that honour. Under Lord John Russell in 1846 he was appointed Master of the Mint, and in 1850 British minister at Florence. Here his constitution, enfeebled by gout, sank under the shock of the sudden death of his stepson, May 25, 1851.

See his *Memoirs*, by W. Torrens McCullagh (2 vols. 1855). His *Speeches*, with a memoir by T. MacNevin, were published in 1845; the *Speeches, Legal and Political*, edited by M. W. Savage, in 1855 (2 vols.).

Shekarry (also spelt *shikarry*, *shikaree*, *chickary*; Hind. *shikāri*), an Anglo-Indian word for 'hunter,' 'sportsman,' familiar to English readers from the books on sport in India by 'The old Shekarry,' Major H. A. Leveson (1828-75).

Shekel (Heb., from *shakal*, 'to weigh'), originally a certain standard weight in use among the ancient Hebrews, by which the value of metals, metal vessels, and other things was fixed. Gradually it became a normal piece of money, both in gold and silver, marked in some way or other as a coin, although not stamped. The gifts to the sanctuary, the fines, the taxes, the prices of merchandise are all reckoned in the Old Testament by the shekel, not counted but weighed. Three different kinds of gold, silver, and copper shekels are mentioned: the common shekel, the shekel of the sanctuary (probably of double value), and the shekel of royal weight. Besides these there was a half-shekel and a quarter-shekel. The sacred shekel was equal to 20 gerahs ('beans'), and 3000 sacred shekels made a talent. The gold shekel is reckoned approximately to contain 161 Troy grains, the silver shekel 275. During the Babylonian exile the Persian money (*darics*) was used by the captives; nor do the Jews seem to have afterwards used any but the coins of their foreign rulers. It was first under the Maccabees that national money began to be struck. Simon, the 'prince and high-priest,' received, according to 1 Macc. xv. 16, the permission from Antiochus VII. to strike coins in

138 B.C. The emblems are sacred branches, sheaves, flowers, vases, &c., and the legend (in archaic Hebrew) contains the date, the name of the Jewish ruler, and the inscriptions 'Shekel of Israel,' 'Jerusalem the Holy,' 'Redemption of Israel.' The latest coins with Hebrew inscriptions date from the revolution of Bar-cochba under Hadrian. The value of the silver shekel is reckoned to be something over two shillings.

Shekinah. See ARK OF THE COVENANT.

Shelburne, WILLIAM PETTY, EARL OF, son of the first earl, and maternal grandson of the famous Sir William Petty (q.v.), was born in Dublin, 20th May 1737, and, after studying at Oxford and serving in Germany, entered the House of Commons for the pocket-borough of Wycombe in 1761, but only sat for a few weeks, the death of his father calling him to the House of Lords. When George Grenville succeeded Bute in 1763 Lord Shelburne was placed at the head of the Board of Trade, and when Chatham formed his second administration in 1766 he became one of the Secretaries of State. Upon the fall of Lord North's ministry in 1782 George III. sent for Shelburne, and proposed to him to form a government. He declined, not being the head of a party, and was sent by the king to the Marquis of Rockingham with an offer of the Treasury, himself to be one of the Secretaries of State. It soon appeared that Shelburne was not so much the colleague as the rival of Lord Rockingham, the chosen minister of the court, and the head of a separate party in the cabinet. Upon Rockingham's death in the following July the king sent at once for Shelburne, and offered him the Treasury, which he accepted without consulting his colleagues. Fox thereupon resigned, and Shelburne introduced William Pitt, then only twenty-three, into office as his Chancellor of the Exchequer. Shelburne's ministry, on the occasion of the king's announcement of his determination to concede the independence of the American colonies, found itself outvoted by the coalition between Fox and Lord North (February 1783). He resigned, and the coalition ministry took his place, but soon broke up. The nation expected that the king on this event would have sent for Shelburne, but William Pitt received the splendid prize, and Shelburne was consoled by being made in 1784 Marquis of Lansdowne (q.v.). The rest of his days he spent in retirement, amusing himself by collecting in Lansdowne House a splendid gallery of pictures and a fine library, and with the friendship of Priestley, Jeremy Bentham, Sir S. Romilly, Mirabeau, Dumont, and others. He died at Bowood Park, Wiltshire, 7th May 1805. See *Life of Shelburne*, by his great-grandson Lord Edmund Fitzmaurice (3 vols. 1875-76), in which he is shown to have been an advocate of reform, free trade, and Catholic emancipation.

Sheldrake (*Tadorna*), a genus of birds of the Duck family Anatidæ, having the hind-toe free. The Common Sheldrake (*T. cornuta* or *vulpanser*) is one of the most remarkable of all the duck tribe for its size and the beauty of its plumage. It is fully 2 feet long. The head and neck are dark glossy green; below this is a collar of white, and lower still a collar of rich chestnut extending over part of the back; the rest of the back is white; the middle of the under-parts is black; the wing speculum green, the primaries and part of the secondaries black; the bill and frontal knob bright carmine; the legs, feet, and webs flesh pink. The female is rather smaller and duller, and has no frontal knob. The sheldrake is confined to salt water, and is found upon flat shores, links, and sand-bars on various parts of the coasts of the British Isles. It is abundant in Sweden, Denmark, the Baltic, and Norway; it is

a winter visitor to the Mediterranean, but resident in the Black Sea and the Caspian; it is found in Asia in salt lakes, and as far as Japan. It breeds in burrows made by rabbits and foxes in sand-dunes (hence the name Burrow Duck by which it is sometimes called), or it may make its own burrows. In some sandy islands off the coast of Jutland burrows are made by the inhabitants, who protect the birds

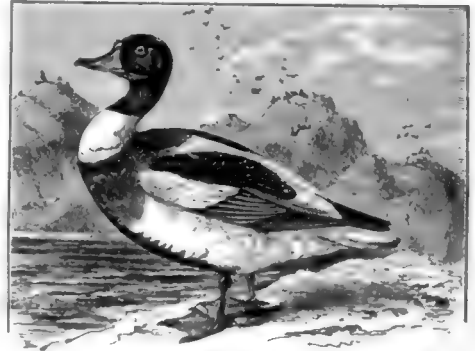

Common Sheldrake (*Tadorna vulpanser*).

for the sake of their eggs and down. The food consists of small molluscs, sand-hoppers, and seaweed. The flesh is coarse and unpalatable. The note of the male is a shrill whistle; the female utters a harsh bark. The Ruddy Sheldrake (*T. rutilla* or *casarca*) is rare as a British bird, and not common anywhere north of the Alps and Carpathians. It is not uncommon in Spain and various parts of North Africa. It is more abundant in the Black Sea area, southern Russia, and the elevated parts of Asia as far as China and Japan. In India, where it is known as the Brahminy Duck, it is very common during the cold season. Four other species are found respectively in South Africa, the Malay Archipelago, Australia, and New Zealand. The name is doubtless derived from *shield*, from the markings on the plumage. Other names are Skeel-duck, Skeeling-goose, Sly-goose, St George's Duck, and Bargander.

Shell, a term applied to the hard outer covering or skeleton of many animals, to the internal skeleton of some invertebrates, and to the outer covering of the eggs of various animals. Shells differ so much from one another in structure and chemical composition that a small piece often serves to distinguish not only the family or the genus, but even the species to which an animal belongs. In the class Protozoa, which consists of unicellular animals usually of microscopic size, the shell is very diversified in form and composition, being formed of calcium carbonate, as is typically seen in Foraminifera; flint, as in many Heliozoa and Foraminifera; acanthin, in some Radiolaria; and chitin, as in some Foraminifera. In the Coelenterata (Sponges, Corals, &c.) the shell may be either continuous or more or less interrupted or formed of spicules or granules; and it may be composed of salts of calcium and magnesium, flint (silica), or 'horny' or chitinous material. Among the Echinodermata the skin becomes calcified so as to form generally a very complete skeleton. The shell of a starfish or of a sea-urchin presents the appearance seen in fig. 1, which shows

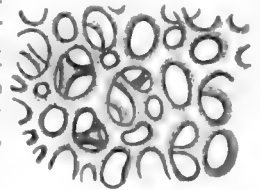

Fig. 1.—Shell of Echinoderm, magnified.

the calcified areolar tissue. In the Mollusca, including the Brachiopoda, a shell, which is closely associated with the breathing organ, is usually present, and appears in the embryo as a growth from a special gland. Its further development depends on the mantle. It grows in superficial extent at the edge of the mantle, and increases in thickness by growth from the surface of the mantle already covered. It is thus essentially a cuticular structure. It may be univalve or bivalve: in only one genus (*Chiton*) is it composed of several pieces. A section of the shell of the fresh-water mussel (fig. 2) shows (a) the thin, horny, uncalcified outer layer which is formed by the thickened edge of

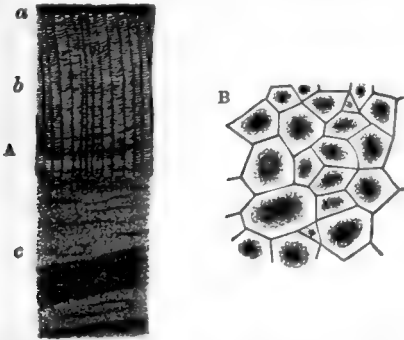

Fig. 2.—Shell of Fresh-water Mussel, magnified :

A, section at right angles to the long axis of the shell; a, outer; b, middle; c, inner layers. B, end view of the prisms of the middle layer.

the mantle, and is the first to be deposited; (b) the middle layer, consisting of numerous calcified polygonal prisms placed side by side, slightly obliquely to the surface of the shell; (c) the nacreous or pearly inner layer, finely granulated and traversed by delicate striae. The calcium carbonate, to which the hardness of the shell is due, may be dissolved away, leaving the organic basis. In the Mollusca shells are distinguished according to their texture as porcellanous, nacreous, and fibrous. In composition they usually consist of carbonate of lime (in the form of calcite, less commonly of aragonite). Some Cephalopods develop an internal calcareous shell. In Arthropoda (Crustaceans, Insects, &c.) the shell is composed of a firm, coloured, lamellated, nearly structureless layer of chitin, with or without an interstitial calcareous deposit, pierced by many pores and by processes of the skin, and shed and renewed periodically. A section of the hard shell of a crayfish (fig. 3) shows (a) an outer structureless resistant cuticle; (b) a pigmented layer consisting of fine plates parallel to the surface, alternately more or less refractile, and traversed by small vertical pores; (c) a thick non-pigmented calcified layer, whose pores are continuous with those of the second layer, and whose lamellae gradually merge into (d) a thin layer of delicate non-calcified lamellae with a few vertical pores. The organic substratum is chitinoid, and the calcareous matter is chiefly calcium carbonate, and to a much less extent calcium phosphate.

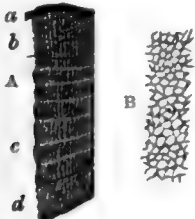

Fig. 3.

A, part of transverse section of an appendage of a crayfish, magnified; a, b, c, d, the various layers. B, tangential section of the same, showing the pore canals represented by small dots.

few vertical pores. The organic substratum is chitinoid, and the calcareous matter is chiefly calcium carbonate, and to a much less extent calcium phosphate.

For an account of the structure of shells and the literature on the subject, see Rolleston's *Forms of Animal Life* (2d ed.); Carpenter's *Microscope and its Revelations*; and Quekett's *Lectures on Histology* (vol. ii.), in which there are many excellent drawings. See BIVALVES, CONCHOLOGY, EGA, FORAMINIFERA, IRIDESCENCE, MOLLUSCA, MOTHER OF PEARL, &c.

Shell, a hollow projectile containing a bursting charge of gunpowder or other explosive ignited at the required instant by means of either time or percussion fuzes (see FUZE). Originally shells were made of cast-iron, spherical in form, and fired only from mortars (see MORTAR) or Howitzers (q.v.) with time fuzes. They were called *bombs* at first (see BOMB), and afterwards *common shells*. A smaller kind were thrown by hand and called *hand-grenades*. Shells appear to have been first used by the sultan of Gujarat in 1480; they were in general use about the middle of the 17th century.

But the introduction of *Shrapnel shell* (so called from the inventor, Colonel Henry Shrapnel, R.A.; died 1842) during the Peninsular war led to the employment of this projectile first with specially manufactured shell-guns, and then, as at present, with all guns of whatever construction. *Shrapnel shells* have thinner walls than *common*, and, instead of powder, are filled with bullets and a small bursting charge just strong enough to open them without disturbing the flight of the bullets. The latter then spread over a considerable area with the velocity which the shell had at the moment of bursting. These projectiles are generally burst by time fuzes at least 100 yards in front of and some 50 feet above the target, so that what is called the *cone of dispersion* of the bullets may be as favourably placed as possible. They are essentially man-killing projectiles, in contradistinction to *common shells*, which are chiefly useful for destroying *matériel*.

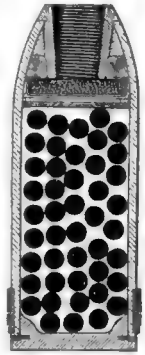

Fig. 1. Shrapnel Shell.

The original Shrapnel shell was of course spherical for use with smooth-bore guns. It was improved by the introduction of a *diaphragm* to separate the bursting charge from the bullets. When rifled guns and elongated projectiles came into vogue it was found that the ricochet of a solid shot was so erratic that it could not, like the old round shot, have any useful effect, and solid shot gradually ceased to be used, Shrapnel and common shell and case-shot being the artillery projectiles retained.

The Armstrong *Segment shell* (a sort of Shrapnel) is filled with iron segments built up inside it instead of bullets. It was found to give poor results owing to the spin of the shell due to the rifling dispersing the segments on bursting. The German and Swiss *Ring shell* is somewhat similar, having rings of iron built up inside it round the bursting charge; but it is a substitute for common shell, not for Shrapnel.

Until quite recently Shrapnel shell found no favour with foreign nations, but by 1892 they had all followed the example set by Great Britain in adopting it. Fig. 1 is a section of modern British steel Shrapnel, with soft metal driving-band at

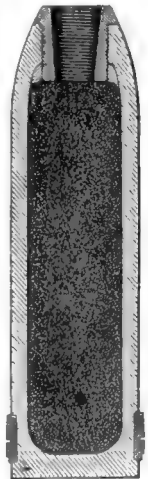

Fig. 2. Common Shell.

base to give rotation, instead of the metal studs or lead-coating formerly used for that purpose. The bursting charge is at the base of the fuse-hole, and the head is filled with wood. Fig. 2 is the section of a common shell. Shells of all sizes are constructed on the same principles.

Palliser's shells have sharp-pointed heads, no fuse-holes, and very thick walls. They are cast head downwards in thick metal moulds. Their heads are thus chilled, and become hard enough to pierce ship's armour. In passing through the armour the bursting charge is exploded, so that no fuse is needed.

The *Lyddite shell*, used in warfare at Omdurman (1898) for the first time, and with great effect, is a steel-cased shell filled with lyddite, which is a special preparation of picrate of potash. It is claimed for this shell that it explodes with such force as to ensure destruction to any living thing within 200 or 300 yards. Used with the new breech-loading howitzer it is certainly a most effective weapon of war. See also CANNON, CASE-SHOT, GRENADE, PALLISER, &c.

Shelley, PERCY BYSSHE, one of the greatest of English poets, was born on 4th August 1792, at Field Place, near Horsham, Sussex, the eldest child of Timothy Shelley and his wife Elizabeth, daughter of Charles Pile of Eppingham, Surrey. The family was old and honourable. Bysshe Shelley, the poet's grandfather, married two heiresses, acquired a great property, and in 1806 received a baronetcy; in 1815 he died. Percy was a boy of much sensibility, quick imagination, and generous heart; physically of a refined type of beauty, blue-eyed, golden-haired. At ten years old he became a pupil of Dr Greenlaw's at Sion House School, Isleworth, where he made some progress in classics, listened with delight to lectures on natural science, and endured much rough handling from his schoolfellows. In 1804 he passed to Eton, where Dr Goodall was then head-master. He continued his study of the classics, read eagerly Lucretius and Pliny, became a disciple of the 18th-century sceptical and revolutionary writers, pored over Godwin's *Political Justice*, filled his imagination with the wonders of modern science, resisted the system of school-fagging, and held aloof from the throng of the schoolboys, who in turn made him the object of systematic persecution. While still at Eton he wrote *Zastrozzi*, a crude romance in the manner of M. G. Lewis, which, published in April 1810, brought him £40; and before the end of that year a second romance, *St Irvyne, or the Rosicrucian*, appeared; it is as absurd as its predecessor in its sentimental extravagance, its pseudo-passion, and mock sublimity. He assisted his cousin Thomas Medwin in a long poem on the subject of *The Wandering Jew* (1810), and issued with some fellow-rhymer a volume of verse (now known only through reviews), *Original Poetry by Victor and Cazire*. Possibly his collaborator was his cousin Harriet Grove, whom Shelley loved with a boy's passion. Her parents, alarmed by Shelley's religious scepticism, put a stop to the correspondence between the cousins. In April 1810 Shelley matriculated at University College, Oxford, and in Michaelmas term entered on residence. His chief friend was a student from Durham, Thomas Jefferson Hogg, who has left a most vivid account of Shelley's Oxford life. Hogg was shrewd, sarcastic, unimpassioned, and withal a genuine lover of literature. He aided Shelley in putting forth a slender volume of poems, originally written by Shelley with a serious intention, now retouched with a view to burlesque—*Posthumous Fragments of Margaret Nicholson*—the pretended authoress being a mad washerwoman who had attempted the

life of the king. In February 1811 a small pamphlet by Shelley, entitled *The Necessity of Atheism*, was printed. When it was offered for sale in Oxford, the college authorities conceived it their duty to interfere; Shelley and Hogg were interrogated respecting its authorship, and having refused to reply, were expelled from University College (March 25, 1811) for contumacy and for declining to disavow the pamphlet. For a time the friends lived together in London lodgings; then Hogg departed to the country and Shelley remained alone. In his solitude he found some pleasure in the society of a schoolfellow of his sisters at Clapham, Harriet Westbrook, a fresh and pretty girl of sixteen, daughter of a retired coffee-house keeper. She moved under the tutelage of an unmarried sister nearly twice her own age. When summer came Shelley was with cousins in Wales; letters reached him from Harriet in London complaining of domestic persecution, and speaking of suicide as a possible means of escape; a letter followed in which she threw herself on Shelley's protection, and proposed to fly with him from her home. Shelley hastened to see her, but at the same time assured a cousin that he did not love Harriet, though he was prepared to devote himself to her through a sentiment of chivalry. On meeting her she avowed her passion, and he left her with a promise that if she summoned him he would come at her call and make her his. The summons came speedily; Shelley and Harriet, aged nineteen and sixteen, took coach for Edinburgh, and were there formally united as man and wife on 28th August 1811. He assured his bride that, in accordance with principles which he firmly held, the union of man and wife might be dissolved as soon as ever it ceased to contribute to their mutual happiness.

Coming from Edinburgh to York, where Hogg resided, the young married pair were joined by Eliza Westbrook, the elder sister. Ill conduct of Hogg towards Harriet caused a temporary alienation between the friends. The Shelleys with Eliza moved to Keswick, where Southey's presence was an attraction. Southey was kind and helpful, but his lack of revolutionary ardour and his indifference to metaphysical speculation displeased Shelley. The young enthusiast found a monitor more to his liking in Godwin, with whom he now corresponded as a disciple with a master. To apply at once his ideas of reforming the world he resolved to visit Ireland, and there advocate Catholic emancipation and Repeal of the Union. On reaching Dublin he printed and scattered abroad an *Address to the Irish People*, written at Keswick. This was soon followed by a second pamphlet, *Proposals for an Association of Philanthropists*. He spoke at a large public meeting from the same platform with O'Connell, and made the acquaintance of Curran. Discouraged by the small results of his efforts, and yielding to Godwin's advice, he left Ireland (April 4, 1812), and after some wanderings in Wales found rest in a cottage at Lynmouth, then a lonely fishing-village. Here he received as a visitor Miss Hitchener, a Sussex schoolmistress, whom both before and for a time after his marriage he had idealised into all that is most heroic and exalted in womanhood, and with whom he was ere long more than disenchanted. He wrote a vigorous pamphlet on behalf of liberty of printing—the *Letter to Lord Ellenborough*—amused himself with circulating, by means of bottles and boxes set afloat in the Channel and by fire-balloon, copies of his satirical poem *The Devil's Walk* and his revolutionary broadsheet *Declaration of Rights*, and was at work on his *Queen Mab*. His servant, having been found posting up at Barnstaple the offensive broadsheet, was imprisoned, and Shelley crossed to Wales. He took up his abode at Tremadoc, where he was much

interested in the scheme of a great embankment against the sea. In October he made Godwin's personal acquaintance in London. During the winter he was active in the relief of the suffering poor of Tremadoc, studied history and philosophy, and added to his manuscript poems. On the night of 26th February 1813 an attempt was either really made by some villain to enter the lonely house of Tanyrallt, or Shelley with over-heated fancy conjured up such an outrage. He hastily quitted Tremadoc, and, after an excursion to Dublin, Cork, and Killarney, once again settled in London. In June 1813 his wife gave birth to a daughter who was named Ianthe (married to Mr Esdaile, died 1876). On Harriet's recovery some stay was made at Bracknell in Berkshire. *Queen Mab* was printed for private distribution, its religious and political views being considered too hostile to received opinions to admit of public circulation. The poem sets forth Shelley's youthful conceptions of the past history of humanity, its present evils, and future progress. It is often crude, often rhetorical, yet there is more than a promise of poetical power in certain passages. In the autumn (1813)—perhaps to obtain time to settle with creditors—Shelley and his household went northward to the English Lakes, and thence to Edinburgh, but before the new year opened he was settled at Windsor. About this time he wrote a prose dialogue (published 1814), *A Refutation of Deism*, designed to prove that there is no *via media* between Christianity and Atheism.

In March 1814 Shelley went through the ceremony of marriage with Harriet according to the rites of the English Church, probably to set at rest any doubts of the validity of the Scotch marriage. He was endeavouring to raise large sums of money on Godwin's behalf, and the marriage may have been considered advisable to render certain the legitimacy of a future son and heir. Four months later he had separated from his wife for ever. Their early married happiness had become hopelessly clouded; an attempt at reconciliation made by Shelley in May was rejected. Harriet withdrew to Bath. It was stated by Miss Clairmont, the daughter of Godwin's second wife, that Shelley declared in July 1814 that Harriet had yielded herself to a certain Major Ryan, and Godwin in 1817 stated in writing that he had evidence independent of Shelley of her unfaithfulness before Shelley left her. No such evidence is in our possession to-day, and statements to the contrary were made by Harriet herself and by several persons who knew her well. The division between husband and wife, whatever its causes, was deep. Shelley had become suddenly and passionately enamoured of Godwin's daughter, Mary, a girl of fine intellect and vigorous character. Having informed Harriet of his resolve to leave her finally, and having made arrangements for her material comfort, he took flight to the Continent with Mary Godwin on 28th July 1814. Miss Clairmont accompanied the fugitives. Shelley was inexperienced enough to suppose that Harriet could still regard him as a considerate friend, though no longer her husband.

After a journey across France and a short stay in Switzerland, Shelley and his companions returned by the Rhine to England. The last months of 1814 were full of vexation caused by debts and duns. But in January 1815 Shelley's grandfather died, and by an arrangement with his father he obtained an income of a thousand a year. His health unhappily showed the effects of the previous year's strain and excitement. He sought rest and refreshment in Devon, and in August found a home at Bishopsgate, on the edge of Windsor Forest. In the autumn of 1815 *Alastor*, his first

really admirable poem, was written. It tells of the ruin of an idealist who, pining for absolute love and beauty, shuns human society; its visionary landscapes have the largeness and ideality characteristic of Shelley. In January 1816 Mary gave birth to a son, who was named after her father; but Godwin still held aloof. It was decided to try life upon the Continent, and in May Shelley and Mary travelled through France to Geneva. Miss Clairmont, whose intrigue with Byron was unknown to Shelley and Mary, accompanied them. On the shores of the Lake of Geneva a meeting took place between Byron and Shelley. They rowed and sailed together on the lake, and Shelley in company with Mary made an excursion to Chamouni. In the poem *Mont Blanc* and the *Hymn to Intellectual Beauty* we find a poetic record of the impressions of these memorable days.

In September they were once more in England. The suicide, following a state of deep depression, of Fanny, the half-sister of Mary (see GODWIN, WILLIAM), gave Shelley a great shock, and this disaster was soon followed by the death of Harriet Shelley. For some time past Shelley had in vain inquired for her. She had formed an irregular connection with one who, it is believed, deserted her. On 10th December her body was discovered in the Serpentine; had she lived she would soon have given birth to a child. It was another severe shock to Shelley, but he always maintained that he himself was 'innocent of ill, either done or intended.' Free now to make Mary his lawful wife, he at once celebrated his marriage (30th December 1816). A long Chancery suit followed, Shelley seeking to obtain possession of his daughter Ianthe and his son Charles (born November 1814—died 1826), the Westbrooks resisting. At length Lord Eldon gave judgment which compromised the matter; Shelley's opinions being such as led to immoral and illegal conduct, he was disqualified for bringing up his children, but he might appoint caretakers and tutors to be approved by the court. The blow was deeply felt by Shelley. While the Chancery affair was proceeding he was cheered by the friendship of Leigh Hunt and of Horace Smith. His home was at Marlow on the Thames, and here he wrote fragments of his *Prince Athanase*, a portion of *Rosalind and Helen*, and his long narrative poem *Laon and Cythna*, designed to sustain men's hopes in ideals of freedom and progress during days of political reaction. When some few copies of *Laon and Cythna* had been issued the publisher withdrew it from circulation, and induced Shelley to alter certain lines and phrases which might give offence. As thus revised the poem was issued with a new title, *The Revolt of Islam*. During his residence at Marlow Shelley worked earnestly and systematically in the relief of the poor. He printed two pamphlets, *A Proposal for Putting Reform to the Vote*, by 'The Hermit of Marlow,' and *An Address to the People on the Death of the Princess Charlotte*. In the spring of 1818 it was feared that he was threatened with pulmonary disease. He decided to seek a southern climate, and in April, with Mary, little William, an infant daughter Clara (born 2d September 1817), Miss Clairmont and her child Allegra (Byron's daughter), he left England for Italy, never again to see his native land.

In the summer of 1818, at the Baths of Lucca, Shelley completed his *Rosalind and Helen*, and made his translation of Plato's *Banquet*. Grief came with the autumn; little Clara died on 24th September at Venice, where Shelley had been renewing his companionship with Byron. Memorials of this visit to Venice, with an idealised presentation of Byron, will be found in the admirable poem

Julian and Maddalo. He contemplated a tragedy of *Tasso*, but this was set aside in favour of his great lyrical drama *Prometheus Unbound*, the first act of which was written at Este, September-October 1818. Seeking a warmer climate for the winter, he journeyed to Rome, and thence to Naples. His letters descriptive of Southern Italy are full of radiance and luminous beauty. In the spring (1819) he was again in Rome, and found great delight in its classical sculpture and architectural remains. Among the ruins of the Baths of Caracalla he wrote the second and third acts of *Prometheus*. The fourth act—not originally conceived as part of the poem—was added before the close of the year at Florence. On 7th June 1819 Shelley's beloved son William died at Rome. The afflicted parents sought the neighbourhood of kind friends near Leghorn, and here—at the Villa Valsovano—Shelley wrote the greater part of his dark and pathetic tragedy *The Cenci*. At Leghorn the first edition was printed in quarto. The other works of this memorable year were written at Florence—a prose treatise called *A Philosophical View of Reform* (still unpublished in its entirety); a poetical appeal to his countrymen on the occasion of the 'Peterloo' affair, entitled *The Mask of Anarchy*; a grotesque satire suggested by the supposed failure of Wordsworth's poetic powers under the blight of Toryism—*Peter Bell the Third*; a translation of *The Cyclops* of Euripides; and in addition to these some of his noblest lyrical poems, among them the magnificent *Ode to the West Wind*.

On 12th November 1819 a son was born to comfort his father and mother, Percy Florence (died 5th December 1889). The climate of Florence was found trying, and in January the Shelley household moved to Pisa, where was spent the greater part of the poet's remaining days. The year 1820 was less productive than 1819. The charming poetical *Letter to Maria Gisborne*, a spirited translation of the Homeric *Hymn to Mercury*, the brilliant fantasy of *The Witch of Atlas*, the satirical drama *Edipus Tyrannus or Swellfoot the Tyrant*, which deals not very happily with the affair of Queen Caroline, are the chief writings of 1820. As the year was closing the Shelleys made the acquaintance of a beautiful girl, Emilia Viviani, who was confined in the convent of St Anna. To Shelley's imagination for a brief time she became the incarnation, as it were, of all that is most perfect, all that is most radiant in the universe. At such a moment he wrote his *Epipsychidion*, which is rather a homage to the ideal as seen in womanhood than a poem addressed to an individual woman. It was followed by a remarkable piece of prose—the critical study entitled *A Defence of Poetry*.

A small circle of interesting friends had gathered about Shelley at Pisa. Among these were Edward Williams, a young lieutenant of dragoons, and his wife Jane, to whom many of Shelley's latest lyrics were addressed. In the summer of 1821 the Shelleys and Williamses had much pleasant intercourse at the Baths of San Giuliano. The elegy *Adonais*, suggested by the death of Keats, was here written; it is Shelley's most finished piece of art. In the late summer or autumn he swiftly composed his *Hellas*, a lyrical drama suggested by passing events in Greece. Early next year Byron was settled in Pisa, and Shelley had also an interesting new companion in Trelawny, a young man of ardent and romantic temper. Shelley worked somewhat tentatively at his unfinished historical drama *Charles I*. His last great poem, also unfinished, *The Triumph of Life*, was written in his boat near Casa Magni, a lonely house on the eastern side of the Bay of Spezzia, occupied as a summer residence by the Shelleys, together with Edward and Jane Williams.

On 19th June Shelley heard of the arrival in Italy of Leigh Hunt and his family. He and Williams, some days later, set sail for Leghorn. The meeting with Hunt was full of joy and hope. On Monday, 8th July, Shelley and Williams left the port of Leghorn with a favourable breeze; the boat was observed at ten miles distance; then it was lost in sudden storm and mist. Dreadful uncertainty for a time came upon the two widowed women at Casa Magni. On 19th July the bodies were found upon the shore near Via Reggio. By special permission they were consumed by fire in the presence of Trelawny, Hunt, and Byron. The ashes of Shelley were placed in a casket, and were afterwards interred in the Protestant burial-ground at Rome.

In person Shelley was tall and slight, and if not of exact formal beauty of face had a countenance full of spiritual beauty, radiant with its luminous blue eyes. His portrait, painted in Rome by Miss Curran, is the only likeness of Shelley in manhood. His poetry is inspired by an ardent passion for truth, an ardent love of humanity; it expresses desires and regrets with peculiar intensity, but also sets forth a somewhat stoical ideal of self-possession, as if to balance the excessive sensitiveness of its author. The earlier poetry is aggressive and doctrinaire, embodying the views and visions of Godwin's philosophy; the later is more purely emotional. Shelley's creed, which passed at an early stage from deism to atheism, rested in his mature years on a spiritual conception of the universe.

MARY WOLLSTONECRAFT SHELLEY, daughter of William Godwin and Mary Wollstonecraft, and wife of the poet Shelley, was born August 30, 1797. Her life from 1814 to 1822 was bound up with that of Shelley. Her first and most impressive novel, *Frankenstein*, had its origin in a proposal of Byron's made in 1816 at his villa on the Lake of Geneva, that Mary and Shelley, Polidori (Byron's young physician), and Byron himself should write each a ghost story. *Frankenstein* (q.v.) was published in 1818. The influence of Godwin's romances is apparent throughout. Her second tale, *Valperga, or the Life and Adventures of Costucco, Prince of Lucca* (1823), is a historical romance of mediæval Italy. In 1823 she returned to England with her son. Her husband's father, in granting her an allowance, insisted on the suppression of the volume of Shelley's *Posthumous Poems*, edited by her; and she was obliged to submit. *The Last Man* (1826), a romance of the ruin of human society by pestilence, fails to attain sublimity, but we can trace in it with interest idealised portraits of some of the illustrious persons most intimately known to her. In *Lodore* (1835) we read under a disguise the story of Shelley's alienation from his first wife. Her last novel, *Falkner*, appeared in 1837. She published several short tales in the annuals, some of which have been collected and edited by Dr Garnett. Of her occasional pieces of verse the most remarkable is *The Choice*. She wrote also many of the lives of Italian and Spanish literary men in Lardner's *Cabinet Cyclopaedia*. Her *Journal of a Six Weeks' Tour* (partly by Shelley) tells of the excursion to Switzerland in 1814; *Rambles in Germany and Italy* describes a series of tours in her later years. She will be remembered by *Frankenstein* and her admirable notes—in large part biographical—to her husband's poems. Those who knew her intimately valued Mary Shelley for her nobility of character, even more than for her fine intellect. She died February 21, 1851, and was buried in Bournemouth.

The best edition of Shelley's works in verse and prose is Mr H. B. Forman's (8 vols. 1876-80). Mr Forman has also given an admirable text of the poetical works in two volumes. Mr Rossetti's edition of the poetical

works is of great value. The most complete one-volume edition of the poetical works is that by the present writer (Professor Dowden), who has also written the fullest and most exact Life of Shelley (2 vols. 1886). Mrs Julian Marshall has written a valuable Life of Mary Wollstonecraft Shelley (2 vols. 1889); and there is a short Life of her by Mrs W. M. Rossetti. Short lives of Shelley have been written by Mr Symonds, Mr Rossetti, Mr Salt, and Mr W. Sharp, and by the poet's daughter-in-law, Lady Shelley. Hogg's Life of Shelley is excellent for the months at Oxford. Trelawny's *Records* gives a vivid picture of Shelley during his last days. Dr Garnett's *Relics of Shelley* gave for the first time many pieces recovered from MSS. The same careful editor has superintended an admirable selection from Shelley's *Letters* (1882). Mr Forman's *Shelley Bibliography* (1882) is full and accurate. The publications of the 'Shelley Society' include reprints of several rare editions. An admirable *Lexical Concordance to Shelley's poems* was published by Mr F. S. Ellis in 1892.

Shell-fish, a popular term for many aquatic animals not fishes (in the sense in which the word 'fish' is now understood); especially oysters, clams and all molluscs, and crustaceans such as crabs and lobsters.

Shell-lac. See LAC.

Shells. See SHELL.

Shell-sand. Sand consisting in great part of fragments of shells, and often containing a small proportion of organic matter, is a very useful manure, particularly for clay soils, heavy loams, and newly-reclaimed bogs. It is also advantageously applied to any soil deficient in lime. It neutralises the organic acids which abound in peat, and forms with them compounds which serve as food for plants. Great deposits of shell-sand are found on the coasts of Devonshire and Cornwall, and are of much value in the agriculture of that district. Shell-sand is also found on many other parts of the British coast, and nowhere more abundantly than in the Outer Hebrides. The sand of many parts of the coast being mostly siliceous is incapable of the same use. Shell-sand is much used as a manure in some of the maritime districts of France, as Bretagne and Normandy.

Shelta, or **SHELRO**, is a secret jargon of great antiquity spoken by Irish tinkers, beggars, and pipers, the descendants of the ancient ceards and bards. The word Shelrú is a perversion of the Irish *béarla*, 'language.' Shelta is otherwise known as 'Cainnt ceard,' 'Minkur-tharal,' 'Gam (or Gamoch) cant,' 'Bog-latin,' and 'Béarl' eagair.' For use of last name see *Gaelic Dictionary of the Highland Society* (1828), i. 113: "'Beurl' eagair" or "'Laidionn nan ceard," the gibberish of tinkers: *figulorum stribligo*; *dialectus qua utuntur ollarum sartores circumforanei*;' also i. 548: 'Gibberish: *mendicorum et nebulonum ex compacto sermo, barbaries.*' Béarla eagair (i.e. 'vernacular') thus used must not be confounded with Béarlagair na saor (mason's jargon), a few words of which are given by MacElligott (*Dublin Gaelic Society*, 1808). The earliest specimens of this idiom, collected (1877-80) by Mr C. G. Leland from an English vagrant in North Wales and an Irish tinker in Philadelphia, are published in *The Gypsies*, pp. 354-372. The investigation of Shelta was continued by Mr D. MacRitchie in the *Journal of the Gypsy Lore Society* (i. 350-357), where fresh examples from the Scotch Highlands and south of Ireland subsequently appeared. In the same *Journal* (ii. 204-220) the present writer showed Shelta to be a systematic perversion of the pre-*spirated Gaelic* spoken anterior to the 11th century, and Dr Kuno Meyer (ii. 257-266) in an erudite paper on 'The Irish Origin and Antiquity of Shelta' adduced numerous references to this jargon in early Irish MSS. Shelta has been identified by

Dr Meyer with the ancient secret language called Ogam, a word probably surviving in the name Gam or Gamoch cant. References to Ogam as a spoken tongue occur in the *Annals of Clonmacnoise* (1328) and in O'Molloy, *Grammatica* (1677), p. 133. Several common Shelta words are found in the *Dúil Lathine* or Book of Latin (cf. 'Laidionn nan ceard;' for Latin = cant, see Pott's *Zigeuner*, i. 8), an Ogam glossary copied by MacFírhis from an old or middle Irish MS. Professor Thurneysen (*Revue Celtique*, vii. 369-375) has shown that many of these Ogam words are formed by substituting for the initial its runic name: thus *manait* (*D. L.* 137 = Shelta *münani*) is formed from *Ir. maith* by changing *M* into *muin*, the name of the letter; Shelta *nadherum*, 'mother,' being similarly an anagram of *muinathair* (*Ir. mathair*). Shelta words are also fabricated from Irish by reversing or transposing the letters of the original word (e.g. *gré*, 'rise,' *Ir. érg*; *tober*, 'road,' *Ir. bothar*), by changing the initial (e.g. *jünnik*, 'Sunday,' *Ir. domnach*), and by the prefix, suffix, or interpolation of arbitrary letters to the Irish word or its anagram (e.g. *gladher*, 'skin,' *Ir. leathar*; *thalosk*, 'day,' *Ir. latha*; *srigo*, 'king,' *Ir. rig*; *laskon*, 'salt,' *Ir. salann*). Analogous modes of word-disguise are described in the *Amra Choluimchille*, an Irish MS. of the 12th century, and in the *Uraicept na n-Eges* (Primer of the Poets), each of these processes having a recognised name. A few old Irish words are used in Shelta without disguise, as *künya*, 'priest,' *Ir. cairneach*, 'druidical priest;' *gükera*, 'beggar,' *Ir. geocaire*. Shelta borrows its grammar and unimportant words from Irish or English. The following translation of the Lord's Prayer ('Staffara a' Dhalyon') by an old Irish tinker illustrates the hybrid grammar of the Ulster dialect:

Müflsha's gather, swürth a münniath, mönni-gräha kradyl dhüflsha's münnik. Gra be grëdh'd shedhi ladhu, as aswürth in münniath. Bog müflsha thalosk minürth goshta dhurra; gretul our shakü arask müflsha getyas nidyas grëdhi gamiath müflsha. Njesh solk mwil-il stürth gamiath but bug müflsha achim gamiath. Dhi-il the srüdug, thardyürath and münniath. Gradhum a gradhum.

The tinkers believe Shelta to be an independent language of Pictish origin (*The Gypsies*, p. 371). Mr MacRitchie connects this tradition with the fact that Creevie (Cruithnigh) is a Connaught tinker surname, and Crink (Cruithneach) a nickname for Irish tinkers (Groome, *In Gipsy Tents*, p. 147). Shelta contributes largely to other English and Irish cants. See *ken* and *gage* (vb) in Harman's *Caveat* (1566), *cín* (Shelta, *ken*) in MacElligott's *Berlagar na saer*, and *tobar* in *Rapparee* (*Ir. rapaire*) cant.

Shemakha, a town of Russian Caucasus, on the Pisargat River, 63 miles W. by N. of Baku, with silk manufactures. It was known to Ptolemy and the Greek geographers as Semachia, and was subsequently for centuries the capital of the Tartar khans of Shirvan, but was entirely destroyed by Nadir Shah in 1742. Nevertheless it was soon rebuilt, but was overwhelmed by an earthquake in 1859, and a second time in 1872. Pop. 28,545.

Shemites. See SEMITES.

Shenandoah, (1) a river of Virginia, drains the beautiful and fertile valley between the Blue Ridge and the principal range of the Alleghanies. It rises in two branches, which unite about 85 miles W. of Washington, and runs north-east 170 miles to the Potomac, at Harper's Ferry. In the war of 1861-65 this valley was the scene of numerous battles, was successively occupied by the opposing armies, and finally was carried and laid waste by General Sheridan (q.v.) in 1864-65.—(2) A borough of Pennsylvania, 138 miles by rail NW. of Philadelphia. It has a very large trade in

anthracite coal, the output of the neighbouring collieries reaching \$2,500,000 in a year. Pop. (chiefly foreign, 1880) 10,147; (1890) 15,944.

Shendy, a town in Lower Nubia, on the right bank of the Nile, 100 miles N.N.E. below Khartoum, with a trade in salt, wool, carpets, ostrich-feathers, &c., and a pop. of about 5000 (40,000 prior to its destruction by the Egyptians in 1822).

Shenstone, WILLIAM, son of Thomas Shenstone of the Leasowes, Hales Owen, Worcestershire, was born there 18th October 1714. In 1732 he was sent to Pembroke College, Oxford, and whilst there devoted himself much to the study of English poetry. In 1737 he published anonymously a small volume of *Poems upon Various Occasions*; in 1741 *The Judgment of Hercules*; and next year *The Schoolmistress*, the work by which he is chiefly remembered. In 1745 he succeeded his father in the estate of the Leasowes, where he thenceforth busied himself with landscape-gardening. Such was his success in beautifying his little domain that it attracted visitors from all quarters, and brought him more fame than his poetry, but at the same time involved him in serious pecuniary embarrassments. He died 11th February 1763. *The Schoolmistress*, which has secured for the 'water-gruel bard' (as Horace Walpole dubbed him) a permanent if humble place among English poets, is written in the Spenserian stanza; and in the contrast between the stateliness of the vehicle and the familiar and homely quality of the subject, with the graphic truth of its treatment, there is a singular source of charm. Shenstone's other works are for the most part quite insignificant; but his *Pastoral Ballad* has touches of exquisite tenderness and truth of sentiment expressed in a simple and appropriate melody.

See Life by Dr Johnson prefixed to the pithy *Essays on Men and Manners* (new ed. 1868) and that by George Gilfillan to an edition of his *Poems* (Edin. 1854).

Sheol. See HELL.

Shepherd of Hermas. See HERMAS.

Shepherds. See FRIENDLY SOCIETIES.

Shepherd's Dog. See SHEEP-DOG.

Shepherd's Purse (*Capsella Bursa-pastoris*—formerly *Thlaspi*), an annual plant of the natural order Cruciferae, a most abundant weed in gardens and cornfields in Britain, and remarkable as one of the few plants that are found over almost the whole world without the tropics, adapting themselves to almost all soils and climates. It is a very



Shepherd's Purse
(*Capsella Bursa-pastoris*).

more or less pinnatifid, all the leaves more or less toothed, and rough with hairs. The root-leaves spread closely along the ground. The flowers are white and diminutive. The pouch, from which the English name seems to be derived, is laterally compressed and somewhat heart-shaped.

Sheppard, JACK, born at Stepney in 1702, was the son, grandson, and great-grandson of a carpenter, and himself at twelve, after a year and a half's schooling in Bishopsgate workhouse, was apprenticed to a carpenter in Wych Street, Drury Lane. For six years he did well, but, falling then into bad company, in July 1720 he committed the first of many robberies. In the course of 1724 he was four times caught, but as often escaped, on the occasion of his third evasion from Newgate forcing six great doors. The fifth time luck deserted him, and on 18th November he was hanged at Tyburn in the presence, it was said, of 200,000 spectators. Harrison Ainsworth has made him the hero of a novel (1839). See *Celebrated Trials* (vol. iii. 1825).

Sheppey, ISLE OF, a portion of the county of Kent, insulated from the mainland by the Swale, an arm of the Medway. It is 9 miles long and 4 broad. Once it was larger; but the sea is eating away the north shore, which is lined by cliffs of London clay 60 to 80 feet high. The church of Minster, formerly in the middle of the island, is now close to the north coast. Almost the whole of the inhabitants are massed in Sheerness (q.v.). In 1732 Hogarth and four others made 'a five days' peregrination' of the island; see their illustrated account (1781, 1782, 1817, &c.).

Shepton Mallet, an ancient market-town of Somersetshire, 15 miles from Bath. It has a market-cross, dating from 1500, 51 feet high; a church with a splendid timber roof; a grammar-school (1627); and some manufactures of silk, velvet, crape, and ale. Pop. (1891) 5501. See J. E. Farbrother's *Shepton Mallet* (1860).

Sheraton, THOMAS, designer of furniture, was born at Stockton-on-Tees in 1751. In 1791 he produced *The Cabinet-maker and Upholsterer's Drawing-Book*, with over one hundred plates (new ed. 1793-6-1802; reprinted 1896). He gave his name to a style in which ornament was subordinated to utility, and on severer lines than that of his predecessor Chippendale (q.v.). He died in 1806.

Sherbet, a beverage much used in Mohammedan countries, where stimulating drinks are forbidden. It consists of the juices of various fruits diluted with water, and sweetened.

Sherborne (A.S., 'clear brook'), a pleasant old-fashioned town of Dorsetshire, in the Vale of Blackmore, on a gentle southern hill-slope above the Yeo, 17 miles N. by W. of Dorchester and 5 E. of Yeovil. In 705 Ina, King of Wessex, made it the seat of a bishopric, with St Aldhelm for first bishop, whose twenty-fifth successor, Hermann, in 1075 transferred the see to Sarum. The noble cruciform minster, measuring 207 by 102 feet, with a tower 114 feet high, was the church of a great Benedictine abbey, founded by Bishop Roger in the first half of the 12th century. It was converted from Norman to Perpendicular after a great fire in 1436, and was restored in 1848-58 at a cost of over £32,000. Noteworthy are the clerestory, vaulting, and choir; and in the retrochoir are the graves of Asser and two of King Alfred's brothers. King Edward's School, comprising remains of the abbey buildings, was founded in 1550, and reorganised in 1871, since when it has risen to be one of the great public schools of England, with a yearly endowment of £800 and 300 boys. Former pupils have been Vice-chancellor Knight-Bruce, the Right Hon. Montague Bernard, Dr J. M. Neale, and Mr Lewis Morris. Sherborne Castle is an Elizabethan mansion, built in 1594 by Raleigh in the grounds of Bishop Roger's Norman castle (c. 1125), which, taken by Fairfax in 1645, is now a ruin. Sherborne has also a literary institute

(1859), Bishop Neville's 15th-century hospital, and the Yeatman memorial hospital (1863), with some manufactures of lace, buttons, and silk. Pop. (1861) 5523; (1891) 3741.

Sherbrooke, a city of Quebec, capital of Sherbrooke county, at the junction of the rapid Magog (with falls) and St Francis rivers, 168 miles by rail E. of Montreal, with many busy factories, and (1891) 10,110 inhabitants.

Sherbrooke, LORD. The Right Hon. Robert Lowe, Viscount Sherbrooke, was born in 1811 at Bingham, Notts, of which parish his father was rector. He was educated at Winchester, and University College, Oxford, of which he became a fellow and tutor. Called to the bar in 1836, he emigrated in 1842, and soon attained a lucrative practice at the Sydney bar; he also took a leading part in the political life of the colony, ultimately as member for Sydney. At home again in 1850, and returned in 1852 for Kidderminster as an independent member with Conservative tendencies, he in 1853 took office under Lord Aberdeen, and in 1855 under Lord Palmerston. In 1859 he was returned for the borough of Calne by the influence of the Marquis of Lansdowne; and he represented London University from 1868 till he went to the Upper House. During 1859-64 he was vice-president of the Education Board (and virtual minister for Education) in the second Palmerston administration, resigning in 1864, and introduced the Revised Code of 1860, with its principle of 'payment by results.' He largely contributed to ensure the rejection of the Whig Reform Bill in 1866. He was, with other 'Adullamites,' offered a post in the Derby government, but he declined to leave the Liberal party, though in 1867 he was still an opponent of all reduction of the suffrage. In 1868 his feud with the Liberal party was forgotten in the strenuous aid he gave the Liberal leaders in carrying the disestablishment of the Irish Church. Accordingly he obtained in Mr Gladstone's Liberal ministry the office of Chancellor of the Exchequer; exchanging it in 1873 for that of Home Secretary. As Chancellor of the Exchequer, his proposal of a tax on matches was very unpopular; but the annual surpluses were large almost beyond example. He exerted himself to keep down the public expenditure; and his curt treatment of all claimants of public money brought odium upon him. In acuteness and cogency of argument he had hardly an equal. In education he opposed the once exclusive study of the classics. An LL.D. of Edinburgh D.C.L. of Oxford, in 1880 he went to the Upper House as Viscount Sherbrooke. He published a volume of poems (*Poems of a Life*) in 1884; and he died 27th July 1892, at Warlingham, Surrey. See his *Life* by A. Patchett Martin (2 vols. 1893).

Shere Ali. See AFGHANISTAN.

Sheridan, PHILIP HENRY, general, was born in Albany, New York, March 6, 1831, a few weeks after the arrival of his Irish parents in the New World. After attending a public school in Ohio, to which state the family removed soon after his birth, he was employed for a time as a shop-boy. In July 1848 he was appointed a cadet at West Point, graduated in 1853, and was appointed a brevet second-lieutenant in the Third Infantry. In May 1861 he was a captain in the Thirtieth Infantry, and in December of that year he was made chief quartermaster of the army in southwestern Missouri. In April 1862 he became chief quartermaster under General Halleck; but in May he was given a regiment of cavalry (the Second Michigan), and, being now in his proper sphere, did such excellent work that he was soon pro-

moted to the command of a brigade, and then to a division of the Army of the Ohio. In the battle of Perryville (8th October), and still more in the battle of Stone River (Murfreesboro'), which ended on 3d January 1863, and where his division lost over 1600 men, he performed brilliant services, and earned his promotion to major-general of volunteers. He took part in the severe battle of Chickamauga, from which field the Northern army fell back within the defences of Chattanooga, and there, serving now under the immediate command of General Grant, he was engaged in all the operations of the campaign that followed, gaining especial credit for the dash and gallantry with which his division drove the enemy up the slope and over the summit of Mission Ridge. Soon afterwards transferred to Virginia, in April 1864 he was given command of all the cavalry of the Army of the Potomac, took part in the battle of the Wilderness, and made a notable raid (May 9-25) on the Confederate lines of communication with Richmond, advancing to the outer defences of that city, cutting railroads, destroying depôts, and on the 11th defeating the enemy's cavalry at Yellow Tavern with the loss of their commander, General Stuart. In the same month he was first into Cold Harbor, and in June took part in the heavy battle there, and fought a number of cavalry actions, with a dash and skill that attracted the admiration of Grant, who in August gave Sheridan the command of the army of the Shenandoah, consisting of two cavalry divisions, commanded by Torbert and Wilson. The task set him was to drive the Confederates out of the Shenandoah Valley and to close this gate to Pennsylvania and Maryland. In September he attacked the enemy under General Early, drove them beyond Winchester, and captured 5000 prisoners and 5 guns; he dislodged Early from Fisher's Hill, where he had halted, and pursued him through Harrisburg and Staunton; and then retired to Winchester, burning grain and forage as he passed. These battles made him a brigadier-general in the regular army. But Early's army, being largely reinforced by General Lee, again appeared in the Shenandoah Valley, and on October 19, advancing under cover of fog and darkness, succeeded in surprising the Northern army and driving it back in confusion. Sheridan had been in Washington, and at this time was at Winchester, twenty miles away. Hearing the guns, he put his horse to its speed, and arrived on the field by ten o'clock, waving his hat and shouting to the retreating troops, 'Face the other way, boys; we are going back.' His unexpected appearance restored confidence, the lines were re-formed, and a serious defeat was suddenly converted into a great victory. The enemy's left was soon routed, the rest shared their fate, and the Confederates were again, and finally, driven from the valley, which Sheridan, by Grant's orders, now devastated. For Winchester he was promoted to major-general and received the thanks of congress, and Grant's armies fired a salute of 100 guns in honour of the victory.

Henceforward Sheridan fought always under Grant's direct command, and took an active part in the final battles which led to Lee's surrender at Appomattox Court-house, April 9, 1865. His ability as a general was nowhere better displayed than in the action at Dinwiddie Court-house and the assault of Five Forks in March and April, which drove Lee from Petersburg and Richmond. After the war Sheridan was placed in command of the military division of the Gulf, and later of the department of the Missouri. When Grant became president of the United States General Sherman was made general-in-chief and Sheridan promoted to lieutenant-general. In 1870 the latter visited Europe to witness the conduct of the Franco-

German war, and was with Von Moltke during the battle of Gravelotte. On the retirement of Sherman in 1883 he succeeded him as general-in-chief. In May 1888 Sheridan became seriously ill, and a bill was speedily passed by both Houses of Congress restoring for him the full rank and emoluments of general. He died at his country-house in Nonquitt, Massachusetts, August 5, 1888, leaving a widow and three children. He was buried at Arlington, Virginia, within sight of Washington, where a beautiful monument marks his grave.

Sheridan was the nineteenth general-in-chief of the United States army. He never lost a battle, and the confidence and affection which 'Little Phil,' as they delighted to call him, inspired in his troops may be gauged by the story of Winchester. Among the Northern generals he ranks second only to Grant and Sherman. See his *Personal Memoirs* (2 vols. 1888).

Sheridan, RICHARD BRINSLEY BUTLER, was born in Dublin, 30th October 1751. He was the grandson of Swift's friend, Thomas Sheridan, D.D. (1687-1738), and the second son of Thomas Sheridan (1719-88), a man of established reputation as a teacher of elocution, and the author of a now forgotten *Life of Swift*. His mother, Frances Sheridan, *née* Chamberlaine (1724-66), also had achieved some success in literature, being the author of a novel called *Sidney Biddulph*, and of one or two plays. Richard Sheridan was educated at Harrow, where he does not seem to have distinguished himself much. After leaving school he made his first attempt at literature, in collaboration with a school-friend named Halhed, in the form of a three-act farce called *Jupiter*, the general idea of which bears some resemblance to that afterwards worked out in the *Critic*. It does not, however, appear to have ever been completed. The two friends next attempted a verse translation of the *Epistles of Aristænetus*—a pseudo-classical author of unknown date and doubtful identity—of which the first part was published, but attracted no favourable notice. In 1771 the Sheridans settled at Bath, where they made acquaintance with the family of Linley the composer. A sort of sentimental friendship, ripening into a warmer feeling, appears to have been set up almost immediately between Elizabeth Linley, the eldest daughter—a girl of great beauty and musical talent, popularly known as the Maid of Bath—and Richard Sheridan, which, after various romantic episodes, terminated in a marriage, with the rather reluctant consent of the parents in 1773.

The young couple settled down in London to a life considerably beyond their means. Mrs Sheridan had a fortune in her voice, but her husband would not allow her to use it professionally. He himself now made more serious efforts at dramatic composition—which had always attracted him—and got a play accepted at Covent Garden. On the 17th of January 1775 the *Rivals* was produced for the first time with no great success; but after a slight alteration in the cast the play met with universal approval. Probably it will always remain the most popular of Sheridan's performances. There is nothing in it to strain the understanding or require any education of mind to comprehend. Nor does it contain the least touch of bitterness; vices are not satirised, but only oddities laughed at. Above all, the plot is clear and connected, a point by which the ordinary playgoer is naturally apt to judge. It is not too much to say that in genuine mirthful humour Sheridan has been surpassed by Shakespeare alone; and this quality predominates in the *Rivals*. In the same year appeared the farce called *St Patrick's Day*—a poor performance which Sheridan wrote for the benefit of

the Irish actor whose personation of Sir Lucius had saved the *Rivals*—and also the *Duenna*, which received an exaggerated meed of praise, and had a (then) phenomenal run of sixty-three nights. In 1776 Sheridan, with the aid of his father-in-law, Linley, and another friend, bought half the patent of Drury Lane Theatre for £35,000 from Garrick, who was retiring from the stage, and some years later the remaining share for £45,000 from Mr Willoughby Lacy, thus becoming complete owner. His first production here was a purified edition of Vanbrugh's *Relapse*, under the title of a *Trip to Scarborough*, while three months later appeared his greatest work, the *School for Scandal*. As a dramatic composition the *School* is inferior to the *Rivals*; the plot is involved and its details obscure, the play a series of extraordinarily brilliant scenes, but wanting in cohesion. So powerful is the satire, however, and so real and striking are the characters, that Sheridan's contempt for the dramatic unities has never diminished the enthusiastic approval awarded to it from the first. It brought back prosperity for a time to Drury Lane, where Sheridan's idle and careless management had done much mischief. In 1779 he produced the *Critic*, a play of even more heedless composition than the *School for Scandal*, but teeming from end to end with a sparkling wit which carries it over all obstacles. This was Sheridan's last dramatic effort, with the exception of a tragedy called *Pizarro*—in no respect superior to Mr Puff's tragedy—prepared for the stage by him some twenty years later.

Sheridan now began to turn his thoughts to another field for ambition, and on the dissolution of parliament in 1780 he was elected member for Stafford. He adhered to the opposition, then under the leadership of Burke and Fox, and on the change of government in 1782 became under-secretary for foreign affairs under Rockingham, afterwards serving as secretary to the Treasury in the coalition ministry (1783). His parliamentary reputation, however, may be said to date from the impeachment of Warren Hastings. His part in the attack was to expose the connivance at the plundering of the Begums of Oudh, on which subject he delivered three great speeches. The first, in the House of Commons, was a marvel of oratory, and produced such an effect upon the audience that the House decided to adjourn, as being still too much under the influence of this wonderful speech to give a cool, impartial vote. The second, on the actual trial of Hastings, was rather less successful, and the answer to the pleadings of Hastings' counsel, seven years later, was, comparatively speaking, a failure. The reputation thus acquired was not sustained, his habitual indolence perhaps rendering him incapable of a continued effort. During the thirty-two years he sat in parliament Sheridan took an active part in the debates, and was known as a lively and occasionally impassioned speaker. In 1794 he again electrified the House by a magnificent oration in reply to Lord Mornington's denunciation of the French Revolution, but with this exception he never again rose to the same height. At the critical period of the mutiny at the Nore he did much to strengthen the hands of the government by his unselfish and patriotic support. He remained the devoted friend and adherent of Fox till the latter's death, and was also the defender and occasional mouthpiece of the Prince Regent. Few rewards fell to his share. In 1806 he was appointed Receiver of the Duchy of Cornwall, and in 1806 held for a short time the small post of treasurer to the navy. In 1812 he was defeated at the polls at Westminster, and his parliamentary career came to an end.

To turn to his private life. In 1792 his first wife,

to whom he had been passionately attached, though he must at times have caused her great unhappiness, died; and three years later he married again a Miss Ogle, daughter of the Dean of Winchester, who survived him. The affairs of the theatre had gone badly. The old building had to be closed as unfit to hold large audiences, and a new one built which was opened in 1794, but this also was destroyed by fire in 1809. This last calamity put the finishing touch to Sheridan's pecuniary difficulties, which had long been serious. Misfortunes gathered thick upon him, and his latter days were spent in trouble and privation. He died on the 7th July 1816 in great poverty, with bailiffs actually in possession of his house; but the friends of his prosperity came forward to give him a magnificent funeral in Westminster Abbey.

See the Memoirs prefixed to editions of his works by Leigh Hunt (1840), James P. Browne (2 vols. 1873-75), and Stainforth (1874); Lives by Watkins (2 vols. 1817) and Moore (2 vols. 1825); *Sheridan and his Times* (2 vols. 1859); *Memoirs of Mrs. Frances Sheridan*, by her granddaughter, Alicia Le Fanu (1824); W. Fraser Rae, *Wilkes, Sheridan, and Fox* (1874); the short life by the present writer ('English Men of Letters' series, 1883); Percy Fitzgerald, *Lives of the Sheridans* (2 vols. 1887); Lloyd C. Sanders, *Sheridan* (1891); and the Life by Fraser Rae (2 vols. 1896). See also NORTON (MRS.).

Sherif, or **SHEREEF**, designates a descendant of Mohammed through his daughter Fatima and Ali. The title is inherited both from the paternal and the maternal side; and thus the number of members of this aristocracy is very large among the Moslems. The men have the privilege of wearing green turbans, the women green veils, green being the prophet's colour. Many of these sherifs founded dynasties in Africa; the line which rules in Morocco (q.v.) boasts of that proud designation. The ruling prince of the district of Mecca and guardian of the Kaaba (q.v.) is called sherif, sometimes for the sake of distinction grand sherif.

Sheriff (A.S. *scir-gerefa*, the reeve or fiscal-officer of a shire), in English law, is an officer whose duties are chiefly ministerial (for he has only a few trifling judicial duties). The office is of great antiquity. The sheriff was (next to the ealdorman or earl, and the bishop) the chief man of the shire, and seems to have possessed unlimited jurisdiction to keep the peace; to have presided in the courts of the shire; to have punished all crimes, and have redressed all civil wrongs. The sheriff was formerly chosen by the inhabitants, though probably requiring confirmation by the crown. But popular elections for that purpose were put an end to by a statute of 9 Ed. II., which enacted that in future the sheriffs should be assigned by the chancellor, treasurer, and judges. Ever since that statute the custom has been, and now is, for the judges, the Lord Chancellor, and Chancellor of the Exchequer to meet in the Court of Exchequer (now the King's or Queen's Division) on the morrow of St Martin (12th November), and there propose three persons for each county to the crown. On the morrow of the Purification (3d February) the names are finally determined on, the first on the list being generally chosen; and the sovereign afterwards 'pricks off' the person selected, by piercing the list with a punch opposite his name, and so appoints him to the office. A sheriff continues in office for one year only, and cannot be compelled to serve a second time. The office is not only gratuitous, but compulsory, for if the person appointed refuses he is liable to be fined. In practice, country gentlemen of wealth are appointed. As military head of the county the sheriff was superseded by the Lord-tenant (q.v.) as early as the reign of Henry VIII. In the city of London the sheriffs are appointed

not by the crown, but by the citizens. The sheriff has important official duties in elections of members of parliament. He is, by his office, the first man in the county, and superior to any nobleman while he holds office. He has the duty of summoning the *posse comitatus*—i.e. all the people of the county—to assist him in the keeping of the peace; and if any person above the age of fifteen, and under the degree of a peer, refuse to attend the sheriff after due warning, he incurs a fine or imprisonment. The chief legal duty which the sheriff discharges is that of executing—i.e. carrying out—all the judgments and orders of the courts of law. It is he who seizes the goods of debtors or their persons, and puts them in prison. For this purpose he has a number of persons called bound-bailiffs (or, in popular dialect, bumbailiffs), who in practice do this invidious work, and give a bond to the sheriff to protect him against any mistake or irregularity on their part. The necessity of this bond is obvious, for the doctrine of law is that the sheriff is personally responsible for every mistake or excess made or committed by the bailiffs in executing the writs or process of the court; actions may be brought against him by indignant prisoners, or debtors whose persons or goods have been arrested; and the courts watch jealously the least infringement of personal rights caused by these bailiffs. Every sheriff ('high-sheriff') has an under-sheriff, usually a solicitor, who takes charge of the legal business; and he is required to name a deputy in London to whom writs may be delivered. See works by Churchill and Bruce (1879) and Atkinson (new ed. by Melsheimer, 1878).

The sheriff's extensive jurisdiction, gradually acquired at the cost of local courts, has been gradually infringed upon, partly by the exercise of the royal prerogative, and partly by parliament. But in England it suffered more from the appointment to the office of men not specially qualified to exercise judicial powers, and from the consequent usurpation of their functions by the supreme courts. The same causes operated in Scotland, though to a less extent. In England they resulted in the almost entire abolition of the judicial functions of the sheriff. In Scotland they resulted in his being deprived of the more important parts of the criminal jurisdiction, particularly of the power to punish by death, and in his civil jurisdiction being limited mainly to questions affecting movables. In both countries the office was entrusted to gentlemen having estates in the county; in some cases it was hereditary; these arrangements tended to a separation of the duties of the office into the honorary and the laborious—the former being performed by the sheriff, and the latter by his deputy. In Scotland this separation was completed by the act of Geo. II., which entirely separated the offices by the transference of the power of appointing the depute from the principal sheriff to the crown. In England this complete separation has never become necessary, from the fact of the sheriff's power having been much more crippled than in Scotland. Indeed, in England, so purely honorary and ministerial has the office become, that it has been held by a female, and in Westmorland the office was hereditary down to 1849. The duty of enforcing the orders of the supreme courts, which now in England is a principal part of the duties of the sheriff, appears to have been engrafted on the office—probably on the theory that these orders were those of the king himself. In Scotland the sheriff has never been called on to enforce any writs except those actually and not merely in name proceeding at the instance of the crown.

SHERIFF, in Scotland, is a title given to the magistrate and judge of a county. In Scotland the office of sheriff is still that of a local judge, and

not merely ministerial, as in England; and the jurisdiction, both civil and criminal, is still very extensive. The duties of the office are now performed by two officials, the sheriff—called sheriff-depute since the abolition of the Heritable Jurisdiccions (q.v.) to distinguish him from the heritable sheriff-principal—and the sheriff-substitute. The sheriff-depute, except in the case of Edinburgh and Glasgow, does not reside in the county, but holds courts therein at stated periods. The sheriff-depute is disqualified from acting as advocate in any cause originating in his county, though in other respects he is at full liberty to practise. He is appointed by the crown, must be an advocate of three years' standing, and holds his office for life or good behaviour. The sheriff-substitute was at first appointed by the sheriff-depute, but he is now appointed by the crown, requires to be an advocate or solicitor of five years' standing, and holds office *ad vitam aut culpam*. He resides within the county, and presides over the ordinary sittings of the court. The civil jurisdiction of the sheriff extends to all personal actions on contract or obligations without limit, actions for rent, and other questions between landlord and tenant. His powers are limited in matters of heritable right and title to cases where the value does not exceed £1000, or £50 by the year. He can, however, adjudicate on questions of possession beyond these limits, and he can also deal with questions of servitude and nuisance. He cannot decide questions of *status*, but he may entertain questions of aliment. There are various other matters with which the sheriff may deal, such as questions of poor-law, lunacy, elections, &c. Besides his ordinary court the sheriff holds two statutory courts, the Debts Recovery Court and the Small Debt Court. The former is for actions where the value, exclusive of expenses, exceeds £12, but is less than £50. It is confined to certain specific kinds of action, and has statutory forms of procedure. The latter is for actions not exceeding £12 in value, or which have been restricted to that amount. This latter court is made great use of by all classes of the community. The sheriff has also jurisdiction in cases of bankruptcy and insolvency. Against most judgments in ordinary cases by the sheriff-substitute there lies an appeal to the sheriff, and in some cases to the Court of Session. In criminal cases the sheriff has jurisdiction in all the minor offences which do not infer death or banishment, but his powers of punishment are practically limited to imposing a sentence of not more than two years' imprisonment. The forms of trial in use before the sheriff are jury trial and cases which are brought under the Summary Jurisdiction Acts. Changes of considerable importance, and in many of the details of criminal procedure, were introduced by the Criminal Procedure (Scotland) Act, 1887. The sheriff's jurisdiction excludes that of the justices of peace in riots. He has charge also of taking the recognitions in criminal cases, in which he is assisted by the procurator-fiscal. He revises the lists of electors, and returns the writs for the election of members of parliament; and this last is almost the only duty which he performs in common with the English sheriff. An idea of the multifarious duties performed by the Scotch sheriff may be gathered from the statement that he exercises somewhat similar functions to those which in England are exercised by the commissioners in bankruptcy, county-court judges, the stipendiary magistrates, recorders, revising barristers, and coroners. The office of Commissary (q.v.) has been amalgamated with that of sheriff. Additions to the miscellaneous duties of the Scottish sheriffs are not infrequently made in the course of legislation. See COUNTY.

The Sheriff-clerk, in Scotland, is the registrar of the sheriff's court, and as such has charge of the records of the court. He registers, and, when required by the proper party, issues the sheriff's judgments. He also conducts what correspondence may be required. He has important duties to perform in regulating the summary execution which is issued in Scotland against the debtors in bills of exchange, promissory-notes, and bonds, without the necessity of any judicial suit. See J. D. Wilson, *Practice of the Sheriff Courts of Scotland*.

In the United States the office of sheriff is mainly ministerial; the principal duties being to maintain peace and order, to attend courts as administrative officer, to guard prisoners and juries, to serve processes and execute the judgments of the courts, and to preside at inquisitions. In most of the states the sheriff is appointed by the popular vote, and the shrievalty in such places as New York is a highly paid and highly coveted political office. In all the states there are deputy-sheriffs, who are the servants and agents of the sheriff; and in some of the states there is an under-sheriff, who does duty for the sheriff in his absence. See Murfree's *Treatise on the Laws of Sheriffs* (St Louis, 1884).

Sheriffmuir, in Perthshire, on the northern slope of the Ochills, $2\frac{1}{2}$ miles ENE. of Dunblane, was the scene, on 13th November 1715, of an indecisive battle between 8400 Jacobites under the Earl of Mar and 3500 Hanoverians under the Duke of Argyll. The Macdonalds, who formed the centre and right of the Highland army, completely routed the left of their opponents; but Argyll with his dragoons had meantime driven the left of the Highlanders back for two miles. About 500 fell on each side.

Sherlock, WILLIAM, was born in Southwark in 1641, had his education at Eton and Peterhouse, Cambridge, and became Rector of St George's, Botolph Lane, London, in 1669. Later he was preferred to be prebendary of St Paul's, Master of the Temple, Rector of Therfield in Herts, and Dean of St Paul's (1691). At the Revolution he refused at first to take the oath, but soon complied. He died at Hampstead in 1707. He wrote about sixty books or pamphlets, mostly controversial. His *Practical Discourse Concerning Death* (1689) was long famous, and was styled by Addison 'one of the strongest Persuasives to a Religious Life that ever was written in any language.' The *Vindication of the Doctrine of the Trinity and of the Incarnation* (1690) opened up a fierce and unseemly controversy with South (q.v.) and others, which is said to have been closed only by the express desire of the king. Sherlock attempted to explain the relations of the three Persons by 'a mutual self-consciousness,' but his metaphysical powers were not subtle enough for his task, and he cannot be said to be altogether undeserving of South's charge of Tritheism. His *Case of Allegiance to Sovereign Powers Stated* (1691) was published to justify his own swallowing of the oath, and at once excited a raging controversy. Other works discussed Future Judgment (1692) and Future Punishment (1704-5), but these have long lost their importance.

His son, THOMAS SHERLOCK, was born in London in 1678, educated at Eton and Catharine Hall, Cambridge, and in 1704 succeeded his father as Master of the Temple. In 1715 he became Dean of Chichester, in 1728 Bishop of Bangor, in 1734 of Salisbury, and in 1748 of London. He died in 1761. Sherlock was a strenuous Tory, yet so much of an observer of the times as to earn Bentley's nickname of Cardinal Alberoni. His volumes of Temple Sermons were highly praised in their day, and the Rev. T. S. Hughes edited his complete writings, including treatises against Hoadley, on prophecy,

the *Trial of the Witnesses* for the resurrection, &c. (5 vols. 1830).

Sherman, capital of Grayson county, Texas, 64 miles by rail N. of Dallas, contains a fine courthouse and gaol, has foundries and mills, and is a depôt for grain and cotton. It was partly destroyed by a tornado in May 1896. Pop. (1890) 7338.

Sherman, WILLIAM TECUMSEH, eighteenth general-in-chief of the United States army, was born in Lancaster, Ohio, Feb. 8, 1820, sixth son of Judge Sherman, who died when William was nine years old. He attended school in Lancaster until 1836, then was appointed to a cadetship at West Point, and graduated in July 1840 sixth in a class of forty-two. He was commissioned second-lieutenant in the Third Artillery and ordered to Florida, where there was some trouble with the Seminole Indians, and was afterwards stationed at Fort Morgan and Fort Moultrie, and from 1846 to 1850 in California. Seeing no prospect of promotion Sherman resigned from the army in 1853, having previously married Miss Ellen Boyle Ewing, daughter of Thomas Ewing, secretary of the Interior, and entered civil life. He was a banker in San Francisco for several years, and at the beginning of the civil war was superintendent of the Louisiana Military Academy at Alexandria, which position he immediately resigned. In May 1861 Sherman was commissioned colonel of the Thirteenth Infantry, and joined his regiment at Washington. In the battle of Bull Run he commanded a brigade, and for good conduct in that engagement was promoted to brigadier-general of volunteers. Sherman was one of the first to estimate properly the serious nature of the struggle before the country. In August he was sent to Kentucky, but when he asked for 200,000 men to put an end to the war in that section, the authorities at Washington looked on his demand as wildly extravagant, if not insane, and deprived him of his command. But soon after he was given a division in the Army of the Tennessee, and in April 1862 displayed both coolness and skill in the severe two days' battle of Shiloh, where he was wounded, but would not leave the field. Grant afterwards wrote: 'To his individual efforts I am indebted for the success of that battle.' In May he was made a major-general of volunteers, and stationed at Memphis.

In the various movements made by General Grant against Vicksburg Sherman was most active, commanding the famous Fifteenth Corps of the Army of the Tennessee, and being next in rank to Grant. Immediately after the surrender of that Confederate stronghold, July 4, 1863 (the date of his brigadiership in the regular army), he moved against General J. E. Johnston at Jackson, Mississippi, and drove him out of that city. In November Sherman joined Grant at Chattanooga, and rendered excellent service in the great victory won there on the 25th, withstanding a long series of attacks intended to crush his command; and a few days later he hurried to relieve Burnside, besieged at Knoxville by General Longstreet, whose forces fled at the approach of the Northern cavalry. On 12th March 1864, the same day that Grant became commander-in-chief, he appointed Sherman to the command of the south-west, with headquarters at Nashville. In April he commenced his campaign against Atlanta, his command consisting of the armies of the Cumberland, Ohio, and Tennessee, in all about 100,000 men, with 254 guns. Moving from Chattanooga Sherman first encountered General Johnston at Dalton, May 14, and, by repeatedly turning his position, and constantly pursuing and pressing him, drove him to Cassville and beyond the

Etowah, thence to a strong position on Kennesaw Mountain (where the Union army was at first heavily repulsed), and finally to Atlanta, the direct attack on which began on July 17. Many bold sorties were made by General John B. Hood, who had superseded General Johnston, and fierce encounters occurred at Peach Tree Creek, Ezra Church, and elsewhere, all unfavourable to the Confederates, until on 1st September they evacuated the city, and Atlanta was won.

After giving his gallant army a rest Sherman moved out of Atlanta on his famous march to the sea, with about 65,000 men. Passing between Augusta and Macon, and meeting with little serious opposition, for Hood and his army had been disastrously defeated by General Thomas in the battle fought near Nashville, he reached the outworks of Savannah on December 10—a march of 300 miles in twenty-four days, with a loss of 63 killed and 245 wounded. The works were soon carried, and on the 20th General Hardie evacuated the city, Sherman marching in on the 21st. To President Lincoln he wrote: 'I beg to present you as a Christmas gift the city of Savannah, with 150 guns, plenty of ammunition, and 25,000 bales of cotton.' For his great services he had already been made a major-general in the regular army, and now he received the thanks of congress for his 'triumphal march.'

Early in February Sherman and his army left Savannah for the north, and by the 17th, compelling, by another flanking movement, the evacuation of Charleston, he had reached Columbia, the capital of South Carolina. Thence he moved on Goldsboro' by way of Cheraw and Fayetteville, fighting by the way severe battles at Averysboro' and Bentonville in March, and aiming either to cut off Lee's retreat or to join Grant before Richmond. But on April 9 Lee surrendered, and word of this coming to General Johnston, he made terms with Sherman on the 17th, which, however, were disapproved as too lenient by Secretary Stanton and repudiated: Lincoln had been assassinated on the 14th. The surrender of Johnston's army was soon followed by all the other Confederate forces then in the field, and the four years' war was at an end.

Before the disbandment of Sherman's army and the Army of the Potomac, they passed in review at Washington before President Johnson and General Grant on May 23 and 24, 1865. Sherman took leave of his troops in a field order of May 30. For the four years following he was in command of the division of the Mississippi; and when Grant became president Sherman succeeded to the head of the army with the rank of general, having been previously promoted to lieutenant-general. In 1872 he visited Europe, everywhere receiving distinguished honours; and in 1874, at his own request, to make room for Sheridan, he was retired on full pay. His remaining years were spent in St Louis and in New York, where he died February 14, 1891. He received a public funeral in both these cities, and was buried by the side of his wife and favourite son William in the St Louis Cemetery. Many lives have been published of Sherman, but much the most valuable are his own Memoirs, first issued in 2 vols. in 1875, and of which revised editions were published in 1885 and 1891. A noble equestrian statue of Sherman adorns New York City.

JOHN SHERMAN, statesman, a younger brother, born at Lancaster, 10th May 1823, was for a time attached as rodman to a corps of engineers, and then studied law with his brother Charles, whose partner he became after his admission to the bar in 1844. From 1855 to 1861 he sat in congress, from 1859 as chairman of the committee of ways and means; and in the senate, of which he was a member

from 1861 to 1877, he was for many years chairman of the committee on finance. As a congressman he had been eminent for the steady but statesmanlike opposition which he offered to slavery, and on the outbreak of the war he raised a brigade in Ohio largely at his own expense. Two bills for which he was largely responsible were that for the reconstruction of the seceded states and that providing for the resumption of specie payment (1879). A supporter of Mr Hayes, he was appointed by him in 1877 Secretary of the Treasury, and in 1878 had prepared such a redemption fund in gold as speedily raised the legal-tender notes to par value. In 1881 and 1887 he was again returned to the senate, was for a while its president, and afterwards chairman of the committee on foreign relations. In 1880-84-88 he was an unsuccessful candidate for the presidential nomination. The Sherman Act (1890), authorising large purchases of silver by the Treasury, was repealed in 1893. In 1897 he was made Secretary of State by Mr McKinley; but, becoming infirm, he retired from public life in April 1898, and died 22d October 1900. See Life by Bronson (1880), his *Selected Speeches on Finance and Taxation* (1879), the *Sherman Letters* (1894), and *Sherman's Recollections* (1896).

Sherry, a name derived from Xeres (q.v.), or Jerez de la Frontera, near Cadiz, and applied to the better kind of white wines grown over a considerable area in the neighbourhood of Xeres, between the mouths of the Guadalquivir and Guadalete. Sherries may be divided into the Amontillado class and the Montilla—the latter the lighter and drier, with grape spirit added only when it is required to enable the wine to stand transport. The Amontillados are generally fortified so that sherry of this type contains about 32 degrees of proof spirit. So-called 'natural sherry' has from 2 to 4 per cent. of spirit added to make it keep. Sherries are coloured by introducing wine boiled down to a liqueur, and sweetened by mixing with them wine made from over-ripe grapes. The trade is largely in the hands of Englishmen settled at Xeres: Cadiz is the chief shipping port. The export is mainly to England, and in 1891 amounted to 2,135,969 gallons—64 per cent. less than in 1873 (the year of largest imports), after which date there was a steady decrease. See SACK, WINE.

Sherwood, MARY MARTHA, a prolific writer of religious and juvenile fiction, was the daughter of Dr Butt, chaplain to George III., and a descendant of Sir William Butts, physician to Henry VIII. She was born at Stanford, Worcestershire, May 6, 1775, and from early years was an indefatigable narrator of stories. In 1803 she married her cousin Henry (afterwards Captain) Sherwood, and sailed for India, where she showed strong sympathy with the religious labours of Henry Martyn and Dr Corrie, Bishop of Madras. Her husband predeceased her (1849), and she died at Twickenham, September 22, 1851. Her first book, the *Traditions*, was written when she was seventeen. Her *Susan Grey* (1802) was one of the first attempts to write on religious subjects for the poor. Of her seventy-seven religious works and stories the least forgotten are the *Little Woodman*, *Little Henry and his Bearer*, and the *Fairchild Family*. A collected edition of her works in 16 vols. was issued in New York. See Life (chiefly autobiographical), by her daughter Sophia Kelly (1854).

Sherwood Forest, a stretch of hilly country in the west of Nottinghamshire, lying between Nottingham and Worksop, and extending about 25 miles from north to south and 6 to 8 miles from east to west. It was formerly a royal forest, and the traditional scene of many of the exploits of the famous Robin Hood (q.v.); but it is now almost

wholly disafforested, and is occupied by gentlemen's seats and fine parks. The town of Mansfield and a number of villages are situated within the ancient bounds. Numerous remains of the old forest are still to be seen. See R. White's *Nottinghamshire and Sherwood Forest* (Worksop, 1875).

Shetland, or ZETLAND (Scand. *Hjaltland*, 'high land'), a group of more than a hundred islands, islets, and skerries, forming the northernmost Scottish county, whose capital, Lerwick, is 116 miles N.E. of Kirkwall, 300 N. by E. of Edinburgh, and 222 W. of Bergen in Norway (direct distance). Extending 70 miles, and 36 in extreme breadth, they have a total area of 551 sq. m., the largest of the twenty-nine inhabited islands being Mainland (378 sq. m.), Yell (83),



Unst (47), Fetlar, Bressay, Whalsay, and Foulas. The cliff-scenery is very fine, and the sounds and voes, or firths, are so numerous that no spot is more than 3 miles from the sea. The surface is more rugged than that of Orkney, the highest points being Ronas Hill (1475 feet) in Mainland, and the Sneug (1372) in Foulas. Metamorphic crystalline rocks predominate, with isolated Old Red Sandstone; and the soil is peaty, barely one-sixth of the total area being in cultivation, whilst trees there are none. The live-stock includes from 70,000 to 100,000 sheep, some 19,000 cattle, and nearly 5000 shaggy 'Shetland ponies,' 9 to 10 hands high. The climate is equable but moist (rainfall, 49 inches); at the longest day the sun sets for only five hours, at the shortest for over eighteen. The herring and other fisheries are the leading industry, having been greatly developed since 1872. Shetland unites with Orkney to return one member to parliament; but it was dissevered therefrom as a county by the Local Government (Scotland) Act, 1889. Pop. (1801) 22,379; (1861) 31,679; (1891) 28,711. Subject, like Orkney (q.v.), to the Scandinavian crown until 1468, Shetland—the *Ultima Thule* of the ancients—is still markedly Norse in many of its characteristics, Norse being still spoken in Foulas as late as 1774, and having bequeathed many words to the Shetland dialect. In 1766 it was sold by the

Earl of Morton to the ancestor of the Earls of Zetland, but the present earl's property here is small.

See LERWICK, FOULA, BROCHS, CROFTER, and for the old Udal tenures, ALLODICIUM; Scott's *Pirate*; Tudor's *Orkneys and Shetland* (1883); Edmondston's *Shetland Glossary* (1866); and other works by Brand (1701), Sheriff Rampini (1884), and the Rev. J. Russell (1887).

Shiahs. SHITES.

Shibboleth (properly *Shibbo'leth*, Heb., 'ear of corn,' or 'stream'), the test-word used by the Gileadites under Jephthah after their victory over the Ephraimites, recorded in Judges, xii. 6. The latter could not pronounce the *sh*, and, by saying *sibboleth*, betrayed themselves, and were slaughtered at the ford. All those Hebrew names in the Old Testament which commence with the *sh* have now, through the inability of the Septuagint to render this sound in Greek, become familiar to us, through the versions that flowed from it, as beginning with the simple *s*—e.g. Simon, Samaria, Solomon, Saul, &c. The word *Shibboleth* is still used to mean a test of opinions and manners.

Shiel, LOCH, a fresh-water lake in the west of Scotland, on the boundary between Moidart in Inverness-shire and Ardgour in Argyllshire, 18 miles W. of Fort-William. It extends 17½ miles south-westward, is 1 mile broad, is overhung by mountains nearly 3000 feet high, abounds in fish, and communicates with the sea by the river Shiel and salt-water Loch Moidart. Prince Charles Edward was here, a fugitive, in 1746; and Queen Victoria in 1873. At the head is Glenfinnan (q.v.).

Shield, a portion of defensive armour held in the left hand or worn on the left arm to ward off sword-strokes or missiles. The earliest known shields date from the close of the bronze age. They are circular and flat, or but slightly convex, with a central boss, under and across which the handle is fixed. The material is thin beaten bronze, strengthened by a turned-over rim round the circumference, and by the surface being embossed with concentric circles alternating with circular rows of small bosses. The Greek shield of the Homeric period was also of bronze, circular, convex, and often ornamented with devices. The Etruscan shield of bronze, of which there is a fine specimen in the British Museum, is also circular and ornamented in concentric bands of embossed work round the central boss. The Roman infantry used a light round shield about three feet in diameter, and the cavalry carried a smaller buckler also of a round form covered with hide, while the spearmen had a large oblong convex shield of wood and leather strengthened with iron, which covered the whole body. The early Germanic shields were also large, oblong, and convex, and Tacitus, in the 1st century of our era, mentions that they were painted with gay colours and devices. These are supposed to have been the precursors of the heraldic devices on the shields of the middle ages. From the downfall of the Roman empire to the 10th and 11th centuries there seems to have been considerable variety in the forms of the shields in use among European nations, though the circular shield was perhaps the most common. The shields of the Anglo-Saxon invaders of England and of the Scandinavian vikings were mostly circular. But the Norman shield of the 11th century was kite-shaped (see BAYEUX TAPESTRY), and the triangular form continued to prevail till the 15th century, becoming gradually shorter and more obtusely pointed, or heater-shaped. After the 14th century the small round buckler came into fashion, and retained its place till the 16th century. By this time the use of firearms had made the shield practically useless in warfare. The large shields used at tournaments and pageant shields and bucklers were often highly

ornamented, some of the latter being among the most beautiful works of art of the middle ages. Round shields or *targets*, covered with hide or leather, ornamented with brass studs and bosses, were used in the Highlands of Scotland down to 1745. Many savage tribes still use shields of wood or hide of various forms. For the heraldic shields, see HERALDRY, Vol. V. p. 660.

Shield, WILLIAM, composer, was born 5th March 1748, at Swalwell in Durham, and was apprenticed to a boat-builder; but he studied music with zeal by help of Avison, and composed anthems that were sung in the cathedral of Durham; and ere long he was a conductor of concerts at Scarborough. He published a comic opera, *The Flitch of Bacon*, in 1778, and, now composer to Covent Garden (1778-97), produced several other dramatic works, including *Rosina* (1783), *The Poor Soldier* (1784), *The Woodman* (1792), *Two Faces under a Hood* (1807). But he is best known by his songs, amongst which are 'The Heaving of the Lead,' 'The Arethusa,' 'The Thorn,' 'The Ploughboy,' and 'The Wolf.' The tune of 'Auld Lang Syne,' as now sung (based apparently on an old Scotch tune), was introduced into his *Rosina*; the authorship both of it and of 'Comin' through the Rye' have even been claimed for Shield. In 1807 he published *An Introduction to Harmony* (2 vols.), in 1817 *Rudiments of Thorough Bass*, and several collections of glees, ballads, trios, &c. In 1792 he travelled and studied in France and Italy. At his death, 25th January 1829, he was Master of the King's Musicians. See a 'Memorial' published in 1891 in connection with the erection of a tombstone in his native parish.

Shields, NORTH, a seaport and market-town of Northumberland, situated on the north bank of the Tyne, near the mouth of that river, 8 miles ENE. of Newcastle-upon-Tyne. In the 13th century the germ of the present town was a collection of huts or sheds temporarily used by the fishermen of the Tyne. These were called 'shelles,' a name which has since been corrupted into 'Shields.' The prior of Tynemouth previous to 1279 built twenty-six houses and a quay here, but the burgesses of Newcastle, who claimed an exclusive right to the trade of the Tyne, frustrated his design to establish a town where, so they contended, 'no town ought to be.' For five hundred years North Shields, oppressed by Newcastle, remained a mere village, but during the 19th century its development has been rapid. The town is without any architectural character, the streets being monotonously plain, and, near the river, narrow and dingy. The principal public buildings and institutions are the town-hall (1844), the theatre-royal, the covered market, the free library and museum, the Tyne Sailors' Home (1856), and the Master Mariners' Asylum (1837-38). North Shields is within the parish of Tynemouth. There are five churches in the town (four Established Church and one Roman Catholic Church) and seventeen chapels. The Northumberland Park (in which are the remains of St Leonard's Hospital) formed part of Spital Dene, and abuts on the Tynemouth Road, covering an area of about 17 acres. The mouth of the Tyne forms an important harbour; the depth of water on the bar at low-water (spring-tides) is 20 feet; at high-water, 37. Within the borough are two extensive docks—the Northumberland (opened 1857) and the Albert Edward (opened 1884), the one having an area of 55 acres, the other of 24. Upwards of 2½ million tons of coal and coke were shipped from these docks in 1890. The principal imports are corn, timber, and esparto grass. About 101,000 tons of shipping are registered at the port of North Shields. There is much building and repairing of steam and

sailing vessels and manufacture of anchors, chain-cables, ropes, &c. At the fish-quay (4½ acres in extent) there were landed in the year ending March 25, 1890, 6530 tons of herrings and 6146 tons of whitefish. At Clifford's Fort is a submarine mining station. In conjunction with Tyne-mouth (q.v.) and three small townships North Shields forms a municipal and parliamentary borough, named after Tyne-mouth, and sends one member to parliament. The population of the municipal borough of Tyne-mouth, of which North Shields forms a part, in 1881 was 44,118; in 1891 it was 46,588. This town is the birthplace of the painters George Balmer (1805-46) and Birket Foster (born 1812), also of William Wouldhave (1751-1821), who shares with Greathead the honour of inventing the lifeboat. Henry Taylor (1737-1823), who originated the system of lightships in such places as Goodwin Sands, was from 1772 to his death associated with North Shields.

Shields, SOUTH, a seaport, municipal and parliamentary borough, and market-town of Durham, situated on the south bank of the Tyne at the mouth of that river, 9 miles ENE. of Newcastle-upon-Tyne. On the Lawe, an eminence overlooking the river, the Romans had an important military station, approached from the south by the Rykfield Way. In Saxon times it was called Caer Urfa, and is said to have been the birthplace of King Oswin. Salt-pans were established here in 1489, and glass-works in 1619. The oldest part of the town extends for about two miles along the river-bank, the streets being narrow and dingy. Ocean Road—a fine broad thoroughfare nearly a mile long—stretches from the market-place to the pier. Several of the modern streets are wide and well-built. South Shields is becoming popular as a watering-place. The coast southward is very fine, the cliffs—magnesian limestone of the Permian system—being hollowed into picturesque caves. The principal public buildings are the town-hall, in the centre of the market-place (1768); the public library, news-room, and museum (1859); the marine school (opened 1869); the theatre-royal (1866); and the Ingham Infirmary (1873). South Shields is in the parish of Jarrow (q.v.). There are twelve churches in the borough (ten belonging to the Established Church and two to the Roman Catholic Church) and twenty-six chapels. At the east side of the town are the North and South Marine Parks, 45 acres in extent, divided by the pier parade. A portion of the site of the Roman station, containing the remains of the Forum, treasury, western gateway, &c., has been enclosed by the corporation and laid out as a recreation ground. The south pier—a gigantic breakwater 5218 feet in length, protecting the harbour from the south-east gales, was begun in 1854, and not quite completed at the end of 1891. Nearly 30,000 tons of shipping are registered at the port of South Shields. The harbour is lined with ship and boat yards, iron, glass, alkali, and rope works, paint and varnish manufactories, &c. Within the borough are the Tyne Docks, the property of the North-Eastern Railway, from which 5,695,829 tons of coal and coke were shipped in 1890. The docks were opened in 1859, and cover an area of 50 acres. There is a large colliery in the town—the St Hilda—which was opened in 1810. In an explosion here in 1839 fifty-nine persons were killed. The first lifeboat was built at South Shields, and was used for the first time on January 30, 1790. A memorial to the inventors Wouldhave and Greathead has been erected on the pier parade. Near it is preserved the old 'Tyne' lifeboat which saved no less than 1024 lives. A life-brigade was established here in 1866. A steam-ferry for passengers and carriages plies day and night between North and

South Shields. South Shields was incorporated in 1850. Since 1832 it has returned one member to parliament. Pop. (1851) 28,974; (1881) 56,875; (1891) 78,391.

Shifnal, a town of Shropshire, 17 miles E. by S. of Shrewsbury, with iron manufactures. Pop. 3531.

Shigatze, or DIGARCHI, a town of Tibet, stands on the right bank of the Sampo or Brahmaputra, 140 miles W. by S. of Lhasa, at an altitude of 12,000 feet. Near by is the great monastery (3500 monks) of the Tashilunpo, the residence of one of the Tibetan incarnations of Buddha. Pop. of Shigatze, 9000.

Shiites (also *Shceahs*; 'sectaries,' from the Arab. *shiah*, 'a party'), the name given by orthodox Muslims or Sunnites to Ali's followers, who call themselves *al-adeeliyyah*, 'the right people.' They were the champions of Ali's right to be Mohammed's successor as being his cousin and son-in-law (see CALIF, ALI); and after Ali's death they took the side of his sons Hassan (Hasan), Hussein (Hosain), and Mohammed ibn al-Hanafiyah. The Persians, believers in the divine right and even in the divine nature of kings, took this side. All Shiites allegorise the Koran; but the ultra-Shiites, founded by Abdallah ibn Sabā, a converted Jew of Yemen, differed from the moderate Shiites or Zaidites in believing in the transmigration of souls, and in calling Ali and his legitimate successors incarnations of God. By Shiite help the Abbāsides in 750 wrested the califate from the Omniades. Yet, unsound as the Abbāsides were, and decided as Persian ascendancy was for 100 years, the Shiites gained little. They were the strength of 'the veiled prophet' (see MOKANNA) in 770-779 and of Bālek 817-837. Their disaffection was one chief reason for the introduction of Turks into the calif's service (830-840). In 765 the death of Jaafar the Veracious, the sixth Shiite Imām, developed the Isma'ili sect of the Shiites. Those followed the eldest son Ismael; the majority, following Moosā the second son, were afterwards named *Twelvers*, the series of their Imāms ending with the twelfth. In Irāk in 887 arose the Karmathian branch of the Isma'ilis. In 909 an Isma'ili proclaimed himself in North Africa as the first Fātimide calif. The 6th calif of this line, HAKIM, was declared to be God's tenth and final incarnation by Darazi, who founded the sect of the Druses. In 1090 Hassan Sabbāh, an Isma'ili of Khorassān, as the Sheikh of the Mountains instituted the order of Assassins, who generally recognised the Fātimide califate. Isma'ilis are still found in Persia and Syria. The moderate Shiism that has been the national religion of Persia since the native royal line of Safides ascended the throne in 1499 is more Koranic than Sunnism. It has Hadith and Sunna (see SUNNITES), but not those of the orthodox Muslims. It has its own modes of religious washing, and its own postures in prayer. Shiites, habitually ill-used in Arabia, absent themselves much from Mecca, and, unable to bless Abu-bekr and Omar, who are buried in Medina, go still less thither. But they do pilgrimage unhindered to the tombs of Ali and Hussein in the pashalic of Bagdad, and to the tomb of Riza, one of their twelve imāms, in Meshhed, the capital of Khorassan, and to the tombs of Shiite saints. They keep the orthodox feasts and others, among which the Moharram feast, occupying the first ten days of the month Moharram (q.v.), and commemorating the martyrdom of Hussein, is the chief. (For the Shiite cry of *Ya Hasan! Ya Hosain*, see HOBSON-JOBSON.) They detest Ayesha and the founders of the four orthodox schools, and hold all califs save Ali to have been usurpers. They own no califate nor imāmate; these have been dormant since the death of

Mohammed, their twelfth imâm, in 879, but shall be revived in him when he, the Hidden Imâm, reappears as the Mahdi. Shiism, the ancient protest of Persian patriotism against Arabian ascendancy, has spread through Afghanistan into India, but toward the west has made no way. The Shiites, divided and subdivided into sects, number 10 millions, most of whom are Aryans. Toleration and free thought are common in towns and among the more cultivated Persians, especially toward the north. In 1736 Nâdir Shah tried but failed to restore the Shiites to orthodoxy.

Shikarpur, an important trading-town and capital of a district in the north of Sind, stands 18 miles W. of the Indus, on the railway leading to Quetta and Pishin. Before the opening of this railway it was a place of very considerable commercial importance, owing to its situation on one of the principal routes between India and Khorassan—viz. that by the Bolan Pass. It occupies a very low site, the adjacent country being often inundated, but the soil is extremely fertile, and yields heavy crops of grain and fruits. Carpets, coarse cottons, furniture, baskets, &c. are made in the town. Pop. 42,496.—The district has an area of 10,001 sq. m. and a pop. of 852,986.

Shikarry. See SHEKARRY.

Shilka. See AMUR.

Shillelagh, the cudgel carried by the conventional Irishman, with which he is supposed to delight to play upon the heads of his friends on occasion. The name is borrowed from the once famous oak-forest of Shillelagh in the south-west corner of County Wicklow, which in Rufus' day furnished 'cobwebless beams' for the roof of Westminster Hall. The railway station of Shillelagh, 16½ miles SW. of Anghrim, is the terminus of a branch-line.

Shilleto, RICHARD, the greatest Greek scholar of his day in England, was born in 1810, educated at Shrewsbury and Trinity College, Cambridge, and took the second place in the classical tripos in 1832. Shortly after graduating he married, and thus made himself ineligible for an ordinary fellowship. For some five and thirty years his best energies were given to 'coaching' or private tuition, and it was only in 1867 that he was elected Fellow of St Peter's College, and so obtained leisure to realise the great ambition of his life. This was an edition of Thucydides, of which he only lived to publish the first book, dying on 24th September 1876. He edited Demosthenes' *De Falsa Legatione* (1844).

Shillbeer, GEORGE (1797-1896). See OMNIBUSES.

Shilling (A.S. *scylling*), a coin whose name is most probably derived from a root *skil*, 'to divide,' apparently because it was deeply marked with an indented cross, so as to allow of its being easily broken in four. The old Saxon coin of this name was worth about 5d. The shilling in our sense was first coined by Henry VII. in 1504; milled shillings were first coined by Charles II. in 1662. The silver shilling is nominally worth the twentieth part of a pound sterling. But the silver of which shillings are made contains 11 oz. 2 dwt. pure silver to 18 dwt. alloy; and a pound by weight of this compound is coined into 66 shillings; so that each shilling contains 80·727 grains fine silver, and its value as bullion is very much less than its nominal value. The shillings in the old coinages of various north European countries had usually a much smaller value—e.g. the Danish copper *skilling* and the silver *schilling* of Hamburg were each worth less than 1d.

Shiloh, a town of the tribe of Ephraim, the first permanent resting-place of the Tabernacle

(q.v.), the home of Eli and Samuel, and long the religious centre of Israel. The site is well ascertained—a ruinous village hidden among the hills 20 miles north of Jerusalem.

Shiloh, one of the most desperate battles of the American civil war, takes its name from a log meeting-house, 2 miles from Pittsburg Landing, which is on the Tennessee River, 8 miles above Savannah. Here, on Sunday 6th April 1862, the Confederates (40,000) under General A. S. Johnston attacked and surprised the Union army (33,000) under General Grant. The battle raged from dawn to sunset, the Federal troops being steadily driven back; but the effort to utterly crush Grant failed, and the next day he won back all the ground he had lost, and the Confederates retreated. On the 6th Johnston was killed while heading the charge of a brigade. The Southerners had 1728 killed, 8012 wounded, and 957 missing; the Northerners, 1754 killed, 8408 wounded, and 2885 missing.

Shimonoseki, a town of Japan, at the south-west extremity of the main island and the western entrance to the Inland Sea, was declared a seaport open to foreign traders in 1890. The batteries and a part of the town itself were destroyed during a bombardment by a combined English, French, Dutch, and American fleet in 1864. In 1895 a treaty of peace was concluded here between China and Japan. Pop. 30,825.

Shin, LOCH. See SUTHERLAND.

Shingles (probably derived from Lat. *cingulum*, 'a belt') is the popular name for the variety of *Herpes* (q.v.) which is known as *H. zoster*.

Shingles, flat pieces of wood used in roofing like slates or tiles. Such roofs are much used in newly-settled countries where timber is plentiful. The wood is chosen from among the kinds which split readily and straightly, and is usually some kind of fir. It is cut into blocks, the longitudinal faces of which are of the size intended for the shingles, which are then, in Germany, for instance, regularly split off in thicknesses of about a quarter of an inch, but in America are sawn out, somewhat thicker at one end than the other. In the United States shingles, usually some 6 inches wide by 18 long, are in common use, and their manufacture, especially in the Pacific states, has reached enormous proportions. Shaved—i.e. hand-made—shingles of Washington cedar fetch a somewhat better price than the sawn ones, which cost about \$2 per 1000. Shingles are laid with one-third of their length (the thick end) to the weather.

Shintoism. See JAPAN, Vol. VI p. 287.

Shipbuilding. From crossing a stream of water on a floating log, or on two or more logs fastened together raft-wise, the first steps towards shipbuilding were probably the Canoe (q.v.) and Coracle (q.v.). The earliest Egyptian drawings show boats constructed of sawn planks, and having sails as well as numerous oars. So far as can be learned from ancient sculptures, the ships of ancient Greeks and Romans appear to have been open, at least in the middle portion; to have been built with keel, ribs, and planking; and to have been strengthened crosswise by the numerous benches on which the rowers sat. Ships continued, however, to be generally of small draught, for they were beached every winter. The Romans built their vessels of pine, cedar, and other light woods; but their ships of war were of oak at the bows, clamped strongly with iron or brass, and having *rostra* or beaks, for use as rams (see TRIREMES).

With Rome's decline arose a new era for shipbuilding. The hardy Norsemen had chopping seas

and Atlantic swells to fight with; their ships differed much from the stately galleys of the empire. A viking war-ship, unearthed in 1880 from a sepulchral mound at Sandefjord in Norway, and now preserved at Christiania, is clinker-built, 78 feet long, 17 wide amidships, and 5½ deep, drawing less than 4 feet of water; she had 32 oars and one mast, 40 feet high, which probably carried a single square sail. The introduction of galleys by Alfred, pulled by forty and sixty oars, kept the viking war-ships in check; but these galleys were only fit for shore-service. Canute undertook his final invasion with ships of but moderate size, the average complement of each consisting of eighty men only—less than can be carried by many of the small boats now used as part of the equipment of sea-going ships. The 'large ships' in which Richard Cœur de Lion in 1190 conveyed his forces to the Crusades were of but small dimensions, but depended chiefly for propulsion not on rowers but on sails. The voyage to the Mediterranean—longer than those ordinarily undertaken previously—was of itself the source of enlarged experience to the sailors, and led to the improvement and increase of British shipping. The mediæval galley of the Mediterranean is described at Galley (q.v.). Henry V. during the early part of the 15th century ordered the construction of several large ships, the wonder of their time, one of which is recorded to have been about 165 feet extreme length, 112 feet length of keel, and 46 feet beam. Henry VII., and still more Henry VIII., did much to encourage ship-construction both for war and commerce, the latter building the *Great Harry* (see NAVY, Vol. VII. p. 415). The year 1511 saw the construction in Scotland of the *Great Michael*, 'ane varie monstrous great schip,' 240 feet in length, said to have cost about £20,000 Scots. Columbus made his first voyage to the New World in the *Santa Maria*, of 90 feet keel and 29 feet wide, with two small undecked caravels (see also the articles on the navigators Gama, Gilbert, Frobisher, Drake, Magellan, Dampier, Anson, &c., and those on Geography and Polar Exploration).

At this period in the history of shipbuilding the main principles of wood construction were already clearly established, and subsequent development in size, down at least till the beginning of iron shipbuilding, was mainly characterised by such modifications in individual parts or in structural arrangements as made such development possible. Scarcely any advance in the size of ships was made during the reign of Elizabeth, notwithstanding that this was pre-eminently the period of daring navigation. Much was done by her successor to develop both the royal navy and the mercantile marine. He appointed commissions of inquiry into naval affairs, granted a new charter to the East India Company, and endeavoured to raise the standard of knowledge and practice amongst shipbuilders by granting a charter in 1612 to the Shipwrights' Company, and endowing it with jurisdiction over all shipbuilders in the kingdom. The first president of this body was Phineas Pett, master-shipwright of Woolwich Dockyard. To this eminent shipwright, and to his son Peter and Sir Anthony Deane, naval architecture owed much during the 17th century. This period of progress, however, was followed by a century of almost utter stagnation in respect of the application of science to shipbuilding. Skill and thoroughness in ship-carpentry as a craft were indeed not wanting; but there was nothing like adequate application of scientific principles to the evolution and improvement of naval architecture. The best scientific talent during this period and well on into the 19th century was

to be found in other countries than England—France, Spain, Sweden, and Denmark; while the British ships produced—particularly ships of war, but also merchant-ships—were, as regards speed, size, and sea-behaviour, far surpassed by the ships of the countries named. 'System' had become so stereotyped that glaring imperfections—such as the lack of both longitudinal and transverse strength—were permitted and perpetuated. At length came a shipbuilder who had courage to break away from established practice, and introduce improved methods of construction. This was Sir Robert Seppings, who began as an apprentice shipwright in the dockyards, and rose to the position of surveyor of the navy, which he held till 1832. To counteract the effect of 'hogging'—i.e. the dropping of the ends of the ship relatively to the middle—he associated with the transverse 'ribs' or frames (see the section of a wood ship shown by fig. 1) an inner framework of ties or 'riders' arranged diagonally. A more important modification still was the introduction of 'fillings' between the frames up to some distance above the bilges. These fillings, occupying as they did the whole space between the ribs, were of great value, both as safeguards in the event of damage to the outside planking and as affording immense assistance to

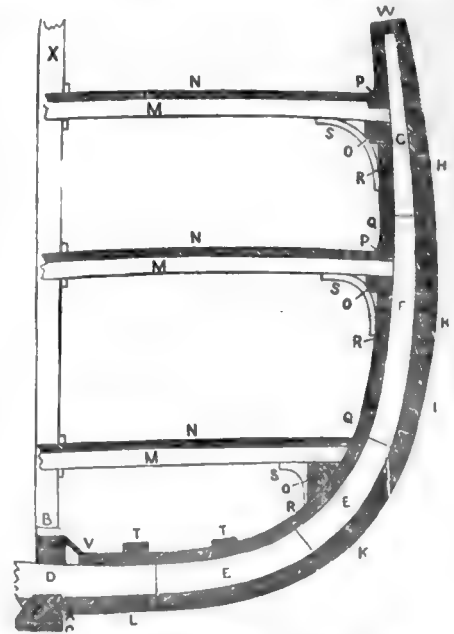
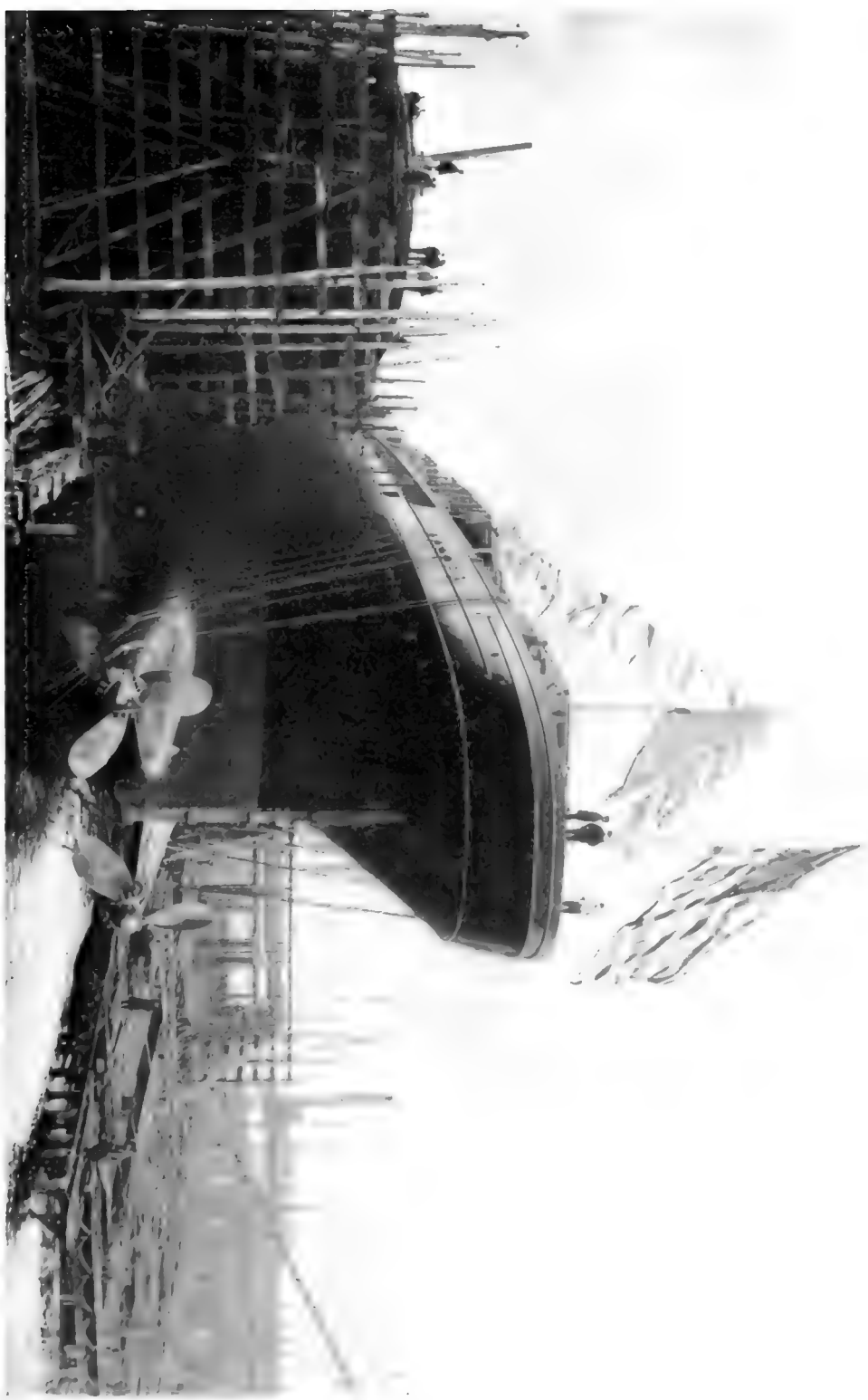

Fig. 1.—Midship Section of Wooden Vessel.

A, keel; B, keelson; C, false keel; D, floor; EE, futlocks; F, top-timber; G, lengthening piece; HH, wales; I, diminishing planks; K, bottom planks; L, garboard strakes; M, beam; N, deck; O, shelf; P, waterway; Q, spirketting; R, clamps; S, knees; T, side keelsons; V, limber strakes; W, rough-tree rail; X, mast.

the resistance offered by the lower parts of the ship to hogging. A third important change was in the mode of attaching the deck-beams to the frames at the sides of the ship. This bold shipwright suggested and ultimately effected the reduction of the long 'beak-heads' and lofty square sterns which had for centuries characterised British war-ships. With Seppings' improvements the way was made thoroughly clear for increase in the size and power of wood ships, and the results were exemplified in those towering three-deckers long the pride and glory of the navy, and in the staunch

VESSEL ON THE LAUNCHING-WAYS.



and elegant merchantman known on every sea. At the present day, however, wood shipbuilding in Great Britain has so fallen into desuetude as to have become mainly a matter of historic interest. It is a thing entirely of the past in the royal dock-yards, and is of the smallest importance in British mercantile shipyards, though at a few minor ports a little wood shipbuilding is still carried on (see table on page 411). In Canada and the United States, on the other hand, the great bulk of new shipping still consists of wood. Wood is even being employed in the construction of steamships of considerable size, and of sailing-ships of dimensions never before attempted in America.

While wood has thus largely been supplanted by iron and steel in the construction of ships, no such sweeping change has taken place in the means for their propulsion. Steamships have undoubtedly made a wonderful transformation, but spread of sail and 'unbought wind' are still potent factors in the speeding of ships across the ocean. Indeed within recent years the size of sailing-ships and the extent of their rig have enormously increased. Full-rigged ships formerly had only three masts, but four and even five-masted vessels have become not uncommon. Fig. 2 shows a three-masted ship,

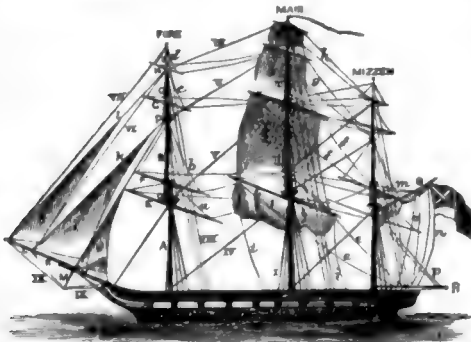

Fig. 2.—Diagram of Ship:

Spars, &c.—A, mast; B, topmast; C, topgallant-mast; D, royal-mast; E, yard; F, top-sail-yard; G, topgallant-sail-yard; H, royal-yard; J, bowsprit; K, jib-boom; L, flying jib-boom; M, martingale; N, chains; O, top; P, cross-trees; Q, gaff; R, sparker-boom.

Sails.—1, course; 2, topsail; 3, topgallantsail; 4, royal; 5, sparker; 6, fore-topmast-staysail; 7, jib; 8, flying-jib.

Standing Rigging.—i, shrouds; ii, topmast shrouds; iii, topgallant shrouds; iv, stay; v, topmast stay; vi, topgallant-mast stay; vii, royal stay; viii, backstays; ix, martingale stays.

Running Rigging.—a, lifts; b, topsail lifts; c, topgallantsail lifts; d, royal lifts; e, braces; f, topsail braces; g, topgallant braces; h, royal braces; i, sheet; k, jib-stay; l, flying jib-stay; m, peak halyards; n, signal halyards; o, vangs; p, topping lifts.

Note.—The corresponding rigging, &c. on the different masts have the same names, prefixed by the name of the mast; such as Fore-top-sail-yard, Main-top-sail-yard, Mizzen-top-sail-yard, &c. See also SAILS.

with its rigging, spars, and sails. In all substantial points the rig of each mast is the same; to understand one consequently is to understand all. The illustration of *La France* (fig. 3), a five-master of 3784 tons, built in 1800-91, gives evidence of the increased

size of hull and the great spread and intricacy of rigging in the colossal ships of modern times. Another and still larger vessel, the *Marie Rickmers*, built by Messrs Russell & Co. of Port-Glasgow in 1891-92 for Messrs Rickmers & Co. of Bremen, has no less than 56,500 square feet of sail area; 21,300

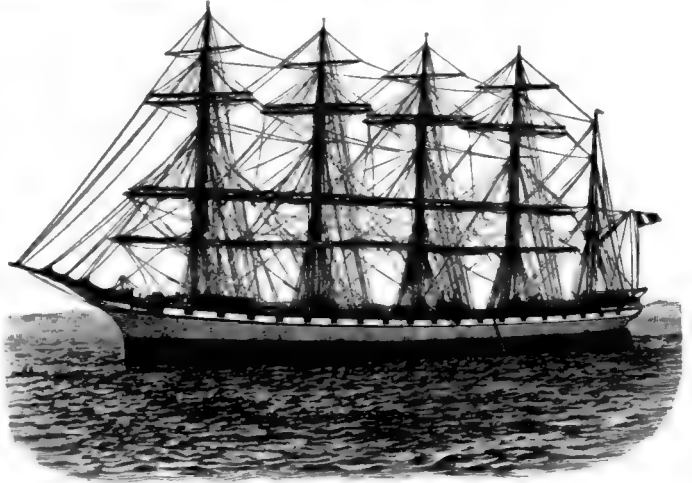

Fig. 3.—*La France*.

(From a Photograph by Messrs Adamson & Son, Rothsay.)

lineal feet, or over 4 miles, of steel wire in the form of shrouds, stays, &c.; and 31,000 lineal feet, or approaching 6 miles, of running cordage. The combined height of the masts is 960 feet, and the combined length of the spars—yards, booms, and gaffs, by which the spread of sail is suspended—no less than 2000 lineal feet. Not only are the sailing-ships of to-day on the whole much larger and better fitted than those which made for themselves great reputations and earned for their owners large fortunes about the middle of the 19th century, but steam appliances for managing the sails, anchor, &c. at sea, and for dealing with cargo in port, are now no inconsiderable part of their equipment. In ponderously-rigged vessels like *La France* and *Marie Rickmers*, intended for long voyages, the need for such appliances is of course almost imperative. In the case of the latter, steam is also employed as an auxiliary to the sail-power for propulsion. The utter incapacity of sailing vessels to make progress in a calm is one of their greatest defects—a defect increased tenfold in the case of very large vessels. The use of auxiliary steam-engines is not an innovation, as many of the larger vessels of 1850-60 were so fitted. Proving too expensive an item in the equipment of the comparatively small vessels of those days, the auxiliary engine was generally abandoned. Most of the conditions at that time unfavourable are now, however, entirely changed. The weight of engine and coal to be carried for a given power developed and length of voyage undertaken has been marvelously diminished, as also the space occupied. There is now, perhaps, some danger of owners and builders overdoing matters by saddling large sailing-vessels with more powerful engines, and consequently more dead-weight, than the needs of the case warrant. The provision of power sufficient to propel a vessel out of calms at the rate of 5 or 6 knots, or in stormy weather to take her from dangerous proximity to a lee shore, is all that should be aimed at. The *Marie Rickmers* is fitted with triple-expansion engines of about 600 indicated horse-power (i.h.p.), capable, it is esti-

mated, of propelling her, fully loaded and in calm weather, about 7 knots. They are situated near the stern, and they drive a feathering screw-propeller of the 'Bevis' type, the advantages and efficiency of which have already been fully demonstrated in government vessels and large first-class auxiliary yachts. By suitable gearing worked from the engine room, and led through the hollow of the shafting, the disposition of the blades can be altered relatively to the longitudinal axis of the shafting as may be desired, and even turned so as to be exactly in line with the axis, in which position of course they will offer the least resistance to the vessel's progress while proceeding under sail alone.

Steamships.—When the steam-engine came into vogue as a moving power its utility for the purposes of ship-propulsion occurred to many minds. The Spaniards claim that Blasco de Gary as early as 1543 attempted to propel a vessel by steam in the harbour of Barcelona. Denis Papin (q.v., 1647-1712) on 27th September 1707 employed a steam-engine to drive a model boat fitted, with paddle-wheels, on the river Fulda from Cassel to Münden. Jonathan Hulls in England patented in 1736 and described in 1737 a form of paddle-steamer resembling in many essential features vessels still in use. Other inventors proposed more or less feasible schemes for applying the imperfect forms of the steam-engine as then known to ship-propulsion.

The real beginnings of practical steam-navigation, however, are to be found in the period 1780-90, and almost simultaneously, and probably with little knowledge of what was being done elsewhere, the pioneers of progress set to work in England, France, and America. The Marquis de Jouffroy (q.v., 1751-1832) produced a paddle-steambot at Lyons, which, on being tried for speed there on July 15, 1783, attained most encouraging success; but, ruined by the Revolution, he failed to bring his invention into practical use. About 1785 two American inventors—James Rumsey (c. 1743-92) and John Fitch (q.v., 1743-98)—were independently engaged in steamship experiments. Rumsey in 1786 succeeded in driving a boat at the rate of 4 miles an hour by jet-propulsion—i.e. forcing by steam-pumps a jet of water through the stern. Rumsey died in London just prior to trials being made on the Thames with another boat from his plans. Fitch began his experiments with paddle-wheels in 1785, but more successfully in 1787-88 with a series of paddles worked with a motion resembling that of the Indian's paddle in canoe-propulsion. In April 1790 another of Fitch's boats made 7 miles an hour, and afterwards plied as a passenger-boat on the Delaware. Fitch disputed with Rumsey and others the right to be considered the inventor of steam-navigation; but losing all hope of making headway in America, he went to France in 1793. Again in 1796 he was back in America experimenting with a little *screw* steambot on a pond in New York. This led to no practical result, and Fitch, disappointed and broken down, retired to Kentucky, where he seems to have committed suicide. For a number of years prior to 1788 experiments with boats driven by paddle-wheels, worked by manual power, had been made by Patrick Miller (1731-1815), a retired Edinburgh banker, in a lake on his estate of Dalswinton, Dumfriesshire. On the suggestion of James Taylor, tutor to his sons, Miller was led to think of applying steam as the motive-power—though the original idea is also claimed as his. Taylor introduced to him William Symington, a mechanic at Wanlockhead, who had already invented an engine for road locomotion, as an assistant in his experiments. During the summer

and autumn of 1788 the skill and ingenuity of Symington were exercised in constructing an engine after the pattern of his own road-engine, on board a boat 25 feet long by 7 feet broad, having twin-hulls with paddle-wheels between. On October 14, 1788, this small craft was propelled through the waters of the lake at the rate of 5 miles per hour, in presence of Robert Burns, Lord Brougham (then a boy), Nasmyth the painter, and other friends of Mr Miller. A year later (October 1789) a larger and more powerful vessel was built and engined for Miller at Carron Ironworks, and tried on the Forth and Clyde Canal, the speed then attained being about 7 miles per hour. Miller, as Carlyle tells us, 'spent his life and his estate in that adventure, and died quasi-bankrupt and broken-hearted.' Symington's pecuniary circumstances did not admit of his experimenting further on his own account, and it was not until twelve years after that he had the opportunity of following up previous efforts with one still more emphatically successful. Meantime in America others were at work besides Fitch, amongst whom were Samuel Morley, Nathan Read, John Steven, Nicholas Roosevelt, Chancellor Livingston, and Robert Fulton. None of these, however, had materially advanced the cause of ship-propulsion by steam, when in 1801-2 Symington completed for Thomas, Lord Dundas of Kerse, a steam-vessel intended for towing purposes on the Forth and Clyde Canal. This was the *Charlotte Dundas*, the 'first practically successful steamboat ever built.' The engine was of Watt's double-acting type, turning a crank on the shaft of the paddle-wheel, which was situated at the stern. Early in 1802 she was launched on the canal at Grangemouth, and in March of the same year she towed two laden barges, each of 70 tons burden, a distance of about 20 miles against a strong headwind in six hours. After repeated trials the proprietors of the canal were urged to adopt the new plan of towing, but, fearing injury to the banks of the canal from the wash caused by the paddles, they declined the proposal. The *Charlotte Dundas* was beached upon the canal bank, and gradually broken up; and Symington, thoroughly disheartened, turned his attention to other matters.

Amongst those who are said, on sufficiently credible authority, to have inspected the *Charlotte Dundas* were Robert Fulton (q.v., 1765-1815) and Henry Bell (q.v., 1767-1830), two enterprising spirits, afterwards destined—the one in America, the other in Scotland—to achieve permanent success with steamships. Fulton went to Paris in 1797, and for some years was engaged experimenting with submarine torpedoes and torpedo boats. About 1801-2, jointly with Chancellor Livingston, then ambassador at the court of France, he built a steambot on the Seine, the engine for which, proving too heavy for the hull, caused it to collapse and sink. Nothing daunted, Fulton recovered the machinery and placed it in a new and stronger boat, 66 feet long by 8 feet broad. On August 9, 1803, this boat was tried on the Seine, but attained only very limited speed. Fulton, returning to England in May 1804, remained for over two years; and there he ordered and saw completed by Boulton and Watt a steam-engine which Livingston and he intended should be utilised in America. He sailed in October 1806, the engine following, and in August 1807 it was part and parcel of the *Clermont*, a vessel 133 feet long, 18 feet broad, and 9 feet deep, built to Fulton's order. Her first trip between New York and Albany, a distance of 142 miles, was made in thirty-two hours' steaming time, and the return journey occupied thirty hours. The

Clermont was undoubtedly the first steamboat profitably employed—at least continuously—in useful service, and Fulton is accordingly entitled to the distinction of having been 'the first to make steam-navigation an everyday commercial success.' (For the history of American shipbuilding, see p. 410.)

America, with its enterprise and its great natural field for inland-navigation, was infinitely better prepared for the innovation than the old country, with its traditional achievements, conservatism, and prejudices. Yet Henry Bell's venture in 1811-12 is, for various reasons, worthy of note and admiration. Henry Bell, by training a millwright, was proprietor of a hotel at Helensburgh on the Clyde. He had long had convictions as to the high place which the steam-engine would take in ocean-navigation, and had knocked at the door of both the British and American governments for encouragement to prosecute his ideas. The ultimate result of his own financially unaided efforts was the renowned *Comet*, which was launched from the yard of John Wood of Port-Glasgow in January 1812. She was 42 feet long, 11 feet broad, 5½ feet draught of water, and her engine, fitted by John Robertson of Glasgow, was of 3 horse-power. She plied on the Clyde from Glasgow to Helensburgh, and thence across the river to Greenock, her speed being about 5 miles per hour. After a time, when her immediate successor, the *Elisabeth*, and other steamers had been built and were running successfully, the *Comet* was lengthened to 60 feet, and fitted with a new engine and a single pair of paddles (at first there were two paddles a side), and attained a speed of 6 miles an hour.

The building of steamships was soon fairly established, and the Clyde took the lead in their construction. While most of them were intended for home river or coasting trade, not a few were built for service at distant ports. Of the four steamers produced in 1814, one, the *Marjory*, was the first steamer to ply upon the Thames, having been bought by a company of London merchants soon after her launch from the yard of William Denny of Dumbarton. She passed through the Forth and Clyde Canal from Bowling to Grangemouth, and reached the Thames six days after leaving the Forth. Soon after the industry received a forward impetus from the energetic genius of David Napier, already a well-known marine engineer, of Glasgow. He thoroughly grasped the possibilities of steam-navigation in connection with coasting and over-sea traffic. In 1818 he established regular steam-service between Glasgow and Belfast with the *Rob Roy*, built by William Denny, and fitted with engines of his own make. In 1819 he established the first line of steamers between Glasgow and Liverpool, and during the subsequent twenty years he engineered most of the notable steamers produced by Clyde builders. Meantime, largely owing to the success of the *Rob Roy*, steamers had begun to be built and employed in service at other ports. On the Thames steamers began to ply between London and Margate in 1815-16; and in 1817 James Watt, whose double-acting side-lever type of engine (see STEAM-ENGINE) had played such an essential part in the movement, crossed over to the Scheldt in a steamer named the *Caledonia*, afterwards ascending the Rhine to Coblenz.

Ocean voyages by steamers were at first performed by vessels in which sail almost as much as steam was the power relied on. In this way the Atlantic was crossed in 1819 by the *Savannah*, a vessel 100 feet long and of about 300 tons burden, the passage from Savannah to Liverpool occupying twenty-five days. In 1824 the steam-yacht *Falcon*,

of about 175 tons, proceeded from England to India, for the most part relying on sails. In 1825 the *Enterprise*, 122 feet length of keel by 27 feet beam, and of about 470 tons burden, made a passage from London to Calcutta in 113 days, ten of which were occupied by stoppages. The successful inauguration of transatlantic steaming is due to the *Great Western*, built for the Great Western Steamship Company by I. K. Brunel, whose bold genius controlled the affairs of the company, and gave to the maritime world several of its most notable steamships. She was 212 feet long, 35 feet 4 inches beam, 23 feet 2 inches depth of hold, and registered 1340 tons. Her engines, on the side-lever principle, were made by Messrs Maudslay, Sons, and Field of London, and were of 440 horse-power. On Sunday, April 8, 1838, the *Great Western* started from Bristol on her voyage across the Atlantic, her completion and despatch being hastened on account of the fact that, four days before, a vessel named the *Sirius* (taken from the service between London and Cork) had been despatched on the same voyage. The *Sirius* was smaller and less powerful than the *Great Western*, and both vessels arrived at New York on the same day, Monday, April 23—the *Sirius* in the morning and the *Great Western* in the afternoon—the passage thus taking eighteen days and fourteen days respectively. Their arrival was hailed with immense acclamation by a vast concourse of spectators; the event represented a triumph in steam-navigation, regarding the possibility of which much popular unbelief and some scientific doubt had been expressed, and virtually reduced the distance between the Old World and the New by about one-half.

A historical survey of the transatlantic service affords in itself a more complete and connected epitome of steamship development in all its essential aspects than any other single service that can be instanced. The reader may at the outset be referred to the profiles of typical Atlantic steamers from the *Sirius* onwards (fig 4), reproduced here through the courtesy of the proprietors of *Engineering*. The return passages of the *Great Western* and *Sirius* were even more successful than their outward, both as regards time occupied and fuel consumed, but the undertaking commercially was far from satisfactory. Other pioneer steamers followed, but, with the exception of the *Great Western*, which was kept running at a loss, they were gradually withdrawn from service. Yet in 1839 Mr Samuel Cunard (q.v.) came over to England from Halifax, determined to establish on a secure and satisfactory basis a line of transatlantic steamships. He was brought into contact with Mr George Burns of Glasgow and Mr David M'Iver of Liverpool, the necessary capital was soon raised, and the celebrated 'Cunard' Company, backed by a handsome government subsidy for prospective mail services, was the result. Their first vessels were the paddle-steamers *Britannia*, *Acadia*, *Columbia*, and *Caledonia*, all of about the same dimensions—viz. 207 feet long, 35 feet 4 inches broad, 22½ feet deep, 1154 tons burden, and 740 h.p. Their engines were of the side-lever type, by Robert Napier of Glasgow, return-flue boilers and jet-condensers being used. The *Britannia* inaugurated the mail service by sailing from Liverpool on Friday 4th July 1840, and arriving safely at Halifax after a voyage of twelve days, ten hours. Her return passage was made in ten days; and the mail service thus instituted was thenceforth carried on by these four vessels with great regularity. The average speed then attained was about 8½ knots, and in 1848, when longer and more powerful vessels were running, the average speed had been increased to 10½ knots.

Iron Ships.—The substitution of iron for wood in the construction of ships' hulls originated in barges and light craft built for canal and inland lake service, and amongst the first builders of iron boats were John Wilkinson, an iron-founder at Cartmel in North Lancashire, in 1787 or earlier; Thomas Wilson, on the Monkland Canal, Scotland, in 1818; and John Laird, founder of the Birkenhead firm in 1829. The first iron steamer was the *Aaron Manby*, built at Horsely Ironworks, Tipton, in 1820-21, and named after her designer and builder. The first iron steamer constructed on the Clyde was the *Aglais*, built in 1832; the first on the Tyne was the *Prince Albert*, built also in 1832. The distrust

and opposition which this great change met with not only from the public, but from shipowners, builders, and naval authorities, hindered its development for many years. The building of the *Great Britain* for the Atlantic service during the years 1838-44 was, therefore, a characteristically bold step on the part of Brunel and the company for whom he acted. This remarkable vessel, the marvel of her day, was in herself a striking exemplification not only of the natural evolution of the steamship as regards dimensions, but of the revolution in construction and propulsion under consideration. She was over 320 feet in length, 51 feet beam, 32½ feet deep, her hull was

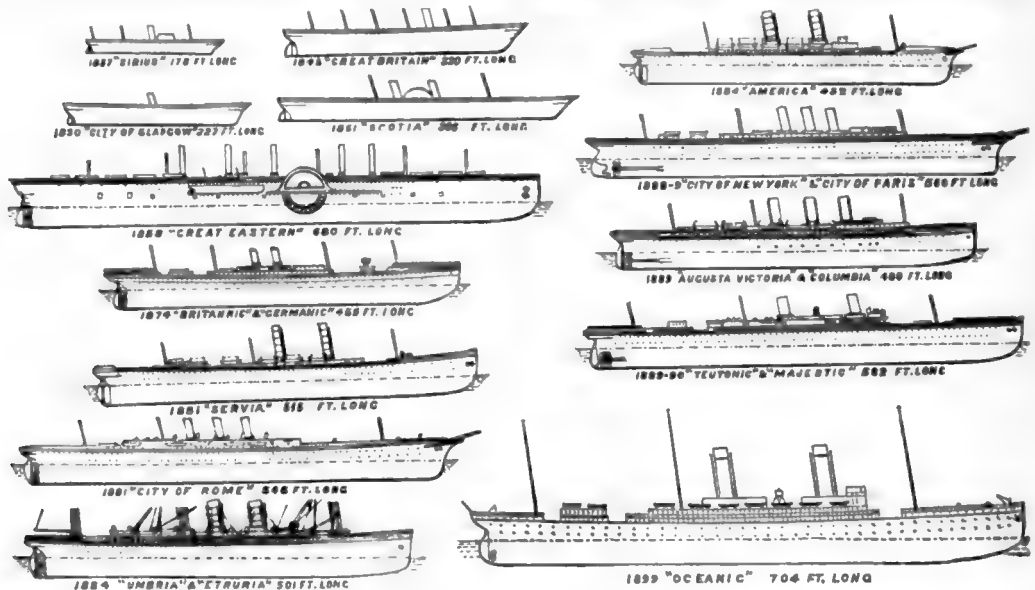

Fig. 4.—Comparative Sizes of Typical Atlantic Liners.

(From *Engineering*, 4th December 1891. The *Oceanic*, from drawing kindly furnished by Messrs Harland & Wolff.)

constructed of iron, and she was fitted with a screw-propeller. The employment of the screw in place of paddles was resolved upon in 1839 after the engines designed for paddle-wheels had been partially made, the determination having been come to after painstaking study of the screw as already applied to smaller vessels.

Screw-propellers.—The idea of employing the principle of the screw for ship-propulsion is known to have been entertained from a period at least as early as the application of steam as the motive power. Claimants for priority in this matter have been most numerous, and the subject is so beset with many intricate and conflicting contentions that it would be futile to attempt a satisfactory statement here. Amongst the first, however, to score decisive success and convince the engineering profession of the practicability of screw-propulsion were John Ericsson (q.v., 1803-89) and Sir Francis Pettit Smith (1808-74). The former with the *Francis B. Ogden* on the Thames in 1836 obtained encouraging success, and the latter with the *Archimedes*, a vessel of much larger size, in 1839 clearly demonstrated the practicability and value of screw-propulsion. The innovation in the case of the *Great Britain* was equally a success; but the great misfortune which overtook her on her fourth voyage from Liverpool to New York in stranding in Dundrum Bay, Ireland, through a misreckoning, interrupted her successful career as a steamship, although she was long afterwards employed in the Australian

service. This misfortune, however, helped incalculably to further shipbuilding in iron. The vessel, after lying aground in an awkward situation for about eleven months, was successfully floated, and was found to have sustained comparatively little damage. Many of the shipbuilders and owners who had been hesitating about the judiciousness of employing iron paid visits to the stranded vessel, inspected her after docking, and felt entirely convinced of the suitability of iron for ship-construction. Ocean-navigation by iron steamers was now placed on a thoroughly practical basis, and, although the transatlantic service continued to be conducted by wooden vessels propelled by paddle-wheels for some time longer, the superior efficiency of the screw for over-sea propulsion became more and more understood and accepted.

The advantages of the screw-propeller for ocean-steaming as compared with the cumbersome paddle-wheel are mainly as follows: As an instrument of propulsion purely, and as compared by performances in smooth water, its efficiency is not much greater than the paddle-wheel, but in virtue of its position relatively to the body propelled, and to the water through which that body passes, it is vastly more efficient than the paddle for sea-going purposes. Placed at the stern of the vessel, and fully immersed, it acts upon relatively a much larger quantity of water in a given time than the paddle. The rolling motions which so grievously affect the paddle leave the screw almost uninfluenced. If

the screw be well immersed to start with, even the pitching oscillation—i.e. the rising of the stern and dipping of the stem—does not entail any great loss of efficiency in large vessels. Again, considerable variations in a ship's draught of water may take place and yet leave the screw moderately efficient; whereas in the case of the paddle a small decrease or increase in the amount of 'dip' of the floats, whether caused by draught of water or by wave-hollows, makes a very material difference.

The virtual monopoly of the Atlantic steamship service which had existed for ten years in the hands of the Cunard Company was first seriously assailed by opposition in 1850. In that year the celebrated 'Collins' Line of paddle-steamships, four in number, American built, of superior power and speed, and backed by a substantial subsidy from the United States government, was established, and the competing Inman Line also sprang into existence. The ultimate issues were greatly in favour of the Cunard Line, the Collins opposition ceasing in 1858 after the loss of two of the vessels and the refusal of the American government of further financial aid. Misfortune and mismanagement were chiefly the causes of this failure, but probably it was also partly determined by the evident and inevitable success of screw-propulsion and iron hulls. It was with iron ships propelled by screws that the Inman Company entered on Atlantic competition. Their first vessel was the *City of Glasgow*, built by Messrs Tod & M'Gregor on the Clyde, their second being the *City of Manchester* by the same builders. Committed to a certain line of development, the Cunard Company in 1852 sent forth the *Arabia*, a wooden paddle-steamer of 2480 tons and 938 h.p. This was followed in 1855 by the *Persia*, the first iron vessel the company owned, and with which they still maintained first place as regards speed. The next addition to the fleet—referred to at the time as the 'champion and model of a mercantile ocean steamship'—was the *Scotia*, built of iron, but still with paddle-wheels as the propulsive agent. She measured 366 feet long, 47½ feet beam, 30½ feet deep, her gross tonnage being 3870. Her engines, by Napier, were 475 h.p. nominal, but she indicated at sea as much as 4200 h.p. Notwithstanding that her early performances surpassed those of any previous vessel, she was destined to be the last of the paddle-steamers built for the Atlantic by the Cunard Company. In the same year which gave her birth the government sanctioned the use of the screw-propeller in the mail-steamers of the company, and the screw-steamer *China* was at once the result. This vessel was followed during the next two years by four others, the result of whose performances finally established the fact that the screw-steamer in point of efficiency and economy, especially with the improvements which had concurrently taken place in the marine-engine, far surpassed the paddle-steamer for deep-sea traffic.

Since the triumph of metallic construction and screw-propulsion was thus assured, no further very radical change has taken place in steamships, but the agents supplying motive power have undergone many important modifications (see STEAM-ENGINE). Development in size and power proceeded more swiftly than ever, and steam-navigation grew and flourished amazingly. Additional companies were formed, and new steamships produced with rapidity not only for the Atlantic traffic, but for services having the widest ramifications. The year 1858 witnessed the completion of the *Great Eastern* (q.v.)—Brunel's and Scott Russell's stupendous creation—and also saw the modest beginning of the now great fleet of the North German Lloyd; and 1861 saw the start of the French

Compagnie Transatlantique. The first mercantile steamship company to develop the trade of England with her Indian possessions by way of the Isthmus of Suez was the Peninsular Company, afterwards developed into the more renowned Peninsular and Oriental Company, their first services dating from 1837. The Pacific Steam-navigation Company was established in 1847, and it was in vessels built for it in 1856, engined by John Elder, that the compound principle, destined to prepare the way for the marvellous improvement which has since been gradually effected in the marine steam-engine, received its first satisfactory credentials. The subsequent general adoption of the surface-condenser and the circular multitubular boiler enabled higher pressures of steam to be safely carried and economically produced and used. The employment of steamers on the longest of voyages and at high rates of speed was fairly established about 1877; the Orient Steam-navigation Company then instituted a fortnightly service to Australia, and in 1879 added the *Orient*, and in 1882 the *Austral*, to their fleet, both from the stocks of the Fairfield Company, Glasgow. The *Orient* on trial attained 17 knots, and afterwards made the passage from Plymouth to Adelaide *via* Suez Canal in 35 days 16 hours, and the same voyage *via* the Cape in 34 days 1 hour, steaming time. It was in a steamer specially built for the Australian service in 1881 by Messrs Napier & Sons—the *Aberdeen*, for Messrs G. Thomson & Co., Aberdeen and London—that the merits of the triple-expansion type of engine, now so universally approved, were first decisively shown, the machinery of this vessel being from the designs of Mr A. C. Kirk, of Messrs Napier. The engines of the *Aberdeen* work with steam having a boiler pressure of 125 lb. per square inch, and expansion takes place in three cylinders. On her first voyage from Plymouth to Melbourne, which occupied 42 days, her average i. h. p. was about 1800 and consumpt of fuel less than 34 tons per day, or at the rate of 1.69 lb. per i. h. p. per hour. In 1883 the New Zealand Shipping Company instituted direct steamship service to New Zealand, and steamers of their fleet, together with those of another company, are now making regular passages averaging from 37 to 40 days. In vessels employed in this service a further extension of the principle of higher pressures and increased measure of expansion—quadruple—has been carried out, with corresponding economic results.

With the year 1874, which saw the production of the *Britannic* and *Germanic*, of the White Star fleet, by Messrs Harland and Wolff, Belfast—each a considerable advance on anything then existing—began what has since proved a practically unbroken and hotly sustained contest for the leading place in the race across the Atlantic. Steamship after steamship has proved more or less an advance on its predecessor in respect of length of keel, splendour of appointment, stupendousness of propulsive power, and consequent shortening of the passage time. Events have been marvellously crowded into a comparatively short period, but, perfection having been so nearly approached, advancement in each case is now less conspicuous than formerly for outstanding improvements in either the shape of the hull or the essential character of the propulsive agents. Each increase in the speed of the present-day high-speed Atlantic steamer represents the resultant of innumerable modifications—some minor, others radical—which engineering experience and skill and the constant improvement in contributory branches of art and manufacture suggest and render possible. For these reasons, and in view of the table on page 406 of speed, dimensions, &c. of Atlantic steamers from the *Britannic* onwards, the references to individual competitors in the race

will only be of the nature of a catalogue. For a time the White Star liners maintained first place in the matter of speed, being exceeded, however, as respects dimensions and tonnage by the *City of Berlin* of the Inman Line, produced in the same year, and for a time the longest vessel afloat next to the *Great Eastern*. Roundly stated, the *Britannic* reduced the passage to and from Queenstown and New York to 8½ days. In 1879 two fresh competitors were in the field, the *Arizona* of the Guion Line, built by the Fairfield Company, and the *Gallia* of the Cunard Company, built by J. and G. Thomson, Clydebank. During 1880-81 the Cunard Company added the *Servia* to their fleet, from the stocks of Messrs J. and G. Thomson; the Inman Company added the *City of Rome* (subsequently transferred to the Anchor Line fleet), from the stocks of the Barrow Company; and the Guion Company the *Alaska*, from the Fairfield yard. After them came the *Oregon* (Fairfield), for the Guion Line, in 1883; the *Aurania* (Clydebank), for the Cunard Company, in the same year; the *America* (Clydebank), for the National Line, in 1884; and the *Umbria* (Fairfield) and *Etruria* (Fairfield), for the Cunard Company, in 1885. The average time between Sandy Hook and Queens-town during 1886 was about 6 days 15 hours as compared with 11 days 19 hours in 1856. A table of speeds and dimensions of representative Atlantic steamers is appended.

Name.	Dimensions: Length, Breadth, Depth.		Gross Tonnage.	Ind. Horse- power.	Trial Speed.	Quickest Passage (Eastward).
	Feet.					
Britannic	455	46	34	5,004	5,500	Knots. D. H. M.
Arizona	450	45	37½	5,147	6,300	16
Servia	515	52	40½	7,392	10,300	17
Alaska	500	50	39½	6,932	10,500	16-9
City of Rome . . .	546	52	38½	8,141	11,890	18
Oregon	500	54	39½	7,375	7,375	18-23
America	432	51	37½	6,500	7,354	18
Umbria	501½	57½	38½	7,718	14,321	17-8
Etruria	501½	57½	38½	7,718	14,320	19
City of Paris . . .	560	63	43	10,499	20,605	19-2
Augusta Victoria .	480	56	38	7,661	14,110	21-8
Columbia	480	56	38	7,578	13,680	18-31
Teutonic	582	57½	39½	9,686	18,000	19-15
Normannia	520	57½	38	8,716	16,352	20
Fürst Bismarck . .	502½	57½	38	8,000	16,412	19-34
Campania	600	66	41½	12,950	30,000	20-7
						23

Twin-screw Steamers.—In 1888-89 four still larger and more powerful steamships were afloat—these were the *City of New York*, *City of Paris*, *Majestic*, and *Teutonic*—inaugurators of the twin-screw epoch of Atlantic navigation. Of the same class were the twin-screw vessels built and owned by German and French firms, the *Normannia*, *Augusta Victoria*, and *Fürst Bismarck* of the Hamburg American Line, *La Touraine* of the Compagnie Transatlantique. The next triumph was the construction at Fairfield for the Cunard Company of the *Campania* and *Lucania*, two powerful twin-screw vessels, which began to ply in 1893. In January 1899 was launched at Belfast by Messrs Harland & Wolff the White Star liner *Oceanic*, the biggest ship ever built; length (over all) 704 ft., breadth 68 ft., depth 49 ft., with a displacement of 28,500 tons.

Twin-screws have been employed in steamers for particular services for many years, notably in those for coasting and cross-channel work, where depth of water is restricted, and in vessels of the navy, where manœuvring facility was and is a desideratum. The comparative efficiency of single-screw and twin-screw steamers is still the subject of debate by naval architects, but the conditions under which the evolution of the Atlantic 'express' steamship must proceed make it imperative that twin-screws should form the agents of propulsion. In vessels having engines which develop i.h.p. ranging from 13,000 to 20,000 it has been

recognised as unadvisable to transmit the total power through one line of shafting. The risks run through mishaps to the shafting or propellers of single-screw steamers receive only too frequent illustration, and the concurrent decrease in sail-power makes the consequences greatly more serious. With twin-screws, each driven by a separate set of engines and shafting, ships can, in the event of a break-down to one set of machinery, still pursue their voyage by means of the other set. The twin-screws can also be used to assist the steering in case of emergency. The duplication of the engines also permits of a complete central water-tight bulkhead, greatly increasing the chance of safety in case of collision.

Turbines.—The latest development in propellers consists of engines on the turbine principle (see WATER-POWER), steam being the motive-power and acting directly on turbines enclosed in tubes. The screw shaft, again, is acted on directly by the turbines, which weigh about one-fifth of an ordinary steam-engine. The *Turbinia* torpedo-boat, with three such turbines, made 42½ miles per hour at Spithead during the review in 1897.

Water-tight Subdivision.—Subdivision of the hull by strong water-tight Bulkheads (q.v.) has undoubtedly become the essential factor in the safeguarding of steamships against foundering through collision or grounding on rocks. In the event of the shell being penetrated and an inrush of

water taking place, the inflow is confined to the space between two bulkheads, and there is reserve of buoyancy enough in the remaining compartments to keep the vessel afloat. Many of the high-class mail and passenger ships on the Atlantic and elsewhere are so minutely subdivided that even in the contingency of any two compartments being laid open to the sea—as in the case of the shell being penetrated precisely in the line of a dividing bulkhead—the vessel would not sink. In the case of purely cargo-carrying vessels the commercial and other conditions imposed are such as restrict the degree and nature of subdivision, but even in vessels of this

class the system is being more and more developed. These very conditions, curiously enough, encourage, nay demand, the extended application of the principle of subdivision in another part of the hull structure of cargo-carrying vessels, sailing as well as steam—viz. throughout the bottom. The carrying of water-ballast (see BALLAST) has for very many years been imposed on vessels compelled by the exigencies of service to proceed light or partially loaded, and this same need, associating itself with the structural requirements arising from the growth in ships' dimensions, has resulted in the general adoption of water-ballast bottoms on the subdivisional or 'cellular' principle. This modification in the internal features of a ship's structure dates from before the time of the *Great Eastern*, in which, as well as in previous smaller ships built by Scott Russell, the cellular system received thorough illustration, although not associated with water-ballast. That it contributes immensely to the security of a vessel in the event of its grounding on rocks or other sunken obstacles is of course easy to understand. Not only is the length of the ship subdivided by transverse bulkheads as already explained, but the top of the cellular bottom or 'inner shell' is in all vital respects as water-tight, though necessarily not so thick, as the outer skin of the ship. We are enabled through the courtesy of Messrs William Denny and Bros., shipbuilders, Dumbarton—a firm

who have done more than any other to popularise and improve the cellular system—to reproduce a midship section of the South African mail steamship *Scot* (fig. 5), in which the necessary longitudinal strength in the way of girders and inner plating is happily associated with the transverse deep-floor principle, and the whole utilised for the accommodation and manipulation of water-ballast.

Mild Steel, first used as the building material in France, attracted the attention of the British naval authorities, and about 1875-76 they ordered from home manufacturers the steel requisite for the construction of the cruisers *Iris* and *Mercury*. In 1879 the Allan Line entrusted to Messrs William Denny Brothers the building of the *Buenos Ayrean*, the largest vessel of the Allan Line fleet up to that time, the hull of which was of steel bound with steel rivets. Almost from the first, mild steel found favour with the shipyard workers as being a material capable of much easier manipulation than iron, but its high cost and the exacting test conditions imposed by Lloyd's Registry restricted its use for some years. Improvements in manufacture and enlarged facilities for production, however, gradually cheapened its cost, and enabled Lloyd's to relax their surveillance. Among the advantages of the new material are its great lightness—strength for strength—compared with iron, and its effecting economy in labour and material through lending itself more than iron to being worked while in the cold state; to being readily and safely flanged along the edges, thus dispensing with angle-bars; and to being supplied in plates of greatly increased size. As regards weight-saving, while the change from wood to iron effected a saving of from 30 to 40 per cent. on the weight of ships' hulls, the employment of steel effected a further economy in weight of almost 15 per cent. Roughly, therefore, the steel ship of to-day is 50 per cent. lighter than a wooden ship of former times of similar dimensions and tonnage. Finally the greater safety of steel ships, or the diminished risk of heavy damage requiring repair, in the event of their getting aground, has commended steel to shipowners and marine insurance societies. Through the superior malleability and ductility of the material, steel ships have again and again come comparatively scatheless out of ordeals which would have proved fatal to ships built of iron. At the present time quite 90 per cent. of the shipping produced in Britain consists of steel-built vessels (see table, page 411).

Composite Ships.—The only serious disadvantage attaching to steel ships is one common to them with iron ships—fouling and corrosion in actual service. The attachment and growth of marine plants and animals, which takes place more or less rapidly on iron ships in all waters, and especially in warm or tropical seas, has all along been the serious bugbear of the navigator and the shipowner. Cases are on record where a few months in tropical waters have sufficed to produce such an amount of fouling

as to reduce the speed of the ship very considerably. The anti-fouling properties of copper-sheathing—which from a very early date formed an essential item in the proper fitment of a wooden vessel for sea—were so well understood that for long after iron had supplanted wood the 'composite' system of construction was followed. Ships built on this system resemble iron ships in all respects, except

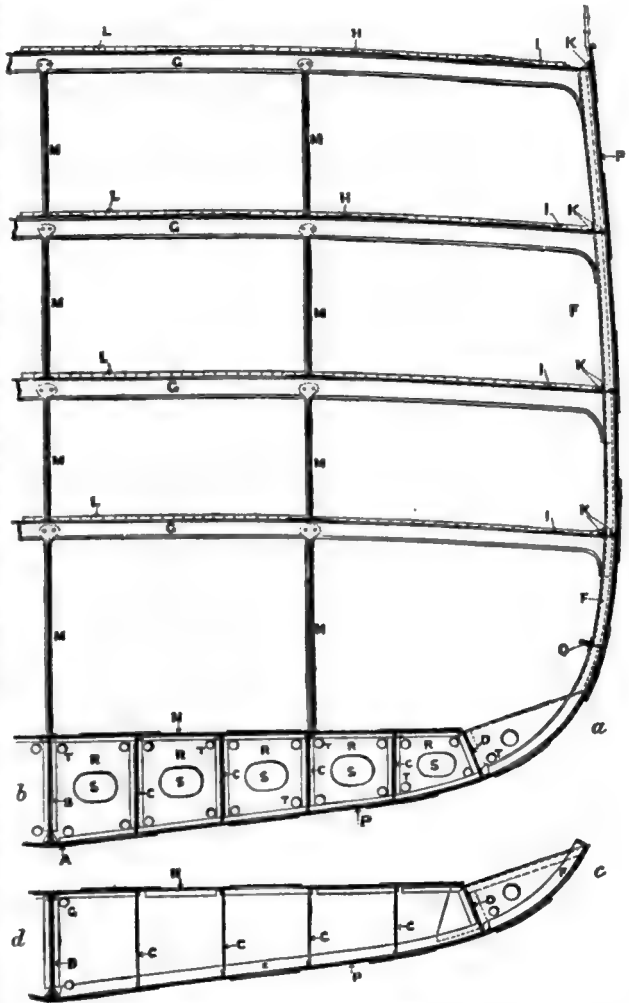

Fig. 5.—Midship Section of *ss. Scot*, illustrating the Cellular Bottom System of Construction :

a, b, arrangement on every frame under engines, and on alternate frames elsewhere; c, d, alternate frames in holds.
A, keel-plate; B, centre longitudinal; C, side longitudinal (analogous to keelsons in vessels with ordinary bottoms); D, wing-plate; E, bottom frame; F, side frame (reverse frame dotted); G, deck-beams; H, deck-plating; I, deck-stringers; K, stringer-angles; L, deck-planking; M, hold stanchions; N, tank top or inner bottom-plating; O, bilge keelson; P, shell-plating; R, deep-floor plates (analogous to solid floors in vessels with ordinary bottoms); S, man-holes; T, air and limber holes.

that they have wood-planking, keels, stems, and stern-posts; the wood-planking enabling their bottoms to be sheathed with copper. The composite system of construction found special favour in connection with ships of war and with mercantile ships for particular services, intended to keep the sea for long periods and to maintain their speed. The China clippers formerly employed in the tea

trade, whose annual races home excited so much interest, were built on this system; and in the royal navy the composite system still obtains for smaller-sized vessels, and even for the larger and swifter iron and steel cruisers having an inner metallic skin. Amongst the innumerable attempts to remedy the fouling of iron ships some have been directed towards attaching protective sheathing—copper or zinc—indirectly or directly to the iron shell, but commercial and practical difficulties have defeated these efforts; and in spite of countless specifics proposed, it would seem as if frequent docking and careful coating of the hull with the most approved paints and compositions were the best protection.

The Art of Shipbuilding.—The employment of iron for constructional purposes and the simultaneous extension of the use of machinery revolutionised the art of shipbuilding. The manipulation of this malleable material and of its still more ductile successor, mild steel—especially with the aid of steam machinery—is simplicity itself compared with the elaborate hewing and fashioning of timber requisite in wood shipbuilding. Take, for example, one of the more important parts of a ship's structure, the rib or frame. In a wooden vessel it is a matter of careful and skilful workmanship to saw or hew from the rough logs approximately curved timbers, many of which have to be combined to form a single rib. In an iron ship, on the other hand, the angle-bars used for frames are simply heated in a furnace and then bent to the required curve, each frame in its complete form consisting of the simplest possible combination of angle-bars and a plate or plates for the floor. The iron-manufacturer anticipates the wants of the iron-shipbuilder, and supplies the material approximately of the very forms and dimensions in which it enters into the structure, thus diminishing the work of trimming and preparation to a minimum. Machinery too has discounted and displaced handicraft skill in the iron shipbuilding yard. Iron plates and bars are punched, sheared, drilled, planed, and bent by simple and suitable machines managed by comparatively unskilled hands. One or two skilled workmen, assisted by several unskilled labourers, can rapidly perform in iron operations corresponding to those which in wood would necessitate the handicraft skill and prolonged efforts of many trained shipwrights. Division of labour also enters into the economy of iron shipbuilding to a much greater extent than in wood shipbuilding. The shipwright, as his name implies, really builds the ship, other tradesmen merely aiding in the fittings and equipments; whereas in the case of iron shipbuilding there is no correspondingly prominent artificer of the 'all round' type, the work being apportioned among machine-aided ironworkers, joiners, and carpenters. Shipbuilding may, in these respects, be said to have lost dignity as an art. It is otherwise, however, when we regard iron shipbuilding as an industry and the modern steamship as a product of science. The rate of production is accelerated tenfold compared with what it was even in the palmiest days of wood shipbuilding; and in point of size and perfection of equipment the magnificent mail-steamer and ponderous ironclads produced almost daily from the yards of our busiest shipbuilding centres dwarf almost into insignificance the achievements of former times.

The undertaking of a new vessel in modern times originates as a general rule with the shipowner; and from his experience as to the needs of the case he submits to the professional marine architect (as distinct from the shipbuilder; in business for himself, or sometimes the exclusive servant of the

shipowner) the main regulating conditions of design—e.g. the principal dimensions, the structural type, the cargo to be carried, or the speed to be attained on a given draught of water. From these and other fundamental data the architect is enabled to prepare a suitable design and a detailed specification, which the owner can lay before one or more builders and obtain prices. Even where this is the procedure adopted and a given builder has been fixed upon, there always remains a goodly amount of designing work to be done in connection with details and with the preparation of 'working-drawings' to guide the workmen in the shipyard. This necessity has existed so long, and building firms have evinced such readiness to requisition their staff of draughtsmen on behalf of owners desirous of building, that at the present day quite three-fourths of the necessary designing is willingly undertaken by shipbuilding firms who see some chance of their securing the order to build. We may follow the development of a typical modern vessel from the time she is ordered until she is 'handed over' complete to her owners, on the supposition that the whole of the work connected with her is undertaken by one firm of builders, who are also marine-engineers. The first step is the preparation of 'constructional' or 'draught' plans, showing by a series of curved and straight lines the contour of the ship's hull, on three distinct planes, represented by (1) the 'sheer-plan' or longitudinal elevation, showing the lines of length and height from stem to stern; (2) the 'half-breadth plan,' showing the lines of length and breadth, or, in other words, those lines corresponding to the margin of the Decks (q.v.) as they would present themselves to an observer looking down on the skeleton of the vessel from an elevation; (3) the 'body-plan,' which shows all lines of breadth and height visible to one looking at the framework of the vessel 'end on.'

Following upon the design of the hull form or even preceding it is the preparation of a 'midship-section' showing the transverse contour of the vessel amidships, and the thickness of the various parts which go towards constituting the structure (see specimen midship section shown by fig. 5). If the vessel is to be 'classed at Lloyd's'—as the majority of vessels at the present day are—in order to facilitate its insurance by the underwriters, this 'midship' or 'scantling section' is despatched to Lloyd's Registry of Shipping, with the scantlings approved for the particular class—'100 A,' '90 A,' &c.—which the owners or builders may desire. The practice of classing at Lloyd's (q.v.) is most advantageous in several ways. Not only does it serve the owner as a 'patent royal' in all subsequent negotiations connected with insuring the vessel and her cargo, but incidentally it relieves the designer and builder of a great amount of calculation and concern connected with fixing the requisite size and proper grouping of the parts constituting the structure. Elaborate codes of rules have been formulated, and are issued annually by Lloyd's (see LLOYD'S).

When once the hull form is delineated on paper, a wood model or small-scale duplicate of the hull is prepared, which, besides showing more clearly to the eye the exterior form of the ship, is available for various constructional purposes. On its surface are marked vertical lines from keel to gunwale, representing the frames at equal distances apart (21 inches in small vessels to 24 and 26 inches in large) from the stern-post to the stem. Across these, and in a longitudinal direction from stern to stem, lines are drawn representing the edges of shell-plating, which is arranged in 'strakes' analogous to the planking in a wood ship, each strake being divided throughout by 'butts' into

uniform lengths of plates. The surface of the model is also marked with lines representing the decks, the transverse bulkheads, the side-ports, &c. From the model as thus prepared, and from various plans, such as deck, bulkhead, keelson, and floor plans, the draughtsman measures and orders from the makers the angle-bars, bulb-bars, plates, and butt straps. Meanwhile the vessel's lines, as delineated on paper, have been 'laid off' on the mould-loft floor full size, in which process inaccuracies due to the small-scale drawing are eliminated. From the mould-loft lines, when accurately 'faired,' moulds and templates of the several parts of the ship structure are prepared for the guidance of the workmen in the shipyard. The most important item thus prepared is the 'scribe-board,' an immense piece of flooring on which the 'body-plan' or frame curves and other features are delineated full size by sharp lines cut or 'scribed' in the smooth surface. This flooring is placed convenient to the angle-bar furnace and the contiguous 'bending-blocks,' massive iron slabs which form the solid flooring on which the frames, &c. are bent. On this floor the form of the frame is marked from the scribe-boards. All over the floor are round holes, closely spaced and equidistant, into which—or those of them which fall within the line of the frame curvature—upright pins are placed with their upper ends projecting. Long angle-bars (*a*, fig. 6) of iron or steel properly heated are now drawn from the furnaces, and speedily bent round the pins to the form required, by special hand appliances. Each separate half-frame of a ship is thus fashioned to the proper curve in little more time than it takes to describe the process. It is now allowed to cool, and it is then returned to the scribe-board to be set or adjusted with 'reverse frame,' which with the 'floor' plates go to make the ship's frame in its complete form. The three items tentatively bolted together are now taken to the building-berth, and there riveted together by hand or by hydraulic power machines, the holes for the rivets having been punched by the punching-machine partly before and partly after bending. While this has been going on, the keel has been laid on the blocks—heavy masses of wood, usually 4 to 6



Fig. 6.

feet apart and 3 to 4 feet high, their tops lying in a plane inclined to the horizon about $\frac{1}{4}$ inch per foot. The frames as completed are hoisted up in their places, and kept in position by shores and ribbon-pieces. The stem and stern-posts are set up, and soon the work becomes general all over the vessel. The deck-beams—usually of the forms shown

in *b* and *c*, fig. 6—are put up, the bulkheads, stringer-plates, and keelsons are added in due succession, and the outside shell-plates are curved, punched, fitted, and temporarily fastened with bolts and nuts ready for the busy hammers of the riveters. In vessels built on the cellular double-bottom principle the order of procedure is different from the above, especially in the earlier stages. The frames in this case are in three and sometimes four sectional parts. One part (when three parts are employed) forms the bottom of the vessel, and extends across and through the centre longitudinal (*B*, fig. 5), terminating against wing-plate *D* at each bilge. When four parts are used, one begins on each side the centre longitudinal *B*, to which it is securely attached, and ends against the wing-plate *D* on each bilge. The remaining two parts form both sides of the vessel,

and are superimposed upon the wing-plate, and firmly bracketed to it. In construction therefore the centre longitudinal and keel are first erected, the bottom sections of the frame fixed in place, and the whole system of longitudinal and deep-floor plates completed before the side portions of the frames are erected. In other respects the procedure does not materially differ from that above outlined.

All the iron work entering into the structure is fastened together by rivets. Holes are first punched or drilled in the plates and angle-irons, in most cases before they are put together.

The holes having been made exactly to fit over each other, a red-hot rivet is received from the boy rivet-heater, and inserted through them, as in *b*, fig. 7. A workman called the 'holder-up' holds the head of the rivet forcibly in place with a heavy iron tool, while two riveters on the other side of

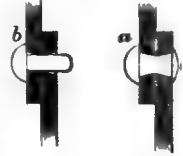

Fig. 7.

the plate strike its point rapidly with their hammers until hammered down flush with the plating or as shown at *a*. The contraction of the rivet in cooling causes it to draw, and hold the two plates still more tightly together.

Steamships are divided throughout their length into compartments by transverse bulkheads. These partitions, like the outside shell of the vessel, are made water-tight by 'caulking'—i.e. forcing by means of blows from a hammer on a chisel-like tool the edge of one thickness of plating against the surface of the other. With the completion of the riveting and caulking of the shell and the concurrent advance of other features the vessel is ready for launching. Preparations for this highly important and critical part of the work have been proceeding simultaneously with the finishing touches to the shell. Launching 'ways' of heavy timber have been laid down parallel to the keel and at some little distance on each side of it under the bilges of the vessel, and extending into the water some distance beyond and below high-water mark. A 'cradle' is then built under the ship, the bottom of which is formed of smooth timbers, or 'sliding ways,' resting upon the 'permanent ways.' Before launching, the rubbing faces of both of the ways are well greased, and gradually the weight of the ship is transferred from the 'keel-blocks' and bilge-blocks to the cradle and ways. By a locking arrangement of the two ways the tendency of the ship and cradle to glide down the lubricated pathway is resisted until the proper moment. When this arrives (at high-water usually) the ceremony of naming the vessel takes place, the locking arrangement or 'dog-shore' is knocked away, and the vessel glides down the appointed pathway with gradually increasing velocity until checked by the resistance of the water or 'brought' to by check-ropes and weights on shore. As soon as the vessel is 'water-borne' the weight is taken from the cradle, and it floats apart in pieces, which are afterwards towed back to the shipyard.

Although the vessel is now afloat, much probably remains to be done. Frequently the greater part of the deck-planking has to be laid and caulked, and the whole of the cabin appointments, previously prepared in the joiner's shop, to be fitted up; the wood ceiling which lines the cargo-holds has to be laid, the masts have to be put on board and erected, together with the spars, sails, and rigging. In the case of a steam-vessel the propelling machinery—engines, boilers, shafting, &c.—and the various items of deck machinery—windlass, winches, steering-gear, &c., have all to be placed and properly secured on the seatings pro-

vided for them. The main engines and boilers have of course been under construction almost since the date of the order, and with their erection and fitting in the interior of the vessel, the responsibility devolving on the engineering department is more accentuated. All is at last complete: the multifarious deck-fittings, the furnishing of the saloons and state-rooms, the fitting of the electric light probably, the completion of the network of piping, the fitting of the steering gear, the placing of the compasses, and the thousand-and-one other items which go towards the thorough equipment of the vessel for sea. When at last the steamer glides out of the dock of her builders and proceeds on her trial trip, and to adjust compasses, there ensues what is not infrequently a most anxious period for the builders and engineers. In vessels where high speed, together perhaps with carrying capability on a given draught of water, is the regulating condition of design, the stipulations as to speed trials are often most exacting. The 'measured mile'—i.e. the nautical mile of 6280 feet determined by fixed marks on a straight length of coast-line—is usually the means by which a vessel's speed capabilities are ascertained; but in addition to running the mile most of the higher class steamers have to undergo tests of steaming continuously over long distances. Two, four, and sometimes more separate runs are made over the mile, half the number with and half against the tide, the object being to eliminate the tide's influence from the results. The mean time taken to each double run enables the builder to compute the rate of speed per hour of which the vessel is capable.

Scientific Qualities of Modern Steamships.—Speed, power, and dimensions almost of necessity imply stability, strength, and safety, and these several qualities are duly balanced in the magnificent ships traversing the Atlantic and other important oceans; while in the paddle and screw steamers employed in various other kinds of service—such as river, lake, and cross-channel passenger work—practical skill and scientific knowledge are equally exemplified. In the case of purely cargo and freight-carrying vessels, while fundamentally the same order of conditions obtains, there are other influences and restrictions, due to the exigencies of commerce and of economic service, which interfere with the balance of qualities. Speed, for instance, may be subordinate to economic consumption of coal; stability may be regulated less by the ship's form and weight-distribution in the hull structure than by the amount and distribution of cargo when the ship is fully loaded; and safety or immunity from risk may be subordinated to convenience of working. The functions of the present-day designer of steamships are concerned not so much with attaining great success in any one direction at any cost as with fulfilling various and conflicting conditions of service at moderate outlay.

The attention of the shipping world has frequently been called to novelties and so-called 'new departures' in ship design and construction, but commercial prudence and industrial caution have hitherto kept their balance, and the ultimate effect of most of these 'flashes in the pan' has been to illumine and make clear the safest line of advancement. The employment of electrical energy for propulsive power—which has already met with considerable success in small craft, and for very short runs—naturally leads to speculation on the possibility of its being introduced into ocean-going vessels. In the midst of such immense and marvellous works achieved by this great force one might be excused for such speculations as to the 'ship of the future,' but we have the authority of *Engineering* (December 4, 1891) for saying that no one of the builders of the present-day Atlantic

steamers entertains any belief in the probability of electricity, or indeed any other motive power, superseding steam in ship-propulsion.

Ship-producing Countries and Districts.—With the change from wood to iron, and the development of propulsion by steam instead of sails—in both of which the United Kingdom took the initiative and has maintained the lead—the iron shipbuilding industry not only chose to flourish in the country which originated it, but became localised and concentrated in the districts which, besides possessing the *sine qua non* of ready outlet to the vast ocean, are specially favoured as being the repositories of great natural wealth in the form of coal and ores. In this way the valleys of the Clyde, Tyne, Wear, and Tees have become the great centres of shipbuilding, as have also the Thames and Mersey, although the two latter rivers have for a considerable number of years been overshadowed as building centres by the immensity of their shipping. Belfast and Barrow-on-Furness are important ship-building centres, not alone because of large annual output of tonnage, but by reason of the number of high-class ocean steamships built there. America apart, Britain has practically done the world's shipbuilding for many years, and even now, when in America and Europe iron shipbuilding is being steadily developed and encouraged by government subsidies and otherwise, British shipbuilders are still being requisitioned by foreign shipowners. During 1891, for example, vessels possessing a total tonnage of 16,000 tons were constructed in Great Britain for German account, the tonnage built in Germany itself being 28,000 tons. Notwithstanding this dependence on foreign shipbuilders, Germany is the European country which, after Great Britain, with its colossal yearly tonnage of about 800,000, turns out the largest number of new ships year by year; Norway, at one time mistress of the seas, occupying third place. France, Italy, and America, which are endowed with a wealth of shipbuilding timber, are coming rapidly to the front with iron ships, and largely depend on home production.

In the United States shipbuilding began with fishing-boats, smaller and larger: the first ship built was the *Virginia*, 60 feet long, at the mouth of the Kennebec River in 1607. In 1640 a vessel of 300 tons was built at Salem; and soon shipbuilding was a prosperous industry in several New England ports. In 1700 New York owned 124 vessels and Boston 194, some of 300 tons. The revolutionary war was fatal to the industry; but from 1812 to 1850 wooden shipbuilding prospered exceedingly, and the American sailing-vessel reached perfection. The first China clipper was built by Webb at New York in 1841; the first three-decker by the same builder in 1849. The building of whalers, once a great New England occupation, is almost extinct. The share of the United States in the introduction of steam-power has been already recorded, as also the rivalry between the Collins Line and the British Atlantic lines. In 1847 congress subsidised mail-steamers from New York to Chagres, and from Panama to San Francisco. The Pacific Mail has sent steamers to the Sandwich Islands, Japan, China, and Australia. In 1830–61 New York, Philadelphia, Boston, and Baltimore built eighty sea-going steamers with an aggregate tonnage of 120,000 tons. America is specially famous for her river and lake steamers, the first stern-wheel paddle-boat being built by Fulton and Livingston at Pittsburgh in 1811. The first great lake steamer was built at Sackett's Harbor in 1816; and the first iron boat was built in Pennsylvania for service on the Susquehanna. New York soon took the lead in this branch, and in 1836 produced a vessel of 600 tons. Webb was the great builder of wooden

ships, as afterwards of iron ones; Cramp of Philadelphia and Roach of Chester became famous for their iron and steel ships. At the outbreak of the civil war, which ruined both shipbuilding and carrying trades, Philadelphia had pushed ahead of New York; and the Delaware has been called the Clyde of America, Wilmington and Chester being also shipbuilding centres. Baltimore and San Francisco build iron steamers; and there are shipbuilding yards at Pittsburgh, St Louis, Buffalo, Cleveland, and many other places.

In 1890 the United States had shipping to the amount of 928,062 tons in the foreign trade, and in coasting, &c., 3,409,345 tons. The 15,164 sailing-vessels had a tonnage of 2,109,413 tons; the 5965 steamers, 1,859,089 tons; and with barge and canal boats, there was a grand total of 23,467 vessels of 4,424,497 tons. In the year 1889-90, 505 sailing-vessels of 102,873 tons were built; 410 steamers of 159,046 tons; 40 canal boats of 4346 tons; and 96 barges of 27,858 tons. Of the world's total—22,939,958 tons—of shipping above 100 tons register, 11,928,624 tons belonged to Britain. Figures as to the shipping and trade of the most important countries are given in the articles on those countries. In 1890 the total tonnage of vessels built in the United Kingdom was 1,197,235; in the United States, 148,178; in Germany, 102,465; in the British colonies, 44,540; in France, 34,562; in Norway, 27,153; in Holland, 26,133. The table appended, from Lloyd's Register, shows the tonnage building in the United Kingdom in 1875 and 1891.

1875.				1891.				
VESSELS BUILDING AT SEPTEMBER 30.				VESSELS BUILDING AT SEPTEMBER 30.				
Steam.		Sail.		Steam.		Sail.		
No.	Tons gross.	No.	Tons gross.	No.	Tons gross.	No.	Tons gross.	
Steel...	249	508,015	100	179,886	
Iron...	126	157,466	114	106,521	82	13,132		
Wood...	6	1,065	208	51,122	3	160		
Total...	132	158,531	317	157,643	334	516,307	141	185,807

In 1898 the tonnage of merchant-vessels built in the United Kingdom was 1,367,570, and of war-ships 191,555; total, 1,559,125 tons. Steel has now all but supplanted iron for shipbuilding purposes. Up to 1870 sailers were always most numerous; in 1872 the steamers built had eight times the tonnage of the sailers; in 1885 they were on a level again; and in 1892 sailers had only 32 per cent., and in 1894 10 per cent.; in 1896 steam to sailing tonnage built was as twenty-four to one.

See also the articles on Boat, Bottomry, Brig, Brigantine, Caulking, Crew, Cunard, Decks, Dock, Dockyards, Galley, Great Circle Sailing, Insurance, Lighthouse, Log, Navy, the P. & O. Company, Plimsoll, Privateering, Rule of the Road, Sails, Schooner, Signalling, Slip, Steering, Timber, Tonnage, Wrecks, Yacht, &c. On the general subject of ships and steam-navigation, see *Lindsay's History of Merchant Shipping and Ancient Commerce* (1883); *Ocean Steamships*, by Commander Chadwick and others (Murray, 1891). On the art and science of shipbuilding, see Scott Russell's *Modern System of Naval Architecture* (1860); Rankine's *Shipbuilding, Theoretical and Practical* (1866); *Reed's Shipbuilding in Iron and Steel*; White's *Manual of Naval Architecture*; Thearle's *Naval Architecture, Practical and Theoretical*; Reed's *Stability of Ships*; Barnaby's *Marine Propellers*; Meade, *Naval Construction* (Phila. 1869); Griffiths, *The Progressive Shipbuilder* (New York, 1875); Varney, *The Shipbuilder's Manual* (New York, 1878); Henry Hall, *The Shipbuilding Industry of the United States*; the present writer's *Modern Shipbuilding and the Men engaged in it* (1885); A. J. Maginnis, *The Atlantic Ferry* (1892); Cecil Torr, *Ancient Ships* (1894); also the *Transactions of the Institute of Naval Architects* and other technical societies.

Shipka, a pass in the Balkans, on the side next Roumelia, 50 miles NE. of Philippopolis and 87 miles SW. of Rustchuk on the Danube, was stoutly held by the Russians, in an entrenched camp, against the desperate assaults of Suleyman Pasha (21st to 26th August and 9th to 17th September) in the war of 1877.

Ship-money, an impost levied by Charles I. in 1634-37, which led to fierce opposition on the part of Hampden and the parliament. In old English days royal navies were raised by the levying of ships; and under the early Norman kings the ports and the counties on the coast were called on from time to time to provide ships and men to strengthen a naval force paid for by the kings. In 1628 Charles's expedition to Cadiz was largely made up of merchant-ships pressed into the royal service; but it was in 1634, when the Dutch and French navies were well able to dispute England's sovereignty of the sea, that Charles set himself seriously to the work of greatly strengthening the English navy. By the advice of Noy, the attorney-general, he issued writs to the port towns to furnish ships, but agreeing to provide the ships if the towns would equip and man them. In 1635 he demanded the like from maritime and inland counties also; agreeing as before to find the ships if money for manning and equipment were provided by the counties. Thus a strong fleet was raised and manned with money which was not sanctioned by any parliamentary grant; and much grumbling was the result. In 1637 Charles consulted the

judges, and ten out of twelve declared that the king had a right to do what was necessary for the defence of the kingdom in times of danger. It was agreed that no tax could be levied without parliamentary sanction; but Charles maintained that ship-money was not a tax, but money paid in lieu of the performance of the duty incumbent on all Englishmen of defending their country. John Hampden refused to pay the 20s. levied on his estate in Buckinghamshire, and his case was dealt with by the Exchequer Chamber (for the issue, see HAMPDEN). The Long Parliament in 1640 and 1641 pronounced the levying of ship-money illegal; and the bill to this effect received the king's assent, 7th August 1641.

Ship of Fools. See BRANDT.

Ship Railway. See RAILWAYS, Vol. VIII. p. 556, and NOVA SCOTIA.

Shipton, MOTHER, a famous prophetess of popular English tradition, whose story has at any rate the weight of a considerable antiquity. S. Baker published in 1797 her prophecies, together with those of the Cheshire prophet Nixon, and here we gather the following circumstantial details. Ursula Shipton was born near Knaresborough in Yorkshire, in July 1488, was duly baptised as Ursula Southiel by the Abbot of Beverley, at twenty-four married Tony Shipton, a builder, and departed this life with much serenity at over seventy years of age. However, a book (1684) by the notorious Richard Head is the real source of most of the fables about her. Here we are told how Agatha Shipton was carried off and married by the devil, how she bore him an ugly impish child, enjoyed power and knowledge beyond the measure of mortals, and left many prophecies behind her. Of these the earliest known record is a pamphlet of 1641, containing formal prophecies of the death of Lord Percy and of Wolsey—her prophecy that

Wolsey should never reach York was long current, is given by Baker, and was claimed as fulfilled by the fact that Wolsey was arrested at Cawood, a few days before his formal installation as Archbishop of York. In W. Lilly's *Collection of Ancient and Moderne Prophecies* (1645) occurs 'Shipton's prophecy,' and from it we see that all her prophecies were considered as already fulfilled. Again, an extant comedy on the subject dates from about 1660. A prophecy in doggerel verse under her name was put into circulation about 1862 by Charles Hindley, on his own confession (*Notes and Queries*, April 26, 1873). These wretched lines concluded with a prophecy that the world should come to an end in 1881, which caused great anxiety amongst a few very ignorant persons in corners of England. See William H. Harrison's *Mother Shipton Investigated* (1881), in which all the facts available are excellently set forth. Mr Harrison points out, moreover, the striking likeness between the traditional Mother Shipton represented on the chap-books and the conventional Punch.

Ship-worm. See TEREDO.

Shipwrecks. See WRECKS.

Shiraz', a city of Persia and capital of the province of Fars, much celebrated in Persian poetry for its climate, its wine and roses, and its beautiful gardens, is situated in a broad plain, 115 miles ENE. of Bushire and 35 miles SW. of the ancient Persepolis (q.v.). It is enclosed by ruined walls, and previous to the earthquakes contained many splendid mosques, bazaars, caravanserais, and other public buildings. The place has now a mean and ruined appearance, and is greatly neglected. The wine of Shiraz, which is very strong and resembles Tokay, is, however, still famous throughout the East. Rose-water is prepared in large quantities. Inlaid articles in wood and metal, glass, and woollens are made here. The city was founded in the 8th century, and from its beautiful situation and charming climate became a favourite resort of the Persian princes. In 1812 a destructive earthquake laid a large portion of it in ruins, and another in 1824, which cost the lives of 4000 of the inhabitants, completed the wreck of its prosperity. It was, however, rebuilt, and numbered 40,000 people, when a third and more terrible visitation, in April 1853, laid almost the whole town again in ruins, and caused the death of 10,000 people. It has since been partially rebuilt in a somewhat inferior style, and its pop. is now estimated at 30,000. The tombs of the poets Hafiz and Sâdi, both natives of the town, exist in the vicinity.

Shire. See COUNTY.

Shiré, a river of East Africa, has its source in Lake Nyassa, and after a southerly course of 370 miles joins the Zambesi. It forms part of the chief highway to the Lakes region, and was discovered by Livingstone during the Zambesi expedition (1858-63). The navigation is obstructed by cataracts (Murchison Cataract) for 35 miles, in which the Shiré falls 1200 feet. The river passes through the heart of the Shiré Highlands, the scene of the Church of Scotland's and the English Universities' missions, and of the labours of the African Lakes Company. This district was declared British territory in 1889. See John Buchanan, *The Shiré Highlands* (1885); also NYASSA, ZAMBESIA.

Shirley, JAMES, dramatist, was born in London, September 13, 1596, and went at twelve to Merchant Taylors' School, whence he passed in 1612 to St John's College, Oxford. Wood tells us that Laud esteemed him highly, but deterred him from seeking holy orders because of the large mole on his left cheek. He migrated, however, to Catharine Hall,

Cambridge, took orders, and held for a short time a living at or near St Albans, but, becoming a Catholic, resigned it, and made his bread (1623-24) by teaching in the grammar-school there, 'which employment also,' says Wood, 'finding uneasy to him, he retired to the metropolis, lived in Gray's Inn, and set up for a play-maker.' He worked hard in his vocation, being a diligent student of his great predecessors, and Shakespeare alone has bequeathed us a larger number of regular five-act plays—there are as many as thirty-three printed in the edition of Gifford and Dyce. In 1636 or 1637 he went to Ireland, probably under the protection of Lord Kildare, but soon returned to London, where the suppression of stage-plays in 1642 ended his livelihood. For some time he attended on the Earl of Newcastle, then returned to London again to earn his bread by teaching. He contributed the address 'To the Reader' to the first folio of Beaumont and Fletcher (1647). The Restoration revived his plays, but brought him no better fortunes; and Wood tells us that he and his second wife died on the same day, distracted by the Great Fire, and were buried in the same grave, October 29, 1666.

For his plots Shirley drew upon his own inventiveness, and Dyce points out that not one, if we except that extraordinary failure, *St Patrick for Ireland*, is founded upon events of British history. Beaumont and Fletcher were his models, even more than Ben Jonson, his 'acknowledged master,' but it must be owned he has but little of the grand Elizabethan manner. Most of his plays are tragi-comedies, and his best work is ever the tragic and pathetic portions. He is chaste by comparison with his contemporaries, and his plays breathe throughout a pensive and tender beauty that touches a sympathetic reader with a charm of its own. Bright and playful fancy, sweet and flowing dialogue, honest emotion and unwrought pathos—these are the threads out of which his magic robe is woven.

His chief plays were *Love Tricks*, a bright but ill-constructed comedy, though Pepys calls it a 'silly play' (1625); *The Maid's Revenge*, a poor tragedy (1626); *The Brothers*, a comedy (1626); *The Witty Fair One*, an excellent comedy (1628); *The Wedding*, a charming and indeed exquisite comedy (1628); *The Grateful Servant*, a fine tragi-comedy, prefaced by eleven copies of verses by various friends, including Massinger (1629); *The Traitor*, his finest and also his strongest tragedy (1631); *The Changes, or Love in a Maze*, a comedy (1632); *The Bird in a Cage*, a comedy (1632, printed next year with a sarcastic dedication to Prynne, then suffering his cruel punishment); *Hyde Park*, a bright comedy, branded by Pepys as 'a very moderate play' (1632); *The Young Admiral*, specially commended by the Master of the Revels as free from oaths (1633); *The Gamester*, an admirable comedy, revived by Garrick in 1758 (1633); *The Example*, an excellent comedy, Sir Solitary Plot a happy imitation of Ben Jonson's characters of *Humour* (1634); *The Opportunity*, an amusing though improbable comedy (1634); *The Lady of Pleasure*, the most brilliant of his comedies (1635); *The Imposture*, a tragi-comedy (1640); and *The Cardinal*, to the author himself 'the best of his flock,' a tragedy coloured by Webster's *Duchess of Malfi* (1641). In 1646 he printed a volume of his poems, including his masque of *The Triumph of Beauty*. As a writer of masques he is second only to Ben Jonson. Among his best was *The Triumph of Peace*, presented by the Inns of Court before the king and queen in 1633. Another, *The Contention of Ajax and Ulysses* (1659), contains the noble and solemn lyric, 'The glories of our blood and state are shadows, not substantial things.' Almost as good is the ode, 'Victorious man of earth,' in *Cupid and Death* (1653), or that beginning 'Ye virgins that did late despair' in his dull play, *The Imposture*. The only complete edition of his works is that edited by Gifford and Dyce (6 vols. 1833). There is a selection of five plays, with *The Triumph of Peace*, in the 'Mermaid' series, by E. W. Gosse (1888).

Shirwa, a lake of south-east Africa, 45 miles SE. of Lake Nyassa; length, 40 miles; breadth, 15 to 20 miles; and 1970 feet above the sea-level. On the west, between the lake and the river Shiré, Mount Zomba rises to 7000 feet. It was proved by Consul O'Neill in 1884 to have no connection with the river Lujenda, a right-hand tributary of the Rovuma. See *Proc. Roy. Geog. Soc.* (1883-84-88).

Shisdra, a town of Russia, 80 miles SW. of Kaluga, on a branch of the Oka. Pop. 11,678.

Shishak (in hieroglyphs, *Shashank*, the *Susak* or *Susukim* of the Septuagint, the *Shishak* of the Hebrew version, the *Sesonchosia* or *Sesonchis* of Manetho), the name of several monarchs of the 22d or Bubastite Egyptian dynasty (see EGYPT, Vol. IV. p. 240). Shishak I.'s name is found in the portico built by the Bubastite dynasty at the great temple of Karnak, and on several statues of the goddess Pasht, which probably came from Luxor. Jeroboam fled to Shishak from the pursuit of Solomon, who wished to kill him, and lived there during the lifetime of Solomon. On the death of this monarch Jeroboam quitted Egypt, and contended with Rehoboam for the possession of the crown. This struggle caused the division of the kingdom of David into two states, that of Israel and Judah. In the fifth year of Rehoboam Shishak marched to Jerusalem with an army of 12,000 chariots, 60,000 cavalry, and an innumerable number of infantry, composed of Troglodytes, Libyans, and Ethiopians. He took the city, the treasures of the temple, and all the gold bucklers which Solomon had made. The conquest of Jerusalem is found recorded on the monuments of Karnak, on which Shishak I. is represented dragging before the god Ammon three files of prisoners, inscribed with various names of places, amongst which are Judæa, Megiddo, Ajalon, Mahanaim, and other towns taken by Shishak in his line of march.

Shittim-wood, the name in the Old Testament for a valuable and durable wood, believed to be that of some kind of acacia—probably the *Acacia seyal*.

Shoa, a country of Africa, lying to the south of Abyssinia proper, and watered by the Blue Nile and the Hawash, but usually accounted one of the three divisions of the Abyssinian state. Area, approximately 26,000 sq. m. In physical characteristics it closely resembles the rest of Abyssinia (q.v.). The highest point in the Guraghe Mountains reaches 12,790 feet. The people, who are partly Abyssinians and partly Gallas, number about 1½ million. The present capital is Licheh (pop. 3000); but the most important place is the former capital, Ankobar (q.v.). This country was conquered by King Theodore of Abyssinia shortly after his accession (1855). On the death of Theodore's successor (John II.) in 1889 the king of Shoa, Menelek, was made king of all Abyssinia; and Shoa, like the rest of Abyssinia, is now in many particulars an Italian protectorate.

Shock. It is well known that some forms of injury, as, for example, a blow on the pit of the stomach, may occasion death without leaving any visible trace of their operation in the body; and, indeed, life may occasionally be destroyed even by sudden and powerful mental emotions. In such cases as these death is said to result from *shock*, the actual cause of death being the sudden arrest of the heart's action, consequent on the violent disturbance given to the nervous system. The effects of shock may be manifested in all degrees from the transient feeling of faintness (see FAINTING) or sickness produced by a sudden emotion, or an unexpected and unpleasant sight, &c., to the disastrous result above described. In cases of moderate

severity the condition known as *collapse* is induced, in which the patient lies in a state of utter prostration, and apparently on the verge of dissolution. The face, and even the lips, are pale and bloodless; the skin is cold and clammy, and drops of sweat are often seen on the forehead. The features are contracted, and there is great languor in the general expression. There is extreme muscular debility, and the sphincter muscles sometimes relax, so that there is involuntary discharge of the contents of the bowels and the bladder. The pulse is quick, and so feeble as often to be almost imperceptible, and the respiratory movements are short and weak, or panting and gasping. The patient is in some cases bewildered and incoherent, in others drowsy, and sometimes almost insensible. In less severe cases nausea and vomiting, with hiccup, are not infrequent symptoms; and in the case of children convulsions are often present.

When a person recovers from a state of collapse he passes into a condition termed *reaction*, which often lasts for several hours. The first symptoms of this favourable change are improvements in the state of the pulse and the respiratory actions, recovery of the power of swallowing, an increased temperature, and an inclination to move from the supine position to one side. A slight degree of feverishness then often ensues, after which the skin becomes moist, the patient falls asleep, and awakes convalescent. As a general rule, the longer the symptoms of reaction are delayed the greater is the danger, and if several hours pass without any sign of the commencement of reaction there is little hope of recovery.

The principal causes of shock in its severer forms are sudden and severe or extensive injuries, whether due to accident or operation, particularly if they involve any of the viscera, joints, or other organs abundantly supplied with nerves. Pain alone, when intense and protracted, has proved fatal in this way; and it appears in a case related by Sir A. Cooper that sudden relief from great agony was attended by the same untoward result. Certain poisons operate in this manner, depressing the system so suddenly and severely as to produce a state of collapse; tobacco, for example; and drastic purgatives have in some cases induced a similar condition.

The effects of shock are aggravated by loss of blood; and hæmorrhage alone, if sudden and profuse, will produce collapse. General debility and old age favour the influence of the shock, and much depends upon the idiosyncrasy of the patient; an injury which will produce no apparent effect on one man often producing a serious and persistent impression on another.

The following are the most important points in regard to treatment: The patient should be kept in a horizontal position, with the head on the same level as the body, and he should not be raised till decided symptoms of reaction appear. The best stimulant is brandy, in moderate and carefully regulated doses, given in the form of hot brandy and water. At the same time heat should be applied to the pit of the stomach and the extremities, by means of hot flannel, hot-water tins, or, in their absence, bottles containing hot water, and other appliances. Nourishment, in the form of beef-tea, should closely follow the stimulants; the two may be combined with the greatest advantage, and as the system rallies the latter may be entirely replaced by the former. See Holmes's *System of Surgery*.

Shoddy (a provincial word, 'that which is shed') formerly meant only the waste arising from the manufacture of wool, but it has acquired a wider and much more important signification. Clippings of woollen and worsted stuffs and rags of

any kind of fabric made of wool are now carefully utilised. Cuttings of new flannels, worsted cloths, and knitted textiles receive the name of *new shoddy*, and when articles made of these are worn out they are termed *old shoddy*. On the other hand tailors' clippings of milled cloths are called *new mungo*, while the material of old clothes and rags of this woollen cloth is styled *old mungo*. Both shoddy and mungo, which were formerly, to a large extent at least, waste materials, are now 'ground up' as it is termed—i.e. they are put into a machine with a revolving cylinder armed with iron spikes and having toothed rollers moving in an opposite direction. This *willy* or *devil*, as it is called, reduces the rags or clippings to short wool, which, when cleaned, oiled, and mixed with some fresh wool, is remanufactured into many different kinds of cheap fabrics, such as rugs, druggets, friezes, flannels, inferior milled cloths, &c. These, though serviceable while they last, are of course not so durable as when made of new wool. See RAGS, and WOOL.

Shoebill. See BALENICEPS.

Shoe-blacking. See BLACKING.

Shoeburyness, on the coast of Essex, and at the mouth of the Thames, faces the Nore, 3 miles E. of Southend and 45 of London. Its dreary marshland, purchased by government in 1842-55, has since been the seat of a school of gunnery, with artillery barracks, batteries, targets, and other appliances for experimenting on cannon. See GUNNERY.

Shoes. See BOOTS AND SHOES, HORSESHOEING.

Shola, or SOLA, the white pith of the leguminous plant *Eschynomene aspera*, a native of India. With this substance, which is exceedingly light, the natives of India make a great variety of useful articles, especially hats, which being very light and cool are in great request. Helmets made of shola are much used by the British in India.

Sholapur, a town of British India, presidency of Bombay, 150 miles by rail SE. of Poona, with important silk and cotton manufactures. An old fort and ruined walls (in part) still exist. Pop. (1891) 61,915.—The *district* has an area of 4542 sq. m. and a pop. of 750,689.

Shooter's Hill, an eminence (446 feet) in Kent, near Greenwich and Woolwich, which commands a splendid view of London.

Shooting. See GUN, GAME-LAWS, POACHING, GROUSE, DEER-FORESTS, BATTUE, PIGEON, &c.

Shore. See SEASHORE.

Shore, JANE, the famous mistress of Edward IV., was born in London, and was well brought up, and married at an early age to William Shore, an honest citizen, traditionally a goldsmith. After her intrigue with the king began her husband abandoned her, but she lived till Edward's death in the greatest luxury, enjoying great power through his favour, yet 'never abusing it,' as More tells us, 'to any man's hurt, but to many a man's comfort and relief.' Her beauty was more that of expression than of feature, and her cheeks somewhat pale, yet her face was fair beyond others, and 'there was nothing in her body that you would have changed, but if you had wished her somewhat higher.' But her greatest charm was her bright and playful wit. After the king's death she lived under the protection of Hastings, and on his death, it is said, of the Marquis of Dorset; but King Richard III., out of a pretended zeal for virtue and to make his brother's life odious, plundered her house of more than two thousand marks, and caused the Bishop of London to make her walk in open penance, taper in hand, dressed only in her kirtle. More tells us that Richard had first tried to charge her with bewitching him, literally rather than in

the sense in which she had done his brother, and the reader will remember the use that Shakespeare has made of this in his tragedy of *Richard III.* Jane Shore survived her penance more than forty years, dying in the 18th year of Henry VIII. The additional horrors that she died in a ditch since called Shoreditch, and that a man was hanged for succouring her contrary to Richard's command, are completely unhistorical, however positive their ballad authority.

Percy printed from the Pepys collection 'The woofull lamentation of Jane Shore,' in wretched doggerel, ascribed to Thomas Deloney. Thomas Churchyard also wrote a poor ballad on the story, inserted in the *Mirror for Magistrates*, and Drayton has in his *England's Heroical Epistles* one from her to her royal lover, with a prose description of her beauty in the notes. Deloney's ballad is printed also in the *Collection of Old Ballads* (1723), with a miserable burlesque song on the same subject.

See 'Some Particulars of the Life of Jane Shore,' by Mark Noble, in Brayley's *Graphic Illustrator* (1834); and Sir Thomas More's fine picture in his *History of Richard III.* Nicholas Rowe's drama dates from 1714.

Shoreditch, a parliamentary borough of East London, returning two members—one for Haggerston and one for Hoxton. See TOWER HAMLETS, and LONDON.

Shoreham, NEW, a seaport of Sussex, at the mouth of the Adur, 6 miles W. of Brighton. It arose when the harbour of Old Shoreham, now a mile inland, became silted up; and it has some shipbuilding, oyster and other fisheries, and a considerable trade with France from its tidal harbour, whose piers were erected in 1819. Charles II. embarked here after Worcester for Normandy. The suspension bridge (1833), the Norman and Early English parish church, and a place of resort, the 'Swiss Gardens,' may be noticed. The parliamentary borough of New Shoreham, including since 1770 the Rape of Bramber (177 sq. m. and 42,442 inhabitants in 1881), and returning two members, was merged in the county in 1885. Pop. of parish (1851) 2590; (1891) 3393.

Shorncliffe, in Kent, 2½ miles W. of Folkestone, the seat of a military camp during the Peninsular war, and since the Crimean war of a permanent one for 5000 men.

Shorthand. The problem which inventors of systems of shorthand have attempted to solve is thus formulated by Peter Bales (c. 1547-1610), a writing-master and stenographer—'to write as fast as a man speaketh treatably.' 'This,' he says, 'may in appearance seem difficult; but it is in effect very easy, containing a many commodities under a few principles, the shortness whereof is attained by memory, and swiftness by practice, and sweetness by industry.' Although three hundred years have elapsed since this assertion was made, it has not yet been realised to the extent anticipated.

Phonography is a growth of the age, and is the lineal descendant of the 200 different systems that have been published since the appearance of the first system of modern shorthand in 1588. It carries out fully the principle which all previous systems acknowledge, but do not faithfully apply—viz. that of enlarging the ordinary 26-letter alphabet. Those systems add to the alphabet three signs for *ch*, *th*, and *sh*; but these are not all the consonants in which our alphabet is deficient. Two signs are required for *th*, as pronounced in *thin* and *then*, one for *ng* in *sing*, and one for *zh* in *pleasure* (plezhure). But the principal defect in the ordinary systems of shorthand is in their vowel notation. They contain but five signs for the five vowels, *a*, *e*, *i*, *o*, *u*, which, single and combined, represent 17 different sounds. This disparity between the sounds of the

language and the means of representing them made the reading of shorthand extremely difficult and uncertain.

In the 18th century three systems were published, by Tiffin, 1750; Lyle, 1762; and Holdsworth and Aldridge, 1768; and in the 19th century five systems appeared, by Row, 1802; Towndrow, 1831; Pitman, 1837; De Staines, 1839; and Bell, 1857, based on the phonetic principle; but, excepting phonography, they were wanting in all the main requisites of a shorthand system—simplicity of construction, facility in execution, and elegance in effect.

The shorthand of the Romans, practised by Tiro, first the slave and afterwards the freedman of Cicero, was really an abbreviated longhand. The Roman letters were shorn of their just proportions, initial letters often served for whole words, and terminations, in which Latin abounds, were either abbreviated or omitted. By systematising these mutilations Tiro constructed a system of swift writing, which served him as Cicero's amanuensis in good stead, and doubtless we owe to it much of what remains to us of the writings of Cicero.

The history of shorthand properly so called, with an alphabet of simple signs as substitutes for the ordinary letters, dates from the reign of Elizabeth. Dr Timothy Bright (c. 1551-1615), a learned man, the author of several medical works and the compiler of an abridgment of Fox's *Book of Acts and Monuments of the Church*, in the year 1588 published *Characterie; an Arte of Shorte, Swift, and Secrete Writing by Character*. In this ingenious work Bright claims the invention of the art of shorthand. His claim may justly be disputed, for his system is not shorthand in the present sense of the word. It is not based on a shorthand alphabet, but is a

system of arbitrary marks for words: thus }
 abound, \ about, | accept, ↓ accuse, ↓ ad-
 vance, &c.

Two years after the appearance of this work Peter Bales published *The Writing Schoolmaster*. This system also was composed of arbitrary characters. In the year 1602, a little above threescore years before Wilkins published his celebrated *Essay towards a Real Character and a Philosophical Language* (1668), appeared *The Art of Stenography, or Short Writing, by Spelling Characterie, invented by John Willis, Bachelor in Divinity*. The author intimates in the title of the work the grand distinction between it and the previous attempts that had been made in the art by describing it as 'spelling characterie,' the others having been verbal characterie. John Willis's alphabet is:

a b c d e f g h i j k l m n o
 Λ ∩ Γ I 7 < L J o ∞ > Γ ∩ U ∩
 p q r s t u v w x y z
 / 0 - 1 (λ v) ∞ x z

The inadequacy of this alphabet is proved by the fact that not one of its letters was used in the same sense by the inventors of systems in the following century, when shorthand began to be popular. Sixteen years after the publication of John Willis' system Edmund Willis published *An Abbreviation of Writing by Character* (1618). This system exhibits a considerable improvement in its alphabet, and 15 of its letters were adopted by subsequent shorthand authors.

The next name on the roll of shorthand authors deserving of mention here is that of Rich, 1654-69. His system was used by Dr Doddridge,

who reprinted it for the benefit of his theological students, and strongly recommended its adoption by young persons. Mason followed in 1672-1707. The alphabet had now become much simplified. Mason's system was adopted by Thomas Gurney in 1750, and has since been known as Gurney's shorthand.

The principal shorthand authors of the 18th century were Macaulay, 1747; Angell, 1758; Byrom, 1767; Taylor, 1786; and Mavor, 1789; and in the 19th century, Clive, 1810; Lewis, 1815; Moat, 1833; Isaac Pitman (q.v.), 1837; Fancutt, 1840; Bradley, 1843. Of these systems, except Pitman's phonography, the one that has obtained the greatest amount of popularity is Taylor's, and a few private persons and reporters use it to the present day. Its alphabetic signs are well chosen, but it fails to supply signs for three consonant sounds heard in the English language, and it makes no pretension to express all the vowel and diphthong sounds. The following is Taylor's alphabet:

b c d f g h j k l m n
 e (— / \) /) (— o — —
 p q r s t v w x y z
 | (— / — | \ — — — —
 oh sh th
 (— | a — o
 e — i — s
 t — j —

The publication in 1837 of Isaac Pitman's system of shorthand, entitled 'Phonography,' in which the stenographic signs or letters represent the sounds of the English language, marks a new era in the art. The legibility which this principle secures has led to the very general use of shorthand in merchants' and lawyers' offices, and in railway and ordinary correspondence; it has also promoted the establishment in England of a dozen shorthand periodicals. A vigorous propagandism, and instruction books at low prices, have aided in giving to this system its well-merited distinction above all others in public estimation. At the end of the 18th century the price of a treatise on shorthand was a guinea, and a course of lessons in the art cost five or ten guineas. In contrast with this, Pitman's system is published in a compendious tabular form for a penny, and its inventor organised a Phonetic Society, extending throughout Great Britain and Ireland, whose members invite learners to send their lessons through the post for gratuitous correction.

Before giving a brief description of this system of shorthand we may note the conditions on which alone Peter Bales's reasonable anticipation of the future universal practice of shorthand can be realised, and then it may be seen whether phonography fulfils these conditions.

Given a language, say the English, it is required to provide signs for its expression which may be written at the rate of speech in a public assembly, which ranges from a very slow utterance of 60 words in a minute, with frequent pauses, to a rapid flow of 180 words in a minute. The average of public speaking is a mean between these extremes—i.e. 120 words a minute, or two words per second. A dexterous penman can make 180 separate simple strokes or dots in a minute. The required system of shorthand must, therefore, represent two words by three strokes (or dots), or by one and a half strokes per word. Let the reader try his hand upon such signs as

\ | / — — — — —

(the last two struck upward), and he will feel

assured that there is no error in the conclusion to which he will be brought.

The number of pen-strokes and dots or short vowel marks in the following specimen of reporting in phonetic shorthand (*Phon. Jour.*, 1st February 1879) is 425. The number of words which these signs represent is 319, or $1\frac{1}{2}$ strokes per word :

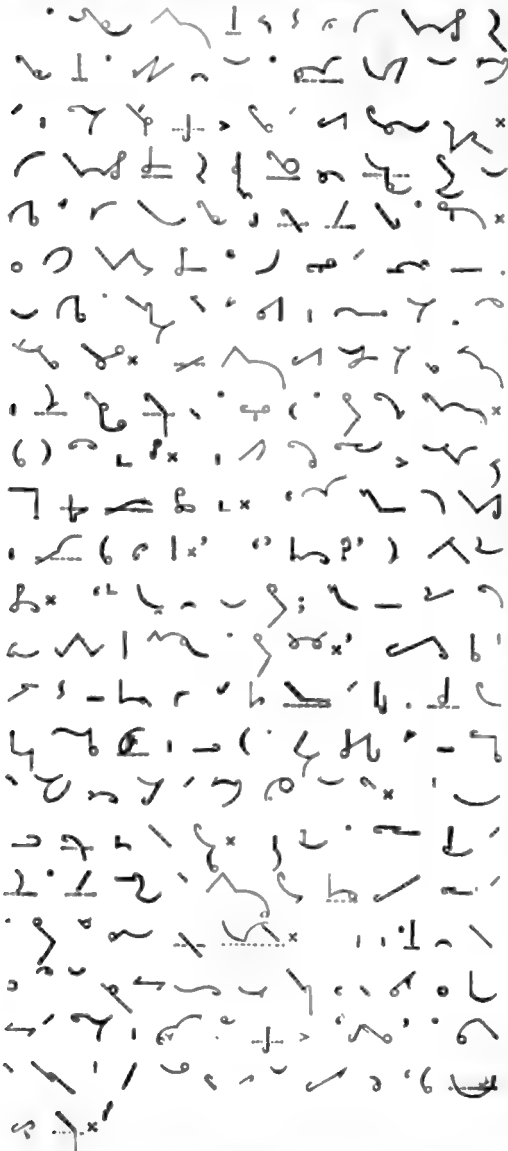

Key.—An enterprising reporter had heard that the late Lord Palmerston was to be present at an archery meeting in a small village in Hampshire, and he accordingly posted down to the place, and waited for something to turn up. Lord Palmerston's task was to distribute prizes to some half-dozen blushing young ladies, and the whole company present didn't number much above a score. His lordship performed the task with his usual grace and good humour, giving the young ladies a paternal pat on the head, but making only the most commonplace observations. Our reporter waited anxiously until, to his horror, he saw the proceedings brought to a close without a speech from the Premier. This was more than he could stand. He rushed from his corner to the noble lord, who was getting out of the room as fast as he could: 'My lord, I beg your pardon,

but really this will not do.' 'What do you mean?' was the reply of the astonished statesman. 'Why, you've made no speech; I've come all the way from London to report it, and I must have a speech of some sort.' Whereupon it is on record that the good-tempered old gentleman turned back, and detained the audience for twenty minutes while he gave them a genial dissertation on the good qualities of English women in general, and Hampshire lasses in particular. On another occasion, however, he made up for this. He was attending an agricultural dinner, and saw a large gathering of reporters, for the times were critical, and a speech of his certain to be valuable. But he had made up his mind not to speak—no man knew better when to hold his tongue—and accordingly he slyly sent down to the 'gentlemen of the press' a slip of paper, on which, in his bold, round hand, were the words: 'This fish won't bite!'

We have seen that the pen can produce $1\frac{1}{2}$ strokes per word uttered at the rate of 120 per minute. The pen is therefore ahead of the speaker, and in a burst of oratory could record 200 words in a minute. In this calculation the reporter has the further advantage that this estimate is based on the number of *separate* strokes which the pen can make in a minute, whereas *joined* strokes can be written more rapidly than single ones: thus



take less time than



&c. In the above specimen only 130 words are written by single strokes, and the remaining 295 words or phrases (for several words are often linked together in one shorthand outline) are composed of from two to four strokes combined in one stenographic form.

Words can be recognised, either in longhand or shorthand, by their consonants alone; and the simple strokes employed in shorthand to represent the consonants may be placed in three positions, *above, on, or through* the real or imaginary line on which the writing is placed. The twelve simple or pure vowels and five diphthongs in the English language may be arranged in three classes, according to the nature of the sounds, as below. The vowel of any given word, or rather the class of vowels to which it belongs, may therefore be understood by the *position* which the consonant part of the word takes with respect to the line. The alphabet of phonography is:

CONSONANTS.									
(thin) (then)									
		(up)							
VOWELS.									
<i>Long.</i>									
<i>palm</i>	<i>pate</i>	<i>peat</i>	<i>pall</i>	<i>bone</i>	<i>pool</i>				
<i>Short.</i>									
<i>pat</i>	<i>pet</i>	<i>pit</i>	<i>poll</i>	<i>pen</i>	<i>pull</i>				
DIPHTHONGS.									
<i>pine</i>	<i>new</i>	<i>now</i>	<i>ay (yes)</i>	<i>boy</i>	<i>wide</i>				

The vowel and diphthong signs are the dots, dashes,

and small angular marks; the upright stroke to which they are placed (the shorthand letter *t*) is introduced to show the *position* in which the vowel-sign is written with respect to *all* consonants. These 17 vowel-signs may be distributed into three classes, all the sounds in each class having a common characteristic; thus:

Class 1.—Ah, ä; au, ö; ei, ai, oi=7, in each of which, except *ei*, the broad sound of *ah* or *aw* is heard.

Class 2.—Eh, ê; oh, ô=4, intermediate sounds between *ah* and *ee*, and between *aw* and *oo*.

Class 3.—Ee, î; öö, ö; eu, ou=6, in each of which the close *ee* or close *oo* predominates.

By adding a hook or small circle to the consonants, by halving, and by lengthening, double and treble letters are produced on the following plan:

Straight Lines. 
p pl pr sp spr pf pn ps pns pt

Curves. 
a nl nr sn nn ns nt ntr

This principle is applicable to all the consonants, and conduces to the brevity of the system.

The shorthand letters, both vowels and consonants, are employed first as component parts of words, and secondly each letter is made the representative of some common word in which the letter is prominently heard; thus *\ p* represents *up*, *| t* stands for *it*, */ ch* for *which*, *— k* for *come*, *\ öö* for *to*, &c.

The most frequently occurring words, *the*, *and*, *of*, *in*, *to*, &c., are selected for this distinction, and are called grammalogues, or letter-words; and the shorthand letters when thus employed are logograms or word-letters. In the 'learners' style' of phonography only 50 grammalogues are used; in the ordinary or 'corresponding style' there are 150 (which amount to one-half of the language on common subjects); and in the 'reporting style' the number is largely increased, for every short word becomes a grammalogue on the principle of omitting its vowel and writing the consonant form *in position* with respect to the line, *above*, *on*, or *below*, to denote a vowel of the first, second, or third class.

A remarkable impetus has been given to the general cultivation of shorthand by the celebration of the tercentenary of Bright's system and the jubilee of Pitman's phonography at the first International Shorthand Congress, held in London in 1887, followed by the introduction of shorthand as a subject to be taught in elementary schools and technical classes in Great Britain. The second congress was held at Paris in 1889. Many systems are used by French writers, the best known being those of Prévost (based on Taylor) and Duployé, in which the vowels are joined to the consonants. The third congress, at Munich in 1890, included special gatherings of disciples of Gabelsberger, whose system—a script one, having the slope of ordinary longhand—is largely used in Germany, Austria, Hungary, Sweden, Denmark, and Italy. The fourth congress, held at Berlin in 1891, included a special gathering of writers of the Stolze school (a modification of Gabelsberger), extensively employed in north Germany. In the United States and Canada several persons have published Mr Pitman's phonography. Benn Pitman, a brother of the inventor, and A. J. Graham published the English phonography of 1856, when the old vowel scale was used, and have introduced

slight modifications of some parts of the system. In 1858 the vocalisation was changed to that at present used, which J. E. Munson and Longley have adopted, and which introduced some very slight changes in one or two consonants that they might secure copyright in America.

Pitman's phonography was adapted to the Japanese language in 1879, and is employed for reporting the Diet. It has also been adapted to the Hindu and Malagasy languages, and adaptations to the Welsh, French, Italian, German, Dutch, and Spanish languages appeared between 1887 and 1892.

See Isaac Pitman's *Phonographic Teacher*, and his *History of Shorthand* (3d ed. 1891), which describes the ancient systems and 250 English systems; Thomas Anderson's *History of Shorthand* (1882), including the Continental and leading English systems, and his *Shorthand Systems* (1884); and works by Dr Westby-Gibson (1882), J. E. Rockwell, J. W. Zeibig (Dresden, 1878), and H. Moser (Leip. 1889 *et seq.*).

Shorthouse, JOHN HENRY, was born at Birmingham in 1834, was educated at private schools, and settled as a manufacturer in his native city. In 1881 the extraordinary popularity of his romance, *John Inglesant* (previously printed for private circulation), carried his name over England. The book was written in fine, delicate English, and revealed a subtle and sympathetic insight into old-world phases of the spiritual mind, but was invertebrate in structure, its second half at any rate anything rather than a novel. It was followed by *The Little Schoolmaster Mark: a Spiritual Romance* (1883-84); *Sir Percival: a Story of the Past and the Present* (1886); *A Teacher of the Violin* (1888); *The Countess Eve* (1888); and *Blanche, Lady Falaize* (1891). These stories all lack substance, his figures being more shadows than men and women, but the style, though in later books somewhat over-refined, continues to please his admirers. He has contributed a few articles to the magazines, and wrote the article on George Herbert in the present work.

Short-sightedness. See EYE, p. 515.

Shoshone Falls (pron. *Shoshonee'*), on the Snake (q.v.) River, in southern Idaho, about 950 feet wide, and with a clear leap of 210 feet (that of Niagara is under 170 feet). The river runs in a deep gorge between walls of volcanic rock, 1000 feet high at the foot of the falls, and the head of the falls is in the form of a semicircle. Four miles higher up are the Little Shoshone Falls, two nearly equal cataracts divided by a great rock, and falling 182 feet. See the *Century Magazine*, April 1890.

Shoshones, a family of American Indians (see Vol. I. p. 226), also known as Snakes, living, since 1805 at least, to the west of the Rocky Mountains; they are now on three reservations, two in Idaho (over 2100), one in Wyoming (900)—and scattered through Nevada, Utah, and north-western Idaho (perhaps 1400 altogether). Missions have been started by the Episcopalians, Roman Catholics, and others. Though most are inoffensive, some of the bands are fierce and warlike, and hostilities ceased only in 1867, after an expedition had destroyed a great part of their braves and stores.

Shoshong, capital of Khama, chief of the Bamangwato in the Bechuanaland protectorate, near the telegraph and projected railway to Mashonaland, was in 1892 superseded by Palapwe (or Palapye), 60 miles to the NE. Shoshong, now deserted by most of its population, was long the largest native town in South Africa, and a great trade centre, being on the trade route to the coast and the farther interior—to Matabeleland, the Zambesi, and Lake Ngami. The exports of the

region are chiefly ostrich-feathers, ivory, and skins; Manchester piece-goods and Sheffield hardware are among the imports. Pop. variously stated at 2000 to 5000—much reduced of late.

Shot is the term applied to all solid projectiles fired from any sort of firearms; those for cannon and machine guns being of cast-iron or steel, those for small-arms of lead. Solid shot of more than 3 lb. weight are no longer used as artillery projectiles except where the armament is obsolete (smooth bore or Armstrong guns). Even the Palliser chilled shot for piercing armour is not quite solid, having a small internal cavity. *Bar-shot* were two discs of iron connected by a bar, and used formerly to destroy the rigging and spars of ships. *Chain-shot*, for the same purpose, were two round shot connected by a chain. *Case-shot* (q.v.) or *canister* is used with all guns to ward off a sudden attack, as of cavalry or of boats; it consists of a tin cylinder fitting the bore of the gun, and filled with bullets. *Grape-shot* is obsolete. It consisted of small iron balls (1 lb. to 2 lb. weight) held together on a spindle by canvas or by iron plates so as to be easily inserted in the gun.

Small-shot for sporting purposes is of various sizes, from buck-shot, nearly as large as peas, to dust-shot. It is made by dropping molten lead through a colander in rapid motion from a considerable height into water. The lead falls in small globular drops through holes varying in size according to the denomination of the shot, No. 0 requiring holes $\frac{1}{16}$ th inch in diameter, No. 9 $\frac{3}{32}$ th inch. A small portion of arsenic is melted with the lead to harden it, and the fusion in the colanders is maintained by those vessels being surrounded by burning charcoal. The fall through the air enables the lead to cool and harden before taking its plunge. The smaller sizes require less fall than the larger—100 feet suffices for sizes Nos. 4 to 9; the larger sorts demand 150 feet. The highest shot tower is at Villach in Carinthia, where there is a fall of 249 feet. After cooling, shot is sifted in successive sieves to separate the sizes. Misshapen shot are found by their inability to roll down an inclined plank; and finally the whole are polished by rotary motion in small octagonal boxes, in which a little plumbago has been thrown.

Shotts. See ALGERIA; SAHARA, Vol. IX. p. 76.

Shoulder-joint, an enarthrodial or ball-and-socket joint. The bones entering into its formation are the humerus or arm-bone (see ARM) and the scapula or shoulder-blade. The former has already been described: the latter is a flat triangular bone which is indirectly attached to the trunk by articulation with the clavicle. When the arm hangs by the side the scapula covers the ribs posteriorly from the second to the seventh or eighth inclusive. It presents a posterior surface or *dorsum*, an anterior surface or *venter*, three borders, three angles, and certain outstanding processes.

The figure represents a posterior view of the scapula. It is divided into two unequal parts, the supra-spinous fossa (1) and the infra-spinous fossa (2), by the spine (10), a crest of bone commencing at a smooth triangular surface (11) on the internal border, and running across towards the upper part of the neck of the scapula (8), after which it alters its direction, and projects forwards so as to form a lofty arch, known as the acromion process (12), which overhangs the glenoid cavity (6), or receptacle for the head of the humerus. The acromion obviously serves to protect the shoulder-joint, as well as to give great leverage to the deltoid muscle which raises the arm. From the upper part of the neck (8) there proceeds a curved projection termed the coracoid process; it is about 2 inches

long, and gives attachments to several muscles. The upper border of the scapula presents a notch (4), which in the recent state is bridged over by a ligament, and gives passage to the supra-scapular nerve.

The large globular head of the humerus is received into the shallow glenoid cavity of the scapula, an arrangement by which extreme freedom of movement is obtained, while the apparent insecurity of the joint is guarded against by the strong ligaments and tendons which surround it, and above by the arched vault formed by the under surface of the acromion process. As in

movable joints generally, the articular surfaces are covered with cartilage, and there is a synovial membrane which lines the interior of the joint. The most important connecting medium between the two bones is the capsular ligament.

The shoulder-joint exhibits the following varieties of motion: (1) flexion, to a great extent; (2) extension, in a much more limited degree; (3) adduction, in an oblique direction, forwards and inwards; (4) abduction very freely; (5) circumduction; and (6) rotation slightly.

The morbid affections of the shoulder-joint may

be divided into those arising from disease and those dependent on an accident. The most common diseases are acute and chronic inflammation of the joint, which often terminate in its ankylosis or immobility. The principal accidents are fractures and dislocations.

There may be fracture (1) of the acromion process, or (2) of the coracoid process, or (3) of the neck of the scapula, or (4) of the superior extremity of the humerus; or two or more of these accidents may be associated. Again, the head of the humerus may be dislocated from the glenoid cavity as the



Fig. 1.—Posterior View of the Left Scapula:

The parts designated by the figures 1, 2, 4, 6, 8, 10, 11, 12 are sufficiently described in the text; 3 is the superior border; 5, the external or axillary border; 7, the inferior angle; 9, the internal or vertebral border; 12, the acromion process; 13, one of the nutrient foramina; 14, the coracoid process.

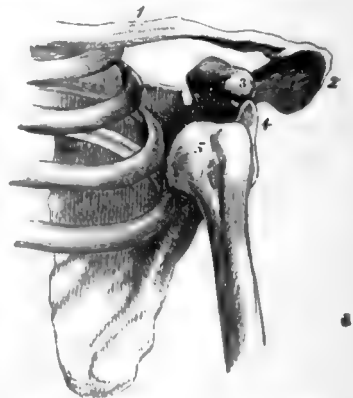

Fig. 2.—Dislocation of the Shoulder-joint downwards:

1, the clavicle; 2, the acromion process; 3, the coracoid process; 4, the glenoid cavity; 5, the head of the humerus lying in the axilla.

result of accident in three different directions—viz. (1) downwards and inwards into the axilla, which is by far the most common form; (2) forwards and inwards; and (3) backwards on the infra-spinous fossa, or the dorsum of the scapula. The first of these varieties is of very common occurrence, and everybody should know how to recognise, and even (in an emergency) to treat it. The bones are in the position shown in the figure; the arm is lengthened; a hollow may be felt under the acromion, where the head of the bone ought to be; the shoulder is flattened; the elbow sticks out from the side, and cannot be made to touch the ribs; and the head of the bone can be felt if the limb be raised, although such an attempt causes great pain and weakness. The methods of treating such a case are discussed at DISLOCATION. The scapula may also be fractured in any of its parts as the result of direct violence, and its inferior angle may slip from its natural position.

Shovel, SIR CLOUDESLEY, a brave but ill-fated admiral, was born of poor parents, about 1650, most probably at Clay, a Norfolk fishing-village. Here he was apprenticed to a shoemaker, but he ran away to sea, and soon rose by his remarkable ability and courage through the grades of cabin-boy and seaman to the quarter-deck. He served as lieutenant under Sir John Narborough in the Mediterranean (1674), burned four pirate ships under the walls of Tripoli, commanded a ship at the battle in Bantry Bay (1689), and was soon after knighted for his conduct. In 1690 he rose to be rear-admiral of the blue, and took an active part in the battle off Beachy Head; two years later, as rear-admiral of the red, he supported Admiral Russell heroically at La Hogue, and himself burned twenty of the enemy's ships. He was sent to Vigo in 1702 to bring home the spoils of Rooke, next served under that hero in the Mediterranean, and led his van at Malaga. In January 1705 he was made rear-admiral of England. That year he took part with Peterborough in the capture of Barcelona, but failed in his attack on Toulon in 1707. On the voyage home his ship, the *Association*, struck a rock off the Scilly Isles, on the foggy night of the 22d October 1707, and went down with 800 men on board. Three other vessels of his squadron perished with a loss of over 2000. Sir Cloudesley Shovel's body was washed up next day, and buried in Westminster Abbey.

Shoveler (*Rhynchaspis* or *Spatula*), a genus of birds of the duck family, Anatidae, having the



The Common Shoveler (*Rhynchaspis clypeata*), male and female.

hind-toe small, free, and unlobed; and remarkable for the expansion of the end of the mandibles in adult birds, particularly of the upper mandible.

The lamellæ of the mandibles are long and very delicate. The legs are placed near the centre of the body, so that these birds walk much more easily than many of the ducks. The Common Shoveler (*R. clypeata*) is smaller than the wild duck, but rather larger than the widgeon. The shoveler is a visitant to the British Isles, especially during cold weather. A few remain all the year. It is widely distributed over North Africa, Europe, Asia, and North America. It is reported as having been found in Australia. Its nest is made of fine grass, with a lining of down, on dry ground on the borders of rushy lakes. The eggs, from eight to fourteen in number, are of a pale greenish buff colour. Its food consists of grasses, worms, slugs, snails, insects, and small crustaceans. Its flesh is well flavoured and very highly esteemed. The bird is often called Broad-bill.

Showers of Fishes occasionally fall in different parts of the world, exciting great astonishment. Instances of this kind have occurred in Britain. On one occasion a shower of small three-spined sticklebacks fell near Merthyr-Tydvil in Wales, sprinkling the ground and housetops over a large area. If caught up by a whirlwind from any of the brackish ponds near the sea, in which this species of fish abounds, they must have been conveyed through the air a distance of almost thirty miles. Another similar instance occurred at Torrens, in the Isle of Mull, in which herrings were found strewed on a hill five hundred yards from the sea, and one hundred feet above it. Such downfalls are more common in tropical countries. In India a shower of fishes varying from a pound and a half to three pounds in weight has been reported. Sometimes the fishes are living, more frequently they are dead, and sometimes dry or putrefying. They are always of kinds abundant in the sea or fresh waters of the neighbourhood. The occurrence of the phenomenon is readily explained by the partial vacuum and strong up-draught produced in the centre of a whirling column of air like that of a Tornado (q.v.). Such a whirling column in passing over the surface of a lake or river or of the sea may suck up a considerable quantity of water along with any living creatures that may be in it. This may be carried for a considerable distance, and is discharged as a waterspout or cloudburst when the rotational energy of the whirl is expended. Showers of frogs (when authenticated) are a similar phenomenon. Showers of dead flies have also been reported. The analogous showers of 'sulphur' or of 'blood' are produced by wind-borne pollen from pine-trees, or minute organisms of fungoid nature and bright red colour. In the latter cases the organic particles probably play the part of dust in causing the rain-drops to form. See BLOOD-RAIN.

Shrapnel, LIEUTENANT-GENERAL HENRY (1761-1842), invented the Shell (q.v.) named after him.

Shreveport, a city of Louisiana, on the west bank of Red River (here spanned by an iron bridge of 1200 feet), and 328 miles by rail N.W. of New Orleans, with which it has also regular steamboat connection. It ships cotton, hides, wool, and tallow, contains planing and saw mills, foundries, machine-shops, breweries, and manufactories of cotton-gins, cotton-seed oil, soap, ice, carriages, &c. Pop. (1880) 8009; (1890) 11,979.

Shrew (*Soricidæ*), a family of insectivorous mammals closely resembling, in general form and appearance, the true mice and dormice, but in reality widely differing from and not to be confused with those rodents. The shrews have the head small, muzzle long and pointed, eyes small but

well developed, external ears usually small; body mouse-like, covered with hair; limbs short, nearly equal in size, the feet not adapted for digging; tail nearly naked and scaly. The teeth vary in number from twenty-eight to thirty-two; the formula $i. \frac{1}{2} c. \frac{1}{2} p. \frac{1}{2} m. \frac{1}{2}$ shows the numbers of teeth so far as they are constant, *v* meaning that the incisors and premolars in the upper jaw vary in different species. Along the sides of the body, or at the root of the tail, are peculiar glands, which secrete a fluid of a very strong odour. The shrews are very widely distributed, being found over North America and the whole of the eastern hemisphere except Australia. The Oriental region has twenty-eight species, the Nearctic twenty-four, the Ethiopian eleven, and the Palæartic ten. The classification of the shrews is a matter of extreme difficulty. The family is said to consist of one genus, eleven sub-genera, and about sixty-five species.

The Common Shrew (*Sorex vulgaris*), found in the British Isles and over the whole continent of Europe, has a body about 2½ inches long, the fur being generally reddish gray above and grayish below, and a tail about 1½ inch long, four-sided with the angles rounded off, and not tapering. It abounds in dry fields, gardens, and hedge-banks, feeding chiefly on insects, worms, and slugs. It burrows and makes long runs just under the surface of the ground. It is very pugnacious, and two shrews rarely meet without one of them being killed and eaten. Its natural enemies are moles, weasels, owls, and cats; but although killed by these it is not always eaten by them. Great numbers of shrews are often found dead in autumn

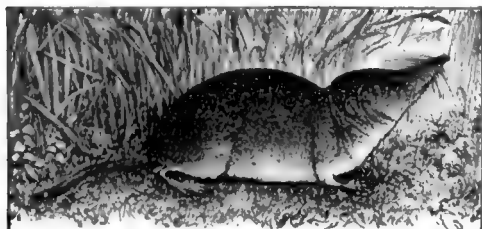

The Common Shrew (*Sorex vulgaris*).

without apparent cause, a circumstance as yet unexplained. The shrew breeds in spring; the female brings forth five to seven young in a nest of soft dry herbage in a hole in the ground. Though harmless and inoffensive, the shrew has long been regarded with dread and aversion (see White's *Natural History of Selborne*, Letter xxviii.). The Lesser Shrew (*S. pygmaeus*), another British species, closely allied to the common shrew, but with a proportionately longer tail and white on the under parts of the body, is the smallest British mammal. The Water Shrew (*Crossopodus fodiens*), larger than the common shrew, is not known to occur in Ireland, but is found in Great Britain and over the whole continent of Europe as far north as the shores of the Baltic. Though not absolutely confined to the water-side, it prefers to live there, where it forms its dwelling as a burrow in a soft bank. It feeds chiefly on aquatic insects, molluscs, crustaceans, fish spawn, and even large fish. The Garden Shrew (*Crocidura aranea*) is common over almost the whole of Europe, but does not occur in Sweden or in the British Isles. The Tuscan Shrew (*C. trusca*), found in the south of Europe, from France to the Black Sea, and also in the north of Africa, has a body only about an inch and a half long and a tail about an inch, and is the smallest living mammal. The Rat-tailed Shrew

(*C. myosura*), known in India as the Musk-shrew or Musk-rat, is about 6 inches long, and has a strong musky odour. The Musk-rat of Ceylon (*Sorex kandianus* or *serpentarius*), a smaller form, is found in Southern India and Ceylon. Two very interesting species have been brought from Tibet—the Tibetan Water Shrew, with sucking discs on the under surfaces of its feet; and the Tailless Shrew (*Anurosorex squampipes*), with a body like a mole, ears entirely concealed, eyes almost imperceptible, and feet short and scaly.

Shrew Mole (*Scalops*), a genus of insectivorous mammals of the family Talpidæ, very closely allied to the Moles (see MOLE). The tail is short and naked; the muzzle is long and slender, the nostrils looking forwards and upwards on the oblique slope at the end of the snout; the eyes are very small and are hidden in the fur. The teeth are peculiar in form; their number is represented by the formula $i. \frac{1}{2}, c. \frac{1}{2}, p. \frac{1}{2}, m. \frac{1}{2}$. The feet resemble those of the common mole, but the toes of the hind-feet are webbed. All the species are American. The Common Shrew Mole, or simply Mole (*S. aquaticus*), is found everywhere in the United States east of the Mississippi. The Prairie Mole or Silvery Shrew Mole (*S. argentatus*), about 7 inches long, is found on the western prairies as far eastwards as Ohio and Michigan. The Texan Shrew Mole (*S. latimanus*), larger in size and possessing broader fore-feet than any other species, is found in Texas and Mexico. Two other shrew moles have been placed in a separate genus: one, Brewer's Shrew Mole (*Scapanus brewerii*), closely resembling the common mole externally, but agreeing in its dentition and habits with the star-nosed mole, inhabits the eastern United States; the other, the Oregon Shrew Mole (*Scapanus townsendii*), is found plentifully on the banks of rivers on the Pacific coast.

Shrewsbury, the county town of Shropshire, on the Severn, 36 miles SSW. of Crewe, 42 W. by N. of Birmingham, and 163 NW. of London. The river here makes a serpentine curve and is spanned by the English Bridge (rebuilt 1774), the Welsh Bridge (rebuilt 1795), the iron bow and girder Kingsland Bridge (1882), which lead to the suburbs of Abbey-Foregate, Coleham, Frankwell, Castle-Foregate, and Kingsland; and the Greyfriars iron foot-bridge (1879). With its steep, narrow streets, and its wealth of black and white half-timbered houses, Shrewsbury is picturesque as very few English towns. Its Norman castle, built by Roger de Montgomery, still stands, though greatly modernised; and coeval with it is Holy Cross or Abbey Church, belonging to a Benedictine abbey (1083). Of the other eight Anglican churches the chief is St Mary's, Norman to Perpendicular in style, with a Jesse window, the tomb of Admiral Benbow, and a spire 222 feet high. Noteworthy also are the Roman Catholic church (1856), by Pugin; the council-house (1501-60), where Charles I. stayed in 1642, and James II. in 1687; the old market-house (1595); the new market-hall (1868); the shire-hall (rebuilt 1836, and again, after fire, 1883); the corn exchange (1869); the post-office (1877); the county infirmary (1747-1830); the eye, ear, and throat hospital (1881); the 'Raven' Hotel, where Farquhar in 1704 wrote the *Recruiting Officer*; the 'Quarry,' a pretty park of 23 acres, with its lime-tree avenue (1719); a Doric column (1816) to Lord Hill, 134 feet high; and a bronze statue (1860) by Marochetti of Clive. The county museum and a free library now occupy the old buildings (1630) of the grammar-school, which was transferred to a fine new site of 26 acres (now 50 acres) in 1882, since which time the number of the boys has increased from 170 to over 300. Founded by

Edward VI. in 1551, though not actually opened till 1562, and augmented by Queen Elizabeth in 1571, this school was recognised as one of the seven great public schools in the Public Schools Act of 1868, and owes its greatness partly to its rich endowment (£3100 per annum), but still more to the exertions of two successive headmasters, Dr Samuel Butler (1798-1836), afterwards Bishop of Lichfield, and Dr Kennedy (1836-66). Among its alumni have been Sir Philip Sidney, Fulke Greville, Wycherley, Judge Jeffreys, the Marquis of Halifax, Charles Darwin, Bishop Fraser of Manchester, Archbishop Thomson, Earl Cranbrook, H. C. Raikes, Stanley Weyman, and such famous scholars as B. H. Kennedy, F. A. Paley, H. A. J. Munro, R. Shilleto, and J. E. B. Mayor. A statue of Darwin, in front of it, was unveiled 1897. Glass-painting, malting, iron-founding, and the making of farm implements are industries; and 'Shrewsbury cakes' have long been held in esteem. Chartered by Richard I., the borough returned two members from Edward I.'s reign till 1885, when the representation was reduced to one. Pop. (1851) 19,681; (1881) 26,481; (1891) 26,967. The Cymric *Pengueerne* ('alder hill'), after its capture in 778 from the king of Powys by Offa of Mercia the place changed its name to *Scrobbesbyrig* ('town in the wood'), of which the modern name is a corruption. Thenceforward it has figured often in history, having been visited by most of the English kings, and repeatedly besieged—e.g. by Llewellyn (1215) and the parliamentarians (1644). In the battle of Shrewsbury, fought at Battlefield, 3 miles N.E., on 21st July 1403, Henry IV. (q.v.) routed Hotspur and his confederates. For the earls of Shrewsbury, see TALBOT, and SHEFFIELD.

See works by T. Phillips (1779), H. Owen and J. B. Blakeway (1825), H. Pidgeon (1857), and W. Phillips (1878).

Shrike (*Lanius*), a genus of passerine birds having the bill short and compressed, the upper mandible curved and with a prominent tooth, the base of the bill covered with hairs directed forwards, wings of moderate length, and very powerful feet. They are found in all parts of the world except in South America. They are called Butcher-birds from the habit, common to many species, of impaling their prey upon thorns. The food consists chiefly of insects, but often also of mice, frogs, lizards, and small birds. The Great Gray Shrike



Great Gray Shrike (*Lanius excubitor*).

(*L. excubitor*) visits the British Islands in autumn and winter, but has not been known to breed. It is one of the largest species, its length being 9 to 10 inches. The back is of a light gray colour, wing and tail feathers black tipped with white,

bill and legs brownish black. The Lesser Gray Shrike (*L. minor*) has also been seen in England; but the commonest British species is the Red-backed Shrike (*L. collurio*), which breeds in wooded districts in England and Wales, and occasionally in the south-east of Scotland. The nest is made of twigs and roots, neatly lined with wool and hair. Only one brood is reared, and the birds usually migrate in August. The males of this, and of some other species, have considerable power of song. In Australia the shrikes are represented by the nearly allied Thickheads (*Pachycephala*), which abound in the forests throughout that continent and Oceania.

Shrimp (*Crangon*), a genus of crustaceans, of the order Decapoda, allied to lobsters, crayfish, and prawns. The form is elongated, tapering, and arched as if hunch-backed. The beak is very short, affording a ready distinction from prawns. The forceps are comparatively small. The whole structure is very delicate, almost translucent; and the colours are such that the shrimp may readily escape observation, whether resting on a sandy bottom or swimming through the water. For the change in colour on boiling, see PIGMENTS, Vol. VIII. p. 174. The quick darting movements, like short leaps, betray them to any one who looks attentively into a pool left by the retiring tide on a sandy shore. When alarmed they bury themselves in the sand by a peculiar movement of their fanlike tail. The Common Shrimp (*C. vulgaris*) is very abundant

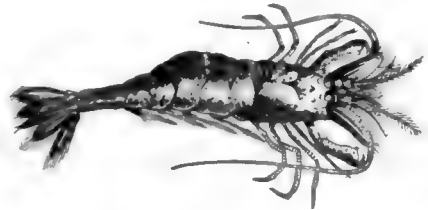

Common Shrimp (*Crangon vulgaris*).

on British and other European coasts wherever the shore is sandy. It is about 2 inches long, of a greenish-gray colour, dotted with brown. It is in great esteem as an article of food, and is generally taken by a net in the form of a wide-mouthed bag, stretched by means of a short cross-beam at the end of a pole, and pushed along by the shrimper wading to the knees. Sometimes a net of larger size is dragged along by two boats. The Skeleton-shrimp or Spectre-shrimp is a small crustacean of the family Caprellidæ (as *Caprella linearis*). The Brine-shrimp (q.v.) is the subject of a separate article. The Fresh-water Shrimp is treated at GAMMARUS.

Shrine, a case or reliquary for containing the Relics (q.v.) of saints and martyrs.

Shropshire, or SALOP, a West Midland county of England, on the Welsh border, bounded by the counties of Cheshire, Stafford, Worcester, Hereford, Radnor, Montgomery, and Denbigh. It measures 50 miles by 41, and has an area of 844,565 acres or 1319 sq. m. The Severn, entering from Montgomeryshire, winds 55 miles across the interior, dividing Shropshire into two pretty equal portions, and being joined here by the Tern, whilst a lower tributary, the Teme, traces much of the southern boundary. Ellesmere (116 acres) is the largest of several lakes. The northern and eastern portion, to the left of the Severn, is level with the exception of the isolated Wrekin (1320 feet), and is occupied by the New Red Sandstone. The south-western portion, belonging to the Old Red and

earlier formations, is rugged and mountainous, and in the Cleve Hills attains 1805 feet. Coalbrookdale is the chief of five coal-fields, and the mineral wealth also includes iron, lead, limestone, and freestone. The soil is variable, but generally fertile and well cultivated, so that only about one-seventh of the whole area is waste, whilst woods and plantations cover 71 sq. m. and orchards 4000 acres. Much attention is paid to live-stock, the cattle exceeding 150,000 and the sheep 430,000. The county, whose council has 68 members, is divided into 14 hundreds and 253 civil parishes. It contains the parliamentary borough of Shrewsbury, the county town, and the municipal boroughs of Bridgnorth, Ludlow, Oswestry, and Wenlock. It returns four members for the Oswestry, Newport, Wellington, and Ludlow divisions. Clive was a native; and historic scenes or antiquities, other than those noticed in the articles on the different towns, are Acton-Burnell, Boscobel, Wroxeter, Watling Street, and Offa's Dyke. Pop. (1801) 169,248; (1841) 225,820; (1871) 248,111; (1891) 236,339.

See works by C. Hulbert (2 vols. 1837), E. Lloyd (1844), R. W. Eyton (12 vols. 1853-60), J. C. Anderson (1864), Mrs F. C. Acton (1868), M. E. C. Walcott (1879), Miss G. Jackson (*Dialect*, 1879-81), and Miss C. Burne (*Folklore*, 1883-85).

Shrovetide, 'shriving-time,' 'absolution-time,' the name given to the days immediately preceding Ash-Wednesday, which, as indeed the whole period after Septuagesima Sunday appears to have been, were anciently days of preparation for the penitential time of Lent. In the modern discipline of the Roman Catholic Church a trace of this is still preserved, as in many countries the time of the confession, which precedes the paschal or Easter communion, commences from Shrovetide. These days were sometimes called Fasting-tide, Fast-mass, Fasten-e'en, or Fastern's-e'en, names still retained in some parts of Great Britain, as *Fastnacht* is the regular German name. The name of Shrovetide was retained in England after the Reformation, although the practice of shriving was abandoned. The duty of confession having been fulfilled, the faithful, upon the eve of entering upon the Lent, were indulged with permission to give themselves up to amusements and to festive celebrations, of which the counterpart is still seen in the continental carnival. In England the pastimes of football, cock-fighting and throwing at cocks, bull-baiting, &c. were long recognised usages of Shrovetide; and the festive banquets of the day are still represented by the pancakes and fritters from which Pancake Tuesday took its name, and by the 'collops' which gave its title to Collop Monday. Shrovetide cakes and ale, the last surviving relic of Shrove Tuesday celebrations, were discontinued by Brasenose College in 1887. The *Mardi Gras* of the French, with its merry-makings, is Shrove Tuesday. It is a popular festival at New Orleans.

Shrub. See RUM. For Shrubs, see TREE.

Shuckford, SAMUEL, Rector of All-Hallows, London (died 14th July 1754), is remembered for his *Sacred and Profane History* (4 vols. 1727), intended as a continuation of the work of Prideaux (q.v.).

Shumla, or SCHUMNA, a city of Bulgaria, by rail 56 miles W. by N. of Varna and 80 SE. of Ruzchuk. Of exceptional strategic importance, it is defended by strong detached forts and a fortified camp, all of which were to have been demolished according to the Berlin treaty, though the clause stipulating this has not been carried out. Shumla is a straggling place, and has numerous mosques and churches, the splendid mausoleum of Hassan Pasha (18th century), an arsenal, numerous

barracks, and a military hospital. It manufactures slippers, clothing, copper wares, and silks. Pop. (1894) 23,520. The fortified works were attacked in vain by the Russians in 1774, in 1810, and in 1828, but were abandoned to them in 1878.

Shusha, a town of Russian Transcaucasia, 65 miles SSW. of Elizabetopol, occupies a strong position on a mountain, which is accessible only on one side, and is, moreover, defended by a citadel. Pop. (1896) 26,800, who make celebrated carpets and coarse silk goods, and trade in horses that are held in great repute.

Shuster, a decayed city of Persia, stands on the Karun, at the point where that river emerges from the hills, 250 miles W. by S. of Isfahan. It is protected by a citadel. It has been identified by some with the ancient city of Susa, but the site of that city is Sus, 40 miles WNW. of Shuster. Pop. 6000.

Shute, JOHN. See BARRINGTON.

Shwan-pan, the Chinese Abacus (q.v.).

Shah-posh ('black-clothed'), a name given by their Moslem neighbours to the pagan Kafirs of Kafiristan (q.v.).

Sialagogues are substances which increase the secretion of saliva. They may do so by stimulating the secretory nerves of the salivary glands reflexly through the sensory nerves of the mouth, stomach, eye, or nose. Thus, sweet or slightly irritating substances in the mouth provoke a secretion of saliva, while the sight or smell of savoury eatables 'makes the teeth water.' These are known as topical sialagogues, and include such substances as mustard, ginger, pellitory-root, dilute acids, &c. Dilute acids and pellitory-root are the only ones which are much used in medicine to increase the flow of saliva and keep the mouth moist; a small piece of the latter is chewed from time to time. Sialagogues also act after absorption into the blood by a direct stimulating action on the secretory nerves. Jaborandi and mercurial compounds are well-known examples of this class. The former, or its alkaloid, pilocarpine, may cause the secretion of a pint or more of saliva within a short time after administration. This class is known as remote or general sialagogues.

Stalkot, a town in the Punjab, near the left bank of the Chenab, 72 miles N. by E. of Lahore, is a rapidly growing, clean, and well-built town, with large manufactures of paper and a native cloth. There are an old fort, gallantly held by a few Europeans in 1857, but now converted into public offices, several shrines sacred to the Sikhs and the Mohammedans, the Punjab military prison, a public garden, &c. Pop. (1881) 45,760; (1891) 55,087, including the cantonment, one mile to the north.—The *district* has an area of 1958 sq. m. and a pop. of 1,250,000.

Siam (native name, *Muang Thai*, 'the Land of the Free') occupies the central portion of the Indo-China Peninsula. Its extreme length stretches from 4° in the Malay Peninsula to Chiengsen (20° 22' N.), on the river Mekhong, or a distance of nearly 1100 miles, and the greatest breadth from E. long. 98° to 106°, or about 530 miles. It is bounded on the south by French Cambodia, the Gulf of Siam, and the British Malay states, and on the west by Burma. The northern frontier was laid down by the Anglo-Siamese Boundary Commission (1890-91); and in 1893 the treaty of Bangkok (supplemented by the Anglo-French treaty of 1896, which guaranteed the neutrality of the great central portion of Siam) conceded to France all the territory between the Mekhong and former Annamese frontier north to the Laos country; so that the Mekhong is now the Siamese boundary on the east

(see map in Vol. II. p. 562). The territory ceded to France may amount to 100,000 sq. m., and its pop. to 100,000. The area of the present kingdom of Siam is about 220,000 sq. m., of which 60,000 are in the Malay Peninsula. The population is estimated at about 12,000,000, of whom about 3 or 4 millions are Siamese, about 3,000,000 Chinese, the remainder being Shans, Laos, Malays, Burmese, and hill tribesmen.

Physical Features.—The Malay Peninsula excluded, the plain of the Menam Valley, the adjoining eastern coast, and the Korat plateau (from 400 to 1000 feet high) occupy the greater portion of the country. These plains are fringed by hills up to 5000 feet high, and the north generally is hilly. The Menam, with a course of about 600 miles, is the principal river. It is formed by the junction of the Meping and Meyome, and at a point 130 miles from the sea it divides itself and falls into the Gulf of Siam by two mouths, the westerly of which is named the Tachin River. Two other streams, the Meklong and the Bangpakong, flow into the Gulf of Siam. The Mekhong (q.v.) or Cambodia has the main part of its course in or along Siamese territory, but navigation for vessels of any size is impeded by rapids, and, commercially speaking, this magnificent river is of little importance at present. The rivers form the principal trade-routes, and in and around Bangkok there is an intricate network of canals. Only the land adjoining the rivers is under cultivation, and the greater portion of the country is covered by pathless jungle.

The climate is considered healthy for the tropics. Low malarial fever is the most frequent illness amongst the European community. There are two seasons—the wet and the dry, the former lasting from May till November, and the latter the rest of the year. The average rainfall is 54 inches per annum, which is slight compared with that of the adjoining countries of Burma and Cochin-China. April is the hottest month of the year, but even then the thermometer rarely rises above 94° in a well-constructed house, and as a rule there are cool breezes at night. The average temperature for the year is 81°.

Productions, Commerce, Exports, and Imports.—The chief production of Siam is rice. It is the national food, and its export forms the great source of wealth of the country. The system of agriculture is of the most primitive kind, but a genial sun, refreshing rains, and alluvial soil combine to produce abundant crops. In 1890, 479,660 tons of rice, valued at £2,508,816, were exported, chiefly to Singapore and Hong-kong for transhipment. This item formed more than two-thirds of the total exports, which amounted to £3,209,621. The other principal exports were teak-wood, obtained in the north, to the value of £200,178, pepper, salt, and dried fish, cattle (for consumption in Singapore), and til (sesame) seed. Goods were imported to the value of £2,631,020. The most valuable items were treasure and gold-leaf, £995,003; cotton manufactures and China goods, £403,184; jewellery, £131,400; opium, £118,292. The principal commerce of the capital is in the hands of Chinese, who own 17 out of a total of 23 steam rice-mills. The labour market is supplied by Chinese coolies, and the best tradespeople and artisans are Chinese. The native Siamese are handicapped to some extent by the requirements of *corvée*, or state labour, but besides they are deficient in that enterprise and energy which are indispensable to successful trading. They confine themselves to agriculture, fishing, boating, and petty hawking, and many are simply idle hangers-on of the nobility. In addition to the exports above mentioned, the country produces hemp, tobacco, cotton, coffee, cardamoms, and many other articles of tropical growth, which are culti-

vated for local consumption only. Tropical fruits are abundant, the most highly prized being the durian, mangosteen, and mango. The banana is cheap and plentiful.

Animals.—The wild elephant, tiger, bear (in the north), wild pig, deer, monkey, and squirrel abound in the distant jungles. Tame elephants are employed for travelling and for labour, especially in the teak forests in the north. Several specimens of the famous 'white elephant' are kept in the courtyard of the royal palace at Bangkok; but they are not, as is popularly supposed, fed from golden dishes, nor are they regarded with any special veneration (see Vol. IV. p. 290). Crocodiles are found at the mouths of the rivers. The python, cobra, reptiles of various kinds, mosquitoes, ants, fireflies, and tropical insects are plentiful. There are many species of birds, and the rivers and coast swarm with excellent fish.

Minerals.—Gold has been produced in Siam from time immemorial; and argentiferous copper also is found. Alluvial tin-mines are worked by Chinese in the Malay Peninsula, and iron is turfed out in the north by native smelters. Rubies and sapphires are found in the Chantaboon district on the east coast of the Gulf of Siam, and the work of mining for these gems is carried on by Burmese immigrants. The country has lately been a field for the researches of mining prospectors, and several concessions, mostly for gold and gems, have been granted to European speculators.

Manufactures.—The Siamese are very deficient in manufacturing arts. The only manufactures are a species of coarse cloth and silk, rough paper made from the bark of a tree, water-jars, and coloured tiles for the roofs of temples. These industries, paltry as they are, are gradually giving way to the import of foreign goods. Native gold- and silver-smiths display considerable ingenuity in their work.

Inhabitants and Customs.—Pure Siamese are estimated to number only a third of the total population. The north and east are occupied by Laos or Shans (q.v.), who are tattooed, and differ somewhat in speech from the Siamese, and besides the Chinese there are considerable numbers of immigrant Burmese, Indians, Malays, and Cambodians. The character of the Siamese is essentially peaceful and indolent. They are very social, vain, and fond of bright dresses and jewellery. Their intercourse with each other is conducted with a ceremonious attention to distinction of rank. They are a small, well-proportioned race, with olive-coloured skin, black hair, slight black moustache, and no beard. They shave the heads of their children, with the exception of a tuft on the crown, which is cut off with great ceremony at the age of puberty. The hair is then allowed to grow in the usual fashion, both sexes being alike closely cropped. The national dress both for men and women consists of a bright-coloured panung—a cotton or silk cloth arranged somewhat in the form of Turkish trousers, and reaching to the knee. Princes and well-to-do people wear in addition a white jacket, often with gold or silver buttons, shoes, and white stockings, while the women are distinguished by a gaudy scarf thrown across the bosom.

The houses are built of wood or bamboo, thatched with the leaf of the attap palm, and are raised a few feet from the ground on piles. Both sides of the river at Bangkok (q.v.) are lined for several miles with houses floating on wooden pontoons or on bundles of bamboo. Furniture there is none, unless a mosquito-net, a mat or two, and cooking and betel utensils be reckoned furniture.

The food of the mass of the people consists simply of rice, curry stuff, a little dried fish, and fruit. Large quantities of tea are consumed in Chinese

fashion without sugar or milk. A spirituous liquor is distilled from rice, but drunkenness is rare. Betel-nut chewing and tobacco-smoking are universal. Children begin to smoke at a very early age, and ladies do not disdain the use of the fragrant weed. Betel-nut discolours the teeth, and this process is often aided by the use of various materials to render them quite black and polished. The characteristic vice of the Siamese is gambling, which can only be carried on in the licensed government gambling houses. At the new-year holidays (in April), and on two or three other public holidays, the people are allowed as a privilege to gamble at home or in the streets.

Marriages are negotiated by elderly women, who find out if the birthdays of the intended bride and bridegroom are suitable—for the Siamese are superstitious in this respect—and arrange the amount of property or money the parents on each side are willing to give to set up the young couple in life. The marriage ceremonies, during which the chewing of betel-nut plays an important part, last two or three days, and all friends are entertained liberally during this time. Priests are sometimes engaged to recite prayers, the bride and bridegroom are sprinkled with consecrated water, and on a favourable astrological day—generally the third—the marriage-bed is prepared by an old couple, friends of the family who have in their time been blessed with a large and prosperous family. Among the poorer classes there is little ceremony. The main feature of the contract is that the swain hands over to his mother-in-law a certain sum of money, which is termed 'ka nam nom,' or price of the mother's milk. Polygamy is universal amongst the wealthy and noble classes.

The system of medicine is curious. The Siamese believe that the arteries are filled with air, and that most diseases are caused by some disturbance in this internal wind. Apoplexy, for example, results from wind blowing upon the heart with sufficient force to rupture it. The vegetable, mineral, and animal kingdoms are largely drawn upon to supply medicines, and the use of such peculiar articles of pharmacy as cat's eyes, bile of snakes, rhinoceros horn, sea-shells, &c. is not despised. Patients are accustomed to take medicines compounded of numerous ingredients and in enormous quantities. It is a painful custom of obstetrics that after the birth of a child the mother lies thirty days roasting before a hot fire. The number of days is diminished with the number of children. The mode of paying doctors might be adopted with advantage elsewhere. A fixed sum is agreed upon for a cure, and if the condition of the patient does not improve, or if he dies, the doctor gets nothing. The dead, after being kept for a period varying from two or three days for a poor man to eight or nine months for a prince, are cremated with much ceremony and at great expense.

Every Siamese, with certain exceptions, is bound to give the state free labour for about three months in the year, and to supply travelling officials with provisions and means of transport when called upon. A form of domestic slavery exists, by which any one borrowing money may offer his person as security. The creditor can put his debtor in chains, if necessary, and compel him to work in his service till the principal is paid off, the value of his labour being reckoned only as interest.

The religion of the country is Buddhism. The sacred books are written in Pali in the Cambodian character, and have been originally brought from Ceylon. All Siamese enter the priesthood for a short time. Priests are clothed in yellow robes, and their heads and eyebrows are shaved. They collect their food from the charitable in the early

morning. The temples are numerous, and they are the only buildings, except the palace, on which any architectural effort has been expended. Their gilded minarets, roofs of coloured tiles, and quaint pagodas draw forth the admiration of the stranger on his arrival at Bangkok.

Government and General Progress.—The old system of first and second kings has been abolished, and the present and only king is Chulalongkorn I. (Phra Paramindr Maha), who was born September 21, 1853, and succeeded to the throne October 1, 1868. He is an amiable but dignified monarch, knows the English language thoroughly, and is possessed by a sincere desire to ameliorate the condition of his country. The eldest son of the queen was nominated crown-prince in 1887, and this innovation will tend to make the throne hereditary, which was not formerly the case. The legislative power is vested in the king in conjunction with a council of ministers, who have charge of the departments of war and marine, foreign affairs, home government, justice, agriculture, royal house, and finance. The country is divided into provinces administered by governors. The ablest of the king's brothers (two full and twenty half-brothers), nearly all English-speaking, fill some of the more important public offices. There is a small permanent army, modelled after the fashion of the British army, and drilled by Europeans. The navy consists of a modern cruiser of 3000 tons, a smaller cruiser, and a few gunboats, despatch vessels, &c.

The government, assisted by many British and other resident officials, has in recent years made rapid strides in reforming the administration. Mr Mitchell Innes, who acted as financial adviser to the king during 1896-97-98, greatly improved that department. The revenues have been increased, are now paid directly into the Treasury and regularly audited, and an annual budget instituted. Judicious expenditure has been made on public works, the Civil List has been put on a definite footing, and all salaries and accounts are paid regularly at fixed intervals, instead of being months in arrear. Taxation is lightened and simplified, so that Siam is now the most lightly taxed country in Asia. In other directions similar reforms are being carried out. Sanitation, education, and the administration of law and justice are all greatly improved. By improvements in forest conservation the teak revenues have been trebled and waste prevented. An improved and now effective police system has had beneficial results in many directions. Bangkok is lit with electricity. Telegraph lines connect Bangkok with Europe *via* Saigon, and also *via* Tavoy in Burma, and with Chiangmai in the north. The postal union was joined in 1885, and a telephone exchange exists in Bangkok. A railway connecting Bangkok with Paknam at the mouth of the river was opened in 1893, and a line to Korat, 165 miles N.E. of Bangkok, slowly constructed; other railway lines (to Burma and the Chinese frontier) have been surveyed. Bangkok has tramways. Education, which is carried on by the priests in the temples, has been supplemented by schools for the teaching of English. Extra-territorial jurisdiction exists in Siam—i.e. foreigners are not subject to Siamese laws, but to the laws of their respective countries administered by consuls.

The revenue is estimated at £2,000,000, and includes £1,000,000 for opium, spirit, gambling, pawnbroking, and other monopolies; £700,000 taxes on houses, shops, boats, fisheries, theatres, &c.; £200,000 land-tax; and £100,000 customs.

History.—Authentic Siamese history does not begin till the year 1350, when Ayuthia (q.v.) was founded. Cambodia was conquered and made tributary in 1532. The period from 1659 to 1688 was

rendered illustrious by the career of Constance Falcon (or Phaulkon), a Greek of Cephalonia, who attained the dignity of prime-minister. He was the king's favourite, and induced that monarch to send an embassy to Louis XIV. Ayuthia remained the capital till 1768, when after a siege of two years it was taken and burned by the Burmese. The invaders were finally driven from the country by a general named Phya Tak, son of a Chinaman by a Siamese mother, who made Bangkok the capital, and afterwards ascended the throne. The present dynasty was founded in 1782.

Language and Literature.—The alphabet consists of forty-four characters and twenty vowel-signs. The language is monosyllabic (the polysyllabic words being borrowed from Pali) and has five tones, which render its acquisition difficult to Europeans. The style in which inferiors address superiors differs considerably from the common language, and the sacred books are written in Pali. Literature is comprised in some volumes of history, medicine, laws, astrology, &c., but it is of no particular value. The Siamese are fond of reading fables, romances, plays, &c., of which there is a cheap and abundant supply.

The principal books on Siam are *La Loubère, Description du Royaume de Siam* (1691); Pallegoix, *Description du Royaume de Siam* (1854); Bowring, *Kingdom and People of Siam* (1857); Mouhot, *Travels in Siam, Cambodia, and Laos* (1864); Bastian, *Die Völker des östlichen Asiens* (1866); Leonowens, *The English Government at the Siamese Court* (1870); Bock, *Temples and Elephants* (1884); Colquhoun, *Amongst the Shans* (1885); Coit, *Siam, or the Heart of Farther India* (New York, 1886); Chevillard, *Siam et les Siamois* (1889); Hallett, *A Thousand Miles on an Elephant* (1889); J. Anderson, *English Intercourse with Siam in the Seventeenth Century* (1890); Mrs Grindrod, *Siam: a Geographical Summary* (1896); Maxwell Sommerville, *Siam: on the Meinam* (1897); H. Warington Smyth, *Four Years in Siam* (2 vols. 1898). See the map at Burma, Vol. II.; the article in the *Times*, 31st January 1899; a series of recent consular reports; and articles on ANNAM, SHANS, and TONG-KING.—The Gulf of Siam is an arm of the China Sea, is bounded on the N. and W. by Siam, and on the E. by Cambodia and Cochinchina. At its entrance it is 250 miles wide, and it extends nearly 400 miles inland.

Siamese Twins, a name given to two children, Eng and Chang, born of Chinese parents in Siam, in 1811, having their bodies united by a band of flesh, stretching from the end of one breast-bone to the same place in the opposite twin. A union of the bodies of twins by various parts is not an unusual occurrence (see MONSTROSITY). The Siamese twins, purchased of their mother at Meklong, were brought to America by Mr Hunter in 1829, and to England afterwards. After realising a competence by the exhibition of themselves in the various countries of Europe, the Siamese twins settled in one of the southern states of America, where they were married to two sisters, and had offspring. Ruined by the civil war in America, the Siamese twins again made the tour of Europe, and exhibited themselves in London again in 1869. They died 17th January 1874, the one surviving the other two hours and a half only, and then dying from the effect of the shock on a heart already weak.

Sibbald, SIR ROBERT, Scottish naturalist and antiquary, was born of Fifehire ancestry at Edinburgh, 15th April 1641. Educated at Edinburgh, Leyden, and Paris, he settled in 1662 as a physician in Edinburgh, devoted much time to botany and zoology, and aided Sir Andrew Balfour in establishing a botanic garden. He was knighted in 1682 and appointed Geographer-royal for Scotland, in 1686 was for a short time a convert to Roman Catholicism, and died about 1722. He published

many pamphlets on medical subjects, natural history, Scottish history, and antiquities.

His writings include *Scotia Illustrata, sive Prodrromus Historiæ Naturalis* (1684); *Collection of Several Treatises in Folio Concerning Scotland, as it was of Old, and also in Later Times* (1707); *A History of Fife and Kinross* (1710); and his *Autobiography* (1833).

Sibbes, RICHARD, Puritan divine, was born the son of an honest wheelwright at Tostock (not Sudbury), Suffolk, in 1577. He was put to Bury school, and afterwards, by the exertions of some friends who saw his promise, was sent to St John's College, Cambridge, as sub-sizar. He graduated B.A. in 1599, was elected Fellow two years after, and was Trinity Lecturer from 1610 till 1615, when he was deprived, as also of his fellowship. But he was at once appointed preacher of Gray's Inn, where he laboured till 1626, when, after declining Usher's offer of the provostship of Trinity College, Dublin, he was made Master of Catharine Hall, Cambridge. He was under the suspicion of Laud, but contrived to escape the penalties inflicted by his courts, and in 1633 was appointed by the king Vicar of Trinity Church. He died 5th July 1635. Fuller tells us Sibbes was most eminent for that grace which is most worth, yet costs the least to keep it, Christian humility, and further, that as a preacher the truth he pressed most urgently on his hearers was the Incarnation. For his heavenly-mindedness he has been called, and not inappropriately, the English Leighton. Among his many books may be named the *Bruised Reed*, which converted Baxter at fifteen; and the *Soul's Conflict*, which Izaak Walton bequeathed to his son, as he did the former to his daughter; *Bowels Opened*; *The Returning Backslider*, &c. There is a complete edition in Nichol's Puritan Divines, with a Life by the Rev. A. B. Grosart (7 vols. 1862-64).

Siberia (*Sibir*), originally the name of a Tartar fort on the Irtysh, is now applied to an immense territory belonging to Russia in northern Asia, bounded by the Ural Mountains on the W.; the Arctic Ocean on the N.; the seas of Behring, Okhotsk, and Japan on the E.; and the Russian provinces of the Kirghiz Steppes and Turkestan, and the Chinese empire (Mongolia and Manchuria) in the S. Taken within these limits Siberia covers an area of no less than 4,833,500 sq. m.—nearly forty times as great as that of the United Kingdom—and has a population of 4,484,550 inhabitants. Its natural divisions, broadly corresponding to the administrative ones, are: *West Siberia*, including the governments of Tobolsk and Tomsk, as also parts of Perm situated on the eastern slope of the Urals; *East Siberia* (governments of Yeniseisk, Irkutsk, Yakutsk, and Transbaikalia); the peninsula of *Kamchatka*; and the *Amar region*, which includes the governments of Amur, Ussuri, the maritime province, and the island of Saghalien (Sakhalin). The group of islands, sometimes from the principal one called Liakhov, have been described at NEW SIBERIA. The areas of the provinces with their populations are given under RUSSIA. Immense parts of this territory are still but very imperfectly mapped, especially in the wildernesses of the north and north-east—a few surveys along the chief rivers and lines of communication being the only sources of information. But the leading features of the network of highlands which covers Siberia can be stated in a few words (see also ASIA, Vol. I. pp. 485-487).

The great plateau of eastern Asia enters Siberia to the east of Lake Baikal, where it attains a height of from 3000 to 4000 feet and a width of nearly 1300 miles, and stretches therefrom, with a gradually decreasing height and width, towards the north-eastern extremity of Asia at the Behring Strait. It is fringed on its south-

western border by the Great Altai and Sayan mountains, which separate Siberia from North-west Mongolia, the Barguzin and the South Muya ridges, and a series of yet unexplored and unnamed ridges stretching farther north in the same direction; while along its south-eastern border it has the Stanovoi Mountains, which rise as a high wall on the coast of the Sea of Okhotsk, and are continued farther south by the Great Khingan. The border-ridges of the lofty plateau are the highest in Siberia, and their peaks attain heights of from 7000 to nearly 11,000 feet, but very few of them penetrate into the region of perpetual snow. Mountains remaining snow-clad all the year round and giving origin to glaciers are met with only in the Altai (q.v.), at the Munku-Sardyk which rises to a height of 10,700 feet amongst the Sayan Mountains to the south-west of Lake Baikal, and in the highlands of the far north-east. In the remainder of Siberia, owing to the dryness of climate, and also perhaps to a warm current flowing in the upper strata of the atmosphere, the perpetual snow-line stands at a great height not attained by peaks 7000 to 9000 feet high. A broad belt of alpine tracts fringes the plateau along its north-western border, assuming a more and more gloomy aspect in proportion as they advance farther north. The whole of this belt is thickly clothed with forests, the summits only of the higher peaks (4500 to 7000 feet) rising beyond the limits of tree-vegetation. The auriferous regions of the Altai, Upper Yeniseisk, Barguzin, and Olekma are situated in this alpine belt. A belt, nearly 500 miles wide, of high plains 1700 to 2500 feet above the sea-level spreads all along the base of the alpine belt, their outer limit being, roughly speaking, a line running from Tomsk towards the north-east. They are very fertile in the south, but of course become less and less suitable for agriculture as they advance into higher latitudes. The whole of West Siberia, between these high plains and the shores of the Arctic Ocean, is an immense lowland which has barely a few hundred feet of altitude and most of which must have emerged from the sea at a quite recent post-glacial epoch. The southern part of these lowlands—the prairies of Ishim, Upper Tobol, and Baraba—is extremely fertile. The soil is a thick layer of black earth, which also penetrates into the lower valleys of the Altai, and the traveller finds there to his astonishment a territory, nearly as large as Great Britain, entirely covered with a luxurious grass-vegetation, with masses of deciduous forest, which is even now the granary of Siberia, and has grain to spare for export to the mines of the Urals. Nearly one-third of the population of Siberia is gathered on those prairies, attaining a density of 20 and 40 inhabitants to the square mile; and the population is more thoroughly Russian than in many parts of European Russia itself, the indigenous population making but two per cent. of the whole.

Farther north, and especially in the space between the Obi and the Irtysh, the country assumes a quite different character; there begin the *urnans*, or immense marshes which cover nearly 100,000 sq. m., entirely clothed with thickets and meagre forests, and quite impracticable in the summer. Even the bear does not venture to cross the marshes when they are not frozen. Agricultural settlements may be found in this region on the banks only of the rivers, while some 30,000 Ostiaks, Voguls, and Samoyedes find scanty means of existence in hunting and fishing. Farther north still begin the *tundras*, which extend along the Arctic seaboard as far as Kamchatka, and cover an aggregate area of some 450,000 sq. m.—more than twice the area of France. The climate of the tundras is really terrible; the average temperatures of De-

ember and January are 15 and 35 degrees below the zero of the Fahrenheit scale; the soil is frozen to a great depth, and only thaws on its surface during the short summer. The trees disappear, only a few species venturing to struggle against the cold by spreading as low bushes or by rising but a couple of inches above the ground. The want of drainage adds to the difficulties which vegetation has to cope with, and only a few flowering plants enliven occasional small patches of better protected and dryer soil. Nevertheless some 50,000 human beings wander over these inhospitable tracts, with reindeers and dogs for dragging the sledges across the wilderness. Of the plateau which fills vast tracts in East Siberia the upper terrace, 3000 to 4000 feet high, is quite unsuitable for agriculture, in consequence of its altitude, cold climate, and want of drainage; in fact, the whole of the Vitim plateau and its continuation towards Kamchatka is quite uninhabited. But its lower terrace, which is 2500 to 3000 feet above the sea and is separated from the upper by the Yablonovoi ridge, offers, especially in Transbaikalia, great facilities for agriculture and cattle-breeding, and is peopled by both Buriats and Russians; while the smaller chains of mountains which intersect it are the seat of rich goldfields, and owing to their richness in copper, iron, and silver will certainly become some day an important centre for mining industry. The Great Khingan, which is continued farther north by the Stanovoi Khrebet and is pierced by the Amur about Kumara, is the south-eastern border-ridge of the great plateau, and it also is fringed on its outer side by an alpine belt of several chains of mountains running parallel to the border of the plateau. Owing to this character, the Stanovoi and the Great Khingan are a most important geographical boundary; properly speaking they separate Siberia from a region which is Manchurian in its physical features. As soon as the traveller has crossed this ridge (which hardly rises as a range of hills above the level of the plateau) and has descended a couple of thousand feet down a very steep slope leading to the basin of the Amur, he sees a complete change of scenery. The oak, the walnut-tree which he has not seen since he left the Urals, the vine, and a variety of bushes and trees belonging to the Manchurian and the Japanese floras suddenly make their appearance. When he has emerged from the alpine belt he finds again the same prairies which he has crossed on the Siberian slope of the plateau, and the climate of these prairies remains as continental and the winters almost as cold as in Siberia proper; but the general character of the flora and fauna is totally changed. In fact it is European no more; the species differ from their European congeners, new genera appear, and even the European species offer notable differences from the types familiar in Europe.

Another belt of high plains, 1500 to 2000 feet high, follows. These prairies, watered by the Zeya and its tributaries, and covered with a very fertile soil and excellent oak forests, are the richest part of the Amur territory, and are being rapidly occupied by immigrants, chiefly sectaries, from Russia, who already number about 60,000, and supply the gold-mines on the slope of the Stanovoi with grain and cattle. The picturesque Little Khingan or Bureya Mountains separate the prairies of the Middle Amur from the lowlands of its lower course. The whole of the latter is only now emerging from the Lacustrine period; immense lakes enclosed within quite flat shores intermingle with swamps; and when the autumn rains, due to the monsoons of the China Sea, swell the waters of the Amur and the Sungari, making of the former a stream several miles wide and covering all its low islands, the whole region

becomes an immense swamp. Various small tribes of Manchurian origin (Golds, Mangoons, &c.) lead a half aquatic existence on the banks of the Lower Amur and its tributaries, while the Russian settlements are reduced to a number of villages built on the river for maintaining communication along its banks. It is on the border of this region that the capital of the Amur territory, Khabarovka, stands at the junction of the Amur with the Usuri. The rocky and inhospitable mountains of Sikhota-alin, intersected by equally low and swampy valleys, fill the remaining space towards the sea-coast—the mountains rising over the sea as a stone wall, almost entirely devoid of indentations. From Khabarovka the valley of the Usuri leads southwards to Lake Khangka and to the fertile tracts on the frontier of Corea, which surround the Gulf of Peter the Great. In that gulf Russia has at Vladivostok a splendid harbour, reminding one by its general aspect of the Golden Horn of Constantinople. A railway, intended to connect Khabarovka with Vladivostok, was begun in 1891 at its southern terminus, and was strenuously carried on notwithstanding the very great difficulties presented by natural obstacles and the scarcity of population. The island of Saghalien and Kamchatka are separately treated.

Rivers.—The rivers of Siberia are of an immense importance for the life of the country. They all take their origin on the plateau, and, after having pierced the surrounding mountains, enter the plains, where they describe great curves and receive numbers of large tributaries before entering the sea. All of them have moreover this feature in common, that each of them is formed by the junction of a pair of great rivers: such are the Obi and the Irtysh, the Yenisei and the Tunguska, the Lena and the Vitim, the Shilka and the Argun which form the Amur. The three former enter the Arctic Ocean, and repeated efforts have been made of late by both Swedish and English explorers and traders to establish a regular communication between Europe and the mouths of the Siberian rivers, *viâ* the Kara Sea, which is now known to be free from ice for a few weeks every year. These efforts have not been lost, as a couple of steamers now reach every year the mouths of either the Obi or the Yenisei, with a cargo of machinery and various manufactured goods. Owing to the great depth of the Siberian rivers, Nordenskiöld was enabled to sail up the Yenisei as far south as 60° N. latitude, while a schooner which was built at Tiumen, on a tributary of the Obi system, could sail to London with a cargo of Siberian wheat. But for the interior communication the rivers are of still greater importance. A line of railway crossing the Urals now connects the Kama, a great tributary of the Volga, with the town Tiumen, and steamers ply regularly from Tiumen to Tomsk, the capital of West Siberia; to Barnaul and Biysk in the Altai Mountains; and to Semipalatinsk in the Kirghiz Steppes. Besides, a canal has recently been dug to connect the Obi with the Yenisei, and, when it has been deepened and some rapids on the Angara have been cleared, goods will be transported from the Urals to Irkutsk, the capital of East Siberia, situated within 40 miles of Lake Baikal. No less than 164 steamers (4000 horse-power) already ply on the Obi and the Irtysh. The Yenisei is also navigated as far as Minusinsk, a small town situated within 300 miles of the Mongolian frontier, in a very fertile region which is often described as the Italy of Siberia on account of its rich vegetation. The Lena is navigated by steamers from Verkholsensk (200 miles N. of Irkutsk) to its mouth—large quantities of corn and various goods being shipped to the gold-mines of the Olekma; smaller steamers also navigate the

Vitim. On the Amur forty-five steamers (2800 horse-power) ply for a distance of 2000 miles, from Sryetensk in Transbaikalia to its mouth; while its tributary, the Usuri, permits steamers to approach within 100 miles of Vladivostok.

Overland communication is maintained by means of post-stations between all the chief towns—the great highway from Russia to the Pacific passing through Tiumen, Omsk, Tomsk, Krasnoyarsk, Irkutsk, Tchita, Blagoveschensk, and Khabarovka, the capitals of all the southern provinces. Communication remains, however, difficult along the Shilka and the Amur, where long distances have to be traversed on horseback, especially when ice is drifting on the river before it is frozen, or when it is about to thaw. Two lines of railway already enter Siberia from the west—the line Perm to Tiumen, not yet connected with the other Russian railways, and the line Ufa to Tchelyabinsk (or Cheliabinsk), which joins at Samara the railway-net of European Russia. The new trans-Siberian railway is a continuation of the latter, and is being built in sections. The easternmost, from Vladivostok to Khabarovka, was laid in 1891-95. In 1896 the western section had been pushed from Tchelyabinsk to the Obi, and from the Obi (not then bridged) to Krasnoiarsk. Its total length, from the Urals, *via* Irkutsk, to Vladivostok, will be 5500 miles, and its cost is estimated at £40,000,000. Chinese concessions in Manchuria (q.v.) shortened the main track, and allowed extensions to Port Arthur on the ice-free China Sea, with ultimate connection to Peking. In 1898 the line was open as far east as Krasnoiarsk.

Climate.—Siberia fully deserves its reputation of being the coldest country of the world. However, with the exception of the Pacific seaboard, it has a much warmer summer than it is generally supposed to have. In the interior of the country one must go as far north as the 60th degree of latitude to find in July an average temperature of less than 60°; while in moderate latitudes July has an average temperature of from 61° to 67°, and 69° on the Middle Amur. The hot summer and a cloudless, bright sky favour vegetation, and one learns to his astonishment that melons are grown in the open air in the steppes of Minusinsk and Irkutsk, or that barley which has been sown in May about Yakutsk (62° 2' N. lat.) ripens by the end of August. But the summer is short, as a rule, and cold weather sets in very rapidly. Night frosts are usual in September, and in November all rivers are frozen; even the Baikal becomes a highway for sledges in January. In November, even in South Siberia, the mercury of the thermometer is occasionally frozen, and in December and January it remains frozen for weeks. The spring begins in April or May, according to the latitude, and is very pleasant, though it still freezes hard at night; but in the second half of May, when all fruit-trees are in full blossom, there is a sudden return of cold which prevents apples and pears from being grown in Siberia. In the far north the cold is really terrible, and Verkhoyansk, although its latitude is only 67° 34' N., is the cold pole of the eastern part of the northern hemisphere. Temperatures as low as -75° and -85° F. have been measured at Verkhoyansk and Yakutsk. Man certainly could not stand such low temperatures, were it not for the dryness of the atmosphere and the absence of wind during the great frosts, which render them more supportable than might be supposed. Not so with the snowstorms, which are frequent by the end of the winter, and are most dangerous to both man and cattle.

Population.—The population of Siberia is very unequally distributed over the territory. As already mentioned, there are from 20 to 40 inhabitants

to the square mile in parts of South Tomsk and Tobolsk, while the deserts of the far north are almost uninhabited. The total population of Siberia, which was less than 1 million at the beginning of the 19th century, had in 1897 attained 5,727,090, and it is yearly increased by some 50,000 new immigrants coming from Russia; so that in western Siberia a want of free land available for agriculture is already felt by the new-comers. The Russians in Siberia proper already number more than 3,800,000. They occupy the best parts of the territory in the south, as well as the valleys of the chief rivers. The indigenous population, barbarously exterminated by the Turkish and Mongolian conquerors of the country in the 12th and 13th centuries, and by the Russian conquerors in the 17th and 18th centuries, hardly numbers now 700,000; whole tribes have almost entirely disappeared. The natives belong to various stocks: the Ugrian stock is represented by the Voguls, the Ostiaks, and the Samoyedes on the slopes of the Urals. Various small stems of Turkish origin inhabit the slopes of the Altai and Sayan mountains; they number about 80,000; while the Yakuts, belonging to the same stock, number no less than 200,000. The Mongolian race is represented by the Kalmucks (about 20,000 in the Altai), the Buriats (250,000) around Lake Baikal, and the Tunguses (about 50,000), who lead a nomad existence in the mountains of East Siberia and the Amur region. Nearly 15,000 Manchurians and Chinese continue to stay on Russian territory of the Amur and Usuri; and more than 3000 Coreans are settled around the Gulf of Peter the Great. Finally, in the north-east there are several stems usually described as Hyperboreans and akin to the Eskimos: the Tchuktehis (12,000), the Koryaks (5000), and the Kamchadales (3000). On the Lower Amur we find the Ghilyaks (about 5000), and in the island of Saghalien the Ainos (3000). The condition of the aborigines is altogether precarious; their hunting and grazing grounds are constantly invaded by Russian settlers, and they themselves become an easy prey to the traders, who enslave them by means of loans of food, gunpowder, &c. The numbers of most of them, save the Yakuts and the Buriats, are declining, and some stems will soon totally disappear—a fact which is much to be regretted, because their children, when they have received education in Russian schools, generally prove to be useful workers in various branches of science and art. As to the Russians in Siberia, the old stock of early settlers, chiefly of North Russian origin, differ a good deal from the bulk of the Great Russians. Not having known serfdom (only 8000 peasants in West Siberia and 20,000 peasants who belonged to the emperor's mines in East Siberia were serfs in 1861), they are of a more independent spirit; but these descendants of the Novgorodian traders also are much more individualistic and almost devoid of poetical gifts, though very successful as a rule in exact sciences. The chemist Mendeleeff, the historian Schapoff, the zoologist Polyakoff, and several other men of mark are of Siberian extraction. On the outskirts of the continent the Russians, especially during the first centuries of the conquest, underwent a good deal of mixture with the aborigines—Samoyedes, Ostiaks, Buriats, and Yakuts.

A great variety of religions are met with in Siberia. The Russians belong chiefly to the Greek Orthodox faith, or rather to some of the nonconformist sects, the very making of Siberia being due to the emigration of dissenters persecuted by government in their mother-country, as well as to the runaway serfs, and at a later epoch, to the desire of avoiding military service. Most Turkish tribes profess the Mohammedan faith, which is

steadily winning new converts. The Buriats profess Buddhism; and most Ugrian and Finnish stems, as well as the Hyperboreans, are Shamanists. Christianity is making but very slow and nominal progress.

Exiles.—The rapid increase of population which has taken place in the last quarter of the 19th century is chiefly due to free immigration. As to the exiles, of whom no less than a million have been transported to Siberia since 1840, and who are transported now to the number of 20,000 every year, they have contributed but little to the increase of the settled population. After having been kept for a number of years in prisons in complete idleness, and spent a couple of years on the journey, large parts of which are still made on foot, they are quite unable to become regular agriculturists. They look upon Russia as their mother-country, and very many of them make an attempt to return to their native villages. They run away, wander on foot through the forests, and, after having been re-arrested and brought back to their settlements, they repeat again and again the attempt on the next opportunity. Others join the ranks of the floating population, and perish in numbers on long pedestrian journeys to and from the gold-mines.

Agriculture, Industry.—Agriculture and cattle-breeding are the chief occupations. The regions of Tomsk, South Tobolsk, Minusinsk, Irkutsk, and Middle Amur produce more corn than is wanted for the population, and export some. It may be taken that the annual production of all sorts of corn (summer wheat, rye, oats, and barley) in an average year amounts to or exceeds 7,000,000 quarters in West Siberia, and 4,500,000 quarters in East Siberia. Cattle-breeding is extensively carried on, especially in the steppes of the east. It is roughly estimated that there are about 2,000,000 horses, 1,500,000 head of horned cattle, 3,000,000 sheep, and 100,000 reindeer in West Siberia, and about 850,000 horses, 1,100,000 horned cattle, 1,120,000 sheep, and 50,000 reindeer in East Siberia. Hunting continues to be profitable in some parts of the territory, notwithstanding the reckless extermination of wild animals and burning of forests which have been going on for three hundred years. Sables, Arctic foxes, and gray foxes become rare; so that squirrels, common foxes, bears, deer, and antelopes, as also some ermines and a few beavers in the north-east, are the chief object of the hunter. Even the sables which were so numerous on the Amur when the Russians first occupied it are rapidly being exterminated. Fishing is extensively carried on on Lake Baikal, the Amur, the Obi, and other rivers. Industry is in its childhood. With the exception of the Tiumen region, where some carpets are woven in the peasants' houses, and a few domestic trades are resorted to in the winter, the Russians in Siberia do not carry on the domestic industries so characteristic of middle Russia. In Transbaikalia the want of the simplest technical knowledge is simply astonishing. Therefore, although Siberia has all the raw produce that may be wanted for the development of a prosperous industrial activity, the want of technical skill prevents the growth of industries. It must also be said that the prospects of a sudden enrichment in the lottery of gold-mining diverts the attention of the population and the few capitalists from the surer industrial pursuits, and that the first steps in that direction are beset with difficulties in a country devoid of railways, domestic industries, and technical schools. Yet the influence of the mining and industrial centres of the Urals is already felt in West Siberia. Tiumen has its establishments in which steamers provided with all modern fittings are built with full success.

Although Siberia is very rich in all kinds of ores, the same causes prevent the development of rational mining, which still remains chiefly limited to gold-washing, very primitive in most cases, and only here and there supplied with modern machinery. The production of gold is considerable. In the period 1860-90 no less than from 404 to 584 cwt. of gold annually were obtained in East Siberia, and 48 cwt. in West Siberia, exclusive of Perm. In 1888 the figures of extraction of gold were: Tomsk, 43 cwt.; Yeniseisk and Irkutsk, 98; Transbaikalia, 56; Yakutsk, 149; Amur, 125. Silver is extracted in the Altai to the amount of from 130 to 300 cwt. every year; lead, 3250 cwt. in the Altai, and 232 cwt. in Nertchinsk; copper, 5800 to 7740 cwt. in Altai; iron, 97,000 to 130,000 cwt., to which the considerable production of the ironworks of the eastern slope of the Urals ought to be added.

Education still stands at a very low level, the total numbers of pupils in schools throughout Siberia hardly exceeding 60,000 boys and girls. A university has been opened at Tomsk (1888), after much opposition on behalf of the government, but it has only two faculties, medical and juridical. In the chief towns of each province there are gymnasia in which some education on classical lines is given, but primary and technical education is in great neglect. The technical society of Irkutsk has, however, made some progress in the latter direction. The geographical societies at Omsk and at Irkutsk are known for their scientific publications. Natural science and anthropological museums have been opened of late by some exiles, and those of Irkutsk, Minusinsk, and Yeniseisk contain valuable collections.

History.—The earliest history of Siberia is still imperfectly known, and the numberless tumuli scattered over its surface only begin to be scientifically explored. The earliest inhabitants seem to have belonged to a stock different from the Ural-Altaians, and are described by Radloff as Yeniseians. They were followed by the Ugro-Samoyedes, whose bronze ornaments buried in the tumuli testify to a high pitch of artistic skill. They were subdued in the 11th century by Turkish invaders, who themselves were conquered, two centuries later, by the Mongols. The latter swept away the previous civilisation. The Russians, who vaguely knew Siberia since the 11th century through the Novgorodian merchants, began the conquest of the territory in 1580, when a band of Cossack robbers under Yermak subdued the Tartars on the Tobol River. New and new bands of Cossacks, traders, and hunters, supported by the Moscow government and followed by dissenters flying from religious persecution and peasants escaping from serfdom, poured into Siberia during the next two centuries. The Cossacks took possession of the country, and reached the coasts of the Sea of Okhotsk within the first eighty years after Yermak's expedition. In 1643-50 they also took possession of the Amur, but were compelled by the Chinese to abandon their settlements and forts (1689). The estuary of the Amur was discovered in 1849, and a military post established at the mouth of the river in 1851. The left bank of the Amur and the right bank of the Usuri were annexed in 1853-57; a chain of villages was built along both rivers, and the 'accomplished fact' was recognised by China in 1857 and 1860. The Behring Strait was discovered in 1648 by the Cossack Dejneff, who sailed that year around the north-eastern extremity of Asia; but the fact remained unknown, and the scientific discovery of the passage between Asia and America belongs to Behring. The first circumnavigation of Asia was, however, not accomplished till 1878-79, when Nordenskiöld, on board the *Vega*, sailed through the Arctic Ocean, wintered

on the Siberian coast, entered next spring the Behring Strait, and returned to Sweden *via* the Japanese and Chinese Seas, the Indian Ocean, and the Suez Canal.

The *Géographie Universelle* of Élisée Reclus, vol. vi. (English trans. by Professor Keane), is the best source of general information in English. See also Ravenstein's *Russians on the Amur* (1861); Seeböhm's *Siberia in Asia* (1882); Lansdell's *Through Siberia* (1882); Kennan's *Tent Life in Siberia* (New York, 1870), and *Siberia and the Exile System* (1891); Radloff's *Aus Sibirien* (1884), and other works; H. de Windt, *Siberia as It is* (1891); J. Y. Simpson, *Side-Lights on Siberia* (1898). Of numberless Russian works, see 'Picturesque Russia,' by various writers, and Yadrintseff on 'Siberia as a Colony' (German trans. 1886).

Sibi, a pass, town, and district, in British Beluchistan, on the Afghan frontier. The town, which is 72 miles SE. of Quetta and has a station on the Sind and Pishin Valley Railway, is the residence of a British political agent. The inhabitants of the district, mostly Pathans and Beluchis, number about 14,000.

Sibyl, the name given in antiquity to certain inspired prophetesses, whether Apollo's mistresses or daughters, or merely his priestesses. The name is explained by Lactantius on authority of Varro as made up of the Doric *sios* = *theos* and *bylē* = *boulē*; Maas tries to connect it with the Eastern *Saba* or *Sabar*; Bang makes bold to connect it with the *Volva* and *Voluspá* of the Old Norse Sagas. Their number is differently given; some writers—Ælian and Pausanias, for example—mention only four, the Erythræan, the Samian, the Egyptian, and the Sardinian; Aristophanes and Plato use the word in the singular number only; but in general ten are reckoned, as by Varro—the Babylonian, the Libyan, the Delphian, the Cimærian, the Erythræan, the Samian, the Cumaean, the Trojan or Hellespontine, the Phrygian, and the Tiburtine. Of these by far the most celebrated is the Cumæan, identified by Aristotle with the Erythræan, and personally known by the names of Herophile, Demo, Phemonoë, Deiphobe, Demophile, and Amalthæa. She figures prominently in the 6th book of Virgil's *Æneid*, as the conductor of the poet into the realm of the shades. Livy records the legend that she came from the east, appeared before King Tarquin, and offered him nine books for sale. The price demanded appeared so exorbitant that the king refused to purchase them. She then went away, destroyed three, and returning, asked as much for the remaining six as for the nine. This was again refused, whereupon she destroyed other three, and once more offered to sell him the remainder, but still at the same price asked at first. Tarquin was struck by her pertinacity, and bought the books, which were found to contain oracular advices regarding the religion and policy of the Romans. They were preserved in a subterranean chamber of the temple of Jupiter on the Capitoline, and were originally entrusted to two officials (*duumviri sacrorum*), appointed by the senate, who alone had the right to inspect them. The number of keepers was afterwards increased to ten (*decemviri*), and finally by Sulla to fifteen (*quindecimviri*). In the year 83 B.C., the temple of Jupiter having been consumed by fire, the original Sibylline books or leaves were destroyed, whereupon a special embassy was despatched by the senate to all the cities of Greece, Italy, and Asia Minor, to collect such as were current in these regions. The new collection, of about a thousand lines, was deposited in the rebuilt temple of Jupiter, but was transferred in 12 B.C. by Augustus as *pontifex* to the temple of Apollo on the Palatine, where it remained till it was publicly burned by Stilicho, between

404 and 408. Many spurious Sibylline prophecies in private hands were taken by Augustus and burned. Quite distinct are the fourteen books of so-called *Sibylline Oracles* in Greek hexameters (over 4000 lines), a series of pretended prophecies written by Alexandrine Jews and Christians, in the interest of their faiths, and supposed to date from the 2d century B.C. down to the 3d century A.D., or, according to Ewald, even the 6th. The origin and signification of many passages have caused fierce discussion, but beyond doubt many are plainly Jewish and pre-Christian, others as plainly Christian. One passage in the eighth book (217-250) touched powerfully the imagination of that Christian world which found no difficulty in reading Messianic prophecy into the vague spirituality of the fourth eclogue of Virgil. This passage, alone in the whole series, is written acrostically, like all the Sibylline verses of Rome, the initials forming the Greek words for Jesus Christ, Son of God, Saviour, Cross. It is alluded to in the *De Civitate* of Augustine, and we find it again in the solemn Sequence of Thomas of Celano: 'Dies ire, dies illa Solvet sacrum in favilla, Teste David cum Sibylla.' And it was the same sense of mysterious continuity between the ancient order and the new that gave so rich a motive to mediæval art in masterpieces by Giotto, Michelangelo, and Raphael.

Editions of these so-called *Sibyllina* are by Alexandre (Paris, 1841-56), a monument of erudition, the second volume with an exhaustive commentary; Friedlieb (Leip. 1852); A. Rzach (Vienna, 1891); and H. Diels (Berl. 1891). See works devoted to discussion of the question by Ewald (1858), Dechent (*Zeitschr. für Kirchengesch.*, 1878), Badt (1869 and 1878, the latter an edition of book iv.), Maas (1879), and Bang (trans. by Poestion, 1880); also an admirable article in the *Edin. Review* for July 1877.

Sicilian Vespers, the name given to the massacre of the French in Sicily on Easter Monday (March 30) 1282, the signal for the commencement of which was the first stroke of the vesper-bell. Charles of Anjou, brother of Louis IX. of France, had deprived the Hohenstaufen dynasty of Naples and Sicily; but his cruelty and tyranny, his oppressive taxation, and the brutality of his followers excited among the Sicilians the deadliest animosity. So on that evening the inhabitants of Palermo, enraged (according to the common story) at a gross outrage offered by a French soldier to a young Sicilian bride, suddenly rose against their oppressors, and put to the sword every man, woman, and child to the number of 8000. This example was followed by Messina and the other towns, and the massacre became general throughout the island: the French were hunted like wild beasts, and dragged even from the churches. The 600th anniversary of the Sicilian Vespers was celebrated with much enthusiasm in 1882, Garibaldi (shortly before his death) having come to Palermo on purpose to be present, though he was too feeble to take part in the ceremonies. See Amari, *La Guerra del Vespro Siciliano* (Eng. trans. by Earl of Ellesmere, 1850).

Sicily, the largest, most fertile, and most populous island in the Mediterranean Sea, lies in 36° 38'—38° 18' N. lat. and 12° 19'—15° 42' E. long., and is separated from the mainland of Italy by the narrow Strait (*faro*) of Messina (2 miles wide). Its shape roughly resembles a triangle (whence the early Greek navigators gave it the name of *Trinacria*, the 'Three-cornered')—the eastern coast, from Capo di Faro in the north to Capo Passaro in the south, forming the base, and the northern and south-western coasts the sides, which gradually approach each other towards the north-west. Area, 9828 sq. m. (one-third that of Scotland); of the *compartimento* (including adjacent islands), 9936

sq. m. Pop. (1881) 2,927,901; (1890) 3,285,472. Capo Passaro, at the south-eastern extremity, is only 56 miles from Malta; and Capo Boco, near Marsala, at the western, only 80 miles from Cape Bon on the African coast. The Strait of Messina is nearly everywhere over 150 fathoms deep; but its narrowness and the conformity of the geological structure on both shores bear witness that the island was formerly a part of the mainland with which it has always been so closely connected politically. Of fourteen new forts for the protection of Messina and the straits the most were finished by 1895.

Sicily is for the most part a plateau from 500 to 1900 feet above the level of the sea, and traversed throughout its northern half by a chain of mountains. The north and east coasts are steep and rocky, the south and west generally flat; the best harbours and the shortest rivers are found in the north. The mountain-chain may be looked upon as a continuation of the Apennines (q.v.). Beginning at Capo di Faro on the Strait of Messina, it runs in a south-south-westerly direction as far as Taormina, where it turns off to the west, and stretches across the whole island. The first part of the chain, from Capo di Faro to Taormina, is called the Peloritian range, which in Monte Dinnamari attains the height of 3700 feet. The second and much the longer part is called the Nebrobian range; near the middle of the north coast it receives the local name of Le Madonie, and rises in the Pizzo d'Antenna to 6467 feet (the highest point in the island except Etna). Immediately to the west of the Madonie there is a notable depression, whose waters are carried off by the rivers Grande and Salso to the north and south coasts respectively; beyond this point the mountains for some distance maintain the character of a chain, but gradually lose this and break up into irregular and often detached masses, ending in the precipitous walls of Monte San Giuliano (ancient *Eryx*, 2464 feet), which rises straight from the sea. About the centre of the chain a range branches off through the heart of the island to the south-east—at first wild and rugged, but afterwards smoothing down into tablelands, which in turn slope away tamely to the sea. There are innumerable other spurs to the south from the great northern chain, which rise in several peaks to over 5000 feet: Monte Cammarata reaches 5177 and Rocca Busambra 5299 feet. Tertiary limestones occupy most of the island; the Nebrobian rocks are mainly of Oligocene date. The lower mountain-slopes are in general covered with groves of oranges and olives, and most of the plateau with fields of wheat. The only extensive plain of special note is that of Catania (given up to vineyards), out of which Etna (q.v.) rises to a height of 10,850 feet, with a base 400 sq. m. in extent. Although rivers are numerous, none are navigable. The principal perennial streams are the Simeto, the Salso, the Platani, and the Belici. The largest lake is the Lago di Lentini, near the east coast, which has an area of less than 4½ sq. m.

The climate of Sicily is warm and equable, especially on the north and east coasts. The mean temperature in the years 1871-86 ranged from 45° F. in winter to 79° in summer; during the same period the extremes recorded were 25° (Caltanissetta) and 118° (Palermo); but only for brief periods does the dry parching Sirocco (q.v.), chiefly in the spring and early autumn, drive the thermometer up to over 100°. Snow seldom falls in the lowlands; on the Madonie, however, it lies till June, and on Etna till July; and the temperature in winter in the wretched mountain towns is often bitterly cold. The reckless destruction of the forests, for which the whole island anciently was famed, has wrought serious injury to both the

climate and the soil. This process is still going on, and little is done in the way of reforestation; yet magnificent relics of the primeval forests of oak and ilex are left on the Madonie and elsewhere, and in some districts beeches clothe the mountains to their very summits, and chestnuts, pines, and enormous holly-trees flourish; on the other hand, wide tracts have been reduced to absolute sterility by the destruction of the woodlands. Malaria is endemic in many parts—sometimes more so in the uplands than upon the coast. Nearly all the rain falls in the winter months, when the rivers are swollen to destructive torrents; in the long summer there are usually three months of drought, most of the streams dry up, and the hillsides and plains are turned to brown, sunburnt deserts. Nevertheless the soil is naturally so fertile that even these causes and the ignorance and primitive methods of the people have not yet destroyed its marvellous productive power. Vegetation is everywhere luxuriant. Dwarf-palms abound, in the south-west especially, and dates, Indian figs, agaves, prickly pears, oranges, lemons, olives, almonds, pomegranates, mulberries, and grapes are all largely grown. Sicily's wheat still represents a seventh of that of all Italy; and of the kingdom's barley, though the figures are much smaller, it raises one-half. Formerly corn was grown and exported at a profit; but of late years this can no longer be done, and to-day the island's chief agricultural products are grapes, oranges and lemons, and sumach. It sends out two-thirds of Italy's wine, which till the rupture of the commercial treaty with France (see ITALY, Vol. VI. p. 244) was mainly exported thither for mixing purposes; of 'green fruit' it yields nearly nine-tenths of all the Italian crop, and sends large quantities to the United States and to Britain; and sumach, for tanning, is exported to the value of nearly a million sterling. But the Sicilians will change neither the methods nor the implements of their fathers. In many districts the soil is enfeebled by being perpetually cropped with wheat, and only the rich supply of sunshine saves it from exhaustion; artificial manures are unknown, and good systems of irrigation and of rotation of crops are even more needed than the introduction of agricultural machinery. At present ploughs of rough-hewn branches, the wooden share thinly shod with iron, are in use, and the corn is usually threshed on the smoothest spot in or near the field—trampled by oxen and horses, who drag heavy stones after them—and winnowed by being thrown into the air. Cattle-rearing, in the usual sense of that term, is not attempted. Oxen and cows are bred for purposes of labour, not for the market or the dairy, and are sent old from the cart or plough to the butcher. But indeed in the interior little meat is eaten at all. Sicilian mutton is as tough as the beef, and has besides a very rank, woolly flavour. Goats are much more common than sheep, and pigs are reared in great numbers in the mountainous tracts, and in the small towns overrun the streets and act as scavengers. There is no regular pasturage for flocks and herds, which live entirely in the open air, and usually gather a subsistence as they can; when straw and cactus-leaves fail they are in some parts fed on the rinds of oranges and lemons. Butter, mostly imported in tins, is known only in the large towns, and the cheeses of the island, chiefly made from goats' and ewes' milk, are hard and bitter.

After agriculture the production of sulphur is the most important occupation. This is the only mineral product obtained on a large scale, and forms the essential resource of Sicily; but it too is separated from the ore by a very primitive process. There are some 300 mines in the island, and 350,000

tons have been exported in a year; in 1888, however, when the lowest record was touched, the export fell to about half this amount. The rich deposits of rock-salt are scarcely worked at all, though bay-salt is largely made in the salt-pans on the east and west coasts. Fishing, especially for the sardine and tunny, occupies a large number of the people; the coral-fishery has greatly declined. Amber is found and worked in Catania. Manufactures are few and of little consequence—some machinery, cement, crockery, gloves, macaroni, and soap nearly exhaust the list. Commerce is mainly in the hands of English, Germans, and Swiss. Over 30,000 vessels yearly enter the sixty ports, and trade as a whole has developed rapidly since 1860. It is, however, much hampered in the interior by the scarcity of good roads—the whole island in 1889 boasted only 3200 miles; 611 miles of railway were built between 1863 and 1890.

As a consequence of the successive foreign settlements on the island the population is rather a conglomerate one; in the east the Greek element prevails, and the people are superior to those in the west, where Arab blood is strongest. In some places in the interior the dialect of the Lombards survives in their descendants, and near Palermo (Piana dei Greci, &c.) both Greek usages and Greek costumes are to be found. The general dialect of the island differs markedly from that of the mainland, as does also the appearance of the country. Most of the farms are small; but in any case the traveller cannot but be struck with the absence of farm-buildings and houses. The labourers as a rule herd in the small towns, walking wherever possible to their work every morning, and otherwise, in spring and harvest, sleeping during the week in temporary conical huts of straw. The crops are guarded, and the losses of tenants from predatory animals, &c. certified, by mounted guards in the pay and uniform of the chief proprietors. Wages range from 1s. to 2s. per day, without food; the peasant seldom tastes even goat's flesh, and lives on black bread, onions, beans, herbs, prickly pears, bitter cheese, and weak wine; the boy swineherds receive only bread, and find water for themselves. The houses of these labourers consist usually of one room in a town perched on the top of a hill or mountain, shared with such poultry and pigs as they may have; the place is dirty, cold, with a tiled roof through which the smoke escapes and the rain enters, the bed being, when possible, sheltered by a strip of matting. The roadway in front commonly serves for latrine and dressing-room. The houses of the craftsmen are no cleaner, but possess tiled floors and more decent furniture. As for the better classes, they are confined to the cities: there are proprietors in Sicily, but no country gentlemen, nor any houses for them; country life there is absolutely none. Even market-towns are unknown; only sometimes fairs are held in the interior. But in spite of his wretched life, labouring from sunrise to sunset all through the year, and steeped in poverty to the lips, the Sicilian is manly and independent, good-humoured and obliging, prudent and steady in his habits. Under proper direction he will work hard and cheerfully, and his patience and resignation to his lot are truly Oriental: 'come Dio vuole' is but the 'kismet' spirit localised. He is also, however, deceitful, taking pride in his cunning, is heartlessly cruel to animals ('they are not baptised,' he explains), and can be sullen and treacherous and vindictive. In homicides, which occur almost daily, Sicily leads the rest of Italy; and robberies and thefts are very frequent. Brigandage on the grand scale has been put down, but cases of less note do occur still from time to time, and bands of highwaymen occasionally attack even carriages

escorted by carabinieri. The Mafia (q.v.) is not dead yet, and the vendetta (worn down by affectionate familiarity to 'vinnitta') is preferred to more legal methods of punishment. This state of things is largely to be traced to the low rate of wages and the excessive taxes, and to the deficient administration of justice; the two former causes certainly are responsible for the emigration of thousands of Sicilians every year to America. In religion the people are devout, and superstitious to a degree. They are very illiterate; three in every four can neither read nor write. Education is free and compulsory, but the law is not very strictly enforced. In 1895 there were 3500 elementary schools in the island, 13 normal schools, 67 'licei,' &c., 46 technical schools, besides government technical institutes, industrial schools, schools of mercantile marine, a military college at Palermo, a government conservatoire at Palermo, schools of agriculture and universities at Catania, Messina, and Palermo. The island is divided into seven provinces (see ITALY), and its chief towns are Palermo (pop. in 1897, 283,700), Messina (150,800), and Catania (127,100).

See Franchetti and Sonnino, *La Sicilia nel 1876* (1877); German works by Hoffweiler (1870), Th. Fischer (1877), Von Adrian (1878), Von Lasaulx (1879), Gregorovius (7th ed. 1895), Schneegans (1889), and Gsell Fels (1889); Mrs F. Elliott, *Diary of an Idle Woman in Sicily* (1881); G. Chiesi, *La Sicilia Illustrata* (1892); René Bazin, *Sicile* (1892); W. A. Paton, *Picturesque Sicily* (1898); besides the *Annuario Statistico Italiano* and the Consular Reports.

History.—The earliest inhabitants of Sicily of whom we know anything were the Sicani, who may have been an aboriginal pre-Aryan people like the Ligurians, Iberians, or the still surviving Basques. Somewhere about the 11th century B.C. the Siculi, most probably an Aryan race, were believed to have crossed the strait from Italy; and we hear of yet another early stock mainly in the north-eastern corner, the Elymoi, whose towns of Segesta and Eryx showed a considerable progress in civilisation. The Phœnicians from an early period began to make settlements—Motya and Panormus—mostly on the north and north-west coasts, for the purposes of commerce; but the real civilisers of Sicily were the colonies of immigrant Greeks, both Dorian and Ionian, who founded a number of flourishing cities on the east and south coasts, such as Naxos (735 B.C.), Syracuse (734), Leontini and Catania (730), Megara Hyblæa (726), Gela (690), Himera (648), Zancle, or Messina (date uncertain), Selinus (c. 628), Agrigentum (579). These Greek settlers became known as Sikeliots, in distinction to the native Siculi, with whom, however, they gradually became assimilated. Their cities were long independent, and flourished first under oligarchical constitutions, then under the short-lived rule of a succession of more or less enlightened tyrants like Phalaris and Theron of Agrigentum, and Gelon, who in 485 transferred the seat of his power from Gela to Syracuse, thereafter the first city of the island. The inevitable struggle with Carthage soon began, and its first stage was closed for seventy years by the great victory of Himera (480), won over Hamilcar on the same day as Salamis, by the united power of Gelon and Theron. The long Peloponnesian war and the intrigues of the mother-cities in Greece drew Sicily into the current of Greek history, but the fatal Athenian expedition to Syracuse (415-413) under Nicias (q.v.) ended for ever the Athenian dream of a wider empire in the west. Next followed a Phœnician invasion under Hannibal, grandson of the Hamilcar who perished at Himera. His course of conquest was facilitated by internal jealousies, and he took in turn Selinus, Himera, and Agrigentum, leaving behind

him nothing but smoking ruins. Their strong fortress of Lilybæum was founded about 397. But the vigorous reign of Dionysius the Tyrant at Syracuse (405-367) put a check to Carthaginian conquest. He fought Carthage in four wars, and carried his conquests into Southern Italy. After the tyranny of Dionysius and his son followed Dion and Timoleon, next the splendid but fatal reign of Agathocles (317-289). The Sicilian war of Pyrrhus of Epirus (278-276) was but the prelude to the long struggle between Rome and Carthage, the first stage of which was the war for Sicily. First Carthaginian Sicily in 246, then the whole island in 210 passed into a Roman province, on the death of Hieron, for fifty years a steadfast ally of Rome. The chief events in Sicily's Roman history were the two insurrections of slaves (135-132 and 102-99), the infamous pro-pretorship of Verres (73-71), its occupation by Sextus Pompeius (42), the conquest by the Vandal Genseric (440 A.D.), his cession of the island to Theodoric, and its recovery to the eastern empire by Belisarius (535). So it remained till 827, the date of the beginning of the Saracen occupation. Syracuse itself was taken in 877; the last stronghold, Rametta, fell in 965. For nearly a hundred years the Moslem rule was not seriously disturbed, but at length George Maniakes was sent by the eastern empire to win back the island (1038). His army included many Normans, who saw with eager eyes the goodness of the land. Town after town was taken—Messana, Syracuse, all save Panormus. The recall of Maniakes brought back a return wave of Saracen conquest, but at length, after much hard fighting, the Normans conquered the whole island; Panormus (Palermo) fell in 1071; Syracuse in 1085; Rametta (Noto), the last stronghold to hold out, in 1090. Robert Guiscard, son of Tancred of Hauteville, now took the title of Duke of Apulia and Calabria; his brother Roger, that of Count of Sicily. The Norman dominions were united under his son Roger, the great Count of Sicily, who took the title at Palermo in 1130 of 'King of Sicily and Italy.' He was followed by William the Bad (1154-66) and William the Good (1166-89), on whose death childless the Sicilians chose Tancred, an illegitimate grandson of King Roger. But Tancred died in 1194, whereupon the crown fell to the German Emperor Henry VI., who had married Constance, daughter of King Roger I. Henry forced the Sicilians to acknowledge him as king, and died in 1197, leaving the kingdom to his son Frederick, afterwards the famous Emperor Frederick II. On his death in 1250 the succession fell to his son Conrad, next to his grandson Conradin, under whom Frederick's natural son Manfred governed Sicily. The latter declared himself king at Palermo in 1258 on an unfounded report of Conradin's death. But the popes pursued him with rancorous enmity, and on the nominal and shameless fiction of over-lordship offered his crown for money to Richard of Cornwall, brother of Henry III. of England, and next to Henry's younger son Edmund. At length Pope Urban IV., a Frenchman, opened up the most unworthy chapter of Sicilian history by granting it (1264) to Charles, Count of Anjou. Manfred fell fighting heroically against the invader at Grandella near Benevento in 1266, and Anjou entered Naples in triumph. But Peter, king of Aragon, who had married Constance, the daughter of Manfred, laid formal claim to Sicily in her right. The government of the French proved intolerable to the Sicilians, and the massacre of the Sicilian Vespers (q.v.) opened up a long struggle, which ended with the crowning of Peter's son Frederick in 1296, and his being acknowledged at the peace of 1302 king of Trinacria for life. But he soon

felt strong enough to resume his proper title of King of Sicily, and at his death in 1337 left the crown to his son Peter.

The Angevin House continued to reign in Naples, although they still maintained their nominal claim to Sicily—hence after the union the name Kingdom of the Two Sicilies. They upheld the Guelphic party; the Aragonese in Sicily, set up against the pope, were Ghibellines. Frederick's successors reigned on in Sicily, but in 1409 Mary, queen of Sicily, married Martin, son of Martin of Aragon, and through this the island was again united to the crown of Aragon. Queen Joanna II. of Naples, successor of Ladislas, was childless by both her marriages, and had first adopted as her successor Alfonso V., king of Aragon and Sicily, then revoked this disposition to adopt Louis III. of Anjou. The two parties went to war and divided all Italy: the Duke of Milan and Sforza on the Angevin side, the pope and the Florentines on Alfonso's. On the death of Louis the queen adopted his brother René of Anjou in his place. She died in 1435, and seven years later Alfonso succeeded in taking Naples, and died in 1458 king of Aragon, Naples, and Sicily. He left Aragon and Sicily, which he had inherited, to his legitimate son John II.; Naples, which he had won, to his bastard son Ferdinand I., whose cruelty made the chief citizens invite John of Calabria, son of René, to contest the crown. He was unsuccessful, but Charles VIII. of France revived the claim as the representative of the Angevin House, entered Italy in 1494, and made his progress in triumph to Naples, whence King Alfonso II. fled. Next year Alfonso's son Ferdinand II. returned to Naples to win back his kingdom. He died in 1496, and was succeeded by his uncle Frederick, who was betrayed by his kinsman Ferdinand of Aragon making an alliance with Louis XII. of France, and compelled to retire, giving up his rights to the French king. Next year (1502) the French and Spaniards quarrelled over their ill-gotten spoil, and the war was ended by the Spaniards utterly defeating the French at Mola near Gaeta in 1504.

Ferdinand the Catholic had thus again united Naples and Sicily to the Spanish monarchy. Both himself and his successor, the Emperor Charles V., had promised not to exact any new taxes from the kingdom of Naples without consent of nobles and people; but the viceroy of Philip IV. laid on grievous burdens, which at last led to insurrections both in Naples and Palermo, crushed mercilessly by Don John, bastard son of Philip IV. In 1700 Charles II. of Spain died childless, whereupon Louis XIV. claimed the throne for his grandson Philip, Duke of Anjou, and the Archduke Charles of Austria for himself. The long war of the Spanish succession was closed by the peace of Utrecht (1713), which gave to Charles, now the Emperor Charles VI., Milan, Naples, and Sardinia, while the Duke of Savoy received Sicily with the title of king. Philip again plunged into Italian intrigues, and captured Sardinia by a treacherous attack. But the Quadruple Alliance (England, France, the United Provinces, and Charles of Austria) enforced the treaty. Victor Amadeus of Savoy had been on the side of Spain in hopes of gaining Lombardy, and the Powers compelled him in 1720 to give up his new kingdom of Sicily to Charles VI. in exchange for Sardinia. Don Carlos, son of the queen of Spain, after a series of intrigues, made an attack on Sicily, and at length in a readjustment of the map of Italy at the treaty of Vienna (1738) was acknowledged king of the Two Sicilies. As Charles III. was called to be king of Spain in 1759 he left Naples and Sicily to his younger son, Ferdinand IV., whose queen, Caroline, a sister of Marie Antoinette, naturally hated the

French Revolution, and joined the English alliance. Bonaparte took Naples in 1798. King Ferdinand was turned out, allowed to return, but again turned out in 1806, when Bonaparte made his brother Joseph king. When Joseph was made king of Spain in 1808, Joachim Murat succeeded to his crown, Ferdinand being allowed to remain king of Sicily. By the treaty of Paris Italy was restored to her old masters. Victor Emmanuel received Sardinia with Genoa; the kingdom of Naples was restored to King Ferdinand IV. of Sicily, and he formally took the title of Ferdinand I. as king of the Two Sicilies. Ferdinand II. (1830-59) ruled Naples and Sicily with dreadful tyranny, bombarded Messina and Palermo, and flung the best citizens to rot in loathsome dungeons. Francis II. succeeded him; he had been brought up by the Jesuits, and under his rule the country ripened fast for revolution. At length Garibaldi sailed from Genoa with his thousand heroes, landed at Marsala, 11th May 1860, took Palermo, and at Melazzo defeated the king, who in abject terror promised all manner of reforms to Cavour and Victor Emmanuel. They did nothing but wait the issue, while Garibaldi crossed to Spartivento, drove back the king's troops, defeated them at Volturmo, and entered Naples in triumph on the 7th September. The people of Sicily and Naples joined themselves by a popular vote of more than a hundred to one to the Sardinian kingdom.

The palmiest age of letters in Sicily was the reign of the first Hiero (478-467), besung by Pindar; the next, that of the elder Dionysius, himself a poet and the friend of Plato. The lyric, the comedy, and the mime were practised by Stesichorus of Himera, Epicharmus, and Sophron of Syracuse; Empedocles of Agrigentum was a famous philosopher, Archimedes of Syracuse the most celebrated of ancient mathematicians; but the rarest flower that grew out of Sicilian soil was the bucolic poem which once for all attained perfection in the idylls of Theocritus and Moschus of Syracuse, and in Bion, who, though a native of Smyrna, was a Syracusan in all his sympathies and in his grave.

The modern Sicilian dialect is of course closely allied to the Neapolitan, but offers grave difficulties both in vocabulary and grammar to the student acquainted only with Tuscan. It has furnished a rich literary material to the popular imagination for six hundred years down to our own day, and yielded a harvest of genuinely popular poetry not equalled elsewhere in the world. But not in their number alone are the Sicilian folk-songs pre-eminent, but in their intrinsic poetic excellence. The love-songs especially are tender, passionate, and sincere, and many have a penetrating pathos that haunts the memory of a reader. They have been collected by S. Salomone-Marino, Dr Pitre (q.v.), and L. Vigo, whose *Raccolta amplissima di canti popolari Sicil.* (1870-74) alone contains 6000 songs, with besides a good bibliography of books in the Sicilian dialect. Dr Pitre's great *Biblioteca della Tradizione pop. Siciliana* (19 vols. 1870-90) is a vast encyclopædia of folk-songs and ballads, folk-tales, legends, proverbs, customs, games, jests, riddles, &c., with grammatical introductions and glossaries. Two other works that must be named are Laura Gonzenbach's *Sicilianische Märchen* (2 vols. Leip. 1877), and S. Salomone-Marino, *Storie popolari in Poesia Siciliana* (Bolog. 1877). For the Sicilian dialect, see the works by Wentrup (Halle, 1880) and C. Avolio (Moto, 1882); the Sicilian-Italian Dictionaries of G. Biundi (Pal. 1857) and V. Mortillario (new ed. Pal. 1879).

There are histories of Sicily in antiquity by Holm (2 vols. Leip. 1870-74) and W. Watkiss Lloyd (1872); the Moslem period, by Amari (3 vols. Florence, 1853-73); the Norman period, by Bazancourt (2 vols. Paris, 1846) and Graf v. Schack (2 vols. Stuttg. 1889); the Bourbon period, by Amari (Paris, 1849); the Piedmontese period, by Querner (Bern, 1879). See also the works on the history of Naples by Giannone and his continuator, Colletta; Seibert, Reuchlin, Orloff, Rüstow, Romano-Manebrini, La Lumia, E. A. Freeman's unfinished *History of Sicily* (vols. i-iv. 1891-94), and his short history ('Story of the Nations' series, 1892).

Sickingen, FRANZ VON, born on 2d March 1481 at the castle of Ebernburg near Kreuznach, fought in 1508 against the Venetians in the service of the Emperor Maximilian, but in peace led the life of a free-lance. He could bring 20,000 followers into the field, and during 1513-19 we find him warring against Worms, the magistrates of Metz, the Landgrave Philip of Hesse, and Würtemberg. He twice levied ransoms of 20,000 and 30,000 gulden, and Charles V.'s election to the imperial crown was largely due to his influence. Reuchlin was protected by him at the capture of Stuttgart, and he formed a close friendship with Ulrich von Hutten (q.v.), who from 1520 was his constant guest, and won over his rude but lofty spirit to the cause of the Reformation. His fortresses, Landstuhl and Ebernburg, became the 'asylums of righteousness'; Bucer, Aquila, and Ecolampadius found refuge within their walls. In 1521 he assisted the emperor in his French campaign; in 1522, with the nobles of the Upper Rhine, he opened a Protestant war against the archbishop of Treves. That war miscarried; and put to the ban of the empire, and besieged in his castle of Landstuhl, on 2d May 1523 he received a musket-shot, of which six days later he died. In 1889 a stately monument to him and Hutten was erected at Ebernburg.

See works cited at HUTTEN, and monographs on Sickingen by Ulmann (Leip. 1872), Bremer (Strasb. 1885), and Hill (Ludwigsh. 1887).

Sickle. See REAPING.

Sicyon, an important city of ancient Greece, stood on a triangular plateau, between the rivers Asopus and Helisson, about 2 miles S. of the Corinthian Gulf and 7 NW. of Corinth. It was celebrated in antiquity for the unusual beauty of its bronze work, which exercised an important influence on the development of Greek art in general, and was the seat of a school of painting that included Pamphilus and Apelles, both natives of Sicyon. It was also the birthplace of Aratus (q.v.), the general of the Achæan League, and of Lysippus, the sculptor. There exist at the present day a few remains of the ancient city, as well as of the more modern buildings erected by the Roman conquerors of Greece. These have been in part excavated by the American School of Classical Studies at Athens since 1887.

Siddhartha. See BUDDHISM, Vol. II. p. 517.

Siddons, SARAH, the greatest tragic actress England has produced, was the daughter of Roger Kemble, a respectable manager of a small travelling theatrical company, whose circuit was in the midland and western parts of England. Sarah, who was the eldest child, was born at Brecon on 5th July 1755. From her earliest childhood she was a member of her father's company, and in a playbill dated 12th February 1767 her name appears as acting the character of the Princess Elizabeth in Havard's tragedy of *Charles the First*. When only seventeen she formed an attachment to Siddons, who was a member of her father's company, and, after considerable opposition from her parents, she was married to him in Coventry on 26th November 1773. Her husband and herself joined the Cheltenham Company, and while here she was recommended to Garrick by the Earl of Ailesbury. Garrick asked the Rev. Bate Dudley to report on her abilities, and is said to have also sent King, the actor, to see her. The result was an engagement at Drury Lane, where she made her first appearance on 29th December 1775 in the character of Portia. It has been said that the comparative failure which attended her first attempt to become a London actress was the result of pique on the part of Garrick; but there is no evidence whatever of this, and the fact seems to be simply

that her powers were not matured sufficiently to enable her to produce an effect in the huge metropolitan theatre. At the end of the season she was not re-engaged, and for six years she played in the provinces, making her greatest successes in York and Bath; but her reputation grew so fast that in 1782 she was invited to return to Drury Lane. She accepted the offer, and made her reappearance on 10th October 1782 as Isabella, in Garrick's adaptation of Southerne's *Fatal Marriage*. Her success was immediate and permanent, and from this time to her retirement she was the unquestioned queen of the stage. In 1803 she followed the fortunes of her brother, John Philip Kemble, who had purchased a share in Covent Garden Theatre, and here she appeared on 27th September 1803 in her favourite character of Isabella. During the rest of her career she continued at Covent Garden, and at that theatre she took her formal farewell of the stage on 29th June 1812, when she played *Lady Macbeth*. She appeared occasionally after this time, but only for charitable objects or for special benefits. After her retirement from the stage Mrs Siddons gave occasional public readings from Shakespeare and Milton. She died on 8th June 1831, and was buried in Paddington Churchyard. As an actress Mrs Siddons stands unapproached, so far as can be judged from recorded criticism, in every line of tragedy—her pathos, her rage, her despair, her suffering, her grief, all being perfect in expression and convincing in naturalness. Endowed by nature with a gloriously expressive and beautiful face, a queenly figure, and a voice of richest power and flexibility, she worked assiduously to cultivate her mental and physical gifts until she reached a height of perfection which has probably never been surpassed by any player of any age or country. In comedy she was less successful. See *Life by Mrs Kennard* ('Eminent Women' series, 1886).

Side-bones are enlargements situated above the quarters of a horse's feet, resulting from the conversion into bone of the elastic lateral cartilages. They occur mostly in heavy draught horses with upright pasterns, causing some stiffness, but, unless when of rapid growth, little lameness, though they are accounted amongst the defects that render a horse 'unsound.' They are treated at first by cold applied continually, until heat and tenderness are removed, when blistering or firing must be resorted to, and removal of pressure by shoeing with a 'bar shoe.'

Sidereal Clock, a clock so regulated as to indicate *sidereal time*; see DAY. The sidereal clock is a most important aid to the practical astronomer, and is one of the indispensable instruments of an observatory.

Sideroxylon. See IRONWOOD.

Sidesaddle-flower is a name sometimes given to a plant of the genus *Sarracenia*. See INSECTIVOROUS PLANTS.

Sidgwick, HENRY, a writer on ethics, was born at Skipton in Yorkshire, on 31st May 1838, and educated at Rugby and Trinity College, Cambridge, being elected a Fellow in 1859. From 1875 he lectured in the capacity of prelector of Moral and Political Philosophy, and in 1883 was elected Knightbridge professor of Moral Philosophy. His name first became widely known as an able writer on ethical subjects by his *Methods of Ethics* (1874; 4th ed. 1890), a critical examination of the principles underlying the various historic systems of moral philosophy, in which the points of resemblance between the opposing intuitional and utilitarian schools are particularly dwelt upon. The writer is on the whole fair to both sides, although his own sympathies lean to the utilitarian standpoint. The strongest feature of the book is its

keen analytical power, which, however, drifts at times into the over-refinements of mere intellectual subtlety. Professor Sidgwick contributed numerous papers on ethical and economic subjects to *Mind*, *Journal of Philology*, and other journals. He took a warm and active interest in the higher education of women, and was especially interested in the management of Newnham College at Cambridge. In 1886 he published as a separate book *Outlines of the History of Ethics*, the historical summary of the chief ethical systems and schools that he contributed to the ninth edition of the *Encyclopædia Britannica*; in 1883 *The Principles of Political Economy*, a work that maintains the essentials of John Stuart Mill's method and results, but modifies them into harmony with the march of progress and the advance in economic ideas; in 1891 *The Elements of Politics*. Professor Sidgwick took an active interest in the Psychological Research Society, and was once its president. He died in August 1900.

Sidi-bel-Abbès, a quiet modern town of Algeria, 48 miles by rail S. of Oran and 56 NE. of Tlemçen. Pop. 19,848.

Sidlaw Hills. See FORFARSHIRE, and DUN-SINANE.

Sidmouth, a watering-place on the south coast of Devonshire, 14 miles by road, but 20½ by a branch-line (1874), ESE. of Exeter. It lies in a narrow valley at the mouth of the little Sid between the red sandstone cliffs of High Peak (513 feet) on the west, and Salcombe Hill (497) on the east. Its esplanade is protected by a sea-wall (1838), 1700 feet long; and its parish church (1259; almost rebuilt 1860) has a stained west window inserted by Queen Victoria in memory of her father, the Duke of Kent, who died here in 1820. Sidmouth then was the favourite resort that it has once more become since the opening of the railway; its former prosperity as a port, which in Edward III.'s day sent two ships to the siege of Calais, passed away through the silting up of the harbour. The climate is mild, the rainfall the least in Devon, and the beach yields plenty of agates and chalcedonies. Pop. (1851) 2516; (1891) 3758.

Sidmouth, HENRY ADDINGTON, VISCOUNT, prime-minister, was born in London, 30th May 1757, the son of Lord Chatham's physician, Dr Anthony Addington (1713-90). After twelve years at Cheam and Winchester schools, and four at Brasenose College, Oxford (1774-78), he studied law at Lincoln's Inn, married (1781), and was led by his friendship with Pitt to quit the bar for politics, in 1783 being elected M.P. for Devizes. He made an admirable Speaker from 1789 till 1801, when, upon Pitt's resignation on the Catholic relief question, he was invited by the king and urged by Pitt to form a ministry. That most third-rate administration, in which Addington was First Lord of the Treasury and Chancellor of the Exchequer, and whose one great event was the short-lived peace of Amiens (1802), came to an end in 1804. In the following January Addington was created Viscount Sidmouth; and thereafter he was thrice President of the Council, once Lord Privy-seal, and from 1812 to 1821 Home Secretary, as such being thoroughly unpopular for his coercive measures. He retired from the cabinet in 1824, and died 15th February 1844. He was a very sincere Tory. See his *Life and Correspondence* by his son-in-law, Dean Pellew (3 vols. 1847).

Sidney, or SYDNEY, ALGERNON, grand-nephew of the famous Sir Philip, was born probably at Penshurst, Kent, and in 1622, the second son of Robert, second Earl of Leicester (1595-1677). He received a careful education, and accompanied his father in 1632 on his embassy to Denmark, and in 1636 to France. In 1641-43

he commanded a troop of horse against the rebels in Ireland, of which country his father was (nominally) Lord-lieutenant. Then with his elder brother, Viscount Lisle, he returned to England, and, declaring for the parliament, was in March 1644 appointed to a troop in the Earl of Manchester's regiment. At Marston Moor he was severely wounded; in 1645 was appointed governor of Chichester, and returned by Cardiff to parliament; in 1646 attended his brother, now Lord-lieutenant, to Ireland as lieutenant-general of the horse and governor of Dublin; and in 1647, after receiving the thanks of the House of Commons for his services, was appointed governor of Dover. In 1649, though nominated one of the commissioners, he kept himself clear from any hand in the king's trial, which yet he justified on abstract grounds, speaking afterwards of the execution as 'the justest and bravest action that ever was done in England or anywhere else.' In principle a severe republican, he resented Cromwell's usurpation of power, and from the dissolution to the restoration of the Long Parliament (1653-59) lived in retirement at Penshurst. He then was nominated one of the Council of State, and next was engaged for a twelvemonth on a political mission to Denmark and Sweden. After the Restoration he lived precariously on the Continent, flitting from place to place (Rome, Brussels, Augsburg, Montpellier, Paris, &c.); but in 1677 a pardon was procured for him from Charles II., and he returned to his native country. In 1679 he twice stood for parliament, but each time was jockeyed out of his seat in favour of the court candidate; and an attempt was made that same year to involve him in the sham Meal-tub Plot. The attempt miscarried; still, he deemed it prudent to retire for a while to France, where he bought a small property, and, to detach Louis XIV. from Charles, entered into negotiations with him through Barillon. That prior to this he had taken moneys from the French ambassador, either for himself or (more likely) for the republican cause, is admitted by Hallam and Macaulay, but disputed by Mr Ewald, who contends that Barillon embezzled the thousand guineas that he set down to Sidney's account. Anyway, to understand Sidney's relations with Louis, it must be borne in mind that he was hardly less hostile to William of Orange, as stadtholder, than to Charles himself, as king. Next year he was back in England, and, it is said on somewhat doubtful authority, assisted his friend, William Penn, to draw up the Pennsylvanian constitution, including the ballot, universal suffrage, the abolition of a property qualification, religious equality, prison reform, and the abolition of capital punishment except for murder and treason. In June 1683, when the Rye-house plot was announced, the chance was seized to get rid of men felt to be dangerous, and, along with Lords Russell, Essex, and Howard, Sidney was arrested and committed to the Tower. On 21st November he was tried for high-treason before the brutal Jeffreys, and, on no evidence but the traitor Lord Howard's and his own unpublished *Discourses concerning Government*, was found guilty and sentenced to die. He met his doom bravely on Tower Hill, 7th December, and was buried the next day at Penshurst. His attainder was reversed in 1689; his *Discourses* appeared first in 1698.

See Blencowe's *Sidney Papers* (1813), and the Lives of Sidney by S. W. Meadley (1813) and A. C. Ewald (2 vols. 1873), with other works cited at RUSSELL, SHAFESBURY, and CHARLES II.

Sidney, PHILIP (November 1554-October 1586). After three hundred years the effacing hands of time and change have still left a halo about Sir Philip Sidney such as surrounds no other of his

contemporaries. His unselfish chivalrous nature it is, bold at once and tender, his purity of life in the corrupt atmosphere of the Elizabethan court, above all, his heroic death, which make him still in a certain sense alive among us. Yet his was in fact an unadventurous life, wasted, not by his own fault, despite of strenuous endeavour; whilst by a kind of pathetic irony the fame which preserves his gracious memory has perversely failed to do justice to that true and passionate verse which in his own day placed him at the head of our poetry next in succession to Chaucer. Sidney, born 29th November 1554, at Penshurst, Kent, and named after Philip II., was son to Sir Henry, a man of high birth and noble character, married to Mary Dudley, daughter to the Duke of Northumberland (executed for treason 1553), and sister to that base and hypocritical Lord Leicester, of all Queen Elizabeth's favourites the most ill-chosen and baleful. Philip was sent first for education to Shrewsbury School (1564), thence (1568) to Christ Church, Oxford. He studied hard, as his writings show, and made his two best friends, Greville, afterwards Lord Brooke, and Dyer; men likeminded with himself in a certain seriousness and manliness of character, such as was naturally formed by the atmosphere of that age—troubled, yet full of hope and energy.

From 1572 to 1575 Sidney travelled in France, Germany, and Italy, completing his education after the fashion of those days, returning well versed in the best Italian literature, but unspoiled by foreign temptations. He was not a man to verify the proverb of that day, 'A devil incarnate is the Englishman Italianate.' Few men or none were then more powerful in England than his uncle Leicester, and Sidney at once began to make his career at court, then the only portal to public life. His character was now fully formed as the model of a finished English gentleman; in Spenser's fine phrase he was the 'President of noblesse and of chivalry.' Yet as a statesman Sidney practically failed. At first a favourite of the ever-fickle queen, he accompanied her progresses; he was sent ambassador (1577) to Rudolph II., and then to William, Prince of Orange. There is a vague story that he was thought of as candidate for the uneasy Polish throne; he certainly longed to join Prince Casimir, then in arms in the Netherlands. But he was not yet (1578) fated to visit Zutphen.

Sidney's court position now became trying. Elizabeth displayed her too frequent ingratitude toward his father for his exertions as Lord Deputy in Ireland, and Philip wrote in his defence with much ability and courage. And in similar style he addressed the queen against her desired match with the miserable Duke of Anjou. Elizabeth hence frowned upon him; whilst, meanwhile, Leicester's own marriage with Lady Essex had removed him from court. Sidney also retired (1580) to his admirable sister Mary, now Lady Pembroke, at Wilton, where most, probably, of his *Arcadia* was written.

Of Sidney's life in 1581–82 we know little. He returned to court, like Spenser,

To lose good days, that might be better spent;
To waste long nights in pensive discontent:

tortured also with the hopeless love, which we shall notice further on. In 1583 he was knighted; he received from Elizabeth a paper-grant of 30,000,000 acres in 'certain parts of America not yet discovered;' and married Frances, daughter to Sir F. Walsingham. But although he may thus have thought to strengthen his position, Sidney was doomed to yet another disappointment. The arrangement which he had settled (1585) to accompany Drake on one of his buccaneer expeditions to America was defeated by Elizabeth's weakness or

caprice and Drake's jealous treachery. Indeed, when seen not through the haze of tradition, the distorting mists of partisanship, but in natural light, the popular heroes of that day often drop their halo. But this subject belongs to that unwritten section of our annals, the true history of the Elizabethan age.

It was poor amends that Sidney was ordered to accompany Leicester, chosen for her general by the queen's infatuation, to carry her half-hearted and untrustworthy support to the Netherlanders in their agony and struggle against Spain. Upon the miseries of Sidney's position in his partial charge of that thrice disgraceful expedition we need not dwell. For nearly a year he was detained in idleness; then, after one small brilliant exploit, he received upon October 2, 1586, his death-wound in a chivalrous conflict, rash as the English charge at Balaclava, under the walls of Zutphen; dying, as he had borne himself throughout life, like a hero and a Christian, on the 17th; and mourned by England with a unanimity and a depth of feeling never surpassed—perhaps never equalled.

By 1579 Sidney, who through a Cambridge scholar, Gabriel Harvey, had become acquainted with Edmund Spenser, a year or more his senior, had formed with him and some others a little literary society, which aimed at rejecting rhyme and writing English poetry in classical metres. Of that folly Sidney soon repented; but a few letters between Spenser and Harvey upon the subject, happily preserved, are noteworthy as the sole contemporary notice of Sidney's own work in literature, which we may place between 1578 and 1582. Widely celebrated as that work was during Sidney's lifetime, yet nothing of it was published till after his death. He 'purposed no monuments of books. . . . His end was not writing, even while he wrote,' said his friend Greville. Like his immediate predecessors Wyatt, Surrey, Sackville, he was statesman or courtier first, author only in leisure hours. His writings must have been partially made known by MS. circulation; yet we may suspect that Sidney's own brilliant character, his connections, which placed him in the very foremost rank of high life, his generous patronage of men of letters, with the report of those to whom his writings were communicated, united to give him his pre-eminent contemporary reputation. This was, however, amply supported when the *Arcadia* (written for his sister, Lady Pembroke, probably 1578–80, but never finished) appeared, imperfectly in 1590, completely in 1598. This book, for perhaps about a century, retained a vast popularity, though now almost unread, and indeed unreadable. It is a pastoral romance, founded primarily upon the *Arcadia* (1504) of the Neapolitan Sannazzaro, being, like that, an intricate love-story, intermixed with poems and written in melodious but elaborate prose, and not free from the artificial 'conceits,' the Euphuism, familiar in Europe to that age. But the Portuguese Montemayor's *Diana* (1542), the old Greek romance *Theagenes and Chariclea*, with, doubtless, other traditional legends, had also their share in Sidney's story; whilst its many incidents, disguises, and intricacies supplied material for later writers. But the main value of the book perhaps lay in this, that here Englishmen found their earliest model for sweet, continuous, rhythmical prose—for the prose of art. Before the *Arcadia* we have fine single passages; no such consistent whole. The verse portions are rarely happy; they must have been among Sidney's earliest attempts; but in truth his genius required that high heat of personal passion which inspires *Astrophel* to fuse his ore into gold; although that ore (to pursue the figure) is always weighty with Sidney's seriousness, his elevated thought, his chivalry of nature. As of

exceptional merit may be noticed the dialogue between Nico and Dorus, and an Epithalamium of stately dignity, which may have been suggestive to Spenser. In *Arcadia* Sidney tried numerous metres, English, Italian, classical; the latter, inevitably, with small success.

To about 1580 may be assigned Sidney's *Apology for Poetry* (afterwards named *Defence of Poesy*), in reply to an abusive Puritan pamphlet, and to a general disesteem then felt in England for that art; published 1591. In this tract, written in clear, manly English, and still well worthy of readers, Sidney defines poetry, after Aristotle, as Ideal Imitation, and for her claims her ancient place as the highest mode of literature, teaching mankind the most important truths through the medium of that pleasure which is the formal end of all fine art. In mediæval fashion, many authorities are quoted, and Sidney displays his wide range of reading. Lastly, he criticises severely and justly the crowd of contemporary versifiers—not peculiar to that age!—to whose want of power, bad taste, and trivial style he partly ascribes the then existing low estimate of poetry. And here he names the best English poets known to him: Chaucer, Sackville, Surrey, and Spenser's just (anonymously) published *Calendar*. 'Besides these, I do not remember to have seen but few (to speak boldly) printed, that have poetical sinews in them.' English drama, it will be remembered, was then in its cradle.

Sidney, like Shelley, was so great a poet that he had just right to come forward in defence of poetry. But for himself it was love, not instruction, that moved him:

Come, let me write: And to what end? To ease
A burthen'd heart;

and again, to his Love,

Only in you my song begins and endeth.

For the origin of *Astrophel and Stella* (published 1591), however, we must go back to an episode in Sidney's life. In 1575, aged twenty, he met Penelope Devereux, daughter to Lord Essex, then a child of twelve. Some intimacy followed, and Essex, on his deathbed (1576), expressed a hope that the two might in due time marry. In Sidney's nature, however, was some want of youthfulness; his heart did not respond, and it was only in 1581, when Penelope was engaged and wedded (apparently without love on her part) to Lord Rich, that Sidney awoke too late to find *Quid sit Amor*—to find also that she might have loved him. It is hence a sad drama, a miniature tragedy in lyrics, that is revealed in this long series; as Nash, the editor, said, 'The argument, cruel chastity; the prologue hope, the epilogue despair.'

These 108 sonnets and 11 songs (to which a few separately published in 1598 may be added), after, or rather with, Shakespeare's sonnets, have long seemed to us to offer the most complete and powerful picture, in this form, of passionate love, in our language. And they have a straightforward truth of expression which unveils the poet's own character beyond Shakespeare's: they truly speak everywhere heart to heart. Sidney's *Canzoniere* has hence escaped those elaborate futile attempts to give it an impersonal or symbolical character which have wearied mankind in the case of Shakespeare. Yet, as Dante's love for Beatrice, Petrarch's for Laura, have been doubted, so has it been with *Astrophel's* for *Stella*. But readers who do not bring only brains to reading Sidney's little *Liber Amoris* will assuredly set aside every such ingenious sophist and sceptic at once and for ever: He has not loved!

Considering the charm that Sidney's name still exerts, the close relation of his poetry to the romance of his life, and the high place in our

literature merited by its great qualities, that as poet he should have met hitherto so imperfect a recognition is little to the credit of popular taste. That high place has been amply vindicated in the admirable essay by the most exquisite of poetical critics, Charles Lamb. But that Sidney's fame falls far below his deserts is due in part to that inequality of his workmanship which he shares with other supreme writers of sonnet-sequences; with Petrarch, Shakespeare, and Wordsworth. Nor did life allow him to acquire their finished art. 'His end was not writing, even while he wrote.' Fanciful conceits, obscurity from the depth and wealth of thought, are not unfrequent; at times the style is prosaic, bare, unmelodious. But over-fancifulness was the defect of that age: obscurity is common to his great rivals, when moving in the sonnet's narrow bounds. It is the defect of high thinking and intensity of passion. Space, however, does not allow us to offer even a few specimens in proof; and, after all, the poet is always his own best interpreter.

Sidney's *Poetry and Apology* have been carefully edited, the first by the Rev. A. B. Grosart (3 vols. 1877), the second by Mr Arber (1868) and Mr Shuckburgh (1891); the last complete *Arcadia* was printed so long since as 1725. Dr H. Oskar Sommer published in 1891 a photographic fac-simile of the original quarto edition of 1590. Fulke Greville's *Life* (1652) was re-edited by Sir Egerton Brydges (2 vols. 1816). *Modern Lives* are by Dr Zouch (1808), H. R. Fox Bourne (1862); also a smaller book in 'Heroes of the Nations,' 1891, and J. A. Symonds in 'English Men of Letters' (1886). An elaborate life by Dr Ewald Flügel was announced in 1891 by the Clarendon Press as in preparation. See also the *Sidney Papers* edited by Arthur Collins (1746), and the Correspondence of Sir Philip Sidney with Hubert Languet, edited by Stuart A. Pears (1845). See also the *Sonnets*, edited by Gray (1898), and the article ZUTPHEN.

Sidon (Heb. *Zidon*), anciently a city of Phœnicia, situated on the east coast of the Mediterranean, half-way between Tyre and Beyrout. It soon rose, both by its exceptional position and the enterprising character of its inhabitants, to the first position among the cities of Phœnicia (q.v.), so that the whole country is sometimes designated by the name of Sidon, 'the Great,' 'the Metropolis.' The extensive commerce of Sidon is well known from ancient authorities. Its colonies extended over the coast of Asia Minor, the adjacent islands, Thrace and Eubœa, and even some parts of Sicily, Sardinia, Spain, northern Africa, in fact, nearly the whole of the ancient world. The Sidonian manufactures of glass and linen, purple dye and perfumes, were sources of vast wealth. At length it surrendered to Shalmaneser, king of Assyria. But under Assyrian, Chaldean, and Persian domination it retained a kind of independence for its internal affairs, and under the Persians reached its highest prosperity. An unsuccessful revolt against Artaxerxes Ochus ended in its temporary ruin (351 B.C.). Speedily rebuilt and re-peopled, it opened its gates to Alexander the Great (333 B.C.), and from that time forth it fell successively into the hands of Syrian, Greek, and Roman rulers. Through the middle ages little is heard of it, except that it was taken by the Crusaders. The present town of Saida has 10,000 inhabitants, of whom 7000 are Mohammedans. In the neighbourhood are numerous rock-cut burial-places of the ancient Phœnicians, in which have been found the sarcophagus of Eshmunazar, king of Assyria, and others. The town was stormed by the allies under Napier in 1840.

Sidonius Apollinaris, a 5th-century churchman and author, descended from a noble Gaulish family, who held high civil offices at Rome and in 472 became bishop of Clermont. Born about 430, he died in 483. His letters (nine books) are

modelled on Pliny and other classics; his poems (twenty-four books) comprise panegyrics on three emperors and two bombastic epithalamiums.

See the Abbé Chaix, *Saint Sidoine Apollinaire et son Siècle* (2 vols. Clermont, 1867-68); works by Chatelain (Paris, 1875) and Kaufmann (Göttingen, 1864); Hodgkin's *Italy and her Invaders* (vol. ii. book iii.; 1880). There are editions of the works of Sidonius by Baret (Paris, 1879) and Lütjohann (Berlin, 1888).

Siebenbürgen ('Seven Castles'), the German name of the former principality of Transylvania.

Siebengebirge, or 'Seven Mountains,' in Rhenish Prussia, on the right bank of the Rhine, about 20 miles above Cologne. The highest is the Ölberg (1522 feet); but the most famous is the Drachenfels (q.v.). The crags are crowned with ruins of baronial castles of the 12th century. Trachyte is quarried amongst these hills; from them the stone was obtained for the greater part of Cologne Cathedral.

Siebold, PHILIPP FRANZ VON, physician and botanist, was born at Würzburg, 15th February 1796, became sanitary officer to the Dutch in Batavia, and, accompanying the Dutch embassy to Japan, did much to make Japan known to the western world. He spent 1826-30 in Japan, wrote on the country, its flora, and language, and died 18th October 1866.—His brother KARL THEODOR ERNST VON SIEBOLD, anatomist, was born 16th February 1804, and became famous as professor at Munich (1853), where he died, 7th April 1885. He wrote works on the Invertebrata (Eng. trans. 1857), on tapeworms, on parthenogenesis, on salamanders, and on the fresh-water fishes of central Europe.

Siedlee, a town, or rather a large village, of Poland, 57 miles by rail E. by S. of Warsaw, is the capital of the province of the same name. Pop. 12,950.—Area of province, 5535 sq. m.; pop. 671,538.

Siege (Fr., 'a seat,' 'a sitting down'). When the assault of a fortified place would be too hazardous and costly and its reduction by blockade too slow, recourse is had to the *regular siege* or *systematic attack*. In order to cross the open ground swept by the fire of the fortress with as little loss as possible the besieger makes use of sunken roads or *trenches*. The revetments having been breached by his artillery or mines, he continues these roads through the breaches into the place. To prevent these *approaches* being enfiladed by the guns of the fortress they are made at first in zigzags; the prolongations of which are directed so as to clear the works of the fronts attacked, and, when a direct advance becomes necessary, they are provided with traverses at short intervals, or *blinded sap* is used—i.e. a trench covered in with timber and earth. Two or three such lines of approach are used. To protect and connect them lateral trenches are formed from which large bodies of troops can fire upon any sortie that may be made. These are termed *parallels*, being parallel to the general front of the parts attacked. The *first parallel* is made at as short a distance as possible (perhaps 1000 yards) from the fortress, and its construction follows the disorganisation of the defenders' artillery by that of the attack from its first position, often 4000 yards from the fortress; the *second* would be rather less than midway between the first and the most advanced works of the fortress, so that the supporting troops in it may be nearer the working parties in the approaches than the enemy; the *third parallel* would generally be about 100 yards in front of the salients of the covered way. Parallels are useful also to connect the batteries which, dispersed over a wide area, will concentrate their fire upon the revetments of

the ditch and ramparts, or upon the guns of the defence. These latter, restricted as they are to a comparatively small space, must eventually be outnumbered and overpowered; but, if the investment is imperfect, as at the siege of Sebastopol in 1854-55, an active defender may long delay this disaster, especially if the fortress has an outer girdle of detached forts, for in that case at least two of the forts must be taken by regular siege before further advance is made, and the ground between them (1000 yards and upwards) lends itself to the construction of new batteries to meet those of the attack. But the resources in men, guns, and ammunition must, by the nature of the case, be largely in favour of the attacker, and therefore, if persevered in, the siege is sure to succeed.

The ancients used to surround the place attacked with a high bank of earth, called a *line of circumvallation*, and protected themselves against attack from the outside by another called a *line of contravallation*, and a similar arrangement was in vogue until the middle of the 19th century. Now a covering field-army is employed, which, by its greater mobility, is able to meet the relieving army many miles from the besieging force, and a chain of fortified localities takes the place of the continuous line of circumvallation.

In order that a siege may be safely undertaken the strength of the besieger should be about four times that of the garrison. Thus, in the case of a small place with a garrison of 5000 men the line of investment would probably be 12 miles long, and could be maintained by three detachments of 2500 men each, the guards of the trenches would be 5000 and working parties 8000—a total of 20,500. In 1870 Strasburg, with a garrison of 20,000, was captured by a besieging force 60,000 strong. Metz was starved into surrender, the presence of so many men (some 170,000) besides the proper garrison only hastening that result. Had this large entrenched camp been held by its regular garrison of 40,000 men it would not have fallen to a besieger with less than 120,000, which is more than half the numbers actually employed.

The *siege trains* employed in 1870 by the Germans were comparatively small, owing to the badly prepared state of the French fortresses. Thus, at Strasburg only 243 pieces were used, firing 200,000 rounds in thirty-six days, while at Sebastopol the allies mounted 698 pieces of artillery, and in three days these fired 150,000 rounds.

The *siege parks*, or main depôts, for the artillery and engineer trains must be out of range of the enemy's guns, containing as they do powder, ammunition, guns, and warlike stores of all descriptions. The batteries necessary are *enfilade* batteries, placed on the prolongations of all the important works attacked; *counter batteries*, to overcome the fire of the works bearing upon the field of attack; *mortar* and *howitzer* batteries, to search by high-angle fire the interior of all the works attacked; and *breaching batteries*, to breach by curved fire the scarps and flanking casemates. Light pieces, such as the seven-pounder mountain gun and machine guns, are placed in the second and third parallels, and in the *demi-parallels* or lodgments, 100 to 150 yards long, made on each approach about half-way between these parallels.

Beyond the third parallel the besieger will probably be met by counter-mines, and himself have to resort to mining in order to carry out the crowning of the covered way. He will then connect his approaches by a fourth parallel, establish batteries and lodgments on the crest of the covered way, and from them mine down to the back of the counterscarp, which he can blow in previous to sapping across the ditch and up the breaches. From

the positions thus gained a further advance, if necessary, can be made until the last retrenchment is taken, and the place falls. See also FORTIFICATION, and MINES.

Among great sieges in the world's history may be mentioned those of Troy, Tyre (572, 332 B.C.), Syracuse (396 B.C.), Saguntum (219 B.C.), Jerusalem (70 A.D.), Acre (1191, &c.), Calais (1347), Orleans (1428), Constantinople (1453), Haarlem (1572-73), Leyden (1574), Breda (1625), Rochelle (1628), Magdeburg (1631), Breisach (1638), Taunton (1644-45), Londonderry (1689), Gibraltar (1731, 1779, 1782-83), Prague (1741-44), Leipzig (1757, 1813), Quebec (1759-60), Seringatam (1799), Genoa (1800), Saragossa (1808-9), Ciudad Rodrigo (1810, 1812), New Orleans (1814), Antwerp (1832), Rome (1849), Sebastopol (1854-55), Kars (1855), Lucknow (1857), Delhi (1857), Gaeta (1860-61), Vicksburg (1863), Charleston (1863-64), Richmond (1864-65), Metz (1870), Strasburg (1870), Belfort (1870-71), Paris (1870-71), Plevna (1877), and Khartoum (1884).

The *state of siege* as defined by continental jurists is a condition of things in which civil law is suspended or made subordinate to military law. A fortress, city, or district is thus put under martial law—i.e. under the authority of the military power—either on account of the presence of an enemy, as at a siege, or because of the failure of the civil power, as in the case of domestic insurrection, or of a conquered district in military occupation. The *minor state of siege*, a modification of the more severe rule, usually suffices for domestic troubles. No such provision is made by the laws of the British Empire or of the United States, though very similar powers are exercised when martial law is proclaimed. For this no rules are made—the possibility of civil war is not presupposed; but should the civil power become inoperative it is the duty of the supreme authority to maintain order by any means (usually of course an armed force) that are available, afterwards coming to parliament for an act of indemnity to justify conduct in itself contrary to law. Perhaps an approach to the continental *minor state of siege* may be found in the restricted power to try offenders in Ireland by military tribunals created by act of parliament in 1799, 1803, and 1833.

Siegen, a town of Prussia, in Westphalia, stands on the Sieg, 47 miles E. of Cologne, manufactures leather, paper, linen, soap, iron, copper, lead, zinc, &c., having many mines in the vicinity. Siegen was the birthplace of Rubens. Pop. 16,676.

Siegfried, or SIGFRID. See NIBELUNGENLIED.

Siemens, WERNER VON, engineer and electrician, was born December 13, 1816, at Lenthe in Hanover. In 1834 he entered the Prussian Artillery, and in 1844 was put in charge of the artillery workshops at Berlin. He early showed scientific tastes, and in 1841 took out his first patent for galvanic silver and gold plating. He was of peculiar service in developing the telegraphic system in Prussia, and discovered in this connection the valuable insulating property of gutta-percha for underground and submarine cables. In 1849 he left the army, and shortly after the service of the state altogether, and devoted his energies to the construction of telegraphic and electrical apparatus of all kinds. The well-known firm of Siemens and Halske was established in 1847 in Berlin; and subsequently branches were formed, chiefly under the management of the younger brothers of Werner Siemens, in St Petersburg (1857), in London (1858), in Vienna (1858), and in Tiflis (1863). Besides devising numerous useful forms of galvanometers and other electrical instruments of precision, Werner Siemens was one of the discoverers of the principle of the self-

acting dynamo (see DYNAMO). He also made valuable determinations of the electrical resistance of different substances, the resistance of a column of mercury, one metre long and one square millimetre cross section at 0°C., being known as the Siemens Unit. His numerous scientific and technical papers, written for the various journals, were republished in collected form in 1881. In 1886 he gave 500,000 marks for the founding of an imperial institute of technology and physics; and in 1888 he was ennobled. He died at Berlin, 6th December 1892. See his *Personal Recollections* (translated, 1893) and his *Scientific Papers* (2 vols. 1892-95).

Siemens, SIR WILLIAM (KARL WILHELM), the youngest brother of Werner Siemens, was born at Lenthe in Hanover, April 4, 1823. He was educated at the trade school at Magdeburg, and spent a year in study at Göttingen University, where he worked hard at science. In 1843 he visited England, and was successful in introducing a process for electro-gilding invented by his brother Werner and himself. In 1844 he again came to England and patented his differential governor. Thenceforward he made England his home, and became a naturalised British subject in 1859. In 1862 he was elected a Fellow of the Royal Society, and was presented with the Royal Albert Medal (1874) and with the Bessemer Medal (1875) in recognition of his researches and inventions in heat and metallurgy. He filled the president's chair in the three principal engineering and telegraphic societies of Great Britain, and in 1882 was president of the British Association. He was knighted in April 1883, and died on November 19 of the same year. As manager in England of the firm of Siemens Brothers, Sir William Siemens was actively engaged in the construction of overland and submarine telegraphs. The steamship *Faraday* was specially designed by him for cable-laying. In addition to his labours in connection with electric lighting, Sir William Siemens also successfully applied, in the construction of the Portrush Electric Tramway (opened 1883), electricity to the production of locomotion. In his regenerative furnace (1856; see Vol. V. p. 240) he utilised in an ingenious way the heat, which would otherwise have escaped with the products of combustion. The process was subsequently applied in many industrial processes, but notably by Siemens himself in the manufacture of steel (see IRON). Of his miscellaneous inventions and researches, the following are particularly worthy of mention: A water-meter; a thermometer or pyrometer, which measures by the change produced in the electric conductivity of metals; the bathometer, for measuring ocean depths by variations in the attraction exerted on a delicately suspended body; and the hastening of vegetable growth by use of the electric light.

See his *Life* (1889) by Pole and his *Scientific Works* (1889).

Sienskiewicz, HENRIK, Polish novelist (see POLAND, p. 275) born in 1846, has visited California and Africa. A number of his works (*The Deluge*, *Children of the Soil*, *Yanko the Musician*, *With Fire and Sword*, *Quo Vadis?* &c.) have been translated—most of them by Jeremiah Curtin.

Sienna (Ital. *Siena*), a Tuscan city 60 miles by rail S. of Florence, with many mediæval features, such as its walls and citadel. The chief architectural glory of Sienna is her cathedral, one of the finest examples of Gothic work in Italy. It was begun early in the 13th century; in 1339 it was intended to build a vastly larger church, of which the existing cathedral should have been only one transept. But after the plague of 1348 the idea was abandoned, and only ruined walls indicate the ambitious design. The magnificent west front of

three arches was not finished until 1380; it is partly pointed, partly round-arched, and is enriched with red, white, and black marbles, gilding, and many sculptures. A fire did considerable damage to the exterior in 1890. A lofty square campanile stands on the south side. The art treasures of the interior embrace the wonderful octagonal pulpit by Niccolò Pisano (1268), similar to the one at Pisa; the marble mosaic floor of the cathedral, from designs by Buoninsegna and Beccafumi; the series of frescoes commemorative of the life of Pope Pius II., by Pinturicchio, in the Piccolomini Library, where



Cathedral at Sienna.

also are preserved several choir books splendidly illuminated by Siennese artists; the celebrated font (1428), with bas-reliefs by Donatello, Della Quercia, and other sculptors, in the church of San Giovanni, situated beneath the cathedral. The churches of Sant' Agostino, the Servites, San Domenico, and some others contain pictures by Sodoma, Matteo di Giovanni, and other Siennese artists. The greatly venerated church of St Catharine (q.v., a native of this city) stands on the site of her former dwelling-house; and not far away is the fountain of Fontebranda, celebrated by Dante. The municipal palace, a magnificent edifice of brick in the Pointed Gothic style, begun in 1288 and finished in 1309, is adorned on the exterior by a lofty tower (1325), and contains numerous paintings by Siennese artists. There are several noble palaces, as the Piccolomini, Tolomei, Monte de' Paschi, Loggia del Papa, some dating from the 13th century, and some now put to various public uses. The more noteworthy of the public institutions are the university, with faculties of medicine and law (less than 180 students), founded in 1203; the state archives and the town library; and an Institute of Fine Arts (1816), sheltering in its gallery many fine pictures by masters of the Siennese school, the principal of whom are Buoninsegna, the brothers Lorenzetti, Simone di Martino, Matteo di Giovanni, Peruzzi, Sodoma (Bazzi), and Beccafumi. The city has also given birth to a host of other illustrious men, as Aeneas Piccolomini (Pope Pius II.), Gigli (a scholar and a humorist), Bernardino Ochino, the two Socini (founders of Socinianism), and the architects

Agnolo, Agostino, and Della Quercia. Every July (2d) and August (16th) celebrated horse-races are held in the market-place, being the survival of still more widely celebrated popular festivals of the middle ages. The inhabitants, 28,500 in 1892, weave silk, manufacture cloth and hats, and carry on an active trade in wine and olive-oil. Sienna is the seat of an archbishop.

Shortly before or after the establishment of the Roman empire Sienna was made a Roman colony under the name of *Sena Julia*. After the empire was broken up the city soon formed itself into a free republic, governed by consuls, and grew so much in power and prosperity that it became the head of the Ghibelline towns in Central Italy. During this period (the 12th and 13th centuries) it had a dangerous rival in Florence, but inflicted a crushing defeat upon the Florentine militia at Montaperto in 1260. A century later, however, when hard pressed by Florence, the Siennese put themselves (1399) under the protection of the Duke of Milan. Nevertheless hostilities were frequently renewed with their powerful rival during the 15th century. Between 1487 and 1512 the virtual ruler of Sienna was Pandolfo Petrucci, called the Magnificent, who aimed at founding a dynasty in his native city similar to that of the Medici in Florence; but his descendants were not the men to realise his ambitions, and in 1524 the people, to escape from the dominion of the Petrucci, put themselves under the suzerainty of the Emperor Charles V. Yet soon afterwards the city revolted and called in the French to its aid; but it and its ally were defeated and Sienna itself besieged (1555) and taken. The emperor then gave it to Cosimo de' Medici (1557), who annexed it to Florence, and subsequently incorporated

it in the grand-duchy of Tuscany (q.v.).—The province of Sienna has an area of 1477 sq. m. and a pop. (1889) of 222,104.—For Sienna Earth, see BURNED SIENNA.

Sierra, the name applied in Spain and in Spanish-speaking countries to a range of mountains. It is usually derived from the Latin *serra*, 'a saw,' but more probably comes from the Arabic *schrah*, 'a desert place,' whence also Sahara.

Sierra Leone, a British colony—since 1888 a separate and distinct colony—on the west coast of Africa, stretching 180 miles along the coast, from the French colony of Rivières du Sud in the north to Liberia in the south, with an area of 4000 sq. m. (including the Los, the Banana, Tasso, and Sherbro islands). In 1896 a hinterland of 40,000 sq. m. was proclaimed a protectorate, and was organised after the troubles about the hut-tax in 1898 (which for a time caused some anxiety). The name Sierra Leone is more strictly confined to a densely-wooded peninsula, 26 miles long by 12 broad, jutting out to the NW., just south of the Sierra Leone (i.e. the river Rokelle) estuary, which rises to 3000 feet in Sugar Loaf Mountain. The climate is very hot and very moist. The rains last from April to December, and the annual rainfall ranges from 144 to 170 inches. The thermometer varies between 64°5' and 100°5' F. The low-lying districts are infested with a good deal of fever and malaria; but the higher parts are comparatively healthy. Sierra Leone is often called the 'White Man's Grave;' but the title would be just as appropriate

to any of the adjacent coast-regions of that part of Africa. The resources of the colony are by no means fully developed. Agriculture and trading employ each only about one-fifth of the population, which in 1890 numbered 75,000 individuals (60,546 in 1881; 37,039 in 1871). They are nearly all negroes, about one-half the descendants of liberated slaves, the others belonging to almost all the tribes of that part of Africa. But all the negroes are alike indolent, and the soil does not yield anything like what it is capable of yielding. Coffee, cocoa, tapioca, ginger, maize, cassava, and cotton are grown; but the bulk of the exports (ground-nuts, kola-nuts, benni-seed, ginger, hides, palm-oil and kernels, india-rubber, and gums) come from the interior. These commodities are exported to the annual average value of £332,600, of which Sierra Leone itself contributes but a very small part. Of the total value an average of £141,000 represents the exports to England. The import trade ranges between £248,000 (1886) and £390,000 (1890) a year, England's share falling between £190,500 (1888) and £295,000 (1890). Clothing, provisions, wine and spirits, iron and steel goods, haberdashery, gunpowder, and tobacco are the principal imports. The harbours of the colony are entered by 715 vessels of 250,000 tons every year. There is a little boat-building, mat-making, and cloth-weaving. The capital is Freetown (q.v.), now a fortified naval depot and coaling station. The colony is provided with good roads, and has a frontier police of 290 men (organised in 1890), besides part of the West India regiment (400 men). Fouray Bay College (1828), near Freetown, belongs to the Church Missionary Society, and was affiliated in 1876 to Durham University. There are four or five good schools, a lunatic asylum (100 inmates), and a savings-bank (1120 depositors, holding £16,485 in 1890) in the colony. Sierra Leone gives title to an Anglican bishop, and contains many Methodists, besides a large body of Mohammedans. The governor is assisted by an executive council of five members, and the same officials together with three other persons nominated by the crown constitute the legislative council. In 1897 the revenue was £106,000, and the expenditure £111,678; the public debt in 1897 was £25,000, but the sinking fund paid it off in 1898.

This district was discovered and named (from the lion-like thunder on its mountain-tops, Sierra Leone = Lion Mountain) by the Portuguese navigator, P. de Cintra, in 1462. In 1787 a body of freed slaves were planted here as a colony; but the enterprise was not a success. Four years later a second attempt was made by the Sierra Leone Company (which included amongst its promoters men like Granville Sharp, W. Wilberforce, and Sir R. Carr Glynn). But this scheme, even though supported by the arrival of 1200 freed negro slaves from North America, was not an unqualified success, and in 1807 the company transferred their rights to the crown. The boundaries of the colony have been gradually extended on all sides, except to the west, since 1862.

See T. R. Griffith, in *Proc. Roy. Colonial Institute* (1881-82); and Banbury, *Sierra Leone* (1888).

Sierra Madre ('Main Chain'), a general name for the mountains that in Mexico stretch northward from about Guadalajara to Arizona, forming the western wall of the plateau, and separating Chihuahua from the maritime states of Sinaloa and Sonora. Along the eastern foothills of the range, in north-west Chihuahua, the country is very fertile. The so-called Sierra Madre Plateau, on the United States frontier, is a northern continuation of the Chihuahua plateau.—The name has often been more widely extended, however, to include the central and eastern ranges of the Cordilleras.

Sierra Morena, a mountain-range, or rather a broad mountain-ridge in the south of Spain, forming the southern edge of the great central plain of the peninsula. It separates the basin of the Guadiana on the north from that of the Guadalquivir on the south, and ranges in height from 2000 to 5500 feet. Valuable mines of lead, silver, quicksilver, sulphur, and lignite, as at Tharsis and Rio Tinto, occur in certain parts of the system. It is frequently mentioned in *Don Quixote*, and is the scene of many of the incidents therein described.

Sierra Nevada (i.e. 'Snowy Range'), (1) a mountain-range of southern Spain, stretches east through the province of Granada to the frontiers of Almeria, is 60 miles in length, from 20 to 30 in breadth, and covers an area of 1060 sq. m. It forms a portion of the watershed between the streams that flow into the Mediterranean and those that flow into the Atlantic. The peak of Velate (11,670 feet) is the highest point of the Spanish Peninsula. The range receives its name from the perpetual snow which covers the highest summits (down to 11,000 feet). The system is connected with other mountain-masses in Spain, to north, east, and west, and its edges are much indented by deep valleys.—(2) A range of mountains in California, forming the eastern boundary of its Great Central Valley, and extending from north-west to south-east 450 miles, until in the neighbourhood of 35° N. this and the Coast Range meet and become continuous. Among the higher peaks of the Sierra Nevada are Mount Whitney (14,886 feet high), Mount Shasta (14,440), Mount Tyndall (14,386). Granite and metamorphic slate are the principal rocks; in some parts volcanic rocks are abundant. The sides of the range are covered with great forests, gold imbedded in quartz is found in large quantities, and silver-mines have been opened on the east side. The Southern Pacific Railroad crosses the range at an altitude of 7042 feet.—(3) *Sierra Nevada de Mérida* is the principal chain of the Andes in Venezuela, rising to over 15,300 feet.—(4) *Sierra Nevada de Santa Marta* is a system in the north of the department of Magdalena, in Colombia, flanking the sea, and stretching westward from near Venezuela to the low swamps and marshes of the Rio Magdalena (about 120 miles). The central knot consists of two tables, with from eight to ten separate summits, all capped with snow, the highest point variously estimated at from 16,400 (Sievers) to 17,500 (Simons) feet. The leading rocks are granite, syenite, and various slates, sandstones, quartz, and older eruptive rocks. The northern slopes are densely wooded with virgin tropical forests from 4000 feet downwards; the southern slopes are naked rocks above 6300 feet. The valley of the Rio Cesar is especially fertile, and in the mountains the Arhuacos Indians have even coca plantations. Copper, silver, and gold are found, and coal in the Rio Cesar valley. Much difference of opinion has existed as to whether this group is an independent system or connected with the Andes. Dr Sievers avers that they unite a little to the south of 11° N. lat. in the Sierra de Perijá, within a triangle formed by the towns of Fonseca, Treinta, and Soldado. See his *Reise in der Sierra N. de S.M.* (Leip. 1887); also a paper in *Proc. Roy. Geog. Soc.* (1881) by F. A. A. Simons, and another in *Scot. Geog. Mag.* (1887).

Sieyès, EMMANUEL JOSEPH, COMTE, who, as the Abbé Sieyès, figures prominently in the French Revolution, was born, the fifth child of an honest bourgeois family, at Fréjus, May 3, 1748. He had his education from the Jesuits at Fréjus and the Doctrinaire Fathers at Draguignan, and first wished to be a military engineer, but was condemned to the

clerical calling by the weakness of his health. He studied theology at Saint-Sulpice, where his originality and boldness of speculation caused no small misgiving to his masters, and completed his course at the seminary of Saint-Firmin. He became canon in the diocese of Treguier (1775), next chancellor and vicar-general of the diocese of Chartres, and was sent by the latter to the *Chambre Supérieure* of the Clergy of France. Between the dissolution of the Assembly of Notables and the reunion of the Constituent Assembly he published three famous pamphlets which carried his name over the length and breadth of France: *Vues sur les Moyens d'Exécution* (1788), *Essai sur les Privilèges* (1788), and, the most famous of all, *Qu'est-ce que le Tiers-État?* (January 1789). His answer to the last question was 'Everything'; 'What has it been hitherto?' was his next question; its answer, 'Nothing.' 'What does it desire to be?'—'Something.' He was elected one of the deputies for Paris, and it was on his motion (June 10, 1789) that the tiers-état sent a final invitation to the noblesse and clergy to join them, with the intimation that if they refused they would constitute themselves into the States-general. Seven days later the National Assembly was formed, the name being due to the suggestion of Sieyès. After Mirabeau made his memorable answer to the king's messenger, the Marquis de Dreux-Brézé (June 23), Sieyès reassured the members with the characteristically quiet words, 'Gentlemen, you are to-day what you were yesterday.' The deadly enemy of privilege, cold, inflexible, fearless in logic and trenchant in phrase, Sieyès gained great influence, and the division of France into departments for administrative purposes, declared in the last two months of 1789, was mainly his work. He took part in the memorable declaration of the Rights of Man (August 26, 1789), and opposed the royal veto, during the great debate on which question Mirabeau invoked the counsel of Sieyès as that of a man 'whose silence and inaction I regard as a public calamity.' But he kept aloof from Mirabeau's alliance, opposing his policy alike in the last measure and in his refusal to the Assembly of the right of nominating the Regent in the event of the king's death. He was elected to the National Convention, sat in the centre, voted for the king's death *sans phrase* (though he afterwards denied adding these words to the one word *mort*); but as the Revolution grew sank into 'philosophic silence,' his heart filled with disdain alike at its illogical excesses and the bombastic rhetoric of its leaders. Asked long afterwards what he had done during the Terror, he is said to have replied, 'J'ai vécu.' He opposed the new constitution of Year III. (1795), and declined a seat on the Directory named by the new Corps Législatif, which entered on its functions on the 27th October of that year, but had a share in the *coup d'état* of 3d September 1797 (17th Fructidor). In 1798 he went on mission to Berlin, was elected to the Directory in 1799, and now, like Burras a traitor to the Republic, he plunged into a web of dark intrigues with a view to find a soldier who would be content to be an instrument. Bonaparte returned from Egypt on October 25, 1799, and together they plotted the revolution of the 18th Brumaire (November 9, 1799), the result of which was the institution of the Consulate of Sieyès, Bonaparte, and Roger Ducos. Once more he drew upon his skill as a framer of constitutions, his final effort being a masterpiece of complexity beyond the calculating machine of Pascal, its aim to break the force of democracy by dividing it, to triumph over the passions of men by cunningly balancing them the one against the other. But he soon discovered in his new ally a master. Finding himself befooled by Bonaparte, he threw up his consulship

in disgust, his last illusion shattered for ever. His fall was somewhat gilded over by the title of Count, a sum of 800,000 francs, and the estate of Crosne. The presidency of the senate was offered him later, but declined. He wrapped himself in morose meditations during the Empire, filled with silent irony and scorn for that humanity which had so little realised his views. Exiled at the Restoration, he lived in Belgium for fifteen years, returned in 1830, and after a long illness in which his mind often wandered to the Terror and the sinister name of Robespierre, died at Paris, June 20, 1836.

The influence of Sieyès upon the Revolution is clear enough, but the man remains wrapped in shadow. He was reserved and solitary from his youth, but we may write over against this that he was passionately fond of music, and that a woman once said of him, 'Quel dommage qu'un homme si aimable ait voulu être profond!' He believed absolutely in the infallibility of his own abstractions: 'Polity is a science I have completed,' he said to Dumont. Rigorous in everything—in nothing more than in the closeness of the bond between logic and language—he would have reduced to a merciless and inflexible system every aspiration of mankind. But he revealed a fundamental want of insight into the nature of man in thinking that masses of men could ever be governed by bare reason alone. For human nature remains much more complex than the subtlest calculations, the factors in the process obscure, the conclusion still uncertain. Sieyès was himself a creature all head, to the complete exclusion of heart, exactly what he wanted his human puppets to be, and the end of all his scheming was discomfiture and a name in history to inspire respect, not sympathy.

See E. de Beauverger (1851), Mignet's *Notices historiques sur Sieyès* (1853), Sainte-Beuve's *Causeries du Lundi* (vol. v.), and a work on Sieyès by Bignon (1894).

Sigfried. See NIBELUNGENLIED.

Sight. For the organ of sight, its anatomy, physiology, defects, and diseases, see EYE; also BLIND, COLOUR-BLINDNESS, OPTICS. For the theory of vision, see VISION.

Sigillaria (Lat. *sigillum*, 'a seal'), a family of fossil plants, which ranges from the Devonian to the Permian system, but is more especially abundant in Carboniferous strata. The plants had slender, pillar-like trunks, some of which attained a diameter of 5 feet and were proportionately tall, reaching a height of 50 to 70 feet. Towards the top they branched dichotomously several times. The columnar stems are ribbed and fluted longitudinally in a very regular manner, the flutings being marked by rows or whorls of scars left by fallen leaves. The form of these seal-like scars is very variable, but they are all so arranged that the scars of each horizontal row are placed in the intervals between the scars of the rows immediately above and below. The thick dichotomous branches of the tree were clothed with long grass-like leaves. The fruit is still unknown, some botanists supposing that Sigillaria had cones like those of lycopods, while others think it probable that the fruit resembled that of yew-trees. The structure of the stem is peculiar: the external rind or coat is hard, beneath that is a great thickness of cellular tissue traversed by rope-like bands of fibres forming an inner bark, while in the centre is a comparatively small firm woody axis. The roots usually start from the stem in four main branches, which divide dichotomously several times, and then extend for long distances like great cylindrical cables, which, Sir W. Dawson considers, were intended to anchor the tree firmly in soft and

marshy ground. Cylindrical rootlets proceeded from these long cable-like roots in a regularly spiral manner, and when they decayed they left rounded scars. These roots were formerly supposed to be a distinct species till stems of *Sigillaria* were found with *Stigmariam* roots attached.

The stem of *Sigillaria* is not often so well preserved as to show any structure, or even its cylindrical form. It generally occurs as a double layer of coal exhibiting on the outer surfaces the scars produced by the bases of the leaf-stalks. Indeed from the fact that most coal-seams are underlaid by what appear to be old soils or underclays, which are crowded with roots, it would seem that *Sigillaria*, and probably other trees with *Stigmariam*-roots, enter very largely into the formation of many coal-seams. Some of the more impure coals, which are interlaminated with shale, &c., consist principally of the flattened stems of *Sigillaria* mixed with the debris of other plants. From this and other evidence Sir W. Dawson is of opinion that the growth of a forest of *Sigillaria* and other trees having *Stigmariam*-roots was the first step towards the accumulation of a bed of coal, and that the formation of this coal terminated as it had begun by a forest growth. This is shown by the fact that

Sigillaria restored: a, in some localities erect stumps *Sigillaria Brownii*; b, *S. elegans*. (After Dawson.)

Botanists are still undecided as to the position of *Sigillaria*. Some eighty species have been described from the Carboniferous system, and many more must have existed; and it is quite probable, as Sir W. Dawson thinks, that the group of *Sigillaria* may eventually be divisible into several forms. He considers that some will come to be classed with the *Lepidodendroids*, while others will prove to be allied to the pines and cycads (*Gymnospermæ*). See Dawson's *Geological History of Plants* (1888), and *STIGMARIA*.

Sigismund, emperor of Germany (1411-37), the son of the Emperor Charles IV., was born on 14th February 1368. He was made king of Hungary when only nineteen, succeeding to that dignity through his wife. In 1396 at the head of a numerous army he attempted to relieve the Byzantine empire from the Turks, but was terribly defeated at Nicopolis (28th September). Some years later he conquered Bosnia and Herzegovina and reduced Serbia to his sway. In 1411 he was proclaimed emperor on the death of Rupert. One of his earliest acts as emperor was to induce Pope John XXIII. to call together the Council of Constance for the purpose of putting an end to the Hussite and other schisms. But although he supported the party of reform, he made no effort to uphold the safe-conduct he had granted to Huss, and permitted him to be burned by his enemies. In return for this breach of faith his succession to the throne of Bohemia, after his brother's death, was opposed by the Hussites; and they maintained their opposition so stoutly that it was 1436 before Sigismund, making concessions, could put the crown of Bohemia on his head. But in the year following he died at Znaim, on 9th

December. This emperor possessed many of the qualities of a capable ruler, and made praiseworthy attempts to introduce various reforms in the administration of the empire; but his efforts seem to have been frustrated in great part by his own lack of decision and by his chronic want of money.

See works by Aschbach (4 vols. Hamb. 1838-45), Bezold (Mun. 1875), Lenz (Berl. 1874), and Windecke (Ger. trans. Leip. 1886).—For the Polish Sigismunds, see POLAND.

Signaringen. See HOHENZOLLERN.

Signalling is the means of transmitting intelligence to a greater or less distance by the agency of sight or hearing. Incomparably the most powerful medium yet known for this purpose is the electric current (see TELEGRAPH, TELEPHONE). The electric current requires fixed or (as in the case of field telegraphy) travelling apparatus establishing an actual communication between the two points; and is therefore inapplicable to the ordinary cases of ships interchanging signals with each other or with the shore. For railway signals, see RAILWAYS, Vol. VIII. p. 558.

The ancients seem to have elaborated a fair system of night-signals by torches for military purposes (see BEACON); but in naval affairs the ships sailed so close together that orders could be communicated by word of mouth, while the turning of a shield from right to left sufficed as sailing directions to the several lines. In the time of James II. a ship's signal could only be expressed by flags, in confusing number, hung in different parts of the vessel.



N.B.—When used as the 'Code Signal,' this Pennant is to be hoisted under the 'Ensign;' when used as the 'Answering Pennant,' where best seen.

			BLUE RED YELLOW WHITE

Fig. 1.—Flags of the International Code of Signals.

Thanks to Sir Home Popham, Marrayat, and other inventors, the system has been adopted of hanging a number of flags under one another, each symbol or combination having an arbitrary conventional

meaning attached to it. In consequence of action taken by the British Board of Trade, the system of sea-signals called the *International Code of Signals* was compiled in 1857 and adopted by nearly all the commercial nations of the world. Except for confidential signals, it is also used on board the ships of the British royal navy. The system consists of eighteen flags and a code pennant (see fig. 1).

In using and interpreting these signals it is of course necessary to be in possession of the signal code-book, in which the arbitrary meanings attached to the flags and combinations of the flags are printed, but the general nature of the meaning of a hoist can be determined by the form of the hoist. This is the case because the meanings of the hoists are arranged in the signal-book upon the following plan, viz.: (1) Signals made with two flags: If burgee (B) is uppermost, it is an attention signal; if a pennant (C, D, F, or G) is uppermost, it is a compass signal; if a square flag (H to W) is uppermost, it is an urgent or distress or

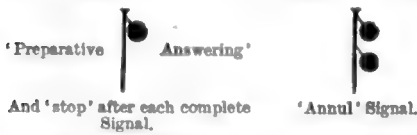

B	J	Q
C	K	R
D	L	S
F	M	T
G	N	V
H	P	W

Fig. 2.—Distant Signals.

danger signal. (2) Signals made with three flags: The meanings of these are not classified according to the top flag; they relate to general subjects of inquiry or communication. (3) Signals made with four flags: If burgee (B) is uppermost, it is a geographical signal; if one of the three pennants C, D, or F is uppermost, it is a spelling or vocabulary signal; if the pennant G or a square flag (H to W) is uppermost, it is the name of a man-of-war or merchant ship. All the two- and three-flag hoists, and also the four-flag geographical hoists, have the same meanings printed in the signal-book of the various nations which have adopted the code, each nation printing its own copy of the signal-book in its own language, and thus two ships, totally ignorant of each other's language, may converse by means of these flags.

As signal-flags can only be used within distances across which their colours are distinct, the flag code has been supplemented by what are called distant signals. They are made by taking any two square flags, any two pennants, and two balls, and making the signals for the letters on the flag-plate by the combinations shown in fig. 2. The interpretations are made in the usual way by the aid of the signal-book.

Still further to increase the use of the code, a system of semaphore signals is also available in the same code, the ball of the distant signal being replaced by a level arm, the square flag by an arm pointing upwards, and the pennant by an arm pointing downwards. The semaphore alphabet is shown in fig. 3.

These may also be used from boats or from a boat's crew on a beach by making three persons hold out something resembling a ball, pennant, and flag, and reading from left to right. A hat, a man's arm, and a square handkerchief do very well.

In this code the largest possible number of two-flag hoists is 306, of three-flag hoists 4896, and of four-flag hoists 73,440, giving a possible total of 78,642 different signals.

These signals are of use only during the day. The question of *Night-signalling* at sea is now engaging attention.

In H.M. royal navy, where the use of the semaphore is far more common than in the merchant service, the electric light is utilised to make semaphore signals visible at night. The form of night-signalling which finds most favour is that of flashing lights. Several ingenious inventors have produced flashing lights visible at long distances. It is probable that signalling by long and short flashes, using the Morse code in connection therewith, will ultimately become common at sea, especially as the same code may be used along with long and short blasts on a steamer's whistle or other sound signal, and the signals so made could be interpreted either with or without the signal code-book at will.

The international signals used by vessels which are in *distress* and want assistance are: In the day-time, a gun fired at intervals of about a minute, or the flags NC, or a square flag having a ball above or below it; in the night-time, a gun fired at intervals of about a minute, or flames, as from a burning tar-barrel, oil-barrel, &c., or rockets or shells of any colour or description, fired one at a time at short intervals.

For the numerous signals to be made by the various classes of vessels at sea at night or in fog, &c., reference may be made to the *Regulations for Preventing Collisions at Sea*, issued in pursuance of the Merchant Shipping Amendment Act, 1862, and as altered in 1885. Briefly, these declare that at

B	J	Q
C	K	R
D	L	S
F	M	T
G	N	V
H	P	W

Fig. 3.—Semaphore Alphabet.

night a steamer shall show a white elevated light visible round twenty points of the compass, a star-board green light, and a port red light each visible ten points. A steamer towing doubles the white masthead light. A sailing-vessel is to show only the red and green side-lights. Trawlers and net and line fishers have special lights. A pilot-vessel shows a white fixed light and a flash-light. All vessels at anchor show a white light. Vessels being overtaken show a white stern light.

Vessels broken down show (vertically) three black balls in the day and three red lights at night. A telegraph ship shows three shapes—red, white, red—in the day (the reds globe-shaped, and the white diamond-shaped), and three lights—also red, white, red—at night. In fog, mist, and falling snow, both day and night, all vessels at anchor ring a bell; steamers going make long blasts on the steam-whistle; sailing-vessels going make one, two, or three long blasts on a fog-horn; and fishermen not at anchor sound the fog-horn and bell alternately; all at intervals not exceeding two minutes. A steamer turning its head to starboard, to port, or going full speed astern may indicate the same to a vessel in sight by making one, two, or three short blasts respectively on the steam-whistle. These are practically international signals.

A vessel wanting a pilot shows the flags PT, or the Jack (or other national colour) at the fore; or at night burns a blue light, or flashes a white light at short or frequent intervals for about a minute at a time.

The use of signals to indicate to the mariner or others the approach of storms has now become common in maritime countries. In Great Britain the probable approach of a gale from points from SE. round by south to NW. is indicated by a cone in the daytime, point down, and at night by three red lights in a triangle, point down; and the probable approach of a gale from NW. round by north to SE. is indicated by the cone or triangle of lights being hoisted point up. In France a drum in addition to the cones is hoisted when necessary to indicate greater force of wind. Besides these a flag, a short pennant (cornet), and a pennant of any colour mean respectively doubtful weather—barometer tending to fall, bad weather, and appearance of better weather in the open sea. In Germany a ball indicates caution; a cone point down, storm from SW.; cone point up, storm from NW.; two cones points down, storm from SE.; two cones points up, storm from NE. One square flag hoisted in addition indicates that the wind will probably change to the right hand, and two such flags that it will probably change to the left hand. In the Netherlands the Aeroklinoscope (invented by Buys-Ballot, q.v.) is used. It is simply a beam, half red, half white, with a ball suspended from the white arm, the whole being capable of rotation in both a horizontal and vertical plane. The arm is pointed horizontally in the direction of the two stations having the greatest difference of height of barometer readings, and the end of the beam pointing towards the place of the highest barometer reading is then tipped up in proportion to the difference of the barometer readings at the two stations in question.

In the United States a square red flag with a black centre indicates a violent storm; a yellow flag with a white centre, a light storm; a red pennant indicates that the storm trough is approaching the station, and a white pennant that the storm trough has passed the station. Further, if the red or white pennant is hoisted above the square flag, the station is probably on the north side of the centre of the storm; and if the red or white pennant is hoisted below the square flag, the station is probably on the south side of the centre

of the storm. A yellow pennant means 'call at the station for special weather information.' At night a red light indicates easterly winds, and a white light above a red light westerly winds. This harmonises with the red flag (easterly) and the white flag (westerly) in the day-signals. The United States weather bureau has also recently arranged to hoist the following 'forecast' signals—viz. white flag for fair weather; blue flag for rain or snow; blue and white flag for local rains; triangular black flag above these for higher temperature, and below for lower temperature; and white flag with black square in the centre for cold waves or frosts.

Many local signals of different kinds are in use: e.g. at Mauritius a white flag with horizontal blue stripes below a ball means 'prepare for bad weather, and a red flag below a ball means 'take lower yards and topmasts down.' In Mexico a red flag means 'a norther may be expected.' Some other countries have adopted the simple signals used in Britain; but it is to be regretted that a uniform system of storm-warning signals is not universally adopted.

The system of visual signalling adopted in the British army is a combination of short or long flashes by lamps at night, and the alternate appearance or obscuration of any given object by day (revolving shutters or discs, semaphores, collapsible cones, flags, or even jets of steam), and if visible symbols are not available, short and long sounds on a fog-horn, bangle, or steam-whistle may be used. By any of these means the dot and dash of the Morse alphabet, as used in telegraphy, can be expressed; but the regular method is to use flags or mirrors (see HELIOGRAPHY) if the sun is shining by day, and lamps at night. Every regiment and battalion trains a number of its officers and men each year in signalling, which has been found to be of the greatest use on active service, especially in savage countries. Not only messages but drawings have been sent by signal—using paper covered with numbered squares—e.g. the position of the Afghans on the Peiwar Khota (1878) was in this way signalled back by the advanced parties. Fig. 4 shows the manner of working the flag: from *a* to *b* and back to *a* is a dot, from *a* to *c* and back to *a* is a dash. The code and numbers laid down in the army and navy signal-book are sometimes used instead of spelling the words by the Morse alphabet. This prevents unauthorised persons reading the signals.—For Lloyd's Signal Stations, see LLOYD'S.

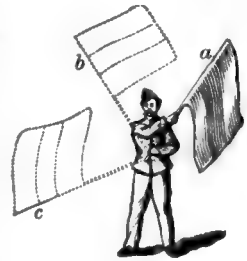

Fig. 4.

Signature. See BOOK, Vol. II. p. 300. For signing, sealing, and delivering, see DEED.

Signatures, THE DOCTRINE OF, an inveterate belief in early medicine that plants and minerals bore certain symbolical marks which indicated the diseases for which nature had intended them as special remedies. These figures, of course, were not the result of chance, but the evidence of Providence, being really the characters and figures of those stars by whom they are principally governed and endowed with particular virtues. And the doctrine brings us into the wider region of magic in its fundamental confusion between an object and its image, the word and its idea. Many names witness to a belief in this theory, as *mandrake*,

kidneywort, *scorpion-grass*, and the *Euphrasia* or eyebright. In the case of the last, for example, the plant was supposed to be good for the eyes, because of a black pupil-like spot in its corolla; and by an analogous process of thought the yellow turmeric was thought good for jaundice, the bloodstone for stopping bleeding. Similarly white things were regarded as refrigerant, red as hot. So in small-pox red bed-coverings were used, with the view of bringing the pustules to the surface of the body; red things were to be looked upon by the patient; burnt purple, pomegranate seeds, mulberries, and other red ingredients were dissolved in his drink. John of Gaddesden, physician to Edward II., directs his patients to be wrapped up in scarlet dresses, and claims by this means to have recovered the young prince quickly from an attack of small-pox. Wraxall, in his *Memoirs*, tells us that this was done so late as 1765 with the Emperor Francis I. when ill with smallpox. See PLANTS, Vol. VIII. p. 222; and T. J. Pettigrew, *On Superstitions connected with Medicine and Surgery* (1844).

Signboards were known to both Greeks and Romans. There are allusions to them in classic writers; and specimens have been found at Pompeii and Herculaneum, sometimes painted, but oftener carved. A bush was the sign of many taverns so late as the reign of James I., and the antiquity of that sign may be inferred from the analogy of our proverb, 'Good wine needs no bush,' to the Latin 'Vino vendibili suspensâ hederâ non opus est.' During the illiterate middle ages every trade had its emblem, some of which have survived to our day, as the chemist's pestle and mortar, the pawnbroker's three balls, and the barber's pole, with in Scotland (as on the Continent) the brazen basin, which recalls Don Quixote. Besides these trade emblems, every individual trader might have his own special device: Southey's father, a Bristol linen-draper, for his chose a hare. The old printers' emblems, described in Vol. II. p. 303, were akin hereto, as to-day are trade marks. During the 16th and 17th centuries huge painted signs came greatly into vogue. They were suspended either from projecting metal-work, from a post or an obelisk, or from a sort of miniature triumphal archway, and sometimes cost great sums—e.g. £1057 for the 'White Hart' at Scole in Norfolk, erected in 1655. These creaking and ponderous signboards proved a source of annoyance, sometimes of positive danger, as when in 1718 one in Bride's Lane, Fleet Street, dragged down a house front, and killed in its fall four persons. So in 1762-70, under act of parliament, the London signboards were either wholly removed or at least affixed to the fronts of the houses; and this example was gradually followed throughout the kingdom, though here and there signposts linger, or have been restored—even in London. One of the oldest and most interesting signs still existing is the 'Red Lion' at Martlesham, Suffolk, for it was the figurehead of one of the Dutch fleet defeated off Southwold in 1672; but the history even of vanished signboards has no slight interest. A good many signboards have been painted by great artists, Holbein, Correggio, Paul Potter, Hogarth, Wilson, Morland, David Cox, 'Old' Crome, Sam Bough, and Sir J. E. Millais (some of which are still extant); and nearly every sign had its curious origin, hard though it may be to come at. Thus, there were the religious signs ('Salutation,' 'Lamb and Flag,' &c.), historical signs (as the 'Royal Oak' and 'Marquis of Granby'), heraldic (coats of arms, crests, and badges), humorous (as the 'Good Woman,' without a head), and a host of others. Not the least curious feature about old signs is the havoc played on them by 'folk-etymologies,' which have, for instance, corrupted the 'Bacchanals' into 'Bag o' nails,' 'Boulogne Mouth'

(i.e. the entrance to Boulogne harbour) into 'Bull and Mouth,' the 'Catherine Wheel' into 'Cat and Wheel,' and, more dubiously, 'Caton fidèle' (a faithful governor of Calais) into 'Cat and Fiddle,' 'God encompasseth' into 'Goat and Compasses,' and 'Piga wassail' (A.S., 'Virgin, hail,' or 'a lass and a glass') into 'Pig and Whistle.'

See Larwood and Hotten's *History of Signboards* (1866), Miller-Christy's *Trade-signs of Essex* (1887), and F. G. H. Price's *Signs of Old Lombard Street* (1887).

Signet, in England, one of the seals for the authentication of royal grants; for its use and for the signet office, now abolished, see SEAL, p. 277. The signet in Scotland is a seal which seems to have been originally intended to authenticate royal warrants connected with the administration of justice. The principal class of solicitors in Scotland are called Writers to the Signet, from their having been originally clerks in the office of the king's secretary, it being their duty to prepare all warrants for charters or grants to be passed under either the Great Seal or Privy-seal, such warrants being called from an early period 'signatures,' because they bore the signet of the king. Writers to the Signet and Solicitors before the Supreme Courts were long the only solicitors allowed to act as agents in the Supreme Courts. But by the Law Agents Act of 1873 any person duly admitted a law agent can practise in any court in Scotland. See SOLICITORS.

Sign-manual, ROYAL, the superscription of the sovereign, which must be adhibited to all writs which have to pass the Privy-seal or Great Seal. When attached to a grant or warrant it must be countersigned by one of the principal secretaries of state, or by the Lords of the Treasury. For certain deeds of minor importance a *cachet* or stamp of the royal signature is used.

Signorelli, LUCA, Italian painter, was born about 1441, at Cortona, being a distant relative of Vasari, the historian of Italian art. He studied under Piero della Francesca of the Umbrian school, but seems to have learned most from observation of the human form. During the first half of his life he had apparently no settled home; at all events he worked in various towns in Italy. At Loretto he painted a number of frescoes of sacred subjects, commissioned by Pope Sixtus IV.; in the Sistine Chapel the fresco called the Acts of Moses; and for Lorenzo de' Medici the picture known as the School of Pan. This last design he subsequently repeated on the wall of Pandolfo Petrucci's palace at Sienna; in a convent of that same city he painted, after 1497, eight frescoes illustrating the Life of St Benedict. But the greatest achievement associated with his name is a number of frescoes, depicting such subjects as the Fall of Antichrist, Punishment of the Wicked, the Last Days of Earth, done on the walls of a chapel of the cathedral in Orvieto. The boldness and grandeur of invention shown in these designs, and the powerful modelling of the nude forms, suggest comparisons with Michelangelo. Signorelli was one of the painters summoned to Rome by Pope Julius II. in 1508 to adorn the Vatican, and along with his colleagues was dismissed to make way for Raphael. In his native town he left many proofs of his artistic skill, and died there in 1525.

See Crowe and Cavalcaselle's *History of Painting in Italy* (1864-71), Sidney Colvin in the *Cornhill* for 1875, and R. Vischer's *Luca Signorelli* (Leip. 1879).

Sigourney, MRS LYDIA HUNTLEY (Huntley being her maiden name), American authoress, was born at Norwich, Connecticut, 1st September 1791. For five years she taught a class of ladies in Hartford; in 1815 she published *Moral Pieces in Prose and Verse*; and in 1819 she married a Hartford

merchant. In 1822 she published a descriptive poem on the *Traits of the Aborigines of America*; and in 1824 a *Sketch of Connecticut Forty Years Since*. These were followed by *Pocahontas and other Poems, Lays of the Heart, Tales in Prose and Verse, &c.*, and *Letters to Young Ladies and to Mothers*, both of which passed through many editions, in England as well as America. In 1840 she visited Europe, and on her return wrote her *Pleasant Memories of Pleasant Lands*. She compiled amusing and instructive books for the young, and was a constant contributor to magazines and other periodicals of poems, whose subjects, style, and sentiment gave her the designation of 'the American Hemans.' She died at Hartford, 10th June 1865. See her autobiographical *Letters of Life* (New York, 1866).

Sigurd, or SIGFRIED. See NIBELUNGENLIED.

Sihûn. See JAXARTES.

Sikhs, a religious sect of Northern India, which became a great military confederacy. The sect was founded by Baba Nanak (born in 1469), who rejected the institution of caste, idolatry, and superstition, preached the existence of One spiritual God, and inculcated a higher moral life. He was followed in the headship of the sect—'Sikhs' means 'followers' or 'disciples'—by ten 'gurus' or chief-priests. The third of these excavated the sacred tank at Amritsar; and his son, Arjun Mal, built, towards the end of the 16th century, the holy temple, in the tank at Amritsar, which became the headquarters of the Sikh religion. The same guru first edited the *Adi Granth*, the sacred book of the Sikhs. As time went on the adherents of the sect, principally Jats by race, gradually becoming conscious of their numbers and their growing power, began to adopt something of a military organisation in addition to their religious discipline. This end—converting them into a powerful military community—was deliberately pursued by the guru Govind Rai (1675–1708); he adopted the appellative Singh (or Sing; better Sinh, 'lion') as a generic family-name for all members of the sect, strengthened the bonds of personal discipline, and revised the sacred book so as to bring it into harmony with the altered aims and position of the Sikhs. See INDIA, Vol. VI. p. 107.

On the downfall of the Mogul power, shortly after the middle of the 18th century, the Sikhs formed themselves into a number of tribal and territorial confederacies, some of which were virtually independent states. Their religious fanaticism was fanned by a body of devotees, who dedicated themselves to warlike pursuits; and the Sikhs greatly extended their possessions. It was, however, Ranjit Singh (q.v.), a young and warlike chieftain, who converted the Sikh confederacies into a powerful and formidable military power, by welding the separate confederacies into one organic whole and carrying his arms westwards, northwards, and southwards. On the east alone he made no conquests; he had in 1809 concluded a treaty of peace with the British, whose authority reached to the Sutlej, which was the eastern boundary of the Sikh dominions. This agreement Ranjit faithfully kept; but at his death he left an army of 124,000 men, animated by a warlike spirit and inspired by religious enthusiasm—a force that had been thoroughly organised and drilled by French officers on the European system. But there was none amongst his immediate descendants capable of taking up the sceptre he let fall, and wielding it with the same energy and skill. Amid the anarchy that followed his death, the soldiers of his armies clamoured to be led against the forces of the British; and accordingly in December 1845 they crossed the Sutlej and invaded British territory.

Their advance guard was, however, routed by Sir Hugh Gough at Mudki (18th December), though not without heavy loss to the British, 'Fighting Bob' Sale being amongst the slain. The main body entrenched themselves at Firozshah, 12 miles east of the river; but their camp was stormed, after two days' desperate fighting, by Sir Hugh Gough and Sir Henry Hardinge (governor-general) on December 21st and 22d. Another Sikh army that crossed the river was defeated and driven back by Sir Harry Smith, at Aliwal (28th January 1846); and on 10th February Gough and Hardinge totally crushed and dispersed the Sikh forces at Sobraon. The British at once captured Lahore, and on the 9th March following peace was signed between the combatant parties, the Sikhs ceding the districts between the rivers Sutlej and Ravi, and subsequently, in lieu of a money indemnity, Cashmere, the hill-country of Hazara, and some other portions of territory.

Two years later war broke out again, caused, as the first conflict was, by Sikh fanaticism: two British officers were massacred at Multan in April 1848. And although Lieutenant Herbert Edwardes attempted to check the movement at its beginning, the war became general. Multan was taken; but the battle of Chillianwala (13th January 1849) was left undecided, in spite of very heavy losses on the British side. At Gujrat, however, on 21st February, Gough finally crushed the Sikhs and effectually broke their power. After this the Punjab was annexed to British India. And so successfully was its government organised and administered by Lord Dalhousie and John and Henry Lawrence that on the outbreak of the Mutiny the Sikhs not only refrained from joining the rebel sepoys, but lent very material assistance in quelling that formidable outbreak. The Sikhs still constitute about 6 per cent. of the population of the Punjab; and there are connected with the Punjab government fifteen protected Sikh states, of which Patiala is the principal. In 1891 the Sikhs numbered 1,907,836.

See J. D. Cunningham, *History of the Sikhs* (1849); Sir J. Malcolm, *Sketch of the Sikhs* (1812); Trumpp, *The Adi Granth* (Lond. 1877), and *Die Religion der Sikhs* (Leip. 1881); Gough and Innes, *The Sikhs and the Sikh War* (1897).

Si-kiang, a river of China, rises in Yunnan, and flows east till, just above Canton (q.v.), it turns south and pours its waters into the Chinese Sea. Canton and Hong-kong stand on the eastern arm of its delta, and Macao on the promontory that divides it from this arm, the Canton River.

Sikkim, a protected state in the north-east of India, bordering on Tibet, Nepal, and Bhutan. Area, 2700 sq. m.; pop. 30,500, mostly Buddhist Rongs or Lepchas, akin to the Tibetans. The state lies on the southern slopes of the Himalayas, has mountains reaching to 24,000 feet and mountain-passes at 16,000 feet. Swift torrents flow at the bottom of precipitous ravines; and valleys and lower slopes are clothed with forest. The raja, who resides at the village of Tumlong, ceded Darjeeling to the British in 1835, having already acknowledged their 'protection' in 1816. The trade with British India was, in 1890–91—exports to India, £10,000, and imports thence, £8215; in 1897–98, exports, £3292, and imports, £2433. The treaty of 1890 gave Britain exclusive control over its internal and foreign affairs.—The district of Darjeeling (q.v.), which borders on Sikkim state, is often called British Sikkim.

Sikrol, or SECRELE. See BENARES.

Silage is the term applied to fodder which has been preserved by the process of Ensilage. Ensilage is a French word, tracing through the Spanish, from the Lat. *sirus*, Gr. *siros*, 'a pit,' whence

the Spanish verb *ensilar*, 'to store grain in a silo or pit.' It was originally employed to denote the preservation of green forage in an air and water tight silo—the contents being tightly pressed down so as to get rid of and permanently exclude the oxygen of the air, and thereby prevent putrefactive fermentation. The practice, since its introduction into the British Isles, has been considerably extended, so that the term silage is now applied to fodder which has been preserved by pressure in stacks as well as to that preserved in silos by pressure. The practice of ensilage is of great antiquity. From time immemorial grain has been stored in underground pits in eastern countries. In the time of Pliny it was, he tells us, pursued with success in Thrace, Cappadocia, Barbary, and Spain. Varro also speaks approvingly of the process, and asserts that by it wheat could be preserved fresh for fifty years and millet for a century. In early times it was probably employed chiefly to hide stores of grain from invaders. It is now used mainly in the preserving of green food for cattle and horses. The converting of green fodder, as distinguished from ripened grain, into silage is believed to have been first practised in Germany. In 1843, in the *Transactions of the Highland and Agricultural Society of Scotland*, Professor Johnston gave a detailed description of the German system of making 'sour hay.' The practice spread through the Austro-Hungarian empire, where graves or trenches, 4 feet by 6 or 8 feet in breadth and depth, were dug and crammed with green grass or green Indian corn, the whole being covered over with a foot of earth. The distinction of first succeeding in directing general attention to the subject was earned by a Frenchman, M. Goffart, whose book, *Manuel de la Culture et de l'Ensilage des Mais et autres Fourrages verts*, published in 1877, was not only widely read in his own country, but was translated into English and published in New York in 1879. The method had already been tried to a small extent in America, and the perusal of M. Goffart's work aroused the deepest interest and led to numerous and extensive experiments. The general results were satisfactory, and soon the system found its way into Great Britain. Although several trials were made earlier, the systematic and extensive adoption of ensilage in the United Kingdom dates from 1882. In that year the successful experience of Vicomte Arthur de Chezelles, who had been pursuing the system upon a large scale in France, was made known through the press to British farmers. A host of experimentalists were instantly at work, and so keenly was public attention aroused that in 1883 the Ensilage Commission, a private but highly influential body, was formed to collect evidence and consider and make known the merits of the practice. A mass of valuable information was collected and was embodied in the official blue-books issued by the government.

The commission reported strongly in favour of the system, concluding as follows: 'After summing up the mass of evidence which has reached us, we can without hesitation affirm that it has been abundantly and conclusively proved to our satisfaction that this system of preserving green fodder crops promises great advantage to the practical farmer, and, if carried out with a reasonable amount of care and efficiency, should not only provide him with the means of insuring himself to a great extent against unfavourable seasons, and of materially improving the quantity and quality of his dairy produce, but should also enable him to increase appreciably the number of live-stock that can be profitably kept upon any given acreage, whether of pasture or arable land, and proportionately the amount of manure available to fertilise

it.' From 1883 the progress of the movement in Great Britain was rapid. The British agricultural returns first included statistics as to ensilage in 1884. In that year 610 silos were reported as existing in Great Britain. In the next three years the number increased to 2694. By 1887 it was proved by repeated experiments in England that silage might be made in stacks as well as in silos, and, as would be expected, the discovery of the fact that the advantages of ensilage could be attained without incurring the cost of constructing a silo gave a great stimulus to the movement. It is found in practice that the percentage of loss by the spoiling of the food is rather greater in the stack than in the silo, but the balance of advantages is in favour of the stack, which has therefore gained the lead in popularity. Silos are in almost all conceivable forms, some specially constructed at great expense, others 'converted' from existing buildings at small outlay. The cost of construction has varied so much as from 8s. to 50s. per ton capacity. The methods of pressure employed consist of dead weights or of mechanical appliances. The latter, being more convenient in application, are now most largely used. Many ingenious contrivances have been tried for pressing silage. One of the most popular methods is by jacks, screw, and hydraulic. Several systems of pressure which have been patented are found to work admirably, both in silos and stacks. Two varieties of silage are made, the one 'sweet,' the other 'sour.' Originally all the silage made was of the latter kind. In 1884 Mr George Fry, of Chobham, England, made known the results of experiments by which he proved that 'sweet' or 'sour' silage might be produced at the will of the farmer. Prior to 1884 it was the universal custom to apply pressure as soon as the silo was filled. The product of that method was invariably 'sour' silage. Mr Fry filled his silo without packing the material, and deferred applying pressure for two or three days, until the temperature of the silage rose to about 120° to 140° F., when pressure was applied and the top of the silo covered. The theory advanced and proved by Mr Fry is that this temperature is sufficiently high to kill the bacteria which produce acid fermentation, and that, with the bacteria killed and the silage then weighted and the silo covered, the mass of green fodder will remain sweet and be practically preserved under the same conditions as fruits, vegetables, or meats are preserved when tinned. This process of making 'sweet' silage has been found peculiarly suited for stack ensilage, and, as 'sweet' silage is on the whole preferable to 'sour,' the method originated by Mr Fry has been extensively adopted. Temperature is the principal agent in the making of silage. This is controlled by pressure, and in the mass of silage it is measured by the stack thermometer, which should always be employed in silage-making. It is found a safe practice to allow the temperature of the mass to rise to from 130° to 140° F. before applying pressure if sweet silage is desired. Nearly all kinds of farm crops, except roots, may be preserved by the process of ensilage. The crops most largely converted into silage are meadow-grass, clover, rye-grass, lucerne, sainfoin, vetches, maize, and the cereal crops. In some cases the fodder is cut with the chaff-cutter before being put into the silo or stack, but the rule is, except with maize, to preserve it in its natural length. Nearly all kinds of farm stock eat both 'sour' and 'sweet' silage with relish, and it is the prevailing experience that by the process of ensilage the feeding value of the fodder is as a rule slightly enhanced. In wet climates the system is of great importance, for it practically renders the farmer independent of the weather in saving his fodder crops.

In the United States the subject was discussed by the agricultural journals as early as 1873-74; the French method was fully described in 1875 in the Report of the Agricultural Department; experimental silos were being made about the same date; but the first person who made silos and ensilage on a large scale was Francis Morris in Maryland in 1877. The system rapidly spread, especially in the eastern and middle states.

Silbury Hill. See AVEBURY.

Silchester, a village in the extreme north of Hampshire, 7 miles N. of Basingstoke, famous for the remains of the ancient Romano-British town of *Caer Segeint*, called by the Romans *Callena*, and by the West Saxons *Silceastre*. The chief visible remains are the amphitheatre, 50 yards by 40, and the walls, 2760 yards in length; excavations have shown the foundations of a basilica, the forum, a temple, baths, &c.; and coins, seals, rings, and much broken pottery have been found. New excavations were begun in June 1890. See *The History and Antiquities of Silchester* (1821), and the work on Silchester by Plummer (1879).

Silené, a genus of plants of the natural order Caryophyllaceae, having the calyx, corolla, and stamens of *Lychnis* (q. v.), three styles and a three-celled capsule opening at the top in six teeth or valves. The species are numerous, mostly natives of the temperate parts of the northern hemisphere, annual and perennial plants; nine or ten of them natives of Britain, and others frequent in flower-gardens. One of the most common British species is the Bladder Campion (*S. inflata*), a perennial, which grows in cornfields and dry pastures, and near the seashore, has a branched stem fully a foot high, ovate-lanceolate bluish-green leaves, panicles of white flowers, and an inflated calyx, with a beautiful network of veins. The young shoots are sometimes used like asparagus, and have a peculiar but agreeable flavour, somewhat resembling that of peas. They are best when most blanched. The cultivation of this plant was long ago strongly recommended, but it has not obtained a place among garden plants. The Moss Campion (*S. acutis*) is a pretty little plant, with beautiful purple flowers growing in patches so as to form a kind of turf, one of the finest ornaments of the higher mountains of Scotland, and found also in Cumberland and Wales. Many species, some of them British, are popularly called Catchfly, from their viscidities, as *S. anglica*, a species found in sandy and gravelly fields in many parts of Britain. For the Red Campion, White Campion, and German Catchfly, see LYCHNIS.

Silenus, a primitive woodland deity of Asia Minor, whom men try to catch when in a drunken sleep, in order to compel him to prophesy and sing. Later representations make him a son of Hermes or of Pan, and the chief of the Sileni or older Satyrs, and the inseparable companion and instructor of Dionysus, with whom he took part in the contest against the Gigantes, slaying Enecladus. He is described as a little pot-bellied old man, bald-headed and snub-nosed, his body very hairy, always drunk and bearing a skin of wine, and usually propped up by the other satyrs or astride of an ass, since his own legs could not be trusted.

Silesia, a province of Prussia, lying in the extreme south-east corner of the kingdom, and having Brandenburg and Posen on the N., the Polish provinces of Russia and Austria on the E., and Austrian Silesia, Bohemia, and the kingdom of Saxony on the S. Area, 15,557 sq. m.; pop. (1875) 3,863,699; (1890) 4,223,807, including more than 820,000 Poles, some 55,000 Bohemians (Czechs), and 32,000 Wends. By religion more than one-

half are Roman Catholics and somewhat less than two millions Evangelical Protestants. The province is drained almost entirely by the Oder (navigable from Ratibor), which traverses it from south-east to north-west; this river forms in the middle part of its course a deep valley, and this valley has a westward extension from near Liegnitz. The south-western parts are broken and made uneven by the Sudetic Mountains and their outlying ranges. On the northern and eastern sides of the Oder and in the west of the province there are extensive tracts of a marshy and a sandy character, on which large forests grow (29 per cent. of the total area). But between the Oder and the Sudetic Mountains the soil is exceptionally fertile, producing the usual cereals, besides flax, beet-root, chicory, hops, oil-plants, and orchard fruit. There are several very large estates in the province, the owners of which have done much to encourage the breeding of sheep, horses, and cattle. Silesia embraces in its south-eastern extremity one of the most productive coal-mining regions of Prussia (530 sq. m. in extent; annual output 16 million tons, valued at nearly 7 millions sterling). Zinc is also extracted to the annual value of £354,000, and lead of £365,000. In point of industrial activity Silesia ranks high amongst the provinces of Prussia; more than 35 per cent. of the population find employment in industrial pursuits. The most important departments are in linen and cotton; next in order of importance come the metal industries and the manufacture of cloth and woollens, beet-root sugar, glass, tobacco, and a great variety of other articles. The commerce is greatly hampered by the near proximity of the Russian frontier and its vexatious tariff regulations. Breslau, the capital, is the seat of a university, and gives title to a prince-bishop of the Roman Catholic Church.

Early in the 10th century Silesia, except the extreme western districts, was under the dominion of Poland, and towards the end of the 12th century was divided into two duchies (Breslau or Lower Silesia and Ratibor or Upper Silesia) ruled by Polish dynasties. In the following century great numbers of German immigrants settled in the country and gradually Germanised its semi-Slavic inhabitants. Duke Henry II. of Lower Silesia perished in the memorable battle of Liegnitz (1241), in conflict with the Mongol invaders. By the beginning of the 14th century Silesia was divided up amongst a score of petty rulers, nearly all of whom acknowledged King John of Bohemia as their feudal superior instead of the king of Poland in the years 1327-29. The Silesian dukes put no obstacles, as a rule, in the way of the Reformation; but the emperors, who as the heirs to the kingdom of Bohemia became the suzerains of Silesia, treated the people with cruel intolerance, and pursued that policy down to the first decade of the 18th century. The great duel between Austria and Prussia for the mastership of the Silesian territories grew out of a contract by which in 1537 the Duke of Liegnitz left his lands to the Elector of Brandenburg in the eventuality of his house becoming extinct in the male line. On the conclusion of the first Silesian war (1742) the duchies were divided pretty much in the way they are at the present time, Prussia getting by far the greater number and greater area; and the result of the second Silesian war and the desperate struggle of the Seven Years' War confirmed Frederick the Great in the possession of the lands he had so greatly coveted. Frederick, however, took the most active and judicious measures to improve his conquest, and reform its administration and put it on a sound basis. Silesia took a very zealous part in the final struggle against Napoleon in the early years of the 19th century. For the

Silesian Schools of Literature, see GERMANY (Vol. V. p. 187), and OPITZ.

See Grünhagen's *Geschichte Schlesiens* (2 vols. Gotha, 1884-86); Adami's *Schlesien nach seinen physikalischen, topographischen, und statistischen Verhältnissen* (6th ed. Breslau, 1885); and Schrollier's *Schlesien* (3 vols. Glogau, 1885-88).

Silesia, AUSTRIAN, a duchy and crown-land of the Austrian empire, bounded on the NE. by Prussian Silesia, and on the S. and W. by Moravia and Hungary. Area, 1987 sq. m.; pop. (1880) 565,475; (1890) 602,117. Subsidiary chains of the Carpathians and Sudetic Mountains diversify the southern and western frontiers; the duchy is watered by the systems of the Vistula (in the east) and the Oder (west). The climate, though somewhat raw, is healthy, and the soil produces good crops of rye, oats, barley, potatoes, beet-root, hay, &c. Mining and manufacturing industries both flourish. The mines yield coal, iron, sulphur, and other minerals to the annual value of close upon one million sterling. The principal industries are the smelting of iron, making of machinery, the manufacture of various textiles (worsted, cloth, linen and linen thread, cottons, &c.), brewing, distilling, and the preparation of chemicals. The principal town is Troppan. This province was created a separate crown-land in 1849. There is a provincial assembly or diet of thirty-one members.

Silex (Lat., 'flint'), a generic name given by some mineralogists to all those minerals of which silica is the principal ingredient. See SILICON, QUARTZ.

Silhet. See SYLHET.

Silhouette, a profile or shadow-outline filled in of a dark colour, the shadows and extreme depths being sometimes indicated by the heightening effect of gum or some other shining material. This species of design was known among the ancients, and was by them carried to a high degree of perfection, as the monochromes on Etruscan vases amply testify; but the name silhouette is quite modern, dating from about the middle of the 18th century, though the art itself seems to have been practised in England prior to 1745. It was taken



Silhouette of Robert Burns.

from Etienne de Silhouette (1709-67), the French minister of finance for four months in 1759, who, to replenish the treasury, exhausted by the costly wars with Britain and Prussia, and by excessive prodigalities, inaugurated numerous reforms and the strictest economy of expenditure. His earliest reforms were admirable; his later ones, however, were so capricious, shortsighted, and unsuccessful that he fell utterly from favour, and his name became a byword for injudicious parsimony; any mode or fashion that was plain and cheap was styled *à la Silhouette*; and profiles made by tracing the shadow projected by the light of a candle

on a sheet of white paper, the rest of the figure being filled up in black, have continued to bear the name. Although without merit as a work of art, the silhouette presents a clear and well-marked profile, and the Pantagraph (q.v.) used to be frequently employed to obtain profiles of a reduced size direct from the human features. Profiles cut out of black paper with scissors also receive the name of silhouettes; and akin to these are the 'silhouette illustrations' to *Faust*, *A Midsummer Night's Dream*, &c., by the Prussian Paul Konewka (1840-71), or those to our own article HORSE in Vol. V. p. 794. It should be added that Littré derives the use of the word otherwise: quoting from the *Journal Officiel* of 1869 a statement that one of M. de Silhouette's chief amusements after his fall was making such shadow-portraits, and that his château of Bry-sur-Marne had the walls of several of its rooms adorned with pictures of this sort. M. de Silhouette was at an earlier date secretary and chancellor to the Duke of Orleans, and was one of the three commissioners appointed in 1749 to delimit the frontiers of the French and British possessions in Acadia. He wrote a number of works, and published three translations from the English of Bolingbroke, Pope, and Warburton respectively. See a long correspondence in *Notes and Queries* for 1882-83.

Silica. See SILICON.

Silicon, or SILICIUM, is one of the non-metallic elements: sym. Si; at. wt. 28.4 (O = 16); sp. gr. of crystalline form, 2.40. It may be obtained in three different forms—viz. the *amorphous*, the *graphitoid*, and the *crystalline*. It is amorphous silicon which is obtained by the processes in common use, the other forms being obtained from it.

Amorphous silicon presents the appearance of a dull brown powder, which adheres to the finger, is insoluble in water and in nitric and sulphuric acids, but readily soluble in hydrofluoric acid and in a hot solution of potash. It is a non-conductor of electricity, and when heated in air or oxygen its external surface burns brilliantly, and is converted into silica, which fuses from the extreme heat, and forms a coating over the unburned silicon. *Graphitoid* silicon is obtained by exposing the amorphous variety to an intense heat in a closed platinum crucible. This form of silicon will not take fire when heated in oxygen gas, and resists the solvent action of pure hydrofluoric acid, although it rapidly dissolves in a mixture of nitric and hydrofluoric acids; moreover, it is a conductor of electricity. Deville obtained *crystallised* silicon in regular double six-sided pyramids of a dark steel-gray colour.

Silicon, in a state of combination with oxygen, is the most abundant solid constituent of our globe; in less proportion, is an equally necessary ingredient of the vegetable kingdom; while in the animal kingdom it occurs in mere traces, except in a few special cases. It is never found in nature except in combination with oxygen; but, by a somewhat difficult process, it may be separated as a dark brown powder. It was first isolated by Berzelius in 1823. For our knowledge of the other modifications we are indebted to Wöhler and Deville.

Silicon forms two oxides, one of which is only known in the hydrated state, while the other is the well-known compound silica or silicic acid. Silica or silicic acid is represented by the formula SiO_2 , and a hydrate, $3\text{H}_2\text{O} \cdot 2\text{SiO}_2$, has been obtained, while other hydrates are known to exist.

Silica exists both in the crystalline and in the amorphous form. The best examples of the crystalline form are rock-crystal, quartz, chalcedony, flint, sandstone, and quartzose sand. Silica in this

form has a specific gravity of about 2.9, and is only attacked with difficulty by potash or hydrofluoric acid. The amorphous form exists naturally in opal, and is obtained artificially as gelatinous silica, &c.; it differs from the former in its specific gravity, being about 2.2, and in its being rapidly dissolved by potash and by hydrofluoric acid. Pure silica (as it occurs in rock-crystal, for example) is perfectly transparent and colourless, and is sufficiently hard to scratch glass. The heat of the oxyhydrogen blowpipe is required for its fusion, when it melts into a transparent glass, capable of being drawn out into elastic threads. Perfectly pure silica in its amorphous form may be obtained by various chemical processes. If a solution of silicate of potash or soda be treated with hydrochloric acid, the silicic acid separates as a hydrate, and on evaporating this to dryness, and treating it with boiling water, silicic acid remains as an amorphous powder, which, after being washed, dried, and exposed to a red heat, may be regarded as chemically pure. The hydrated silicic acid mentioned in the above experiment is soluble in water, and (more freely) in acids and alkalis. The solubility of hydrated silicic acid in water accounts for the presence of silicic acid in mineral springs and in the geysers of Iceland, as well as for its gradual separation from these waters in the form of petrifications. That silica or silicic acid is a true acid (although a feeble one) is obvious from its uniting with bases, especially those which are capable of undergoing fusion, and forming true salts, known as silicates. These silicates occur abundantly in nature, all the forms of clay, felspar, mica, hornblende, augite, serpentine, &c. being compounds of this description.

Most of the silicates are fusible, the basic silicates fusing more readily than those which are either neutral or contain an excess of acid. Excepting the silicates of the alkalis, no silicates are soluble in water. The anhydrous, neutral, and acid silicates of the earths resist the action of all acids except the hydrofluoric.

Silica derives its name from the Latin *silex*, 'flint,' of which it is the essential constituent, and is largely employed in the manufacture of glass, china, and porcelain. For these purposes it is obtained in a finely comminuted state by heating flints or portions of colourless quartz to redness, and plunging them in cold water. The silica splits up into a friable mass, which may be easily ground to a fine powder. The use of silica in giving firmness and rigidity to various parts of the animal organs is exemplified in its free occurrence in the quill-part of the feathers of birds, in the shields of certain infusoria, and in the spicula occurring in sponges; while its similar use in the vegetable kingdom is seen in its more or less abundant presence in the stalks of the grasses, more particularly in the cereals and in the bamboo (where it is especially deposited about the joints, and is known as *Tabasheer*), in the *Equisetæ*, &c.

Silicon may be made to combine with several other elements besides oxygen, but, with the exception of silicofluoric acid, these compounds are of no practical value. Thus, silicon and hydrogen form a hydride of silicon, a colourless and spontaneously inflammable gas. Nitride of silicon is a bluish fibrous body, while sulphide of silicon is a white earthy powder. Silicon unites with chlorine, bromine, and probably iodine and fluorine, in two proportions corresponding to its oxygen compounds. Fluoride of silicon, SiF_4 , is a colourless pungent gas, liquefiable under strong pressure, and solidifying at -220° , inflammable, and a non-supporter of combustion. It is obtained by heating

powdered glass with twelve times its weight of oil of vitriol, and when a stream of this gas is transmitted through water a reaction takes place; two atoms of water and three atoms of the fluoride of silicon yielding silicofluoric acid, H_2SiF_6 , which remains in solution, and silicon, which is deposited. A saturated solution of this acid forms a very sour fuming liquid, which does not directly attack glass, but if allowed to evaporate on it causes erosion from the fluoride of silicon becoming evaporised, and free hydrofluoric acid being left. A dilute solution is sometimes employed in the laboratory as a precipitant of potash, which it throws down in a transparent gelatinous form. With salts of baryta it gives a white crystalline precipitate. It combines with bases to form salts.

For soluble glass, a silicate of soda or potash, see GLASS, Vol. V. p. 245; and for silicate cotton, see SLAGS.

Siliqua (*Siliqua*), in Botany, the fruit of the Cruciferae. See FRUIT, Vol. V. p. 19.

Silistria, a town of Bulgaria, is situated on the right bank of the Danube, here $1\frac{1}{2}$ mile wide, about 70 miles NW. of Varna. Owing to its strategic position it has for many centuries been a more or less formidable fortress, especially since the 14th century, under the dominion of the Turks. The Roman *Durostorum*, it was captured by the Russians under Sviatoslaff in 867, but was recovered in 971 by the Byzantine emperor, John Zimisces. It has been repeatedly besieged by the Russians. They destroyed the works after capturing it in 1810; but the fortifications were rebuilt more strongly than before, and offered a stout resistance to the Russian attacks in 1828-29. In 1849 it was made a stronghold of the first class, and was rendered almost impregnable by the addition (1853) of twelve detached forts on the south and east. On the outbreak of the Crimean war the Russians laid siege to it with an army of from 60,000 to 80,000 men, but were compelled to retreat after thirty-nine days. In 1877, again, it successfully defied the troops of the czar. The Congress of Berlin in 1878 decreed that the fortifications should be dismantled; but this has not been given effect to. Pop. (1893) 11,710, who weave cloth, tan leather, and grow vegetables.

Silius Italicus, a minor Latin poet, was born in 25 and died in 101 A.D. At an early age he became a prominent forensic orator, was consul the year of Nero's death (69), became a familiar friend of Vitellius, and was afterwards proconsul in Asia. He was a devoted student of Cicero and Virgil, and owned their estates at Tusculum and Naples. In old age, finding himself labouring under an incurable disease, he starved himself to death. His epic poem, *Punica*, in seventeen books and about 14,000 lines, has come down entire, and remains a monument of industry, of patient imitation, not of poetic creation. Scipio and Hannibal are its Achilles and Hector, its *Aeneas* and *Turnus*; and every episode in his great originals is slavishly reproduced and degraded to a dead level of literary mediocrity.

The poem was discovered by Poggio about 1416, and the *editio princeps* appeared in 1471. Editions are by Ernesti (1791) and Lemaire (1823).

Silk. The Chinese appear to be the first people who applied themselves to sericulture, although some claim for the Tussur silk of India the earliest silk fibre used. Copyright: 1892, 1897, and 1900 in the U. S. by J. B. Lippincott Company. The words *Seres* used by Theophrastus and *Serinda* by Procopius were in all probability so used to indicate that part of the East, which was no doubt China, where the silk industry existed at a very remote period. Ptolemy was the first to use the word *Seres* for China, or

rather the northern part of it, known later as *Cathay*; and the name is derived from the Chinese name of the silkworm *szé, see, or si*, in Korean *si*, whence the Greek *σιπη*, 'the silkworm'; *σιπηρ*, 'the people furnishing silk'; and *σιπηριον*, 'silk.' The Latin *sericum* has been traced direct to the Mongol *serkeh*; and the *serikoth* of Isaiah, xix. 9, has been supposed to be silk. From *sericum* is derived the French *soie*; and etymologically connected with it are the German *seide*, the Russian *sheolk*, the Anglo-Saxon *seolc*, the Icelandic *silke*, and the English *silk*. We are informed by Hawae-nan-tze, in a Chinese work called the *Silkworm Classic*, that Se-ling-she, the principal queen of Hwang-te (2640 B.C.), was the first to rear silkworms, and the Emperor Hwang-te was induced to invent robes and garments from this circumstance. The Chinese historians carry back the cultivation of the mulberry and the breeding of silkworms to the mythic period. If they are to be believed, the art of silk-reeling was known in China in the time of Fouh-hi, a century before the date usually assigned to the biblical deluge, and Hwang-te's queen did not disdain to share in the labours attending the care of the insect, as well as in those of the loom, the invention of which seems to be attributed to her, and to have raised her to the position of a tutelary genius with special altars of her own. But whatever the precise date of the discovery, it appears there can be no question of the very high antiquity of the knowledge of the worm and its product in China. A series of imperial edicts and voluminous literature of practical treatises testify to the importance of the industry and the care that was taken to foster an art which was considered, according to M. de Rosny, 'best fitted to promote the morality of the people and extinguish pauperism in the empire.' The queen and wives of the nobles through successive generations personally attended to the rearing of the silkworms. That this silk was of the mulberry-fed kind is evident from a further extract from the *Silkworm Classic*, which says that afterwards 'When Yu regulated the waters (2200 B.C.) mention is made, in his work on the tribute, of the land adapted for the mulberry-tree having been supplied with silkworms, from which time the advantage thereof gradually increased.' It is not known whether silk was utilised in India at so early a period as this—probably not; but that India learned the art from China is generally believed, although at what period is not known.

About the middle of the 6th century A.D. the western world received a supply of silkworms' eggs. They were conveyed from China to Constantinople by two Persian monks who had gone to the East as missionaries, and had observed in China the various processes connected with the rearing of silkworms, the nature of the trees on which they fed, and the preparation of the silk. This occurred in the year 552, in the reign of Justinian, who gave every encouragement to the introduction of the valuable insect. The eggs were secretly conveyed from China within a hollow cane; at the proper season they were hatched, and the caterpillars were fed on the leaves of the wild mulberry-tree. The monks continued to superintend at Constantinople the rearing of the insects and the whole process of manufacturing the silk. From this small commencement the myriads of silkworms have sprung which throughout eastern and western Asia have met the demand for silk—a demand that has gone on increasing from that time to the present.

Natural and Life History.—The natural history of every kind of silk may be briefly stated. From a small egg laid by the moth, of whatever species, appears in due season a small larva,

or caterpillar, or worm, as it is usually called. This worm, after having lived its day, feeding only on the leaves of certain plants specially suited to its own species, and increasing in size, spins, or rather secretes, a fine silk thread around itself for a covering and protection during the time it lies dormant in the next stage of its existence. As soon as it has secreted all the silk, it changes into a pupa or chrysalis, and remains inside its silken cell until the time for its appearance as an imago or perfect moth, having four scaly wings, with six legs, and two antennae, which are larger in the male than in the female. When its hibernation is ended it emits a fluid which softens the end of its cocoon cell, and, by means of its wing-spines and legs, parts the fibres aside until the opening is large enough for it to creep out. After a short time its wings expand and dry, and it enters into a perfect state. It lives only a few days in this phase of existence. It is in this stage only that the race is perpetuated, the female laying a number of eggs and dying soon afterwards (see the articles INSECTS, CATERPILLAR, CHRYSALIS, COCOON).

There are a number of species of silkworms whose food is the leaves of the mulberry-tree, the principal and most useful of which is the *Bombyx mori*. The following is a list of mulberry-feeders, the various kinds of Bombyx alone being domesticated, the others being wild:

Bombyx mori (Linnaeus).—The common silkworm, domesticated in China, Bokhara, Afghanistan, Cashmere, Persia, South Russia, Turkey, Egypt and Algeria, Italy, France, and Spain, in all which countries it produces but one crop annually, spinning the largest cocoon and the best silk of a golden yellow or white.

B. tector (Hutton).—The Boro Poloo of Bengal, domesticated in South China and Bengal; an annual only, producing a white (sometimes yellow) cocoon of a different texture and more flossy than *B. mori*.

B. sinensis (Hutton).—The Sina, Cheena, or small Chinese monthly worm of Bengal, introduced from China, and partially domesticated in Bengal; produces several broods in the year; cocoon white and yellow.

B. creasi (Hutton).—The Nistri or Madrassee of Bengal, introduced from China, and domesticated in Bengal; yielding seven or eight broods of golden yellow cocoons in the year of larger size than *B. sinensis*.

B. fortunatus (Hutton).—The Desi or Chota Poloo of Bengal; yields several broods annually, spinning the smallest cocoon of a golden yellow colour.

B. aracanensis (Hutton).—The Burmese silkworm, domesticated in Arakan, said to have been introduced from China; yields several broods annually; cocoons larger than the Bengal monthly species.

Theophila huttoni (Westwood).—The wild silkworm of the north-west Himalayas, feeding on the indigenous mulberry in the mountain forests.

T. shervilli (Moore).—The wild silkworm of the south-east Himalayas.

T. bengalensis (Hutton).—The wild silkworm of Lower Bengal, discovered in the neighbourhood of Calcutta, feeding on *Artocarpus lacucha*. Found also at Ranchee, in Chota Nagpore.

T. religiosa (Heller).—The Joree of Assam and Deomooga of Cachar. Feeds also on the ber tree (*Ficus bengalensis*) and the peepul (*F. religiosa*).

T. mandarina (Moore).—The wild silkworm of Chekiang, North China; said to feed on wild mulberry-trees, spinning a white cocoon.

Ocinara lactea (Hutton).—Mussoree, north-west Himalayas; also feeds on *Ficus venosa*, spinning a small yellow cocoon, yielding several broods during the summer.

O. moorei (Hutton).—Mussoree; also feeds on *F. venosa*, as well as on the wild fig, spinning a small white cocoon. It is a multivoltine (see below).

O. diaphana (Moore).—Khasi Hills.

Trilocha varians (Walker).—North and South India.

In Italy and France *B. mori* is cultivated under active government encouragement and oversight, having during centuries of effort become a subject of high national importance. The United

States of America and the British colonies are making efforts to introduce the cultivation of the *B. mori*; the only hindrance being in the high price of labour for cocoon reeling. The *B. mori* is univoltine or annual; but the *B. fortunatus* and *B. crass*, which are confined to Bengal, are multivoltine—i.e. they produce several broods annually. For wild silks not from mulberry feeders, see page 456.

Classification.—The silk-producing Lepidopterous insects are of many species, possessing very marked structural differences, whilst the variety and quiet beauty of their colours, and in many species their large size, contribute greatly to the charm of studying this branch of natural history. They belong to the order Lepidoptera, sub-order Heterocera or Moths, group Bombycina, and to several of the twenty-seven or more families which compose this group, the most important being the Bombycidae and the Saturniidae. All the Saturniidae are silk-producers, but not all the Bombycidae. Recent researches have resulted in adding many new or previously unknown species to the list of silk-producers, and the known number is now upwards of 400, and the list is by no means complete.

The Bombycidae have a very short and rudimentary proboscis, live for a very brief time in their perfect state, and take little or no food; the body is thick and hairy; the antennae are pectinated. The caterpillars feed on the leaves and other tender parts of trees or other plants; the chrysalises are enclosed in a cocoon of silk, which gives to some of the species a great economical importance. The most important is the Common Silkworm (*Bombyx mori*), cultivated chiefly in China, Japan, Italy, and France. The perfect

substance, which, when dry, becomes silky. In Europe they are laid in spring, and are hatched in summer. The caterpillar is at first very small, not more than a quarter of an inch in length, but rapidly increases in size, till, when full grown, it is nearly 3 inches long. It is of a yellowish-gray colour. The head is large. On the upper part of the last joint of the body is a horn-like process. The skin is changed four times during the growth of the caterpillar. Before each change of the skin it becomes lethargic and ceases to eat, whereas at other times it is very voracious. When the skin is ready to be cast off it bursts at the forepart, and the caterpillar then, by continually writhing its body, without moving from the spot, thrusts it backwards; but silkworms frequently die during the change of skin. A very rapid increase of size takes place whilst the new skin is still soft. The natural food of the silkworm is the leaves of the white mulberry, but it will also feed on the leaves of some other plants, as the black mulberry and the lettuce. When so fed, however, it produces silk of inferior quality. The silk-producing organs are two large glands (*sericteria*) containing a viscid substance; they extend along great part of the body, and terminate in two seripositors in the mouth. These glands become very large when the change to the chrysalis or pupa state is about to take place. When about to spin its cocoon the silkworm ceases to eat, and first produces the loose rough fibre which forms the outer part of the cocoon, and then the more closely disposed and valuable fibre of its interior. In this process the position of the hinder part of the body is little changed, but the head is moved from one point to another; and the cocoon when finished is much shorter than the body, which, however, being bent, is completely enclosed in it. The cocoon is about the size of a pigeon's egg. Each fibre of silk or *bave*, when examined by a microscope, is seen to be double or of two *brins*, being equally derived from the two silk-producing organs of the caterpillar. The *bave* or double thread often exceeds 1100 feet in length. The time of the silkworm's life in the caterpillar state is generally about eight weeks. About five days are occupied in the spinning of the cocoon, after which about two or three weeks elapse before the cocoon bursts and the perfect insect comes forth. The opening of the end of the cocoon by the moth for its escape is, however, injurious to the free and perfect reeling of the silk from the cocoon, and the silkworm reeler prevents this by throwing all the cocoons into hot water or more usually into an oven, called in France *étouffoir*, *séchoir*, heated by hot air or by steam, except those which he intends to keep for breeding. These he selects with care, so that he may have about an equal number of male and female insects, the females being known even in the chrysalis state by their larger size. The cocoons intended for the production of moths are placed on a cloth in a somewhat darkened room, of which the temperature is near, but does not exceed, 72° F.; and the moths, when produced, show no inclination to fly away, but remain on the cloth, lay their eggs, and die there. It is an interesting peculiarity of this valuable species of moth that neither in the caterpillar nor in the winged state does it show that restless disposition which belongs to many others, the caterpillars remaining contentedly in the trays or boxes in which they are placed, feeding on the leaves with which they are there supplied, and at last only seeking a proper place for making their cocoons for their covering and protection. Whilst assuming the chrysalis state small bundles of twigs are placed above the feeding-trays for the worms at their last caterpillar stage to resort to for cocoon building. Owing to this peculiarity or



Fig. 1.—Common Silkworm (*Bombyx mori*):
a, larva, full grown; b, larva, seripositing; c, cocoon;
d, chrysalis; e, female moth; f, male moth.

moth is about an inch in length, the female rather larger than the male; the wings meeting like the sides of a roof; the colour pale buff with a broad pale brown bar across the upper wings. The females generally die very soon after they have laid their eggs, and the males do not survive much longer. The eggs are numerous, about the size of a pin's head, not attached together, but fastened to the surface on which they are laid by a gummy

domesticity, it is capable of being reared and managed in a way which would otherwise be impossible.

Rearing of Silkworms.—It is of the first consequence in the production of silk that one of the species of mulberry should be cultivated, and that it should be so favourably situated as to climate that it is in readiness for feeding the worms. The species best adapted is the white mulberry, *Morus alba*. The extreme lateness of season at which the black mulberry produces its leaves prevents its employment generally, besides which it will not bear the loss of its leaves so well. It is said that in some parts of China the silkworm is easily reared upon the trees in the open air. So little has it a tendency to wander far from the place of its birth, if food be at hand, that it only requires a warm, dry atmosphere to bring it to perfection; but usually, even in China, and in all other countries, it is thought desirable to raise the silkworm in properly arranged buildings, and to supply it with mulberry leaves gathered from day to day. In India, China, and other tropical countries the eggs hatch readily at the proper time by the natural heat; but in southern Europe artificial heat is almost always required; formerly the heat of fermenting dung was found serviceable, and the warmth of the human body was also used, the eggs being carried in little bags in the bosom of the cultivator; but now they are regularly hatched by stove-heat, beginning with a temperature of 64° F., which is gradually increased through ten days to 82°, at which it is maintained until the eggs are hatched. Experience has shown that the operation is facilitated by washing the eggs in the first place with clean water; and some cultivators also wash them in wine, the value of which is very questionable. Washing is found to remove a certain gumminess and other impurities from the eggs which would otherwise impede the hatching. When the silkworms have been regularly developed as above described, it is usual to place above the trays contrivances for the caterpillar to spin within. In feeding the worms care is taken so to distribute the food on the shelves or in the trays that the insects shall not crowd together; and for this reason the most careful cultivators chop the leaves small, and strew them very evenly about. Great care is taken not to let the worms of one hatch mix with those of another, unless of exactly the same age, otherwise the stronger insects would deprive the younger of their food. Many other niceties of attention are required, which altogether render the successful rearing of silkworms a matter of much anxiety and labour.

Diseases.—Silkworms are subject to various diseases. In all about fifteen have been defined, but the most important, which only need mention here, are *Musccardine*, *Pebrine*, *Flacherie*, *Guttine*, and *Grasserie*. *Musccardine* is the result of the growth on the silkworm of a microscopic fungus named *Botrytis bassiana*. The spores of this minute fungus are not larger than the two millièmes of a millimetre. They are carried by the air, and falling on the mulberry leaves or on the worms cause the disease. Worms affected with muscardine die before arriving at the moth. In the magnaneries where the disease is present or is suspected they are daily fumigated with sulphurous acid gas (fumes of sulphur), which kills the spores, but does not hurt the worm. *Pebrine* is the most important disease. Worms affected with it are without difficulty detected; amongst other well-known signs by the appearance of blackish spots on the skin. This disease is the consequence of a corpuscle or bacillus, which, once having entered the worm, multiplies rapidly. The interior of the body of a moth is often found to be quite full of corpuscles. *Pebrine*

is found in all the life-stages of the insect. Prevention is the remedy laid down by M. Pasteur, and in all well-managed rearing-houses the microscope is employed to examine the eggs, when those found to be pebrinised are rejected. This method, combined with greater cleanliness, dessication, and fumigations of chlorine, has been so successfully used since 1865 that pebrine has nearly disappeared in a number of localities in France and Italy where previously sericulture had become almost extinct, and it now only exists where these precautions are not sufficiently observed. *Flacherie* is a deadly and contagious disease, and is the result of bacterial growth of a vibronic nature. The worms are attacked in their last stage, having arrived at their full size; they languish, die, and decompose rapidly, a whole chamber sometimes perishing in a day. Pasteur has fully studied this disease, and has pointed out preventive remedies. It is generally the result of other diseases and the want of proper precaution, especially as to the careful conservation of the eggs from the laying of them to the time they are hatched. *Guttine* is a disease of the same character, and is probably only a modification of flacherie. *Grasserie* is of less importance than the other diseases; but it is interesting and not very well understood. A few worms will frequently be found in the midst of healthy ones, which are evidently ailing, crawling slowly, with a glossy skin, becoming thinner and longer. In the yellow races the colour becomes bright, and in the white races an unhealthy milky-white appearance, and through the skin there exudes a dirty liquid which under the microscope is seen to contain a multitude of many-sided globules, probably albuminous. A cold, stagnant, or damp atmosphere, or a too crowded chamber, favours the commencement of this disease, which is neither hereditary nor contagious.

Preparation of Silk.—When the cocoons are completed, which is known by the absence of any sound within, they are carefully sorted, and a certain number are kept for breeding. The sexes are readily known by the difference of shape as well as of size. The French growers sort them into several varieties; those which are less compact, or in which the worm has died—a fact known by external indications—being separated from the good ones. When the sorting is finished, the cocoons are placed in an oven with a gentle heat, which kills the enclosed chrysalis—otherwise they would all become perforated by the insect eating through; they are then prepared for winding by first removing the flossy covering, which is often somewhat hard and compact. The cocoons are placed in basins of water, kept warm by charcoal fires, or in the larger establishments by steam. This softens the natural gum which coats the silk, and loosens the various coils of silk adhering together in the cocoon. The operator then takes a small battage brush made of twigs and stirs them about in the water. This catches the outside portions of the cocoon, from which the reelable thread is gradually unwound. From three to five of these ends are taken and united into one thread, which is passed through a polished metal or glass eye in the reeling-machine. In large filatures or silk establishments complex machinery is used for winding; but reeling apparatus of greater simplicity is used by the Chinese, East Indians, and others. In all cases, however, the principle is the same. The plan most generally adopted in Italy is shown in fig. 2.

Great care and skill are required in reeling silk from the cocoons, because, although the reeler starts with four or five or six cocoons, not only are their individual threads apt to break, but they are not all of the same length, so that one will run out

before the others. These matters are carefully watched, and, as often as a thread breaks or a cocoon runs out, another thread is joined on and is made to adhere to the compound thread on the reel by its natural gumminess. Each cocoon generally yields about 300 yards of thread, so that it takes 1200, 1500, or 1800 yards to make 300 yards of the filament of raw silk, by which name the reeled silk is always known. The raw silk is made up into hanks of various sizes. That from China and Japan is tied in packages of six hanks each, technically called books, and sometimes the ends of these books are covered with silken caps very curiously formed out of unreeled cocoons macerated and felted into a thin material, so managed as to form a filmy cap sufficiently large to cover a man's head. Formerly all raw silk required to be made into compound and twisted threads was termed thrown silk, but at the present time much is woven in the raw state and afterwards dyed in the piece. The raw silk is used for the warp, and spun silk and cotton for the weft, and the cheaper kinds of silks, such as foulards and some satins, made in large quantities in Lyons.

When the silk has to be thrown into organzine or tram, the raw silk is put into warm soap and

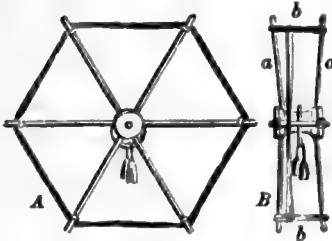

Fig. 2.

water to soften the gum, so as to make the hanks wind more easily. The hanks are placed on large skeleton reels called swifts (A, B, fig. 2), so adjusted that they will hold the hanks tightly. B, the edge view, shows that the spokes, *a, a*, are in pairs. They are made of thin pieces of lance-wood, and each pair are rather nearer together at the axle than at the circumference, where they are connected together by a small band of cord, *b, b*. These bands are so tied that they will slip down easily to admit of the hanks being placed; then, by pushing the cords upwards, the hank can

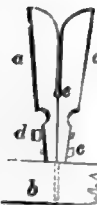

Fig. 3.

be stretched to its fullest extent. This is necessary to compensate for the varying lengths of the hanks received from the different countries. When the swifts are set in motion the silk is carried from the hanks to bobbins, upon which it is wound for the convenience of further operations. The bobbins are then taken from the winding to the cleaning machine, when they are placed on fixed spindles, so that they will turn with the slightest pull; and the thread is passed through a small apparatus attached to the machine, which is specially called the cleaner, and consists essentially of two polished smooth-edged blades of metal (*a, a*, fig. 3) attached to a part of the frame of the machine, *b*. They are held together by the screw, *c*, and are slightly opened or closed by the other screw, *d*, so that the thread can be put between them down to the small orifice, *e*, and then, by tightening the screw, preventing its return after passing through this small hole, which is the gauge of the thread, and which removes any irregularities or adherent dirt. The silk next passes over a glass or metal rod, and then through another small hole, much larger than that of the cleaner, and usually made of glass, on to the bobbin, upon which it is wound by the action of the machine. The next process is twisting the

cleaned thread, by which it becomes better adapted for being combined with other threads. Doubling is the next process, and this consists in running off a number of bobbins of twisted silk on to one bobbin of a larger size, which is put into the throwing machine, when the ends of the doubled silk are passed through a smooth hole on to a large reel, which reel winds it into hanks, but twisting the threads into a fine cord as it goes from the bobbins to the reel. After this the hanks have to be again wound on reels and bobbins for the weaver, the former for the warp and the latter for the weft. If it has been wound, cleaned, and thrown it is called thrown-singles; if wound, cleaned, doubled, and thrown, it is called tram, and is used for the richer silks and velvets, but only for the weft or shute; and if wound, cleaned, spun, doubled, and thrown, it is called organzine, and is used for the warps of fabrics. Before winding the cocoons a flossy portion has to be removed; and after all has been wound off another portion remains like a compact bag; these are collected and sold under the name of waste-silk, and to these are added the fragments of broken threads, which accumulate in considerable quantities during the reeling and throwing operations. Formerly very little use was made of waste-silk; not a little of it was employed by engineers and others for mere cleaning purposes; although as early as 1671 a proposition was made by a manufacturer named Edmond Blood to make it available by carding it with teasels or roving-cards. He took out a patent for this invention, but apparently did not bring it into use.

It has been left to the 19th century to perfect the spinning into yarn of waste-silk. Mr Lister of Bradford (in 1891 created Lord Masham) in 1857 discovered a successful method of spinning native Chassum, or Indian silk-waste, there being then a very considerable quantity warehoused in London, for which, however, no use had been found. Since that period many important improvements in dressing and spinning waste-silk have been invented, and a great trade has resulted in the manufacture of fabrics made from these yarns in Yorkshire, Alsace, Switzerland, and France. Another patent was taken out by Mr Lister, which has done wonders; now the waste is all spun into yarn, thereby greatly economising the use of silk, as the quantity of silk-waste always greatly exceeds the amount of good silk reeled off. The processes employed in the production of silk-yarn from the waste differ little from those of spinning, especially for cheap and common qualities of cotton and wool.

The following silk centres represent the present and past localities of British silk manufacture: London (Spitalfields), Derby, Coventry, Sherborne (Dorsetshire), Sudbury, Glemsford and Haverhill (Suffolk), Braintree, Yarmouth, Bungay, Leicester, Nottingham, Norwich, Macclesfield, Leek, Congleton, city and district of Manchester, Rochdale, Bradford, Halifax, city and district of Glasgow, city and district of Dublin, Tideswell (Derbyshire). Leek is justly celebrated for its manufactures of sewing and embroidery silks, a branch greatly increased since the introduction of the sewing-machine, which necessitated long and evenly-made lengths of silk thread of many sizes and colours. Leek has become the largest centre of dyeing silk in England; it is noted for the production of a special 'raven black,' nowhere else produced, and so called from its resemblance to the bluish-black plumage of a raven's wing. It is said that this shade is partly owing to the peculiar quality of the water used in dyeing. Silk is also dyed in London, Glasgow, Macclesfield, Coventry, Middleton, and other places, but to a much diminished extent.

Statistics.—About 100 lb. of cocoons are raised from 1 oz. of eggs, and 12 to 14 lb. of cocoons

yield 1 lb. of raw silk; but the quantity is variable, and depends on silkworm study, selection of eggs, and in crossing the numerous varieties. As far as can be ascertained, the total quantity of raw silk annually produced in the world is upwards of 22 millions of pounds. China furnishes 38·53 per cent.; Italy, 29·65 per cent., Japan, 12 per cent.; France, 7·52 per cent.; the Levant, 6·21 per cent.; India, 3·82 per cent.

Of silk manufacturing countries France is the principal. The French consumption of raw silk amounts to about 9,918,000 lb. per annum, the value of which is estimated at from £10,000,000 to £12,000,000. France itself produces about one-eighth of the raw silk consumed (there were 242,000 growers in 1890); the rest being imported from Italy and Asiatic countries. The total value of manufactured silk produced by France is estimated at from £24,000,000 to £26,000,000 per annum; the total production of the world being £64,000,000. France thus produces about two-fifths of the whole, the total number of silk looms in France being estimated at 230,000.

The British silk trade was formerly much larger than it is at present. The treaty with France which allowed French silks to come in duty free found Great Britain and Ireland unable to compete with France, and in a short time the trade dwindled immensely, with disastrous results to Spitalfields, Coventry, Macclesfield, Congleton, Dublin, Manchester, and a few other centres. From this it has never recovered; but it is hoped by the promotion of a higher efficiency, and by the equalisation of wages and hours of labour throughout the Continent, that Britain may once more come to enjoy her fair share in this important and beautiful industry, having a climate splendidly suited for all stages of manufacture, though not for sericulture. The following figures, taken from the Board of Trade returns of 1890, show the total quantity of silk manufactured in Great Britain.

Raw.....	262,168 lb.	= £178,188
Knubs or husks of silk and waste...	11,189 cwt.	= £114,893
Thrown.....	124,149 lb.	= £90,119
Manufactures.....		£295,780

The history of silk production in America dates from 1530, when the first mulberry-trees and silkworms were imported into Mexico. But by 1600 the industry had died out there; and a like fate overtook it in Virginia before the end of the next century, and practically everywhere by the beginning of the 19th century, although it had been vigorously encouraged by England, filatures established, and Georgia alone in one year had sent home nearly 2000 lb. of raw silk. About 1825 a powerful effort was made to revive the industry in the United States; silk societies were established, and manuals of silk-culture, such as J. H. Cobb's, printed and distributed by state legislatures and by congress. But success was prevented by a craze for speculation in Chinese mulberry-trees, which ended in wide-spread ruin in 1839. Since then silk-culture has never flourished in America. It was taken up with eagerness in California in 1854, but quickly dwindled and died; there is a state board of silk-culture in San Francisco, but it has not succeeded in arousing much interest in it. At Philadelphia a Woman's Silk-culture Association was founded in 1876, so far with the same result; nor has commercial success encouraged the attempts of the Agricultural Department, which established a filature at Washington in 1886 for reeling silk from American cocoons, and has distributed eggs of large Milanese silkworms. But if silk-culture has failed so far to engage American attention and capital, the reverse has been the case with the silk manufacture. This began in New England early in the 18th century,

and steam-power for the manufacture of sewing-silk was introduced in 1810, improved machinery quickly following, until before the civil war a great trade had grown up in twist, dress-trimmings, ribbons, and woven silk goods. Laces were manufactured at Brooklyn in 1871, and since 1876 silk handkerchiefs, tapestry, and velvets, besides dress-silks of all sorts, have been manufactured in steadily-increasing quantities and excellent qualities. The most famous seat of the American silk manufacture is Paterson (q.v.), with considerably more than 100 mills. In 1874 the value of all silk goods manufactured in the United States was \$16,269,157; in 1880 it was \$34,519,723. In 1880 2,562,236 lb. of raw silk was imported, and in 1890, 7,510,440 lb., valued at \$24,325,531. The imports of manufactured silk were valued at \$38,246,787 in 1890, and \$22,635,047 in 1898.

Wild Silks.—This is a generic term generally signifying those silks used in commerce, and those not at present utilised, other than silk of the mulberry-feeding worms, but relates almost entirely to the Saturniæ, whose fibres are more or less flat; it necessarily includes a few species which are subject to more or less of domestication, such as the Eria and Muga of Assam. Most of the principal wild silkworms are Asiatic. The best known are those of India. There are a few species in North America, one or two of which have received some attention. South America and the West Indies contain many others, and are almost unworked fields. The following list includes all the principal wild silks:

Atlas and Eria Group.—*Attacus atlas*, *A. silhetica*, *A. edwardsia*, *A. cyntia*, *A. ricini*, *A. canningi*, *A. lunula*, *A. obscurus*, *A. guerini*.

Actias Group.—*Actias selene*, *A. sinensis*, *A. leto*, *A. moras*, *A. ignescens*.

Tusar and Muga Group.—*Antheræa mylitta*, *A. andamana*, *A. mezanookoria*, *A. frithii*, *A. nebulosa*, *A. helferi*, *A. perrotti*, *A. assama*, *A. roylei*.

Miscellaneous Group.—*Salassa lola*, *Rinæa zulcika*, *Rhodia newara*, *Caligula tibeta*, *C. simla*, *C. cachara*, *Neoris hutoni*, *N. shadulla*, *N. stoliczkanæ*, *Saturnia culosa*, *S. grotei*, *S. lindia*, *S. anna*, *Loepa katinka*, *L. sikkina*, *L. sivalica*, *L. miranda*, *Cricula trifenestrata*, *C. drepanoides*, *Antheræa pernyi*, *A. confucii*, *A. yama-mai*, *Saturnia pyretorum*, *Neoris shadulla*, *Theophila mandarina*.

Of these a few species only need be noticed here. *Antheræa yama-mai* is a Japanese species, which feeds on the leaves of the oak. It is peculiar to Japan, and has long been held in high estimation there, more so formerly than now. At one period its silk was solely reserved for the use of royalty, and the penalty of death is said to have been inflicted upon any person found using it or taking the eggs. At the present time it is woven along with the ordinary silk of commerce in patterns, giving the separate effects of each silk. The Eria silk is the product of the Eri or Arindi worm of Assam. It is largely cultivated in that part of India, and is handspun and woven by the natives in garments, rough, but so durable that mothers are said to leave them to their daughters. The cocoon is soft and not compact; it has hitherto been found impossible to unwind it in a continuous thread, and in consequence of this difficulty it is rudely spun by hand like flax. It would be largely employed in Europe for machine-spinning if it could be cultivated and exported in quantity. Its excellences for this process of manufacture are well known. The worm chiefly feeds on the *Ricinus communis*, or castor-oil plant. *Attacus cyntia* is a species closely allied to *Attacus ricini*. It comes originally from China, and feeds on the Ailanto (q.v.) tree. Its cocoons were first received in Europe in November 1856, and hatched out the

following year, and towards the middle of May 1857 the first living specimen of *Attacus cynthia* was born in Europe. These cocoons were sent by

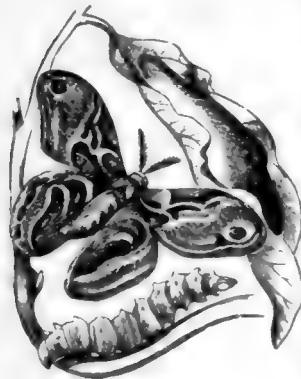

Fig. 4.—*Ailanthus* Silkworm (*Attacus cynthia*), reduced, showing Cocoon attached to a leaf.

Abbé Fantoni, a Piedmontese missionary, from the province of Shan Tung, in the north of China, situate just south of Peking, to some friends at Turin. This species was first introduced into England in 1859, and reared by Mr F. Moore of the East India Museum. The larvæ, feeding on the castor-oil plant, and hatched from eggs sent by M. Guerin Meneville, were exhibited by Mr Moore before the Entomological Society of London

in October 1859. Afterwards Lady Dorothy Nevill cultivated that species extensively, and planted in her park in the south of England a number of Ailanto trees. Dr Wallace also wrote on this silk-worm, and considerable efforts have been made in France and in England to domesticate it, but without success. The *Attacus atlas* is found over India. It is the largest known moth, being often 10 inches in expanse of wing. The cocoon is large, but the fibre is coarse; it has not hitherto been used in the reeled state, but it is utilised in the Nepal Terai by the Mechi people, in the form of rudely-made cloths. The warp and weft are handspun yarns of long staple. The *Antheræa assama* or Muga silk is confined to Assam, and is largely cultivated for native purposes. A little is exported to Dacca

and Calcutta for embroidery purposes. Could the natives be induced to cultivate it on a commercial scale for exportation it would have a widely extended use, for it is a silk that could easily be utilised for many European purposes.

The last two silks are the principal wild ones; they may from their similarity be classed as one, and are known under the name of Tussur silk—a name said to be derived from *tasara*, a weaver's shuttle. The species known as *Antheræa pernyi* is a native of China; the worm feeds on the leaves of the oak. It is very largely cultivated for export to Europe. That known as *Antheræa mylitta* is the principal species, and is exclusively Indian, being found over all parts of the country, particularly in Bengal. The Tussur silkworm when fully grown is very large and beautiful. It is about 5½ inches long. Its cocoon is hard and compact; the silk is of a deep fawn colour, which has to be resolved before any delicate shades of colour can be dyed upon it. The rapidly extended utilisation of this silk is very wonderful. About 1871 its European use was almost confined to the wearing of native-made cloths in the undyed state, and the consumption was extremely small; but in consequence of improvement in the bleaching and dyeing of this silk, at first effected by the writer of this article, as well as to his suggested utilisation, its importation has now become a factor of serious import. The fibre is well adapted for pile fabrics, and very large quantities are used in Yorkshire for the manufacture of seal cloths, a fabric resembling sealskin. France has taken up the utilisation of this silk for trimming and upholstery purposes, and the present consumption at Lyons averages 100 bales per week. The fibre of Tussur silk is flat and thick. A fabric closely resembling silk is now manufactured from wood reduced to a glutinous, transparent pulp, and forced through very fine tubes, according to the method of Comte Hilaire de Chardonnet. There are large and successfully operated works at Besançon, and since 1896 near Coventry.

Name of Worm or Silk.	Country.	Diameter in fractions of an inch.		Tension or limit of stretch before breaking, in inches, of single fibre one foot long.		Strength of single fibre in drachms avoirdupois.		Dimensions of Cocoon in inches.
		Outside of Cocoon.	Inner part of Cocoon.	Outside of Cocoon.	Inner part of Cocoon.	Outside of Cocoon.	Inner part of Cocoon.	
<i>Bombyx mori</i> , or mulberry silk	China.	⅜	⅜	1½	1½	2½	2½	1½ × 1
	Italy.	⅜	⅜	1½	1½	2½	2½	1½ × 1
	Japan.	⅜	⅜	1	1½	2½	2½	1½ × 1
	Bengal.	⅜	⅜	1½	1½	2½	2½	1½ × 1
<i>Bombyx textor</i> .	India.	⅜	⅜	1½	1½	2½	2½	1½ × 1½
<i>Antheræa mylitta</i> , or Tussur silk	"	⅜	⅜	1	1	7	8	1½ × 1
<i>Attacus ricini</i> , or Eria silk	"	⅜	⅜	1	1½	1½	2½	1½ × 1
<i>Attacus cynthia</i> , or Ailanthus silk	"	⅜	⅜	1	1½	2½	2½	1½ × 1
<i>Antheræa assama</i> , or Muga silk	"	⅜	⅜	1	1	2½	3	1½ × 1
<i>Actia serena</i>	"	⅜	⅜	1	1½	2	2½	3 × 1½
<i>Attacus atlas</i>	"	⅜	⅜	1	1½	2½	2½	3½ × 1½
<i>Antheræa yama-mai</i>	Japan.	⅜	⅜	1	1	2½	3	1½ × 1
<i>Oricula trifenestrata</i>	India.	⅜	⅜	2 × 2

See also the articles DYEING, LYONS, MOIRE, RIBBON, SATIN, VELVET, WEAVING, &c.; Lardner's Cyclopaedia; the monograph by Cobb in 'British Manufacturing Industries' (1876); American works by Brockett (1879), Wyckoff (1879), Crozier (1880), and Riley (1886); and the following works by the present writer: *The Wild Silks of India* (published as a South Kensington Handbook), *The English Silk Industry* (part of vol. iii. of the second Report of the Royal Commissioners on Technical Education, 1884), and *Silk: its Entomology, History, &c.* (1888).

Silk-cotton. Under this name various silky fibres are from time to time brought from tropical countries to Europe; they are all of the same

general character, and are chiefly produced by the trees composing the genus *Bombax* and other genera included in the natural order Malvaceæ. These trees are natives of the tropical parts of Asia, Africa, Australia and America. The fibre fills their large woody capsules, enveloping the seeds contained in them, and is produced in great abundance; but is too short, too smooth, and too soft to be spun into yarn by machinery. Silk-cotton is, however, used for stuffing pillows, mattresses, sofas, &c. to a limited extent in England, but more largely in Holland, where a long-stapled variety is obtained from Java. One of the best-known silk-cotton trees is *Bombax malabaricum*, a very large soft-

wooded tree growing in India, Burma, Java, and North Australia. Its fibre is called *simal*. Another of these trees is *Eriodendron anfractuosum*, which is found in tropical countries of both hemispheres, and which yields the fibre known in India as *rapok*. *Cochlospermum gossypium*, a small Indian tree, also yields a silk-cotton. A beautiful fibre of this kind is obtained in the West Indies from *Ochroma lagopus*. *Vegetable silk*, which, like silk-cotton, is only suitable for stuffing, is the covering of the seeds of *Chorisia speciosa*, a Brazilian tree.

Silkworm Gut, a material used by anglers for dressing the hook-end of the fishing-line. It consists of the drawn-out glands of the silkworm at the time it is about to spin its cocoon and when these glands are fully distended. The worms are immersed for twelve or fourteen hours in strong vinegar, and then taken separately, and pulled asunder. The skilled operator knows by the strength of the silk-gut if the soaking in vinegar has been sufficient, and if so he lays hold of the ends of the two silk-glands and draws them out gently to the proper length—and so the gut is formed. He then stretches a number of these lengths separately across a board, fixing them at each side or end by slits or pins, after which they are exposed to the sun to dry. Silkworm gut is a very strong material. It is prepared in Italy and Spain.

Sillery, a village of 400 inhabitants in the French department of Marne, near Rheims, famous for its Champagne (q.v.).

Silliman, BENJAMIN, American physicist, was born at North Stratford (now Trumbull), Connecticut, August 8, 1779. His father was a colonial judge, and a brigadier-general in the war of independence. He graduated at Yale in 1796, was appointed a tutor in 1799, and was admitted to the bar in 1802, but soon after received from the college the appointment of professor of Chemistry, and proceeded first to study this subject, attending lectures on chemistry for three years at Philadelphia, and in 1805-6 at Edinburgh (on geology also) and London. His chair he filled till 1853, and for two years longer lectured on geology. In the course of many experiments in 1822 he first established the fact of the transfer of particles of carbon from the positive to the negative pole of the voltaic battery. From 1808 he delivered popular lectures on chemistry and geology in many parts of the country, and interested in these subjects many who afterwards became among the foremost of American scientists. In 1840 Professor Silliman was elected the first president of the American Association of Geologists and Naturalists—since grown into the American Association for the Advancement of Science. In 1818 he founded the *American Journal of Science*, better known as *Silliman's Journal*, of which he was for twenty years the sole and for eight more the principal editor. In 1830 he published a textbook on chemistry; he edited several editions of Bakewell's *Geology* and of Henry's *Chemistry*; and in 1853 he published a *Narrative of a Visit to Europe in 1851* (his *Journals of Travels in England, Holland, and Scotland* had appeared as early as 1810). He died 24th November 1864, at New Haven, where a bronze statue has been erected (1884) in the college grounds. See the Life by G. P. Fisher (1866).—His son, Benjamin (1816-85), assisted his father from 1837, in 1847 founded the Yale (since 1860 the 'Sheffield') School of Science, and was its professor of Chemistry till 1869, except in 1849-54, when he held a chair at Louisville. He was professor of Chemistry at Yale from 1854—in the college till 1870, in the medical department till his death. His researches were chiefly in

applied chemistry and in mineralogy. From 1845 to 1885 he was co-editor of the *Journal of Science*, and he published very popular manuals of chemistry and of physics, and a volume on *American Contributions to Chemistry* (1875).

Silloth, a seaport and watering-place of Cumberland, on the Solway Firth, 20 miles W. of Carlisle. Prior to the opening of the railway in 1856 it was a mere hamlet, but it is now of growing importance, with good docks opened in 1857-85. Silloth, which commands a fine view, is much resorted to for sea-bathing, the climate being mild and salubrious, and considered highly favourable for those affected with pulmonary complaints. The mean annual temperature is 49° F., being the same as that of Worthing (q.v.) on the south coast of England, and only 1° below that of Torquay. Pop. (1861) 1521; (1881) 2116; (1891) 2600.

Silo. See SILAGE.

Siloam, a great rock-cut pool to the south-east of Jerusalem, with a second or lower reservoir connected with it by an aqueduct. See JERUSALEM and map; and for the ancient Siloam inscription describing the making of a tunnel from a spring to the pool, found in the tunnel in 1880, see INSCRIPTIONS, Vol. VI. p. 159; HEBREW LANGUAGE, Vol. V. p. 614.

Silures, an ancient people inhabiting the south-east of South Wales and the adjoining English area—Glamorgan, Brecknock, Monmouth, Radnor, Hereford. They were a dark and curly-haired race, and were probably of a non-Aryan stock—Iberian or Euskarian—though ultimately Celticised in language and manners. Less civilised than their British neighbours, they were more warlike, and offered fierce resistance to Ostorius Scapula and the other Roman commanders who invaded their country. See WALES, BASQUES, CELTS; Elton's *Origins of English History* (1882), Rhys's *Celtic Britain* (1882).

Silurian System, a name given by Murchison in 1835 from the Silures (q.v.) in South Wales, where this system is well developed. The sedimentary strata consist principally of grits, slates, dark shales, flagstones, sandstones, and conglomerates, and interbedded with these occur occasional calcareous bands, and more or less lenticular beds of limestone. The following table gives the succession of the Silurian system of Britain:

UPPER SILURIAN....	{ Ludlow Group. Wenlock Group. Upper Llandovery Group.
LOWER SILURIAN....	{ Lower Llandovery Group. Bala and Caradoc Group. Llandoello Group. Arenig Group.

The strata attain a thickness of more than 20,000 feet, and have a wide distribution. In Wales the basement beds rest conformably on the upper members of the Cambrian system, while a well-marked unconformity separates the Lower from the Upper Silurian. Silurian rocks are exposed at the surface in many of our upland areas: thus, they form a large part of the high grounds of Wales, Westmorland, and Cumberland, and the major portion of the Southern Uplands of Scotland, and they likewise extend into the Scottish Highlands. In the hilly parts of Ireland they are also well developed at the surface; nor can there be much doubt that the same strata, buried under younger systems, extend throughout the larger part of the British Islands. The deposition of the Lower Silurian was marked by the appearance of considerable volcanoes in Wales, Westmorland, Ayrshire, and the south-east of Ireland.

On the continent of Europe Silurian strata have an extensive development. They occupy large

tracts in Scandinavia and the basin of the Baltic, and probably continue eastwards under the great plains of northern Russia, for they crop up along the flanks of the Ural Mountains. In middle and southern Europe they rise again and again to the surface in mountain-regions, from which it may be inferred that they underlie vast areas in the surrounding low grounds. In North America Silurian rocks extend westwards from the mouth of the St Lawrence by the great lakes into the far north-west, and south-west by the Alleghanies into Alabama. As more or less isolated areas rise to the surface in the interior of the continent, it is probable that Silurian strata, concealed under younger formations, extend throughout the interior continental basin; and they reappear in the Rocky Mountains. The system has been recognised as entering into the formation of the Cordilleras of South America. Silurian strata have also been detected in the Himalayas and other parts of Asia, in Australia, and New Zealand.

The Silurian rocks which occur in mountainous areas are usually much indurated and dip at high angles, being frequently much contorted and dislocated. In the Highlands of Scotland and in Norway they have even been subjected to such disturbance that they have over wide areas acquired a more or less schistose or foliated character. In other low-lying regions, however, as in Russia, the strata are not indurated, and occur in horizontal or gently inclined positions.

Life of the Period.—Plant-remains consist almost exclusively of seaweeds, only a few traces of land-plants having been met with. These indicate a cryptogamic flora—ferns and lycopodiaceous trees. The lower forms of animal life were represented chiefly by sponges (Amphispongia, Astylospongia, &c.). Amongst the Cœlenterata were numerous forms of graptolites and corals. The former are eminently characteristic of the Silurian, and abound in certain thin bands of black shale. Those with two rows of cells are mostly confined to the Lower Silurian, while the single-rowed graptolites are upon the whole most common in the Upper Silurian. Corals abounded—certain limestones appearing to be almost wholly made up of their remains. Some common or characteristic rugose forms were *Omphyma*, *Zaphrentis*, *Cyathophyllum*, &c. Prominent tabulate forms were *Halysites*, *Favosites*, &c. The living Aleyonarian corals (*Heliopora*) were represented by *Heliolites*. Crinoids or sea-lilies were very numerous—their jointed stems and arms entering largely into the composition of many of the limestones. Cystideans, which attained their maximum development in Silurian times, star-fishes, and brittle-stars appear to have been less abundant. Annelid-tracks are common on the surfaces of beds, and the filled-up burrows of sea-worms frequently occur. Now and again jaws of annelids are likewise met with, and occasionally their tubular cases (*Serpulites*, *Spirorbis*) are seen attached to shells, corals, &c. Among the most characteristic Silurian fossils were the Trilobites, which made their first appearance in Cambrian seas and reached their greatest development in the Silurian age. They lived on in much diminished numbers through the Devonian and Carboniferous periods, and became finally extinct in Permian times. Some of the more widely distributed Silurian forms are *Ogygia*, *Trianclens*, *Asaphus*, *Ilænus*, *Phacops*, *Calymene*, &c. Other remarkable Arthropods were the Eurypterids (an extinct order allied to the existing king-crabs). One of these (*Pterygotus*) was seven or eight feet in length. *Ostracods* (*Beyrichia*) and *Phyllopo*ds (*Ceraticaris*) likewise occur in Silurian rocks. Here also we meet with the first scorpion (*Palaophonon*) and the earliest insect (*Palaoblattina*, a form of cockroach). Various lace-corals

(*Fenestella*) and other Polyzoa occur, but by far the most abundant forms amongst Molluscoids were the Brachiopods. Characteristic types are *Discina*, *Orthis*, *Leptæna*, *Pentamerus*, *Rhynchonella*, *Strophomena*. Lamellibranchs were much less numerous—*Modiolopsis*, *Ctenodonta*, and *Ortho-*nota are examples. Amongst Gasteropods the more common genera are *Euomphalus*, *Bellerophon*, *Holopella*, *Murchisonia*, and *Pleurotomaria*. The Cephalopods are well represented by straight and coiled chambered cells: amongst the former is *Orthoceras*, many species of which are known; the latter show such types as *Cyrtoceras*, *Lituites*, *Phragmoceras*, *Nautilus*, &c. Vertebrates make their earliest known appearance in the Upper Silurian. The remains consist of bony bucklers or head-shields of ganoid fishes (*Pteraspis*, *Cephalaspis*), the defensive spines of some cestracrioni, and fragments of shagreen-like skin and plates.

Physical Conditions.—The Silurian strata appear to have been deposited chiefly in shallow seas, which here and there, however, may have been moderately deep. No certain indications of true oceanic conditions have yet been met with. During the formation of the Lower Silurian strata the entire area of the British Islands, with the exception, perhaps, of some of the Archæan tracts of the north-west, appears to have been under water. At this time active volcanoes, forming groups of islets, were scattered over the area of what is now North and South Wales, the south-east of Ireland, and southern Ayrshire. Considerable earth-movements affected the British area at the close of the Lower Silurian period—the bed of the sea being here and there elevated, so that islands of considerable size came into existence at the beginning of the Upper Silurian period. Eventually, however, a movement of depression supervened, and the islands referred to were submerged and gradually buried under the sedimentary accumulations of the Upper Silurian sea. Judging from the geographical distribution of the Silurian strata, we are led to conclude that enormous areas of what are now our continents were during the accumulation of those rocks overflowed by shallow seas. The main land-masses of the period seem to have been grouped chiefly in boreal regions and were composed essentially of Archæan rocks. In Europe and North America alike the old land-surface lay towards the north, but the great continental ridges may have risen here and there to the surface in other places so as to form groups of islands, as in Bavaria and Bohemia in Europe, and in the region of the Colorado and Park ranges in America.

The temperature of the seas was such as to allow of the migration of closely allied and apparently identical species of molluscs, crustaceans, &c. over vast regions. In arctic lands fossils occur which are met with likewise in the Silurian rocks of Wales; more than this, many Silurian species were truly cosmopolitan, ranging from the extreme north across the equator to Australia. To have allowed of such world-wide distribution the temperature of the seas must have been singularly uniform. But while not a few Silurian species were cosmopolitan, many others appear to have had a more restricted range. Thus it may be inferred that, however uniform the climatic conditions may have been, the uniformity nevertheless was only comparative, and that even in Silurian times the oceanic areas had their distinct life-provinces. It is remarkable that in the Lower Silurian of Scotland large erratic blocks of gneiss and other crystalline rocks occur, and similar blocks are met with in the Silurian strata of the Lake Superior region. It is difficult to see how such blocks could have been transported without the agency of floating ice. See also the articles MURCHISON and GEOLOGY.

Siluridæ, or CAT-FISHES, a large family of fresh-water fishes, included in the order Physostomi. The skin is naked, or equipped with some bony scutes, never with scales; the dorsal fin is short and is occasionally absent—when present it is inserted above or in front of the ventrals; there is generally an adipose fin; the maxilla is very small; the barbels are well developed. The family is represented in most parts of the world. In Europe, however, there is only one Siluroid, the Sheat-fish or Shadden (*Silurus glanis*), which occurs in some eastern and central regions—e.g. in the Danube and the Elbe. In size it sometimes

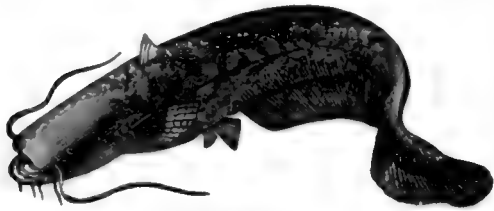

Silurus glanis.

approaches the sturgeon, and is a sluggish but very voracious animal, and has been the subject of many strange stories. In North America most of the common cat-fishes belong to the genus *Amiurus*; in tropical America the genus *Pimelodus* has many representatives (see CAT-FISH). In many species of *Arius*—a marine genus—common in the East Indies and on both coasts of Central America, the males hatch the eggs in their mouths. Species of *Doras*, common in South America, are remarkable for their habit of travelling from one pond to another. In northern Africa the most remarkable Siluroid is the Electric Cat-fish, *Malapterurus electricus*.

Silver (sym. Ag; equiv. 108; sp. gr. between 10.47 and 10.57), one of the very earliest known of the metals, is of a peculiar and beautiful white colour, by which it can be distinguished from all other metals or alloys, except one or two rare metals, such as lithium and indium, which are seldom seen. Silver is harder than gold, but softer than copper. It takes a very high polish, and for this reason was sometimes used for making small mirrors by the ancient Romans. It ranks next to gold in malleability and ductility, the thinnest silver-leaf produced by hammering being only $\frac{1}{500000}$ of an inch thick; and a wire of the metal can be drawn so fine that a length of 130 yards weighs only one grain. It has been usually stated that silver has a clear ringing sound when struck, but accurate observers, like Karsten and Percy, say that, on the contrary, a bar of the metal emits a dull sound on receiving a blow. Silver conducts heat and electricity better than any other metal, for which reason it is adopted as the standard represented by 100. Its melting-point has been variously stated, but appears to be about 1904° F. (1040° C.). Silver does not suffer even from long exposure to the atmosphere, except that it readily tarnishes when sulphuretted hydrogen or animal exhalations containing sulphur are present. Both nitric and sulphuric acid dissolve silver; and aqueous hydrochloric acid, as well as a solution of common salt, converts the surface of the metal into the chloride of silver. The metal is not attacked by caustic alkalis.

Oxides of Silver.—Three compounds of silver with oxygen are known. *Argentous Oxide* or *Protoxide of Silver*, Ag_2O , is the best defined of the three. If to an aqueous solution of nitrate of silver lime-water or baryta-water be added, this oxide of

silver is precipitated. The same brown precipitate is obtained if pure potash or soda be used as the precipitant. The protoxide of silver when moistened absorbs carbonic acid from the air. It decomposes and loses its oxygen at 572° F. (300° C.), and ignition takes place when it is rubbed in a mortar with sulphide of arsenic or of antimony and other easily oxidisable substances. The other two oxides of silver are the *Argentous Oxide* or *Suboxide*, Ag_2O , and the *Peroxide*, Ag_2O_2 .

Sulphide of Silver, Ag_2S .—The strong affinity silver has for sulphur is seen from the readiness with which it blackens in an atmosphere containing sulphuretted hydrogen. A silver coin can be easily darkened by rubbing it with sulphur or by placing it in contact with vulcanised india-rubber, which contains sulphur. Sulphide of silver can be prepared by melting together silver clippings and sulphur in a covered crucible. It is also formed when sulphuretted hydrogen or a soluble alkaline sulphide is added to an aqueous solution of a salt of silver, the silver sulphide precipitating as a black powder. The tarnish on silver articles which from their nature cannot be easily rubbed with leather and rouge or brushed can be readily removed by an aqueous solution of cyanide of potassium; but as this salt is poisonous the article should be afterwards carefully washed. Silversmiths perfectly restore the original white colour to darkened silver objects by heating them in contact with carbonate of soda and nitre. Statuettes and other art objects in silver are frequently 'oxidised,' as it is called. This is really darkening their surface more or less by a film of sulphide produced by immersing them in a hot solution of sulphide of potassium. The prominent parts are then brightened by brushing or otherwise. The native compounds of silver and sulphur (ores) are noticed below.

Chloride of Silver, AgCl .—This salt is prepared by adding to an aqueous solution of the nitrate of silver either hydrochloric acid or chloride of sodium (common salt), when a thick, white, curdy precipitate of the chloride is thrown down. The precipitate requires to be washed and dried in the dark, and it is then an anhydrous white powder. When fused and allowed to cool it becomes waxy or hornlike, in which state it is translucent or even transparent in thin plates. In this massive condition it is still sometimes called by the old name of *horn silver* or *luna cornea*, whether native or artificially prepared. Chloride of silver is very insoluble in water, so that an extremely small proportion of silver may be detected in water by the formation of chloride. It dissolves in ammonia-water and cyanide of potassium or sodium. When a solution of chloride of silver in ammonia-water is boiled a fulminating compound is deposited; but this can be avoided by evaporating the solution at a gentle heat, by which treatment scales of the chloride separate. As commonly prepared, chloride of silver blackens by exposure to daylight. Native chloride of silver is an important ore of the metal, and is referred to below. So also are the native compounds of silver with bromine and iodine.

Cyanide of Silver, AgCy , is obtained by precipitation as a white powder when hydrocyanic acid or cyanide of potassium is added to an aqueous solution of nitrate of silver. It is insoluble in water, but aqueous solutions of ferrocyanide of potassium, hyposulphite of soda, and ammonia and some of its salts dissolve it. It forms double salts with various metallic cyanides, one of these, the *argentocyanide of potassium*, being of great service in Electro-metallurgy (q.v.). Mr A. Wright, surgeon, Birmingham, first applied this salt to electroplating, his invention having been bought and patented by the Messrs Elkinton in 1840.

Copyright 1892, 1897, and 1900 in the U.S. by J. B. Lippincott Company.

Nitrate of Silver, AgNO_3 , is one of the most important salts of the metal. It crystallises in colourless tabular plates belonging to the prismatic system, has a specific gravity of 4.355, and fuses at a low temperature, forming after solidification the *lunar caustic* used as an escharotic by surgeons. If during fusion the temperature is allowed to rise above 383°F . (198°C .) the salt is decomposed. Nitrate of silver dissolves in rather less (783) than its own weight of water at 51.8°F . (11°C .), and is more soluble at higher temperatures. It is prepared by dissolving silver in moderately strong nitric acid with the aid of heat, and has a very bitter taste. Unless in contact with organic matter, nitrate of silver is not blackened or discoloured by the action of light. An ink for marking linen or cotton is prepared by dissolving 2 parts by weight of nitrate of silver and 1 part of gum-arabic in 7 parts of water, a little Indian ink being added. For the use of nitrate of silver in taking photographic pictures, see PHOTOGRAPHY. Black stains upon the hands or upon linen caused by nitrate of silver may be removed by a strong solution of iodide of potassium, or more efficiently by cyanide of potassium, which, however, is poisonous. When phosphorus is kept immersed in an aqueous solution of nitrate of silver the metal is reduced. This supplies a means of coating delicate objects with a film of silver. The article is dipped for a moment in bisulphide of carbon containing $\frac{1}{2}$ of its weight of phosphorus in solution. As the bisulphide evaporates, phosphorus is left in a state of fine division over the surface of the object, which is then dipped into an aqueous solution of nitrate of silver, from which silver is reduced by the phosphorus. Such objects as insects, feathers, and lace can be thus coated with silver, but adroitness is necessary, as finely-divided phosphorus takes fire spontaneously.

Sulphate of Silver, Ag_2SO_4 .—This salt is formed either by adding sulphate of soda to an aqueous solution of nitrate of silver, when it is thrown down as a precipitate, or by boiling granulated silver with sulphuric acid. The process for 'parting' an alloy of silver and gold by sulphuric acid is referred to below.

Silver can be removed from old plated articles by boiling them in a menstruum of 3 lb. of sulphuric acid, 1 lb. of water, and $1\frac{1}{2}$ oz. of nitrate of potash. The silver in the solution is then precipitated as the chloride, and from this the metal is recovered.

ORES OF SILVER.—*Native silver* occurs in many forms and in numerous localities. It crystallises in the cubical system. Some specimens are of dendritic or arborescent form; others are found in laminae or foil; others again are massive, or occur in grains or specks disseminated through veinstone of different kinds. Native silver is usually associated with other ores of the metal. All native gold contains more or less silver, and when the proportion of the latter reaches about 20 per cent. the native alloy is called *electrum*. The amount generally varies between 3 and 25 per cent., but some of the specimens of pale gold found in Transylvania contain 38 per cent. of silver. In Europe native silver has been found most largely at Kongsberg in Norway, where the mines have been worked since 1623. Most of the silver produced by these mines has been obtained in the native state. Some very heavy single pieces have been found; one in the Copenhagen Museum weighs 560 lb., but another lump was dug out nearly three times as heavy. At Freiberg in Saxony a mass weighing 140 lb. was once obtained. A mineral vein on Silver Islet, Lake Superior, contains much native silver; and at Minnesota, on the same lake, the native copper is sometimes studded with native

silver in the form of lumps, or grains, or stringy pieces. Native silver is or was abundant in the great Comstock lode in Nevada, and is common in the silver lodes of Mexico, Chili, and Peru.

Argentite, Silver Glance, Vitreous Silver, Sulphide of Silver.—A large amount of silver is obtained from this ore, which is abundant in Mexico and in the deep part of many mines in Chili. It occurs in the Comstock lode, Nevada, and sparingly in some European mines, including some in Cornwall. Argentite crystallises in the cubical system, and when pure contains 87 per cent. of silver and 13 of sulphur.

Stephanite, Brittle Silver Ore, Sulph-antimonite of Silver.—This ore is found in the same European localities as Stephanite, and likewise occurs in Mexico, Chili, Idaho, and Nevada. Small quantities of it have occasionally been got in Cornwall. Crystallising in the rhombohedral system, it often forms like Proustite, to be presently referred to, a very beautiful mineral of a blood-red colour, which, however, darkens by exposure to light. When pure, pyrrargyrite contains 60 per cent. of silver, 22 of antimony, and 18 of sulphur.

Pyrrargyrite, Dark Red Silver Ore, Sulph-antimonite of Silver.—This ore is found in the same European localities as Stephanite, and likewise occurs in Mexico, Chili, Idaho, and Nevada. Small quantities of it have occasionally been got in Cornwall. Crystallising in the rhombohedral system, it often forms like Proustite, to be presently referred to, a very beautiful mineral of a blood-red colour, which, however, darkens by exposure to light. When pure, pyrrargyrite contains 60 per cent. of silver, 22 of antimony, and 18 of sulphur.

Proustite, Light Red Silver Ore, Sulph-arsenite of Silver.—This ore is found in the same European localities as Stephanite, and likewise occurs in Mexico, Chili, Idaho, and Nevada. Small quantities of it have occasionally been got in Cornwall. Crystallising in the rhombohedral system, it often forms like Proustite, to be presently referred to, a very beautiful mineral of a blood-red colour, which, however, darkens by exposure to light. When pure it contains 65½ per cent. of silver, 15 of arsenic, and 19½ of sulphur.

Stromeyerite, Sulphide of Silver and Copper.—The cuprififerous silver ores of Chili are said to consist chiefly of this mineral, but it is usually so intimately mixed with felspathic vein-stuff that it is difficult to separate pure pieces. It is also found in Arizona, California, Silesia, and Siberia. In its pure state, its composition is silver 53.1, copper 31.1, and sulphur 15.8 per cent.

Chlorargyrite, Cerargyrite, Kerate, Horn Silver, Chloride of Silver.—The most important localities for this valuable ore are Nevada (White Pine District), California, Idaho, Arizona, British Columbia (Fort Hope), certain districts in Mexico, Chafarcillo in Chili, and in the Silverton district and Barrier Ranges in New South Wales. But it also occurs, though for the most part sparingly, at Kongsberg in Norway, Allemont in France, the Saxon and Harz mining districts, and in one or two Cornish mines. It crystallises in the cubical system, but is usually massive with a wax-like appearance. It is malleable and sectile. This ore when pure contains 75 per cent. of silver and 25 of chlorine.

Embolite, Chloro-bromide of Silver. is the chief ore obtained in the mines of Chafarcillo in Chili, but it is believed that much of the ore called chloride of silver is really this mineral. Embolite contains from 61 to 68 per cent. of silver with variable proportions of chlorine and bromine.

Bromite, Bromyrite, Bromargyrite, Bromide of Silver.—This is the chief constituent of a silver ore found in a few Mexican mines, and it also occurs in Chili. The pure ore consists of 57½ per cent. of silver and 42½ of bromine.

Iodite, Iodyrite, Iodargyrite, Iodide of Silver, is a comparatively rare silver ore, occurring in a few of the Mexican and South American mining districts; also in Arizona and Spain.

Arquerite is a native silver amalgam containing 86½ per cent. of silver and 13½ of mercury. It is the principal ore of the mines in the Arqueros district near Coquimbo in Chili, but it is also found with alluvial gold in British Columbia. Other silver amalgams are found in some European mines as well as elsewhere.

METALLURGICAL PROCESSES.—Owing to its high value and the many different ways in which silver occurs in nature, the metallurgical processes in use for the extraction of the metal from its ores are perhaps more varied than those employed in the case of any other metal. If it were obtained only or chiefly from comparatively rich or pure ores the state of matters would be different, but silver is most largely extracted from ores in which the metal in some form is minutely and sparsely disseminated through an earthy or rocky matrix, or from ores of common metals in which it is present in only very small proportion, as in the case of argentiferous lead and copper ores. More than one-half of all the silver produced is obtained from lead ores. The scarcity or abundance of fuel is an important question in determining what process can be most economically employed. The three important methods of separating silver from its ores are (1) by forming an amalgam of silver with mercury, from which the latter is afterwards separated by distillation; (2) by converting the silver in sulphuretted ore or regulus into a soluble salt, and from its solution precipitating the silver by metallic copper or iron; (3) by forming a rich alloy with lead, as through the smelting of silver ores with galena or other lead ore, from which the silver is afterwards separated by cupellation.

Amalgamation Processes.—The Mexican or Patio amalgamation process, invented by Bartholomé Medina about the middle of the 16th century, has been practised with but little alteration down to the present time. Silver is one of the metals which mercury unites with at common temperatures, but the amalgamation proceeds more quickly with the mercury at or near its boiling-point. Mexican silver ores consist of sulphides, chloride, chlorobromide, and native silver generally disseminated through rocky gangue or other minerals. The ore, first broken into small pieces by stamps or edge stone mills, is most frequently ground in Mexico in a circular trough (*arrastré*), in some cases 9 feet in diameter and 1 foot deep, with a flat bottom formed of hard stones. In the centre revolves a vertical shaft on which are fixed four arms, each carrying a heavy stone by which the ore is reduced to a fine powder, or rather, as water is used, to a fine mud.

In the Patio process, which is best suited for sulphuretted silver ores, the materials used besides the ground ore are *magistral* (sulphide of copper roasted, so as to produce as much sulphate as possible), common salt, and mercury. The ore, at first a fine mud, is partially dried and worked into flat circular heaps, which, though sometimes smaller, generally contain from thirty to sixty tons. Salt-earth is then added in such quantity as will yield chloride of sodium amounting to fully six per cent. of the ore, a limited quantity of water being used. After a mixture of this salt with the ore is made, the heap is made circular and trodden by horses for two hours, the mixture being turned over by men in the middle of the operation. The next step is to add about two per cent. of *magistral*, which is spread over the ore and incorporated with it also by the feet of horses. If the ore under

treatment contains about sixty ounces of silver per ton, then mercury to the extent of 24 lb. per ton is spread over the heap in small globules by pressing it through linen bags. Only about two-thirds of this mercury is, however, added in the first instance, and the mass again trodden for two hours by horses. The ore in the heap, now called a *torta*, is next turned over by men, and horses once more trot over it for a rather longer time. After this the mixed mass of ore, mercury, and other materials is left to rest for a day, when horses again travel over the *torta*. It is now time to add the second portion of mercury, and again to turn over the ore mixture. Further treading by horses and turning over by men follow at intervals of days, the completion of the amalgamation process taking about a fortnight in summer and considerably longer in winter. The dry amalgam produced by the above operations now receives an addition of mercury to render it liquid enough to admit of its being separated from the slime by washing.

For what is called the *Cazo or Caldron process*—i.e. the hot amalgamation method as practised to some extent in Mexico, but more generally in South America—the suitable ores are those containing native silver or such as consist of silver in union with chlorine, bromine, or iodine. It is unsuited for sulphuretted ores. After having been ground, dressed, and washed, the ore is put into a caldron with a thick copper bottom, along with water to form a thin mud. A fire is then lighted beneath it, and just before the liquid stuff begins to boil common salt to the amount of about one-sixth part of the weight of the ore is added, and enough mercury put in, but not all at once, to form a soft amalgam. The liquid is constantly stirred by revolving arms on an upright shaft with copper blocks attached to them. In about six hours the operation is completed, and the amalgam is then separated from impurities. Care is necessary in this process not to use excess of mercury, which should not be more than four times that of the silver by weight. A greater quantity produces adhesion of the silver amalgam to the copper, and sometimes a copper amalgam is formed if the blocks rotate too slowly.

The amalgam, after being subjected to filtration through canvas, is distilled in an iron bell-shaped vessel or cylindrical retort, by which the mercury is expelled as vapour and the fumes condensed in a trough containing water. The silver remains in the retort, and is afterwards cast into bars.

The great silver-producing region of the United States was only discovered so recently as 1859. The lodes occur either in the Rocky Mountains or to the west of them, in the states of Montana, Idaho, Nevada, California, Colorado, Arizona, and in Utah and New Mexico. There is great variety both in the kind of ores which are found and in their richness in silver. Much of the ore raised contains both gold and silver.

Argentiferous lead ores consisting of earthy carbonates and sulphates as well as galena are found largely in Utah. The amount of silver in these ranges from 10 to 150 ounces per ton, but in some places the minimum quantity is 70 ounces. These ores are smelted at various works, and the resulting argentiferous lead is desilverised by the zinc process (see LEAD). Sulphuretted silver ores prevail in the United States, and these require to be roasted in furnaces along with the common salt to drive off the sulphur and to form the silver into a chloride. Such ores are previously crushed by stamps or rollers in the dry state, but the more easily decomposed silver ores are crushed wet. What is called the *Pan Amalgamation Process* is that most largely practised in the silver-works of

these western states. This method is founded on the Cazo process above described, an iron pan being used instead of a copper vessel. These pans, which were introduced soon after the silver ores of Nevada and adjoining states began to be worked, are tube 5 or 6 feet in diameter, and generally made entirely of iron. Each has a vertical shaft passing up through the centre, upon which is fitted a revolving muller with iron shoes, which come almost close to dies fixed to the bottom, and between which the pulp passes. This shaft is kept in motion by strong spur gearing, and there is usually a double bottom to the pan for heating by steam. Different pans are in use, but they vary more in detail than in principle. Fig. 1, from Egleston's *Metallurgy*, shows the Horn pan in section. These vessels are charged half-full of crushed ore and water, and they are designed with the intention of uniting as far as possible a grinding with a stirring surface. Common salt, sulphate of copper, and sometimes other chemicals are added to the charge. A pulp is produced just thick enough to allow the

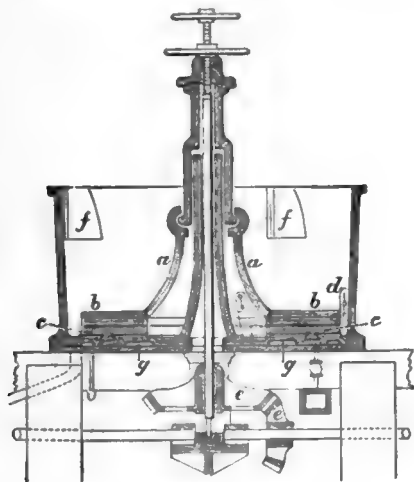

Fig. 1.—Amalgamating Pan :

a, muller; b, shoes fixed to muller; c, dies fixed to bottom of pan; d, scraper; e, driving wheels; f, wings to prevent pulp rising too high; g, steam space.

muller to rotate, and the temperature of the charge is raised by steam to from 160° to 200° F. The necessary quantity of mercury is added, and the pulp containing the amalgam is ready to be removed after the charge has been in the pan five hours. The amalgam is then cleaned and strained, and the mercury separated from the silver by distillation in a cast-iron retort.

Freiberg Processes.—The Barrel Amalgamation Process, formerly practised with much success at Freiberg in Saxony, is or very recently was in use at some silver-extraction works in America. The Freiberg ores are complex. Certain lodes contain various sulphuretted silver ores in quartz vein-stuff, but other lodes yield along with these argentiferous galena, zinc-blende, copper and iron pyrites, and other metalliferous minerals in a vein-stuff of baryta, spathic carbonates, &c. These ores were pulverised and so mixed that the poorer class contained 30 or 40 ounces of silver per ton, and the richer class three or four times as much. An ore of this nature is roasted with common salt to convert the sulphide of silver into chloride, after which it is finely ground and placed in the amalgamating casks along with water, scrap-iron, and mercury. The iron reduces the silver to the metallic state,

and it then combines with the mercury to form an amalgam which, when separated from the residues, is distilled in iron retorts. This is a more perfect system than the Mexican method, but there is a considerable expense for fuel. Fig. 2 shows

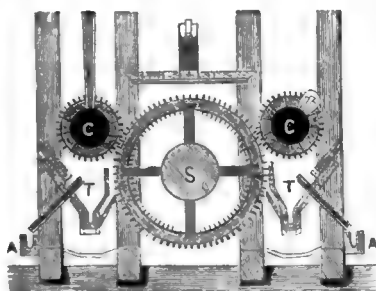

Fig. 2.—Vertical Section of Amalgamating Apparatus : C, C, oak barrels; S, toothed wheel for setting the barrels in motion; A, A, troughs for amalgam; T, T, troughs for residues.

the arrangement of rotating barrels used in this process.

At the present time silver is obtained at the Freiberg works by the smelting of argentiferous lead and copper ores in a Pils blast-furnace, an illustration of which is given in the article LEAD. The charge is composed of lead ores, zinc-blende, and pyritic ores, some of which are highly siliceous. This ore-mixture contains the following metals, the average percentage of each being—lead 23, zinc 13, copper 3, and silver '08 to '60, together with sulphur and quartz gangue. The ore is first roasted in a reverberatory furnace, and then smelted in the Pils furnace along with slags and various residues rich in silver. Coke is used as fuel, and the products of the furnace are lead containing a variable amount of silver, a regulus of lead and copper with from 0.1 to 0.2 per cent. of silver, and a slag containing lead with sometimes '04 per cent. of silver. The lead in the regulus is separated from the copper by another smelting. Most of the silver is retained by the lead, and is recovered from it by Pattinson's desilverising process and subsequent cupellation. See LEAD.

Augustin Process.—This and the next are wet processes for the extraction of silver. When certain argentiferous ores or products are roasted with common salt the chloride of silver is formed. This chloride is soluble in a strong solution of common salt, and from the solution so formed metallic silver is precipitated by means of copper. An equivalent quantity of copper chloride is at the same time formed, from which metallic copper is in turn precipitated by iron. Sulphuretted ores or compounds are used in this process.

Ziervogel Process.—No simpler process is known for the extraction of silver from argentiferous copper pyrites (which nearly always contains iron) or of an ore in which it is an important constituent. The method is based upon the fact that sulphide of silver contained in the ore, or matt derived from it, is converted into a soluble sulphate by very careful roasting. By the reactions in the furnace sulphate of iron is first formed, then sulphate of copper, and finally, by the decomposition of these, sulphate of silver, which is readily dissolved out of the roasted ore by hot water. The silver is then precipitated from the solution by copper.

Smelting of Silver.—At Kongsberg in Norway, and at Wyandotte in Michigan, silver ores, consisting chiefly of native silver with other minerals in a rocky matrix, are smelted in furnaces. At the former locality, by the addition of iron pyrites to

the ore, a regulus consisting chiefly of sulphide of iron and some sulphide of copper is first formed. When in the molten state this is mixed with one-third of its weight of lead, which, after taking up most of the silver, separates by its own weight. From this silver-lead the silver, amounting to 5 per cent. of the alloy, is separated by cupellation. At Wyandotte a slightly richer silver-lead is produced which is also cupelled.

Combined lead and silver smelting, as conducted in Great Britain from native ore (argentiferous galena), is described under LEAD. There are no silver ores properly so called produced in the United Kingdom, but foreign ores are smelted along with lead ores or rich lead slags.

Liquation Process.—Silver can be separated from argentiferous copper by this process, which consists in heating a fused mixture of the copper with a large excess of lead to a temperature above the melting-point of the latter, but below that of the copper. In this state of matters the lead liquates or sweats out of the mass, carrying with it the greater part of the silver which the copper contained. This silver can then be extracted from the lead by cupellation.

Cupellation.—This process consists in melting lead rich in silver on the hearth of a small furnace, and blowing air over its surface, the oxygen of which, under the influence of the heat, rapidly converts the lead into litharge or plumbic oxide. Fused litharge has the property of dissolving the oxides of some other metals, such as copper, zinc, tin, antimony, &c. Silver, however, is not oxidised by this treatment. The result of the operation is that the whole of the lead put in the furnace, together with small quantities of other oxidisable metals (present as impurities), are removed as oxides, and the silver is left on the bed of the furnace. In the English cupellation-furnace the bed or hearth is movable, and is formed of an oval iron frame or test rammed full of powdered bone-ash. The German cupellation-furnace (shown in fig. 3)

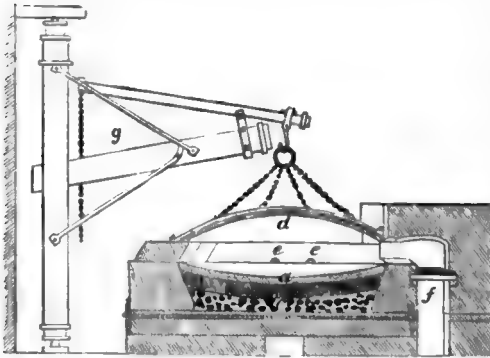

Fig. 3.—Silver Cupellation-furnace:

a, hearth of marl or clay; b, bricks; c, bed of slag; d, movable cover; e, e, tuyeres connected with bellows; f, fireplace; g, crane for lifting cover.

is of larger capacity than the English, and has a movable domed cover constructed of iron. The diameter of this furnace is about 10 feet, and the hearth is covered with marl. These furnaces differ only in details and in the way in which they are charged. In the United States what is termed a Steitz water-back cupel—a hollow casting through which water flows—is used in the first stage of cupellation.

There are three processes for separating silver from gold practised on a large scale. One of these is a very old method. It is called 'parting' by

nitric acid. The alloy, which may consist of one part by weight of gold to two of silver or of one of the former to three of the latter, is melted and granulated—i.e. formed into small beads. It is then boiled (in platinum or earthenware vessels) with nitric acid, of 1·4 sp. gr. and an equal bulk of water, for several hours, till the silver is almost all converted into nitrate, the gold forming the residue after the dissolved silver is removed. To this solution of nitrate of silver common salt is added to precipitate the silver as chloride, from which the metal is reduced by the action of granulated zinc and weak sulphuric acid. The silver is then washed, pressed, dried, and melted, producing bars almost pure from the alloys generally treated.

Another method of 'parting' is by boiling the alloy in concentrated sulphuric acid. Auriferous silver, either granulated or in bars, is placed in cast-iron pots along with sulphuric acid, which is cautiously raised to the boiling-point. The silver, if it does not much exceed 200 lb. in weight, is dissolved in about eight hours, but sooner if granulated. The gold falls down as a sediment, and the sulphate of silver is drawn off by a platinum siphon or otherwise. The solution of sulphate of silver is then diluted with water, and the metal precipitated by scrap-iron. Impurities in the alloy sometimes render the sulphuric acid method of parting troublesome.

Separation of silver from argentiferous gold is now effected by chlorine, a method patented by F. B. Miller in 1867, and soon afterwards used at the Sydney mint and at other places. Gold, to the amount of 600 or 700 ounces, is melted in a clay crucible, and a little melted borax thrown in. Chlorine gas is then admitted through a suitable pipe, the end of which almost reaches the bottom of the crucible, so that the gas is forced to bubble up through the molten gold. At first volatile chlorides of some of the baser metals, which may be present in very small quantity in the alloy, escape through holes in the cover of the crucible, but the chloride of silver does not. Chlorine is supplied till it is found that no more is absorbed, which shows that practically all the silver has been changed into chloride. When this is the case the crucible is allowed to cool sufficiently to allow the gold to solidify, and the red-hot liquid chloride of silver is then formed into slabs in moulds. This chloride generally contains 2 per cent. of gold, but it is eliminated by adding metallic silver, with which the gold forms an alloy. From the slabs of chloride of silver the metal is reduced by using them as one of the elements of a galvanic battery.

The production of silver has increased enormously since the discovery of the rich deposits in the western states of North America, the development of which may be said to have begun with the surface-workings of the Comstock lode, Nevada, in 1859. But in 1861 the yield of the United States was still comparatively small, amounting in value to not more than £400,000. In 1871 it had risen to £4,600,000; in 1881 the value of the production was £8,600,000; and in 1889 it reached the yearly total of £12,929,000. Colorado and Montana are now the great silver-producing states. The director of the United States mint gives the value of the silver production for 1889 in the following countries: Mexico, £11,103,400; Chili, Bolivia, and Peru together, £4,085,000; European countries, £2,136,000; and he makes out the total production of the world in that year to be £32,583,000. (The annual produce of the silver districts in the Barrier Range region, New South Wales, now amounts in value to nearly £2,000,000. The silver district of Zeehan, on the west coast of Tasmania, from which in 1891 galena ore containing 110 ounces of silver per ton reached England, promised

to increase the world's supplies.) The total production of silver over the world in 1898 was estimated at 183,000,000 oz., of which the United States contributes 64,000,000 oz.; Mexico, 58,000,000 oz.; Australasia and Bolivia, 17,000,000 oz. each; Peru, 10,000,000 oz.; Canada, Spain, and Chili also contributing. While the *coinage* value in the United States is \$1.29 per troy ounce, increased production has greatly diminished the bullion value. Up to 1873 it varied little from \$1.20; but in 1888 the average price per oz. was about \$0.94; in 1890, \$1.04; in 1892, \$0.87; in 1894, \$0.63; in 1896, \$0.67; in 1898, \$0.58½ (at the end of the year, \$0.59); and on June 30, 1900, \$0.61½.

Silver is largely used for coinage, plate, jewellery, and watch-cases, and for electroplating articles of German silver and Britannia metal. Silver compounds are used in photography, in glass-staining, and in several chemical preparations, including marking-ink and hair-dyes. It seems to have been a favourite metal with the great nations of antiquity, personal ornaments found in Egypt, as well as ancient Greek and Roman statuettes, vases, dishes, coins, and other objects made of silver being among the treasures of the chief national museums in Europe. Like gold, silver is too soft to be used alone for vessels, jewellery, or coin, for which reason it is usually alloyed with copper. English 'standard silver' is composed of 925 silver and 75 copper. Of this alloy the silver coins and 'hall-marked' silver-plate of Great Britain is made. The alloy used for all silver coins in the United States, and major silver coins in France and Austria, is 900 silver and 100 copper or other inferior metal. Further references to silver will be found in the articles on Alloy, Assay, Bimetallism, Chasing, Filigree, Embossing, Hall-marks, Mining, Mint, Mirror, Numismatics, Electro-metallurgy, Metal-work, Photography, and Repoussé.

See Percy's *Metallurgy* (1880); Egleston, *Metallurgy*, (1887); J. A. Phillips, *Gold and Silver* (1867); Eissler, *The Metallurgy of Silver* (1889); works by Lamborn (1879); Aaron (San Francisco, 1876), and Stetefeld (New York, 1889); vol. iii. of the Report on the United States Survey of the 40th Parallel, for a report on the Chemistry of the Pan Process; Monographs of the U.S. Geological Survey, vols. iii. and iv., for the Geology and Mining of the Comstock Lode.

Silverfish, a name given to the Atherine (q.v.) and to artificially bred Goldfish (q.v.).

Silverton, the centre of a mining district in the extreme west of New South Wales, only 18 miles from the border of South Australia and more than 800 W. by S. from Sydney. It is connected with the railway system of South Australia. Silver (principally), copper, tin, and gold are mined in the district to the annual value of 1½ million sterling. The town has stores, churches, banks, and a brewery. Broken Hill, one of the largest silver mines in the world (see NEW SOUTH WALES), is 17 miles SE. of Silverton.

Silvester. See SYLVESTER.

Simancas, a village of Spain, 7 miles SW. of Valladolid, where the national archives of Spain have been kept since the reign of Philip II. (1563). There are more than 30 million documents in all (see BERGENROTH). Pop. 1258.

Simarubaceæ, a natural order of trees and shrubs, with alternate, generally compound leaves, without stipules; regular, generally hermaphrodite flowers. The species are not numerous; they are found in the tropical parts of Asia, Africa, and America. The whole order is characterised by great bitterness, and several of the species are used as tonics in dysentery, &c. Quassia (q.v.), Bitterwood (q.v.), and Ailanto (q.v.) belong to it.

Simaruba is itself a genus with several species, all belonging to tropical America.

Simbirsk, a town of Russia, stands on the right bank of the Volga, 350 miles SE. of Nijni-Novgorod. It has two Greek cathedrals, a large trade in wheat, wool, fruits, and potash, and a famous annual fair. The town is new, having been rebuilt since its destruction by fire in 1864. Pop. 39,047.—The government has an area of 19,105 sq. in. and a pop. (1895) of 1,525,500.

Simcoe, LAKE, in Ontario, between Georgian Bay and Lake Ontario, 30 miles long and 18 broad.

Simeon, CHARLES, an eminent evangelical preacher, was born at Reading in Berkshire, September 24, 1759. He was educated at Eton and King's College, Cambridge, was elected to his life-long fellowship at his college in January 1782, that same year took orders, and immediately after was appointed Perpetual Curate of Trinity Church, Cambridge, an office which he held till the close of his life, November 13, 1836. As early as twenty he had been converted through reading Bishop Thomas Wilson's book on the Lord's Supper, and as a preacher he was distinguished for an impassioned evangelicalism that at first aroused a bitter and protracted opposition. But he made many converts, and came to exercise an enormous influence not only in Cambridge, but all over England. He took a foremost part in the work of founding the Church Missionary Society, and it was mainly his influence that sent the sainted Henry Martyn to India. Simeon paid several visits to Scotland, first in 1796, when he preached freely in the pulpits of the Church of Scotland—the Moderate majority in the General Assembly prevented this on his second visit in 1798—rode over a great part of the country and climbed Ben Lomond with James Haldane, the pair consecrating themselves anew to God at the top. Simeon's conversation-circles at Cambridge were famous in his day, and his old age was untroubled and full of honour. His influence long survived his death by means of the society he established for purchasing adwosons. Simeon's *Horæ Homileticæ* (17 vols. 1819-28; new ed. 21 vols. 1832-33) contain as many as 2536 sermon outlines. See the *Memoirs* by the Rev. W. Carus (1857), *Recollections of Simeon's Conversation Parties* by Abner W. Brown (1862), and the Study by H. C. G. Moule (1892).

Simeon Stylites. See STYLITES.

Simferopol, a town of Russia, stands in the Crimea, 50 miles by rail NE. of Sebastopol, and has extensive gardens and vineyards. Pop. (1866) 16,550; (1895) 43,755.

Simia, the Latin name for an ape or monkey, and used by Linneus in an almost equally wide sense, of which such current expressions as 'Simian tricks,' 'Simian language,' are a reflection. Technically, however, Simia is now reserved for the genus to which the Orang-outang (*S. satyrus*) belongs. Simiidae includes the Anthropoid Apes: Simiinae, the higher of the two sub-families of Simiidae, comprising the gorilla, chimpanzee, and orang.

Simile. See METAPHOR.

Simla, a British sanatorium, the headquarters of the British government in India during the hot months of summer, stands on the southern slopes of the Himalayas, in a beautiful situation, 170 miles N. of Delhi. Its first house was built in 1819, and it was first visited officially by the Indian government in 1827, having since 1864 been regularly made its headquarters every summer. There are here two viceregal residences (the newer one built in 1886), handsome government buildings (1884), a fine town-hall (1886),

several European schools, and various public institutions. Population 13,800 in winter, and considerably more in summer.—The *district* has an

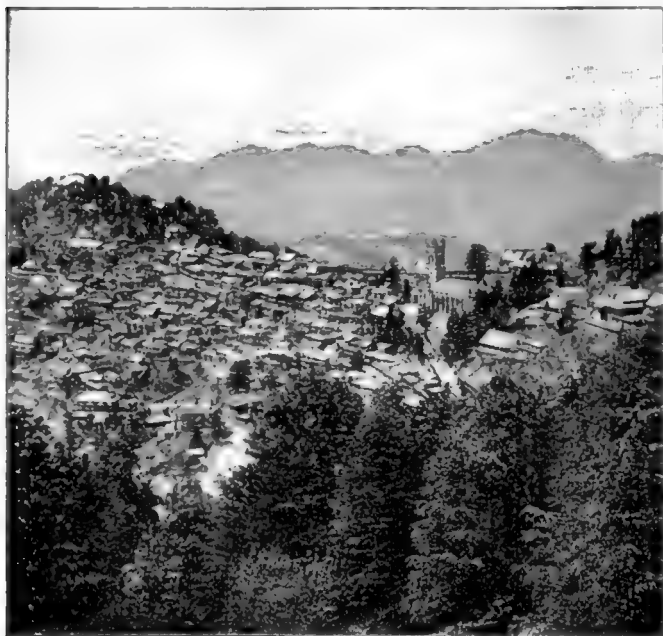

View of Central Simla.

area of 81 sq. m. and a population of 50,000.—The name Simla Hill States is given to twenty-three native States, all small, in the neighbourhood of Simla. Their united area is 6570 sq. m., and their population is over half a million.

Simms, WILLIAM GILMORE, American author, born at Charleston, South Carolina, April 17, 1806, at first was placed with a druggist there, but at eighteen began the study of law, though he scarcely practised. His earliest volume, *Lyrical and other Poems*, was published in 1827. In 1828 he became editor of the *City Gazette*, which opposed nullification and died in 1833. Meanwhile he had published *The Vision of Cortes* (1829); *The Tri-colour* (1830); and in 1832 *Atalantis, a Story of the Sea*. From this time he poured out rather than wrote poems (perhaps the best *Southern Passages and Pictures*, 1839), novels (among them *The Yemassee*, *The Partisan*, and *Beauchampe*), histories, and biographies in rapid succession, almost till his death, on 11th June 1870. His style is crude but vigorous, and his writings display strong imagination and many of the gifts of the born story-teller. An illustrated edition of his works in 17 vols. appeared at New York in 1882-86. There are Lives by Cable (1888) and Professor W. P. Trent (in 'American Men of Letters' series).

Simnel, LAMBERT. See HENRY VII.

Simois. See SCAMANDER.

Simon, JULES, French statesman, economist, and author, was born at Lorient (Morbihan), 31st December 1814. He received the names of Jules François Simon Suisse, but on reaching manhood chose the designation of Jules Simon only. After a brilliant educational career, he succeeded Victor Cousin (whose ardent disciple he was) as lecturer on philosophy at the Sorbonne in 1839. He was returned to the Chamber of Deputies for the department of the Côtes-du-Nord in 1848, and took his seat with the Moderate Left. He refused the

oath of allegiance to the empire, and by the year 1869 had become one of the most popular chiefs of the Republican party. He was minister of Public Instruction in the Government of National Defence; but in 1873 his measures dealing with secondary education were violently opposed by the clericals, and he resigned. He now became leader of the Republican Left. In 1874 he assumed the direction of the *Siccle* newspaper; in 1875 he was elected a life-senator; and in 1876 he was appointed prime-minister, taking the portfolio of the Interior. President Macmahon and the Right, however, resented his liberal attitude towards the press, and he forthwith resigned. M. Simon pronounced the funeral oration on M. Thiers. He always showed himself a consistent advocate of Free Trade, and took a prominent part in the revision of the Constitution. Subsequently his Republicanism developed a more conservative character, and he opposed M. Jules Ferry's bill for the expulsion of the religious orders. In 1880 the French Academy elected him a member of the new Supreme Educational Council, and two years later he was elected permanent secretary of the Academy of Moral and Political Sciences. He died at Paris 8th June 1896. Besides

editing Descartes, Bossuet, Malebranche, and Antoine Arnauld, and contributing to the *Revue des Deux Mondes* and other periodicals (his last work was *Indices et Portraits*, 1893), Simon was author of *Histoire de l'École d'Alexandrie* (1844-45); *La Liberté de Conscience* and *La Liberté* (1859); *La Religion Naturelle* (1856); *L'Ouvrière* (1863); *L'École* (1864); *Le Travail* (1866); *La Politique Radicale* (1868); *Souvenirs du 4 Septembre* (1874); *Le Gouvernement de M. Thiers* (1878); *Dieu, Patrie, Liberté* (1883); *Une Académie sous le Directoire* (1885); *Mémoires des Autres* (1889); and *Studies on Thiers, Guizot, Remusat, Mignet, Michelet, Henri Martin, Victor Cousin, Caro, Reybaud, F. de Coulmings, &c.* Died June 8, 1896.

Simon, RICHARD, the father of biblical criticism, was born at Dieppe, May 13, 1638. He entered the Congregation of the Oratory in 1659, but soon after withdrew, to return in the later part of 1662. He was sent first to lecture on philosophy in the college of Juilly, but was afterwards appointed to catalogue the oriental MSS. in the library of the Order at Paris. His criticisms upon Arnauld's *Defence of the Perpetuity of the Faith in the Blessed Eucharist* caused great displeasure among the Port-Royalists, and his imprudent meddling with another controversy brought upon his head the wrath of the Benedictines. The scandal occasioned by the appearance of his *Histoire Critique du Vieux Testament* (1678) led to his again withdrawing from the Oratory and retiring to Belleville as *curé*. In 1682 he resigned his parish, and lived in literary retirement at Dieppe, Paris, and again at Dieppe, where he died April 11, 1712. Few writers of his age played so prominent a part in the world of letters, and especially in its polemics. There is hardly a critical or theological scholar among his contemporaries with whom he did not break a lance—Weil, Spanheim, Le Clerc, Isaac Voss, Du Pin, Jurieu, and Jurieu's great antagonist, Bossuet. His *Histoire Critique*

(suppressed through Bossuet's influence, and only printed entire at Rotterdam in 1685) anticipates the most important conclusions of all the later rationalistic scholars of Germany, and also their method of investigation, and, indeed, is the first work which treated the Bible from the point of view of a literary product. For example, he disproves the Mosaic authorship of the Pentateuch, assigning its composition to the scribes of the time of Ezra. Other writings of Simon's are *Histoire Critique du Texte du Nouveau Testament* (Rotterd. 1689); and *L'Histoire Critique des Príncipeaux Commentateurs du Nouveau Testament* (Rotterd. 1693), in which he assails the theology of the Fathers, and particularly that of Augustine, as a departure from the simple and less rigid doctrines of the primitive church. Among the Fathers his most esteemed authority was Chrysostom. Bossuet replied to this last work by his *Defense de la Tradition et des Saints Pères*. Simon frequently published under assumed names—as his *Dissertation Critique* on Dupin's *Library of Ecclesiastical Writers*, under the name of Jean Reuchlin; a work, *Histoire Critique sur la Créance et des Coutumes des Nations du Levant*, under the anagram of Monis; and a *Histoire de l'Origine et du Progrès des Revenus Ecclésiastiques*, under the name of Jerome Acosta.

See the Life by K. H. Graf in *Strassburger theol. Beiträge* (1847); A. Bernus, *Richard Simon et son Histoire Crit. du V. T.* (Lauz. 1869), and the same scholar's *Notice Bibliographique* (Basel, 1882).

Simonides, a celebrated Greek lyric poet, was born at Iulis, in the island of Ceos, in the year 556 B.C. He repaired to Athens on the invitation of Hipparchus, and after his death took up his residence in Thessaly, under the patronage of the Aleuadæ and Scopadæ, who appear to have treated him in a very niggardly fashion. Shortly before the invasion of Greece by the Persians he returned to Athens, and devoted his poetic powers to celebrating the heroes and the battles of that momentous struggle in elegies, epigrams, and dirges. He carried off the prize, even from Æschylus, for the elegy on the heroes that fell at Marathon. He won as many as fifty-six times in these poetical contests. He spent his last ten years at the court of Hiero of Syracuse, where he died in 468. Simonides appears to have scandalised his contemporaries by writing for hire; and his great rival Pindar accuses him, apparently not without good reason, of excessive avarice. He brought to perfection the elegy and epigram, and excelled in the dithyramb and triumphal ode; he seems also to have invented the art of artificial memory. The characteristics of his poetry are sweetness (whence his surname of *Melicertes*), polish combined with simplicity, genuine pathos, and power of expression, although in originality he is much inferior to his contemporary Pindar. The best editions of his fragments are those of Schneidewin (1835) and Bergk (*Poetae Lyrici Græci*, vol. 2).—Simonides of Ceos must be carefully distinguished from the iambic poet SIMONIDES of Amorgos, who flourished about 660 B.C.

Simon Magus ('Simon the Magician'), the wicked sorcerer who thought that the gift of God might be purchased with money, and for this was excommunicated by Peter. The word Simony (q.v.) is derived from his name. When first introduced in Acts, viii. 9-24, Simon, apparently about 37 A.D., had already for a long time been a commanding personality in 'the city' of Samaria through his sorceries. Giving himself out to be 'some great one,' he had induced the people 'from the least to the greatest' to call him 'that power of God which is called Great.' Simon and the Samaritans had believed and were baptised under the

ministry of Philip the Evangelist; and when the apostles Peter and John conferred on Philip's converts the gift of the Holy Ghost (including apparently the gift of tongues) Simon, hoping for new magical powers, went to the apostles and offered money that he might be enabled to confer the same gift. Peter's reply is known; Simon, rebuked, was submissive, and here the narrative of the Acts (written probably before the end of the 1st century) leaves him. But his penitence was only temporary. Justin Martyr says Simon afterwards went to Rome in the reign of Claudius as a wonder-worker and was reckoned a god, having a statue erected to him by the senate and people with the inscription 'To Simon the Holy God.' Justin, himself a Samaritan, adds that 'almost all the Samaritans' and 'a few even of other nations' worshipped Simon as the 'First God,' and a woman Helena, who went about with him and had formerly been a harlot, they adored as his 'First Idea.' Irenæus follows Justin in the main, and adds that Simon professed to have appeared among the Jews as the Son, in Samaria as the Father, and to other nations as the Holy Spirit. From Simon, according to Irenæus, 'all sorts of heresies' derived their origin, including Antinomian doctrines. His followers worshipped images of Simon and Helena as Zeus and Athene. Hippolytus, who quotes much from Simon's work *The Great Announcement*, says that Simon encountered Peter at Rome, that he ordered his followers to bury him, promising to rise the third day, but that he never rose. Origen questions whether in his time there were more than thirty Simonians in the whole world. In the pseudo-Clementine *Homilies* and *Recognitions* (in their present form not older than the 3rd century) Simon comes into frequent conflict with Peter at Casarea, Antioch, and elsewhere.

Baur in 1831 was the first to observe the indisputable fact that in some portions of these books it is the apostle Paul who is caricatured under the guise of Simon—portions he believed to come from 1st-century Ebionite sources. Others of the Tübingen school went further and traced the whole story of Simon to the antipathy of the Jewish Christians against the apostle Paul, whom they regarded as a pretender (the false as opposed to the true Simon), a 'Samaritan,' a libertine, and a bewitcher of men. Now, however, it is generally agreed that some facts regarding Simon must be accepted as historical, and that likely enough a pseudo-Messiah named Simon appeared in Samaria in the fourth decade of the 1st century. Perhaps Klostermann and Wendt are right in holding that the 'power of God which is called Great' (Gr. *Megalê*) ought to be interpreted according to the Samaritan word *Megala* ('Revealer'). Simon's 'revelation' or new religion had apparently for its main articles a doctrine of the essential oneness of many widely different cults—hence the attempted fusion of Baal, Zeus, the Father, the Son, the Holy Spirit—and a 'syncretistic-gnostic' conception of the world and its creation, together with ethical Antinomianism.

But it is obvious that the story of Simon has received accretions from a variety of extraneous sources. Thus, Justin was wrong about Simon's statue at Rome, the inscription he quotes being almost certainly identical with a dedication (still extant) by a private individual to Semo Sancus, a Sabine deity. The statement of Irenæus that Simon and Helena (called in the Clementines *Selênê*, 'the moon') were worshipped under the images of Zeus and Athene may rest on a misapprehension of the Syrian Baal and Astarte worship, or on a misunderstanding of the Semitic word *Shem* or *Sem* ('name'). Further, no one now believes that *The Great Announcement* cited by Hippolytus as Simon's dates from so early a period. Opponents

have mixed him up with other sorcerers of Cyprus, Cæsarea, and Rome; and his disciples, anxious to combine as many elements as possible in their new world-religion, added to the confusion by their readiness to identify their master with the most incongruous personalities. Simon is a true magician in this at least, that he still eludes our grasp. The legend of Simon and Helena continued to be read in the middle ages; and several traits of Simon may be recognised in 'Doctor Faustus.'

See Baur's *Paul*, and his *History of the Church in the First Three Centuries* (both translated), and earlier works there cited; Hilgenfeld's *Clem. Recognitionen u. Homilien* (1848); Zeller's *Apostelgeschichte* (1854); Lipsius in Schenkel's *Bibel-Lexicon* (1875) and his *Apokr. Apostelgeschichten* (1877); Harnack's *Gnosticismus* (1873), and his *Dogmengeschichte* (1886).

Simonoseki. See SHIMONOSEKI.

Simon's Bay and Town. See CAPE COLONY.

Simony (derived from Simon Magus), in English law, means, according to Blackstone, the offence of obtaining orders or a license to preach by money or corrupt practice. But the term is now commonly used to denote the offence of presenting or procuring presentation to a benefice for money. In the canon law this was considered a heinous crime and a kind of heresy. As the canonical punishment, however, was not deemed sufficient, a statute was passed in the time of Elizabeth defining its punishment. A simoniacal presentation was declared to be utterly void, and the person giving or taking the gift or reward forfeited double the value of one year's profit; and the person accepting the benefice was disabled from ever holding the same benefice. Presentation bonds, however, taken by a patron from a presentee to resign the benefice at a future period in favour of some one to be named by the patron, are not illegal, provided the nominee is either by blood or marriage an uncle, son, grandson, brother, nephew, or grandnephew of the patron, and provided the bond is registered for public inspection in the diocese. The result of the statutes is that it is not simony for a layman or spiritual person, not purchasing for himself, to purchase, while the charge is filled, either an advowson or next presentation, however immediate may be the prospect of a vacancy, unless that vacancy is to be occasioned by some agreement or arrangement between the parties. Nor is it simony for a spiritual person to purchase for himself an advowson, although under similar circumstances. It is, however, simony for any person to purchase the next presentation while the church is vacant; and it is simony for a spiritual person to purchase for himself the next presentation, although the charge be occupied. See ADVOWSON, and Cripps's *Laws of the Church and Clergy*.

Simoom, or SIMOON (Arab. *samûm* or *samûn*; from *samm*, 'poisoning'), is a hot, suffocating wind common in the deserts of Africa and Arabia, as well as in Sind and Beluchistan. It is essentially of the same nature as a cyclone; there is a central tract of calm surrounded by violent eddies of intensely heated air, and the entire system keeps moving slowly forward, generally from south to north or from east to west. Its presence is heralded by whirling currents of air, and indicated by the purple colour of the atmosphere. It often carries with it huge rotating columns of sand, or stifling gusts and showers of fine sand. It is highly deleterious to men and animals, causing the sensation of suffocation, together with great pain in the limbs. Spring and summer are the usual times of its occurrence; but it seldom lasts many minutes, not more than twenty at the outside. See DESERT, STORMS, WHIRLWINDS.

Simplon (Ital. *Sempione*), a mountain-pass (6594 feet high) of Switzerland. The Simplon Road, leading over a shoulder of the mountain from Brieg in Valais to Domo d'Ossola (41 miles) in Piedmont, was commenced in 1800 by Napoleon, and completed in 1806 at a cost of £720,000. It is carried across more than six hundred bridges, over numerous galleries cut out of the natural rock or built of solid masonry, and through great tunnels. Close to the highest point is the New Hospice (opened in 1825), one of the twenty edifices on this route for the shelter of travellers. After much preliminary negotiation, the convention between Italy and Switzerland for the construction of a railway tunnel through the Simplon was finally approved at Rome and Berne in December 1896. There will be two parallel tunnels, 12½ miles long, about 60 feet apart, with connections every 670 feet. The height above the sea will only be 2312 feet. The Swiss terminus will be at Brieg, and the Italian end at Iselle. Operations were commenced from both ends in August 1898; it is estimated to take 5½ years to construct, and to cost £2,800,000.

Simpson, SIR JAMES YOUNG, physician, was born at Bathgate, Linlithgowshire, 7th June 1811, a baker's son, the youngest of a family of eight. He early showed a peculiar talent for medical observation and research; and in the prosecution of his professional studies at the university of Edinburgh, which he entered at the age of fourteen, he so attracted the notice of his teachers as to inspire all of them with an active interest in his future career. He took his M.D. in 1832, his thesis on *Death from Inflammation* winning the highest admiration; and in 1835 was elected president of the Royal Medical Society. Professor Thomson chose him as his assistant (1837-38), and employed him in the preparation of his course of lectures on General Pathology. During the illness of the professor he supplied his place in the lecture-room with unusual skill and address. He now began professional practice on his own account, and in 1840 succeeded Professor Hamilton in the chair of Midwifery. This position he held with yearly enhanced distinction, and by the rigidly scientific, while popularly attractive, character of his prelections contributed greatly to the renown of the Edinburgh school, both at home and abroad. He was indefatigable, amid the distracting cares of an extensive practice, in promoting the scientific perfection of his art; and his *Obstetric Memoirs* (2 vols. 1856), edited by Dra Priestley and Storer, contains the fruits of much patient and ingenious research. In 1847 he was appointed one of Her Majesty's Physicians for Scotland. The discovery by which he will be more particularly remembered is that of the anæsthetic virtues of chloroform. Sulphuric ether had been employed in America by Morton to produce Anæsthesia (q.v.) during the extraction of teeth; but to Simpson belongs the credit of first, in March 1847, introducing chloroform to the scientific world. In 1859 he recommended the stopping of hæmorrhage by Acupressure (q.v.). In his own peculiar field of obstetrics his improvements on the old methods of practice were numerous and valuable; his antiquarian researches are embodied in his posthumous *Archæological Essays* (1872). He was created a baronet in 1866, and died 6th May 1870. A bronze statue was erected in Edinburgh in 1877.

Besides the *Obstetric Memoirs* already mentioned his medical and archæological works include a volume on *Acupressure* (1864), one on *Homœopathy*, *Selected Obstetrical Works*, *Anæsthesia*, *Clinical Lectures on the Diseases of Women*, and many papers and notices read before the Royal and Antiquarian Societies of Edinburgh. See the *Memoir* by Duns (1873), and works by his daughter (1897) and Laing Gordon (1897).

Simpson, THOMAS, one of the most eminent of the numerous non-academic mathematicians of England, was born on the 20th August 1710, at Market Bosworth in Leicestershire. His father was a stuff-weaver, and, intending his son to follow the same occupation, gave him little or no education. The son, however, had a taste for study, and embraced every opportunity for gratifying it. In consequence he quarrelled with his father and went to Nuneaton. Here he worked at his trade, and eked out his earnings by teaching an evening school and by casting nativities. The last occupation threatening to get him into difficulties, he removed to Derby, where he remained from 1733 to 1735 or 1736. Thence he went to London, and began teaching mathematics. In 1737 he published a *Treatise of Fluxions*; in 1740 a *Treatise on the Nature and Laws of Chance*, and a volume of *Essays on Several Subjects in Speculative and Mixed Mathematics*; in 1742 the *Doctrine of Annuities and Reversions*; in 1743 *Mathematical Dissertations on Physical and Analytical Subjects*; in 1745 a *Treatise of Algebra*; in 1747 *Elements of Geometry*; in 1748 *Trigonometry Plane and Spherical*; in 1750 the *Doctrine and Application of Fluxions*; in 1752 *Select Exercises for Young Proficients in the Mathematics*; and in 1757 *Miscellaneous Tracts*. He was a frequent contributor to the *Ladies' Diary*, of which he was the editor from 1754 to 1760. In 1743 he was appointed professor of Mathematics in the Royal Academy at Woolwich, and in 1745 he was admitted a Fellow of the Royal Society. He died on the 14th May 1761. A biographical notice by Dr Charles Hutton, giving some curious details of Simpson's life, is prefixed to Davis' edition (1805) of the *Doctrine and Application of Fluxions*.

Simrock, KARL JOSEPH, a German poet and scholar, whose name is indissolubly associated with the revival of interest in old German literature, was born at Bonn, 28th August 1802. He studied at the university of his native city and at Berlin, and in 1826 entered the Prussian state service. His first work was a translation into modern German of the *Nibelungenlied* (1827; 50th ed. 1890). Soon after the publication of his translation of Hartmann von der Aue's *Armer Heinrich* (1830) he was compelled to leave the Prussian service on account of a revolutionary poem which he had written. Afterwards he devoted himself exclusively to literature, and more particularly to the early literature of his own country, which he has modernised in excellent style—e.g. the poems of Walter von der Vogelweide (1833), Wolfram von Eschenbach's *Parzival* (1842), *Reineke Fuchs* (1845), *Die Edda* (1851), Gottfried von Strassburg's *Tristan und Isolde* (1855), the *Heliand* (1856), *Beowulf* (1859), *Der Wartburgkrieg* (1858), Brant's *Narrenschiff* (1872), &c. Besides these editorial labours he translated Shakespeare's poems and some of his plays, and published *Quellen des Shakspeare in Novellen, Märchen, und Sagen* (3 vols. 1831), in conjunction with Echtermeyer and Henschel; *Novellenschatz der Italiener* (1832); *Rheinsagen aus dem Munde des Volkes und Deutscher Dichter* (1836); a collection of German *Volksbücher* (13 vols. 1844-67), comprising national proverbs, songs, and riddles, besides a vast quantity of stories; *Das Heldenbuch*, partly translations and partly original poems (6 vols. 1843-49) illustrative of the heroic traditions of the Teutonic race; his own *Gedichte* (1844); and a considerable number of handbooks. In 1850 he was appointed professor of Old German Language and Literature at Bonn, a post which he held till his death, on 18th July 1876. See a monograph on him by Hocker (Leip. 1877).

Sims, GEORGE ROBERT, born in London, 2d September 1847, joined the staff of *Pan* in 1874, in 1877 commenced his 'Dagonet' contributions to the *Referee*, and also contributed series of papers to the *Weekly Dispatch*. Among his plays are *Crutch and Toothpick* (1879), *Mother-in-law* (1881), *The Lights o' London* (1881), *The Romany Rye* (1882), and, among others written in collaboration, *In the Ranks* (1883), *Harbour Lights* (1885), *The Golden Ladder* (1887), and *The Grey Mare* (1892). His novels include *Rogues and Vagabonds*, *Memoirs of Mary Jane*, *Mary Jane Married*, *Dramas of Life*, *Memoirs of a Mother-in-law*, &c.; and his letters to the *Daily News* on the housing of the London poor also deserve mention.

Simson, ROBERT, was born in Ayrshire on the 14th October 1687. He was educated at the university of Glasgow with a view to entrance into the church, but, finding theology uncongenial, he devoted himself to mathematics, and specially to geometry. In 1711 he was appointed professor of Mathematics in Glasgow, and he occupied this chair for the long period of half a century. One of the first subjects to which he turned his attention was the restoration of Euclid's lost treatise on *Porisms*. This had been previously attempted, but without success, owing to Pappus' meagre and obscure description of what a porism was. It is Simson's greatest achievement that he elucidated the nature of the ancient porisms, though his restoration of them is not complete. A specimen of his discovery was printed in the *Philosophical Transactions* of the Royal Society of London in 1723, but his treatise on the subject did not appear till after his death. His *Sectiones Conicæ*, in five books, was published in 1735; the first three books were afterwards translated into English, and have been repeatedly printed. His restoration of Apollonius' *Plani Loci* had been finished about 1738, but was not published till 1749. The work by which he is best known is his *Elements of Euclid*, which appeared both in Latin and English in 1756. It contained the first six books, the eleventh and twelfth, and was the basis of nearly all the editions published for more than 100 years afterwards. In 1761 he resigned his professorship, and occupied himself till his death, which took place on the 1st October 1768, in the arrangement and correction of his mathematical papers. His only publication after his retirement was a second edition of the *Elements* (1762), to which he annexed the book of *Data*. In 1776 a large volume, *Roberti Simson Opera quedam Reliqua*, was printed at the expense of Earl Stanhope, one of Simson's intimate friends, and liberally distributed. It contains a restoration of Apollonius' two books *De Sectione Determinata*, with the addition of other two *De Porismatibus*, and two tracts on logarithms and the limits of quantities and ratios. See Memoir by the Rev. W. Trail (1812).

Sin is not simply moral evil as recognised by the awakened human conscience, but guilt before God or the gods. Some doctrine of sin, and of the mode of averting the anger of the deity, of reconciling him, and of escaping from the guilt, is accordingly part of most religions, ancient and modern. Zoroastrianism is a conflict of sin and holiness. The central doctrine of Buddhism turns on the demerit of human actions and human life, which must be purged by transmigration. But in no sacred books is the sense of sin so keen and developed as in the Bible—in the writings of the prophets of the God of holiness, in the psalms, in the gospels, and in Paul's epistles. From Paul's various utterances on the great subject of sin the latest Christian doctrine professes to be but a development.

Throughout the Scriptures sin appears as that element in man which puts him at enmity with God, and for his salvation from its guilt and power required the work of a Redeemer (see CHRISTIANITY). Sin is not defined in Scripture, and it was not till the controversies between Pelagius and Augustine, at the end of the 4th century, that the doctrine received full development. The early Greek fathers regarded sin as opposition to the will of God, and as such involving death as its just penalty. But they did not affirm that the guilt of Adam's sin or the corruption of his nature descended to all mankind. Tertullian, in virtue of his doctrine of Traducianism, was bound to hold that sinfulness had been propagated from Adam to his descendants. But it was reserved for Augustine to maintain, against Pelagius, that Adam's sin completely corrupted his whole nature; that the corruption of his guilt and its penalty death pass to all his children; that man is born not merely corrupt, but in a state of sin, guilt, and liability to punishment; in virtue of Adam's *peccatum originale*, the offspring of Adam is a *massa perditionis*, incapable of knowing, or loving, or serving God, and naturally disposed, without grace, to pursue evil only, the will being enslaved to evil. Pelagius (q.v.) maintained contrary doctrines, and semi-pelagianism insists that in spite of the weakening of his powers through hereditary sinfulness man is yet not wholly inclined to evil. The Greek Church continued to deny hereditary guilt, and to affirm man's will as free as Adam's before the fall. Duns Scotus and his followers admitted that man had lost by Adam's fall *justitia originalis*, but laid stress on the freedom of the will. Thomas Aquinas taught that hereditary sin is truly sin, and the unbaptised infant is damned. At the Reformation both Luther and Calvin asserted what they regarded as Augustinian and Pauline views. Zwingli looked on hereditary sin as an inherited evil or disease: Arminians and Socinians practically denied hereditary sin altogether. In modern German speculation the Hegelians taught that sin was a necessary condition of the development of mankind; and Schleiermacher that the sinful state of man was a disturbance of his nature, not a necessary condition of it. The problems connected with sin are closely akin to those connected with the origin of evil and the freedom of the will.

The doctrine of the Thirty-nine Articles (Art. ix.) is as follows: 'Original sin standeth not in the following of Adam (as the Pelagians do vainly talk); but it is the fault and corruption of the nature of every man, that naturally is engendered of the offspring of Adam, whereby man is very far gone from original righteousness, and is of his own nature inclined to evil, so that the flesh lusteth always contrary to the spirit; and therefore in every person born into the world it deserveth God's wrath and damnation.'

The Westminster Confession teaches (chap. vi.): 'By this sin' (i.e. the eating of the forbidden fruit) 'they' (i.e. our first parents) 'fell from their original righteousness and communion with God, and so became dead in sin, and wholly defiled in all the faculties and parts of soul and body. They being the root of all mankind, the guilt of this sin was imputed, and the same death in sin and corrupted nature conveyed to all their posterity, descending from them by ordinary generation. From this original corruption, whereby we are utterly indisposed, disabled, and made opposite to all good, and wholly inclined to all evil, do proceed all actual transgressions.'

Sins have been divided into categories, as sins of omission and of commission, deliberate voluntary sins and involuntary sins, sins of infirmity, &c. The 'sin unto death' (1 John, v. 17), generally

identified with the unforgivable 'blasphemy against the Holy Spirit' (Matt. xii. 31), or 'sin against the Holy Ghost,' is understood not to mean profane speaking against the person of the Holy Spirit, or resisting His operations, but a state of obstinate, malignant deadness of heart, and unrepentant and unhesitating hatred to all good. The distinction accepted by Catholic theology between mortal and venial sins is explained at CONFESSION.

See ADAM, ATONEMENT, AUGUSTINE, CHRISTIANITY, DEVIL, ETHICS, EVIL, FALL, HELL, PAUL, PELAGIUS, SACRIFICE, TRANSMIGRATION, WILL; also Julius Müller's *Christliche Lehre von der Sünde* (1839-44; Eng. trans. from 3d ed. 1852, 5th ed. 1877); Principal Tulloch's *Christian Doctrine of Sin* (1876), and A. Brown's *Doctrine of Sin* (1881); Cardinal Manning's *Sin and its Consequences* (1874); Ernest Naville's *Problem of Evil* (Eng. trans. 1872); Rev. O. Shipley's *Theory about Sin* (1874), and *Principles of the Faith in Relation to Sin* (1878).

Sinai, the sacred mountain on which Moses received from Jehovah the tables of the Ten Commandments, is an individual peak in a vast rocky mass that almost fills the peninsula of Sinai. This peninsula is situated on the north-west of Arabia, and is embraced between the Gulf of Suez and the Gulf of Akaba, northern arms of the Red Sea, and is shut in on the north by the desert. In this mountain-mass there are three separate mountains clearly distinguishable—Mount Serbal (6750 feet); Mount Catherine (8540 feet), lying south-east of Serbal; and Umm Shomer (some 8000 feet). Authorities, ancient theologians and historians and modern travellers and commentators, are greatly divided on the identification of the Sinai of Moses, some (Eusebius, Jerome, Lepsius, Ebers, &c.) upholding the claims of Serbal, others (Farrar, Tischendorf, Strauss, Stanley, Palmer, Sir Charles Warren, Hull, &c.) contending for Mount Catherine. Tradition has pointed to the latter ever since the time of Justinian, but the vexed question is yet far from being settled. The mountain known as Jebel Katherin has two well-marked peaks, a northern one called Horeb and a southern called Jebel Musa (Mountain of Moses). It is this last summit which tradition has selected as the sacred mountain of the Hebrew law-giving. At its foot, in a ravine, stands the fortress-like monastery of St Catherine (founded probably about 527 by the Emperor Justinian), and a short distance above it the chapel of St Elias (Elijah); whilst on its summit is the little pilgrim church. The entire peninsula, especially the bold jagged mountains, has a stern, treeless appearance, though trees (the manna-tamarisk, acacias, date-palms, gum-shrubs, &c.) grow in the ravines, beside the watercourses. Four or five thousand Bedouins range over the peninsula, and feed their sheep and goats in the pasturages of the higher valleys. There are several caves amongst the mountains; these, in the early days of Christianity, were the favourite abodes of numbers of hermits or anchorites. And there are a great many Nabatean (q.v.) inscriptions engraved on the rocks of Sinai, which date from the early centuries of the Christian era.

See amongst other books, Hull, *Mount Seir, Sinai, and West Palestine* (Lond. 1885); Palmer, *Desert of the Exodus* (Camb. 1871); Stanley, *Sinai and Palestine* (1856); *Ordnance Survey of the Peninsula of Sinai* (3 vols. Southampton, 1869); and J. Euting, *Sinaitische Inschriften* (1892); also CODEX, TISCHENDORF.

Sinaloa, one of the Pacific states of Mexico with an area of 36,180 sq. m. and a pop. of 223,684. It contains over 100 mining districts, chiefly producing silver. The capital is Culiacan (q.v.), 100 miles north-west of which is the small town of Sinaloa, with a pop. of 2000.

Sinclair, or ST CLAIR. See ROSLIN, ORKNEY.

Sinclair, SIR JOHN, born at Thurso Castle, 10th May 1754, from Logan's tutorship passed to the High School of Edinburgh, and thence to the universities of that city, Glasgow, and Oxford. He was admitted a member of both the Scottish and English bars (1775-82), but, having in 1770 succeeded to the family estate, he devoted himself to his duties as a northern landlord, and to the more engrossing pursuits of public life. In 1780 he was returned to parliament for Caithness, in 1784 for Lostwithiel, and in 1796 for Petersfield, his parliamentary career extending till 1811. In 1784 he published a *History of the Revenue of the British Empire*; and in 1786 he was created a baronet. He travelled over Europe, gathering information on economical and commercial questions, and on his return set about establishing a society in Scotland for improving the breeds of sheep and the quality of wool. His exertions also led to the formation of the Board of Agriculture in 1793, of which he was president for thirteen years. This institution was the precursor of numerous agricultural associations, by which the country was greatly benefited. Sir John's most important undertaking was originating and carrying through the *Statistical Account of Scotland* (21 vols. 1791-99), comprising a description of every parish in Scotland. The parochial clergy were the chief contributors, but the indefatigable baronet also employed statistical missionaries, and was for seven years actively engaged in prosecuting the work. Sir John wrote on all manner of topics, including even a tragedy and treatises on health and longevity; and his publications during fifty years of ceaseless exertion are said to amount in number to 39 volumes and 367 pamphlets. Not one of the whole seems destined to live; their value perished in the using; but the long and active life of their author was highly beneficial to his country. He died at Edinburgh, 21st December 1835, aged eighty-one. See his Correspondence (2 vols. 1831) and Life (2 vols. 1837).

Sir John Sinclair left a numerous family, of whom the third son, JOHN (1797-1875), was arch-deacon of Middlesex from 1842, and author of *Sketches of Old Times* (1875), &c.; whilst the fourth daughter, CATHERINE (1800-64), wrote a number of tales and descriptive works—*Modern Accomplishments*, *Modern Society*, *Scotland and the Scotch*, *Shetland and the Shetlanders*, &c.—all evincing literary taste and fine moral feeling.

Sind, or SINDH (also spelt *Sinde* and *Scinde*), a province in the north-west of British India, belongs to the presidency of Bombay, and is bounded on the N. by Beluchistan and the Punjab, E. by Rajputana, W. by Beluchistan, and S. by the Indian Ocean and the Rann of Cutch. It contains an area of 56,632 sq. m., with a pop. (1891) of 2,900,000. The seacoast (150 miles) is very low and flat, with the exception of the small portion beyond Karachi (Kurrachee), and is studded with low mud-banks formed by the Indus or with sandhills, the accumulated drift from the beach. The province is traversed from north to south by the Indus (whence the name; see INDIA, Vol. VI. p. 96), and includes the whole of its delta. Along each bank of the river is an alluvial tract of great fertility, from 2 to 12 miles wide, and mostly irrigated by artificial canals and water-courses, which, overflowing during the inundations, cover the soil with a silt so rich as to yield two, and sometimes three, crops in a year. The soil, nevertheless, contains in the north so much salt-petre, and in the south so much salt, that after the year's crops have been obtained these substances are extracted for home consumption and export. Between the Indus and its most easterly branch,

the Nara, is an alluvial 'doab,' which, from want of irrigation, has become almost a desert. East of this is the Thur, a desert of shifting sand. West of the Indus the country is occupied by the desert of Shikarpur on the north, a desert not of sand, but of alluvial clay, the same as that of the delta, which only requires irrigation to render it fertile; and in the south it is traversed by the Hala Mountains. The climate is remarkably sultry and dry, the province being beyond the action of the south-west monsoon; during the long summer the thermometer averages 95° F., and ranges up to 120°; in winter it falls below freezing-point and rises to 80°. There are generally two harvests per annum; the first, or *rabi* ('spring') harvest, consists of wheat, barley, indigo, oil-seeds, gram, hemp, and tobacco; the second, or *kharif* ('autumn') harvest, of rice, millet, oil-seeds, pulses, and cotton. The population consists of the native Sindis, with a large sprinkling of Beluchis and Afghans; the greater portion of them are Mohammedans of the Sunnite faith. The population are almost wholly engaged in agriculture. The trade of the province is concentrated at Kurrachee (q.v.), the capital. Raw cotton, wool, and various grains are the principal exports. Besides Kurrachee (pop. in 1891, 104,250), there are the large towns of Hyderabad (57,790), Shikarpur, Larkhana, and Sukkur.

About 712 A.D. Sind was conquered by Mohammed Kasim, the general of the calif, and since that time has been almost entirely ruled by Mohammedan princes. About 871 the califs lost their hold upon this province, which became divided between the two native kingdoms of Multan and Mansura. In 1026 Sind was conquered by an officer of Mahmud of Ghazni, but the conquest was not at all a permanent one. A new native dynasty was founded in 1051, and was followed by others in 1351 and 1521. In 1592 the country was conquered by Akbar, the Mogul emperor of Delhi; and in 1739 it was incorporated in the dominions of Nadir Shah of Persia. Under Persian suzerainty Sind was governed by various native dynasties. The rulers of Sind always regarded the British with suspicion, and not without reason, for on the outbreak of the Afghan war in 1838 the British government forced the chiefs of Hyderabad and Khairpur to agree to a treaty which virtually destroyed their independence. And when their Beluchi subjects, resenting this arrangement, took up arms, Sir Charles Napier marched against them, totally routed them at Meeanee (17th February 1843), and at Dabo, near Hyderabad (March 24th), and annexed their territories. The British administrators have directed their chief efforts to the development of the commerce of the country, principally by the construction of the Indus Valley Railway and the harbour-works at Kurrachee (q.v.).

See five volumes by Sir R. Burton (1851-77), and A. W. Hulse's *Gazetteer of the Province of Sind* (1876).

Sindia, the title of the Mahratta princes or rulers of Gwalior in India. The founder of the family was RANOJI SINDIA, who from a menial station in the household of the Peshwa rose to a high rank in the bodyguard, and after 1743 received in hereditary fief one-half of the extensive province of Malwa. His son, MADHAVA RAO (MADHOJI) SINDIA (1750-94), joined the Mahratta confederation, and was present at the battle of Panipat (1761), where he was so desperately injured as to be left for dead; but he recovered. In 1770, along with the Peshwa and Holkar, he aided the emperor of Delhi to expel the Sikhs from his territories, the administration of which was handed over to Sindia, thus making him the most powerful of the Mahratta chiefs. He first came into collision with the British in 1779; but in the war which followed fortune distributed her favours

with impartiality, and by the treaty of Salbye (1783) Sindia was recognised as a sovereign prince and confirmed in all his possessions. In 1784 he captured the stronghold of Gwalior, and in the following year marched on Delhi, and subsequently seized Agra, Alighur, and nearly the whole of the Doab (q.v.). The manifold advantages of European discipline had struck him forcibly during the war with the British, and, with the aid of an able French officer, he raised and drilled an army of troops, with whom he reduced Jodhpur, Udaipur, and Jeypore, three Rajput states, and effectually humbled the pride of Holkar. See H. G. Keene's *Madhava Rao Sindhia* ('Rulers of India' series, 1892).—**DAULAT RAO SINDIA** (1794-1827) continued his granduncle's policy, and during the troubles which convulsed Holkar's dominions at the commencement of the 19th century ravaged Indore and Poona, but was routed in 1802 by Holkar. Having joined the rajah of Berar in a raid on the Nizam (1803), he brought down upon himself the vengeance of the East India Company. The confederated Mahrattas were routed at Assaye and Argaum by Sir Arthur Wellesley, and were scattered irretrievably at Laswari by Lord Lake. Thereupon Sindia hastened to sign a treaty by which all his possessions in the Doab and along the right bank of the Jumna were ceded to the British. Gwalior was, however, restored in 1805, and from that time became the capital of Sindia's dominions.—During the reign of **MUGAT (JANAKJI) RAO** (1827-43), a minor, the Gwalior dominions were in such a state of anarchy that the British felt called upon to interfere; a war ensued, and the Mahrattas were routed at Maharajpūr (December 29, 1843) by Lord Gough, and at Panniar by Major-general Grey on the same day. Gwalior fell into the hands of the British, 4th January 1844, and Sindia submitted to the conditions demanded of him, besides maintaining a contingent force of sepoy at Gwalior. During the Mutiny **BAJI RAO** (1843-86), successor of Mugat, took the field against the Gwalior contingent, which had joined the rebels; but most of his troops deserted him during the battle (June 1), and he narrowly escaped by fleeing to Agra. He was subsequently reinstated by Sir Hugh Rose, and received from the British government substantial marks of its goodwill and approbation. He was succeeded by his adopted son in 1886, when the British cantonment was removed from Gwalior.

Sindibad. See SEVEN WISE MASTERS.

Sine. See TRIGONOMETRY.

Sin-eaters, a class of men formerly employed in Wales and on the Welsh border, in connection with funeral rites, to eat a piece of bread and drink a cup of ale placed on the bier, and so symbolically take upon themselves the sins of the deceased. As soon as this was done the sin-eater 'pronounced the ease and rest of the soul departed, for which he would pawn his own soul,' and so took his way, having freed the dead sinner from the necessity of walking an unquiet ghost. The name may be due to a mistaken interpretation of Hosea, iv. 8—'They eat up the sin of my people;' but the real origin of this strange custom must undoubtedly be found in the Levitical *scape-goat* (Levit. xvi. 21-22). Aubrey is the chief authority for this usage, and describes it as once common in Shropshire, Herefordshire, and North Wales. It seems also to have been practised in Galloway. See the paper by E. Sidney Hartland in *Folklore* in 1892.

Sinecure (Lat. *sine cura*, 'without care'), in common language, an office which has revenue without employment. In the canon law a sinecure is an ecclesiastical benefice, such as a chaplainry,

or canonry, or chantry, to which no cure of souls is attached, and where residence is not required. The strictest kind of sinecure is where the benefice is a donative, and is conferred by the patron expressly without cure of souls, the cure either not existing, or being committed to a vicar. Sinecure rectories were abolished in 1840. Sinecure offices were formerly very numerous in the English public service. They were used to enrich ministers of state and their families; Sir R. Walpole, for example, presented his son Horace to three or four sinecure places which brought him in a large income. The number of such places has been greatly diminished by modern reforms; the stewardship of the Chiltern Hundreds (q.v.) and some other offices of merely nominal profit are retained, because by accepting one of them a member of the House of Commons is enabled to vacate his seat.

Sinew. See TENDON.

Singanfoo, the principal city of the Chinese province of Shen-hsi, on a tributary of the Hoang-ho. Pop. stated at 1,000,000.

Singapore, a British dependency in Asia, the most important of the Straits Settlements, consists of the island of Singapore (27 miles long, 14 broad; area, 206 sq. m.), separated from the southern extremity of the Malay Peninsula by a strait only half a mile wide at its narrowest, and of a great number of very small islands along its shores. The surface is undulating, the highest point reaching 520 feet only. The climate is hot and moist, but the soil is not particularly fertile; nevertheless the island is perpetually clothed with verdure, and yields good crops of coffee, pine-apples, cocoa-nuts, aloes, and every kind of fruit, especially East Indian fruit (e.g. mangosteen and durian). Gambier, pepper, and nutmegs used formerly to be the staple crops; but all three are cultivated to a much smaller extent than formerly. This island was purchased in 1824 from the sultan of Johore for £12,500 and a liferent of £5000. Pop. of island (1881) 172,993; (1891) 182,650.

The *capital* of the dependency, Singapore, is the only town on the island. It occupies a pleasant site on the south-east coast, on the Strait of Singapore, the principal waterway for vessels trading between eastern Asia and India and Europe. This city was founded by Sir Stamford Raffles in 1819 as an emporium for British trade in the East Indies, and it has since that time advanced and grown in prosperity till it has become the most important trading-place in the south-east of Asia, its only competitor being Batavia in Java, from which it is 600 miles distant. Singapore is a picturesque, well-built town, with fine public buildings and all kinds of appliances in the nature of public works. It possesses a governor's residence, St Andrew's Protestant cathedral (1861-70), a Roman Catholic cathedral, Mohammedan mosques, Hindu temples, Chinese joss-houses, Raffles museum (1823), the supreme law-courts, post-office (1883), hospitals, gaol, barracks, and fine botanical and zoological gardens. It is defended by numerous batteries and forts, and is a naval coaling station and depot. The docks, stores, and dwelling-houses extend for 6 miles or more along the sea-front. The harbour is spacious and safe and remarkably easy of access, and its dock accommodation embraces two graving-docks, an admiralty dock, and several docks of the ordinary kind. It is a free port, no duties being levied except on wines and beer. The annual trade of Singapore has increased at a remarkable rate since the city was founded. The total trade in 1823 was under £2,000,000; in 1851 about £4,000,000. In 1887 the exports were (taking the dollar at 4s.) valued at £15,012,066; the imports, £18,423,947.

In 1896 the exports were £26,697,041; imports, £31,389,324. The imports embrace nearly every kind of European manufacture; whilst the exports consist of the productions of the East Indies, China, Japan, and the islands of the Western Pacific. The tonnage of the vessels entering the port has been known to increase at the rate of 74 per cent. annually: in 1897 the harbour was entered by 9777 vessels of nearly 8,145,378 tons. The vessels of the P. and O. Company, the Messageries Maritimes, and other large companies trading to China, Australia, and the East put in regularly at Singapore. The population has grown at the same rapid rate as the commerce: in 1824 the town had 10,603 inhabitants; (1850) 50,000; (1871) 97,111; (1881) 139,208; (1891) 160,000. This number included about 90,000 Chinese, 25,000 Malays, 12,000 natives of India, and 1300 Europeans. There is a vast disproportion between the numbers of the male (105,423) and the female (33,785) inhabitants. The death-rate is high, yet the climate, in spite of Singapore being situated little more than 1° N. of the equator, is uniform and agreeable, the nights being particularly cool and refreshing. The thermometer ranges between 67° and 94° F. and has a mean of about 82°. The rainfall varies from 65·6 to 92·2 inches in the year. There was a former town on the site of the present city, which was founded by Malay converts to Hinduism from Java or Sumatra, apparently in the 12th century; but it had wholly disappeared when Sir S. Raffles laid the foundations of the existing Singapore (i.e. 'Lion City'). It was made the capital of the Straits Settlements (q.v.) in 1830, superseding Penang.

Singbhum, one of the four districts of the division of Chota Nagpore (q.v.), with no large towns.

Singer, Isaac. See SEWING-MACHINE.

Singhara Nut. See TRAPA.

Singing. See MUSIC, OPERA, ORATORIO, SOLFA SYSTEM, SOLFEGGIO, SONG, SOUND, THROAT, VOICE.—For Singing-flames, see FLAME.

Single-stick. See FENCING, Vol. IV. p. 578; and *Broadsword and Singlestick*, by Allanson-Winn and Phillippa-Wolley (1890).

Sing Sing, a post-village of New York, pleasantly situated on the left bank of the Hudson (here 3 miles wide, and called Tappan Bay), 31 miles by rail N. of New York City. It contains many villas and a number of boarding-schools, and has some busy manufactories; but it is most widely known as the site of the large state-prison which rises from the bank of the river, and has been built since 1825. The Croton Aqueduct rests here on an arch of masonry with a span of 88 feet. Pop (1890) 9352.

Sinigaglia, or SENIGALLIA (anc. *Sena-Gallia*), a seaport on the Adriatic coast of Italy, 16 miles by rail NW. of Ancona, was down to 1869 celebrated for its annual fair, 20th July to 8th August. It was founded by the Senonian Gauls, and colonised by the Romans 289 B.C. There are here a cathedral (1787) and a palace of the dukes of Urbino. Pop. 9602. Pius IX. was born here.

Sinister. See HERALDRY, Vol. V. p. 661, and BATON-SINISTER.

Sinking Fund, a fund formed by setting aside income every year to accumulate at interest for the purpose of paying off debt. A sinking fund for payment of the national debt of Britain was begun in 1716 by Sir Robert Walpole. Certain taxes which had been laid on for limited periods were then rendered perpetual, for the purpose of paying the interest of the funded debt. They produced more than enough for this pur-

pose, and the surplus was laid aside, that it might accumulate into a fund for extinguishing the debt. It appeared to operate well, since, in 1728, after it had existed for twelve years, debt was wiped off to the extent of £6,648,000. It was not observed that, during the wiping off, new debt had been created to about the same extent, so that the nation was just in the position in which it would have been had it neither borrowed nor repaid. It was in 1784-86, however, that the system was established on a great scale by the younger Pitt, who, notwithstanding his great practical abilities, was entirely misled by the theories of Dr Price in his work on Annuities. The system continued to be conducted on an enormous scale, until another student of economy and figures conclusively proved it to be useless; this was accomplished in 1813 by Dr Hamilton, in his Inquiry on the National Debt. The fallacy which Dr Hamilton showed to pervade the sinking fund of Mr Pitt may be best explained by a simple example. Suppose that one requires to borrow £100, and lays by £5 a year as a fund to pay it up with. Accumulating at compound interest, this fund will pay back the loan in about fifteen years. The borrower will, however, gain no more by the process than if he paid the £5 a year to his creditor, for his debt would be diminishing to precisely the same extent as the fund to pay it off would be increasing. Suppose that, while requiring only £100, the borrower raises £200, and lends out one of them, accumulating the interest until the whole amounts to £200; the borrower will no doubt be receiving interest on £100, but he will be at the same time paying interest on £200; and he would repay his debt at the same cost and with more simplicity if, instead of borrowing the second hundred at 5 per cent., he paid over £5 a year to his creditor. In these instances nothing is lost by the sinking fund. But suppose that in the last case the creditor had agreed to lend the £100 at 5 per cent., but, in consideration of the greater risk, would not lend the £200 at less than 6 per cent., while the borrower can only get 5 per cent. for the half which he relends—here the transaction would cause a dead loss of £2 a year over the plan of repaying by instalments. This was exactly the case with the British sinking fund. The more money the Chancellor of the Exchequer wanted the higher were the terms demanded by the lenders, and the addition to each loan on account of the sinking fund increased the rate of interest paid. A new sinking fund on a better plan was started by Sir S. Northcote (Lord Iddesleigh) in 1875, the permanent charge for debt being fixed at 28 millions. As usually happens in such cases, the fixed rule was not observed; Sir S. Northcote's scheme was suspended by Mr Childers and Sir W. Harcourt, and altered by Mr Goschen. See NATIONAL DEBT, Vol. VII. p. 405; and R. L. Nash, *Sinking Fund and Redemption Tables* (1884).

Sinope (Turk. *Sinub*), a town of Asiatic Turkey, stands on a rocky tongue projecting into the Black Sea, 220 miles W. by N. of Trebizond. It has two harbours, one presenting the finest anchorage along the northern coast of Asiatic Turkey. The town is surrounded by ancient Byzantine walls, and has a ruined castle built under Byzantine influence. The bay was the scene of a naval engagement on 30th November 1853, when a Turkish squadron was destroyed by the Russian fleet. The ancient city of Sinope was founded by a colony of Milesian Greeks, and for several years shared with Byzantium the supremacy of the Euxine. It was made by Pharnaces the capital of the kingdom of Pontus in 183 B.C. The great Mithridates, who was born within its walls, raised it to a lofty pitch of splendour. But in 72 B.C. it capitulated to Lucullus, and in 45 B.C.

was made a Roman colony. After belonging successively to the empire of Trebizond (from 1204) and the Seljuks, it was conquered by the Turks in 1461. Sinope was the birthplace of Diogenes the cynic. Pop. 8000.

Sinter, the name given by German mineralogists to those rocks which are precipitated in a crystalline form from mineral waters. Sinter is of various forms, kidney-shaped, knotted, tuberos, botryoidal, tubular, stalactitic, shrub-like, or pronged, and is occasionally distinguished by its chief component, as Calc-sinter, Siliceous sinter, Iron-sinter, &c. Calc-sinter, which is a variety of carbonate of lime, composed of concentric plane parallel layers, appears under various forms; it is deposited with extraordinary rapidity by many springs, a peculiarity frequently made use of to obtain the incrustation of objects with a coating of this substance. Siliceous sinter is mostly found in intermittent hot springs, as in the Geysers of Iceland (see GEYSER). Iron-sinter occurs in old mines and in coal-beds, where it is formed from iron pyrites through the agency of the atmosphere. The tubular conglomeration of grains of sand half-melted by lightning (*blitz*) is also known as Blitz-sinter, or Fulgurite. See FULGURITES.

Sinus, in Anatomy, a term for the air cavities contained in the interior of certain bones—as the frontal, ethmoid, sphenoid, temporal, and superior maxillary. The frontal sinuses are two irregular cavities extending upwards and outwards, from their openings on each side of the nasal spine, between the inner and outer tables of the skull, and separated from one another by a thin bony septum. They give rise to the prominences above the root of the nose called the superciliary ridges. They are not fully developed till after puberty, and vary considerably in size, being usually larger in men than in women and young persons. When very much developed they give a receding appearance to the forehead. They are larger in Europeans than in Negroes, and are very imperfectly developed in the Australians, whose peculiar want of vocal resonance is apparently due to this deficiency. They communicate on each side of the upper part of the nostril by a funnel-shaped opening, which transmits a prolongation of mucous membrane to line their interior. These sinuses are much more highly developed in certain mammals and birds than in man. Sir Richard Owen observes that 'they extend backwards over the top of the skull in the ruminant and some other quadrupeds, and penetrate the cores of the horns in oxen, sheep, and a few antelopes. The most remarkable development of air-sinuses in the mammalian class is presented by the elephant; the intellectual physiognomy of this huge quadruped being caused, as in the owl, not by the actual rapacity of the brain-case, but by the enormous extent of the pneumatic cellular structure between the outer and inner plates of the skull.' The sphenoidal sinuses are two large irregular cavities, formed, after the period of childhood, in the body of the sphenoid bone. They communicate with the upper part of the nose, from which they receive a layer of mucous membrane. Like the frontal sinuses, they serve to lessen the weight of the skull, and to add to the resonance of the voice. The ethmoid sinuses lie in the lateral masses of the ethmoid bone. They communicate with the cavities of the nose. Their main use is to diminish the weight of the forepart of the skull. That part of the temporal bone which forms the projection behind the ear is termed the *mastoid process*. The interior of this process is hollowed out with air-sinuses which communicate with the tympanum or middle ear, and through it with the nose. The superior maxillary sinus commonly known as the

Antrum of Highmore (anatomist, 1613-84, who first accurately described it) is the largest of the sinuses, and the only one present in the infantile skull. Its uses are the same as those of the others, and, like them, it communicates with the nasal cavities.

The term sinus is also applied to certain channels for the transmission of venous blood. These are merely dilated veins formed by the separation of the layers of the dura-mater and lodged in grooves on the inner surfaces of the cranial bones. In Surgery the term *sinus* is nearly equivalent to *Fistula* (q.v.).

Sion, or SITTEN, capital of the Swiss canton of Valais, stands in a picturesque situation in the valley of the Rhone, 16 miles N.E. of Martigny by the Simplon Railway. It has a mediæval appearance, owing to three ruined castles perched on the crags above the town, and its cathedral, which has been the church of a bishop since the 6th century. Pop. 5447.

Sion College, on the Victoria Embankment, London, was founded in 1623 as a college and almshouse on the site of a priory in London Wall, by the benefaction of Dr White. A library was added soon after, and the college was incorporated by charters of 1630 and 1664. The college consists of the incumbents of the City of London and its suburbs, who appoint a governing body. Changes were made in the constitution in 1884, the almshouse for ten old men and ten old women being abolished, and a sum being devoted to the maintenance of pensioners (now forty in number); and the new building having been erected on the embankment at a cost of £26,000, the college and library (now a large and valuable one, easily accessible to the public) were transferred hither in 1886.—For Sion House, see ISLEWORTH.

Siout, or ASIOT, the chief city of Upper Egypt, stands near the western bank of the Nile, about 200 miles by rail south of Cairo. It has some fine mosques, an imposing government palace, an American mission school, and well-built dwelling-houses. The people, about 32,000 in number, make black and red earthenware, and fans of ostrich-feathers, and carve ivory. There is some trade (annual value £380,000) with Darfur and Senaar. Siout is built on the site of the ancient Lycopolis; but few remains of the Græco-Egyptian city are extant. From the neighbouring heights of the Libyan mountains, which contain numerous rock-sepulchres, the view over the valley of the Nile is perhaps the finest in Egypt. See F. L. Griffith's *Inscriptions of Siout* (1889).

Sioux (pron. *Soo*), the principal tribe of the Dakota (i.e. 'confederate') family of American Indians (q.v.), now settled mostly in South Dakota and Nebraska. Forced by the Chippewas south and west, they made their first cession of lands to the United States government in 1830, and in 1837 ceded all their lands east of the Mississippi, and in 1849-51 those in Minnesota. For all these lands annuities were promised, which were, however, allowed to fall into arrears; and meanwhile the Indians were demoralised by the introduction of whisky. In 1862 a number of famishing men broke into a government warehouse, and so began a desperate war which desolated thousands of square miles of territory, cost a thousand whites their lives and the government \$40,000,000, and ended in the execution of the leaders. After some years of further disgraceful mismanagement and wrangling between the various government departments, the Santee Sioux were placed on a small reservation near Yankton, where they have developed into industrious and peaceful farmers, and are permitted to hold their lands in severalty (see AMERICAN INDIANS, Vol. I. p. 227). Meanwhile the hostile

Sioux had retired to the northern parts of Dakota, where, under Sitting Bull, they gathered the young braves who were exasperated by the government's failure to send supplies to the several agencies. The war which began and ended in 1876 is chiefly memorable for the disaster in which General Custer (q.v.) perished; it was ended in a few months, and Sitting Bull took refuge in Canada, but in 1880 was induced by the Dominion officials, on a promise of pardon, to surrender. The Brulé Sioux and the Ogallala Sioux were afterwards settled on the Rosebud and Pinewood agencies in South Dakota. In 1890 there was a general rising of the Indians in the North-west, under a 'Messiah'; and in its course Sitting Bull was slain—whether killed in fight or slaughtered was questioned—on 15th December.

Sioux City, capital of Woodbury county, Iowa, on the east bank of the Missouri River (here crossed by a bridge 2000 feet long), 128 miles (by rail) above Omaha and 512 W. by N. of Chicago. It has good public buildings and schools, great stock-yards and packing-houses, railway-shops, planing and spice mills, and manufactures linseed-oil, vinegar, flour, doors and sashes, &c. Pop. (1880) 7366; (1890) 37,806; (1900) 33,111.

Sioux Falls, capital of Minnehaha county, South Dakota, and the largest town in the state, is on the Big Sioux River (which here falls 90 feet), 241 miles by rail SW. of St Paul. A place of 697 inhabitants in 1878, it now has tramways, water-works, gas, the electric light, a public library, a score of churches, and as many manufactories. A leading industry is the quarrying, shaping, and polishing of the granite which underlies the city. Here are the state penitentiary and school for deaf mutes, and four denominational colleges. Pop. (1890) 10,177.

Siphon, a bent tube for drawing off liquid from one vessel to another. When in action the tube must be itself full of the liquid, so that the quantities of liquid in the two vessels form one continuous liquid mass. In accordance with the principles of Hydrodynamics (q.v.), there will be, in these circumstances, a flow of liquid along the tube until either the free surfaces of liquid in the two vessels are brought to the same level, or the one vessel or the siphon becomes emptied of liquid. If it is desired merely to empty one vessel, a second vessel is not necessary. The principle on which the siphon acts will be readily seen by con-

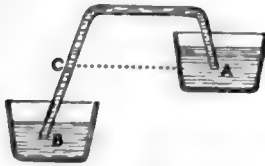

sideration of the figure. The two free surfaces are at the atmospheric pressure, but are at different levels. Take C at the same level as A. Then the pressure at A is obviously greater than the atmospheric pressure, while the pressure at C is less than the atmospheric pressure by the amount of pressure due to the column of liquid between C and the free surface in the lower vessel. Hence there must be a flow of liquid from A to C along the tube—i.e. from vessel to vessel. In the upper part of the siphon the liquid is sustained by the pressure of the atmosphere on the free surface, just as in the Barometer (q.v.). If then the siphon reaches higher above the free surface than the height of the barometer column of liquid used, the continuity of liquid will be broken at the bend, and the siphon will cease to act. Thus a siphon for water cannot be higher than 33 feet above the water surfaces; and a siphon for mercury is similarly limited to 30 inches. To bring it into working condition, a siphon is usually

filled by suction applied (either by the mouth or by a pump) at the one end, the other end being immersed in the liquid; or it is first filled with the liquid and then placed in its proper position.

Siphonophora. See HYDROZOA.

Sippara. See BABYLONIA.

Sipunculus, a genus of worms belonging to the class Gephyrea. The body is cylindrical, unsegmented, without appendages or bristles, with tentacles around the mouth. The food-canal is spirally coiled, and ends anteriorly. The sexes are separate. A common species is *Sipunculus nudus*, which lives in the sand on the shores of the North Sea, the Atlantic, and the Mediterranean. It measures from 6 to 10 inches in length. The animal swallows the sand for the sake of the organic matter therein contained. The members of an allied genus, Phascolosoma, often live within Gasteropod shells, narrowing and extending the mouth of the shell into a tube of cemented sand particles.

Sir (Fr. *sieur* and *sire*, contracted from *seigneur*; from Lat. *senior*, 'elder'), a term originally corresponding to *dominus* in Latin. It was at one time the practice to use the same title in addressing the clergy, a familiar instance being Sir Hugh Evans in the *Merry Wives of Windsor*. To so great an extent did this usage obtain that a 'Sir John' came to be a common sobriquet for a priest. 'Sir' was here a translation of *dominus*, the term used for a bachelor of arts, originally in contradistinction from the *magister*, or master of arts, but eventually extended to the clergy without distinction. Used along with the Christian name and surname, 'sir' is now applied exclusively to knights and baronets. Standing alone it is a common complimentary mode of address used without regard to rank. *Sire* is an older form of *sir*, formerly used in addressing royalty.

Sirach. See ECCLESIASTICUS.

Sirajganj, a town in Pabna district, Bengal, near the main branch of the Brahmaputra, 150 miles NE. of Calcutta. Pop. 23,037.

Sir-daria. See JAXARTES.

Siren, a genus of tailed Amphibians, represented by one species—*Siren lacertina*—living in swamps in the southern states of North America. The animal is eel-like, of a dark lead colour, one to two feet long, without hind-limbs, with four-toed weak fore-limbs, with three pairs of persistent external gills, with no teeth except on a small patch on the roof of the mouth. The food seems to consist of worms and insects.

Siren, an instrument which produces musical sounds by introducing a regularly recurring discontinuity into an otherwise steady blast of air. Seebeck's siren consists of a large circular disc pierced with small holes at equal intervals apart in the same concentric circle. The disc is made to rotate more or less rapidly upon its axis; and while it is so rotating a nozzle, through which a strong blast of air is driven by means of a bellows, is brought so as to bear directly upon any desired circle of holes. When a hole is opposite the nozzle a puff of air escapes; when an unpierced portion of the disc comes before it the air is checked. Thus



Siren lacertina: a, head on larger scale.

the blast of air is broken up into a succession of puffs, whose number per second is exactly equal to the number of holes which pass in front of the nozzle in one second. Knowing the rate of rotation per second of the disc and the number of holes in the circle that is being used, we can readily calculate the frequency of the musical note produced (see SOUND). By shifting the nozzle to bear upon a different circle of holes we get a different note for the same rate of rotation.

In Cagniard de Latour's siren the blast of air whose interruption gives the note also drives the siren. Fig. 1 shows the upper surface of the siren, SS, resting on the cover of the wind-chest, AA. In fig. 2 the instrument is shown in vertical section through the line *nn* of fig. 1. The blast enters by the pipe, BB. The cover of the wind-chest is pierced with exactly the same number

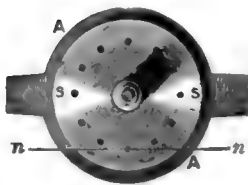

Fig. 1.

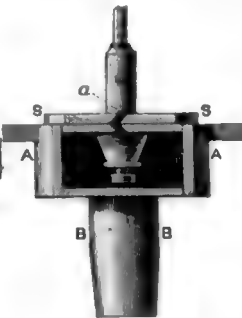

Fig. 2.

of holes as the disc, the only difference being that the holes pierced obliquely in both disc and wind-chest cover are oppositely directed in their obliqueness, as shown at *a* in fig. 2. When the corresponding holes are in apposition the blast of air is driven through all the holes, and by its impact on the obliquely cut walls of the holes in the disc forces the disc round. This brings the unpierced part of the disc opposite to the holes in the cover, and the air is cut off until the holes again come into apposition. The stronger the blast the more quickly will the disc be driven and the higher the note produced. A much more powerful tone can be obtained from this form of siren than from Seebeck's, inasmuch as all the holes are used simultaneously. Von Helmholtz's Double Siren is a combination of two of these on the same axis, each siren, by a suitable arrangement of concentric rings of holes which can be closed or opened at pleasure, being able to sound four distinct notes, singly or simultaneously. It is an invaluable instrument for demonstrating the laws of beats and combination tones (see SOUND). Other forms of siren used in fog-signalling are described under LIGHTHOUSE.

Sirenia, an order of aquatic mammals now represented by the dugong (*Halicore*) and the manatee (*Manatus*). Another form, Steller's sea-cow (*Rhytina stelleri*), was exterminated during the 18th century. In the Miocene and early Pliocene seas there seem to have been abundant Sirenians, many of which belonged to the genus *Halitherium*. As the characteristics of the dugong, the manatee, and Steller's sea-cow are described in separate articles, it is enough to state here that the Sirenians form a very distinct order, that in spite of their superficial resemblance they have certainly no near affinities with Cetaceans, that at present we must be content to regard them as old-fashioned and, it is to be feared, moribund types, occupying a lowly position in the Mammalian series.

The name, which suggests mermaids, seems to refer to the appearance of the dugong, when it raises its head above the water or carries its young one under its arm.

Sirens, sea-nymphs in Greek Mythology who sat on the shores of an island between Circe's isle and Scylla, near the south-western coast of Italy, and sang with bewitching sweetness songs that allured the passing sailor to draw near, but only to meet with death. In Homer there are two, in later writers three, Ligeia, Leukosia, and Parthenope, or Aglaopheme, Molpe, and Thelxiepeia. If any seaman could resist the enticements of their magic music they themselves were doomed to die, but Ulysses or the Argonauts alone succeeded in doing so. In the *Odyssey* we read how Ulysses, by the advice of Circe, stopped the ears of his companions with wax, and lashed himself to a mast, until he had sailed out of hearing of the fatal songs. The Argonauts got safely past because Orpheus protected them by the stronger spell of his own singing, whereupon the sirens threw themselves into the sea and were transformed into rocks. The Latin poets give them wings, and in works of art they are often represented as birds with the faces of maidens, and are provided with musical instruments. According to J. P. Postgate (*Cambridge Journal of Philology*, vol. ix.), the original meaning of the word is 'bird.' In later days they are represented on tombs as singers of dirges for the dead, and more generally as symbolising the magic power of eloquence and song. Parallel conceptions are the Mermaid (q.v.) of western Europe and the Lorelei (q.v.) of the Rhine. See Miss Harrison's *Myths of the Odyssey in Art and Literature* (1881).

Sirhind, a tract in the Punjab, being the north-eastern part of the plain between the Jumna and the Sutlej, which is watered by the great Sirhind Canal (main branch finished in 1882) and its branches. Sirhind, which is not an administrative division, contains five British districts (one being Umballa) and nine native states (including Patiala). It is named from an ancient town in Patiala, now in ruins.

Sir-i-kol, a great lake of the Pamir (q.v.).

Sir-i-pul, a river, city (75 miles NE. of Maimana; pop. 15,000), and district in Afghan Turkestan.

Sirius, otherwise called *Canicula*, or the *Dog-star*, the brightest star in the heavens, is situated in the constellation of *Canis Major*, or the 'Great Dog.' Its distance in light-units is 8.6 (see STARS). It has long been known to possess a 'proper motion'—i.e. an independent progressive motion—which was for a time believed to be in a straight line, but was in 1844 shown by Bessel to consist of an undulatory progressive motion on each side of a middle line. This motion was investigated by Professor Peters of the Pulkowa Observatory, Russia, on the supposition that its anomalous character was produced by the attraction of some unseen neighbour, and his calculations were completed and verified by Mr Safford of Washington. In January 1862 Mr Alvan Clark of New York, chancing to observe Sirius through a powerful telescope, detected a minute star (which had never before been observed) situated at an angular distance of 7" from Sirius, and it is generally believed that this is the disturber in question. By photometric measurement it has been shown that, adopting the latest measures of its distance, Sirius gives seventy times as much light as our sun would at the same distance, and has a mass three times that of the sun. The Egyptians called this star Sothis, and at one time its 'Helical Rising' (q.v.) was regarded as a sure forerunner of the rising of the Nile; while among the Romans it was considered a star of evil omen.

whose appearance above the horizon coincided with (or even caused) the unhealthy and oppressive heats of summer. Hence the origin of the various superstitions regarding the Dog-days (q.v.), many of which are still current. The term 'dog-star' was also applied to Procyon, a bright star in *Canis Minor*, whose heliacal rising differs only by a few days from that of Sirius.

Sirocco, a name given in Italy to a dust-laden dry wind coming over sea from Africa; but also applied to any south wind, often moist and warm, as opposed to the Tramontana or north wind, from the hills.

Sisal Hemp. See FIBROUS SUBSTANCES.

Siskin (*Chrysomitris*), a genus of perching birds belonging to the family Fringillidæ, the true finches. The best-known species is the Common Siskin (*C. spinus*), which occurs from Britain eastward to Japan. This species breeds in the centre and north-east of Scotland, and is a familiar winter visitor to England and Wales. It is also common in some parts of Ireland. The siskin usually builds its nest, which is made of twigs



Siskin (*Chrysomitris spinus*).

and roots lined with moss, high in the branches of fir and birch trees. Two broods are reared in a season. The prevailing colour is yellowish green, with yellow and black markings on the upper and white on the under surface. The female is altogether dingier in hue than the male. The siskin is a common cage-bird, and will even breed in confinement, but the young are not easily reared.

Sismondi, JEAN CHARLES LÉONARD SIMONDE DE, a historian of Italian descent, was born at Geneva on 9th May 1773. The outbreak of the French Revolution ruined his father and drove the family into exile, first to England, then to a small farm near Lucca; but in 1800 Sismondi himself went back to Geneva, and, having obtained certain municipal offices, applied himself to his favourite literary pursuits. He was introduced to Madame de Staël, and became one of the intimates of her circle, like Benjamin Constant and Schlegel. Whilst in the company of this lady he formed the beginning of a fast friendship with the celebrated Countess of Albany, widow of the Pretender and mistress of Alfieri. His *Histoire des Républiques Italiennes du Moyen-Âge* (16 vols. 1807-18) placed him in the first rank among contemporary historians. The events of the Hundred Days brought about one of the most memorable passages in his life—an interview with Napoleon. In 1813 appeared his *Littérature du Midi de l'Europe* (Eng. by Roscoe); and in 1819 he began his second great work, *Histoire des Français*, with which he was occupied until his death. As a historian Sismondi was distinguished more for industry than for natural gifts or graces of style. He took a lifelong interest in political economy: his first book on this subject, *De la Richesse Commerciale* (1803), is written from the standpoint of the *Wealth of Nations*; but in a later

book, *Nouveaux Principes d'Économie Politique* (1819), he modified his views so far as to adopt a more decidedly moral or socialistic attitude. Amongst other products of his unwearied industry and perseverance may be named *Histoire de la Renaissance de la Liberté en Italie* (2 vols. 1832), *Histoire de la Chute de l'Empire Romain* (2 vols. 1835), and an abridgment (1839) of the twenty-nine volumes of his *Histoire des Français*. Sismondi died at Chêne near Geneva on 25th June 1842.

See *Quarterly Review*, September 1843; *Vie et Travaux de Sismondi* (Paris, 1845); Sainte-Beuve's *Nouveaux Lundis* (vol. vi.); and collections of his own *Letters Inédites* (1863 and 1878).

Sissoo Wood. See ROSEWOOD.

Sisterhoods. All societies or communities of women living together under a religious rule, binding upon all, and with a common object for their united life, may be called Sisterhoods in the largest sense of the term. But in common use the word denotes those communities which are not enclosed, and whose life is one of active labour. An account of the great religious communities of women in the early and middle ages of Christianity falls under the head of Monachism. Indeed the state of Christendom for many centuries prevented the possibility of life and work for women such as that of Sisters of Charity. Women were affiliated to the great monastic orders, the Benedictine, Augustinian, Carmelite, &c., but, with one partial exception, that of the Hospitallers, 'Religieuses Hospitalières,' were invariably cloistered. There were several communities of hospital nuns, the great hospitals of the Hôtel Dieu at Paris, San Spirito at Rome, Dijon Hospital, and several others in France being served by them. But they lived in convents adjoining the hospitals, and only left their cloisters to nurse the sick. Even when the Franciscan and Dominican orders of preaching friars arose, the nuns belonging to them, the Poor Clares and Dominican nuns, were strictly enclosed. Their members might and did exercise the most powerful influence on society and education—nay, as in the case of a St Teresa or St Catharine of Sienna, on theology and politics—but this was through the force of moral and religious excellence, and sometimes of genius.

It was the glory of St Vincent de Paul to found, in 1633, assisted by Madame Le Gras, the first superior, the Society of 'Filles de la Charité,' and to lay the foundation of all modern religious communities who lead an active life devoted to various works of charity. The great need of such a society had become so obvious that the holy see, which had hitherto discouraged every attempt of a kindred character, solemnly approved of 'The Daughters of Charity' in 1655. In their constitution it was enacted that the community was 'to consist of girls, and widows unencumbered with children, destined to seek out the poor in the alleys and streets of cities.' In their founder's words, they were 'to have for monastery the houses of the sick; for cell, a hired room; for their chapel, the parish church; for their cloister, the streets of the town or wards of the hospital; for enclosure, obedience; for grating, the fear of God; for veil, holy modesty.'

The order spread with wonderful rapidity, and now numbers between 30,000 and 40,000 sisters, with two thousand houses over the world, devoted to every conceivable work of charity. Outside of France they have houses in Algeria, Belgium, Austria, the British Isles, Italy, Russia, Poland, Portugal, Spain, Switzerland, the Levant, Palestine, China, the United States, Guatemala, Panamá, Ecuador, Peru, Brazil, La Plata, Chili. In 1891 they undertook the care of a hospital at Jerusalem, at the request of the pasha, by whom at its opening they were received with great ceremony.

All are in connection with the mother-house, Rue de Bac, Paris, and are under the superioress, who is elected every three years, and who resides there. After five years' probation the sisters take vows, renewable every year. Their habit is gray-blue cloth, with large white collar, and white *cornette* for the head.

After St Vincent de Paul's sisters, the 'Petites Sœurs des Pauvres' rank next in numbers and in variety of active labours. They were founded in 1840 at St Servan, in Brittany, by the Abbé le Pailleur, then but twenty-five, and a young girl, Marie Jamet, a poor needle-woman. She was soon joined by another poor girl, Virginie Tredaniel, scarcely sixteen, and shortly after by an old servant, Jeanne Jugan, whose name is now known throughout the length and breadth of France, and who at forty-eight had saved 600 francs (£24). The institute was formed for the special object of the care of the aged, destitute, and sick poor. The work was begun by receiving a blind old woman of eighty in an attic, belonging to a poor woman, Fanchon Aubert, who at sixty years of age gave all she had to the work and lived with the sisters, though not formally joining the institute—then supported, as it still is in great measure, by scraps of food and other alms which the sisters begged day by day from house to house. At the present day, in all their houses, coffee-grounds form in the hands of the Little Sisters the basis of a beverage which is esteemed a delicacy by their old people.

Jeanne Jugan received from the French Academy the 'prize for virtue,' i.e. a grant of 3000 francs (£120) awarded every year to the person who is judged to have surpassed all others in works of charity. The recipient is said to be 'crowned by the French Academy.' This sum was applied to building their first house at St Servan, the Abbé le Pailleur selling his gold watch and other effects to help them; and the work begun thus humbly half a century before had by 1892, when the venerable founder and Marie Jamet (then mother-general) were still living, become one of the most imposing and important charitable institutes of our time, possessing 270 houses, with 4400 sisters. The mother-house, established at La Tour in 1856, contains 600 novices from all parts of the world; and from this single centre are directed the work of their thousands of sisters and the affairs of their houses all over France, besides those in Germany, Italy, Spain, Portugal, Belgium, the British Isles, Sicily, America, Africa, India, Ceylon, and Australia. The institute was definitively approved by Leo XIII. in 1886—the object, 'the care of aged people of both sexes, irrespective of creed.'

The 'Sœurs de Bon Secours' (of Troyes) were also founded in 1840, by Abbé Miller, canon of the cathedral at Troyes, for the purpose of nursing the sick in their own homes. There are now 115 houses of this 'congregation' in Europe, seven in Africa, and one in New York. In time of war the sisters nurse the soldiers on the battlefield and in the ambulances. There is another order of 'Bon Secours' Sisters (of Notre Dame), founded in 1824 by Archbishop Quélen.

A heroic sisterhood was formed in 1868 by Cardinal Lavigerie, called 'of the African Mission,' for the care of 300 Arab orphans after the great Algerian famine. They have been pioneers of civilisation as well as Christianity, ploughing and planting vineyards with their own hands, and in 1892 had eleven different houses scattered throughout northern Africa—among the Kabyle Mountains, on the edge of the desert, and along the coast of Algeria. One of their chief works is the reception and education of negro children rescued from slave-dealers. In July 1891 three of these sisters were brought, at the request of the king of

Dahomey, to visit him; they were received with great pomp, and sent away with large presents, amongst which were three girls between ten and fifteen. Many other smaller societies of sisterhoods devoted to the care of the poor exist abroad; but, after France, Ireland has by far taken the lead, both in the rapid growth of such societies and in the number of women she has given to the work. Indeed, considering the smallness of her population, 4,700,000, she has probably far surpassed every nation in Europe in this charitable work.

During the prevalence of the penal laws in Ireland it was impossible for a woman in the dress of a sister to be seen in the streets. But on their repeal in 1782 and 1793 the fire of charitable enthusiasm in Irishwomen broke out and spread the more rapidly for its long repression. The 'Irish Sisters of Charity' were founded in Dublin in 1815 by Mary Aikenhead, daughter of a gentleman of good Scottish family who had settled in Cork. The society is on the same lines as that of St Vincent de Paul, but entirely distinct from it. They have now nearly 500 sisters, with twenty-three houses in Ireland, and one in England, besides four houses in Australia not depending on the mother-house. They are occupied in almost every kind of charitable work— orphanages, hospitals, penitentiaries, schools, convalescent homes, blind asylums, and certified industrial schools for girls under government, of which 4121 girls were inmates in 1890. A hospice for the dying at Harold's Cross near Dublin, with 200 beds, open to all denominations and perfectly free, must be visited in order to gain any notion of the beauty and comfort with which the dying are surrounded, and the perfection of every arrangement.

The other great sisterhood in Ireland is that of the Sisters of Mercy, founded in 1831 in Dublin by Catharine M'Auley. The object of this institute is 'all works of mercy, corporal and spiritual, especially education.' There are now at least 500 houses of these sisters in existence in all parts of the world. In their jubilee year, 1881, 168 houses had been founded in Ireland alone. This is quite the most remarkable development of an order of sisters in the world, considering that the whole population of Ireland is less than that of London.

Of sisterhoods belonging to the Anglican communion the first foundation was made in 1845 by Dr Pusey and Lord John Manners (afterwards Duke of Rutland), who, assisted by a few friends, opened a small house in Albany Street, Regent's Park, to receive a few women desiring to devote themselves to charitable works. Since then the spread of English sisterhoods has been scarcely less rapid than that of their Roman sisters in Ireland. The most powerful impulse to the movement was given by an Irish lady, the Hon. Harriet O'Brien, sister of Lord Inchiquin, who, having married the Rev. C. Monsell, and being early left a widow, undertook the charge of an infant community which had opened a House of Mercy for the reception of penitent women at Clewer, near Windsor, under the care of the rector of Clewer, the Rev. T. T. Carter, the venerable warden that was to be of the immense community numbering hundreds of sisters which has grown up under his fostering care. The sisters are engaged in all kinds of charitable works—missions in the worst parts of London, schools both for the poor and those of a higher class, and have built splendid convalescent hospitals, receiving both men and women, at Clewer, at Folkestone, and at Torquay. They have now five houses for different objects at Clewer, fourteen in London, and fourteen in other parts of England. They have also a branch in America, of which the mother-house is at New York; and

in Calcutta they have charge of the Lady Canning Home, the nursing of the European General Hospital and of the Medical College and Eden Hospitals; also of the Pratt Memorial School, the European Orphan Asylum, and the hospital at Darjeeling, &c.

St Peter's Home, Mortimer Road, N.W., rivals the hospice for the dying near Dublin in the beauty and comfort of all arrangements that may cheer and comfort the dying. It is in England a unique home in this respect, and receives, besides the dying, patients needing long and tender care, incurables, infirm old women, ladies, especially for operations, &c. The sisterhood of St Peter's was founded in 1861, by the late Benjamin Lancaster, Esq., and his wife. The sisters have several other houses, including a convalescent hospital on the high heath and pinewood grounds above Woking Station. They also have mission houses under the parochial clergy in three parishes in the east of London and at Sydenham.

The first sisterhood in England, that founded by Dr Pusey, was broken up in 1855, after the war in the Crimea, where some of the sisters had worked under Florence Nightingale. A few of the original members of this first English sisterhood joined a small community which had been founded by Miss Lydia Sellon in 1849, called the Society of the Holy Trinity. The sisters have a house at Plymouth for lower and middle class schools, and a penitentiary; also a fine convalescent hospital and orphanage near Ascot, and a school at Honolulu, Hawaiian Islands. They also work amongst the poor in Spitalfields.

One of the largest and most important sisterhoods in England was founded in 1851 under the title of 'Sisters of the Poor,' by the late Miss Harriet Byron. Their headquarters is All Saints' Home, in Margaret Street, but they have now eleven houses in London, besides the entire nursing of University College Hospital; thirteen all over England, including a splendid convalescent home at Eastbourne; one at Edinburgh; six in America; five at Capetown, besides the charge of New Somerset Hospital; and at Bombay the nursing of three hospitals and the care of two government schools.

St Margaret's Sisterhood was founded at East Grinstead in 1854 by the Rev. Dr J. M. Neale (q.v.) for the purpose of nursing the sick poor or rich in their own homes. They have fulfilled this object in all parts of England, and in the poorest cottages, and have also undertaken almost every other charitable work. They have, including daughter-houses depending on their own resources, thirty-two houses in England and Scotland; one at Boston, U.S., with sixteen branch houses; and an orphanage and mission-work at Colombo. They also work under the clergy in five London parishes.

The Holy Cross sisterhood, whose headquarters are at Holy Cross Home, Hayward's Heath, was formed in 1857 to aid in the St George's Mission-work, under the Rev. Charles Lowder, a task in which they persevered during twenty years of hand-to-hand fight with the heathenism of Ratcliffe Highway. They have still a branch house at St Peter's, London Docks, and others at Charlton, Dover, Winchester, and York, besides an orphanage and large training-school at Hayward's Heath, Sussex. One of the most flourishing sisterhoods in England—that of St Mary's, Wantage—was founded by the Rev. Dr Butler, afterwards Dean of Lincoln, primarily for penitentiary work. Like other societies, its objects have multiplied, and now embrace hospital-nursing, schools, mission-work, &c. Seventeen houses in London and various parts of England, a mission at Poona, India, with the government high school, the Sassoon Hospital, an orphanage for natives, a government

native school, and a high-caste native school, are under the Wantage Sisters' care. The 'Sisters of Bethany,' founded in 1866, have their headquarters in Clerkenwell, and are chiefly devoted to education and to mission-work in poor parishes. They have six houses in London, two at Brighton, one at Shirebrook, Derbyshire, and an orphanage for a hundred children at Bournemouth. St Raphael's Sisterhood, Bristol, founded in 1867, follows, as far as possible, the rule of St Vincent de Paul, and is devoted entirely to the service of the poor; middle-class education and penitentiary work being excluded. Nine mission-houses, convalescent homes, &c. are under the care of the forty sisters and novices, of which five are in or near Bristol, one at Leeds, and one at Magila, Central Africa, in connection with the Universities Mission.

The 'Sisters of the Church,' Randolph Gardens, Kilburn, founded in 1870 by Miss Emily Ayckbown, developed with extraordinary rapidity, as regards the number of sisters, now nearly 150, the immense number and variety of its work, and the large scale upon which each separate branch is carried on. Their prime object was to rescue girls from workhouse upbringing; and beginning with two little orphans in 1875, they have now 500 girls under their care, admitted without vote or payment, their only passport being entire friendlessness and destitution. In 1884 they opened an orphanage for forty boys at Bronesbury, and in 1886 a convalescent home for 300 children at Broadstairs. Their houses are spread over all parts of London and over England, education and mission-work being amongst their chief objects. They have a large publishing establishment in Paternoster Row; and one of their monthly publications—the *Banner of Faith*, begun in 1882—has a circulation of 320,000. They have immense schools, teaching many thousands of children, and training-homes for teachers. It would be impossible to enumerate all their works in connection with mission-work: restaurants for working-men, a night refuge for men, food-trucks for the unemployed, depôts for the sale of second-hand clothing, and an accident hospital at Rotherhithe. Two houses and schools have been founded by these sisters in Canada, and one at Madras.

Besides these large communities there are many smaller sisterhoods in England: (1) All Hallows, at Ditchingham, the sisters' chief work being amongst fallen women. They have a rescue hospital and another house at Norwich, and an orphanage, county hospital, and training-school at Ditchingham; also a branch in British Columbia. (2) Sisters of the Holy Name, founded 1865, working in the parish of St Peter's, Vauxhall, and with houses at Wednesbury, Malvern Link, Birmingham, and Worcester. (3) St Katharine's, at Fulham, founded 1879, their special object being prison rescue work. (4) St Laurence's Sisterhood, Belper, for the care of the helpless, and to nurse the sick. The sisters have a middle-class school, cottage hospital, and mixed school; also houses at Derby and Scarborough. (5) St Agnes' Sisters, Birmingham. (6) St Mary's Sisters, Brighton, in charge of penitentiary, industrial school, orphans, schools, &c. (7) St Michael's Sisters, Bussage, who have charge of the Diocesan House of Mercy. (8) St Peter's Sisterhood, Horbury, in charge of a penitentiary for seventy-five inmates, and with branch houses near Boston and Manchester. (9) Sisters of the Holy Rood, at North Ormesby, in charge of a cottage hospital for accidents, and two other small hospitals in the mining districts; also of a home for girls. (10) St Thomas' Sisterhood, Oxford, in charge of three schools of different grades, a penitentiary at Basingstoke, and an orphanage at Southsea. (11) St Denys' Sisterhood,

Warminster, formed to train women for foreign missionary work. The sisters have a cottage hospital and ladies' school, and a school at Murree in the Punjab.

The first Protestant sisterhood in America was organised in 1852 by the Rev. W. A. Muhlenberg, rector of the church of the Holy Communion, New York, and author of the hymn 'I would not live away.' The sisters took charge of St Luke's Hospital, which he founded in 1859.

Of most of the Anglican sisterhoods an accurate list will be found yearly in the *Kalendar of the English Church* (Burlington Street, Strand). *St Margaret's Magazine* (Skeffington & Son), published every January and July, gives an account of the increasing works of the East Grinstead Sisterhood; and a monthly record is given by the 'Sisters of the Church' in *Our Work* (3 Paternoster Row). From the *Catholic Directory* information can be obtained as to Roman Catholic sisterhoods; and see Mrs Abel Ram, *The Little Sisters of the Poor* (1894). For Protestant deaconesses, see DEACON.

Sistine Chapel. See ROME, p. 785.

Sis'tova, a town of Bulgaria, on the south bank of the Danube, about 35 miles above Rustchuk. It carries on tanning, cotton-weaving, and wine-growing, and does a large trade in cereals. Here peace between Austria and Turkey was concluded in 1791; the Russians burned the place in 1810, and crossed the Danube into Bulgaria close by in 1877. Pop. (1887) 12,482; (1895) 13,500.

Sistrum. See EGYPT, Vol. IV. p. 237.

Sisyphus, in Greek Mythology, son of Æolus, father of Glaucus, and husband of the Pleiad Merope; only in post-Homeric legends, from his cunning, the father of Odysseus. He is said to have been founder and king of Ephyra, afterwards Corinth, and both he and his whole house were notorious for their wickedness. Homer does not give the reason for his punishment in the lower world, but some later accounts make it his disclosure to the river-god Asopus that it was Zeus who had carried off his daughter; others, his wholesale robbery and murder of travellers. He was condemned to roll an immense stone from the bottom to the summit of a hill, which, whenever it reached the top, rolled down again, and so the task of Sisyphus had to be begun anew.

Sitapur, a municipality with 21,380 inhabitants in Oudh, 52 miles NW. of Lucknow. The place has a cantonment, and is the headquarters of a district, and gives name also to the north-western division of Oudh.

Sitka, the capital of Alaska, is on the west coast of Baranof Island, a deep harbour dotted with islands in front, and snow-clad mountains rising behind. Its principal buildings are the Greek church and the old Russian palace, now a storehouse. The climate, though not severe, is cold; oats cannot ripen here. The rainfall has reached 105.62 inches per year, in an average of seven years; and 100 fair days mean an exceptionally fine year. Pop. (1890) 1188, mainly Indians.

Sitten. See STON.

Sittingbourne, a brick-making market-town of Kent, on Milton Creek, 11 miles ESE. of Chatham and 45 of London. In olden days it was a great halting-place for Canterbury pilgrims and for kings and others on their way to the Continent. Pop. (1851) 2897; (1891) 8302.

Sitting-Bull (1837-90). See STOUX.

Siva (a Sanskrit word, literally meaning 'happy,' 'auspicious') is the name of the third god of the Hindu Trimūrti (q.v.) or triad, in which he represents the characters both of Destroyer and Reproducer. The name Siva, as that of a deity, is unknown in the Vedic hymns, but established as such

in the epic poems, Purānas and Tantras. The *Saivas*, or worshippers of Siva, assign to him the first place in the Trimūrti; and to them he is not only the chief deity, but the deity which comprises in itself all other deities. Thus, in the Siva-Purāna, he is addressed as Brahma, Vishnu, Indra, Varuna, as the sun and the moon, as earth, fire, water, wind, &c.; but even in the Purānas relating to Vishnu his power is exalted in praise, and he is addressed with the utmost awe. The symbol of Siva is the Linga (q.v.), emblematic of creation, which follows destruction. From each of his numerous attributes or characteristics he derives a name or epithet. He has five heads (hence his name *Panchānana*, 'the five-faced'); three eyes (hence his name, *Trinetra*, &c., 'the three-eyed'), one of which is on his forehead, and indicates his power of contemplation; and in the middle of his forehead he wears a crescent. His hair is clotted together, and brought over the head so as to project like a horn from the forehead. On his head he carries the Ganges, whose course he intercepted by his hair, when this river descended from heaven, so as to enable the earth to bear its fall. Round his neck he carries a garland of human skulls. In his hands he holds the trident, a club or pole, armed at the upper end with transverse pieces, representing the breastbone and ribs adjoining, and surmounted by a skull and one or two human heads. Siva is doubtless a combination of an Aryan god and a non-Aryan deity—his wild and terrible attributes being doubtless derived from the pre-Aryan indigenous belief. Among his weapons are a bow, a thunderbolt, and an axe. As the destroyer of the world, he is also called *Kāla* ('Time' or 'Death'), and represented as of black colour. One of his representations is also half-male and half-female, emblematic of the indissoluble unity of the creative principle. He is clothed in a deer-skin; or he also holds a deer in one of his hands; or he sits on a tiger-skin, or is clothed in it. When he rides, the bull Nandi is his beast of burden, whom he also carries as an emblem in his banner. He resides on the wonderful mount Kailāsa, the northern peak of the Himalaya, where he also rules over the north-east quarter. His principal wife is variously called *Devī*, *Durgā*, *Umā*, and *Kālī*, and is the great goddess of modern worship. One of his chief attendants is *Tandu*, who is one of the original teachers of the arts of dancing and mimicry, whence Siva is the patron of dancers. Besides *Tandu*, a host of other attendants and companions, together with demons and other beings, surrounding him, are named by the Purānas. Amongst the principal achievements of this god is his conflict with the god Brahma, who was originally possessed of five heads, but lost one through exciting the anger of Siva by disrespectfully addressing him. Siva is especially worshipped under the symbol of the Linga; but there are periods at which homage is paid to him also under other forms, corresponding with the description given above. Siva and Vishnu are nowadays in their male and female forms practically the gods of the Hindu population. Like Vishnu, Siva has a thousand names by which he is addressed; some derived from his exterior attributes have been mentioned before; among the others the principal are *Isa* or *Iswara* ('lord'); *Maheśa* or *Maheśwara* ('the great lord'); *Sankara* ('the conferrer of happiness'); *Rudra* ('the terrible'), or *Mahārudra* ('the very terrible'); and *Mahādeva* ('the great god'). See INDIA, Vol. VI. p. 106.

Sivaji (1627-80), the founder of the Mahratta power in India. See MAHRATTAS.

Sivas, a city of Asiatic Turkey, is situated on the Kizil Irmak (anc. *Halys*), 170 miles SW. of

Trebizond, and is a dirty, decayed place. Pop. 15,000, of whom about 3000 are Armenians, the rest Turks. It is built on the site of the ancient *Sebasteia*, from which it derives its name.

Siwah. See OASES.

Siwalik Hills. See HIMALAYA, Vol. V. p. 716.

Siwash, or PUTRID SEA. See CRIMEA.

Six Acts, six repressive measures passed in England in 1819 to prevent seditious assemblies and unauthorised military training, punish seditious libels, increase the power of the magistrates, and further restrict the liberty of the press. They were very unpopular, and are known as the 'Gagging Acts.'

Six Articles, STATUTE OF, an enactment of Henry VIII. (1539), commonly called the Bloody Statute, to compel the uniform profession of the following six doctrines: (1) The Real Presence of Christ in the Eucharist, and Transubstantiation; (2) the sufficiency of communion in one kind only; (3) the unlawfulness of the marriage of priests; (4) the obligation of vows of chastity; (5) the propriety of retaining private masses; (6) the expediency and necessity of auricular confession. In spite of the threatened penalties, only twenty-eight persons suffered death under the statute throughout the whole reign. See HENRY VIII.

Six Nations. See IROQUOIS.

Sixtus, the name of five popes, of whom two call for particular notice, Sixtus IV. and Sixtus V. The former (originally named Francesco della Rovere), born July 22, 1414, was the son of a fisherman in Celle, a small village near Savona. He was a pupil and friend of the celebrated Cardinal Bessarion, and, having entered the Franciscan order, gained the highest reputation throughout Italy as a preacher. On the death of Paul II. in 1471, Rovere, who had risen to be general of his order, was elected to the Roman see. His inordinate partiality for his relatives exhausted the papal treasury, and led to many questionable exactions, and to gross abuses in the dispensation of church patronage. But the worst imputation upon his memory is his connivance in the Pazzi conspiracy against the Medici (q.v.) at Florence. In many respects, however, his administration was liberal and public spirited. He did much to foster learning and to encourage art, and contributed notably to the improvement and decoration of the city. He built the Sistine chapel and the Sistine bridge across the Tiber, took a zealous interest in augmenting the Vatican library, and was a munificent patron of the great painters of the day. In 1482 he entered into an alliance with the Venetians against the Duke of Ferrara, which led to a general Italian war, and ended in a dissolution of the Venetian alliance, an event so mortifying to the pope that his death is said to have been caused by chagrin, August 13, 1484. His successor was Innocent VIII.—**SIXTUS V.**, one of the most able and vigorous occupants of the Roman see, originally named Felice Peretti, was born (December 13, 1521) near Montalto, of poor parents. He early entered the Franciscan order, was made professor of Theology at Rimini and Sienna, won a great name as an eloquent preacher, and gradually rose, through the offices of inquisitor-general in Venice and vicar-general of the Franciscan order, to be cardinal (Cardinal Montalto) in 1570. Shortly after the accession of Gregory XIII. (1572) he began to lead a retired and mortified life, and was believed to have fallen almost into the decrepitude of age and infirmity. This circumstance seems to have recommended him to the cardinals assembled to elect a successor to Gregory in 1585. But Sixtus

totally deceived those who had thought to lead him; for his rule was most active and energetic, and was marked by vigorous measures of improvement in every department of administration, ecclesiastical as well as civil. His first care was to repress the prevailing license and disorder of the city of Rome, and of the papal states generally, by breaking up the bands of outlaws by which both were infested. He reformed the administration of the law and the disposal of public patronage; and he entered upon numerous projects for the moral and material improvement of Rome. Amongst others he erected the library buildings of the Vatican. He found an empty pontifical treasury; yet by judicious retrenchment, and heavy taxation, he secured within the first years of his short pontificate a surplus of above 5 millions of crowns. To the Jews (q.v., Vol. VI. p. 328) he extended full liberty to trade and celebrate their own worship throughout his dominions. The great aim of his foreign policy was to advance the cause of the Roman Catholic Church in every quarter of Christendom, against the Huguenots in France, against the Lutherans in Germany, and against Queen Elizabeth in England. At the same time he entertained a deep jealousy and apprehension of the designs of Spain. Amongst other reforms in church matters he fixed the number of the College of Cardinals at seventy, and reorganised the separate congregations of cardinals. Under his authority were published a new edition of the Septuagint and an edition of the Vulgate, the latter famous from the multiplicity of its errors, subsequently corrected in the edition of Clement VIII. Sixtus died on 27th August 1590, and was followed in the papal chair by Urban VII.

Many of the popular stories regarding him are derived from Gregorio Leti's *Vita di Sisto V.* (2 vols. Lausanne, 1669), a work of no authority. The best account is that of Ranke; and see also Tempesti, *Storia della Vita e Gestì di Sisto V.* (2 vols. Rome, 1754); Lorentz, *Sixtus V. und seine Zeit* (Mainz, 1852); and Baron Hübner, *Siate V.* (Paris, 1870; Eng. trans. 1872).

Sizar, the name of an order of students at Cambridge and Dublin universities, so called from the allowance of victuals (*sizze*) made to them from the college buttery. Duties of a somewhat menial kind, such as waiting upon the fellows at table, were originally required of the sizars, but these have long since gone into disuse. At Oxford there was formerly a somewhat similar order of students denominated Servitors.

Size. See GLUE, and GELATINE.

Skagen, CAPE, or THE SKAW, the most northerly point of Jutland, Denmark, on which is built a lighthouse of stone, 148 feet high. Near it is a small town of 1954 fishers and pilots.

Skager-Rack, an arm of the North Sea lying between Denmark and Norway, and communicating with the Cattegat, is about 140 miles long from WSW. to ENE., and 70 miles broad. The depth is much greater on the Norwegian than on the Danish coast, being on the former about 200 fathoms, while on the latter it varies from 30 to 40 fathoms. When free from violent storms—to which, however, it is very subject—the current runs east on the side next Denmark, and west on that next Norway, the harbours being all on the latter coast.

Skald signifies in old Norse a poet. The name was given specially to that class of poets who exercised their art as a vocation requiring a learned education—i.e. a knowledge of the construction of verse, and of the enigmatical imagery, roughly shaped out of obscure tradition, to which Scandinavian poets were prone. The principal aim of the Skaldic poetry was to celebrate the

deeds of living warriors or of their ancestors. Very few complete Skaldic poems are extant; but there are a great number of fragments preserved, partly in the younger Edda (q.v.), partly in the Sagas (q.v.) and the Heimskringla. See SNORRI STUR-LASON.

Skaptá. See ICELAND, Vol. VI., p. 60.

Skat, a game played with thirty-two cards as in Piquet (q.v.), and said to have been invented in 1817 in Altenburg, whence it rapidly spread into other parts of Germany and beyond the borders of the fatherland. Each of three players receives ten cards, the two others being laid aside (hence the name—from old French *escart*, 'laying aside'). The values of the cards and the rules of the game are expounded in numerous works—one in English by L. V. Diehl (Lond. 1891).

Skate, the popular name of several species of Ray (q.v.). The Common Skate (*Raja batis*),



Common Skate (*Raja batis*).

known in Scotland as the *Gray Skate* and in the south of England as the *Tinker*, is plentiful on most parts of the British coasts. The Burton Skate (*R. marginata*) is another of the British species. On American coasts numerous species occur—e.g. on the east, the 'Tobacco-box' Skate (*R. erinacea*), the Briar-skate (*R. eglanteria*), the Smooth or Barn-door Skate (*R. levis*); on the west, *R. inornata*, and the large *R. binoculata*, which attains a length of 6 feet. But a revision of the species of skate is necessary. Skates are voracious fishes, feeding along the bottom. Their egg-cases or mermaids purses are often thrown up on the beach. They are often caught on the lines, but great numbers are now brought to market by the trawlers. The greatly expanded pectoral fins are eaten, but the flesh tends to be coarse.

Skating. Progression on ice is accomplished by means of instruments composed of steel blades which are fastened to the soles of the boot, and which are called skates. In early times the shin bones of animals were bound to the feet, and skaters glided over the frozen surface on these by propelling themselves with the aid of a spiked stick. At a later period the iron or steel blades were introduced, the cutting edge of which enabled the wearer to dispense with the stick, and to push off with one foot and glide on the other with alternate strokes. Stow tells how the London 'prentices used to 'tie bones to their feet and under their heels,' and by that means slide on the ice; and Evelyn, under date 1st December 1662, describes how 'divers gentlemen performed before their Maj^{ties} on the new canal in St James's Park, with *Scheets* after the manner of the Hollanders.' Skates are now of two kinds—viz. those made for speed-skating and those for figure-skating. Both were formerly constructed by inserting the steel blade into a wooden bed, which was approximately shaped to the foot and bound to it by means of leather straps. Modern skates are made entirely of metal, and are fixed either by screws passing through plates (to which the blade is attached) into the sole of the boot, which form of skate is known as the Mount Charles; or they

are fixed to the boot by various mechanical devices which enable the skate to be quickly and firmly attached to the boot, and as quickly removed. Of these the skate known as the Barney and Berry is the most reliable. Many speed-skaters continue to use the wooden bed-skate. The blades of skates for speed-skating are made very thin, about $\frac{1}{16}$ th of an inch, somewhat longer than the foot, and very slightly convex along the whole length of that part of the blade which comes in contact with the ice. Speed-skating as a pastime has lately come greatly into vogue owing to the encouragement given to it by the National Skating Association, which, founded at Cambridge in 1879, and transferred to London in 1894, acts as the presiding body in all matters appertaining to skating; and the celebrated skaters of the Fen counties of England. Races on skates are brought off on tracks having one or more turns, and the fastest time for a mile with a standing start is, for professionals, 2 m. 52 s., by George See, and 2 m. 52½ s. by James Smart (both Englishmen), run on 17th February 1887, in Holland; and for amateurs, 2 m. 55½ s. by T. Thomas (a Swede), on 2d March 1890, at Stockholm. One mile on a straight course, with a very strong wind in favour, was skated at Newbury, U.S., on 1st February 1889, by T. Donoghue, in 2 m. 12½ s. J. Nilsson, at Montreal in 1897, skated 1 mile in 2 m. 41½ s., and 5 miles in 14 m. 47 s. J. J. Eden, at Hamar, Norway, in 1894, skated 5000 metres (= 3½ miles) in 8 m. 37½ s., and in 1895, 10,000 metres (= 6½ miles) in 17 m. 56 s. On 29th December 1891 Harold Hagen, a Norwegian, competing against William Smart, the English champion, skated 5 miles in 15 m. 11 s. on Lake Mjorsen, Norway; and again, competing against Smart on 3d January 1892, did 3 miles in 8 m. 46½ s. and two miles, on 28th February, in 5 m. 43½ s. The ordinary travelling pace of Fen skaters is from 10 to 12 miles an hour.

Skates for figure-skating are broader and deeper in the blades, rounded at both toe and heel, and with a curvature along the whole length equal to that of a circle having a 7-foot radius. The Edinburgh Skating Club (1642) is the oldest club for encouraging figure-skating in Britain, but the figures skated were of an elementary character until after the formation of the Skating Club, London (1830). The members of this club instituted a series of combined movements known as 'The Skating Club Figures,' which have induced a mode of skating peculiar to Great Britain, consisting as it does of large and bold curves and turns, executed with great power and quietness, while the body of the skater is held upright, and the knee of the travelling leg kept quite straight. Figure-skating is now much practised in America, Canada, Holland, Germany, Norway, Sweden, and Denmark; but the nature of the skating in vogue is calculated to excite astonishment at the acrobatic dexterity displayed rather than pleasure at the grace and elegance of the gliding movement which should distinguish good figure-skating. The skates used for this style of skating have a radius of about 5 feet, and this curvature is given to the blade to facilitate the rapid turns and short curves which are practised in this mode of skating. At St Moritz, Davos Platz, and Grindelwald there are excellent ice rinks, much frequented during winter by English visitants.



The Mount Charles Skate.

Wheeled skates were in use on roads in Holland as far back as 1770; but it is only since the introduction of the circular running roller-skate, invented in 1865 by Mr Plimpton of New York, speed and figure skating have become common on roller-skates. Besides being a means of exercise taken under a fascinating form, roller-skating is a splendid introduction to ice-skating.

A bibliography of nearly 300 works relating to skating was printed in *Notes and Queries* between 1874 and 1881. The modern books on (1) Speed-skating are the Annual Reports of the National Skating Association; *Pen-skating*, by N. and A. Goodman (Sampson Low & Co.); *Speed-skating*, by N. Goodman ('All England' series); *Speed-skating*, by Heathcote and Tebbutt ('Badminton' series); and (2) on Figure-skating, *The Art of Skating*, by Cyclos (Horace Cox); *A System of Figure-skating*, by Vendervell and Witham (Horace Cox); *Skating Cards*, by W. Crossley (L. Upcott Gill); *Combined Figure-skating*, by Monier-Williams, Pidgeon, and Dryden (Horace Cox); *Skating*, by D. Adams ('All England' series); and *Figure-skating*, by the present writer ('Badminton' series). There is also a good German book, entitled *Spüren auf dem Eise*, by D. Diamantidi and others (A. Hölder, Vienna). For skating with sails, see the Badminton book, p. 213.

Skean-dhu. See DIRK.

Skeat, WALTER WILLIAM, a learned Early English scholar, was born in London, November 21, 1835, and educated at King's College School and Christ's College, Cambridge, graduating as fourteenth wrangler in 1858. He became Fellow of his college in 1860, and four years later Mathematical Lecturer there; filled for some time curacies at East Dereham and Godalming; in 1878 was elected the first Elrington and Bosworth professor of Anglo-Saxon at Cambridge, and re-elected to a Christ's College fellowship in 1883. He was the first director of the Dialect Society (established 1873), and he has contributed, by his exhaustive labours on Langland and Chaucer, and innumerable editions of Early English works, more than any scholar of his time to a sound knowledge of Middle English and English philology generally.

His most important books are the following: *Piers Plowman*, in its three texts (5 parts, 1867-85; re-issued by the Clarendon Press, 2 vols. 1886); *The Lay of Havelok the Dane* (1868); *Barbour's Bruce* (3 parts, 1870-77); *Chaucer's Treatise on the Astrolabe* (1872), &c., all edited for the Early English Text Society; an edition of Chatterton's *Poems* (2 vols. 1875); *Chaucer's Minor Poems* (1888); school editions, for the Clarendon Press series, of several of Chaucer's *Canterbury Tales*, a portion of *Piers Plowman*, and two volumes of *Specimens* of earlier English literature; *The King's Quair* (1884), for the Scottish Text Society; *A Mæso-Gothic Glossary* (1868); his great *Etymological English Dictionary* (1882), and its admirable abridgment, the *Concise Etymological Dictionary* (1882); and *Principles of English Etymology*, 1887-91; his great edition of Chaucer (6 vols., Clar. Press, 1894-95) and his *Student's Chaucer* (1898); and *A Student's Pastime* (1896). See his own bibliography of fifty-two works in *Notes and Queries*, September 1892.

Skegness, a little watering-place of Lincolnshire, 22 miles NE. of Boston. Pop. 1488.

Skeleton, a general term for the more or less hard parts of animals, whether forming an internal supporting framework—an endoskeleton, or an external exoskeleton, often useful as armour. The term includes so many different kinds of structure and material that it is necessary to take a survey of representative types.

Skeleton of Invertebrates.—Many of the Protozoa have shells of lime (see FORAMINIFERA), or of flint (see RADIOLARIA), or of some organic substance, such as acanthin. These are formed by the living matter of the units, in the case of the lime and flint shells from materials absorbed from the surrounding water, but in what precise way we do not

know. Almost all Sponges (q.v.) are supported by loose or firmly fused spicules of lime or of flint, or have, as in the bath-sponge, an interwoven supporting skeleton of 'horny' fibres. The spicules or fibres are formed by cells in the middle stratum of the sponge. Among Coelenterates various forms of skeleton, both external and internal, both limy and 'horny,' are represented by the different kinds of corals (see CORAL). With few exceptions these skeletons are produced by cells belonging to the outer layer or ectoderm of the animal. Worms have little that can be called a skeleton, although some authorities would compare the sheath of the proboscis in Nemertea (q.v.) to the notochord of Vertebrates. The tubes, calcareous or otherwise, in which many sedentary worms are sheltered, have no vital connection with the animals which make and inhabit them. Echinoderms tend to be very calcareous; lime is deposited in the mesodermic tissue of the body in almost any part, though predominantly near the surface. Most Arthropods have well-developed exoskeletons, cuticles formed from the epidermis, consisting in great part of an organic basis of chitin, on which, in Crustaceans and most Myriopoda, carbonate of lime is also deposited. As this cuticle is not always restricted to the outside of the animal, but sometimes extends inwards, an apparent endoskeleton arises—e.g. in the lobster, the king-crab, and the scorpion. Most Molluscs have shells in which carbonate of lime occurs along with an organic basis conchiolin, and in cuttle-fish there is a remarkable development of cartilage around the nerve-centres in the head—an analogue of the skull in Vertebrate animals. From this rapid survey it will be seen that the skeletons of Invertebrates are very varied alike in structure and in composition; if we except a few doubtful hints of a supporting axis, there are no homologies between the skeletons of Invertebrates and Vertebrates; to the latter, moreover, that form of tissue which we call bone is exclusively restricted.

Skeleton of Vertebrates.—Here we must distinguish first of all between the external exoskeleton and the internal endoskeleton. The scales of fishes, the scales and scutes of reptiles, the scales, claws, and even feathers of birds, the remarkable bony armature of armadillos, the scales of pangolins, the claws of carnivores, the quills of porcupines, and even the hair of ordinary mammals illustrate the variety of structures which may be included within the anatomical conception of an exoskeleton. All these structures are formed in the epidermis, or in the dermis, or in both combined. Tortoise-shell and the scales of reptiles are epidermic; the scutes of crocodiles and the plates covering armadillos are dermic; the scales of Elasmobranch and Ganoid fishes are due to both layers. But it is difficult to carry out any rigidly logical classification. Thus, the dorsal shield of a tortoise is physiologically an exoskeleton, but structurally it is in great part formed from the dorsal vertebrae and from what in other animals form the ribs. The ventral shield of a tortoise is formed from dermal bones, and the so-called abdominal ribs of crocodiles arise as ossifications in the fibrous tissue which lies underneath the skin and above the muscles. The teeth of Elasmobranch fishes are undoubtedly homologous with the dermal denticles or skin-teeth which occur over the skin, and the teeth of mammals are started by enamel germs which sink in from the epidermis of the mouth.

The Vertebral Column.—In a primitive Vertebrate animal like the lancelet the body is supported by a median dorsal axis, and, apart from slight supports for the mouth, the pharynx, and the median fin, this is all the skeleton. The median dorsal axis, which in the lancelet has not even the

firmness of cartilage, is called the notochord, and is one of the constant characteristics of the skeleton of Vertebrates. There is a hint of it in the proboscis of *Balanoglossus* (q.v.) and in *Cephalodiscus* (q.v.); it is more distinct in the tail of young *Ascidians* (q.v.), and persists throughout life in *Appendicularia*; in the lancelet, in the hag, and in the young lamprey it is an unsegmented rod with a

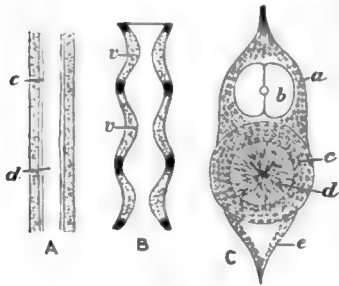

Fig. 1.

A, unsegmented notochord (*d*), its sheath (*c*). B, notochord in process of being constructed by its sheath, the parts marked *c* corresponding to the centres of two adjacent vertebrae. C, section of a young vertebral column: *d*, the notochord; *c*, its sheath; *b*, the spinal cord protected by neural arches (*a*); beneath are inferior processes (*e*).

yet no vertebral bodies. These begin in the Elasmobranch fishes, in which the notochord is, in part at least, constricted by the encroachment of its sheath, and divided into vertebrae. In the bony Ganoids, such as *Lepidosteus*, the vertebrae are ossified, and so they are more or less thoroughly in all the higher Vertebrates. Yet it is not the notochord which is ossified, but its sheath; the notochord in all higher Vertebrates being merely a provisional structure, an internal scaffolding around which its 'substitute,' the backbone, is built. Each vertebra generally consists of the substantial body or centrum, the neural arches which form a tube for the spinal cord and meet above it in a neural spine, the transverse processes which project laterally and are usually connected with ribs, and the articular processes which bind vertebra to vertebra so that a firm and yet flexible backbone results.

A breastbone or sternum to which the ribs are ventrally united occurs in many Reptiles and in all Birds and Mammals. It arises from a cartilaginous tract uniting the ventral ends of the ribs. In Amphibians also there is a breastbone, but there are no distinct ribs, and it is not certain that we can compare this sternum with that of higher Vertebrates.

The Skull.—In a young Vertebrate animal the cavity in which the brain lies is surrounded by a membranous sheath, but this is gradually replaced, first by a gristly brain-box, and afterwards in most cases by an almost entirely bony skull. Let us first consider the gristly brain-box or chondrocranium. (*a*) Its foundation is formed from two pairs of cartilaginous plates—posterior parachordals and anterior trabeculae—which lie beside and in front of the notochord. These are extended upwards by a further formation of cartilage; the end of the notochord may also help a little: the result is a cartilaginous brain-box. (*b*) But to the sides of this are added a pair of cartilaginous nasal capsules in front, and a similar pair of auditory capsules behind. (*c*) About the mouth there are some lip or labial cartilages, which may help in forming the skull; but much more important is a series of cartilaginous 'branchial arches' (never more than

eight pairs), which loop round the pharynx, running between the primitive gill-clefts. Of these arches the two most anterior, which are called the mandibular and the hyoid arches, are of great importance in the development of the skull; the others form supports for the pharynx, and are permanently important only in Fishes and in gilled Amphibians. In Elasmobranch fishes the mandibular and hyoid arches do not form any direct part

of the gristly brain-box, but in the Teleosteans and thence onwards they, or the bones which replace them, contribute directly to the upbuilding of the skull. To follow the history of the arches, which undergo numerous transformations, is one of the most difficult and interesting tasks of comparative anatomy. (*d*) When a bone develops in direct relation to a pre-existent cartilage which it replaces, it is often called a primary or 'cartilage bone;' and there are many regions of the cartilaginous brain-box which in the course of development are thus replaced by bones. But there are other bones which develop independently of pre-existent cartilage. They invest the cartilaginous brain-box on its roof, on its floor, and on its sides. They are comparable to the dermal ossifications or scutes which occur in Ganoid fishes and many other animals, and they are often called secondary or 'membrane' bones. In structure they are of course indistinguishable from 'cartilage bones;' in origin too they are in one way the same, for all bones arise from a (periosteal) membrane of bone-making cells; but 'cartilage bones' are at one time represented by cartilages, whereas 'membrane bones' never are.

To sum up, the skull is formed (*a*) from the parachordals and trabeculae at the end of the notochord, (*b*) from the adjacent sense-capsules of the nose

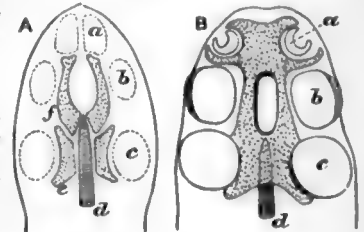

Fig. 2.

A, cartilaginous rudiments of the skull: parachordals (*c*), trabeculae (*f*), anterior end of notochord (*d*), auditory capsule (*c*), optic capsule (*b*), nasal capsule (*a*). B, a slightly more advanced state; the nasal and auditory capsules have fused with the brain-box; the optic capsules remain free.

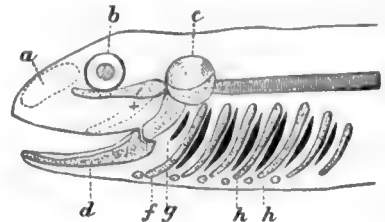

Fig. 3.—Diagram showing the branchial arches of the Embryo:

d and *g*, parts of first or mandibular arch; *f*, part of second or hyoid arch; behind these the arches (*h*) separating gill-clefts; *a*, *b*, *c*, the nasal, optic, and auditory capsules.

and the ear, (*c*) from the more or less intimately associated mandibular and hyoid arches, (*d*) from the ossification of the gristly brain-box due to (*a*), (*b*), and (*c*), but also from 'membrane bones' or investing bones which arise independently of pre-existent cartilages. There is no skull in Tunicates or in the lancelet; it is cartilaginous in Cyclostomata and Elasmobranchs; centres of

ossification and investing bones begin with the Ganoid fishes, and are numerous in Teleosteans and in all higher animals. In the development of the individual there is a parallel progress.

Theory of the Skull.—About the beginning of the 19th century Oken and Goethe independently suggested what is known as the vertebral theory of the skull—an undoubtedly suggestive theory, to which Owen lent the strength of his authority, but which has been disproved by the subsequent discoveries of comparative anatomy and embryology (see SKULL).

The Appendicular Skeleton.—Somewhat apart from the axial skeleton are the limbs and the girdles to which these are attached. No secure conclusion has yet been reached as to origin of the limbs of Vertebrates. In the simplest forms—the Tunicates, the lancelet, the Cyclostomata—there are none, and there is a very marked difference between the fin-like limbs of fishes and the fingered and toed limbs which occur in almost all higher backboned animals. According to Gegenbaur, the pectoral and pelvic girdles are structures comparable to the branchial arches, and he supposes that the primitive limbs were made up of modified fin-rays comparable to those which support the unpaired fins of fishes. According to Dohrn the limbs are residues of a longitudinal series of segmentally arranged outgrowths, perhaps comparable to the appendages of a typical Annelid worm (see FISHES, VERTEBRATA).

The pectoral or shoulder-girdle consists of a dorsal shoulder-blade or scapula, a ventral coracoid, with the articulation for the arm between them, and of a forward-growing collar-bone or clavicle. The pelvic or hip-girdle consists on each side of a dorsal ilium, a ventral ischium, with the articulation for the leg between them, and of a third pubic portion. The fore-limb—from Amphibians onwards—consists of a humerus articulating with the girdle, a lower arm composed of radius and ulna lying side by side, a wrist or carpus of several elements, a hand with metacarpal bones in the palm and with fingers composed of several joints or phalanges. The hind-limb—from Amphibians onwards—consists of a femur articulating with the girdle, a lower leg composed of tibia and fibula lying side by side, an ankle region or tarsus of several elements, a foot with metatarsal bones in the sole and with toes composed of several joints or phalanges. Distinct from all the other bones are a few little 'sesamoids' which are occasionally developed within tendons and

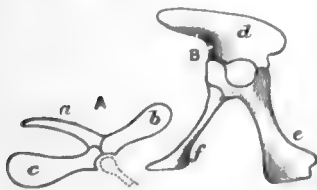

Fig. 4.

A, diagram of half of an ideal pectoral girdle: a, clavicle; b, scapula; c, coracoid. B, diagram of half of the pelvic girdle of an alligator: d, ilium; e, ischium; f, pubis.

near joints, notably, for instance, the knee-pan or patella.

The Skeleton of Man.—As the bones of all the chief parts of the human body are described in separate articles, we need not do more than unify these by reference to a diagram of the entire

skeleton (fig. 5). Altogether there are more than 200 bones, but some which are originally distinct become fused with their neighbours.

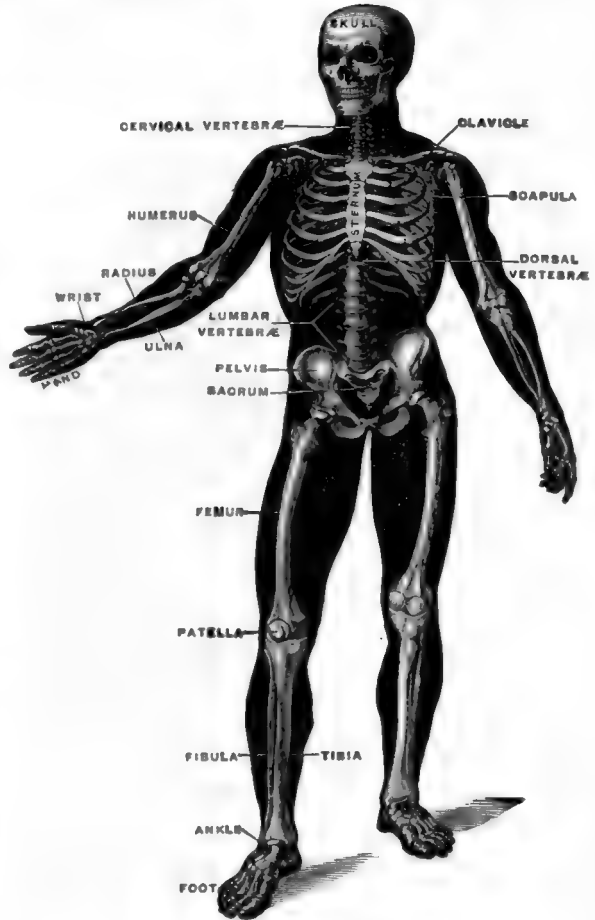

Fig. 5.—Human Skeleton.

In the vertebral column there are originally thirty-three vertebrae, but in adult life the normal number is twenty-six, for, while the first twenty-four remain distinct, five (the twenty-fifth to the twenty-ninth inclusive) unite to form the sacrum supporting the hip-girdle, and the four hindmost fuse more or less completely in a terminal tail-piece or coccyx. Seven cervicals support the neck; twelve dorsals form the greater part of the back and bear ribs; five lumbar occur in the loins; these are followed by the sacrum and the coccyx (see SPINAL COLUMN).

The ribs, or elastic arches of bone which bound the chest, are normally twelve on each side. Most of them articulate dorsally with the bodies of two adjacent vertebrae and with the transverse processes of the posterior one; ventrally the first seven pairs are connected with the median breastbone by means of intervening cartilages, while the posterior five pairs are more or less free (see RIBS).

The skull consists in early adult life of twenty-two separate bones, but originally there were more, and as life continues the number may be further reduced by fusion. For the various bones, see SKULL.

The skeleton of the arm includes thirty bones—in the upper arm the humerus, which articulates with the shoulder-girdle; in the forearm the radius and

ulna, which articulate with the humerus at the elbow; the wrist of eight carpal bones; the five metacarpals of the palm; the five digits, of which the four fingers have each three joints or phalanges, while the thumb has two. The important bone of the pectoral girdle is the shoulder-blade or scapula. To this, at the shoulder-joint, there is fused a small beak-like bone—the coracoid—which is separate in Birds and Reptiles, but reduced to a mere process of the scapula in all Mammals except the Monotremes. Stretching from the breastbone to shoulder-blade is the curved collar-bone or clavicle.

The skeleton of the leg also includes thirty bones—in the thigh the femur, which articulates with the hip-girdle; in the lower leg the shin-bone or tibia and the splint-bone or fibula, which articulate with the femur at the knee-joint, where there lies a little 'sesamoid' bone—the patella; in the ankle region seven bones, then five metatarsal bones forming the sole of the foot, and five toes with the same number of phalanges as in the fingers. The pelvic girdle consists in early life of three paired bones—large dorsal ilium, a posterior ischium, an anterior pubis on each side—but these unite about the twenty-fifth year into single haunch-bone, with the socket of which the thigh articulates. See ARM, HAND, SHOULDER, FOOT, LEG, PELVIS, RIBS, SKULL, and SPINAL COLUMN; for literature, see the works referred to in the article ANATOMY. Skeletons other than human will be seen under the headings of ANTHROPOID APES, BAT, BIRD, ELK, FISHES, HESPERORNIS, ICHTHYOSAURUS, IGUANODON, MEGATHERIUM, PLESIOSAURUS, PTERODACTYL, &c.; and skulls at BABIROUSSA, CARNIVORA, DOG, RODENTIA, &c.

Skelligs, three rocky islands on the south-west coast of Ireland, lying 10 miles SW. of Valentia island. On one of the rocks stands a lighthouse, the light of which is 175 feet above high-water, and visible 18 miles at sea. On Great Skellig (710 feet high) are the ruins of a monastery.

Skelmersdale, a town of Lancashire, 4½ miles from Ormskirk. Pop. (1851) 760; (1891) 6627.

Skelton, JOHN, an early satirical poet, is supposed to have been born about 1460, most probably in Norfolk, although generally said to have been sprung from a Cumberland family. He studied at Cambridge, perhaps also at Oxford, and received from each the academical honour of laureate. He was appointed tutor to the young prince Henry, and early acquired such reputation for learning that Erasmus styles him 'the one light and ornament of British letters.' He took holy orders in 1498, and became rector of Diss in Norfolk, but seems later to have been suspended for keeping a concubine; although Fuller tells us how, on his death-bed he protested 'that in his conscience he kept her in the notion of a wife, though such his cowardliness that he would rather confess adultery (then accounted but a *venial*) than own marriage, esteemed a capital crime in that age.' Wood tells us that he 'was esteemed more fit for the stage than the pew or pulpit,' and Churchyard says 'his talke was as he wract.' Already he had produced some translations, and elegies upon Edward IV. and that Earl of Northumberland murdered by a Yorkshire mob in 1489; but now he struck into an original vein of satirical vernacular poetry, in rattling verses of six, five, and even four syllables, with quick-recurring rhymes, overflowing with grotesque words and images and unrestrained jocularity, and lightened up by bright gleams of fancy. His bent leaned strongly towards satire, and in this kind his chief productions were *The Bourge of Courte*, *Colyn Cloute*, and *Why come ye nat to Courte*. Of these the first is an allegorical poem showing striking power of characterisation;

the second, a vigorous and unsparing attack on the corruptions of the church, of which he himself says, 'though my ryme be ragged, tattered and jagged, rudely rain-beaten, rust and moth-eaten, if ye take well therewith, it hath in it some pyth'; the last is a sustained invective against Cardinal Wolsey. He attacks with the most plain-spoken boldness his arrogance, avarice, and incontinence, and does not spare even his 'gresy genealogy' and the 'bocher's stall.' Wolsey felt the sting, and tried to arrest his libeller, but Skelton fled to the sanctuary in Westminster, where Abbot Islip sheltered him till his death, June 21, 1529. Of his other poems the chief are *Phyllipp Sparowe*, a young girl's lament for a pet bird killed in a convent of black nuns at Carowe near Norwich, an amusing but rather profane *jeu d'esprit*, which Coleridge called 'an exquisite and original poem'; *The Tunnyng of Elynour Rummyng*, a vigorous burlesque picture of low life, its heroine an ale-wife at Leatherhead in Surrey; the *Garlande of Laurell*, a long but less successful poem; and *Magnyfycence*, the only one of his Interludes that has survived. Skelton's reputation for wit, if not ribaldry, was so great that a wretched book of 'merye tales' was popularly linked with his name: as undeserved is Pope's phrase—'beastly Skelton'—written on occasion of a reprint in 1736 of the first collected edition (1568). The only good edition is that by the Rev. A. Dyce (2 vols. 1843).

Skene, WILLIAM FORBES, an erudite Scottish historian, was born at Inverie in Inverness-shire, 7th June 1809, the second son of Scott's friend, James Skene (1775-1864). He had his education at Edinburgh High School, in Germany, and at the universities of St Andrews and Edinburgh, afterwards, in 1834, becoming a Writer to the Signet in Edinburgh. In 1879 he received the D.C.L. degree from Oxford, and in 1881 he succeeded Hill Burton as Historiographer for Scotland. He died on the 29th August 1892. Among his most important works are *The Highlanders of Scotland* (2 vols. 1837), *The Dean of Lismore's Book: a Selection of Ancient Gaelic Poetry* (1861); *Chronicles of the Picts and Scots* (1867); *Fordun's Cronica Gentis Scotorum* (2 vols. 1871); *The Four Ancient Books of Wales* (2 vols. 1868); *Celtic Scotland, a History of Ancient Alban* (3 vols. 1876-80); and *Memorials of the Family of Skene of Skene* (New Spalding Club, 1887).

Skepticism. See SCEPTICISM.

Skerries, a name applied to several groups of isolated rocky islets round the coasts of Great Britain, more especially a group about 2 miles off the north-west coast of Anglesey, having a lighthouse 117 feet high. See also PENTLAND FIRTH.

Skerries, an Irish seaport, 18 miles N. by E. of Dublin. Pop. 2227.

Skerryvore, the chief rock of a reef which lies 10 miles SW. of Tyree and 24 W. of Iona. This reef, which stretches 8 miles west-south-westward, is composed of compact gneiss, worn smooth by the constant action of the waves, and was long a terror to mariners, having caused the loss of one ship annually for forty years previous to 1844. The Northern Lighthouse Commission had long intended the erection of a lighthouse on Skerryvore, the only point of this dangerous reef which could afford the needful foundation; but the difficulty of landing on the rock, from the immense force (3 tons to the superficial foot) with which the Atlantic waves beat upon it, caused the delay of the scheme till 1838. The design and superintendence of the building were entrusted to Alan Stevenson, who followed generally the mode adopted by his father, Robert Stevenson, in the construction of the Bell Rock Lighthouse, and completed his

work in 1844. The lighthouse is 138½ feet high; at the base 42, and at the top 16 feet in diameter. The light, a revolving one, can be seen at a distance of 18½ nautical miles. The cost of erection was £86,977. See A. Stevenson's *Account of the Skerryvore Lighthouse* (Edin. 1848).

Skibbereen, a market-town of the county of Cork, Ireland, 54 miles SW. of Cork, at the terminus of a branch-line, with a little trade in agricultural produce. It suffered terribly during the famine of 1846-47. Pop. 3631.

Skiddaw, a mountain (3054 ft.) of Cumberland, flanking the east side of Bassenthwaite Water, and 5½ miles NNW. of Derwentwater and Keswick.

Skimmer, or **SCISSORS-BILL** (*Rhynchops*), a genus of long-winged sea-birds belonging to the Gull family (*Laridae*). Their most distinctive feature is the long, thin bill with the lower half longer than the upper. There are only three known species, occurring respectively in Asia, Africa, and America. Darwin describes the American skimmers, or, as they are also called, Shearwaters (*R. niger*), as skimming along the surface of the water, generally in small flocks, ploughing up small fish with their projecting lower mandible, and securing them with the upper half of their scissors-like bills. See GULL.

Skin. The skin forms a complete covering for the outer surface of the body, and consists of two distinct layers, of which the outer is termed the *epidermis*, *cuticle*, or *scarf-skin*, and the inner the *corium* or *cutis vera*. Moreover, the skin contains certain structures termed 'tactile corpuscles,' by means of which the properties of bodies are revealed to the sense of touch; and associated with the skin there are such accessory organs as hair, nails, sebaceous glands, and sweat-glands.

The *epidermis* is non-vascular, and forms a protective covering for the *cutis vera*. It varies in thickness from ¼th to ½th of an inch, being thickest in the palms of the hands and soles of the feet. In structure it consists of cells, closely adherent to each other by their margins, and arranged in many irregular layers. The individual cells vary in shape, being perpendicular in the deepest layer, and passing by various transitions into a surface stratum of hardened flattened cells, which are constantly being thrown off by desquamation; fig. 1 shows the various transitions. In many of the cells, even of white races, pig-

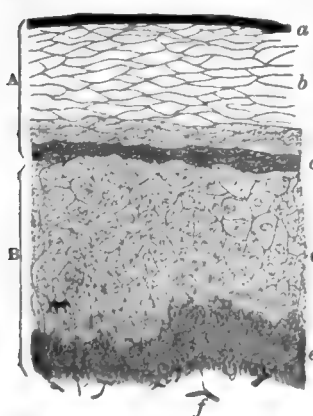

Fig. 1.—Section of Epidermis from the Human Hand, highly magnified (Ranvier):

A, horny layer, consisting of a, superficial horny scales; b, swollen out horny cells; c, stratum lucidum; B, rete mucosum, consisting of d, prickle cells; e, elongated cells near corium; f, a nerve-fibre.

ment granules are found, and the tawny colour of the skin. A section of the epidermis of a Negro's leg, showing the cells of the horny and mucous layers, will be found at Epidermis (q.v.). If a large portion of the epidermis be removed, the process of repair is slow, and proceeds from the edges of the wound, but recovery is quicker if any of the deeper cells of

the layer remain. Skin-grafting aims at transplanting small portions of healthy epidermis—including its deeper layers—to denuded surfaces, and when the grafts take root the raw surface is much more speedily covered because the healing process spreads from each graft (see RHINOPLASTIC OPERATIONS). Nails and Hair (q.v.) are growths of the epidermis.

The *cutis vera*, *corium*, or *true skin* is a vascular and sensitive structure, everywhere covered by the epidermis. It rests on a layer which in most places contains fat—the *panniculus adiposus*—and to this layer the corium is sometimes loosely, sometimes firmly, attached. In structure the true skin consists of an interlacing network of white fibrous tissue with a mixture of elastic fibres. On its deep aspect the meshes are more open, and contain lumps of fat. In this way the corium gradually blends with the subcutaneous layer, and so its thickness is not definite, but is generally regarded as varying from ¼th to ½th of an inch. Wherever hairs occur bundles of muscular fibres are found. The outer surface of the corium is characterised by furrows, which also affect the epidermis. The largest furrows are found opposite the flexures of joints. Finer furrows may be seen on the backs of the hands; while on the skin of the palms and soles ridges with intervening furrows form patterns which are characteristic of each individual. These patterns are permanent, and do not materially change from infancy to adult life (Galton). The latter furrows are due to the fact that the outer surface of the corium is beset with small elevations termed *papillæ* (fig. 2). These are most fully



Fig 2.—Compound Papillæ of Surface of Hand: a, base of a papilla; b, b, their separate processes. Magnified 60 diameters.

developed where touch is finest, and they fit into corresponding depressions on the under surface of the epidermis. The deeper layers of the corium are plentifully supplied with blood-vessels, which form a fine network of capillaries from which loops pass into most of the papillæ. Fine nerves are also supplied to the corium for distribution to the 'touch corpuscles' found in certain papillæ. As a rule papillæ with touch corpuscles have no capillary loop, and thus we distinguish 'vascular' and 'tactile' papillæ. The hair-follicles also receive nerves, and fine varicose nerve-fibrils pass into the deeper layers of the epidermis. *Sebaceous glands*, found wherever hairs are present, pour their secretion into hair-follicles at a short distance from the mouth, unless the hair be small, when the gland may open on the surface of the skin, and the hair project through its duct. Being outgrowths of the hair-follicles they are accessory structures to the epidermis, although the body of the gland is lodged in the corium. They are specially abundant in the scalp and face—some of the largest being found on the side of the nose. Their secretion consists of the fatty degenerated and disintegrated cells which line their interior (see ACNE).

Sweat-glands are found at various depths beneath the corium. Each gland is a coiled-up tube, of which the *duct* is that part leading in a corkscrew manner through the corium and epidermis to the

surface. These glands are also outgrowths of the epidermis, and they are lined by epithelial cells. They are most numerous where there is no hair, but they occur everywhere in connection with the skin. Krause states that 2800 open on a square inch



Fig. 3.—Magnified view of a Sweat-gland, with its duct (Wagner):

a, the gland surrounded by fat cells; b, its duct, passing through corium and epidermis.

of skin from the palm; half as many on a similar area on the back of the hand; fewer on the surface of the forehead; 1100 on breast and forearm; while from 400 to 600 are found on the square inch of the lower limbs and back of the trunk. The sweat is naturally *alkaline*, although it may be found acid owing to the presence of fatty acids derived from the decomposition of sebum. In prolonged sweating the secretion becomes neutral and again alkaline. It is colourless, of a saltish *taste*, and its odour, which is due to volatile fatty acids, varies with different parts of the body. Coloured sweat is among the phenomena of nervous affections, and instances of blue and bloody sweats are on record. In jaundice the sweat may contain bile-pigment.

Ceruminous glands are found in the auditory passage, and have such a close resemblance to sweat-glands that the former may be regarded as modifications of the latter. They yield an adhesive bitter secretion—the wax—which

protects the drum of the ear from insects, dust, &c.

The most important function of the skin, Touch (q.v.), is separately treated. Regarded as a protective covering, the skin possesses the combined advantages of toughness, resistance, flexibility, and elasticity; the connective framework being the part which mainly confers these properties, although the epidermis co-operates with it. The subcutaneous layer of fat, and the modifications of epidermis in various forms, as hairs, wool, feathers, scales, &c., serve for the preservation of warmth, and occasionally (when they occur as claws, talons, &c.) as means of offence or defence. The skin is the seat of a twofold excretion—viz. of that formed by the sudoriparous glands and that formed by the sebaceous glands. The fluid secreted by the sudoriparous glands is usually formed so gradually that the watery portions of it escape by evaporation as soon as it reaches the surface; but in certain conditions, as during strong exercise, or when the external heat is excessive, or in certain diseases, or when the evaporation is prevented by the application of a texture impermeable to air, as, for example, oiled silk, or the material known as mackintosh, or india-rubber cloth, the secretion, instead of evaporating, collects on the skin in the form of drops of fluid. When it is stated that the sweat contains urea, lactates, extractive matters, &c., and that the amount of watery vapour exhaled from the skin is, on an average, 2½ lb. daily, the importance of the sudoriparous glands as organs of excretion will be at once manifest. Moreover, there is reason to believe, from the experiments of Scharling, Gerlach, and others, that the importance of the skin as a *respiratory* organ is far from inconsiderable, very appreciable quantities of carbonic acid being exhaled hourly by the external surface of the body. In the amphibia, in which the skin is thin and moist, the cutaneous respiration is extremely active; and that the respiratory function of the skin in the higher animals is also considerable is

proved not only by measuring the excreted carbonic acid, but by the fact that if the skin is covered by an impermeable varnish, or if the body is enclosed, all but the head, in a caoutchouc dress, animals soon die, as if asphyxiated, their heart and lungs being gorged with blood, and their temperature before death gradually falling many degrees.

The skin is, moreover, an organ of absorption: mercurial preparations, when rubbed into the skin, have the same action as when given internally. Thus potassio-tartrate of antimony, rubbed into the skin in the form of ointment or solution, may excite vomiting, or an eruption extending over the whole body. The effect of rubbing is probably to force the particles of the matter into the orifices of the glands, where they are more easily absorbed than they would be through the epidermis. It has been proved by the experiments of Madden, Berthold, and others, that the skin has the power of absorbing water, although to a less extent than occurs in thin-skinned animals, such as frogs and lizards. This fact has a practical application. In severe cases of dysphagia—difficult swallowing—when not even fluids can be taken into the stomach, immersion in a bath of warm water, or of milk and water, may assuage the thirst. Sailors, also, when destitute of fresh water, find their urgent thirst allayed by soaking their clothes in salt water.

The *diseases* of the skin are classified as DISEASE (q.v.); the more important affections are noticed in special articles. See also ALBINOS, BATH, NERVOUS SYSTEM. The colour of the skin as a means of distinguishing race is dealt with at ETHNOLOGY. Peculiarities in the skins of various animals are treated in the articles on those animals (HIPPOPOTAMUS, RHINOCEROS, &c.). For skins as articles of commerce, see FURS, LEATHER. For the stuffing of animals, see TAXIDERMY.

SKIN-CASTING is a popular term for processes which vary not a little in degree and even in nature. In most cases the outer layer of the epidermis tends to die away, and is separated off either very gradually and in small pieces at a time, or in large shreds, or in a continuous slough (see SNAKES). The moulting of feathers and the casting of hair are analogous. In the moulting or 'ecdysis' of Crustaceans and other Arthropods, what is cast is the cuticle—a product of the underlying epidermis. See CRAB, CRAYFISH, CRUSTACEA.

Skink (*Scincus officinalis*), an African lizard, which lives in sandy places, and burrows with great rapidity. It is from six to eight inches long, generally of a reddish-dun colour, with darker

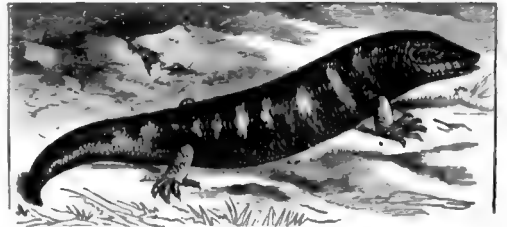

Skink (*Scincus officinalis*).

transverse bands, a wedge-shaped head, and four rather strong limbs. For ages it has been in great repute for imaginary medicinal virtues; it was largely imported on this account into ancient Rome, and is still in high esteem in the East, dried skinks finding a ready sale in many places, as Cairo and Alexandria. There is almost no disease for which skink-powder has not been supposed to be a cure. The Skink is typical of the family Scincidae, of which Eumeces with

well-developed legs, Seps with very weak legs, Nessia with rudimentary legs, Acontias with no legs are representative genera. In many there are well-developed bony scutes beneath the rounded scales. See LIZARDS.

Skinner, JOHN, the author of 'Tullochgorum,' was born in the parish of Birse, Aberdeenshire, 3d October 1721, the son of the schoolmaster there. He graduated at seventeen at Aberdeen, taught in the parish schools at Kenmay and Monymusk (where he left the Presbyterian for the Episcopal Church), and in 1740 went as private tutor to Shetland, where he married the daughter of the Episcopal clergyman. In 1742 he was ordained a deacon, and placed at Longside, where he ministered for sixty-four years. In 1746 his house was pillaged and his chapel burned by the Hanoverian soldiery, although Skinner was no Jacobite, and was one of the few who, so far as he could, complied with the terms of the Toleration Act—for which, however, he had to receive the absolution of his bishop, the church at large regarding compliance as sin. The Act of 1748 he and his people evaded for the most part, and in 1753 he was imprisoned for six months. At some period before 1789 he became dean of the diocese; and he died at Aberdeen, in his son's house, 16th June 1807.

Skinner is remembered only by a few songs. He published *An Ecclesiastical History of Scotland* (2 vols. 1788), and several controversial writings; and other works appeared posthumously, including those wrought out after the theory of John Hutchinson (q.v.). His *Poems* were collected in 1809 (3d ed. 1859), the best being 'The Ewie wi' the Crookit Horn' and 'Tullochgorum'—praised by Burns, in a friendly letter to Skinner (1787), as 'the best Scotch song Scotland ever saw.' See the Life by the Rev. Dr Walker (2d ed. 1883).

His son, JOHN SKINNER, Primus of Scotland, was born at Longside, 17th May 1744, in 1753 shared his father's imprisonment, and graduated at Aberdeen at the age of sixteen. In 1763, when only nineteen—for the same reason as in the case of Dr Chalmers, because he was 'a lad of pregnant parts'—he was ordained and placed in charge of Ellon, with a stipend of £25 a year, eked out by farming. Eleven years later he was called to Aberdeen, where by 1776 his congregation had so increased as to compel his removal to a larger house at Longacre, where the upper floor as usual was fitted up as a 'meeting-house'—the large 'upper room' in which Dr Seabury was consecrated in 1784. By this time Skinner had been made coadjutor-bishop (1782), and in 1787 he became bishop of the diocese, and in 1788 primus. The death of Prince Charles Edward, which occurred in this last year, was the solution of the church's Jacobite difficulty; and the leading part in obtaining the Relief Act of 1792 fell to the primus. Skinner proved a wise and successful administrator, and his great influence was exerted invariably for the real good of the church. He died on 13th July 1816, and was succeeded as bishop by his son. See the Life by Dr Walker (1887).

Skipton, a market-town in the West Riding of Yorkshire, is finely situated in the broad and fertile valley of the Aire, 26 miles NW. of Leeds. The capital of Craven, it is a gray-looking place, with manufactures of cotton and woollen goods, and is an important station on the Midland line. The castle, once the chief seat of the Cliffords (q.v.), is of two periods, the reigns of Edward II. and Henry VIII., and is partly a ruin, partly inhabited. The church has some interesting monuments; and there are also a public hall (1861), a grammar-school (1548; rebuilt in 1876-77 at a cost of £12,000), and a saline spring. Bolton Abbey (q.v.) is 6 miles distant. Pop. (1851) 4962; (1891) 10,376. See W. H. Dawson's *History of Skipton* (1882).

Skirret (*Sium Sisarum*), a perennial plant of the natural order Umbelliferae, a native of China and Japan, but which has long been cultivated in gardens in Europe for the sake of its roots, which are tuberous and clustered, sometimes 6 inches long, and of the thickness of the finger. They are sweet, succulent, and nutritious, with a somewhat aromatic flavour, and when boiled are a very agreeable article of food. A kind of spirituous liquor is sometimes made from them. Good sugar can also be extracted. Skirret was at one time more cultivated in Britain than it is at present, although there seems to be no good reason for its having fallen into disrepute. Worledge called it the 'sweetest, whitest, and most pleasant of roots.' It is propagated either by seed or by very small offsets from the roots. It has a stem of 2 to 3 feet high; the lower leaves pinnate, with oblong serrated leaflets, and a heart-shaped terminal leaf, the upper ones ternate with lanceolate leaflets.

Skittles, a game usually played in a covered shed, called a skittle-alley, about 60 feet in length. The skittles are made of hard wood of the shape shown at A in the fig., and they are placed upon



the floor of the shed in the order shown at *a*. The player, standing at *b*, trundles a wooden missile, shaped like a small, flat cheese, from 7 to 14 lb. in weight, and tries to knock down the whole of the skittles in as few throws as possible. The game is very similar to the American bowls, which is played with ten pins arranged in the form of a triangle; and the missile, a round wooden ball, is rolled along a carefully constructed wooden floor. The game of skittles (*Kegel*) with round balls is zealously played in most parts of Germany, but with great local variations. Thus in Silesia there are sometimes fifteen or seventeen pins, though the usual number is nine; and in some places the round balls have holes in them for the fingers of the player—so that they are thrown rather than trundled. Sometimes the pins have different forms and values, one being called the king; and there are many ways of arranging them. The game seems to be of ancient Germanic origin, and to have come from Germany to the Netherlands, England, and France. It is described by Hugo von Trimberg, rector of a monastery at Bamberg in the second half of the 13th century (when there were only three pins). The old English game was called *Kails* (Sir Philip Sidney has *Keels*; in Scotland *Kyles*—all derived from the German *Kegel*), and was played, not with a ball or disc, but with a short club—according to Strutt, with a 'sheep's leg-bone.' There is a learned monograph on the game by Rothe (Halle, 1879). See also BOWLS.

Skobelev, MICHAEL DMITRIEVITCH, Russian soldier, born in 1841, entered the Russian guards when twenty, fought through the war of the Polish rising (1863), and in 1866 was called to join the general staff. During the years 1871-75 he was on active duty in Asia, preparing for and then taking part in the conquest of Khiva and conquering Khokand. In the Russo-Turkish war of 1877-78 he bore a conspicuous part: in the stormings of Plevna he commanded the left wing and entered that position at the head of his army corps; and he took prisoners the so-called Shipka army of the Turks and captured Adrianople. In 1880 he was

back again in Asia; and it was he who commanded at the storming of the Turkoman stronghold Geok Tepe (24th January 1881). Skobelev was one of the recognised leaders of the aggressive and militant wing of the Pan Slavist agitators; but he died suddenly on 7th July 1882, at Moscow, before he could put his ambitious schemes into execution.

See *Personal Reminiscences of General Skobelev*, by Neimirovitch-Dantchenko (Eng. trans. 1884), and the Life in German by Ossipovitch (Hanover, 1887).

Skoptsy. See RUSSIA, Vol. IX. p. 36.

Skowhegan, a town of Maine, capital of Somerset county, on the Kennebec (which here has a fall of 28 feet), 37 miles by rail NNE. of Augusta. It manufactures flour, oil-cloth, axes, paper, woollens, leather, &c. Pop. 5068.

Skua, or SKUA GULL. See GULL.

Skull. The skull is divided into two parts, the cranium and the face. In human anatomy it is customary to describe the former as consisting of eight and the latter of fourteen bones; the eight cranial bones, which constitute the brain-case, being the *occipital*, two *parietal*, *frontal*, two *temporal*, *sphenoid*, and *ethmoid*: while the fourteen facial bones, which surround the cavities of the mouth and nose and complete the orbits or cavities for the eyes, are the two nasal, two superior maxillary, two lachrymal, two malar, two palate, two inferior turbinated, vomer, and inferior maxillary. The bones of the ear, the teeth, and the Wormian bones are not included in this enumeration. The lower jaw articulates with the temporal bones by means of a diarthrodial Joint (q.v.), but all the others are joined by *sutures*. On the base of the cranium the occipital and sphenoid bones articulate by means of a plate of cartilage (synchondrosis) in young subjects; in adults this becomes bony union. Sutures are named from the bones between which they are found, but to those around the parietal bones special names are given—e.g. interparietal or *sagittal*; occipito-parietal or *lambdoid*; fronto-parietal or *coronal*; parieto-temporal or *squamous*. During adult life many of the sutures close by bony union and disappear, but both the age at which this occurs and the order of its occurrence are subject to variation. Wormian bones are irregular ossifications found in relation to the sutures of cranial bones, but seldom seen in relation to the bones of the face. They are most frequent in relation to the lambdoid suture, and seldom one inch in diameter. The closure of a suture stops the growth of the skull along that line, and in order to compensate for this defect an increase of growth may occur at right angles to the closed suture and thus irregularities of form may result: for example, closure of the sagittal suture stops transverse growth, but the skull continues to grow in the longitudinal and vertical directions, with the result that a boat-shaped cranium is produced—scaphocephaly. Irregular forms may be produced artificially by pressure applied early in life. This is best seen among certain American tribes who compress their children's heads by means of boards and bandages. The bones of the skull are pierced by holes (*foramina*), and similar holes are found in relation to the adjacent margins of bones. Most of these foramina are situated in the base or floor of the skull, and are for the ingress of arteries and the exit of veins and cranial nerves. The largest of these foramina—the foramen magnum—is found in the occipital bone. It is situated immediately above the ring of the atlas vertebra, and through it the continuity between the brain and spinal cord is established, and further, it transmits the vertebral arteries which supply blood to the brain. Compared with the skulls of animals, the form of the

human skull is modified (1) by the proportionately large size of the brain and the consequent expansion of the bones which surround it; (2) by the smaller size of the face, especially of the jaws, so that the face of man, instead of projecting in front of, is *under* the forehead of the cranium; (3) by the *erect attitude*, which places the base of the skull at a considerable angle with the vertebral column, and, in consequence of a development backwards from its point of articulation with the vertebrae, the skull is nearly balanced on the summit of the vertebral column. Hence the orbits look forwards and the nostrils look downwards. The development of the skull is a subject of great interest, not only in itself, but as throwing light on many points which the study of the adult skull

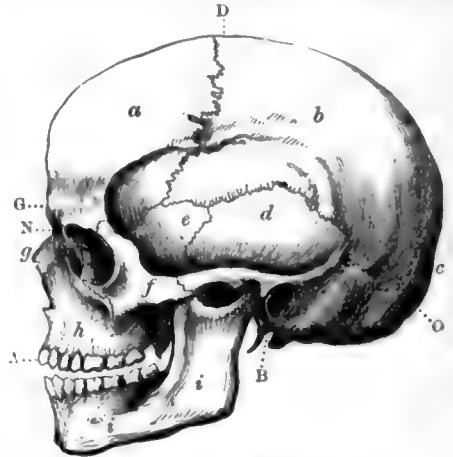

Fig. 1.—Side View of Human Skull:

a, frontal bone; b, parietal bone; c, occipital bone; d, temporal bone (squamous portion); e, sphenoid bone; f, malar bone; g, nasal bone; h, superior maxillary or upper jaw bone; i, inferior maxillary or lower jaw bone. BD, height of cranium; GO, length of cranium; BN, basinal length; BA, basialveolar length. (These measurements are supposed to be made in a straight line from point to point.)

would fail to explain. At a very early period of fetal existence the cerebrum is enclosed in a membranous capsule external to the dura mater, and in close contact with it. This is the first rudiment of the skull, the cerebral portion of which is consequently formed before there is any indication of a facial part. Soon, however, four or five processes jut from it on either side of the mesial line, which grow downwards, incline towards each other, and unite to form a series of inverted arches, from which the face is ultimately developed. Imperfect development or ossification of these rudimentary parts of the face gives rise to 'hare-lip' and 'cleft-palate,' or in very extreme cases to the monstrosity termed 'Cyclopean,' in which, from absence of the frontal processes, the two orbits form a single cavity, and the eyes are more or less blended in the mesial line.

The cartilage, formed at the base of the membranous capsule, is speedily followed by the deposition of ossific matter at various points of the capsule, which soon becomes converted into flakes of bone; while the intervening portions, which remain membranous, permit the skull to expand as its contents enlarge. Then follows the appearance of osseous nuclei in the cartilage at the base, corresponding to the future occipital and sphenoid bones. Lastly, the various bones, some originating in membrane, and some in cartilage (see OSSIFICATION), approach one another by gradual enlargement, and become united in various ways, so as to form a continuous, and ultimately an unyielding

bony case, which is admirably adapted for the defence of the brain, for sheltering the organs of special sense, and for being attached to the ligaments and muscles by which the skull is supported

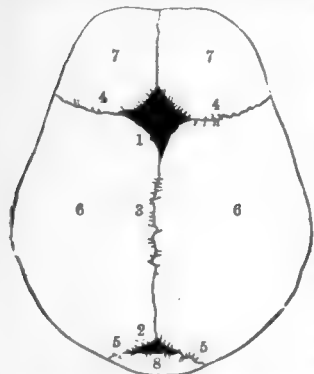

Fig. 2.—Human Skull at Birth, from above :

- 1, anterior fontanelle; 2, posterior fontanelle; 3, sagittal suture; 4, 4, coronal suture; 5, lambdoid suture; 6, 6, parietal bones; 7, 7, two halves of the frontal bone, still ununited; 8, occipital bone.

and is liable to sudden variations of size from temporary congestion, and other causes. The sutures remain distinct long after the closure of the fontanelles, and serve a purpose both in permitting an increase of the size of the cranium by the growth of the bones at their edges, and in diminishing and dispersing vibrations from blows, and thus contributing to the security of the brain.

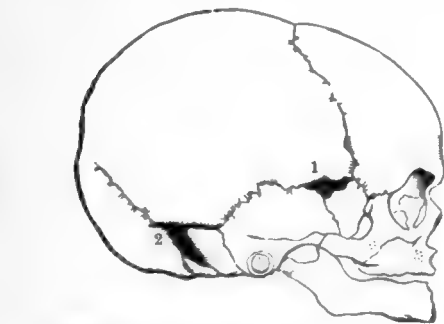

Fig. 3.—Human Skull at Birth (side view):
1, 2, lateral fontanelles.

The number of centres of ossification in the skull is tolerably constant; each bone having a certain number. After the sutures have been formed, and the skull has acquired a certain thickness, a process of resorption commences in the interior of the bones, and reduces the originally dense structure to a more or less cellular or cancellated state. The interior thus altered is called the *Diploë*, and by this change the weight of the skull is much diminished while its strength is scarcely affected.

The *diploë* usually begins to be apparent about the tenth year, and is most developed in those skulls which are thickest. A continuation of the same process of resorption which causes the *diploë* gives rise to the formation of the cavities known as the frontal and sphenoid sinuses. The formation of the *diploë* divides the walls of the cranium into three layers—viz. an outer tough layer; an inner dense, brittle, and somewhat glass-like layer, known as the vitreous table or layer; and the intervening cancellous *diploë*. *Diploë* is absent from the cribriform plate of the ethmoid bone and from the roof of the orbital cavities, and thus these are the thinnest parts of the cranium. The growth of the skull after the seventh year proceeds slowly, but a slight increase goes on to about the age of twenty. The skull-bones are freely supplied with blood from arteries which pass from the dura mater internally and the pericranium externally, through the numerous foramina observed on both surfaces; the blood being returned by veins which take various directions.

The fact that concussion of the brain scarcely ever proves fatal, unless there is also fracture of the skull, affords the most distinct evidence that the skull is constructed in such a manner that so long as it maintains its integrity it is able to protect its contents from serious lesion. This marvellous protective power is due to its rounded shape, whereby its strength is increased, and in consequence of which blows tend to glide off it without doing material damage. Moreover, the curved lines or ridges which may be traced round the skull tend to strengthen it. The weakest part of the skull is at the base. Hence, notwithstanding its removal from exposure to direct injury and the protection afforded by the soft parts, fracture takes

place more frequently at the base than at any other part of the skull, fracture often taking place here even when the skull was not broken at the part struck. There are two points in the architecture of the bones of the face which deserve especial notice—viz. (1) the great strength of the nasal arch; and (2) the immobility of the upper jaw, which is fixed by three buttresses—the nasal, the zygomatic, and the pterygoid.

The base of the skull, whether seen from within or from below, presents many objects of physiological interest in relation to the nervous system. As seen from within, the base presents on each side three fossæ, corresponding to the anterior and middle lobes of the cerebrum and to the cerebellum. These

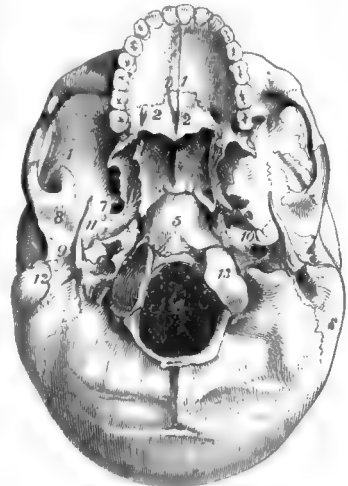

Fig. 4.—Base of the Human Skull :

- 1, 1, hard palate; 2, 2, palate bones; 3, vomer; 4, zygomatic fossa; 5, basilar process of the occipital bone; 6, foramen magnum; 7, foramen ovale; 8, glenoid fossa; 9, external auditory foramen; 10, carotid foramen of the left side; 11, styloid process; 12, mastoid process; 13, one of the condyles of the occipital bone.

presents many objects of physiological interest in relation to the nervous system. As seen from within, the base presents on each side three fossæ, corresponding to the anterior and middle lobes of the cerebrum and to the cerebellum. These

fossæ are marked, as is the whole skull-cap, by the cerebral convolutions, and they contain numerous 'foramina' and 'fissures' which give passage to various sets of nerves and blood-vessels. The external or outer surface of the base of the skull, if we consider it from before backwards, is formed by the palate processes of the superior maxillary and palate bones; the vomer; the pterygoid and spinous processes of the sphenoid and part of its body; the under surface of the temporal bones; and the occipital bone. The most important of the parts which it presents are named at fig. 4.

The *Morphology of the Skull* is the highest and most difficult problem of comparative anatomy, and has cost the most extraordinary labour for its solution. Goethe and Oken independently suggested that the skull was to be regarded as the modification of a series of four vertebrae, and this 'vertebrate theory' was worked out in the most elaborate detail by Owen and other anatomists (see SKELETON). Huxley, however, in a celebrated Croonian Lecture (1858), revised and extended the hitherto neglected embryological observations of Rathke, proposed an unanswerable destructive criticism of the archetypal theory, and may be said to have thus definitely placed the newer view in the way of general acceptance. An enormous amount of detailed research, for which we are indebted chiefly to Parker in England and Gegenbaur in Germany, has established the newer theory on the sure ground of actual observation.

Taking first the simple unsegmented cartilaginous cranium of a skate or dog-fish, with its appended jaws and branchial arches, we find that in development, though the notochord extends into the region of the head, the vertebrae stop altogether short of it; but that on each side of the cranium there arise a pair of cartilaginous bars—the *trabeculae* or 'rafters' of the future skull—and three pairs of cartilaginous capsules, nasal, ocular, and auditory, form round the developing sense-organs; the nasal capsules immediately unite with the ends of the trabeculae, which are meanwhile uniting below, and growing up at the sides to form the brain-case. The auditory capsules become united with the trabeculae by the appearance of two new masses of cartilage—the *parachordals*—the eyes of course remaining free. At first there are no jaws, but a series of seven or more similar vertical cartilaginous bars or arches, considerably resembling the trabeculae, between which slits open into the pharyngeal cavity. The first pair of these arches develops an ascending process, which passes above the developing mouth, and becomes the 'palato-ptyergoid' arch or upper jaw, the original portion remaining as the mandible. The second pair of arches—the 'hyoid'—becomes more or less modified usually to aid in supporting the jaws and floor of the mouth, while the remaining pairs become little modified, and serve throughout life to support the gills.

The more complex bony skulls of higher vertebrates are now in principle readily understood. The chondro-cranium and subjacent arches in all cases develop in the same way, although reduction and even atrophy of the gill arches subsequently takes place. The bones, although similar in the adult, originate in two utterly distinct ways, either by actual ossifications in the substance of the chondro-cranium and jaws, or by the ossification of overlying dermis, and are hence known as cartilage bones and membrane bones respectively—the latter corresponding to the dermal bones and teeth of ganoid and elasmobranch fishes. In mammals a further extraordinary specialisation takes place: the ends of the mandibular and hyoid arches lose their suspensory function, are taken up during development into the interior of the ear capsule, and are metamorphosed into the auditory ossicles.

Various Forms of the Skull.—Age.—At birth the existence of the fontanelles has already been referred to. The frontal and parietal eminences are especially prominent, and the mastoid process is absent. The face is only one-eighth of the bulk of the cranium, whereas in the adult the face is equal to one-half. During the first seven years the skull grows rapidly, and by this time many parts have attained definite size. At the period of puberty the face and regions of the air-sinuses undergo expansion. The face elongates owing to the growth of teeth and the increase in the size of their alveolar sockets. In old age the skull may become lighter and thinner or the reverse. Loss of the teeth and absorption of their sockets result in diminution of the size of the face, and thus the upper jaw recedes, while the chin becomes prominent.

Sex.—It is not always possible to determine the sex from the skull; but, as a rule, the skull of the male has more strongly marked muscular impressions, while the mastoid processes, superciliary ridges, and air-sinuses are more pronounced than in the female, whose skull generally retains the leading features of a young skull.

Race.—In comparing the skulls of different races of mankind it is necessary to have recourse to various methods of measurement, and these are usually conducted on the skulls of adult males. The following is a short summary of these methods. (a) *Cranial Capacity.*—This is obtained by filling the cranial cavity with shot, and then measuring the quantity in a graduated vessel, special precautions being observed in order to obtain equable results. The capacity of normal human crania

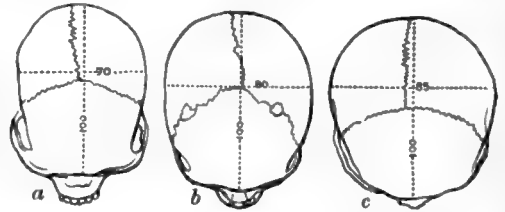

Fig. 5.—Typical Crania seen from the Vertex: a, Negro, index 70, Dolichocephalic; b, European, index 80, Mesaticephalic; c, Samoyed, index 85, Brachycephalic. (After Tylor.)

varies from 60 to 110 cubic inches—the average in all races being 85 cubic inches—e.g. Eskimo, 91.5; European, 90.3; Chinese and Mongols, 87.3; African Negroes, 82.4; Native Australians (aboriginal), 79.3; Andaman Islanders, 78.1. (b) Linear measurement of the *horizontal circumference* of the cranium. In the adult European male the average is 20.7 inches, and in the female 19.6 inches. (c) A third method is by comparison of the relative *length, breadth, and height* of the cranium. The standard of maximum length is taken as 100, and thus $\frac{100 \times \text{breadth}}{\text{length}} = \text{index of breadth or cephalic index}$; and on this basis skulls are classified in three groups—viz.:

Brachycephalic = breadth-index above 80.
Mesaticephalic = " " from 75 to 80.
Dolichocephalic = " " below 75.

In a similar way the proportion of height to length may be calculated, and a *height-index* established. It varies less than the breadth-index—e.g.:

	Breadth.	Height.
Mongolians of Siberia and Central Asia.....	88	78
Andaman Islanders.....	82	77
Chinese.....	79	75
English.....	76	71
Native Australians (aboriginal).....	71	71
Fiji Islanders.....	60	74

(d) *The Degree of Projection of the Jaws.*—We have seen that the human skull, when compared with the skulls of lower animals, presents a small face extended vertically, and thus placed under the anterior part of the cranial box. Prominent jaws therefore indicate an approach to an animal type, especially when associated with a receding forehead. The degree of projection is expressed by

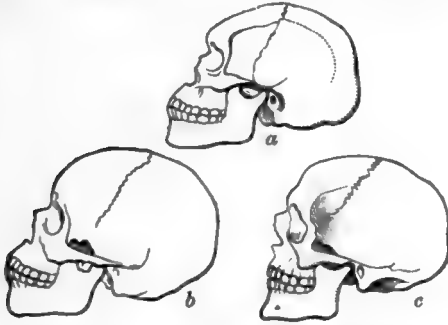

Fig. 6.—Lateral View of three typical Skulls: a, Australian, prognathous; b, African, mesognathous; c, European, orthognathous. (After Tylor.)

the *gnathic index* of Flower, and is obtained by comparing the basi-alveolar length with the basi-nasal length. When the gnathic index is below 98, skulls are said to be *orthognathous*; from 98 to 103, *mesognathous*; above 103, *prognathous*—e.g.:

	Gnathic Index.
English	96
Chinese	99
Eskimo	101
Fiji Islanders	103
Native Australians (aboriginal)	104

(e) The form of the *nasal skeleton* and its *anterior openings* is also subject to variation, and so its height and width may be measured, and the relation between the two expressed as a *nasal index*.

Nasal index below 48 = leptorhine.
 " from 48 to 53 = mesorhine.
 " above 53 = platyrhine.

For example:

	Nasal Index.
Eskimo	44
English	46
Chinese	50
Native Australians (aboriginal)	57

In a similar way the form of the orbit is subject to variation, but this is of less consequence than the nose. Other measurements of the face skeleton are also made. A time-honoured measurement, long thought to be sufficient in itself for founding a classification of races, was the *Facial Angle* of the Dutch anatomist Peter Camper (q.v., 1722-89). This was obtained by drawing one line from the centre of the forehead to the most projecting part of the upper jaw just above the incisor teeth, and another from the opening of the ear to the base of the nasal opening; between these was contained the facial angle.

For the relation of craniometry to the science of man, see ETHNOLOGY and works there cited. See also the articles ANTHROPOMETRY, ANTHROPOID APES, BRAIN, MAMMALS, MAN, PHRENOLOGY, SKELETON, VERTEBRATA; Huxley's *Croonian Lecture* (1858); Huxley's *Anat. of Verteb. Animals* (1871); Parker's *Morphology of the Skull* (1877); and for summary, Balfour's *Embryology* (vol. ii.); Broca, *Instructions Craniologiques et Craniométriques*; Flower, *Cat. of Mus. of Roy. Coll. Surg. of Eng.* (part i. 1873-79); Turner, *Challenger Reports, Zoology*, x. (1888); Schmidt, *Anthropologische Methoden* (1888); Benedikt, *Kraniometrie und Kephalometrie* (1888). For the illustrative tables in this article we are indebted to the summary in Quain's *Anatomy* (10th ed.).

Skunk (*Mephitis*), a genus of small carnivorous quadrupeds of the family Mustelidæ. The body is elongated, and usually much arched; the tail long, and thickly covered with long, fine hair; the head small, with thick, blunt snout; the legs short, and the paws comparatively large, with five incompletely divided toes. The general colour is black and white. The power, characteristic in some degree of all the Mustelidæ, of forcibly discharging the fetid secretion of the Anal Glands (q.v.) is in the skunks enormously developed. All the species are American, and, as they differ little in habit, the Common Skunk (*M. mephitis*) may be taken as typical of the whole genus. The common skunk—an animal about the size of a cat—has fur of a glossy black; on the forehead is a patch of white diverging into two lines which extend the whole length of the back and meet again in the beautiful bushy tail. The under surface of the tail is also white, and, as it is usually carried erect or laid over against the body, the white is regarded by some naturalists as a 'warning colour.' Thus Mr Belt writes: 'The skunk goes leisurely along, holding up his white tail as a danger-flag for none to come within range of its nauseous artillery.' The common skunk is found throughout North America, but is most abundant in the Hudson Bay region. It chiefly frequents high-lying, bushy, or even rocky districts and the banks of rivers, remaining concealed in its burrow by day, but emerging at dusk in search of the worms, insects, birds, and small mammals which form its food. Its movements are slow and leisurely. It never attempts to run away if pursued, for, feeble and defenceless as it looks, it is



Common Skunk (*Mephitis mephitis*).

most efficiently protected by the possession of a nauseous fluid, the discharge of which neither man nor beast will wittingly provoke. Should an unwary intruder venture too near, the skunk turns its back, erects its tail, and, by means of a muscular contraction, ejects the contents of its anal pouches with a force which carries them to a distance of from 8 to 10 feet. So penetrating is the evil odour of this fluid that it is perceptible a mile off, and has been known to cause nausea in persons within a house with closed doors from which the animal was a hundred yards distant; and so persistent is it that clothes defiled by it can only be purified by prolonged hanging in smoke. It is said that the fluid has irritating properties which excite severe inflammation of the eyes, and cases are cited of Indians who have thus lost their eyesight. The skunk is hunted for its fur, which is in considerable demand; but the hunter must be careful to avoid alarming the animal, and thus causing it to discharge its obnoxious fluid. Skunks usually raise from six to ten young in a season. If taken young they are easily tamed and make pretty pets, for they are cleanly in habit and rarely emit their offensive secretion save when provoked. The Long-tailed Skunk (*M. macrura*) is found in central and south Mexico, and a much smaller species (*M. putorius*), with four white stripes, ranges from the southern states to Yucatan and Guatemala.

Skupsh'tina (often spelt *Skuptchina*), the northern assembly of the Servians. See *SERVIA*.

Sky. See *ATMOSPHERE, CLOUDS, DUST, and METEOROLOGY*.

Skye, an island of Inverness-shire, the second largest of the Hebrides, is separated from the mainland by a channel $\frac{1}{2}$ mile wide at the narrowest, Kyle Rhea. Its extreme length, south-south-eastward, is 49 miles; and its breadth varies from 7 to 25 miles; but on account of the extraordinary number of inlets at all parts of the island no point is above 4 miles from the sea. Area, 643 sq. m.; pop. (1841) 23,082; (1861) 18,908; (1881) 16,889; (1891) 15,700. Skye is for the most part mountainous and moory, but it contains some pleasant tracts of arable and pasture land, and one considerable plain, formerly the bed of a lake, in the parish of Kilmuir, where some ruins of a religious house called after St Columba were found. The rocks are mainly volcanic of Tertiary age; and the principal mountains are the Coolin Hills (not Cuchullin), which stretch irregularly from south-west to north-east, terminating in the sharp peak of Sgurr-nan-Gillean (3167 feet) above Sligachan. Another peak, Sgurr Dearg, has been found to be the highest of the range (3234 feet), but Sgurr-nan-Gillean will still be regarded as the chief of the Coolin Hills. The serrated outline of these hills arrests the eye at a great distance, and forms the dominant feature in the view at almost every point round the island, and far out at sea. The most famous scene in this region is Coruisk ($1\frac{1}{2} \times \frac{1}{2}$ mile), the 'stern, dread lake' of Scott's *Lord of the Isles*. Glen Sligachan, ascending $5\frac{1}{2}$ miles from the head of Loch Sligachan, is by many considered the grandest glen in the Highlands. The fantastic Quiraing (1779 feet) and the Storr (2360), in the north of the island, offer splendid scenery, as also do many points along the coast—here columnar basalt formations on a grand scale, and there cliffs 1000 feet high, over which leap many waterfalls, and whose bases are frequently worn into deep caves, some of them of historical interest. One, near Portree, afforded a refuge to Prince Charles Edward; another, on the west coast, was the temporary prison of Lady Grange. The largest arms of the sea are Lochs Bracadale, Dunvegan, and Snizort.

The coasts abound in fish, the most important being herring, salmon, cod, and ling; besides oysters are found in several places. The cod and ling fishery is chiefly confined to Lochs Dunvegan and Snizort. There are no rivers of any magnitude; but salmon and sea-trout are got in some of the principal streams, and trout in most of the fresh-water lochs. Deer are not numerous, nor grouse. West Highland cattle are reared to a considerable extent, but sheep-farming on a large scale predominates. The rainfall averages 65 inches, but the climate is mild and healthy. Agriculture in Skye, being comparatively unprofitable, owing to the moisture of the climate, is falling into entire neglect on some of the chief sheep-farms. The soil, however, is in many places excellent, and capable, in dry seasons, of yielding good cereal crops, while for turnips it is peculiarly suited.

The inhabitants are for the most part poor and ill-housed, but well-behaved and intelligent. At one time they contributed largely to the British army—not less than 10,000 private soldiers, it has been calculated, during the long war with France. The number of soldiers now sent from Skye is very small. In the districts where the men practise fishing nearly the whole of the adult males go to the east coast fisheries in summer, while from all parts of the island young men and women go to the south in search of field-labour. Potatoes and fish are the general diet, meat being a rare luxury.

The population is chiefly Celtic, with, however, a considerable Norse admixture. Gaelic is still universally spoken, but is gradually giving place to English. The chief proprietors are still, as of old, Lord Macdonald, whose seat, Armadale Castle in Sleat, is one of the most beautiful in all its surroundings to be seen on the Scottish coasts, and MacLeod of MacLeod, in whose ancient castle of Dunvegan, perched on a headland, Dr Johnson 'tasted lotus' (1773) and Scott slept in the 'Fairy Room' (1814). The principal port of Skye is Portree, a picturesquely situated village of 750 inhabitants, to which steamers regularly ply from Glasgow, and also from Stromeferry, in connection with the Skye Railway thence to Inverness. Other villages, also calling-points of the steamers, are Kyleakin ('Hakon's strait'), Broadford, and Dunvegan. The celebrated whisky generally known as 'Talisker' is made at the distillery of Carabost, at the head of Loch Bracadale. The inhabitants are nearly all Presbyterians, and chiefly adherents of the Free Church.

See Alexander Smith's *Summer in Skye* (1865), and Robert Buchanan's *Hebrid Isles* (1883).

Skye Terrier, a breed of dogs supposed to be the outcome of a cross between the native dog of Skye and a Maltese terrier, landed from a passing ship—a statement difficult to believe and impossible to prove. Though long known in Scotland, where he was in some places used as a working terrier, it is only of late years that the Skye terrier has



Skye Terrier.

become common over the whole of England. The chief beauty of the Skye is its long and graceful coat, which requires so much attention that it is better suited for a town life than a country one. In its proper place, the Skye is a bright and cheerful companion. The modern Skye should be very low at the shoulder, not above 9 or 10 inches high, with as long a body as possible; many good specimens measure 40 inches from nose to tip of tail. The coat should be very long and abundant, nearly touching the ground, but hanging quite straight, without any curl. Colour varies from a dark blue to a light gray. The weight should be about 20 lb. The Skye terrier is divided into two varieties, Prick-eared and Drop-eared. Though many admirers claim working properties for the Skye, as now bred, it should only be regarded as an ornamental dog. The Paisley or Clydesdale terrier, a variety of terrier brought into notice within the last few years, is a Skye with a light-coloured and silky coat, and is kept entirely as a house-dog.

Skyros, or **SCYRO**, an island of the Grecian Archipelago, the largest of the northern Sporades, 24 miles N.E. of Eubœa. Length, 17 miles; area,

79 sq. m. Skyros is very mountainous in the south, the mountains being covered with forests of oaks, firs, and beeches; but the northern part, though also hilly, has several fertile plains, which produce fine wheat and grapes for wine. The only town is Skyro, or St George, on the east coast. This island is associated with the legends of Achilles and Theseus. In 469 B.C. Cimon the Athenian conquered it and carried off to his native city the bones of the hero Theseus. It was likewise celebrated for its goats and its variegated marble. Pop. 3250.

Slade, FELIX (1789-1868), of Halsteads, Yorkshire, was an antiquary and art collector, and bequeathed to the British Museum his valuable collections of engravings and of Venetian glass. He also left by will money to found art professorships at Oxford, Cambridge, and at University College, London. Amongst Slade professors have been Ruskin, Sidney Colvin, and W. B. Richmond.

Slags, sometimes called Scorixæ, are fused compounds of silica with lime, alumina, and other substances. Blast-furnace slag is usually little else than a silicate of lime and alumina. In smelting processes the slag floats on the top of the molten metal, and is run off or raked off as 'waste material,' provided that the metal has been practically all extracted from it. Many slags which were thrown away in early times have been profitably smelted again in modern days, owing to the amount of metal left in them. Some slags form an opaque glass, but other varieties are more stone-like in appearance, while some are beautifully crystallised. In Great Britain about 18,000,000 tons of iron blast-furnace slag are annually produced. Until comparatively recent times this was considered useless material, but it is now utilised in several ways. By the action of steam upon it in the melted state it is made into fine threads or filaments called 'slag wool' or 'silicate cotton.' This is a bad conductor of heat and sound, and is used as a covering to boilers, and to prevent sound passing through floors. It is also employed for fireproof netting. In some cases blast-furnace slag has been made into serviceable bricks and large blocks for building, as well as into paving setts. On the Continent a useful building cement, or substitute for mortar, has been made from it. The slag from the manufacture of steel from Cleveland pig-iron by the basic process contains about 17 per cent. of phosphoric acid, and forms a valuable fertiliser for sour, peaty, and clay soils.

Slander is an injury to a person's character and reputation caused by spoken words. It is to be noticed that oral unlike written defamation is only actionable (1) on proof of actual, or, as it is technically termed, special damage; (2) in the following specific cases: (a) statement that the plaintiff has committed a criminal offence, (b) an assertion that he is suffering from an unclean and contagious disease, (c) defamatory words spoken in the way of his business or profession. To impute unchastity to a woman was not in itself actionable unless (it is said) the words were spoken in London, when by the custom of the city an action would lie thereon; but the Slander of Women Act (1891) makes the mere imputation a ground of procedure. The remedy for slander is an action at law for damages. To prove the truth of the alleged slander is a complete answer, and the defence of privilege may also be set up. The criminal law affords no protection against slander, nor will any 'indictment lie for mere words not reduced into writing, unless they be seditious, blasphemous, grossly immoral, or uttered to a magistrate in the execution of his office, or uttered as a challenge to fight a duel, or with an intention

to provoke the other party to send a challenge.' This radical distinction between written and spoken defamation is not recognised in Scots law. See LIBEL.

Slang, a term in regard to the usual meaning of which the best authorities differ widely. It is defined by Webster as 'low, vulgar, unauthorised language;' by Skeates 'low, vulgar language or

Copyright 1892, 1897, and 1906 in the U. S. by J. B. Lippincott Company.

a colloquial and familiar mode of expression;' by the *Globe Encyclopædia* as 'the secret jargon of thieves and vagabonds, otherwise known as Cant or Flash;' and by Wedgwood as 'to give bad words, to make insulting allusions.' But any large collection of words universally recognised as *slang* embraces not only vulgar, abusive, familiar, and classically unrecognised terms, as well as those of peculiar jargons or dialects, such as Gypsy, Canting or Flash, Back-slang, and Shelta or Tinkers' Talk, but also a vast number characteristic of trades, pursuits, and positions in every class of society; so that we may agree with Professor A. Barrère, that perhaps the best general definition at which one can arrive is that 'Slang is a conventional tongue with many dialects, which are, as a rule, unintelligible to outsiders.' This confusion of definitions appears to be due to the fact that the word is derived from two sources, each with a separate meaning. According to the generally received popular tradition, which is supported by the Gypsies themselves, and recognised as such by J. C. Hotten (*Slang Dictionary*, 1885), *Slang* is a Romany or Gypsy word. It was originally applied to everything relating to theatres or shows—in Hindustani *Swangi*, also, often, *slangi*. The peculiar jargon or tongue spoken among such show-people, also stage or theatrical language itself, doubtless gave rise to 'slang.' It is also applied as a means of expression by these people to 'licenses to exhibit,' while to be 'on the slang' signifies in circus-dialect to be in any way connected with 'the profession.' Slang in this sense means therefore a peculiar or secret language. But as a term of abuse, as in 'slanging' or 'slang-whanging' a man, Skeat properly derives it from the Norwegian *sleng*, a 'slinging or throwing;' hence *slengja kjeften*, 'to sling the jaw;' *slengjeord*, a 'slang or abusive word.' Thieves' slang, or a jargon deliberately intended to protect criminals, is known in India as *bhat*, hence the Gypsy *pat*, or *patter*, erroneously derived by mere conjecture from *pateroster*. In its extended sense it is difficult to draw the line between technical terms—as for instance those used on the turf or in sport—and *slang*, especially when equivalents for them are wanting in correct English. Any kind of shibboleth used to distinguish a class, be it of students, clergymen, authors, or the most fashionable circles, is correctly called *slang*, and is recognised as such in the best and last works on the subject.

The chief elements of all slang consist first of absolutely foreign words, including those manufactured; as when a costermonger says 'molty kerteever,' from the Ital. *molto cattivo*, for 'very bad,' or a street-vagabond uses the Romany *lelled* ('taken'), for 'arrested.' The other is the substitution of English words for equivalents, as when we hear 'brass' for impudence, 'timbers' and 'pins' for legs, 'claret' for blood, and 'tile' for a hat. Thus it is often in a rough form simile or poetry; 'brass' being indeed of classical origin as applied to the hardness which defies attack. 'A certain proportion of slang words after performing, as it were, quarantine, receive a clean bill of health, and are admitted to that great port the dictionary.' Some even make a reappearance in good language. Thus *humbug*, which meant originally a night-terror or delusion (*Hum*, 'tenebrae,'

Icelandic, and *Bug*, 'a being which terrifies'), was long treated as pure slang, but is now generally used even by the most correct writers in its new meaning. Very little slang in the vulgar or common sense is to be found in Greek or Latin (though Aristophanes and Martial often approach it), or in any European language until the middle ages. François Villon (15th century) wrote ballads in an *argot* which was by far the most copious and perfected in Europe; a century later Martin Luther compiled a dictionary of *Rotwälsch* (*wälsch*, 'foreign' or 'Italian'; *rot* being either from *roth*, 'red,' or *rotte*, 'a gang'), used by the thieves of his time, in which half the words are Hebrew, derived from the receivers of stolen goods and their *Yiddish* dialect. In Italy there was at the same time a *lingua furbesche*, of which a vocabulary has been published; and in Spain the *Tunanesesca* which was largely mixed with Spanish Gypsy, itself a very much corrupted Romany. English Canting, or the language of the dangerous and vagabond classes, which in a great measure preceded all other forms of slang, did not before the end of the 15th century embrace more than 150 or 200 words. But as C. J. R. Turner has suggested, it was the arrival of the Gypsies in England about 1505, speaking by themselves a perfect language, which stimulated the English nomads to improve their own scanty jargon. According to Samuel Rowlande (1610), a man named Cock Lorell, who was the head of all the strollers or thieves in England, observing that the Gypsies were a strong race, proposed union with them, the result being a congress, 'at which a language, or rather language, was deliberately constructed and adopted' (Leland). 'First of all they think it fit to devise a certain kinde of Language to the End that their cousenings, knaueries, and villainies might not be so easily perceived' (Rowlande). The Gypsies, true to their nature, cheated the English vagabonds by teaching them very little of their own Indian tongue. Harman, a magistrate who in 1567 first published a vocabulary of Slang or Canting, declares explicitly that it was only within thirty years of his time of writing that the dangerous classes had begun in England to use a separate language at all.

The Gypsy language, or Romany, has been greatly misunderstood. It is really an Indian tongue, a dialect of Urdu, or Hindustani, but very ancient. A number of writers, such as Grose, the author of the *Life of B. M. Carew*, and others, have, misled by Rowlande, published vocabularies of canting as 'Gypsy.' Romany is, however, the corner-stone of English slang. It has constantly contributed new words to the latter—e.g. *tanner*, 'a sixpence,' not from *tāno*, 'small,' as Borrow declares, but from the Hindu *taino*, 'a coin;' and *bosh*, 'mere noise, nonsense.' A second element is the Celtic, which has come chiefly not so much from any of the leading dialects, such as Irish, Gaelic, or Welsh, as from *Shelta*, a language first discovered by the present writer in 1876, and which has since been identified by Kuno Meyer and Sampson with the artificial—or lost—language of the Irish bards. It is still generally spoken by tinkers, and is common even in London. From it we have *mizzle*, meaning 'to go,' or 'to rain' (*mislain*). The writer once met in the street in London two small English boys, who spoke fluently both Romany and Shelta. Shakespeare, it should be noted, makes Prince Hal speak of a tinker's language. *Yiddish* (Ger. *Jüdisch*, 'Jewish') is a strange compound of very corrupt Hebrew and ancient or provincial German, spoken by the commoner Jews. About a century ago a few words from it, such as *toff*, 'good,' began to creep into our slang. It is extensively spoken

in the East End of London, and is constantly contributing new words to our popular phraseology. It is in Germany a language of some importance, as the 'Yiddish Chrestomathy' (Leip. 1882) of Max Grünbaum proves, and there are in all about twelve vocabularies of it. There were at one time two newspapers in London alone published in Yiddish. Hotten was the first to show and illustrate the curious fact that among street-musicians and costermongers a very corrupt and singular form of Anglo-Italian had become current. Still more strangely, it has come to be considered by tramps as the lowest and most vulgar means of expression. The keeper of a tramps' lodging-house after hearing a Cambridge professor speak Gypsy and Tinkers' Slang made no remark, but hearing him speak Italian said, 'Well, I'd never a-supposed you'd been down as low as *that*.' It occasionally happens that a word in the former corresponds exactly to a Gypsy term—e.g. *bosh*, 'a noise,' 'a nonsense,' *pani*, 'water,' *chor*, 'a thief.'

The Dutch language during the time of the Georges contributed a great many words, such as *boefer*, 'a buffer;' *blink*, 'to drink.' In America a still greater number was derived from this source (e.g. sleigh, from *sle*), which have since come over to England. Some confusion has resulted from the fact that owing to its great resemblance to other northern languages philologists have often thought they had discovered in English slang words of Saxon or Danish origin which were really Dutch, and often Dutch slang. There still remains much to be done as regards investigation in this field. About the beginning of the 19th century, when there was much attention paid to such subjects, and many 'fast' or fashionable men affected to be familiar with vulgar life, there sprang up, it is said, about Leadenhall in London, and bearing that name, that which was afterwards known as Back-slang. This consisted of words spelled backwards, such as *top* for *pot*, *yennep* for *penny*, *nig* for *gin*. It has been dying out rapidly of late years, but was at one time extensively spoken in *Nodnol* or London. Many traces of it are to be found in the gay novels and memoirs of the 'Thirties' and 'Forties.' Contemporary with it as regards time of origin is rhyming slang—i.e. the employment of a word which loses its own signification, taking that of another with which it rhymes. Thus *Lord John Russell* means *bustle*, a canting term meaning to pick pockets, also money. Romany or Gypsy, Shelta or Tinkers' Talk, Canting or Kennick, also known at one time as *Flash* or *Thieves' Latin*, and confused even by a modern Oxford professor with Gypsy, form the principal English slangs. All have their dialects or local differences. Thus, the Shelta heard in tramps' London lodging-houses is a very much corrupted form of that which is spoken in Scotland. Slang may consist of mere intonation or pronunciation: thus, Hotten gives the use of 'Gawd,' or 'Gorde,' for God, and similar errors by certain clergymen as pulpit slang. There are in America preachers who carry this to such an extent that they have almost formed a language of their own in this way; and a certain bishop was once declared to be in the habit of saying in the pulpit: 'He that hath *yaws* to *yaw*, let him *yaw*,' while in ordinary life he ejaculated plainly enough: 'He that hath *ears* to *hear*, let him *hear*!' Hotten also declares that the peculiar *mispronunciation* of certain names, especially in good society, such as Cooper for Cowper, Carey for Carew, Chumley for Cholmondeley, Sinjen for Saint John, is an anomaly which must correctly be regarded as fashionable slang. The misuse of certain French terms is also slang, which is, however returned a hundredfold by the rather recent

adoption and abuse of English words by Parisians, who, for example, believing that *five o'clock* means to drink tea, have formed the remarkable slang verb *fivecloquer*, and even say *Fivecloquons-nous à quatre heures!* Parliamentary, military, sporting, legal and literary, stage, showmen's, shopkeepers, and stock-exchange slang, and that of different callings or trades are all extremely interesting, since there is not one that has not many very old words, often of Norse or Celtic origin, which have not as yet been much investigated. By far the most prolific source of slang of late years has been the American. This has for a 'stem' obsolete English and provincial terms which have been retained chiefly in New England and the West, and which are really not slang, though so called. To these may be added words of German, Dutch, Canadian, French, Red Indian, Negro, and Spanish origin. But by far the most amusing part of Americanisms are the constantly improvised proverbs, sayings, and quaint allusions, eccentric oaths and condensed anecdotes, which, when thrown off in conversation, soon find their way into a newspaper.

The principal works on this subject are Harman's *Caveat for Common Corsetors, vulgarly called Vagabones* (1566); the *Life of Bamfylde Moore Carew* (no date), containing a vocabulary of Canting, miscalled Gypsy; Grose's *Dictionary of the Vulgar Tongue* (1785); *Bacchus and Venus* (1737), with a canting vocabulary, republished as the *Scoundrels' Dictionary*. (This dictionary is said to have appeared by itself in 1710 as *A Dictionary of the Canting Crew*.) The first work of any value on this subject in which slang was treated in its true sense was the *Slang Dictionary* of John Camden Hotten (1859). Its editor unfortunately had no knowledge of Romany, and the existence of Shelta or Tinkers' talk was not known to him. *A Dictionary of Slang, Jargon, and Cant*, by Professor A. Barrère and Charles Godfrey Leland, contains Americanisms, Gypsy, Shelta, Pidgin English, Anglo-Indian, and other terms, with a history of English Slang (2 vols. Lond. 1885; new ed. 1897). *Slang and its Analogues*, by John Farmer (Lond. 1890 *et seq.*), contains synonyms in the principal modern languages. American slang: see the article AMERICANISMS; John R. Bartlett, *Dictionary of Americanisms* (New York, 1848, and Cambridge, Mass., 1877); J. S. Farmer, *Americanisms, Old and New* (privately printed; Lond. 1888); *Americana*, by Charles Godfrey Leland. Gypsy: see works of George Borrow, *Lavengro, Romany Rye, &c.*, and *Dialect of the English Gypsies*, by Dr Bath Smart and Crofton (1863-88). See also the articles GYPSIES and SHELTA, with works there cited. Anglo-Indian: Sir Henry Yule and A. Brunell, *Glossary of Anglo-Indian Colloquial Words and Phrases* (1886). French Slang: Barrère, *Argot and Slang* (Lond. 1887); and the French works of Larchey (1880), Rigaud (1881), Delvau (1883), and Vitù (1890). German Slang: Avé-Lallemant, *Deutsches Gaunerthum* (1862); Genthe, *Deutsches Slang* (1892). Pidgin English: *Pidgin English Ballads*, with vocabulary of the Jargon, by Charles G. Leland (1886).

Slate, or CLAY-SLATE (Fr. *esclat*, a 'shiver' or 'splinter'), is a highly metamorphosed argillaceous rock, fine-grained and fissile, and of a dull blue, gray, purple, or green colour. A red slate is found at Acton, Quebec. Slate splits into thin laminae or plates, that are altogether independent of the layers of deposit; though sometimes coinciding with them, they more frequently cross them at different angles (see CLEAVAGE). Some rocks that split into the thin plates of the original stratification are popularly but erroneously named slate, as thin bedded sandstones properly called flagstones or tilestones, sometimes used for roofing. True slate is a very compact rock, little liable to be acted upon by atmospheric agencies. It is chiefly obtained from Palaeozoic strata, but it is found also among more recent rocks. It is used for various purposes, being split into thin slabs of small size for ordinary roofs and into larger slabs for dairy fittings, wash-tubs, cisterns, tables, &c.,

and, when polished, for writing-slates and 'black-boards.' School slates are manufactured in very large numbers in Wales. They are split, like roofing slates, by hand; but the sawing, grinding, and polishing processes are done by machinery: the making of the wood frames for them being also done by machines. Recently slate has been used in the United States for coffins, and there and elsewhere it has for some time past been cut into gravestones, for which it is not very suitable. There are extensive quarries of roofing-slate in Wales and Scotland, and in the Ardennes in France, some of which have been wrought for a long time. For some years previous to 1891 the average annual quantity of slates quarried or mined in England and Wales amounted to about 450,000 tons (value one million sterling), Carnarvonshire and Merionethshire furnishing nine-tenths of the whole; and among the great slate-quarries there may be mentioned those of Penrhyn (near Bethesda), Llanberis, and Festiniog. Considerable but much smaller quantities are produced in Argyllshire in Scotland and in some counties in Munster, Ireland. Welsh slates are largely exported to Germany and Australia. In the United States not far from one-half of all the slates produced are quarried in Pennsylvania, but Vermont, Maine, New York, Maryland, and Virginia also yield large quantities. Slate is known to be plentiful in Arkansas, California, Utah, and in Canada. The annual value of the slates quarried in the States is over £700,000 (£717,690 in 1889). The debris of slate-quarries is made into bricks. 'Enamelled slate' mantelpieces are made of slate painted and stoved.

In roofing with slates it is necessary to put them on in two thicknesses, so that the sloping joints may be covered by the overlap of the course above. Besides this, the third course must also cover the first by an inch or two, to prevent rain from penetrating. Slates are generally laid upon boarding, and bedded in lime, and nailed with malleable-iron nails, galvanised, so as to prevent them from rusting. When large strong slates are used they may be nailed to strong laths in place of boarding. Welsh slates are the smoothest and most generally used; but Argyllshire slates are stronger and better when the roofs are liable to be injured. See D. C. Davies, *Slate and Slate-quarrying* (3d ed. 1887).

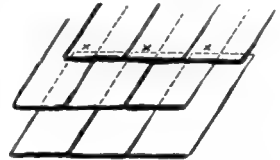

Slate-pencils are either cut or turned sticks of soft slate, or they are made by pressing moistened slate powder until it is firm enough to be made into pencils.

Slaughter-houses, or ABATTOIRS, premises in which cattle are slaughtered and prepared for human food. In modern Europe France took the lead in attending to this important matter; a commission appointed by Napoleon issued in the construction in 1818 of the five Parisian abattoirs, which served as the model to other towns and countries. London cannot be said to have followed suit till the Islington market was opened in 1855. Edinburgh has had a well-appointed abattoir since 1851; and in the United States many cities have provided carefully for this important public necessity. Sanitary authorities are agreed that the establishment of a public abattoir under proper supervision tends to ensure the supply of wholesome meat, but neither the English Public Health Act of 1867 nor the Local Government Act, 1889, gives powers to erect or maintain such premises. A number of

towns, however, have secured the authority by local bills. Buildings for this purpose should be removed from the vicinity of habitations and should be substantially built. The walls should be tiled or cemented, or otherwise rendered impervious to moisture, for a height of at least 6 feet. Wood-work should be avoided as much as possible consistent with convenience, and what there is should be well painted and frequently washed. To prevent absorption of the fluids and subsequent decomposition, the floor should be composed of roughened cement sloping to a channel. In large slaughter-houses the blood is usually contracted for, and is collected in metal pails and afterwards treated for the manufacture of blood albumen, the residue being dried for manure. Offal should be at once removed from the actual slaughtering-house, and a separate building provided for the washing and preparing of tripe.

Slave-coast, a division of the coast of Upper Guinea, Africa, extending eastwards from the Gold Coast (q.v.) as far as the river Benin, is divided between Germany, Dahomey, France, and Great Britain. The British portion is treated of under Lagos (q.v.), the German under Togo (q.v.), and the French under Senegambia (q.v.).

Slavery, in the fullest sense of the term, implies that the slave is the property or at the disposal of another, who has a right to employ or treat him as he pleases; but the system has been subjected to innumerable limitations and modifications. Slavery probably arose at an early period of the world's history out of the accident of capture in war. Savages, in place of massacring their captives, found it more profitable to keep them in servitude. All the ancient oriental nations of whom we have any records, including the Jews, had their slaves. The Hebrews were authorised by their law to possess slaves, not only of other races, but of their own nation. The latter were generally insolvent debtors who had sold themselves through poverty or thieves who lacked the means of making restitution; and the law dealt with them far more leniently than with stranger slaves. They might be redeemed, and if not redeemed became free in the space of seven years from the beginning of their servitude; besides which there was every fiftieth year a general emancipation of native slaves.

Greek Slavery.—In the Homeric poems slavery is the ordinary destiny of prisoners of war; and the practice of kidnapping slaves is also recognised—Ulysses himself narrowly escaping a fate of this kind. None of the Greek philosophers considered the condition of slavery objectionable on the score of morals. Aristotle defends its justice on the ground of a diversity of race, dividing mankind into the free and the slaves by nature; while Plato only desires that no Greeks should be made slaves. One class of Greek slaves were the descendants of an earlier and conquered race of inhabitants, who cultivated the land which their masters had appropriated, paid rent for it, and attended their masters in war. Such were the Helots in Sparta, the Penestæ in Thessaly, the Bithynians at Byzantium, &c., who were more favourably dealt with than other slaves, their condition somewhat resembling that of the serfs of the middle ages. They could not be sold out of the country or separated from their families, and were even capable of acquiring property. Slaves obtained by purchase were the unrestricted property of their owners, who could dispose of them at pleasure. In Athens, Corinth, and the other commercial states they were very numerous, and were mostly barbarians. They were employed partly in domestic service (some being *pædagogoi*, employed to accom-

pany the boys to school, &c.), but more as bakers, cooks, tailors, or in other trades, in mines and manufactories, as labourers on country estates, and as seamen and oarsmen; and their labour was the means by which the owner obtained profit for his outlay in their purchase. These slaves were for the most part purchased; but many were born in their master's family. The Athenian state employed public slaves as police, as soldiers, public criers, gaolers, &c. An extensive traffic in slaves was carried on by the Greek colonists in Asia Minor with the interior of Asia; another source of supply arose from the practice common among Thracian parents of selling their children. In Greece in general, and especially at Athens, slaves were mildly treated, and enjoyed a large share of legal protection. According to Demosthenes, a slave at Athens was better off than a free citizen in many other countries. Manumissions were frequent. A master could obtain damages if a slave was maltreated. The slave was not allowed to wear his hair long, was prevented from entering the gymnasia and public assemblies, but had access to temples and festivals. In the palmy days of the Athenian state there were, according to Wallon, 200,000 slaves in Attica; about three times the number of freemen!

Roman Slavery differed in some particulars from that of Greece. All men were considered by the Roman jurists to be free by natural law; while slavery was regarded as a state contrary to natural law, but agreeable to the law of nations, when a captive was preserved, instead of being slain (the name was believed on doubtful etymological grounds to be '*servus*, quasi *servatus*'); or agreeable to the civil law, when a free man sold himself. In earlier times there was no restriction on the master's power of punishing or putting to death his slave, which was generally carried out by crucifixion; and even at a later period, when the law on this head was much modified, slaves were used with great rigour. The estimation in which their lives were held is illustrated by the gladiatorial combats. Old and useless slaves were often exposed to starve in an island of the Tiber. Under Spartacus (q.v.) a rebellion of slaves attained alarming dimensions. In the time of the empire the cruelty of masters was in some degree restrained by law. It was enacted that a man who put to death his own slave without cause should be dealt with as if the slave had been the property of another; and that if the cruelty of the master was intolerable he might be compelled to sell the slave. Slaves could contract a kind of marriage called *Contubernium*; and ultimately this relation was regarded as indissoluble. The children of a female slave followed the status of their mother. There were various ways in which a slave might be manumitted, but the power of manumission was restricted by law. The harbouring of a runaway slave was illegal. The number of slaves in Rome, originally small, was increased much by war and commerce; and the cultivation of the soil came in the course of time to be entirely given up to them. During the later republic and empire persons in good circumstances kept an immense number of slaves as personal attendants; and the possession of a numerous retinue of domestic slaves was matter of ostentation—200 being no uncommon number for one person. A multitude of slaves were also occupied in the mechanical arts and the games of the amphitheatre. Originally a slave was incapable of acquiring property, all his acquisitions belonging to his master; but when slaves came to be employed in trade this condition was mitigated, and it became the practice to allow a slave to consider part of his gains, called his *peculium*, as his own, a stipulation

being sometimes made that he should purchase his freedom with his peculium when it amounted to a specific sum. Having no legal standing, a slave could not give evidence.

Though the introduction of Christianity did not do away with slavery, it tended to ameliorate the condition of the slave. The fathers taught that the true slavery is not that of the body, but the slavery of sin; and Chrysostom thought the apostle did not insist on the suppression of slavery because it was desirable that men should see how truly the slave could enjoy liberty of soul. Constantine allowed poor parents to sell their children into slavery. Justinian, though his Constitution (529 A.D.) drew a very sharp line between slaves and freemen, did something to promote the eventual extinction of slavery; the church excommunicated slave-owners who put their slaves to death without warrant from the judge. But it was not till the reign of Basil (867-886) that the slaves' *contubernium* was hallowed by the blessing of the church. The number of slaves again increased; multitudes being brought with them by the barbarian invaders, who were mostly Slavonic captives (whence our word *slave*); and in the countries which had been provinces of the empire slavery continued long after the empire had fallen to pieces. The doctrine of Von Maurer and Sir Henry Maine has till of late found almost universal acceptance—that the original bases of Germanic societies were Village Communities (q.v.) of freemen owning the land in common, and that slavery arose by degradation of this social condition. But the researches of Fustel de Coulanges and others tend to show that the evidence for Von Maurer's view is slender, and that probably the earliest state of landed property amongst the Teutonic tribes was manorial lordship with slavery as an adjunct. In Britain great numbers of the Celtic or other natives were enslaved by the Anglo-Saxons; and the Christian Anglo-Saxons had a regular trade with the Continent in Irish slaves, Bristol being a great slaving port. After the Norman Conquest slaves as in a separate class ceased to exist, and slavery eventually merged into the mitigated condition known as *serfdom*, which prevailed all over Europe in the middle ages, and has been gradually abolished in modern times. But though the practice of selling captives taken in war as slaves ceased in the Christian countries of Europe, a large traffic in slaves continued among Mohammedan nations, by whom Christian captives were sold in Asia and Africa; and in the early middle ages the Venetian merchants traded largely in slaves, whom they purchased on the coast of Slavonia, to supply the slave-markets of the Saracens. The history of the achievements of the Barbary corsairs is not to the glory of the Christian nations of Europe. These professional sea-robbers continued for centuries—down to 1812, indeed—to harry the coasts and the commerce of Europe, carrying large numbers of Christians into all but hopeless captivity. When Cervantes was for five years a slave he had about 25,000 fellow-captives in Algiers alone, some treated fairly well, some with great barbarity. Cervantes was ransomed for about £100; £30 or £40 was a more usual price. Another famous slave was St Vincent de Paul. The order of Trinitarians (q.v.) was founded in 1198 for the purpose of redeeming captives (especially French) out of the hands of the infidels, sometimes bringing away several hundreds at a time; and in the 18th century it was not unusual in English and Scottish churches to make collections for a like purpose (see *CORSAIR*, *GALLEY*). Christians sent to the galleys by their own or foreign authorities were worse off than domestic slaves. English convicts used to be transported to

what was practically slavery in His Majesty's Plantations (see *PRISONS*, Vol. VIII. p. 417); and convict labour is still a kind of judicial slavery for life or a term of years.

Serfdom—A numerous class of the population of Europe known as serfs or villeins were in a state of what was almost tantamount to slavery during the early middle ages. In some cases this serf population consisted of an earlier race, who had been subjugated by the conquerors; but there were also instances of persons from famine or other pressing cause selling themselves into slavery, or even surrendering themselves to churches and monasteries for the sake of the benefits to be derived from the prayers of their masters. Different as was the condition of the serf in different countries and at different periods, his position was on the whole much more favourable than that of the slave under the Roman law. He had certain acknowledged rights—and this was more particularly the case with the classes of serfs who were attached to the soil. In England, prior to the Norman Conquest, a large proportion of the population were in a servile position, either as domestic slaves or as cultivators of the land. The humblest was nearly a slave—the *theow*; the other the *Coort* (q.v.), an irremovable tiller of the ground. The powers of the master over his serf were very extensive, their principal limitations being that a master who killed his serf was bound to pay a fine to the king, and that a serf deprived of his eye or tooth by his master was entitled to his liberty. And English serfdom was always territorial rather than personal. After the Norman Conquest there were various names used for the serfs, who seem ultimately all to have been confounded in one class, though originally different. The *villein* (*villanus*) was the Anglo-Saxon *coort*; less favourably situated were the *bordarii*; but the Anglo-Saxon *theow* (the *servus*) was no longer part of the system of society. Other names in the Norman period were *rustici* and *nativi*. Soon the difference became at most one of degree; and *serf* and *villein* are used almost indiscriminately for the great group of non-freemen. They were incapable of enjoying anything like a complete right to property, inasmuch as it was held, in accordance with the principles of the Roman law, that whatever the slave acquired belonged to his lord, who might seize it at his pleasure. The master could transfer them to any other master with the land they tilled. They could not even buy their freedom; and they could not educate their sons for the church without the consent of the lord. If the villein ran away he could be pursued and carried back. But if his lord maltreated him he might have remedy in the king's court; and the law defended him fully against injury from strangers. His oath was accepted as evidence. He was often kindly used by his lord, and generally allowed to lay by his savings. He was free from military service, and had a powerful friend in the church. It used to be said that as distinguished from these *villeins regardant* there were also a distinctly lower class of *villeins in gross* who had no political rights, and might be sold away from the land as absolute chattels of the lords; but this is now denied on good evidence. By a peculiarity in the usages of Britain, the condition of a child as regards freedom or servitude followed the father, and not the mother, and therefore the bastards of female villeins might be free.

The abolition of serfdom in western Europe was a very gradual process, various causes having combined to bring it about. The church did not as such denounce the practice of keeping Christians in bondage; indeed, churches and monasteries were amongst the largest proprietors of serfs. But churchmen insisted on humane treatment and

practised manumission to a large extent. In the course of time usage greatly modified the rights and liabilities of the serf, whose position must have been considerably altered when we find him making stipulations regarding the amount of his services, and purchasing his own redemption. The towns afforded in more than one way a means of emancipation. A serf residing a year in a borough without challenge on the part of his lord became *ipso facto* a free man. The serf's condition improved gradually but steadily, until he had all the rights of a citizen save against his lord, who required from him the customary services in cultivating the lord's lands; and his hold on his land became a kind of definite tenure of villeinage. The Black Death (q.v.) checked the progress, but only for a time. But the serf's position became by custom more secure and more independent. Serfdom died out in England without any special enactment; yet it was not wholly extinct in the later half of the 16th century, for we find a commission issued in 1574 by Queen Elizabeth, to inquire into the lands and goods of all her bondsmen and bondswomen in the counties of Cornwall, Devon, Somerset, and Gloucester, in order to compound with them for their manumission, that they might enjoy all their lands and goods as freedmen. In a few rare instances liability to servile duties and payments in respect of lands seem to have continued down to the reign of Charles I. In Scotland as in England serfdom disappeared by insensible degrees; but a remarkable form of it continued to survive down to the closing years of the 18th century. Colliers and salters were bound by the law, independent of paction, on entering to a coal-work or salt-mine, to perpetual service there; and in case of sale or alienation of the ground on which the works were situated, the right to their services passed without any express grant to the purchaser. The sons of the collier and salter could follow no occupation but that of their father, and were not at liberty to seek for employment anywhere else than in the mines to which they had been attached by birth. Statutes 15 Geo. III. chap. 28 and 39 Geo. III. chap. 56 restored these classes of workmen to the rights of freemen and citizens, and abolished the last remnant of slavery in the British Islands.

In France, though a general edict of Louis X. in 1315 purported to enfranchise the serfs on the royal domain on payment of a composition, this measure seems never to have been carried into effect, and a limited sort of villeinage continued to exist in some places down to the Revolution. In Italy one great cause of the decline of villeinage was the necessity under which the cities and petty states found themselves of employing the peasant population for their defence, whom it became expedient to reward with enfranchisement. In the 11th and 12th centuries the number of serfs began to decrease, and villeinage seems no longer to have had an existence in Italy in the 15th century. Joseph II. abolished serfdom in Bohemia and Moravia in 1781, and in the German lands in 1782. Over a large portion of Germany the mass of the peasants had acquired their freedom before the end of the 13th century, but in some parts of the Prussian dominions a modified villeinage (*leibeigenschaft*) continued to exist until swept away by the reforms of Von Stein in the 19th century.

In Russia serfdom remained a part of the social system until 1861; see RUSSIA, pp. 44, 47.

Negro Slavery existed from the earliest times; the Carthaginians seem to have brought caravans of slaves from various parts of North Africa; but in this the negroes suffered no more than other contemporary barbarians. The negro slavery of modern times was a sequel to the discovery of America. Prior, however, to that event the negroes, like

other savage races, enslaved those captives in war whom they did not put to death, and a considerable trade in slaves from the coast of Guinea was carried on by the Arabs. The deportation of the Africans to the plantations and mines of the New World doubtless raised the value of the captive negro, and made slavery rather than death his common fate; while it may also have tempted the petty princes to make war on each other for the purpose of acquiring captives and selling them. The aborigines of America having proved too weak for the work required of them, the Portuguese, who possessed a large part of the African coast, began the importation of negroes, in which they were followed by the other colonisers of the New World. The first part of the New World in which negroes were extensively used was Hayti in St Domingo. The aboriginal population had at first been employed in the mines; but this sort of labour was found so fatal to their constitutions that Las Casas (q.v.), Bishop of Chiapa, the celebrated protector of the Indians, interceded with Charles for the substitution of African slaves as a stronger race. As early as the beginning of the 16th century a good many Africans were already in Hispaniola; the emperor accordingly in 1517 authorised a large importation of negroes from the establishments of the Portuguese on the coast of Guinea. Sir John Hawkins (q.v.) was the first Englishman who engaged in the traffic, in which his countrymen soon largely participated, England having exported no fewer than 300,000 slaves from Africa between the years 1680 and 1700; and between 1700 and 1786 imported 610,000 into Jamaica alone. At first the trade was in the hands of special companies, one of which long enjoyed the special right or *Assiento* (q.v.) from Spain of supplying slaves. Most of the English slaving ships belonged first to Bristol, and from 1730 onwards to Liverpool (q.v.). The slave-trade was attended with extreme inhumanity; the ships which transported the negroes from Africa to America were overcrowded to such an extent that a large proportion died in the passage; and the treatment of the slave after his arrival in the New World depended much on the character of his master. Legal restraints were, however, imposed in the various European settlements to protect the slaves from injury; in the British colonies courts were instituted to hear their complaints; their condition was to a certain extent ameliorated, and the flogging of women was prohibited. But while slavery was thus legalised in the British colonies, it was at the same time the law of England (as decided in 1772 by Lord Mansfield in the case of the negro Somerset, and less emphatically by other judges at earlier dates, without any actual statute on the subject) that as soon as a slave set his foot on English soil he became free; though, if he returned to his master's country, he could be reclaimed. Up till this date the contrary impression was the usual one, though public opinion was strongly setting against the custom of keeping slaves. In 1764 there were believed to be thousands of negro slaves in London; and advertisements of 'black boys' for sale were frequent, as also rewards offered for runaways. As late as November 1771 the *Birmingham Gazette* advertised the public sale of a negro boy, sound, healthy, and of a mild disposition.

Before the idea of emancipation was contemplated the efforts of the more humane portion of the public were directed towards the abolition of the traffic in slaves, mainly under the influence of a sense of Christian duty. In 1787 a society for the suppression of the slave-trade was formed in London, numbering Thomas Clarkson and Granville Sharp among its original members. The most active parliamentary leader in the cause was William

Wilberforce, and Zachary Macaulay was one of its most zealous friends. The Quakers were the only religious body who as such petitioned the House of Commons on the subject. Many not unkindly people defended slavery. Thus Boswell, who on this point opposed his master, speaking of 'so very important and necessary a branch of commercial interest,' says: 'To abolish a status which in all ages God has sanctioned and man has continued would not only be robbery to an innumerable class of our fellow-subjects, but it would be extreme cruelty to the African savages, a portion of whom it saves from massacre and introduces to a much happier life' (*Life of Johnson*, chap. xxxv.). In 1788 an order of the crown directed that an inquiry should be made by a committee of the Privy-council into the state of the slave-trade; and an act was passed to regulate the burden of slave-ships and otherwise diminish the horrors of the middle passage. A bill introduced by Wilberforce for putting an end to the further importation of slaves was lost in 1791, but in 1792 Wilberforce, supported by Pitt, carried a motion to gradually abolish the slave-trade. And it is noteworthy that the anti-Christian French convention, influenced by the teaching of Rousseau, decreed (4th February 1794) that slavery should be abolished throughout the French colonies, and all slaves admitted to the rights of French citizens. Meanwhile, conquest of the Dutch colonies having led to a great increase in the British slave-trade, an order in council in 1805 prohibited that traffic in the conquered colonies; and in the following year an act was passed forbidding British subjects to take part in it, either for the supply of the conquered colonies or of foreign possessions. In the same year a resolution moved by Fox for a total abolition next session was carried in the Commons, and, on Lord Granville's motion, adopted in the Lords; and the following year the general abolition bill, making all slave-trade illegal after 1st January 1808, was introduced by Lord Howick (afterwards Earl Grey) in the House of Commons, was carried in both Houses, and received the royal assent on 25th March 1807. British subjects, however, continued to carry on the trade under cover of the Spanish and Portuguese flags; the slave-ships were more crowded than ever, to reduce the chances of capture, and the negroes were not unfrequently thrown overboard on a pursuit. The pecuniary penalties of the act were discovered to be inadequate to put down a traffic so lucrative as to cover all losses by capture. Brougham therefore in 1811 introduced a bill, which was carried unanimously, making the slave-trade felony, punishable with fourteen years' transportation, or from three to five years' imprisonment with hard labour. An Act of 1824 declared it piracy, and, as such, a capital crime, if committed within the Admiralty jurisdiction; and the statute of 1837, mitigating the criminal code, left it punishable with transportation for life. The Anti-slavery Society practically established the colony of Sierra Leone in 1787 as a home for destitute negroes.

The United States of America abolished the slave-trade immediately after Great Britain (1808), and the same was in the course of time done by the South American republics of Venezuela, Chili, and Buenos Ayres, by Sweden, Denmark, Holland, and, during the Hundred Days after Napoleon's return from Elba, by France. Great Britain, at the peace, exerted her influence to induce other foreign powers to adopt a similar policy; and eventually nearly all the states of Europe have passed laws or entered into treaties prohibiting the traffic. The accession of Portugal and Spain to the principle of abolition was obtained by treaties of date 1815 and 1817; and by a convention concluded with Brazil in 1826 it was declared piratical for the subjects of that

country to be engaged in the slave-trade after 1830. By the conventions with France of 1831 and 1833, to which nearly all the maritime powers of Europe have since acceded, a mutual right of search was stipulated within certain seas, for the purpose of suppressing this traffic. The provisions of these treaties were further extended in 1841 by the Quintuple Treaty between the five great European powers, subsequently ratified by all of them except France. The Ashburton treaty of 1842 with the United States provided for the maintenance by each country of a squadron on the African coast; and in 1845 a joint co-operation of the naval forces of England and France was substituted for the mutual right of search.

The limitation of the supply of negroes naturally led, among other good results, to a greater attention on the part of the masters to the condition of their slaves. But the attention of British philanthropists was next directed towards doing away with slavery altogether in the colonies. Societies were formed with this end, an agitation was set on foot, and attempts were made, for some time without success, to press the subject of emancipation on the House of Commons. At length in 1833 a ministerial proposition for emancipation was introduced by Mr Stanley (Earl of Derby), then Colonial Secretary, and an emancipation bill passed both Houses, and obtained the royal assent 28th August 1833. This act, while it gave freedom to the slaves throughout all the British colonies, at the same time awarded an indemnification to the slave-owners of £20,000,000. Slavery was to cease on 1st August 1834; but the slaves were for a certain duration of time to be apprenticed labourers to their former owners. Objections being raised to the apprenticeship, its duration was shortened, and the complete enfranchisement took place in 1838. The serious decadence of trade and commerce in the British West Indies has been commonly attributed to emancipation; but though the change in the position of the negroes unquestionably contributed to the result, it is clear that before a slave had been manumitted by law the industry of Jamaica and the other islands had already begun to fall off.

The French emancipated their negroes in 1848; as did most of the new republics of South America at the time of their establishment; while the Dutch slaves had freedom conferred on them in 1863. In Hayti slavery ceased as far back as 1791, its abolition having been one of the results of the negro insurrection of that year. In Brazil (q.v.) slavery was not abolished until 1888.

The history of negro slavery in the United States is partly dealt with at Negroes (q.v.); the steps that hindered or prepared the way for its final abolition in 1862-65 are part of the history of the United States (q.v.), and are dealt with in such articles as ABOLITIONISTS, BROWN (JOHN), DRED SCOTT CASE, GARRISON, LINCOLN, MISSOURI (for the 'Missouri Compromise'), &c. Here it may be noted that in 1800 there were in the United States 893,041 slaves; that Vermont, Pennsylvania, Massachusetts, Rhode Island, Connecticut, New York, and New Jersey emancipated their slaves before 1840, most of them by gradual measures. The average value of slaves was about this period stated at \$600. The 3,953,760 slaves at the census of 1860 were in what were known as the Southern States. Eminent leaders of public opinion from the earliest period of the national existence—such as Washington, Franklin, Jefferson, Madison, Jay, Hamilton—regarded slavery as a great evil, and inconsistent with the principles of the Declaration of Independence. The Society of Friends uniformly opposed slavery, and agitated against it. The Presbyterian Church made six formal declarations against it between

1787 and 1836. The Methodist Episcopal Church always cherished strong anti-slavery views; though when in 1844 one of their bishops was suspended for refusing to emancipate slaves he had inherited through his wife, a secession took place, and the Southern Methodist Episcopal Church was formed. Individuals and groups of persons of almost all churches were found defending slavery. In 1835 the Charleston Baptist Association resolved that the right of masters to dispose of their slaves had been distinctly recognised by the Creator. In 1836 a North Carolina bishop strongly commended for publication a sermon which declared that without a new revelation from heaven no man was authorised to pronounce slavery wrong. In 1838 the New School Presbyterian Church in Petersburg, Virginia, protested against a resolution of the General Assembly declaring slavery a sin against God, pronounced that resolution irreconcilable with American civil institutions, and affirmed that the relation of master and slave had been recognised by the great Head of the Church. Yet, on the whole, anti-slavery views grew steadily; but until the crisis of the civil war very many of those who personally held strong anti-slavery opinions hesitated to join actively in abolitionist agitation, as unwilling to invade what many of their fellow-citizens held to be their indisputable rights. To this halting attitude the war put an end.

Mohammedanism (q.v.) recognises the institution; Mohammed's own precepts insist on the kindly usage of the slave; and Moslem slavery is mainly domestic slavery, household slaves being on the whole well treated. But there is no more awful chapter in the history of human callousness and human misery than the story of the slave-trade as carried on by 'Arab' or Moslem slave-traders, its main tracks from the interior of Africa to the coast being still in many places marked by the whitened bones of slaves who during the ages have sunk in the way, fallen out of the caravans in spite of the lash, and have died or been slaughtered to save trouble. The main regions from which slaves were procured for the Moslem East were, or still are, the Soudan proper, the Egyptian Soudan, or Valley of the Upper Nile, Somali Land, and the borders of the Portuguese East African territory. English and other men-of-war have long been employed in capturing slave-dhows on the east coast. In 1869 the Egyptian Khedive Ismail gave Sir Samuel Baker large powers for the suppression of the slave-trade, a crusade carried on by Gordon Pasha. The sultan of Zanzibar signed a treaty for the suppression of the trade in 1873. By occupying Caucasasia, Russia stopped an important supply for the Turkish harems; it also closed the slave-markets of Khiva and Bokhara, and by crushing the Turkomans (Tekkes and others) freed at once 40,000 slaves. Cardinal Lavigerie, who became archbishop of Algiers in 1867, made the suppression of the slave-trade and slavery his life work, and secured the help of many zealous fellow-workers, men and women. The progress of the Congo Free State, the foundation of missions in the Nyassa country, and the encouragement of legitimate trade by the British East Africa Company and the German settlements will, it is hoped, tend still more effectually to put an end to this curse of mankind. It has been said that the African slave-trade will not finally cease till the African elephant is extinct, as the carrying of ivory to the coast has heretofore only been practicable by slave labour. Conferences of the civilised powers have repeatedly been held with a view to the further restriction of domestic slavery (the entire suppression of which at once is hopeless) and the total prevention of the slave-trade.

See Wallon, *Histoire de l'Esclavage dans l'Antiquité* (2d ed. 1879); Grote's *History of Greece*; Lightfoot's *Commentary on Colossians*; Hallam's *Middle Ages*; Sugenheim, *Geschichte der Aufhebung der Leibeigenschaft in Europa* (1861); Engelmann, *Die Leibeigenschaft in Russland* (1884); Fustel de Coulanges, *The Origin of Property in Land* (Eng. trans. 1891); Freeman's *Norman Conquest*; Stubbs's *Constitutional History* (1874-78); Thorold Rogers' *Work and Wages* (1885); Seebohm's *English Village Community* (1883); Vinogradoff, *Villainage in England* (1891); the article FEUDALISM; Buxton's *Slavery and Freedom in the British West Indies*; Clarkson's *History of the Slave-trade*; Sir L. Playfair, *The Scourge of Christendom* (1884); S. Lane-Poole, *The Barbary Corsairs* (1890); French histories of slavery by Larroque and Villiard; Theodore Parker's *Discourses on Slavery*; W. E. Channing's *Slavery*; Mrs Beecher Stowe's *Key to Uncle Tom's Cabin* (1853); J. E. Cairnes, *The Slave Power* (1862); Goldwin Smith, *Does the Bible Sanction American Slavery?* (1863); H. C. Carey, *The Slave-trade* (New York, 1863); O. B. Frothingham, *The Abolition of Slavery* (1878); H. Wilson, *History of the Rise and Fall of the Slave Power in America* (1872); G. W. Williams, *History of the Negro Race in America* (1882); E. W. Blyden, *Christianity, Islam, and the Negro Race* (1887); Klein, *Cardinal Lavigerie* (Paris, 1890). See also the works of Burton, Baker, Barth, Gordon, Stanley, Thomson, &c.; and for 'blackbirding' in the Pacific, see COOLIES.

Slavonia. See CROATIA.

Slavophiles. See PANSLAVISM.

Slavs, or SLAVONIANS (native name, *Slovenci* or *Slovane*, probably connected with *slovo*, 'a word,' thus meaning the people who spoke intelligibly as distinguished from their neighbour, *Niemets*, the German, literally the 'dumb man'; this opinion is held by the majority of scholars, but lacks the support of Miklosich, who considers both to be tribal names), the general appellation of a group of nations belonging to the Aryan family, whose settlements extended from the Elbe to Kamchatka, from the Frozen-Sea to Salonica, the whole of eastern Europe being occupied almost exclusively by them. They were settled in this continent before the historical times, as their migrations are never mentioned, and some modern scholars—Penka, Poesche, and others—regard them as inhabitants of Europe from the earliest period, and even assign the cradle of the human race to White Russia. It seems probable from the description given in the fourth book of Herodotus that at least one of the Scythian tribes, the Budini, was Slavonic, and to it may perhaps be added that of the Neuri. The original names of the Slavonic tribes seem to have been Winds or Wends (*Venedi*) or Serbs. The former of these names occurs among the Roman writers, and later, in Jordanis, in connection with the commercial peoples of the Baltic; the latter is spoken of by Procopius as the ancient name common to the whole Slavonic stock. The earliest historical notices represent the Slavs as having their chief settlements about the Carpathians, from which they spread northward to the Baltic, westward as far as the Elbe and the Saal, and later, after the overthrow of the kingdom of the Huns, southward beyond the Danube, and over the whole peninsula between the Adriatic and the Black Sea. These migrations ceased in the 7th century; the division of the Slavonic stock into separate branches became now more complete, and gradually they began to form independent states. The sections of the stock may be divided into two groups, the south-eastern and the western; the first comprehends (1) the Russians, (2) Bulgarians, (3) Illyrians (Serbs, Croats, and Slovenes); the second (1) Leclis (Poles, Silesians, Pomeranians), (2) Czechs or Bohemians (Czechs or Chekhs, Moravians, Slovaks), (3) the Slavonic tribes of north Germany, among whom are to be reckoned the Polabes. The only tribes who have preserved their language are

the Lusatian Wends or Sorbs dwelling in Saxony and Prussia. Of the Polabes there are now no traces; their language ceased to be spoken in the early part of the 18th century. Many of the old Slavonic states have lost their independence and are in a state of greater or less vassalage. At the present time Russia, Serbia, and Montenegro are wholly independent. Bulgaria is a tributary state of Turkey, but practically independent. Bohemia and Moravia are united to Austria, and Croatia forms part of the kingdom of Hungary. Poland is distributed between Russia, Austria, and Prussia. Some Slavonic tribes have never enjoyed independence—e.g. the Sorbs and Slovenes. The sum total of the Slavonic populations is estimated at about 100,000,000.

The Slavs are represented by ancient writers as an industrious race, living by agriculture and the rearing of flocks and herds; as hospitable and peaceful, and making war only in defence. The government had a patriarchal basis, and chiefs were chosen by the assemblies. But in the west contact with the feudal institutions of the German empire, and in the east with Byzantium and the Mongols, greatly altered this primitive constitution; the Slavonic princes aimed at unlimited power, and the chiefs succeeded in binding the free peasants to the soil, as the feudal nobility had done. In the course of the 11th, 12th, and 13th centuries a hereditary nobility was formed in some of the Slavonic states. The people sank into the lowest condition of serfdom. Between them and the nobles there was no third or middle class, as the privileges of the nobility prevented the growth of towns, and such trade as there was was chiefly in the hands of foreigners.

The religion of the ancient Slavs, like that of the Teutonic nations, seems to have been in many of its features a kind of nature-worship—not without, perhaps, a predominating divinity: at least so Procopius tells us. But the whole subject of Slavonic mythology is up to the present time in a very confused state. For our information about Slavonic deities we are indebted to Nestor and the German chroniclers who wrote about the Baltic Slavs—e.g. Thietmar, Helmold, and others. We thus only know the gods of these peoples and the Russians. About those of the Poles, Bohemians, and southern Slavs we know almost nothing. The idols, from the accounts given of them, appear to have been of wood; and this is probably the reason why no genuine remains of them have come down to us. The chief deity, whose worship was probably common to all the western Slavs, was Sviatovit, with whom may be associated Perun and Radevast—and some have thought that these three names denote different personations or manifestations of the same power. Perhaps we may find parallels in Sviatovit to Mars and Zeus, Perun to Jupiter and Thor, and Radevast to Mercury and Odin. Of gods of an inferior order we may name Prowe, perhaps a god of justice, and Chernobog, the black god, together with multitudes of demons and spirits good and bad. Thus, among the Russians there were *rusalki*, water-nymphs, *lieshie*, satyrs; and among the Serbs and Bulgarians, *vilas* and *samodivas*, a kind of malicious fairy.

Some of these deities were worshipped under monstrous forms: thus, Sviatovit had four heads, Rugewit, the god of war, had seven faces, and so on. The Slavs seem to have had some crude notion of existence and retribution after death. Worship was performed in groves and temples, cattle and fruits being offered by the priests, whose office was originally performed by the head of the family or chieftain; perhaps this may be the reason why there is a common name for priest and prince (*knez*) among the western Slavs: the word, how-

ever, is certainly borrowed from the O. H. Ger. *chuning*. The eastern Slavs received Christianity from Byzantium in the 9th century, through the instrumentality of Cyril (q.v.) and Methodius; the western from Rome and Germany. They were Christianised with little opposition, for they had no religious caste, and there were no persons politically or socially interested in the cultus of their idols. Panslavism is the subject of an article (q.v.). See Schafarik, *Slawische Alterthümer*.

SLAVONIC LANGUAGE.—The term Slavonic, as applied to language or race, is a generic name (like Celtic or Teutonic) for a group of kindred languages and people belonging to the great Indo-European or Aryan family. The Slavonic languages are in a highly inflected state: the noun has seven cases, and all the numerals are declined. An article is implied in the termination of the adjective, as is shown by the form which it assumes when used as a predicate. As regards tenses, Russian, Polish, and Bohemian in their modern forms have lost the imperfect and aorist, but they are preserved in the Serbo-Croatian and Bulgarian. The poverty of the tense-system is amply compensated by the so-called *aspects*, which are found in every Slavonic verb—e.g. the frequentative, the momentaneous, and others, which supply tenses that may be wanting to the simple verb and express very delicate distinctions of time and manner. The Slavonic family in preserving these aspects has been truer to the old Aryan type of language than Teutonic. Traces of them can be seen in Greek (as Curtius has shown) and in Old Irish. The prepositions in and out of composition are used with a delicacy reminding us of ancient Greek. These languages have great power of compounding words and rich vocabularies. The oldest form known is the Palæo-Slavonic or ecclesiastical Slavonic, so called because used in the Orthodox churches. The original home of this language has been the subject of much dispute, and has divided Slavists into two camps; some finding it in Bulgaria, others in the ancient Pannonia, now corresponding to the territory occupied by the Slovenes—viz. Styria, Carinthia, and Carniola; hence it is sometimes called Old Bulgarian and sometimes Old Slovenish. It is, however, only an elder sister and not a mother language. The Slavonic family of languages may be grouped as follows: first, the south-eastern branch—(1) Russian, including Malo-Russian and White Russian. The second of these has great claims to be considered a distinct language, and is so treated by Miklosich. (2) Old and modern Bulgarian, the latter being in a somewhat decomposed form, having lost nearly all its cases and the infinitive mood. (3) Serbo-Croatian. (4) Slovenish. Secondly, the western—(1) Polish, including Kashubish. (2) Bohemian, including Slovak. (3) Lusatian-Wendish, or Sorbish, divided into two sharply defined dialects. (4) Polabish, which died out at the beginning of the 18th century, and like Cornish has been preserved in some vocabularies, &c.: from these fragments Schleicher constructed a grammar. See the sections on language and literature in the articles BOHEMIA, POLAND, RUSSIA, and SERBIA. We may here remark that in literature Russian, Polish, or Bohemian are richest, the two latter nations having developed a literature much earlier than the former. This remark applies especially to Bohemian, which can show good prose-writing in the 14th century. Many of the Russian and Polish poets have great merit. Slovenish and Sorbish are poor. The Serbs have developed a respectable literature in the 19th century, and the Bulgarians are already active. But both have only recently shaken off the Turkish yoke, fatal to all progress. Serbian, Russian, and Bulgarian are very rich in old ballads and popular

songs. These are scanty in Bohemian, and almost entirely wanting in Polish. Old Bulgarian literature, such as it has come down to us, consists mainly of religious works, original and translated.

See Pypin and Spasovich, *Istoriya Slavianskikh Literatur* ('History of Slavonic Literature,' in Russian, 1879; there is a German translation); Miklosich, *Vergleichende Grammatik der Slawischen Sprachen* (4 vols. Vienna, 1879); Leskien, *Altbulgarisches Lesebuch* (2d ed. 1886). For grammars of special languages, see under respective headings. And see Talvi (Mrs Robinson), *Literature of the Slavic Nations* (New York, 1850); *Slavonic Literature*, by the present writer, W. R. Morfill (Lond. 1883).

Sleaford, a town of Lincolnshire, on the right bank of the Sleas, a branch of the Witham, 17 miles SSE. of Lincoln. It has a fine church (built in 1271), a grammar-school (1624), and a monumental cross (1850). Here King John fell sick after crossing the Wash, and whilst spending the night in the old castle (now almost wholly disappeared). Pop. 4965.

Sledges. See SLEIGHS.

Sleep is symptomatic of repose in the brain and nervous system; in those who are awake cerebral activity is unceasing. Potential energy is being constantly expended in mental operations, vital processes, muscular movements, &c.; also in the perception of impressions that stream towards the brain incessantly from every part of the economy and of the environment. This is attended by wear and tear of the nervous textures, and by the deposition in them of waste-products proportionate to the work effected. Waking is therefore a positive condition—one in which energy is consumed more quickly than it is restored, and than the waste-products are eliminated. It is a state that entails a full working blood-supply to the brain. After a time, longer or shorter, a sense of fatigue suggestive of repose supervenes that is only relieved by sleep. Sleep, on the contrary, is a negative state—one in which these processes are reversed. The brain is inactive; consciousness and volition are in abeyance; coincidentally the central blood-supply is diminished, the brain is smaller in size, and its temperature is lowered. Expenditure of energy is curtailed to the greatest extent compatible with life. Recuperative processes continue, and predominate over the destructive; the nervous structures are depurated, and potential energy is accumulated. When recuperation is completed awaking occurs, and is accompanied by feelings of invigoration. Waking and sleep, therefore, are indicative of cerebral activity and of cerebral rest; they are both physiological functions of a healthy nervous system. When either is unduly prolonged, curtailed, or modified it gives evidence of a departure from health.

The brain is a composite organ. It contains innumerable centres which dominate an equally vast variety and number of functions; and these require and obtain sleep in varying degrees according to their functions. The supreme (psychical) centres which are constantly alert during waking need more sleep than some of the subordinate centres. These latter rest partially by day, so that the complete ablication of their functions at night is less urgently required.

The incursion of sleep is gradual. It is synchronous with the subsidence of activity in the brain and nervous system, and it is best studied in this connection. Molecular activity does not cease in the whole brain instantly, but in one portion after another until the whole organ becomes tranquil. It is suspended first in the centres situated highest in the cerebrum, and afterwards in those at lower levels, till the medulla oblongata and spinal cord are included. It consequently

affects the motor centres of the brain first. The earliest symptom of sleep is the weakening of the voluntary muscles; relaxation takes place in one set after another until the body assumes the horizontal posture. The sphincter muscles are exceptional; they remain contracted. During deep sleep true slackening occurs in the muscular fibres, even in diseases like tetanus and hydrophobia. A man may fall asleep in motion, as in walking or riding, and maintain his equilibrium; a certain amount of activity being sustained in the motor centres enables him to do so. If he yields to sleep in a stationary attitude, the motor centres being quiescent, he tends to sink into the recumbent posture. Activity next wanes in the psychical centres of the brain. The will ceases to control the working of the intellectual faculties, and the perceptive powers are lessened. The mind, no longer inhibited from within nor corrected from without, revels in absurdities until mental operations cease, or, at least, till they are wrapped in oblivion. The centres of the special senses in the brain are next involved, and usually in the following order; they fail to perceive slight or ordinary impressions, while their special nerves transmit them in a slow and imperfect manner. (a) Vision: The eyelids close; the eyeballs turn upwards and inwards in the orbits. The eyeballs occasionally, if rarely, move independently, and not in unison, during sleep. The pupils contract—the contraction being in ratio to the depth of sleep; they dilate widely in the act of awaking. (b) Hearing: Loud noises interrupt sleep, though an expected noise does so more readily. Monotonous sounds do not prevent or interrupt sleep; their cessation may terminate it. (c) Smell: Slight odours may prevent the onset of sleep; but very pronounced smells are required to disturb it. (d) Taste: It is difficult to determine the condition of this sense during sleep, the sense of touch being apt to vitiate the conclusion. (e) Touch: This is the most sensitive sense during sleep. It is chiefly through it that man is warned of danger, and that his safety is secured. Reflex acts can always be elicited, their vigour depending on the strength of the stimulus, the degree of sensitiveness of the part to which it is applied, and the depth of sleep. The centres in the medulla oblongata then become less active. They chiefly dominate the heart, the lungs, and arterial pressure. The heart beats from ten to twenty times less per minute, and the blood pressure is diminished. The respirations are about four fewer per minute. The inspirations are shallower and chiefly thoracic. The pause between inspiration and expiration is practically absent. Pettenkofer and Voit stated that of the total carbonic acid eliminated in twenty-four hours 58 per cent. is given off during the twelve hours of day and 42 per cent. during the twelve hours of night; whilst 67 per cent. of the oxygen taken in is absorbed during the twelve hours of night and 33 per cent. during the day. The centres that dominate the various secretions only respond to suitable stimuli, and as these are wanting during sleep the secretory organs are less active. The digestive juices are not formed, and if the gastro-intestinal movements do not cease entirely, they are greatly lessened. The urine is secreted in one-fourth the quantity. The quantity of sodium chloride, sulphates, and urea it contains is smaller; the latter is decreased one-half. The secretion of sweat is increased, and that of milk is continued.

In consequence mainly of the inactivity of the bodily functions the bodily temperature falls as much as from 0°·5 to 2° F., chiefly for some hours after midnight; it being lowest about 4 A.M. It falls similarly by day in those who work by night

and sleep by day. According to Helmholtz, a man gives off about three times more heat when he is awake than he does when he is asleep. During sleep the economy is more vulnerable to the influence of deleterious surroundings; it has less resisting power. Hence it is that infectious and malarial diseases are so readily contracted by sleeping in places in which these poisons abound; hence also the liability to catch cold from sleeping in a draught. Briefly summarised, during sleep the brain, ganglia, medulla oblongata, and spinal cord are in a state of repose. And the extent to which they are involved may be inferred from the fact that sleeping persons suffer little, if any, from shock in accidents which affect those who are awake most injuriously.

Sleep varies in depth in persons of different ages. It is usually profound in the young, and light in the aged. The depth bears some relation to its duration. Natural sleep varies from time to time during the same night. The observations of Köhlschütter, of Rummo and Ferrannini, and of Mönninghoff and Piesbergen showed that it was deepest an hour after its onset, when its intensity decreases quickly, then more slowly, and again it becomes more profound a second time after four to five hours. This is important in sleep-disturbance, for excitations will act more powerfully when it is lightest. On the other hand, when it is deepest the lowest centres are least inhibited, and the blood is less thoroughly oxygenated. It is then that epileptic, convulsive, spasmodic, and such-like seizures are most apt to occur. Cases of sleep lasting for weeks and months have been recorded (that of Johann Latus in the hospital of Myslowitz in Silesia in 1891-92 lasted 4½ months); in Britain it occurs in neurotic patients, and sometimes is called trance. It is pathological and not natural sleep. In western Africa 'sleeping sickness' is a well-known fatal disease.

Cause of Sleep.—For upwards of two thousand years continuous attempts have been made to elucidate the cause of sleep without success; many theories have been promulgated, but they have fallen short of explaining it.

Of *circulatory theories* the one that prevailed during many centuries attributed sleep to a determination of blood to the head; and much evidence was adduced in its support. Nevertheless, congestion of the brain is incompatible in health with good and refreshing sleep. This hypothesis was replaced by the anæmic theory. From the observations of Donders (1854), Durham (1860), Regnard (1868), Hammond and Weir-Mitchell (1869), and Ehrmann, Salathé, and F. Franck (1877), it would seem to be conclusively demonstrated that the blood-supply of the brain is lessened during sleep. Whether this is causative, concomitant, or consequent is still open to conjecture. Pathological anæmia is a well-recognised source of wakefulness. It appears certain that a blood-supply sufficient for nutritive purposes, but insufficient for mental activity, is an essential factor in natural sleep. The brain, like all other organs, governs and is not governed by its vascular supply.

Humboldt suggested one of several *chemical theories*—that sleep was due to the want of oxygen; and many have since urged that everything that deprives the brain of oxygen conduces to sleep. An atmosphere deficient in oxygen, or one containing an excess of carbonic acid, induces drowsiness and sleep, but it is poisoned, and not healthy sleep. Pflüger believed that activity of the psychical cells depends on the quantity of intra-molecular oxygen they contain, and that all function is attended (particularly in the gray matter) by explosive movements in the cells, caused by the combination of oxygen with the tissue-elements, in

which oxygen is consumed and carbonic acid is formed. He thought that these movements used up the oxygen at a greater speed than the circulation could replace, and that a time arrived when the lack of oxygen and an excess of carbonic acid caused drowsiness and sleep. Again, it has been urged that the waste-products (resulting from mental operations) in the nervous textures occasioned sleep. Preyer believed that the accumulation of these (ponogenes) at first caused fatigue, then sleep, and that waking occurred when they were eliminated in sleep. This doubtless is a factor in the causation of sleep, but it does not explain it.

The absence of external stimuli, such as occurs in the darkness and quietness of night, has been credited with causing sleep. It is a desirable aid to sleep, but, in health, sleep ensues despite all disturbing agencies—even on the torture-rack. Sleep has been ascribed to the law of periodicity that governs all organised things. The study of the bodily functions shows that rest and activity alternate—even the heart gets about ten to twelve hours rest in the pauses between its contractions. Of other numerous theories, it will suffice to say that no one of them can be accepted as fully explaining and finally settling the subtle problem. It may be that the mystery will never be solved until a deeper insight into the working of the mind itself is acquired.

How long should one sleep? is a question that must be answered generally. No hard and fast law can be laid down; every man must be a rule to himself. It is quite clear that nature intends everyone to sleep until the effects of waking are dissipated, and until the bodily energy is renovated. In childhood, when the constructive processes of growth involve large expenditure of energy, sleep is long and profound. In youth much sleep is still needed. In middle age, when decay and repair alone require to be balanced, less sleep is required. In old age, when repair is slowly and imperfectly effected, more sleep is desirable. The duration of sleep is also largely influenced by sex, temperament, occupation, habit of sleep, season, climate, &c. The true guide is the recuperation of the energies; that is indicated by a feeling of well-being on awakening. Some persons awake, after sleeping for an apparently sufficient number of hours, worn, jaded, and exhausted. That is an indication of disease, pointing to an inability on the part of their textures to accomplish their repARATION.

Sleeplessness.—The effects of curtailed sleep are very marked. The loss of a single night's sleep is attended by symptoms of enervation; that of several nights' sleep, by serious consequences. In many diseases the lack of sleep determines a fatal issue; conversely, sleep often determines recovery. Few persons appreciate the fact that the voluntary curtailment of sleep for an hour every night for a year is equivalent to the loss of forty-four nights' sleep of eight hours' duration. That represents an enormous expenditure of energy—e.g. during that time the cardiac pulsations are approximately 210,000 and the respirations about 90,000 more frequent than they would have been during sleep. Undue curtailment of sleep is attended by loss of flesh, the essence of emaciation being the preponderance of decay over repair. The skin becomes dry, and it loses its suppleness and translucency. All the bodily textures are badly nourished, and the organs suffer from lack of innervation. When sleep has been limited unduly, inability to sleep ensues and becomes the bane of existence. Exhaustion of the cerebral structures leads to still graver symptoms, such as insanity. Indeed, insomnia preludes or enters to a greater or less

extent into the causation of almost every form of mental alienation. They arise from similar causes. Many of the tragedies of life are due solely to the prolonged want of sleep. Insomnia or continued sleeplessness may cause death from exhaustion. Sleep, on the other hand, is a powerful curative agent—one that alone suffices to determine recovery. It has been well called 'the chiefest thing in physic.'

Sleeplessness is a symptom designed to subservise a highly conservative purpose. It attracts attention in some to ailments that might otherwise elude detection; in others it maintains consciousness requisite for the preservation of life. Sleeplessness is symptomatic of cerebral activity. This may be originated and perpetuated in divers ways. It may arise from mental causes, for the mind is dependent on the brain for its external manifestation. In mental overwork, worry, grief, suspense, &c. the intellectual or emotional centres respectively grow hyperæmic. At night the vaso-motor nerves that dominate the arterial vessels, worn out by continued inhibition, fail to moderate the supply of blood to these centres, and so the man is impelled to work and to worry, and he is prevented from sleeping. In the early stages he is long in falling asleep, and when he does it is to dream of his work and worry. Eventually insomnia becomes pronounced. Sleeplessness may depend on faulty conditions in the brain itself. Cerebral cells primarily or congenitally feeble, or secondarily debilitated by unhealthy conditions, display their enfeeblement in an incompetency to accumulate nervous force. Their molecules are rearranged in a preternaturally unstable manner, and they discharge their latent energy in response to trifling excitations. Such cells are designated 'explosive.' The peripheral cells generally participate in the enfeeblement, and they and their conducting nerves transmit impressions in a rapid and exaggerated manner. The reaction-time is lessened. This is a fruitful source of wakefulness in neurasthenia and its allied conditions. Sleeplessness from this cause usually appears at the epochs of life, and under privations or strains. The patient gets to sleep easily, but awakes in two or three hours, to remain awake till five or six in the morning. The awaking is often attended by distress and misery. It is in this class of cases that insomnia often occurs and recurs mysteriously. All neurotic diseases tend to recur paroxysmally; a bad sleep-habit once acquired is liable to return from time to time from very trivial causes.

Sleeplessness may result from a blood-supply altered either as regards quantity or quality. The cerebral cells are very sensitive to their environment; they bear excess and deprivation badly. Hyperæmia and anæmia of the brain are consequently productive of cerebral unrest and of wakefulness; and these brain-conditions may arise from diseases of the heart, lungs, and other organs, which secondarily implicate the cerebral circulation. The brain textures are unfavourably affected by alterations of vascular tension; high tension is unfavourable to sleep. They are equally disturbed by overheated blood such as pertains to feverish states. They are similarly perturbed by blood contaminated by peccant matters, such as those of gout, rheumatism, syphilis, malaria, &c.; hence the sleep disturbance in these diseases, and also that which follows the excessive use of tobacco, alcohol, &c. In the latter class the patients get to sleep quickly, to awake at two or three in the morning, to lie awake for some hours; and they are often awakened by slight external excitations.

Sleeplessness may be originated by sensory stimuli, which cause contraction of the peripheral and dilatation of the cerebral blood-vessels,

acceleration of the heart's action, and an increase of arterial tension. They also cause dilatation of the pupils, and change the character of the respirations; these become deeper, quicker, and more abdominal. Consciousness of external things can alone be aroused by impressions transmitted to the brain textures (themselves insensitive) becoming converted into sensations and ideas through the agency of the mind. When excitations are of sufficient intensity to cause sensations wakefulness is inevitable. Excitations may be instigated in the most varied ways; they include pain of all kinds, and many impressions arising out of digestive and other derangements. They affect the neurasthenic, gouty, and rheumatic unduly.

It is evident that successful treatment depends on accuracy of diagnosis. In each and every case the sleeping conditions of the sufferer should be attended to. Exercise and food should be proportionate to the body and to the strength of digestion. The primæ viæ and the state of the skin must not be neglected. A good habit of sleep should be assiduously cultivated. In sleeplessness due to mental causes change of work should be advised, that new centres may be called into operation, and the overwrought ones correspondingly relieved. It is in these cases alone that devices for getting to sleep, such as the monotonous counting of figures, sheep, &c., are efficacious. In bad cases the judicious use of pure hypnotics is helpful; they force the mind into oblivion. Drugs, like potassium bromide and chloral hydrate, which act chiefly on the brain centres that function thought, and induce sleep that closely resembles natural sleep, are called pure hypnotics, in contradistinction to many substances, as narcotics, analgesics, anodynes, soporifics, &c., that arrest pain, diminish sensibility, and disturb in a pronounced manner the functions of the brain and nervous system.

When wakefulness is due to neurasthenic conditions, tonics, increased nutrition, the abandonment of excesses, change of air and scene are indicated; electricity and suitable baths are useful adjuncts; hypnotics should be sparingly employed. Sleeplessness due to hyperæmic conditions of the brain is to be met by antiphlogistic treatment; that which depends on anæmia, by tonics, &c. In both, posture during sleep will repay attention. That which originates from gouty, rheumatic, syphilitic, and like poisons only yields to the alleviation of the constitutional state.

In sleeplessness due to sensory stimuli and pain, care must be taken to ensure the removal or mitigation of these, that the sleep they prevent may supervene. Medicines—analgesics or anodynes—such as belladonna, should be first selected, for they act as indirect hypnotics by operating chiefly on the nerve-terminals. When such remedies fail, narcotics, as morphine and opium, are called for; they not only lessen perceptivity in the brain and sensitivity in the nerve-endings, but they diminish the conductivity of the nerves. Such wide-reaching drugs have many disadvantages in such cases, but pure hypnotics are useless. Hypnotics, narcotics, and sleep-inducing medicines should never be taken except under medical advice. To drug the brain into quiescence without remedying the cause of the cerebral activity will in many cases only aggravate the evil, for they will be complicated by a drug-taking habit. In most instances drugs are best avoided.

Good bibliographies of this subject are to be found in Copeland's *Dict. of Med.* (vol. iii. pt. 2, Lond. 1858); in *Dict. Encycl. des Sciences Médicales*, art. 'Sommeil' (ser. iii. tom. 10, 1881); also in Neale's *Medical Digest* (Lond. 1891). The following may be consulted in connection with the physiology of sleep: Cappie, *The Intra-*

cranial Circulation (Edin. 1890); Carpenter, *Mental Physiology* (Lond. 1874); Darhan, *Physiology of Sleep* (Guy's Hosp. Reports, 1860); Fleming, 'On Sleep,' *Brit. and For. Med. Chir. Rev.* (1865); Hammond, *Wakefulness, &c.* (Phila. 1865); Holland, *Mental Philos.* (Lond. 1858); Lemoine, *Du Sommeil au Point de Vue Phys. et Psychol.* (Paris, 1855); Lyman, *Insomnia* (Chicago, 1885); Marvand, *Le Sommeil et l'Insomnie* (Paris, 1881); Moore, *On Going to Sleep* (Lond. 1868); Mosso, *Sulla Circolaz. del Sangue nel Cervello, &c.* (Rome, 1886); Pflüger, *Theorie des Schlafes* (Pflüger's Archiv, 1875); Serguéyeff, *Physiol. de la Veille et du Sommeil* (Paris, 1890); Vulpian, *Leçons sur l'Appareil vaso-moteur (Physiol. et Pathol.) faites à la Facul. de Méd. de Paris* (tom. ii.). In reference to sleeplessness the following may be referred to: Bride, *Sommeil et l'Insomnie des Vieillards* (Lyons, 1888); Fouquet, *L'Insomnie* (Montp. 1867); Hammond, *Sleep and its Derangements* (Phila. 1869); Macfarlane, *Insomnia and its Therapeutics* (Lond. 1890); De Mussy, *Sur l'Insomnie* (Paris, 1866); Pierrot, *L'Insomnie* (Strasb. 1869); Sawyer, *Causes and Cure of Insomnia* (Lond. 1886), and many other papers in medical journals. See also the articles ANÆSTHESIA, CATALEPSY, COMA, DREAMING, HYPNOTISM, INSANITY, NARCOTICS, SOMNAMBULISM.

In *Plants*, sleep is one of the phenomena of Irritability (q.v.). Light acts on plants as a powerful stimulus, essential to their active and healthful vegetation. When it is withdrawn the flowers of many plants close, and the greater number show a tendency to it, whilst leaves more or less decidedly incline to fold themselves up. The leaf-stalk also generally hangs down more or less, although in some plants it is more erect during sleep. The sleep of plants, however, is not always nocturnal. The flowers of some open and close at particular hours of the day. Thus, the crocus is a morning flower, and closes soon after mid-day; whilst some flowers expand only in the evening or during the night. It was Linnæus who first observed the sleep of plants in watching the progress of some plants of *lotus*, the seeds of which he had sown. The periodic movements of plants, of which sleep is one, have various uses. The opening of flowers in the morning and the closing in the evening is related to pollination; the folded petals protect the stamens and other sensitive parts from excessive cooling or wetting. The rising and falling of foliage leaves is useful in the same way, and preserves the chlorophyll-bearing tissue from injury; the extended position is adapted for temperatures and intensities of light that are favourable to assimilative activity. See PLANTS (MOVEMENTS OF), and VEGETABLE PHYSIOLOGY.

Sleidanus, JOHANNES, whose proper name was PHILIPPSON, a writer of history, was born at Schleiden, in the neighbourhood of Aix-la-Chapelle, in 1506, and having been trained to the law he entered the service (1537) of Francis I. of France. But becoming a convert to Protestantism he was dismissed (1541); and for the rest of his life he was ambassador of the Protestant princes of Germany, and represented them at the court of England and at the Council of Trent. He died at Strasburg on 31st October 1556. His name lives as the author of a history of the reign of Charles V.—a well-written, impartial work entitled *De Statu Religionis et Reipublicæ Carolo V. Cesare Commentarii* (1555; best ed. Frankfort, 1785-86, 3 vols.). Baumgarten edited the Letters of Sleidanus (1881) and wrote a Life of him (1878).

Sleighs, or SLEDGES, are travelling vehicles without wheels, which in some form are in use in all countries where snow lies for any considerable part of the year. Usually they are on runners—either one or two pairs—which are connected by a framework and support the body of the vehicle; but the well-known travelling-sledge (*pulkha*) of

the Laplanders, built in the form of a canoe, with sharp bow and square stern, of light materials and covered with reindeer skin, has no runners. In the northern United States and in Canada, where sleighs are brought to great perfection, lightness, and beauty, they take the place of carriages in winter; and there too sleds of lighter build, and supporting a light platform or seat, are made for coasting—i.e. sliding down hills. Long sleds for this purpose, sometimes capable of carrying forty persons, have two pairs of runners with their framework, on which a platform rests (often like a ladder, covered with a cushion); the front pair of runners is turned on a pivot by a steersman with the aid of ropes and pulleys. In Canada toboggans are in popular use for coasting (here called tobogganing), and consist of a single length of wood (or two boards joined together), about $\frac{1}{4}$ inch thick, curved backward in front, and the curved portion held back by leather thongs. The toboggan of course has no runners, may accommodate two to eight persons, and is guided by the steersman's foot dragging behind, toe downward. In Russia sleighs are often drawn by a team of three horses (*troika*).

Sleswick (Danish *Slesvig*; Ger. *Schleswig*) forms, united with the former duchies of Holstein and Lauenburg, a province of Prussia, having the Baltic Sea and the territories of Lübeck and Mecklenburg for its eastern boundary, Hamburg and Hanover for its southern, the North Sea for its western, and Jutland (Denmark) for its northern. Area, 7273 sq. m. It belongs to the alluvial peninsula of Jutland, its eastern half being an undulating plain and its western a series of low-lying but very fertile marsh-lands, protected from the ocean by sea-banks. The eastern coast (230 miles) is deeply indented by several long narrow arms of the sea called fjords, some of which make excellent harbours, and alongside it lie the large islands of Fehmern and Alsen. The western coast is more regular, but very low; and a string of low islands (Sylt, Föhr, Pellworm, Nordstrand, and others) and sandbanks stretching right in front of it protect it to some extent from the waves of the North Sea. The Elbe (on the southern border) and the Eider are the most important rivers; but the province is crossed by the North Sea and Baltic Canal (61 miles long), the Eider Canal (20), the Stecknitz Canal (35), and two or three shorter ones. The chief occupations of the people are agriculture, cattle-feeding, shipbuilding, and navigation. Corn and fat cattle are exported, the latter (of an excellent breed) in large numbers to England. Nearly 87 per cent. of the total area is under cultivation. Fishing is carried on in the inlets of the Baltic, and there are profitable oyster-beds amongst the sandbanks of the North Sea. Flensburg is the chief seaport. Pop. (1890) 1,217,393—i.e. for Sleswick and Holstein combined. Of this number nearly all belong to the Low German stock (except 140,000 Danes in the north), and are Protestants in religion. Sleswick-Holstein sends 10 members to the imperial parliament, and 19 to the Prussian house of representatives, and has an assembly of its own consisting of 58 members.

At the dawn of history Sleswick was inhabited by the Cimbric; they were succeeded by the Angles, Jutes, and Frisians. But the greater part of the Angles crossed over into England, and their place was taken by Danes. When Charlemagne reduced the Saxons to his sway the Danish king built a wall from sea to sea alongside the Eider, the southern frontier of his domains, to protect himself against the emperor's attacks. And from that time (808) for 350 years Sleswick alternated between the Danish and the imperial yoke, its duke paying homage sometimes to the king of the Danes, sometimes to the German emperor. In 1157 the

duchy was definitively united with the Danish kingdom. Meanwhile Holstein to the south was conquered and christianised by Charlemagne and his successors, and the countship of Holstein formed in 934 by the German king Henry I. Between 1157 and 1225 this southern part of the peninsula was subject to the rule of Denmark. From the year 1386 the Danish duchy of Sleswick and the German countship of Holstein had one common ruler, the Count of Holstein having fallen heir to the former dignity in that year. About fifty years earlier a compact had been made, the *Constitutio Waldemariana*, by which it was solemnly agreed that the crown of Denmark and the duchy of Sleswick should not in future be held by the same individual ruler. In spite of this agreement, however, King Christian I. of Denmark possessed himself of both Sleswick and Holstein, and, having in 1474 acquired from the Emperor Frederick III. the suzerainty of Ditmarsh, he converted the countship of Holstein into a duchy. The sons of the next Danish king divided his territories amongst them after his decease, and their immediate successors still further subdivided them; but eventually they were all gathered up again (1531) under the heads of the royal line (Glückstadt) and the ducal line (Gottorp). The latter held Sleswick as a fief of Denmark and Holstein as a fief of the German empire; nevertheless the king of Denmark ruled in several detached portions of both duchies.

Ten years after the conclusion of the Thirty Years' War the Duke of Sleswick (Frederick III.), backed by his son-in-law Charles X. of Sweden, declared himself an independent and sovereign prince. This the Danish kings all along resented, and at length, when Charles XII. of Sweden was routed at Pultowa, Frederick IV. of Denmark grasped (1721) the opportunity, invaded Sleswick, expelled the duke, and seized his territories in that duchy. The heads of the ducal line became, one in 1751 king of Sweden, the other (the nominal duke) in 1762 emperor (Paul III.) of Russia, and soon ceased to take any interest in Sleswick-Holstein, the whole of which (both duchies) was formally given up to the king of Denmark in 1767. On the dissolution of the German empire in 1806 Holstein was united with the Danish crown, but was reincorporated in the German Confederation by the Congress of Vienna in 1815. From 1767 the Danish sovereigns had steadily endeavoured to make the duchies thoroughly Danish and to reduce them to complete dependence upon the Danish crown. At length in 1846 King Christian VIII. proclaimed that the law of succession in Sleswick should be the same as for the Danish crown—in other words, that Sleswick was to be made an integral part of the Danish kingdom. This action, as well as the refusal of the king to summon the common estates of the joint duchies, was warmly and actively resented by the people of Sleswick and by the German party in both Sleswick and Holstein. At length (March 1848) the latter, headed by Count Reventlow and Prince Frederick of Augustenburg, rose in revolt. They found a zealous supporter in Frederick William IV. of Prussia, who made himself the executive agent of the German Confederation. War began in March 1848; several severely contested battles, as at Düppel, were fought before peace was made in the end of 1850. Through the intervention of Austria matters were for a time put on a footing satisfactory to the people of the two duchies—so far at least as fair words and fine promises could go. The Danes, however, still pursued their policy of forcible denationalisation in both Holstein and Sleswick. The death of King Frederick VII. of Denmark in the end of 1863 brought the question of succession to a crisis; for Frederick of Augustenburg pro-

claimed himself Duke of Sleswick, to which title the new king of Denmark likewise laid claim. Austria and Prussia called upon Duke Frederick to abdicate and leave the duchy, and forbade Denmark to proclaim a constitution for it. Both refused to obey. Thereupon the two powers took up arms against the northern kingdom, and after a short but decisive campaign wrested both Holstein and Sleswick from the Danes. How they divided their conquest between them, and then quarrelled over the division, and how Austria came out of the conflict thoroughly worsted, has been already told under Germany (q.v., p. 183). Since the conclusion of that war (1866) Sleswick-Holstein has constituted a province of the kingdom of Prussia. In the northern part of Sleswick, mainly Danish in population, German measures, such as the compulsory use of the German language in schools, &c., have been considered oppressive; and so recently as 1898 the German government was expelling recalcitrant Danes across the frontier.

Sleswick, the capital of Sleswick-Holstein, stands on the Schlei inlet of the Baltic, 28 miles NW. of Kiel. It was a great trading town in the 9th century, and has a Gothic cathedral and the Gottorp Castle. Pop. (1885) 15,187; (1895) 17,255.

Slickensides are the smooth, polished, or striated, and generally glazed surfaces of joints and faults (see **DISLOCATION**) in rocks, produced by the friction of the two surfaces during the movement of the rock. The surface of slickensides is often coated with a deposition of calcite, hæmatite, chalcedony, or the like.

Sliding Scale. See **CORN LAWS**; **TRADE UNIONS**, Vol. X. p. 265.

Sligo, a maritime county of the province of Connaught, Ireland, is bounded on the N. by the Atlantic and the Bay of Donegal, S. by Roscommon and Mayo, E. by Roscommon and Leitrim, and W. by Mayo. It is 41 miles from E. to W., and 38 from N. to S.; the total area is 461,796 acres. Pop. (1841) 180,886; (1861) 124,845; (1881) 111,578; (1891) 98,338—a decrease of 11.9 per cent. About 91 per cent. are Roman Catholics. The coast-line is indented with bays, the largest being Killala Bay and the Bay of Sligo. The surface rises gradually from the coast as far as the Slieve Gamph and the Ox Mountains (1778 feet). Sligo contains some picturesque lakes, especially Lough Arrow and Lough Gill. The streams are inconsiderable; but three—the Moy, Owenmore, and Garvogue—are to some extent navigable. Iron is abundant and copper occurs, but neither is worked. The climate is moist, mild, and healthy. The soil is in part sandy loam, in part a deep rich loam. The chief occupation is agriculture; until some years back the people were chiefly engaged in tillage, but now they devote most attention to pasturage, especially the feeding of cattle. Close upon one-half of the total area is under grass; 27½ per cent. is uncultivable; and only about 80,000 acres are under crops, including some 19,000 acres of oats, 18,000 acres potatoes, and 32,000 acres of meadow-land. The bulk of the holdings range between 5 and 30 acres each. Coarse woollens and linens are manufactured. A considerable number of the population engage wholly or partially in fishing. The county forms two parliamentary divisions. The principal towns are Sligo, Ballina (1442; also 4318 in Mayo), Ballymote (1145), and Tobercurry (1081). Sligo was anciently the seat of the O'Connors. It contains a group of cromlechs near Sligo, a round tower at Drumcliffe, ruins of an ancient abbey at Ballysadare, and numerous other raths, cromlechs, and ancient caverns.

SLIGO, chief town of the county, stands at the mouth of the Garvogue, 137 miles NW. of Dublin

by rail. Pop. (1861) 13,361; (1881) 10,808; (1891) 10,110. Sligo had its origin in a Dominican abbey, built in the middle of the 13th century by Maurice Fitzgerald, Earl of Kildare, and now in ruins, and was formerly surrounded with walls and defended by a castle (1242), of which no vestiges are now left. There are a Roman Catholic cathedral, a modern town-hall, a lunatic asylum, &c. The town has some trade, exporting cattle, corn, butter, and provisions. Steamers ply regularly between Sligo and Glasgow, Liverpool, and Londonderry. Sligo was besieged by the parliamentarians in 1641, and was captured and lost again by the adherents of William III. It formerly returned a member to parliament, but was disfranchised in 1870.

See county histories by T. O'Rorke (1889) and W. G. Wood-Martin (3 vols. 1890-93).

Sling, a weapon much in use before the introduction of firearms, consisted of a piece of leather, with a round hole in the middle and at each end a cord of about a yard in length. The slinger held the free ends of the cords in one hand, and whirling the weapon round and round with his utmost force in a vertical direction, suddenly let go one of the cords. This propelled the stone or other missile that was placed in the leather at a great speed forwards for a considerable distance. Slings fastened to the end of a short pole were capable of discharging a bolt with such force that at 500 yards distance it could pierce a helmet or a thin shield. The sling is not mentioned in the *Iliad*, but already in the Persian wars we find traces of its use. The Achæans, and later the Achæans were the most skilful, but amongst all ancient races the Balearic islanders were counted the most expert; and the sling was a favourite weapon of several semi-savage peoples, notably the Tahitians in the Pacific. They were used by the besiegers during the defence of Chitral; see Sir G. S. Robertson's *Chitral* (1898).

Slip, in a dockyard, is a smooth inclined plane, sloping down to the water, on which a ship is built. It requires a very solid foundation. For the repair of ships of comparatively moderate size slips were designed by Mr T. Morton, Leith, and consist of a carriage with blocks, as in a graving-dock, working on an inclined railway extending for some distance beyond high-water to a sufficient depth below low-water of spring tides to enable vessels to be floated on the carriage. When the vessel is floated over the cradle powerful hauling gear, worked by steam or other power, is set in motion to draw the ship out of the water. At the Tyne, for example, the slipway is 1000 feet in length, and a hundred vessels yearly are repaired on it. Slipways are useful adjuncts to shipping ports, and for vessels up to 2500 tons register they are better than a dry-dock, as better light is afforded for making repairs, and no pumping is needed; but this size is nearly the limit, though there is no good reason, if the slip and gearing be made strong enough, why larger vessels may not use slipways. See DOCK, SHIP-BUILDING.

Sliven (Turk. *Islimîa*), or SELIMNIA, a town of South Bulgaria (Eastern Roumelia), at the southern base of the Balkan Mountains, 70 miles N. by E. of Adrianople, is celebrated for its annual fair. Arms, cloth, and attar of roses are manufactured. Pop. (1888) 20,893; (1893) 23,210.

Sloane, SIR HANS, physician and naturalist, was born at Killyleagh, County Down, 16th April 1660, the son of an Ulster Scot. He devoted himself to natural history and medicine, and in spite of an attack of hæmoptysis, which lasted from his sixteenth till his nineteenth year, he arrived in London in 1679 a well-read student. His appren-

ticeship to Stafforth, a pupil of Stahl, and his friendship with Boyle and Ray did much to encourage and advance him in his favourite studies. In France he attended the lectures of Tournefort and Duverney, and obtained on his return, by the active support of Sydenham, a footing in London as a physician. Already F.R.S., he spent over a year (1685-86) in Jamaica, collecting a herbarium of 800 species; and after his return became physician to Christ's Hospital (1694-1724), President of the College of Physicians (1719-35), Secretary to the Royal Society (1693), Foreign Associate of the French Academy (1708), and Sir Isaac Newton's successor as President of the Royal Society (1727). He had been created a baronet and physician-general to the army in 1716, and in 1727 was appointed royal physician. Though of remarkably delicate constitution, he lived to the great age of ninety-two, dying at Chelsea, 11th January 1753. His museum and library of 50,000 volumes and 3560 MSS., offered at his death to the nation for £20,000, formed the commencement of the British Museum (q.v.). He contributed numerous memoirs to the *Philosophical Transactions*, and published in 1745 a treatise on medicine for the eyes. But his great work was the *Natural History of Jamaica* (fol. 1707-25).

Sloe, or BLACKTHORN (*Prunus spinosa*), a shrub of the same genus with the plum, and perhaps really of the same species with it and the bullace. It is generally a shrub of 4 to 10 feet high, but sometimes becomes a small tree of 15 to 20 feet. It is much branched, and the branches terminate in spines. The youngest shoots are covered with a fine down. The flowers are small, snow-white, and generally appear before the leaves. The fruit is ovate, or almost globose, pale blue with blackish bloom, and generally about the size of the largest peas. The sloe is abundant in thickets and borders of woods and hedgerows everywhere in Britain and almost all parts of Europe. The shoots make beautiful walking-sticks. Being spiny, the sloe is sometimes planted as a fence against cattle; but the roots having a habit of spreading and sending up suckers, hedges of it are troublesome to keep from encroaching on the fields. The bark is bitter, astringent, and tonic. The flowers, with the calyx, are purgative, and were once a favourite domestic medicine. The leaves are used for adulterating tea. The unripe fruit dyes black. The fruit, which is very austere, may be made into a preserve; and from it a kind of brandy may be extracted. An astringent extract of it, called *German Acacia*, was once much employed in cases of diarrhœa. The juice has been used to impart roughness to port wine and in the fabrication of spurious port. The sloe of the southern United States (*P. umbellata*) has a pleasant black or red fruit.

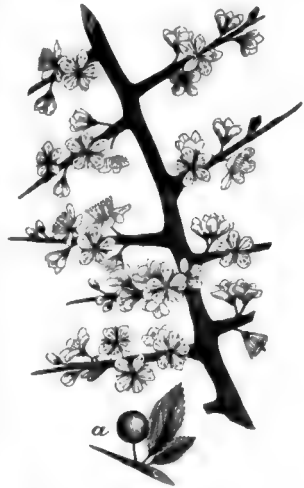

Sloe (*Prunus spinosa*): a, fruit.

Slonim, a town of Russia, 75 miles SE. of Grodno. Pop. 22,275.

Sloop is a one-masted cutter-rigged vessel, differing from a Cutter (q.v.), according to old authorities, in having a fixed bowsprit and somewhat smaller sails in proportion to the hull. The terms 'sloop' and 'cutter' appear, however, to be used nearly indiscriminately. In the British navy a sloop-of-war was a vessel, of whatever rig, between a corvette and a gun-vessel, and ordinarily constituting the command of a commander. In the days of the sailing navy sloops-of-war carried from ten to eighteen guns; but since the introduction of steam the number of guns has ceased to be distinctive. Under the new classification of the navy, which was made in 1888, the term sloop-of-war has been modified, many modern vessels which formerly would have been designated as sloops being now known as third-class cruisers. The few sloops-of-war still found on the *Navy List* are all more or less obsolete, and it is doubtful if any more will be built.

Sloth. These animals, which are referable to two genera (*Choloepus* and *Bradypus*), form a distinct family of the order Edentata. Their nearest allies are the armadillos and ant-eaters of South and Central America, to which countries the sloths also are restricted. They are exclusively arboreal animals and entirely vegetable feeders. In the forests which they inhabit it is quite unnecessary for them to descend to the ground in order to reach another tree, as the interlocking of the branches affords an easy passage. It has been asserted that when a sloth is absolutely compelled to walk upon



Two-toed Sloth (*Choloepus didactylus*).

the ground it acquires itself more creditably than might have been expected from an animal so conspicuously fitted for a purely arboreal life; though some authorities allege that it is quite incapable of progression upon the ground. The form of the animal is bulky and awkward; the fingers and toes are long, and furnished with long curved claws, which enable it to obtain and keep a firm hold upon the branches along which it crawls with the body hanging down. The two genera *Choloepus* and *Bradypus* are known respectively as the 'two-toed' and 'three-toed' sloths, from the number of toes upon the fore-feet. Neither genus has any incisor teeth; they have canines and molars with flat crowns, suitable for crushing vegetable food. The hair of the sloth is coarse and shaggy, and

frequently of a dirty green colour: this colour is lost in captivity. It has been shown by Mr Sorby to be due not to any colouring substance in the hair, but to the presence of minute green plants (*Algae*). The damp and warmth of the tropical forests probably favours the growth of these *Algae*, which disappear when the conditions are altered on the removal of the creature from its native forests. The long green hair combined with the lethargic habits of the sloth must be a protection to it against the attacks of jaguars and large snakes, which are its principal foes. This resemblance to a lichen-covered branch is strangely heightened in one species by an oval mark upon the back which bears the closest resemblance to the broken end of a branch. When the sloth is driven to take extreme measures it can use its teeth and claws to good purpose, and it has been even known to grasp a dog round the neck and strangle it.

Sloth Bear. See BEAR.

Slough. See (under Skin, p. 488) SKIN-CASTING, and SNAKES, p. 530.

Slough, a town of Buckinghamshire, 18½ miles W. of London and 2½ N.E. of Windsor. It has grown from a mere village since the railway epoch, and is a well-built place, the seat since 1863 of the British Orphan Asylum; but it will always be chiefly remembered as the home of Sir William Herschel from 1786 till his death, and thereafter till 1840 of his son, Sir John. Stoke Poges and the Burnham Beeches, both noticed separately, are near. Pop. (1861) 3425; (1891) 5427. See Phipps's *History of Upton-cum-Chalvey* (Slough, 1886), the parish in which Slough is chiefly situated.

Slovaks, a branch of the Slavs (q.v.), who dwell in the mountainous districts of north-west Hungary, and number in all about 2,000,000. They are a race of peasants, and live by cultivating the soil. In religion they are partly Lutherans, partly Roman Catholics. These people formed a constituent part of the ancient kingdom of Moravia, but have been incorporated among the subject-lands of the Hungarian crown since the beginning of the 11th century. Their language is little more than a dialect of Czech, the speech of the Bohemians. Down to the end of the 18th century the Slovaks used Czech as their written or book language, but since that period certain patriotic writers—more notably the poets Holly, Chalupka, and Sladkovitch, the philologists Bernolak and Hattala, and the novelist Tomaschik—have tried to create a pure written Slovak literature. Their efforts have met, however, with considerable opposition from both the Hungarians and the Bohemians.

Slovenians, a branch of the south Slavonic stock to which also the Serbs (Servians) and Croats belong. The Slovenians are found mainly in Styria, Carinthia, Carniola, and adjoining parts of Hungary, and number in all about 1,250,000. They are sometimes called *Winds* or *Wends*, though distinct from the Wends (q.v.) of north and east Germany. They have been subject to the House of Hapsburg since the 8th century. There is not much literature in the native speech apart from the 'Freising Fragments' (forms of confession and a sermon), dating from the 10th century, and 16th-century translations of the Bible, until we come to the end of the 18th century. Since the revival of the language which then took place the principal writers have been the poet-philologist Vodnik (1758-1819), the poets Preseren (1800-49) and Vesel-Koseski, the journalists Bleiweiss and Janezic. See SLAVS.

Slow-match, generally rope steeped in a solution of saltpetre and lime-water, and burning at the rate of one foot per hour. Port-fires are very

similar, but burn an inch a minute. They were used for firing guns before the introduction of friction tubes, and sometimes for firing military mines, &c. They have been superseded by *Bickford's fuse*, a train of gunpowder enclosed in two coatings of jute thread waterproofed. There are two kinds, the *ordinary* (a slow match), burning at the rate of 3 or 4 inches a minute, and the *instantaneous* (a quick match), burning at the rate of 30 yards per second, and distinguished from the former by yellow threads crossed on the outside.

Sloyd (Swed. *slöjd*; cf. Eng. *sleight*) is the name given to a certain system of manual instruction which obtains in the schools of Finland and Sweden, and which has been largely adopted in other countries. The word properly denotes work of an artisan kind practised not as a trade or means of livelihood, but in the intervals of other employment. The fundamental idea of the educational sloyd is to utilise this sloyd-work in the schools in a disciplinary way as an integral part of general education. To this end the older children, generally boys, are engaged for a certain number of hours a week in making articles of common household use varying from simple objects such as a flower-stick or a pen-rest to more complicated articles such as a cabinet or a small table. These objects are made from drawings or from models, but to exact measurements, and the utmost accuracy and finish are insisted upon. The tools employed are the ordinary tools of the carpenter, with certain exceptions, the most important of which is the knife. It is held that work of this kind is valuable, as supplementing and correcting the ordinary school education in the three R's. It fulfils the injunction 'to put the whole boy to school,' it develops faculties that are not otherwise exercised, it trains the eye, and in particular gives a general dexterity of hand which has a direct economical value, particularly in countries such as Finland and Sweden, where the sparseness of the population does not allow of much subdivision of labour. But valuable as are these practical results, the advocates of sloyd maintain that they are only of secondary importance. It is held that in making the models certain educational results, valuable generally, are obtained, which do not follow in like measure on the teaching of the ordinary school subjects, and that, therefore, work of this kind is beneficial for all pupils whatever their future occupation may be. It utilises, as a means of education, the universal delight of children in making things, and in addition to its special function of training the hand and eye it develops in a pre-eminent degree habits of self-reliance, order, accuracy, attention, and industry. It tends like gymnastics to the increase of physical strength, and it has a desirable effect socially, inasmuch as it fosters a liking for bodily labour and a respect for it. Above all it stimulates and exercises the practical intelligence or power of thought in dealing with things. To obtain these results the educational ends of sloyd must be kept prominently in view. The teacher accordingly ought to be a trained teacher who has acquired the requisite manual skill rather than an artisan, and the work ought to be properly graduated, regard being had to the greater or less difficulty of the exercises with tools involved in making each of the models. Besides wood-sloyd, sloyd-work in iron and in cardboard (*papp-slöjd*) is also practised. There are also various systems of wood-sloyd differing in practical details. The main principles of sloyd had been advocated by many prominent educationists, and in particular by Herbart and by Froebel, of whose kindergarten system sloyd may be regarded as a continuation. But it was in Finland, on the reorganisation of the national system of education by

Uno Cygnæus, that manual work was first made a part of the regular instruction in the common schools. In Sweden this branch of education has been systematised and its principles expounded, chiefly by Herr Otto Salomon, director of the great slöjd-seminarium at Nääs (instituted 1872), where every year large numbers of students from all parts of the world receive gratuitous instruction.

Salomon's *Teachers' Handbook of Slöjd* was translated and adapted for English teachers in 1891 by Mary R. Walker and W. Nelson, who also translated Alfred Johansson's *Practical Directions* (1892).

Slug, a name used for those land-molluscs of the order Pulmonata ('air-breathing') in which the shell is rudimentary or absent. They have the same structure as the Snails (q. v.), but the shell, when present, is usually concealed beneath the mantle, though in some genera (e.g. *Urocyclus*) it is visible through an aperture in the mantle, while in others (e.g. *Helicarion*) it becomes decidedly spiral and more exposed, so that it is impossible to draw any hard and fast line between the true slugs and the shell-bearing pulmonates or snails. The mantle is usually an oval structure placed anteriorly on the back, with an orifice on its right side leading to the pulmonary cavity. In *Arion* and some other genera there is a gland at the posterior extremity of the body for the secretion of mucus or slime. Slugs are divided into six families, each of which seems to have been evolved separately from a group of shell-bearing ancestors. The family Succineidæ, in which the jaw has a quadrate accessory plate, contains both testaceous and shell-less genera, the latter being found in South America, the West Indies, and the Indian and Australian regions. The *Vaginulidæ*, in which the male and female genital orifices are distinct, occur throughout the tropical regions of the world. The *Limacidæ*, including the genera *Limax* and *Agriolimax*, are a family of almost world-wide distribution, known by the possession of a smooth jaw and aculeate marginal teeth. The *Arionidæ*, the typical genus of which is *Arion*, have a usually ribbed jaw and quadrate marginal teeth; they are found most abundantly in Europe and North America, more sparingly in South America, Asia, and Africa, and not at all in Australia. The *Testacellidæ* (including *Testacella*) and the *Selenitidæ*, both of wider distribution, have all the teeth aculeate; the former are without, the latter with, a jaw. Over 500 species of slugs have been described, of which nineteen inhabit the British islands. Of these three belong to *Testacella*, a genus possessing a small external shell on the posterior part of the body. The *Testacellæ* are carnivorous, and devour earthworms, which they

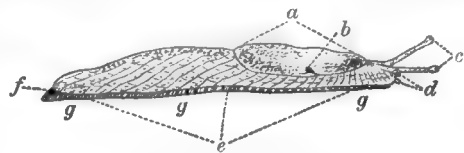

Fig. 1.—Diagram of a Slug :

a, mantle; b, respiratory orifice; c, eye-peduncles; d, tentacles; e, sole; f, mucus-pore; g, foot-fringe.

pursue underground. Four species belong to *Limax*—viz. the Great Gray Slug (*L. maximus*) and its ally *L. cinereoniger*, the Yellow or Cellar Slug (*L. flavus*), recognised by its yellowish colour and bluish tentacles, and the Tree Slug (*L. arborum*). Two species belong to *Agriolimax*, the common Gray Slug of our gardens (*A. agrestis*) and the Brown or Marsh Slug (*A. lavis*), which is found in damp places. Two are of the genus *Amalia*, which differs from *Limax* in having the

back sharply keeled. There are several of the genus *Arion*, differing from *Limax* in the more anterior position of the respiratory orifice, and the possession of a caudal slime-gland. The Black Slug (*A. ater* or *empiricorum*) is a very large species, varying much in colour, being black, white, black with white sides, black with a red fringe, brown, brown with yellow sides, red, gray, or yellow. The red variety is called the Red Slug, and was considered by Linnæus a distinct species.

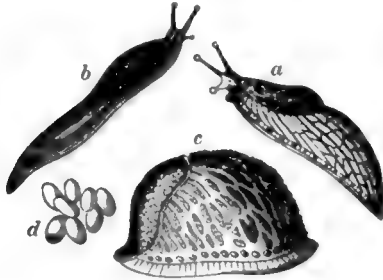

Fig. 2.—Slugs :

a, *Agriolimax agrestis*; b, *Arion*; c, *Arion empiricorum*, at rest; d, its eggs.

The Striped Garden Slug (*A. hortensis*) is a small species common in gardens; it has the under side of the foot yellow or orange. The Irish Slug (*Geomalacus maculosus*) is only found in County Kerry, Ireland, and in Portugal. Slugs do great damage to garden crops, and various methods have been devised for destroying them. They may be sought under stones or boards, or enticed by decaying cabbage-leaves, or collected while on the move at night, or in wet weather. They are readily killed by salt water. They lay their eggs, which often resemble small oval bags of jelly, in clusters in moist places. Slugs frequently climb trees, and some of them, especially the Tree Slug, have the power of descending by means of threads of mucus. The name Slug is often applied by gardeners to the larvæ of saw-flies (Tenthredinidæ).

Slutsk, a town or large agricultural village of Russia, 60 miles S. of Minsk. Pop. 19,208.

Sluys, a town of Holland, province Zealand, on a bay of the North Sea, 6 miles NE. of Bruges. In the middle ages it was a seaport of some importance, but it is most celebrated for the naval battle fought off the shore between the English and the French on 24th June 1340, in which Edward III. won a complete victory. Pop. 2631.

Smack, a generic term for small decked or half-decked coasters and fishing-vessels. Most smacks are rigged as cutters, sloops, or yawls.

Smalkald. See SCHMALKALDEN.

Small-arms include all weapons that can be actually carried by a man. They are described under their respective heads, BAYONET, FIREARMS, PISTOL, REVOLVER, SPEAR (or Lance), RIFLE, SWORD. Small-arms are manufactured for the British government at Enfield and Birmingham.

Small Debts is a phrase current in Scotland to denote debts under £12, recoverable in the Sheriff Court (see SHERIFF). In England the same debts are recoverable in the County Court (q.v.). See DEBT, Vol. III. p. 718.

Small Holdings. See ALLOTMENTS, PEASANT PROPRIETORSHIP.

Smallpox, or VARIOLA, is one of the most formidable of the class of febrile diseases known as the *Ezanthemata* (q.v.). The period of incubation (see under MEASLES) is generally twelve days.

All cases of regular smallpox are divisible into three stages—viz. (1) that of the initial or eruptive fever; (2) that of the progress and maturation of the specific eruption; and (3) that of the decline. The course of an ordinary case of *discrete* smallpox—i.e. one where the pocks remain throughout distinct from each other—will first be described, and afterwards the other forms will be discussed. The *first stage* begins with rigors, followed by heat and dryness of the skin, a quickened pulse, furred tongue, loss of appetite, pain in the pit of the stomach, with nausea, vomiting, headache, and often pains in the back and limbs. The violence of the pains in the back, and the obstinacy of the vomiting, are frequently very well marked and characteristic symptoms. In children the disease is often ushered in by convulsions; while delirium sometimes attends its outset in adults. On the third day minute red specks begin to come out—first on the face (where they are always most numerous), then on the neck and wrists, and on the trunk of the body, and lastly, on the lower extremities. These correspond to the incipient *pocks*, which can be felt like small shot under the skin, better, sometimes, than they can be seen. The fever, pain, sickness, &c. usually begin to subside as soon as the eruption appears, and by the beginning of the fifth day, when the eruption is generally fully out, and the *second stage* commences, have entirely disappeared. Upon the second or third day of the eruption a little clear lymph is seen in each pimple, which has increased considerably in size since its first appearance, and which is thus converted into a *vesicle*. The vesicles gradually increase in breadth, and, their contents becoming more and more yellow and opaque, are converted into *pustules*. These are at first depressed in the centre, but at their fullest development often become turgid and hemispherical. The suppuration on the face is complete by about the ninth or tenth day from the commencement of the fever, and the same process rapidly follows in the other parts of the body in the same order of succession as that in which the eruption originally appeared. The progress of the pustules is usually accompanied by swelling of the skin of the face, with a painful sensation of heat and tension; the scalp is often swollen; soreness of the mouth from a modified eruption there is often present; and the patient exhales a peculiar and disagreeable odour. About the eighth or ninth day of the disease a recurrence of the fever, known as the *fever of maturation*, or *secondary fever*, sets in, with a return of headache, restlessness, and sometimes delirium. The *third* or *declining stage* is little more than a period of convalescence. About the eleventh or twelfth day the pustules on the face become brown and dry at the top, or some of them break, and the fluid which oozes out solidifies into a yellowing crust; and from this time the process of *desiccation* goes on, the swelling of the face subsides, and at last only dry scabs remain, which gradually fall off about the fifteenth or sixteenth day. It is not till three or four days after the scabs have formed on the face that the same process is completed over the whole body. The scabs are usually completely gone by the twenty-first day, leaving behind them blotches of a reddish-brown colour, which sometimes continue for some months before they quite disappear; and some of the pustules, in consequence of ulceration of the true skin, may leave pits, especially on the face, which remain permanently. The period of scabbing is accompanied by various symptoms of improvement: the tongue becomes clean, the appetite returns, and by the time that the scabs have fallen off the patient may be regarded as restored to health; so that the entire course of a case of *discrete* smallpox occupies about three weeks.

Generally speaking, the severity of the disease is proportional to the number of pocks; and when these are so numerous as to run together on any part of the body, the disease is said to be *confluent*. This form differs in many important respects from that already described. The eruption is necessarily modified: the individual pocks are smaller, but by their coalescence they give the skin of the face an appearance 'like a mask of parchment,' and generally lead to much more scarring of the skin. Severe laryngitis and bronchitis, and ulceration of the corneæ, with consequent impairment or destruction of sight, are of frequent occurrence; and salivation is a usual symptom. But most important of all is the difference in the course of the fever. The remission described above in the first stage is slight, if it occurs at all; and the secondary fever, although on this account less conspicuous, is more severe, and much more dangerous to life.

Malignant smallpox is characterised by the severity of the onset, but particularly by the occurrence during the first few days of hæmorrhages under the skin, and from the various orifices of the body. Such cases are almost without exception rapidly fatal, sometimes so early that no sign of the characteristic eruption appears at all.

Modified smallpox, sometimes (but not happily) called *varioloïd*, is the name applied to cases of the disease in which the eruption runs a less severe course than usual. They may be at first discrete or confluent; but the pocks abort either at the papular or the vesicular stage, or if they become pustular are small, and dry up with unusual rapidity. The constitutional symptoms are correspondingly less marked. This form of the disease with rare exceptions occurs only in those who have been vaccinated, or have had a previous attack of smallpox. The form of the disease which follows Inoculation (q.v.) has a shorter incubation period (usually ten days), and a shorter and milder course; and the mortality is very much less than when it is contracted by infection.

The *cause* of smallpox is universally allowed to be a specific contagion, of whose nature we are in the most profound ignorance. There is probably no disease so contagious as this. Dr Haygarth stated (in 1793) that, during his long attention to this subject, not a single instance had occurred to prove that persons liable to smallpox could associate in the same chamber with a patient in the distemper without receiving the infection. The contagion acts either through the air, or by contact with the skin, or by inoculation; and the disease may be caused by the dead body, even when it has not been touched. What products of the diseased body are contagious is not exactly known, but the contents of the pustules and the dried scabs certainly are so. Opinions are divided as to the period at which the disease begins and ceases to be contagious. It is safest to maintain that it is capable of self-propagation as soon as the febrile symptoms have exhibited themselves. How soon the patient ceases to be dangerous cannot be decided with accuracy; but the stability of the contagious principle may be inferred from the fact that clothing will retain it for months, and it is said for years, when confined. Like all the contagious exanthemata, smallpox appears in an epidemic form, at irregular and, in our ignorance, it would almost seem capricious intervals. After an extraordinary exemption, perhaps for years, a district is suddenly invaded by it, and continues to suffer for a longer or shorter period, after which the disease spontaneously disappears—dies out, as it were—and does not reappear perhaps for years. Different epidemics vary very much in their severity, and isolated cases are usually milder than those occurring when the disease is epidemic. Race has

much to do with the severity of the disease; the constitution of the dark races, especially the Negro, being singularly susceptible of the contagion, and exhibiting very little power of resisting the fatal tendency of the disease.

It is generally admitted that the discovery of *Vaccination* (q.v.), by which smallpox is deprived of its danger, is the greatest triumph of modern medicine. *Inoculation* (q.v.) protected the individual, but, by spreading the disease, increased rather than diminished the total number of deaths, while vaccination has the advantage of protecting both the individual and the community.

With regard to prognosis, it may be stated generally, it is a very fatal, and was formerly an extremely destructive disease—one death occurring in every four or five cases. Modified smallpox is very seldom fatal, although instances of death are occasionally reported. Smallpox is more fatal at the two extremes of life than in the intervening period, and is especially dangerous in pregnancy. In olden times it was believed that the eruption was an effort of nature to get rid of the noxious matter, and hence heating and stimulating measures were adopted with the view of promoting the eruption. To Sydenham belongs the credit of first recommending an entirely opposite or cooling mode of treatment; but his suggestions met with the most strenuous opposition, and it was not till long after his death that the cooling treatment was fairly established. In mild cases, and in cases of modified smallpox, the physician has merely to guard the patient against hurtful influences, such as stimulating foods or drinks, too hot a room, or improper exposure to cold, and to prescribe cooling drinks during the fever, and occasional laxatives if they shall be required. In more severe cases the fever may be combated by saline purgatives, prescribed so as to produce two or three liquid stools daily, and by free ventilation of the surface of the body. When the eruption is all out, if the pimples on the face are few and distinct the danger may be regarded as over, and no further treatment is required. If, however, the disease assume a confluent form, wakefulness and restlessness are apt to come on about the eighth day, and opiates in free doses may be prescribed with benefit. If the pustules are abnormally torpid in reaching their maturity, it may be expedient to administer strong broths, or even wine; and when the pustules are livid, and intermixed with *Petechiæ* (q.v.), bark and acids must be additionally ordered, although the patient is then too often beyond the reach of help. During the secondary fever the bowels must be kept gently open, and opiates should be prescribed once or twice each day. A more nourishing diet is now called for, and wine should be given if the pulse is very weak. The external itching is partly relieved by the opiates, but local applications are also employed: cold cream, or a mixture of equal parts of olive-oil and lime-water, may be thus used with advantage. Numerous special methods have been devised for the purpose of preventing the pitting or seaming of the face, which is often a hideous permanent disfigurement to the patient, but there is not yet sufficient evidence that any of them is uniformly satisfactory in its results.

During the period of desquamation an occasional warm bath may be prescribed with advantage; and the patient should always resort to this measure, as a precaution against carrying the contagion about with him, before again mixing in society.

The history of this remarkable disease is clothed in considerable obscurity. Its original habitat is quite uncertain; but there seems no doubt that it has been prevalent in India from a remote period, and in China since at least 200 years before the

Christian era. It has been conjectured that it was one of the pestilences which occurred in Europe during the first and second centuries after that era; but the first accurate description of it is that of Rhazes, an Arabian physician, who flourished early in the 10th century. It appears to have reached England towards the close of the 9th century. After the Crusades it prevailed in most of the temperate countries of Europe, but did not reach the northern countries of Norway, Lapland, &c. for some time later. In 1517 it was carried from Europe to St Domingo; and three years later it reached Mexico, where it committed fearful devastations, and whence it spread with intense virulence throughout the New World. (According to Robertson, three millions and a half of people were destroyed in Mexico alone.) In 1707 it was introduced into Iceland, when more than a fourth part of the whole population fell victims to it; and it reached Greenland still later (1733), when it spread so fatally as almost to depopulate the country. These cases are striking illustrations of the law that seems universally true, that a contagious disease is always most virulent on its first introduction to a new scene of action. At the present day the interior of Africa, and especially the upper basin of the Nile, seems to be the region where smallpox is most destructive. In Europe it is constantly present in most of the large cities; but during the 19th century—i.e. since the introduction of vaccination—epidemics have been much less frequent and severe than before. The most intense and wide-spread was that of 1869-73 (see Report of Medical Officer of the Privy-council, 1874). Smallpox seems first to have been called by that name in the 15th century; *pockes* or *poz* (a contracted plural of pock) having come to be loosely used for several eruptive diseases, and especially for 'French pox' or syphilis. Till Sydenham's time measles and scarlet fever were frequently confounded with smallpox.

SMALLPOX IN SHEEP (*Variola ovina*), although resembling the smallpox of men, is a distinct disease, not communicable either by contagion or inoculation to men or children, or even to dogs or goats. It prevailed as an epizootic in England in 1277, was well known for more than 200 years previous to that date, but in more modern times it did not invade the country until 1847, when it broke out in a farm near Windsor, and quickly spread throughout Norfolk and the eastern counties, and in the summer of 1862 in Wiltshire, near Devizes. It is common on the continent of Europe. Variolous sheep or infected skins appear in both cases to have imported the disease from abroad. About ten days after exposure to contagion the infected sheep become feverish, have a muco-purulent nasal discharge, and a hot tender skin. The red pimples which first appear in about three days become white, and afterwards leave scabs or ulcers. The weakness is great, and the mortality varies from 25 to 90 per cent. Good food and nursing are the appropriate remedies. Promptly and carefully must the sick be separated from the sound; but if the spread of the disorder be not thus immediately checked the whole of the sound flock should be inoculated. The disease thus artificially produced appears in ten days, runs a mild course, occasions a loss of from two to five per cent., and in three weeks the disorder is got rid of and all risk of contagion over.

Smaragdite, a peculiar variety of Amphibole (q.v.), light grass green in colour, with a foliated, lamellar, or fibrous structure. It occurs as a constituent of the rock called Eklogite.

Smart, CHRISTOPHER, a hapless English poet, was born at Shipbourne in Kent, April 11, 1722,

and was educated at Maidstone, Durham, and Pembroke Hall, Cambridge, of which he was elected fellow in 1745. He won the Seatonian prize for an English poem on the attributes of the Supreme Being five times, and left college on his marriage to a step-daughter of John Newbery's in 1752. He now became a bookseller's hack, and made for some years a hard living betwixt improvidence, dissipation, and the expense of wife and children. His mind at last gave way, yet he lived on, with a few brief intervals of sanity, till his death in the rules of the King's Bench, on 21st May 1771. Smart was assisted by Samuel Johnson in his monthly publication, *The Universal Visitor*, and the moralist preserved a kindly feeling for him in his misfortunes. 'I did not think he ought to be shut up,' he said to Burney. 'His infirmities were not noxious to society. He insisted on people praying with him; and I'd as lief pray with Kit Smart as any one else. Another charge was that he did not love clean linen: and I have no passion for it.'

Smart's works include a number of feeble epigrams, birthday odes, and occasional poems; the *Hilliad*—a heavy satire in answer to a criticism of [Sir] John Hill's; a bald prose translation of Horace (1756), well known to schoolboys; a poor poetical translation of *Phædrus* (1765), and a still poorer metrical version of the *Psalms* (1765), of the *Parables* (1768). His poems were collected in 1791, but the editor was careful to exclude the only thing that now claims a notice, *A Song to David* (printed 1763; new ed. 1895), some of the stanzas of which are said to have been scratched with a key on the walls of his madhouse. The poem extends to a hundred stanzas, and is marred by repetitions, and grievous defects of rhythm and structure, but it shows a genuine spark of true poetic inspiration not common in its age, and it is not too much to say that the poor poet here for once 'had reached the zenith from his madhouse cell.' Rossetti called it 'the only great accomplished poem of the last century . . . A masterpiece of rich imagery, exhaustive resources, and reverberant sound;' but the praise is extravagant. Smart is one of the figures with whom Browning holds his *Parleyings*, and supplies a chapter to Mr Gosse in his *Gossip in a Library* (1892).

Smart, HENRY, composer (nephew of Sir G. T. Smart, 1776-1867, organist to the Chapel Royal), was born in 1813 and educated for the law. 'But in 1831 he became an organist, and as such was soon famous. As a composer he possessed a true vein of melody, and a symmetrical and elegant style, his church music (e.g. *Ave Maria*) and his part songs (e.g. *Lady, rise*) being his best-known works. An opera, *The Gnome of Hartzburg*; a secular cantata, *The Bride of Dunkerron* (1864); and a sacred cantata, *Jacob*, were his most ambitious compositions. He died 6th July 1879, not having survived to enjoy a civil list pension of £100 that had been granted to him. A Life by Dr Sparks was published in 1880.

Smartweed, a name given to some of the Milkworts (q.v.) on account of their acrid properties; especially the *Polygonum Hydropiper*, or Water-pepper.

Smeaton, JOHN, an eminent civil engineer, was born at Austhorp near Leeds, 8th June 1724, and early showed a bent towards mechanical pursuits. On leaving school, where he excelled in geometry and arithmetic, he entered his father's office as law clerk; but his heart was not in his work, and about 1750 he removed to London, to commence business as a mathematical instrument maker. In the following year his experiments in mechanical invention were resumed. His improvements on mill-work gained him the

Copley Medal of the Royal Society in 1759. In 1753 he was chosen a member of the Royal Society; and in the following year he visited the Netherlands, and inspected the engineering works of that country. In 1755 the second wooden lighthouse on Eddystone (q.v.) rock was destroyed by fire, and the re-erection of the work was entrusted to Smeaton. The new lighthouse was built of stone (1756-59), and this great work, the greatest of its kind hitherto undertaken, remained for 120 years a stable monument of Smeaton's engineering skill, till the erection of the new Eddystone close by (1879-82). Even after his great achievement Smeaton seems to have had little employment, as he applied for and obtained in 1764 the post of 'receiver of the Derwentwater estate;' and this situation he held till 1777, by which time he was in full professional employment. The chief of his other engineering works were Ramsgate harbour (1774); the Forth and Clyde Canal; several important bridges in Scotland (Perth, Banff, Coldstream), together with an immense amount of mill-machinery. He also improved Newcomen's steam-engine. He was in constant attendance in parliament during a large portion of his life. In 1783 his health began to decline, and he retired from active business, dying at Aushorp of paralysis, 28th October 1792. In 1781 Smeaton wrote a *Narrative of the Construction of the Eddystone Lighthouse*. The Society of Civil Engineers published posthumously his numerous professional Reports (3 vols. 1797), which were regarded by his successors 'as a mine of wealth for the sound principles which they unfold, and the able practice they exemplify.'

See a *Short Narrative of John Smeaton* (1793); and *Smiles's Lives of the Engineers* (vol. ii.; new ed. 1874).

Smectymnuus, a name compounded of the initials of the following five divines: Stephen Marshall, Edmund Calamy, Thomas Young, Matthew Newcomen, and William Spurstow, joint-authors of *An Answer* (1641) to Bishop Hall's *Humble Remonstrance to the High Court of Parliament* (1641), in defence of the liturgy and episcopal government. Of the five authors, the chief was Thomas Young, Milton's tutor.

Smedley, FRANCIS EDWARD, novelist, was born in 1818 at Marlowe. Always deformed, he took early to writing, his half-dozen works including *Frank Fairleigh* (1850), *Lewis Arundel* (1852), and *Harry Coverdale's Courtship* (1854). Bright cheery books, these appeared originally in *Sharpe's Magazine*, of which Smedley for a time was editor, and they were illustrated by Cruikshank and 'Phiz.' He died in London, 1st May 1864.

Smeinogorsk. See ZMEINOGORSK.

Smell. See NOSE, SENSATION.

Smelling Salts. See SALTS.

Smelt (*Osmerus*), a genus of the Salmon family (Salmonidæ), characterised by the strong fang-like teeth, especially on the tongue and on the tip of the vomer, and by the rather large scales, which readily fall off. The Common Smelt (*O. eperlanus*), called *Spirling* or *Sparling* in Scotland, and *Eperlan* in France, is a fish of 8 or 10 inches (rarely 12 inches) in length. The form is very trout-like, but rather more slender; the tail is larger in proportion, and more forked. The lower jaw is longer than the upper. The back is whitish, tinged with green; the upper part of the sides shows bluish tints, the lower part of the sides and the belly are of a bright silvery colour. The smelt has a peculiar, cucumber-like smell, and a delicious flavour, on account of which it is highly esteemed for the table. From the sea smelts often ascend estuaries and rivers, and they thrive well in lakes

and ponds. The same is true of the common American species—*O. mordax*. A third species—*O. thaleichthys*—of smaller size occurs on the Pacific coasts of North America, and another—*O. dentex*—on the corresponding Asiatic coasts. The name smelt is sometimes extended to related genera—e.g. Argentina, Retropinna, and the Pacific surf-smelts (Hypomesus).

Smelting. See COPPER, IRON, &c.

Smeru, or SEMIRU, the highest mountain of Java near the eastern end of the island. It is 12,240 feet high, and is an active volcano.

Smerwick, a peninsula and bay in County Kerry, Ireland, where in July 1579 Sir James Fitzmaurice landed, by authority of the pope, with a number of Italian and Spanish soldiers. They entrenched themselves within a fort, but in November were overpowered and put to the sword, to the number of six hundred, by Lord-deputy Grey and young Walter Raleigh. This gruesome story is introduced into Kingsley's *Westward Ho!*

Smetana, FREDERICK (1824-84), pianist and composer, was born at Leitomischl in Bohemia, and played or directed concerts till in 1874 he lost his hearing. He made artistic use of Bohemian music, and composed symphonic works in *Wallenstein's Camp*, *Richard III.*, *Earl Haco*, *Libusa*, &c., and operas (*Dalibor*, *A Kiss*, *The Secret*, &c.).

Smew. See MERGANSER.

Smilacæ, a tribe of the natural order Liliacæ, formerly by Lindley and others regarded as a distinct order under that name, and ranked by Lindley in his class Dictyogens (q.v.), and consisting of herbaceous or half-shrubby plants, generally more or less climbing, with reticulated leaves, and bisexual or polygamous flowers, a six-parted perianth, six stamens, a free three-celled ovary, with cells one or many seeded, three stigmas, and a roundish berry. The typical genus (*Smilax*) is, from an economical point of view, the most important of the tribe. Over 200 species are included in the sub-order, about 180 being comprised in the genus *Smilax*. The Sarsaparilla (q.v.) of commerce is the product of the roots of several species of *Smilax*; and the large fleshy tubers of *S. China*, a native of China and Japan, are regarded as nutritious and are used for food. *S. pseudo-China*, an American species, has similar tubers, which are used for making beer and for fattening hogs in some parts of the southern United States.

Smiles, SAMUEL, author of *Self-Help*, was born at Haddington in 1812. His family owed much to the intelligence, shrewdness, and force of character of their mother, who, when left a widow with a family of eleven, continued successfully to conduct a small business. Samuel Smiles had artistic leanings, but studied medicine in Edinburgh, took his degree when he was twenty, and published at his own expense a work on *Physical Education* (1838). At first he practised in Haddington as a medical man with small success, lectured on chemistry, and wrote articles for an Edinburgh newspaper. He settled as a surgeon in Leeds, but abandoned this for the editorial chair of the *Leeds Times*. He became secretary of the Leeds and Thirsk Railway Company in 1845, and in 1854 secretary of the South-Eastern Railway, retiring in 1866. While at Leeds he came into contact with George Stephenson, and conceived the idea of writing his life, a work which he eventually accomplished (1857). *Self-Help* followed in 1859, and was soon an assured success, 20,000 copies being sold during the first year, and up till 1889 the sales had reached 150,000 copies, while the book had been translated into seventeen languages. Some young men in Leeds who met in the evening for self-education had asked Smiles 'to talk to them

a bit; though really written before, it was only after the success of Stephenson's life that *Self-Help* appeared. Henceforward his career was that of a popular author and compiler, varied by travel to the scenes of the labours of the characters he described. An attack of paralysis while he was engaged upon *Thrift* in 1871 yielded to complete rest and a change of employment. He received the degree of LL.D. from Edinburgh University in 1878.

To the *Self-Help* series of books he added *Character* (1871), *Thrift* (1875), *Duty* (1880), and *Life and Labour* (1887). Works which teach the same truths by example are *Lives of the Engineers* (1861); *Industrial Biography* (1863); *Lives of Boulton and Watt* (1865); *Thomas Edward* (1876); *George Moore* (1878); *Robert Dick* (1878); *James Nasmyth* (1883); *Men of Invention and Industry* (1884). Besides contributions to the *Quarterly Review*, he also published *The Huguenots in England* (1867), and *The Huguenots in France* (1873); *A Publisher and His Friends: John Murray* (1891); and *Jasmin, the Barber-poet* (1891). The main value of these books is their homely practical nature, and the enforcement of everyday precepts by example.

Smirke, SIR ROBERT, architect, was the son of Robert Smirke (1752-1845), a well-known painter and book-illustrator, and was born in London in 1780. He became R.A. in 1811, was architect to the Board of Works, and was knighted in 1831. He died at Cheltenham, 18th April 1867. Smirke's public buildings are usually classical, his domestic dwellings Gothic. London is full of his work. Covent Garden Theatre (1809) was his first great undertaking; the British Museum (1823-47) the greatest. Others of his buildings are the Mint, the Post-office, several of the clubs (including the Carlton), the College of Physicians, King's College, and courts of justice in various parts of the country. He was entrusted with the restoration of York Minster after the fire (1829). Lowther Castle is a specimen of his domestic architecture. His brother Sydney Smirke, R.A. (1799-1877), was associated with him in some of his labours.

Smith, one of the oldest and most wide-spread of English family names, not to be regarded as belonging to one but to very many distinct families. It is, of course, derived from the honourable trade of the smith; the smith being originally a worker in metal or wood, and so nearly equivalent (when not compounded as in goldsmith, locksmith, arrow-smith) to 'craftsman' or 'artificer.' At first the name was not hereditary, but was used as a description of the individual: in the 14th century we have John Smyth, son of Thomas Wright (John being a smith and Thomas a carpenter); John's son might be called William Smythson, and his daughter Mary Smythdoughter. But soon the name became purely hereditary; and it is obvious that there would be many founders of Smith families. Philip le Smethe, William le Smyt, Henry le Smeyt show ancient forms of the name; Smyth, Smythe, and Smiith (derived from a form with a dotted y, Smyth) are also old variants which still survive. Smithson, Smithman, Brownsmith, Redesmith, Nasmyth (= Nail-smith), &c. are derivative forms. Corresponding in meaning is the Latin *Faber*; French, *Le Fevre*, *Lefevre*, or *Lefebvre*; Italian, *Fabrani*; German, *Schmidt*; Dutch, *Smid* and *Smits*. The Celtic *Caird* and *Gow* are nearly equivalent. The English names *Ferrier*, *Ferrers*, *Ferrars* are from the Latin *Ferrarius*, 'farrier' or 'shoosmith.' See NAMES.

In the London directory the Smiths fill eight pages (averaging 200 entries) of the commercial section (as against four pages of Joneses, and four of Browns), and three in the Court directory—not all undistinguished. Sir Hugh Smithson, who married the heiress of the Percies (q.v.), was created Duke of Northumberland in 1776; the

Viscounts Strangford were Smythes; and the widow of the Right Hon. William Henry Smith (q.v.) was in 1891 made Viscountess Hambleden. And there were in 1892 six baronets and twenty-four knights bearing the name of Smith (in its several spellings); and sixty entries in the index of Burke's *Peerage* testify to the aristocratic connections of the Smiths. There is a work by H. S. Grazebrook on *The Heraldry of Smith* (1870); and by F. M. Smith on *The Heraldry of Smith in Scotland* (1873). In English literature they constitute a mighty army: Allibone's *Dictionary of British and American Authors*, with its supplement (1891), enumerates no less than 1069 several and distinct authors of the name of Smith (seventy-five of them William Smith), without counting Smyth, &c. The editor of the *Dictionary of American Biography* has thought no less than 199 persons of the name worthy of notice in that work. To such exhaustiveness the present work cannot pretend; but besides the subjects of the 18 articles below, we add a list of 22 Smiths whose names are more or less familiar in philanthropy, literature, science, or art.

Anker Smith, engraver (1759-1819); Charles Roach Smith, antiquary (1805-90); Charlotte Smith, poet and novelist (1749-1806); Eli Smith, American missionary to Syria (1801-57); Sir Francis Pettit Smith, mechanical inventor (1808-74; see p. 404); George Smith, of Chichester, landscape-painter (1714-66); Gerrit Smith, American philanthropist (1797-1874); Henry Boynton Smith, D.D., American Presbyterian divine (1815-77); James Smith of Deanston, Scottish agriculturist (1789-1850); James Edward Smith, botanist (1759-1828); John Smith, mezzotint engraver (1652-1742); John Raphael Smith, painter and mezzotinter (1750-1812); John Pye Smith, D.D., LL.D., divine and geologist (1774-1851); John Stafford Smith, composer (1750-1836); Robert Angus Smith, Scottish chemist and hygienist, author of *Air and Rain*, &c. (1817-84); Robert Archibald Smith, composer of Scotch songs and psalm-tunes (1780-1829); Very Rev. Robert Payne Smith, Dean of Canterbury, orientalist and divine, Bampton Lecturer on Prophecy (born 1818); Sir Thomas Smith, Elizabethan statesman and scholar, author of *De Republica Anglorum* (1512-77); Thomas Smith, of Derby, painter (c. 1709-69); Thomas Southwood Smith, M.D., hygienist, author of *Philosophy of Health and Epidemics* (1790-1861); William Henry Smith, author of the philosophical novels *Thorndale* and *Gravenhurst* (1808-72); also Charles Piazzi Smyth, ex-astronomer-royal for Scotland (born 1819).

Smith, ADAM, the founder of political economy as a separate branch of human knowledge, was born in the town of Kirkcaldy, Fife, on 5th June 1723. His family belonged to the respectable middle class; his father was comptroller of the customs at the port of Kirkcaldy, and his mother, Margaret Douglas, was the daughter of a small Fifeshire laird. His father died a short time before his birth, and the boy was the object of the care and solicitude of a widowed mother, to whom he was closely attached, and who lived to be proud of his attainments. When he was no more than three years old the poor woman got a sad fright, from a calamity hardly known at the present day—the child was stolen by tinkers; but he was tracked and recovered by his uncle as they were seeking a hiding-place in the neighbouring wood of Leslie. This was the only adventure in his quiet life. After getting the usual burgh-school education in Kirkcaldy, he was sent, in 1737, to the university of Glasgow, where he seems to have devoted himself mainly to mathematics and natural philosophy, though Hutcheson was the professor of moral philosophy. He secured an exhibition on the Snell foundation, which took him to Balliol College, Oxford, where he studied for seven years, and left traditions as of a man of large acquisitions and peculiar independence of

thought. It is said that he was intended for the English Church, but if so his own convictions crossed the designs of his friends. He returned to Kirkcaldy, and lived for a while with his mother there in undisturbed seclusion and study. In 1748 he came to Edinburgh, where silently and unostentatiously he became one of the brilliant little circle of men of letters who were then rising to importance, amongst his friends being David Hume, John Home, Dr Hugh Blair, Lord Hailes, and Principal Robertson. In 1751 he got the chair of Logic in the university of Glasgow, and this was changed a year afterwards for that of Moral Philosophy. In 1759 appeared his *Theory of Moral Sentiments*, celebrated for its reference of the mental emotions to the one source of sympathy. The *Dissertation on the Origin of Languages* was published along with the later editions of this book. Both had a great reputation in their day, and, although they are now obscure books in comparison with that other by which the author's name is remembered, the position they held with respectable thinkers gave a hearing to his doctrines on political economy which they would hardly have otherwise obtained. In 1762 the university of Glasgow gave him the degree of Doctor of Laws. In the following year he undertook a task, which might at first seem very uncongenial to a mind like his, given to retired study and independent thought and action—he became 'governor' or travelling tutor to the young Duke of Buccleuch. He was then sedulously collecting materials for his great work, and no doubt the inducement to accept the office was the opportunity it gave him for travelling and seeing for himself. He had the opportunity of being nearly a year in Paris, and of mixing in the circle of renowned wits and philosophers of the reign of Louis XV., including Quesnay, Turgot, and Necker. In 1766 his engagement came to an end, and he returned to Kirkcaldy to live in the old house with his mother.

The year 1776 was an era in the history of the world as well as that of the Kirkcaldy recluse, by reason of the appearance of the *Inquiry into the Nature and Causes of the Wealth of Nations*. If there was any living man to whose works he was indebted for the leading principles of this book it was David Hume, and it was from him, as best understanding the fullness and completeness of the exposition, that it had its first emphatic welcome. He wrote immediately on receiving it: 'Euge! Belle! Dear Mr Smith, I am much pleased with your performance; and the perusal of it has taken me from a state of great anxiety. It was a work of so much expectation by yourself, by your friends, and by the public that I trembled for its appearance, but am now much relieved. Not but that the reading of it necessarily requires so much attention, and the public is disposed to give so little, that I shall still doubt, for some time, of its being at first very popular. But it has depth, and solidity, and acuteness, and is so much illustrated by curious facts that it must at last take the public attention.' This was not destined to be exactly the literary history of this great work. Its startling doctrines, fine clear style, and abundant illustration from curious facts took at first; but counteracting influences arose when people saw how far the new doctrines went in playing havoc with old prejudices. The French revolution set the mind of the country bigotedly against everything that breathed of innovation. It was known that the younger Pitt participated at first in Smith's free-trade notions, but he had afterwards, whether from permanent conviction or temporary policy, to put himself in the foremost ranks of the enemies of innovation. It was not until long after the terrors of that epoch and the nervous vicissitudes

of the war had passed over that Smith's work had an opportunity of revolutionising the public mind on matters of trade and finance. It came up, as it were, the leader of a great literary host, for expounders long crowded in numbers round *The Wealth of Nations* as the text-book of sound economy. It has been made matter of reproach against this work that it is not systematic in its form and that its nomenclature is not exact. But its author was not arranging the results of established knowledge—he was rather pulling down existing structures, compounded of ignorance and prejudice. Nor, indeed, have those who have attempted to make an exact science out of political economy practically vindicated the reproach they have cast on him of being unmethodical. Whatever we may yet come to, very few portions indeed of political economy admit of being treated as exact science; it is too closely connected with human passions and energies, and consequently with special results and changes, to be so treated.

In 1776 he lost his friend David Hume. He watched by him on his death-bed, and wrote an account of his last illness and death in a memorable letter to Mr Strahan in London. Soon afterwards he established himself in London, and became a member of the club to which Reynolds, Garrick, and Johnson belonged, though with the last Smith's relations were not uniformly amicable. In 1778 he was made a Commissioner of Customs. The only effect of this was to bring him to Edinburgh, and increase his means for indulging in his favourite weakness, the collection of a fine library; for he was, as he called himself, a 'beau in his books.' He lost his worthy mother in 1784; in 1787 he was chosen Lord Rector of Glasgow University; and he died 17th July 1790.

Smith's position in the history of political economy, his relation to his predecessors the physiocratic school, and his influence on later economists have been considered in the article POLITICAL ECONOMY. It is a mistake to hold that the barren principle of *laissez-faire* was the teaching of Adam Smith. Smith held it to be the duty of the state to protect its citizens from infectious diseases, to endow by charter joint-stock companies with exclusive trading privileges, to enforce military training on all males, and to establish compulsory and cheap education; state intervention being, however, justified only where the work cannot be done by individuals, or not so well as by the state. Smith's works were edited in 5 vols. by Dugald Stewart in 1811-12, and contain, besides the *Theory of the Moral Sentiments* and the *Wealth of Nations*, essays on the first formation of languages, on the history of astronomy, ancient physics, and ancient logic, and on the imitative arts. There have been numerous editions of the *Wealth of Nations*, by M'Culloch (1850), Thorold Rogers (1880), and Professor Nicholson (1884). His system has been dealt with by all subsequent economists, and in all civilised languages. His Glasgow lectures on *Justice, Police, Revenue and Arms* were published in 1897. See Lives by Dugald Stewart (1811), Farrer ('English Philosophers,' 1881), Haldane ('Great Writers,' 1887), and John Rae (1895).

Smith, ALBERT, was born at Chertsey, Surrey, on 24th May 1816, and educated at Merchant Taylors' School. He entered the Middlesex Hospital, and, after in 1838 becoming an M.R.C.S., proceeded to Paris to complete his studies. He then commenced practice with his father, but soon relinquished it for lecturing and light literature, and published upwards of a score of books, some of which were illustrated by Leech. His novels include *The Adventures of Mr Ledbury* (1844), *Scattergood Family* (1845), *Marchioness of Brinville* (1846), *Christopher Tadpole* (1848), and *The Pottleton Legacy* (1849); of his entertainments the most successful was 'The Ascent of Mont Blanc' (1852). He appeared in this at the Egyptian Hall only two days before his death, which took place at Fulham on 23d May 1860.

Smith, ALEXANDER, poet, was born 31st December 1830 at Kilmarnock, but was brought up at Paisley and Glasgow. He received the usual Scottish schooling, and then had to give up all thoughts of the ministry for his father's calling of pattern-designer in a Glasgow warehouse. Here he began to write verses, some of which gained admission to the *Glasgow Citizen*. Through George Gilfillan his *Life Drama* appeared in several issues of the *London Critic* (1851), and was reprinted the next year in a volume of which 10,000 copies sold in a very few months. A reaction, however, set in; and the author had scarcely found himself famous when he began to be fiercely assailed. The faults of his book were obvious enough; every page bore evidence of immaturity and its natural result, extravagance; while a somewhat narrow reading having made him passionately attached to a few modern poets, such as Keats and Tennyson, their turns of expression reappeared in his verse, and gave colour to the charge of plagiarism which was carried to an absurd length. Still, he has always a richness and originality of imagery that more than atone for all defects of taste and knowledge; and no poet since Shakespeare's day has written occasional lines with a more Shakespearian ring. In 1854 he was appointed secretary to the university of Edinburgh, and next year produced *Sonnets on the War* in conjunction with Sydney Dobell (q.v.), his brother-poet in the 'Spasmodic' school. He afterwards wrote *City Poems* (1857); the Northumbrian epic, *Edwin of Deira* (1861); and, in semi-poetic prose, *Dreamthorp: a Book of Essays* (1863); *A Summer in Skye* (1865); and *Alfred Hugart's Household* (1866), a simple and touching story of Scottish middle-class life. In 1857 he married Miss Flora Macdonald from Skye; and he died at Wardie, near Edinburgh, 8th January 1867.

See the Rev. T. Brisbane's *Early Years of Alexander Smith* (1869), and the Memoir by P. P. Alexander prefixed to his *Last Leaves* (1869).

Smith, GEORGE, Assyriologist, was born of humble parentage in London on 26th March 1840. Whilst pursuing his trade of bank-note engraver he found means to study the cuneiform inscriptions in the British Museum, and through the kindly notice and assistance of Sir Henry Rawlinson and Dr Birch was in 1867 appointed an assistant in the department of antiquities in that museum. He helped the former to prepare the third volume of *Cuneiform Inscriptions* (1870), and through his skill as an interpreter of the Assyrian monumental writing not only was able to fix the dates of important events in the history of the East, but discovered the *Chaldean Account of the Deluge* (1872). He likewise furnished (1871) the key to the interpretation of the Cypriote character and script. In 1872 he was sent by the proprietors of the *Daily Telegraph* to Nineveh in quest of discoveries; the collections he brought home were presented to the nation. The British Museum commissioned him (1873) to return and complete the excavations he had begun amongst the ruin-mounds of ancient Assyria, an account of which expedition, entitled *Assyrian Discoveries*, was published in 1875 (7th ed. 1883). Whilst on a third visit to the same regions he suddenly died at Aleppo, in Syria, on 19th August 1876. Besides the books quoted, he wrote *Annals of Assurbanipal* (1871), perhaps his most important publication; *History of Assyria* (1875); *Eponym Canon* (1875), a work on oriental chronology; *History of Babylon* (ed. Professor Sayce, 1877); *History of Sennacherib* (ed. Professor Sayce, 1878); and papers contributed to *Translations of Biblical Archaeology* and the first series of *Records of the Past*.

Smith, GOLDWIN, son of a Berkshire physician, was born at Reading, 13th August 1823. He received his education at Eton and Oxford, where he had a brilliant career, completed by a first-class in classics in 1845. In 1847 he was elected Fellow of University College, and in the same year he was called to the bar at Lincoln's Inn. He was nominated assistant-secretary to the first, and secretary to the second Oxford University Commission, and served on the Popular Education Commission in 1858. He was regius professor of History at Oxford from 1858 till 1866. During the American civil war he was a strenuous upholder of the North, writing several pamphlets in support of the Federal cause, and in 1864 lectured in the United States. In 1868 he was elected to the chair of English and Constitutional History in the Cornell University at Ithaca, New York. In 1871 he settled in Canada, where he became a member of the senate of Toronto University. He edited the *Canadian Monthly*, 1872-74, and founded and for a time edited *The Week* and *The Bystander*. He regards the annexation of Canada to the United States as inevitable, and strongly advocates commercial union or complete reciprocity between the two. He has written much for periodicals, and has contributed to this Encyclopædia. Among his works are *Irish History and Irish Character* (1861); *Lectures on the Study of History* (1861); *Rational Religion* (1861); *Empire* (1863); *The Civil War in America* (1866); *Three English Statesmen* (Pym, Hampden, and Cromwell, 1867; new ed. 1882); *A Short History of England* (1869); *The Political Destiny of Canada* (1879); *Couper* (1880); *Lectures and Essays* (1881); *Jane Austen* (1890); *The United States* (1893); *Questions of the Day* (1894); &c.

Smith, HENRY JOHN STEPHEN, mathematician, was born in Dublin, November 2, 1826, and was educated at Rugby and Balliol College, Oxford, taking a double-first in 1849. In 1861 he became Savilian professor of Geometry. He died February 3, 1883. He was the greatest authority of his day on the theory of numbers (see his *British Association Reports* from 1859 to 1865), and also wrote on elliptic functions and modern geometry. In 1881 the French Academy offered their 'Grand Prix' for a demonstration of certain theorems, ignorant of the fact that they had already been demonstrated fourteen years before by Smith, to whom accordingly the prize of 3000 francs was awarded, but not till a month after his death. He was a man of great versatility, geniality, soundness of judgment, and delicacy of humour.

Smith, JAMES and HORACE, authors of *The Rejected Addresses*, were the sons of an eminent London solicitor, and were born, the former on 10th February 1775, the latter on 31st December 1779. Both were educated at Chigwell in Essex. James succeeded his father as solicitor to the Board of Ordnance; Horace adopted the profession of a stockbroker, and realised a handsome fortune, on which he retired with his family to Brighton. Both were popular and accomplished men—James remarkable for his gaiety and conversational powers, and Horace—the wealthier of the two—distinguished for true liberality and benevolence. Both had written for the *Pic-nic* (1802), the *Monthly Mirror* (1807-10), &c., when the committee of management advertised for an address to be spoken at the opening of the new Drury Lane Theatre in 1812, and the brothers adopted a suggestion made to them, that they should write a series of supposed 'Rejected Addresses.' They accomplished the task in six weeks—James furnishing imitations of Wordsworth, Southey, Coleridge, Crabbe, Cobbett, &c., and Horace those of Scott, Byron (all but the first stanza), 'Monk' Lewis, Moore, W. T. Fitzgerald,

and others. In point of talent the authors were about equally matched; for though James had the greatest number of successful imitations, the most felicitous of the whole is Horace's 'Tale of Drury Lane, by W.S.' ('I must have done this myself,' said Walter Scott, 'although I forget on what occasion.') It is a curious fact in literary history that the *Rejected Addresses* should themselves have suffered rejection, and that the copyright, offered originally to Murray for £20 and refused, was purchased by him for £131 in 1819, after the book had run through sixteen editions, and had brought its authors over £1000. James was afterwards an occasional contributor to the periodical literature of the day, and received £1000 for writing Charles Mathews' 'entertainments.' Horace between 1807 and 1845 produced more than a score of three-volume novels—*Brambletye House*, *Tor Hill*, &c. These are forgotten, but a new edition of his *Tin Trumpet* (1836) appeared in 1869, in which year also an *édition de luxe* of the *Rejected Addresses* was published at New York. Of Horace's *Poems* (2 vols. 1846) the best known is the 'Ode to an Egyptian Mummy.' James died in London on 24th December 1839, and Horace at Tunbridge Wells on 12th July 1849.

See PARODY; also vol. i. of Hayward's *Biographical and Critical Essays* (1858), and Timbs's *Lives of the Wits and Humourists* (1862).

Smith, JOHN, one of the Cambridge Platonists, was born early in 1616, the son of a small farmer at Achurch, near Oundle, in Northamptonshire. At eighteen he entered Emmanuel College, Cambridge, as a sizar, had Whichcote for his tutor, graduated B.A. in 1640, but missed a fellowship in his own college, as another Northamptonshire man already held one. However, the Earl of Manchester's clearances at Queen's College opened up for him a fellowship there in June 1644. Here he laboured with diligence as Hebrew lecturer, Censor Philosophicus, Greek Prælector, and became in 1650 Dean of the college and Catechist. But his feeble health gave way, and he died, after a long illness borne with saintly patience, 7th August 1652, and was buried in the college chapel. His funeral sermon was preached by Simon Patrick, who wrote long after in his *Autobiography*, 'Blessed be God for the good I got by him while he lived.' His *Select Discourses* was published in 1660, again in 1673, in 1821, and at the Cambridge press in 1859. A selection was edited by Lord Hailes in 1756. The subjects of these Discourses are the True Way of attaining to Divine Knowledge, Superstition, the Immortality of the Soul, the Existence and Nature of God, Prophecy, Legal and Evangelical Righteousness, the Shortness of a Pharisæical Righteousness, the Christian's Conflicts with, and Conquests over, Satan, and the Excellency and Nobleness of True Religion—the last an especially admirable treatise, marked at once by strong thought and spiritual inwardness.

Smith, CAPTAIN JOHN, adventurer and explorer, was born at Willoughby, Lincolnshire, in 1580, and was educated at the schools of Alford and Louth. On his father's death in 1596 he made up his mind to go to sea, but instead his guardian bound him apprentice to a merchant of Lynn. Business not being to his mind, he accompanied the second son of Lord Willoughby to France, and at Havre saw some soldiering under Henry IV. Next we find him in the Low Countries, whence he crossed to Scotland, returned to Willoughby, lived in a wood and studied Machiavelli and Marcus Aurelius, and exercised himself on a good horse with lance and ring. As the Turks were at that time ravaging Hungary he made up his mind to join the Christian army, and was robbed by

four adventurers in France on his way thither. He joined a half-merchant, half-pirate, and in coasting round Italy and the north of Africa they were enriched by the capture of a Venetian argosy. Next at Grätz, in Styria, he entered the service of Ferdinand, Duke of Austria, under whom he greatly distinguished himself, and had some astonishing adventures. He was sold as a slave and marched to Adrianople, but escaped and travelled through Germany, France, Spain, and Morocco. After a sea-fight with two Spanish men-of-war he returned to England in 1604 enriched with 1000 ducats. In 1605 he joined the expedition of a London company to colonise Virginia. In April 1607 Jamestown was founded on the James River. On the way out Smith had been accused of conspiracy and narrowly escaped hanging, but in June 1607 he had his full liberty, and was admitted to the governing council. There was a desperate scarcity of food, and in endeavouring to find supplies, he fell into the hands of Powhatan, an Indian chief, and was only saved from being clubbed to death by the intervention of the Princess Pocahontas (q.v.). Smith was elected President of the colony in 1608, but returned to England disabled by an accident with gunpowder towards the end of 1609. During 1610–17 he was again in North Virginia; and he died in London, 21st June 1631. His works include *A True Relation of Occurrences in Virginia* (1608), *A Description of New England* (1616), *New England's Trials* (1620), *General History of Virginia* (1624), and *True Travels of Captain John Smith* (1630). In Charles Deane's edition of *A True Relation* (Boston, 1866) doubts were first raised as to the veracity of the Pocahontas story. Professor Arber, who edited a careful reprint of Smith's works in 1884, believes in him implicitly; but doubts are again raised in Henry Adams' *Historical Essays* (1892). There are Lives by Scheibler (1782), Sparks (1834), Simms (1843), Warner (1881), and Ashton (1884).

Smith, JOSEPH. See MORMONS.

Smith, ROBERT, whose name lives in the Smith's Prizes at Cambridge, was born in 1689, and was cousin to the mathematician Roger Cotes, whom he succeeded as Plumian professor of Astronomy at Cambridge in 1716. He succeeded Bentley as master of Trinity College in 1742, published *Harmonia Mensurarum* (1722), *A Complete System of Optics* (1738), and *Harmonics, or the Philosophy of Musical Sounds* (1748), edited the *Lectures on Hydrostatics and Pneumatics* of Cotes in 1737, and died at Cambridge in 1768.—The two Smith Prizes, now amounting to about £23 each, are, by a Grace of October 1883, awarded annually for the essays of greatest merit on any subject in mathematics or natural philosophy by recent B.A.'s. Holders have been Henry Martyn, J. Herschel, Whewell, Airy, Colenso, Stokes, Cayley, J. C. Adams, Lord Kelvin, Tait, and Clerk-Maxwell.

Smith, SIR SIDNEY, the hero of Acre. See SMITH (SIR WILLIAM SIDNEY).

Smith, SYDNEY, wit and reformer, was born at Woodford, Essex, on 3d June 1771, the second in a family of four sons and one daughter. His father, Robert Smith (1739–1827), was a clever eccentric, who 'bought, altered, spoilt, and then sold about nineteen different places in England;' from his mother, Maria Olier (died 1802), the daughter of a French Huguenot, he derived all his finest qualities. After five years at Southampton, in 1782 he was sent to Winchester, where he rose to be captain of the school, and whence, having first spent six months at Mont Villiers in Normandy, in 1789 he proceeded to New College, Oxford. He duly obtained a fellowship, but of only £100 a year, and in 1794 was ordained to the Wiltshire curacy of

Netheravon, near Amesbury. 'Mr Hicks-Beach,' he tells us, 'the squire, took a fancy to me, and requested me to go with his son to reside at Weimar; but Germany became the seat of war, and in stress of politics we put into Edinburgh, where I remained five years' (1798-1803). During this time he officiated in an Episcopal chapel there, and published *Six Sermons* (1800); married in 1800 a Miss Pybus of Cheam in Surrey; and in 1802, with Jeffrey, Horner, and Brougham, started the *Edinburgh Review* (q.v.), writing eighteen of the articles in the first four numbers. He next lived six years in London, and soon made his mark as a preacher, a lecturer at the Royal Institution on moral philosophy (1804-6), and a brilliant talker; but in 1809 'was suddenly caught up by the Archbishop of York, and transported to the living of Foston in Yorkshire, where there had not been a resident clergyman for 150 years,' but where he continued for twenty as 'village parson, village doctor, village comforter, village magistrate, and *Edinburgh* reviewer.' He farmed his glebe and built a parsonage, but was pinched in his means till in 1820 he came into £400 a year. In 1828 Lord Lyndhurst, the Tory chancellor, presented him to a prebend of Bristol, and next year enabled him to exchange Foston for the more desirable rectory of Combe-Florey in Somerset. In 1831 Earl Grey appointed him a canon residentiary of St Paul's, and this completed his round of ecclesiastical preferment. Visions of a mitre had sometimes crossed his waking dreams, but those dreams were never to be realised. However, he managed to 'grow old merrily' at Combe-Florey, which, in his own phrase, 'bound up well with London.' In London he died at his house, 56 Green Street, Grosvenor Square, on 22d February 1845. He is buried at Kensal Green.

Sydney Smith's writings include sixty-five articles, collected in 1839 from the *Edinburgh Review*, where they had appeared during 1802-27; *Peter Plymley's Letters* (1807-8), in favour of Catholic emancipation; *Three Letters to Archdeacon Singleton on the Ecclesiastical Commission* (1837-39); and other letters and pamphlets on the ballot, American repudiation, the game-laws, prison abuses, &c. They deal mainly with dead abuses and forgotten controversies, and their very success has consigned them to oblivion: who nowadays cares to study the cleverest arguments against seven years' transportation for poaching? So that their author is chiefly remembered as the creator of 'Mrs Partington,' the kindly sensible humorist who stands immeasurably above Theodore Hook, if a good way below Charles Lamb.

His *Life* (1855) was written by his daughter Saba (1802-66), who in 1834 married Dr (Sir) Henry Holland (q.v.); vol. ii. consists of selections from his *Letters*, edited by Mrs Austin. See also vol. i. of Hayward's *Biographical and Critical Essays* (1858), and Stuart J. Reid's *Life and Times of Sydney Smith* (1884; new ed. 1896).

Smith, WALTER CHALMERS, Scottish poet, was born in Aberdeen in 1824, studied at Old Aberdeen and Edinburgh, and, after holding a Presbyterian charge in London for some years, laboured as a minister of the Free Church at Orwell (Kinross-shire), in Edinburgh, in Glasgow, and again in Edinburgh in the Free High Church. Widely popular as an amiable and accomplished man and an admirable preacher, he has won the favour of a yet larger public by a series of volumes of poetry marked by richness of thought, creative imagination, and lyrical charm, although unequal and not seldom careless in construction. These are *The Bishop's Walk*, by 'Orwell' (1861); *Olrig Grange*, by 'Hermann Kunst' (1872); *Hilda among the Broken Gods* (1878); *Raban, or Life Splinters* (1880); *North-Country Folk* (1883); *Kildrostan*,

a Dramatic Poem (1884); *Thoughts and Fancies for Sunday Evenings* (1887); *A Heretic* (1890).

Smith, WILLIAM, called the Father of English Geology, was born at Churchill in Oxfordshire, 23d March 1769. He became a land-surveyor and engineer, and so was naturally drawn to geology; and in 1794, after his appointment as engineer to the Somerset Coal Canal, he began his study of the strata of England. His epoch-making Geological Map of England was published in 1815, and from 1819 to 1824 he published, with self-denying zeal, no fewer than twenty-one geologically coloured maps of English counties, assisted in the latter task by his nephew and pupil, John Phillips, afterwards professor at Oxford. Smith received the LL.D. degree from Trinity College, Dublin, in 1835, and a pension of £100 from the crown in 1831. He died at Northampton, 28th August 1839. He was buried here, and thus had his wish to be buried in the Oolite as he had been born on it. See his *Memoirs* by Professor Phillips (1844).

Smith, SIR WILLIAM, eminent for his advancement of classical and biblical learning, was born in London in 1813, distinguished himself highly in Greek and Latin in the examinations of the university of London, and went through the course of law at Gray's Inn. But he began the real work of his life in 1840 with the publication of editions of the *Apology*, *Phædo*, and *Crito*, of Plato, and the *Agricola*, *Germania*, and part of the *Annals* of Tacitus. His great *Dictionary of Greek and Roman Antiquities* appeared in 1840-42, and was only superseded by its own third edition in 1891 (2 vols.). The *Dictionary of Greek and Roman Biography and Mythology* (3 vols. 1843-49) followed, and this magnificent series of classical handbooks was concluded by the *Dictionary of Greek and Roman Geography* (2 vols. 1853-57). Their learned editor next turned, and with still more striking success, to the task of preparing a series of smaller classical dictionaries for schools; and some years later still achieved further successes with his well-known series, *Principia Latina* and *Initia Græca*, on a method extended also to German and Italian. Students' manuals of history formed the next series of books he edited, including *Greece*, *Rome*, *France*, *Hume*, and *Hallam*. His complete edition of Gibbon's *Decline and Fall* appeared in 1854 (8 vols.); his serviceable *Latin-English Dictionary* in 1855; the *Student's Latin Grammar* in 1863; the *Manual of English Literature* in 1864; and the *English-Latin Dictionary* in 1870.

Another monumental group of works is his series of theological dictionaries: the famous *Dictionary of the Bible* (3 vols. 1860-63; new ed. 1893); *A Dictionary of Christian Antiquities*, in conjunction with Archdeacon Cheetham (2 vols. 1875-80); and *A Dictionary of Christian Biography, Literature, Sects, and Doctrines during the first eight Centuries*, in conjunction with Dr Wace (4 vols. 1877-87). He became editor of the *Quarterly Review* in 1867, held the D.C.L. of Oxford (1870) and other honorary degrees, and was knighted in 1892. He died on the 7th October 1893.

Smith, WILLIAM HENRY, newsagent, book-seller, and Cabinet Minister, was born in London, June 24, 1825. He was educated at the grammar-school, Tavistock, and while a youth entered his father's business, and rose step by step to be head of the firm. This, the largest wholesale newspaper business of the kind in Britain, was founded by his father (born 1792), who saw that the London newspapers, sent off by the evening coaches only, were not delivered in Manchester and Liverpool until forty-eight hours after publication. He conceived the idea of forwarding the papers by express parcel, with private coaches leaving London in the

morning, so that the night coaches were overtaken, and the delivery of news secured twenty-four hours in advance. As the business expanded, to this was added the right of selling books and newspapers at railway stations (Birmingham Railway, 1849). Mr W. H. Smith was as strong in organising faculty as his father had been, and business was extended. He represented Westminster, 1868-85; was returned for the Strand in 1885 and again in 1886. He held the posts of Financial Secretary of the Treasury (1874-77), first Lord of the Admiralty (1877-80), Secretary of State for War (1885); in Lord Salisbury's ministry he was first Lord of the Treasury and leader of the House of Commons till his death, October 6, 1891. His widow was raised to the peerage as Viscountess Hambleden. He was distinguished for conscientious discharge of duty, and in 1889 received a handsome memorial from members of the House of Commons, and was entertained to a banquet. He was an honorary D.C.L. of Oxford. He left a fortune of £1,776,000 in personality, besides several estates. See his *Life* by Sir Herbert Maxwell (2 vols. 1893).

Smith, WILLIAM ROBERTSON, theologian and orientalist, was born at Keig, Aberdeenshire, on 8th November 1846. He received all his early training from his father, the Rev. William Pirie Smith, D.D., minister of the Free Church at Keig. He entered the university of Aberdeen in 1861, and graduated after an exceptionally brilliant career in 1865. He afterwards studied theology at the Free Church College, Edinburgh, at Bonn, and at Göttingen; while in Edinburgh he was also assistant to the professor of Physics (Professor P. G. Tait) in the university there. Immediately on the conclusion of his theological studies he was elected by the Free Church Assembly of 1870 to the vacant chair of Hebrew and Old Testament Exegesis in the Free Church College, Aberdeen; his suggestive inaugural address being *What History teaches us to seek in the Bible* (1870). At an early stage in the preparation of the ninth edition of the *Encyclopædia Britannica* he was invited to contribute articles upon Biblical subjects. The first of these ('Angel') appeared in 1875. That on 'Bible' (1875), a brief objective account of the now well-known historical and scientific facts of the subject, was almost immediately assailed on the ground of its heterodoxy—especially for its acceptance of the non-Mosaic authorship of Deuteronomy. (The question of the date of the Priestly writing—see PENTATEUCH—with Nöldeke on one side and Graf and Kuenen on the other, was at that early stage of the discussion left open in the encyclopædia article.) In consequence of the excitement that had been aroused, the Assembly of 1876 referred all Mr Smith's articles then published to a committee, which reported in 1877 that there was no ground for a heresy prosecution, but added that a majority of the members of the committee had found cause for 'alarm' and 'anxiety' in the article 'Bible' on account of its 'dangerous and unsettling tendency.' In these circumstances a prosecution for heresy was instituted before the Free Presbytery of Aberdeen. A long process ensued, in the course of which Mr Smith displayed remarkable debating talents, and in the end, after many vicissitudes in the various courts of the church, the trial resulted in the acquittal of the accused at the Assembly of 1880 by a majority of 7 in a house of nearly 600 members. In consequence, however, of the article on 'Hebrew Language and Literature,' which appeared in the *Ency. Brit.* in June 1880, Mr Smith was not allowed to resume his teaching duties during the following winter; and although no new heresy was alleged to have been broached in that article, he was removed from his chair without a trial by a considerable majority at

the Assembly of 1881. Mr Smith, who, besides contributing largely to successive volumes of the *Encyclopædia Britannica*, had written several important pamphlets in connection with his trial, delivered at the request of a number of laymen in Edinburgh and Glasgow in 1880-81-82 two series of lectures substantially republished in the two well-known volumes entitled *The Old Testament in the Jewish Church* (1881) and *The Prophets of Israel* (1882). In 1881 Mr Smith transferred his residence to Edinburgh, and became actively associated with Professor Baynes in the editorship of the *Ency. Brit.*; on the death of his colleague he had the undivided responsibility of editor-in-chief. In the beginning of 1883 he was appointed Lord Almoner's professor of Arabic in the university of Cambridge, where shortly afterwards he was elected to a fellowship at Christ's College. His work on *Kinship and Marriage in Early Arabia* was published in 1885. In 1886 he was elected by the Cambridge senate to the university librarianship, which office he exchanged for the Adams professorship of Arabic in 1889. As Burnett lecturer he delivered at Aberdeen in 1889-91 three courses of lectures on the religion of the Semites; the first series was published as the *Religion of the Semites* (1889). After several years of greatly impaired health, he died 31st March 1894. Mr Smith received in 1890 the degree of D.D. from the university of Strasburg; the published éloges (understood to be from the pen of Professor Reuss) particularises with justice and discrimination his conspicuous acumen, unsurpassed learning, indefatigability and success as a historical investigator, and sedulous and pious promotion of untrammelled criticism.

Smith, SIR WILLIAM SIDNEY, the hero of Acre, was born at Westminster, 21st July 1764, entered the navy at eleven, and received a lieutenancy for his courage at Cape St Vincent in 1780. After further service under Graves and Rodney, he rose to the rank of captain in 1782; gave advice to the king of Sweden in the war with Russia (1790-92), being knighted as a reward; was next sent on a mission to Constantinople, and aided Hood in burning the ships and the arsenal at Toulon in December 1793. He next watched the Channel for French privateers, but was taken prisoner in Havre-de-Grâce harbour in April 1796. He succeeded in making his escape in 1798, and in October was sent as plenipotentiary to Constantinople, whence he hastened to St Jean d'Acre on hearing that Bonaparte was about to attack. On the 16th March 1799 he captured the enemy's vessels, and he held the town heroically until Napoleon raised the siege, leaving his artillery behind, on the 20th May. For this he received the thanks of parliament and a pension of £1000. Sir Sidney Smith next aided Abercromby in Egypt, became rear-admiral of the blue in 1805, and successively guarded Sicily and Naples, destroyed the Turkish fleet in Abydos (1807), blockaded the Tagus, became vice-admiral of the blue in 1810, K.C.B. in 1815, and admiral in 1821. He died at Paris, 26th May 1840. See the *Life* by Barrow (1848).

Smithfield, or **SMOOTHFIELD**, is an open space of 5½ acres in London, used for centuries as a market for sheep, horses, cattle, and hay. Being a little north of Newgate and west of Aldersgate, it was outside the city walls, and available for jousts, tournaments, executions, and burnings. It was also a place of recreation for the people, and the celebrated Bartholomew Fair (q.v.) was held in Smithfield. Here the patriot Wallace was executed by Edward I.; here in the great agrarian revolt Wat Tyler, at the head of 30,000 peasants, encountered Richard II., and was stabbed by Walworth, the Mayor of London; and it was here

that many of the long line of martyrs from 1401 to 1612 suffered in the flames or on the scaffold. With the growth of the city the cattle-market became an intolerable nuisance (described in *Oliver Twist*), and was finally closed in 1855 (see SLAUGHTER-HOUSES). The hay-market goes on, but the centre of the space is laid out as a garden with fountains. The Smithfield Club (1798) holds its annual cattle shows in the Agricultural Hall.

Smithfield, a village (pop. 800) of Virginia, on a navigable creek 24 miles WNW. of Norfolk, contains in St Luke's Episcopal Church (1632; built of imported brick) the oldest Protestant building in America, and after the adobe cathedral at Santa Fé the oldest surviving Christian edifice in the United States.

Smithsonian Institution, at Washington, D.C., was organised by act of congress in 1846 in accordance with the will of James Macie Smithson (1765-1829), who, in a fit of pique at the Royal Society's rejection of a paper which he had submitted in 1826, bequeathed the reversion of an estate of £105,000 to the United States of America to found 'at Washington an establishment for the increase and diffusion of knowledge among men.' He was an Englishman, a natural son of Sir Hugh Smithson, first Duke of Northumberland, and Mrs Elizabeth Macie, a niece of Charles, Duke of Somerset. He devoted his life to scientific pursuits, especially to chemistry and mineralogy, was a Fellow of the Royal Society from 1787, and for long a member of the French Institute, and died in Genoa. The Institution is a body of which the presiding officer *ex officio* is the president of the United States, and the Chief-justice of the United States customarily the chancellor. It is governed by a board of regents appointed by the Federal government, its direction under them being confided to a chief officer styled the Secretary. It has a spacious and beautiful building, forming one of the chief architectural adornments of the capital, which is occupied by offices and workrooms, but mainly by the collections of the government, which also fill a separate adjoining edifice covering nearly 2½ acres. In these buildings under its ownership or direction are the results of the exploring, surveying, geological, ethnological, and other expeditions of the Smithsonian and the government, known as the United States National Museum. The work of the institution is to promote original research; to publish the results of investigations, and distribute them freely to libraries in every land; to facilitate the interchange of scientific thought and labour, by sending and receiving free of cost the publications of all learned societies. It has a library of 100,000 volumes. Its publications consist of a quarto series, *Smithsonian Contributions to Knowledge*, an octavo series, *Miscellaneous Collections*, both published at the expense of the fund, and an annual Report printed by congress. The Smithsonian fund now consists of \$703,000, on which and on all sums not to exceed a million dollars congress pays 6 per cent. interest. This is entirely distinct from the sums annually appropriated by government for the following bureaus of the Institution: (1) the National Museum, (2) the Bureau of Ethnology, (3) the Bureau of International Exchanges, (4) the National Zoological Park, (5) the Astro-physical Observatory. These sums (about \$300,000) are under the direction of the institution. See *Nature*, xl. 346, liii. 257-261; Rhee, *Smithson and his Bequest* (1880); E. B. Goode, *The Smithsonian Institution* (1897).

Smith's Sound. See BAFFIN BAY; also POLAR EXPLORATION, and map there.

Smock-frock, an outer garment of coarse white linen worn by agricultural labourers over their

other clothes, especially in the south of England. It is like the French blouse, but longer; and the shoulders are often somewhat elaborately ornamented with neatly sewn folds and puckers.

Smoke, a common term to signify the volatile products of the imperfect combustion of such organic substances as wood or coal. The smoke from burning wood is almost colourless, consisting principally of carbonic acid and water, whilst that produced by burning coal is generally laden with oily and tarry vapour and finely divided carbon (or soot). The different effects resulting from the use of these varieties of fuel is exemplified in the brightness of Paris as compared with the (too generally) gloomy atmosphere of London. In London the smoke nuisance is an old grievance; Evelyn the diarist wrote his *Fumifugium* in 1661; and in his diary explains the unpleasantness of the great fog of the winter of 1684 (when a fair was held on the Thames), and justly ascribes it to the 'fuliginous steam of the sea-coale.'

The smoke nuisance may justly claim pre-eminence for itself in Great Britain, where coal is generally cheap, and where its users either from ignorance or prejudice refuse to adopt means for its proper combustion. In bright warm windy weather the smoke so produced is carried away from towns and factories, and becomes lost to view by mixing with the air; but in cold calm weather with an atmosphere saturated with moisture (or what is a true white fog) the smoke is arrested, and mixing with it gradually accumulates, and forming as it were a vast aerial emulsion of water vapour, tarry matter, and soot, gives rise to the black or brown fogs now so common in the large cities. With a view to the prevention of such a disagreeable and dangerous condition of the atmosphere much has been attempted, more especially by the Society for the Abatement of the Smoke Nuisance (see its *Memoirs*), but so far without beneficial results.

In this article there falls to be explained, first, the causation of such dark-coloured fogs; secondly, what has been done and what may yet be effected in the direction of their prevention. (1) When a microscopic slide is passed quickly over a smoky flame, a thin, semi-transparent film is left on the glass, which when examined under a powerful microscope presents the appearance of numerous particles of amorphous carbon in a finely divided condition, each particle being surrounded by an areola or coating of oily or tarry matter. This explains why a black fog may be and will remain persistent, even while rain is falling, each particle of carbon being, so to speak, surrounded by a waterproof coating which repels moisture. Aitken has conclusively proved that the cause of the separation of liquid water from a moisture-laden atmosphere or white fog is due to particles of fine dust present in the air (see FOG, Vol. IV. p. 706). We should therefore expect that the introduction of solid particles of carbon into such an atmosphere would have the same effect, which doubtless would be the case did not each particle repel the vaporous particles of water in its immediate neighbourhood; at the same time their density is insufficient to cause them to fall through the turgid atmosphere as smuts.

In a smoky town when a breeze prevails the smoke in its horizontal passage through the air gradually parts with its greasy-coated carbon to anything which impedes its progress, such as buildings, trees, &c.; so much so that only a few miles away it loses its dolorous aspect and assumes the soft, dreamy haze so dear to the painter, but which after all is only an air emulsion of finely attenuated particles of grease.

The densest fog of this kind on being agitated will deposit all its carbon as smuts, and become

changed into a white fog or mist; therefore changes of temperature causing convection currents, or electrical discharges, will disperse the densest fog with extraordinary rapidity. In like manner such a fog finding its way into a dwelling-house is exposed to currents of dry heated air, in which the condensed moisture reassumes its gaseous or invisible condition, while the other constituents are deposited as a grimy coating upon its walls, furniture, &c. Likewise in breathing such a fog-laden atmosphere the carbon and oily products are arrested by the air-passages, and become apparent in the expectorated secretion from the bronchial tubes. A comparatively small amount of solid carbon and oily vapour may thus bring about atmospheric conditions wholly at variance with all ideas of beauty, comfort, and cleanliness. Of course with perfect combustion only carbonic acid and water vapour are the products; both being colourless vapours. There are numerous mechanical stokers by which the green fuel is gradually carried from the furnace doors to the fire bridge, by which means the smoke and tarry vapours given off during the distillation stage are forced over the mass of incandescent fuel occupying the posterior position in the furnace. In some cases the fuel is also by mechanical means fed from the bottom of the grate bars, by which means the same end is gained. The only objection to the general use of such stokers is the expense of erection, and the cost of upkeep.

(2) *Smoke Abatement.*—It has been pointed out that wherever smoke is agitated—e.g. by atmospheric or electric currents—its carbon is quickly deposited by its particles agglomerating into masses too heavy to remain in suspension. This may be simply shown, as, when smoke is agitated by fanners or air-currents in a closed space, in a short time it loses its characteristic black colour, the carbon being deposited as smuts (see 'Condensed Carbon Particles in Smoke,' *Jour. Soc. of Chem. Ind.*, vol. ix.).

Other plans by which smoke from furnaces is passed through water and washed have been tried with more or less success, and may come to be compulsorily adopted in factories, as is now the case with iron blast-furnaces, where the products—viz. carbon, hydrocarbons, ammonia, and even the carbonic and sulphurous acids present in all coal-smoke—are profitably utilised. From each ton of coal used in iron-smelting are obtained, of oil used for lucifers for burning, 64 lb.; pitch, 84 lb.; sulphate of ammonia, 20 lb.; the gross value about 3s. 6d., less charges. The net saving on each ton of coal may be taken at 2s., which is about one-fourth of the cost of the coal. By means of such appliances there is now no difficulty in preventing the emission of coloured smoke from any factory-chimney (Elliott's, Mond's, and other processes). But the real difficulty which meets all attempts at smoke abatement lies in the sentimental desire for the cheerful though smoky blaze of English house-fires. This causes, it has been estimated, in London alone the production of thousands of tons of black smuts per annum, which descend either on the city itself or in its immediate vicinity.

Long ago it was pointed out that to obtain the full advantage of the use of coal it should be carbonised—i.e. heated in closed retorts, when the whole of the volatile products, consisting of oil, tar, and gas (which latter is the immediate cause of the production of smuts), would be properly utilised, leaving a coke which would not only burn with a smokeless flame, but give out, weight for weight, a much larger amount of available heat than the uncarbonised coal. At the same time the inflammable gas (one of the products of this process) would either alone or mixed with the coke yield, when properly burned, a smokeless fuel for

use in kitchens or fireplaces, thus doing away with this serious evil, as well as effecting an annual saving estimated by Macaulay at 45,000,000 tons of coal (representing a sum equal to £15,750,000) in Great Britain alone.

Many attempts have been made to effect this by constructing house-grates and cooking-ranges so that the raw coal is introduced from the bottom—i.e. at the fire-bars or grids, so that all gaseous products have to pass through an incandescent mass of carbon before reaching the chimney. But such attempts in general have failed, owing to the mechanical difficulties which have to be overcome and which would necessitate the entire reconstruction of the present house-heating arrangements.

In addition to the extreme discomfort and interruption to traffic which such fogs cause, it has hitherto been supposed that they seriously affect health (see FOG); but the general death-rate is not so much increased (see the publications of the Society for the Abatement of the Smoke Nuisance). Doubtless this may in part be owing to the disinfecting properties of carbon and sulphurous acids, in excess in the atmosphere at such periods.

Smokeless Powder. See GUN-COTTON, RIFLES, &c.

Smoking. See HAM, PRESERVED PROVISIONS. For smoker's sore throat, see TOBACCO.

Smoky Mountain. See APPALACHIANS.

Smolensk, a town of Russia, and an important railway centre, is situated on steep declivities overlooking the river Dnieper, 244 miles by rail W. by S. of Moscow. It is one of the oldest towns in the empire, having been a place of note in the 9th century, is surrounded by massive walls (now falling into ruin), has a cathedral of the 17th and 18th centuries, and was from the 14th century a powerful fortress, and as such an object of contention between the princes of Lithuania and Poland on the one side and of Moscow on the other. Here the Russians, under Barclay de Tolly and Bagration, were repulsed by Napoleon, August 17, 1812, when on his march for Moscow. Pop. 34,348.—The government has an area of 21,632 sq. m. and a pop. of 1,278,117. Almost all the land is farmed by peasant communes.

Smollett, TOBIAS GEORGE, physician, poet, novelist, journalist, historian, was a Dumbartonshire gentleman, belonging to that upper class of Scottish society—the lawyers and landed gentry—to which Sir Walter Scott also belonged. He was educated for the medical profession, but failed to make a living by it. He drifted into literature, and by it he made a precarious living and a lasting name. For the failure of his life in material success he was himself largely to blame. Handsome, upright, generous, of genuine humour, a pleasant companion on occasions, he yielded from his youth to (among other mischievous propensities) the evil habit of epigrammatic sarcasm on one or other of the company he was in. Proud, vindictive, of hot temper and haughty manner, as sensitive as he was satirical, he was a foreordained failure as a doctor, and foredoomed to quarrels, lawsuits, fine and imprisonment, and money difficulties in general as a journalist. The little poetry he wrote was not of great merit. His history was, as David Hume estimated it, a clever superficial review of the subject. It was the novels that made his name, and three of them maintain it.

Smollett was grandson of Sir James Smollett of Bonhill, advocate, member of the Scottish parliament, commissioner of the treaty of Union, and judge in the consistorial court. The fourth son of Sir James and his first wife, daughter of Aulay Macaulay of Ardencaple, was Archibald, who,

without his father's sanction and without means to support a wife, married Barbara, daughter of Robert Cunningham of Gilbertfield, a young lady of good family but portionless. Sir James assigned to the imprudent couple Dalquhurn, the second house on the estate, and the few fields around it, on which stand now the villages of Alexandria and Renton. The third child of Archibald and Barbara was Tobias George, born at Dalquhurn, birthday not recorded, baptised on Sunday, March 19, 1721. His father died shortly after, and his grandfather in 1731. Sir James and his successor would seem to have behaved with reasonable kindness to the widow, a clever managing woman, and her three orphan children. Smollett went to Dumbarton grammar-school, was taught Latin well by John Love, and distinguished himself by the luxuriance of his boyish satire. He went to Glasgow College, attended arts and medical classes, and while attending them served an apprenticeship to John Gordon, doctor, apothecary, and very worthy man. It was thus he qualified for medical practice. Subsequently, in June 1750, he obtained the degree of M.D. from Marischal College, Aberdeen. In 1739 he went to London and tried to get *The Regicide, a Tragedy*, put on the stage. He failed, quarrelled with everybody about it, and published it ten years later with a very foolish preface. He romances about the ill-usage he and it underwent in the story of Melopoyne in *Roderick Random*. Smollett was appointed surgeon's mate on board the *Cumberland*, which sailed in 1740 to join Admiral Vernon's fleet, and took part in the unfortunate expedition to Carthage in 1741. He describes that expedition in *Roderick Random*, and also in a *Compendium of Voyages and Travels* he published in 1756. His temper could not brook the service; he quitted it in the West Indies and tarried a while in Jamaica, where he met Anne Lascelles, the expectant heiress of 'a comfortable, though moderate, estate in the island.' In 1744 he set up house in London, in Downing Street, afterwards in Mayfair, to look for medical practice. He wrote *The Tears of Scotland* in a coffee-house in 1746. The same year he published *Advice, a Satire*—his first publication. Next year he published *Reproof, a Satire*, and married Anne Lascelles. *The Adventures of Roderick Random*, written autobiographically, appeared anonymously in 1748, and was at once a great success; Lady Mary Wortley Montagu thought the novel was Fielding's. It was heartless to caricature his grandfather as the Old Judge and Mr Gordon as Potion. In 1750 Smollett visited Paris along with Mr Moore—afterwards Dr Moore, novelist, father of Sir John Moore—and met Mark Akenside there. In 1751 was published, written biographically, *The Adventures of Perigrine Pickle*. It too had an instant success. The doctor, who gives an entertainment after the manner of the ancients, is a misrepresentation of Dr Akenside, and the laughable account of the feast is a satire on his peilantic affectation of Athenian manners. Smollett was paid for inserting 'The Memoirs of a Lady of Quality, Frances Hawes, Lady Vane,' which are a blot on the novel. He now tried to set up in Bath as a medical man, publishing *An Essay on the External Use of Water*; it was his last attempt of the kind, and it failed. Returning to London to live by his pen, he fixed his abode in Chelsea, and published *The Adventures of Ferdinand, Count Fathom* in 1753. The robber scene in the Black Forest, from that story of a gambler and swindler, has been the prototype of many such, and is a literary masterpiece. About this time an action was raised in the Court of King's Bench against Smollett for caning a person named Gordon. The verdict was in his favour, but the law-costs embarrassed him. In 1755 his

translation of *Don Quixote*, which is still read, was favourably received. He became in 1756 editor of *The Critical Review*, a High Church and Tory monthly. Countless troubles to the editor culminated in 1759, when Admiral Knowles brought an action against the *Review*, and Smollett was fined £100 and sent three months to the King's Bench Prison. In 1756 he also began a *Complete History of England* from the time of Julius Cæsar's invasion down to 1748. He wrote the four quarto volumes in fourteen months, finishing the work in December 1757. This effort brought on chest disease and a scorbutic affection; he never enjoyed good health again. After coming out of prison he wrote a continuation of the history down to 1764, which is better known than the *Complete History*; for in Hume and Smollett's *History of England* the narrative of events from 1689 to 1760 is Smollett's. From all this labour on history he is 'said to have cleared £2000.' In 1757 his farce, *Reprisals, or the Tars of Old England*, was put on the stage by Garrick. Smollett toiled at compiling a universal history and translating Voltaire. *The Adventures of Sir Launcelot Greaves*, an English Don Quixote, appeared as a serial, 1760-61, in the *British Magazine*, a sixpenny monthly, and was published separately in 1762. Like all the novels Smollett wrote, it is weak in construction, but lacks neither vivacity nor wit. He edited *The Briton*, 1762-63, a weekly paper in support of Lord Bute's administration, received no reward, and was routed from the newspaper field by the *North Briton*, the organ of his former friend, John Wilkes. In April 1763 Elizabeth, his only child, died of consumption. He left England in June, sojourned on the Continent more than two years, and published in 1766 the still readable *Travels through France and Italy*. The same year he, broken in health, visited Scotland—his second visit since he left as a lad—and while in Edinburgh stayed with his mother and widowed sister. His health benefited by this journey, but on his return south it broke down again. He left England in 1768 to seek recovery in a warmer climate. He had the year before solicited a consulship at Nice or Leghorn—the only favour he ever asked from government—was refused it, and went to live in Italy, relying on his wife's small and always uncertain income and on his pen. He wrote the *Ode to Independence* about this time. *The History of the Adventures of an Atom*, a prose satire, in which political leaders are broadly caricatured under fictitious names, was published in 1769. In a village, called Monte Novo, near Leghorn, Smollett wrote, in weakness and much pain, the last and best of his novels, *The Expedition of Humphrey Clinker*, written in epistolary form. The 'Ode to Leven Water' occurs in it. It was published in 1771; and Smollett just lived to hear the first rumours of its success. He died, September 17, 1771, aged fifty-one, and was buried in the English cemetery, Leghorn. If he had lived four years longer he would have inherited the family estates; as it happened, he left his widow quite unprovided for. Her small income from the West Indies by and by failed entirely, and there was a benefit performance in the Theatre Royal of Edinburgh in her behalf when she was destitute twelve years after his death. The novels which have become classics are the three in which Smollett himself is adumbrated as, respectively, the Scottish Roderick Random, the English Peregrine Pickle, and the Welsh Matthew Bramble.

Plays and Poems, with Memoir (1 vol. 12mo. 1784). *Miscellaneous Works*, first collected by David Ramsay of the *Edinburgh Evening Courant*; humorous frontispieces by Rowlandson; meagre life (6 vols. 8vo. Edin. 1790; does not contain *Adventures of an Atom*).

Miscellaneous Works, with Memoir, by Robert Anderson, M.D., carefully edited (6 vols. 8vo. Glasgow, 1796); *Expedition to Carthage* added to 2d edition (6th ed. 1820). *Works, with Memoir*, by John Moore, M.D. (8 vols. 8vo. Lond. 1797), carelessly edited; memoir valuable owing to personal intimacy. *Miscellaneous Works, with Memoir*, by Thos. Roscoe (1 vol. large 8vo. Lond. 1840; many editions—latest, 1878; New York, 1857, 6 vols. 12mo.). Sir W. Scott's *Biographical Prefaces*, published separately (2 vols. 12mo. Paris, 1825). *Life and Selections*, by Robert Chambers, LL.D. (1867). *Life*, by D. Hannay ('Great Writers' series, 1887). *Works*, carefully selected—the three classical novels, the plays, the poems—with *Life and Notes* by the present writer; *Notes* fill up blanks left by Smollett (1877). See also Hazlitt's *Comic Writers*, Thackeray's *Humourists*, and Masson's *British Novelists*.

Smolt, a name given to young river salmon when they are bluish along the upper half of the body and silvery along the sides.

Smuggling, originally and strictly a crime of commerce, a violation of customs laws, to be distinguished from such a crime of manufacture as illicit distillation, which violates excise laws. But the term is commonly applied also to the evasive manufacture and disposal of commodities liable to excise as well as to the clandestine importation of articles on which customs duties have been imposed (see CUSTOMS DUTIES, EXCISE). Defrauding the government of revenue by the evasion of customs duties or excise taxes may therefore serve as a definition. The evasion of customs duties is the prevailing sense of the term in the popular mind, a sense in which there are in all nations stirring stories of smuggling rich in romantic incident. But, in the accepted use of language, the other sense is quite common. A case reported (June 1891) in the leading newspapers, as 'Smuggling in London,' was that of two men brought before a police-court on the charge of defrauding the revenue by illicit distillation in a warehouse in Holborn. A great deal of smuggling of the manufacturing kind is constantly carried on all over Great Britain and Ireland. The government is regularly defrauded of revenue in this way to a far greater amount, it is believed, than it is now by the commercial smuggling reported annually by the commissioners of customs. We read frequently of raids by revenue officers on smuggling bothies in the Highlands of Scotland. In July 1891 an important seizure was reported to have been made in one of the haunts of a smuggling fraternity on the Gairloch, between whom and the people of the Outer Hebrides, where no distilleries exist, a brisk trade in spirits is carried on. But men well qualified to form a correct opinion believe that the revenue is defrauded by illicit distillation all over the country a great deal more than it is in the wild districts of the north. In the manufacturing centres skilful mechanics make their own utensils and tools for the purpose, and repair and alter them easily. The Highlanders are obviously at a disadvantage in this respect. Since the duty was taken off malt by Mr Gladstone in 1880 there have been facilities for this kind of smuggling which, there is good reason to believe, have been taken advantage of in the cities and manufacturing towns, and an occasional find of the kind is reported. But the revenue of the country is buoyant, and it is not desirable to make too frequent exposure of crimes so obviously created by act of parliament; the chiefs of the excise branch of the inland revenue department do not, accordingly, encourage too curious enquiry on the part of local revenue officers. In these circumstances exact information on the subject is not available.

Smuggling, in the sense of evading customs duties by dealing in contraband goods, has ceased

to deserve the name of a trade in the United Kingdom. From about the close of the 17th century to nearly the middle of the 19th century the suppression of that kind of free trade by vigorous methods of prevention engaged the close attention of the inland revenue department. Free trade as a national policy has put down the smuggling trade. Only a very small number of persons comparatively deal in contraband goods now. But when the duties on spirits were higher in England than in Scotland, Northumberland and Cumberland were haunted with smugglers. Haddington and Berwick and the Scottish counties on the Solway were long demoralised by unwise tariffs on articles of import from abroad. Readers of Scott's novels know the effective use he makes of smuggling for the purposes of his art in *Guy Mannering* and *Redgauntlet*. Robert Burns was an exciseman, and it was also one of his duties to prevent the smuggling of contraband goods. It is well known how in 1792 he placed himself on one occasion at the head of the revenue officers and a guard of dragoons, waded the Solway sword in hand, was the first to board a smuggling brig, captured the crew, and had the brig sold at Dumfries. It was on that occasion that Burns wrote 'The Deil's awa' wi' the Exciseman.' The exploits of smugglers and constabulary in the frequent and bloody encounters that took place constitute the main interest of many an exciting tale.

The contrabandista used to be one of the most popular characters in Spain. The exports from England to Gibraltar, to refer only to one of his lines of activity, used to be large, and were introduced by smugglers to the interior of Spain. It was remarked fifty years ago or more that it would be nearly impossible to prevent the smuggling of British goods into the United States on the Canadian frontier if the duties on importation were excessive. These duties are now very excessive, and inferences are allowable; but the United States government does not compile statistics of smuggling either by the frontier or by the ports. The injudicious tariffs which used to be imposed by both England and France encouraged smuggling to an enormous extent on both sides of the English Channel; spirits, especially brandy, tea, tobacco, silk goods from France; from England the most important article of illicit trade was cotton-twist. English goods were introduced into France chiefly by the Belgian frontier, and dogs were trained to convey them; a dog would convey goods worth from £20 to £50. There used to be cruel slaughter of these dogs, a reward of three francs being given by the customs authorities for every one seized. A great historical outburst of smuggling was the answer which commercial enterprise gave to Napoleon's Berlin and Milan decrees. Silk from Italy reached England by Smyrna after being a year on passage, by Archangel after being two years. Cotton-twist, coffee, sugar, tobacco were shipped from England to Salonica, conveyed thence by mules and horses through Servia and Hungary to Vienna, and distributed over the Continent from that capital. Coffee from London would reach Calais by Vienna. The risks and expense raised the price of sugar on the Continent to 6s. a pound.

In 1831 an official report estimated the loss by smuggling to the British revenue as exceeding £800,000 a year (in French brandy to the extent of £500,000). Three-fourths of the tobacco consumed in Ireland was smuggled; the total annual cost of protecting the revenue was then from £700,000 to £800,000. In 1840 it was believed that 48 per cent. of French silks paid no duty. The south coast of England, especially Kent and Sussex, was largely addicted to the smuggling trade with France, by which it was stated that goods to the

value of £2,000,000 were conveyed into France from England by the Belgian frontier alone. Till a comparatively recent date the Isle of Man (q.v.) was a great emporium for smuggling into England, Scotland, and Ireland.

In the *Cornhill Magazine* for June 1891 there is an article on smuggling still carried on across the Swiss-French frontier. Tobacco, sugar, and coffee are smuggled from Switzerland into France; cattle, gunpowder, and household goods from France to Switzerland. 'The smugglers usually pass the frontier,' says the writer, 'by a dangerous passage across the river Doubs and the rocks of its vicinity, called the Saut du Doubs. The perils of this romantically beautiful passage are increased by the darkness, the fear of custom-house officers, and by heavy packages of contraband goods which impede the free use of the limbs. Each man is armed with an alpenstock and a pistol; he carries his burden fastened to his back by a heavy strap which can be detached and the bundle rolled down the adjacent precipice at the first signal of danger and pursuit.' Such is the serious business of men who make smuggling a trade on that frontier. But, in a less risky way, 'wagoners, dogs, travellers, railway officials, and even the custom-house officers themselves are all more or less engaged in smuggling. . . . Ladies, ever alive to the delights of a bargain, are inveterate smugglers.' The writer tells us that the smugglers who make a business of it are admired and aided by the peasants on both sides of the frontier. Morality is popularly regarded as immutable, and tariffs are very mutable. The people never did associate ideas of right and wrong with smuggling in any country. The smuggler was everywhere regarded as a benefactor, because the people believed that he supplied better articles at a cheaper rate than those on which customs or excise duties were paid.

The principal articles liable to duty at present in the United Kingdom are cocoa, coffee, currants, raisins, beer, spirits, wine, tea, tobacco. In the last decade of the century smuggling, judged by the number of cases discovered, greatly decreased. In the year ending 31st March 1898 there were 4255 seizures of all kinds, including 6244 lb. tobacco and cigars and 59 gallons spirits. The total number of convictions was 2424, and the total amount of penalties recovered £4174. These figures may be compared with those for the preceding decade:

Year ended 31st March.	Total Number of Seizures of Smuggled Goods of all kinds.	Number of Seizures of Coffee, and Foreign Spirits.	Quantities seized.		Number of Persons convicted.			Penalties recovered.	
			Tobacco and Cigars.	Foreign Spirits.	In Summary Cases.	In Non-Summary Cases.	Total.	Number.	Amount.
1881	1391	1265	21,473	197	1146	67	1213		
1882	1698	1540	25,653	432	1424	92	1516	1395	3529
1883	1799	1601	20,454	194	1423	30	1453	1352	3966
1884	2238	2110	24,556	514	1708	99	1807	1663	7302
1885	2698	2445	17,485	141	1849	101	1950	1793	4589
1886	2641	2426	18,972	162	1898	98	1991	1876	4122
1887	2577	2344	23,657	470	1695	108	1803	1666	4044
1888	2860	2477	20,185	467	1667	83	1750	1666	3568
1889	4354	4209	16,246	535	3224	70	3294	3294	5999
1890	5518	5206	18,084	187	4441	56	4497	4432	8088

Summary cases are disposed of by the magistrates, and are those in which the quantity of tobacco and cigars seized does not exceed 20 lb., of spirits not above five gallons. Larger quantities are dealt with by information and summons as non-summary cases. Of the £7302 of penalties recovered in 1884 £3142 were paid by two parties. It will be seen that the total number of seizures in the year ending 31st March 1890 exceeds those of the previous year

by 1164. About 1000 of these were seizures of tobacco in various forms or of spirits. The quantity of tobacco again exceeds that seized in the previous year by 1838 lb.; while of spirits seized there were only 187 gallons as against 535 gallons—a remarkable decrease. The total increase of seizures in the year 1890, therefore, may be taken, so the commissioners say, to consist of small quantities of tobacco or cigars, averaging from 1 lb. to 2 lb. in weight. It will be seen again that while there was an increase of 1203 in the total number of persons prosecuted, there were only 70 non-summary cases in 1889, 56 in 1890, a decrease of 14; and the penalties show an average of £2 a head. The figures, as thus compared, show a large number of attempts to smuggle tobacco in small quantities. This is confirmed by the following curious item of information supplied by the commissioners: 'The larger seizures dealt with by summons and prosecution comprise several instances of the seizure of tobacco-stalks landed from vessels belonging to the royal navy. Tobacco is issued to the crews of H.M. ships of the navy in the form of unmanufactured leaf, and, in preparing it for use, the men remove the mid-rib of the leaf, which they are enjoined by regulations to destroy; the landing of the stalk, formed by the mid-rib when separated from the leaf, being prohibited by law. Under the existing law . . . drawback can be claimed upon snuff produced by grinding up stalks and other tobacco refuse, and a considerable trade has existed in consequence in certain localities, with the intervention of the receivers, between seamen and others employed on board H.M. ships and persons who purchase stalks for the purpose of obtaining drawback upon the snuff produced from them. In several cases prosecutions have been successfully instituted, and it is hoped that a check has been put to this illegal traffic.' The figures show also that tobacco and spirits are now practically the only articles smuggled, and that the quantity of these so dealt with is comparatively infinitesimal.

See W. D. Chester, *Chronicles of the Customs Department* (1885); Lieut. H. N. Shore, *Smuggling Days and Smuggling Ways* (1892); also the articles COASTGUARD and TAX in this Encyclopædia.

Smut, or BUNT (sometimes also called Dust-brand), is the popular name of certain small fungi which infest flowering land-plants, especially

the grasses. This name is derived from the appearance of the spores, which are nearly black and very numerous. At the present time the group is called the *Ustilaginæ*. Some of them live in the intercellular spaces only, others penetrate the walls of the cells, especially of the parenchyma (simple) cells, and live within the living matter of the plant. Some species attack a part only of their host—

e.g. *Entyloma* forms pustules on the leaves of certain species of *Ranunculus*, others spread throughout the tissues, forming spores in special places. Thus the mycelium of *Tilletia caries*, which causes the disease specially known as Bunt, may spread through the whole of a wheat-plant, but the spores are found only in the ovary. *U. Carbo fructifera* in the inflorescences of various grasses, and causes the disease known as Smut. The part of the plant where the fructifica-

tion is being formed is generally enlarged, and becomes filled with the black resting spores. This swelling is especially noticeable in maize-plants attacked by *U. Masdis*. The mycelial hyphæ are not very densely spread within the tissues of a host, but the hyphæ that will bear spores branch repeatedly, and thus form a mass of compact tissue within that part of the host selected for the fructification, this compact mass taking the form of that part of the host, or covering with a flat layer a part of the surface, or eating a cavity out of the tissues of the plant and taking the form of that cavity. Generally the spore-bearing hyphæ become transformed into spores, so that nothing but spores remain, but some species form definite envelopes for the spores—e.g. *Doassansia*. The germination of the spores occurs when they have been well saturated with water. Typically, a germ tube is emitted which is called the promycelium. This, in most cases, gives forth from the far end a number (4 to 10) of smaller tubes, called sporidia. These sporidia, either before or after their separation from the promycelium, conjugate in pairs. From these conjugated cells there may arise a tube which takes all the protoplasm of the two cells; this tube, called an incipient mycelium, may enter into the tissues of a host and develop a true mycelium. Sometimes in a species which usually develops in this way any or all of these steps may be omitted—e.g. the spore may give rise to an incipient mycelium direct, or the sporidia though formed may not conjugate, but produce incipient mycelia direct. Species also occur in which these peculiarities are the general rule. In some species the sporidia, or what correspond to them, are occasionally formed direct from the hyphæ within the plant, the formation of a true resting spore being omitted; the parts so formed project from the host and are called gonidia.

See FUNGI; also De Bary's *Comparative Morphology of Fungi, Mycetozoa, and Bacteria*; or Goebel's *Outlines of Classification and Morphology*.

Smyrna, the most important seaport of Asia Minor, stands at the head of the Gulf of Smyrna, which penetrates 46 miles inland from the Ægean Sea, and in a little mountain-girdled valley on the west coast of Asia Minor. The city climbs up the slopes and nestles at the foot of a steep hill (at the south-east corner of the Gulf, which is crowned by the ruins of the ancient Greek Acropolis. Viewed from the waters of the Gulf it presents a very fine appearance; but the interior, especially in the higher parts where the Turks dwell, consists chiefly of narrow and dark streets with mean houses. The Frankish quarter, to which the Europeans are confined, and which faces the quays (2 miles long) and harbour, is in most respects decidedly better than the native districts. Gas is used for lighting the streets, and the electric light in private establishments. The drainage is bad; the climate uncertain, but intensely hot in summer; and earthquakes are by no means unknown, those of 178 A.D., 1688, 1768, and 1880 having been particularly severe. Traces of the ancient walls, the stadium, theatre, and some temples can still be discerned. There are a great number of modern mosques, churches, baths, and bazaars, but no buildings with any architectural pretensions. The city is the seat of archbishops of the Roman Catholic, Greek, and Armenian Churches, and of the Turkish governor-general of the province (*vilayet*) of Aidin. Carpets are manufactured, as well as pottery, cottons, and woollens. The principal inland communications from Smyrna are the railway up the Mendere valley to Denizli, having, with branches, a length of 325 miles, and the Smyrna-Ala-shehr railway, with branches, 284 miles; and in connection with these

iron-foundries and machine-shops have been established at Smyrna. But it is as a commercial seaport that the place is specially celebrated. Seven hundred years before Christ it was one of the principal trading-centres for Asia Minor (Anatolia); and at the present day it has unquestionably the lion's share of the Asia Minor trade with Europe. The harbour is large, safe, and easily accessible, but is in imminent danger of silting up like that of Salonica. The exports from Smyrna average about £4,000,000 in annual value, and the imports close upon £3,000,000. The principal commodities amongst the exports are raisins (£1,100,000), valonia (£700,000), figs (£343,000), and opium (£196,000), to which must be added barley, carpets, sponges, liquorice, wool, olive-oil, tobacco, emery, sesame-seed, hides, fruits, antimony, beans, cotton-seed, walnut-wood, poppy-seed, bones, and a multitude of other articles. The imports of greatest value are textiles (£713,000), timber (£275,000), and iron and hardware (£102,000), besides groceries, railway plant, leather, butter, glass, petroleum, coal, cheese, matches, paper, &c. Britain takes of these exports to the value of £2,000,000 annually, and sends from £678,000 (1885) to £1,255,000 (1889) of the imports. The harbour is entered annually by some 1620 vessels of 1,486,000 tons burden. Pop. estimated (1890) at 210,000, of whom 107,000 are Greeks (just the population of Athens), 23,000 Jews, 12,000 Armenians, 12,700 Europeans, and the rest Turks.

Smyrna was originally a city of the Greek Æolic immigrants into Asia Minor, but some time before 688 B.C. it had become Ionian. During that century it enjoyed wonderful prosperity as the principal intermediary in trade between Europe (Greece) and Lydia; but in 630 B.C. it was captured and destroyed by Alyattes, king of Lydia. For more than three hundred years it maintained merely a struggling existence; but it was at length rebuilt on a different site by Antigonus, and further enlarged and fortified by Lysimachus, both inheritors of the conquests of Alexander the Great. Under the Romans its commercial fame was revived, though it had rivals in Ephesus and Pergamum, and at a later date a still more formidable rival in Byzantium, to the emperors of which it belonged. It was frequently sacked by the Turks and suffered many reverses, being destroyed by Tamerlane (1402) and finally captured by the Turks under Murad II. in 1424. See Rougon, *Smyrne: Situation Commerciale et Economique* (1892).

Snail, a term employed to designate the species of terrestrial Gasteropoda (q.v.) which have well-formed spiral shells. The more typical snails

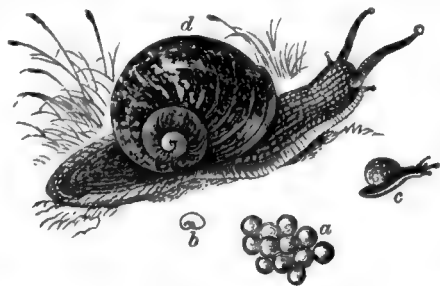

Fig. 1.—Common Snail (*Helix aspersa*):

a, eggs; b, appearance when newly hatched; c, slightly advanced stage; d, mature snail.

belong to the genus *Helix*, of the family Helicidae, and have the shell of many whorls, globose, depressed, or conical. The aperture or mouth of the shell is more or less encroached upon by the last

whorl but one, it is often strengthened by an internal thickened rib, its edges are usually more or less reflexed, and there are sometimes calcareous tooth-like prominences known as the denticles or apertural lamellæ. The animal progresses upon a foot or sole, which is flattened beneath, and fringed at the edge. There are four retractile tentacles, the two upper ones the largest, and bearing the eyes. There is a crescent-shaped jaw, which is usually strongly ribbed. The tongue or lingual membrane bears very many teeth arranged in transverse rows. Thus, the Common Garden Snail has 135 rows of 105 teeth = 14,175 in all. Snails are hermaphrodite, but mutual impregnation takes place. They are provided with calcareous styles or darts, which are secreted within a sac, the dart-sac, from which they are protruded during copulation. The forms of these darts are very various, and sometimes offer excellent characters for the separation of allied species. The eggs of snails are round or oval, and are deposited in damp places or in the earth. Those of the Edible Snail are nearly as large as a pea. At the approach of winter, or in very dry weather, snails close the mouth of the shell with a membrane (*epiphragm*) formed by the drying of the mucous substance which they secrete, and become inactive and torpid. Some, as the Edible Snail, make a succession of such membranes, the outer one of which is also strengthened by a quantity of calcareous matter, the secretion being at first a white



Fig. 2.
'Darts' of
Snails:
a, *Helix aspersa*;
b, *Helix arbustorum*.

viscid fluid, but quickly hardening like plaster of Paris. When this is to be removed a fresh secretion of fluid mucus softens it at the edges. The Common Garden Snail is to some extent gregarious when in the torpid state; many individuals may frequently be found closely packed together in cracks in walls, under logs or stones, and in other sheltered places. Snails delight in warm moist weather, and are active chiefly at night and during or after rain. They are also more abundant on limestone soils than elsewhere; the kinds found in districts where there is little or no lime have frequently very thin shells, owing to the deficiency of calcareous matter to strengthen them. Snails feed chiefly on vegetable substances, although they are very indiscriminate in their appetite, and even devour the dead of their own kind. The mischief which they do to garden crops is too well known; and gardeners are constantly on the alert to destroy them. Thrushes and blackbirds devour great quantities of snails; they select a suitable stone against which they break the shells. These 'breaking-stones' may often be found in fields and by roadsides surrounded by fragments of shells. Snails possess in a very high degree the power of repairing injuries, and specimens may not rarely be found in which part of the shell has been broken and repaired again. Snails are found in nearly every part of the globe, some thousands of species having been described by authors. Seventy species are found in the British Islands, of which twenty-two belong to the genus *Helix*. The Edible or Roman Snail (*H. pomatia*), much esteemed as an article of food on the Continent, is regularly bred on large and prosperous snail-farms in canton Zürich, Bavaria, and elsewhere, being fed on salad, greens, kitchen-waste, meal, &c. It is a large tawny species, not rare in parts of the south of England (especially Kent and Surrey), and is sold for food in London. The Common Garden Snail (*H. aspersa*), the most destructive species in Britain, is too abundant in most places, but rare in parts of Scotland and north-west England. It is also used

for culinary purposes, notably in the Newcastle, Bristol, and Swindon districts. The Striped Snail (*H. nemoralis*) is smaller than the Garden Snail, and of various colours, usually red or yellow, ornamented with one to five spiral dark-brown bands. The rim or lip of the aperture in this species is dark brown, but in a closely allied species, *H. hortensis*, it is white. Both these species are very common, and it is a favourite custom for collectors to obtain large series showing the variation, their beauty and interest being very great. Taking variations in the banding alone, already eighty-nine of *H. nemoralis* and fifty of *H. hortensis* have been found within the British Islands, while very many others are known from abroad. *H. nemoralis*, when introduced into Virginia, produced many band-variations which are not known in Europe. *H. arbustorum* is a species about the same size as *H. nemoralis*, but brown, mottled with pale yellowish, and usually encircled by a single dark band. The Kentish Snail (*H. cantiana*) is smaller, whitish, more or less tinged with rufous. The Hairy Snail (*H. hispida*) is a small horn-coloured or brown species found in hedges, among moss, &c.; its shell is clothed with minute hairs or bristles. *H. virgata* is a species rather over $\frac{1}{2}$ -inch in diameter, found very abundantly in chalky places, on downs, and by the sea. It is usually white with one or more dark-brown bands, though some of the varieties are blackish or yellowish. On the South Downs this and an allied but smaller species (*H. caperata*) are so abundant that the sheep, when feeding upon the short grass, can scarcely avoid devouring them; and the excellency of the South Down and Dartmoor mutton has in part been attributed to the nutritive qualities of the snails. *H. ericetorum* is another species allied to *H. virgata*, and found in similar places, but it is larger and has the shell much flattened above. *H. pulchella* is a minute but very beautiful species, found abundantly both in Europe and North America. Hyalina (often called Zonites) is a genus of small snails in which the jaw is without ribs, and the shell smooth and shiny. There are eleven British species. Some of them emit a garlic odour, especially *H. alliaria*. *H. crystallina* is a small species of a clear white colour. The genus Pupa consists of brown cylindrical shells, resembling small seeds. Some of them, which are placed in the sub-genus *Vertigo*, are exceedingly minute. *P. antivertigo* has the aperture of the shell so barred by long calcareous processes (*denticles*) that it is a wonder how the animal can emerge from it. *Clausilia* is somewhat similar to Pupa, but longer both actually and in proportion to the width; the aperture is turned to the left (*sinistral*) instead of to the right (as is the case with the majority of snails), and is provided with a very curious spiral, shelly plate (*clausium*). A south European snail (*Stenogyra decollata*) is of a cylindrical shape, and sheds its upper whorls when it becomes adult, the aperture so formed being covered by a shelly plate. Adult specimens thus appear truncate, presenting a very singular appearance. See Rimmer's *Land and Fresh-water Shells of the British Islands* (1880).

Snake Bird. See DARTER, WRY-NECK.

Snake River, the largest affluent of the Columbia River, rises among the Rocky Mountains near the western border of Wyoming, sweeps in a rough semicircle through southern Idaho, forming here the famous Shoshone Falls (q.v.), and, turning north, divides Idaho from Oregon and partly from Washington. At Lewiston it turns westward, and in southern Washington, under the name of the Lewis River or Fork, joins the Columbia, after a course of some 1050 miles. It traverses a very

mountainous country, flowing through deep, lava-walled cañons, and is navigable for steamboats only to Lewiston (160 miles). In Idaho its waters are of value to the herds on the winter range. Its chief affluents are the Boise, Owyhee, Malheur, Salmon, Clearwater, and Palouse.

Snake-root. See BISTORT, MILKWORTS, ARISTOLOCHIA, and SENEGA.

Snakes (*Ophidia*) form one of the classes of reptiles, and are readily known by their shape, being limbless and much elongated. To some extent the shape may be an adaptation to the habit of creeping through crevices and among dense herbage; for, apart from snakes, it is seen in other animals which crawl through obstacles or underground, in limbless lizards (e.g. *Amphisbæna* and *Anguis*), in the amphibian *Cæcilians*, in various eel-like fishes, and in worms.

General Habit and Structure.—As regards habitat we distinguish tree-snakes, usually green in colour, of slender body, and of active habits; the water-snakes, including the non-poisonous freshwater forms, such as the British Grass Snake and the tropical *Anaconda*, and the very venomous sea-snakes (*Hydrophidæ*), whose flattened tail, apical nostrils, &c. are adaptations to their mode of life; the burrowing snakes (*Typhlopidae*), with rigid cylindrical bodies, narrow mouths, and no specialised ventral shields; and the majority, which may be called ground-snakes.

The scales covering the body are formed from folds of skin. In each species of snake they have a definite arrangement, which is greatly relied on in the more detailed classification. This is especially true of the shields on the head, which are usually named after the underlying bones—parietals, frontals, nasals, &c.; thus between the nasal scale (on which the nostril opens) and the pre-orbital (in front of the eye) there is in harmless snakes a loreal scale, which is one of their characteristics. Most important in the life of the animal are the strong ventral scales or shields, for each of these is attached to a pair of ribs and helps to grip the ground. As they correspond in number to the vertebræ, they are also diagnostic of species. The number of vertebræ in snakes is often great, in some pythons amounting to more than four hundred. They form a uniform series, distinguishable only into pre-caudals and caudals, and all the pre-caudals except the first bear ribs. The bodies of the vertebræ are concave in front and have well-developed articular processes.

The skull is highly specialised. The bones which form the brain-case proper are firmly united, but most of the others are movable. Thus, 'when the snake opens its mouth for the purpose of striking its prey, the digastric muscle, pulling up the angle of the mandible, at the same time thrusts the distal end of the quadrate bone forward. This necessitates the pushing forward of the pterygoid, the result of which is twofold: firstly, the bending of the pterygo-palatine joint; secondly, the partial rotation of the maxillary upon its lacrymal joint, the hinder end of the maxillary being thrust downward and forward. In virtue of this rotation of the maxillary, through about a quarter of a circle, the dentigerous face of the maxilla looks downward, and even a little forward, instead of backward, and the fangs are erected in a vertical position' (Huxley). The halves of the lower jaw are connected in front by an elastic ligament, and this, combined with the mobility of the quadrates and squamosals, makes it possible for the snake to swallow its relatively large prey.

The teeth of snakes are short, conical, and sharp, and are fused to the bones which bear them. The

upper teeth may occur on the maxilla, palatines, pterygoids, and rarely on the pre-maxilla; the lower teeth are borne as usual by the dentaries. In the most venomous snakes, such as vipers and rattlesnakes, the maxillary teeth are few, and each is folded so as to form a tubular or grooved fang. The specialised fang is connected by a gradual series of forms with the ordinary teeth.

As to the appendicular skeleton, no snake has any trace of anterior limbs or girdle, and only a few—the pythons, boas, *Typhlopidae*, and *Tortrices*—have any rudiment of a pelvis. The pythons and *Tortrices* have short rudiments of hind-limbs terminated by claws.

While the nervous system of snakes differs from that of other reptiles only in small details, such as the absence of a differentiated spinal accessory or eleventh cranial nerve, the sense-organs are in many respects peculiar. The eyelids, apparently absent, are in reality fused as a transparent screen in front of the eye, as is the case in *Geckos* and some other lizards. The eyes are often very small, and the sense of sight seems often to be dim. As the common simile 'as deaf as an adder' suggests, the sense of hearing is also dull; there is no external ear and no tympanic cavity. The nostrils lie at the apex of the snout; the sense of smell seems sufficiently acute to guide the snakes to their prey and to their mates. In finding the latter they are aided by the peculiar, sometimes musk-like odour characteristic of snakes. Of a sense of taste they have little need, for they swallow their prey whole, nor are the usual gustatory organs present. It is not too much to say that the most developed sense-organ is the tactile tongue; with which snakes feel their way and test everything which they touch.

The internal structure of snakes presents several peculiarities in adaptation to the elongated shape of the body. Thus, the stomach is long but not broad, the lobes of the liver are also elongated, there is in most cases only one lung, the kidneys are not opposite one another, and so on. The elasticity of the food-canal is an adaptation to the swallowing of relatively large booty, and during this often slow process the larynx is slanted forward into the mouth so that respiration is not seriously impeded. Although boas, rattlesnakes, and some others have paired lungs, most snakes have only one, usually with a rudiment of the other. There are often auxiliary air-sacs on the windpipe, and the posterior part of the lung is rather a reservoir for air than an actual breathing organ. Apart from the characteristic hiss, produced by the forcible expulsion of air, most snakes are dumb, but some boas are said to whine, and a few others make peculiar sounds, of which the rattling of the rattlesnakes is best known. In having a three-chambered heart and a circulation of mixed blood in the greater part of the body snakes resemble lizards and tortoises. No urinary bladder is developed.

The Poison-apparatus.—The poison-gland characteristic of the venomous snakes is not a new structure, but merely a specialised salivary gland, and it is interesting to notice that a similar modification occurs in the poisonous Mexican lizard *Heloderma*. From the gland, which lies on each side behind the eye, and is about the size of an almond in the cobra, a duct extends to the base of the fang, down which the venomous juice flows when the snake bites its victim. The fangs are folded teeth, each an open groove, as in the sea-snakes, or a closed tube, as in the vipers. It is of course clearly to be understood that the 'sting of the serpent' is a poisonous bite. Stretching over the poison-gland is the membranous origin of the masseter muscle which works the lower jaw, and by means of this and other somewhat complex

arrangements the poison-gland is automatically compressed when the snake opens its mouth to strike. But the opening of the mouth also brings about the erection of the fangs, which are

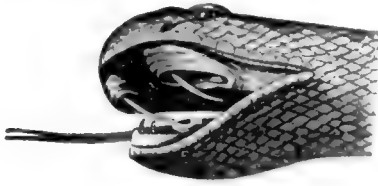

Fig. 1.

Open mouth of a venomous snake, showing the fangs half-hidden in their sheaths. (After Nuhn.)

recumbent and ensheathed when not in use. Behind each functional fang is a series of reserve fangs, and if a fang be broken the foremost of the reserves is shunted forward, and becoming fixed to the maxilla replaces the one which has been lost.

The juice formed in the specialised glands and forced out along the fangs is a clear viscid fluid with an acid reaction, and with poisonous properties which vary according to the species

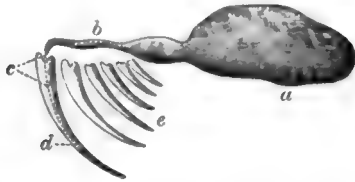

Fig. 2.

Dissection showing the poison-gland, a; its duct, b; the tubular fang, c, d; the reserve fang, e. (After Nuhn.)

and also with the vigour of the snake. It may be kept for months or even years without losing its virulence. Injected through the fangs into the blood of a victim, it tends to paralyse the nerve-centres. It has most effect on birds and mammals, less on cold-blooded animals, such as fishes. An injection of the blood of a venomous snake may also prove fatal. Several venomous snakes are unaffected by their own venom, and Fayer states that Cobras and Daboias may bite one another with impunity. He also notices that the 'sweepers and Dhomes' who attended his elaborate experiments in India were wont to eat the animals which had been fatally bitten. In 1843 Lucien Bonaparte discovered in the poison of the adder (*Pelias berus*) a substance which he called 'viperine,' but this seems practically identical with the ptyaline of ordinary saliva, and we are still far from understanding why the juice of the poison-gland should have its peculiar properties.

Food.—Snakes are almost always carnivorous; and, as is suggested by the nature of their teeth, which are not adapted for mastication, they swallow their booty intact. Mammals, birds, reptiles, amphibians, fishes, molluscs, and insects are all eaten by snakes, and there are many forms with strange preferences—e.g. for milk and eggs. In the egg-eating African snake—*Rachiodon*—the teeth are rudimentary, but the inferior spines of the anterior vertebrae project on the dorsal wall of the gullet and break the egg-shells. In many cases the prey is relatively large—larger indeed than the normal size of the mouth and gullet—and the process of swallowing is tedious. In the python, for instance, there is a slow continuous action of jaws and teeth; the victim is firmly held by one side of the mouth while the other side is protruded and its teeth implanted further forward, and so on alternately on

each side. Meanwhile the mobile bones of the skull are being stretched to the utmost, and the victim is covered with saliva which makes the passage down the elastic gullet somewhat easier. After a heavy meal the snake often lies dormant for a time, after which it may cast its slough.

Movements.—Owen has said of snakes that they can 'outclimb the monkey, outswim the fish, outleap the zebra, outwrestle the athlete, and crush the tiger;' yet all without limbs. The muscular system is very strongly developed, and the long ribs associated with most of the vertebrae serve instead of legs. The serpent 'literally rows on the earth, with every scale for an oar; it bites the dust with the ridges of its body.' On a very smooth surface—on glass, for instance—it can make no headway, but in normal conditions the edges of the anterior ventral scales are fixed against the roughnesses of the ground, the ribs are drawn together first on one side then on the other, the body is thus wriggled forward to the place of attachment, the hind part fixes itself, the front part shoots out, an anterior attachment is again effected, and thus the snake glides onwards. But this scarcely suggests the swiftness or the beauty of what Ruskin calls 'one soundless, causeless march of sequent rings, and spectral procession of spotted dust, with dissolution in its fangs, dislocation in its coils. Startle it; the winding stream will become a twisted arrow; the wave of poisoned life will lash through the grass like a cast lance.' Were it not for many fanciful pictures it would scarcely be necessary to say that without any support snakes are not able to raise the anterior part of their body more than a short distance from the ground.

Sloughing.—It is well known that a snake periodically 'casts its skin,' leaving behind it a continuous 'slough.' The same process occurs in lizards, and to a less extent in some other animals. What is cast is the external layer of the epidermis, and its continuity depends on the fact that the scales are simply folds of skin. As to the physiology of the process, although a complete explanation has not yet been given, it is evident that the outer layer of the skin tends to die away, and that the continued growth of the animal makes sloughing necessary. The number of sloughings in a year varies with the species of snake and also with the age and health of the individual. Cobras have been observed to slough as often as once a month, but this seems to be unusually often. Before sloughing snakes are often almost blinded by the change in the skin over the eyes, and at this time they are said to be very irritable. In getting rid of its slough the snake gets its head free first, and the outer layer is turned inside out from before backwards.

Reproduction.—The sexes are almost always quite like one another externally, save that the females are always larger. The internal organs of reproduction are paired, but those of the right side are often the larger and lie in front of those on the left. The male has a double copulatory organ, sometimes covered with spines or hooks. The eggs, fertilised within the oviducts, are more or less oblong in shape, and are surrounded by a leathery envelope, 'for the rupture of which the embryos are provided with an egg-tooth, a special development like that of the chick.' Most snakes are oviparous, but, as among lizards, viviparous forms occur, such as the British Adder (*Pelias* or *Vipera berus*). It is said that Geoffroy Saint-Hilaire and Florent Prévost 'succeeded in making the (normally oviparous) Common Grass Snake viviparous by depriving it of water and maintaining a suitable surrounding temperature;' and it may be that some viperine snakes and the *Boa Constrictor*, which have borne their young alive in captivity, are oviparous in natural

conditions of life. Of the python it is recorded that the mother coils herself around the laid eggs and broods over them, the temperature within the coils rising as high as 96° F.

Classification.—Snakes may be thus classified :

SUB-ORDER I.—Crotodontia (=Typhlopidae): the simplest and smallest snakes, sometimes smaller than earthworms, occurring in most warm countries as burrowers in the soil. The mouth is narrow and not distensible; the eyes are small and half-hidden; and the skull, besides being much less mobile in its parts than is usual in snakes, is unique in having transverse palatine bones which meet or nearly meet in the base, in the absence of a 'transverse bone,' and in the freedom of the pterygoids from the quadrate; only one jaw, either the upper or the lower, bears teeth. They are not venomous. Most of the forms belong to the genus *Typhlops*—represented in America, Africa, India, Australia, and by one species in south-eastern Europe.

SUB-ORDER II.—Colubiformia: mostly harmless snakes without any fangs (*Aglyodontia*), or with some of the posterior maxillary teeth grooved and fang-like (*Opisthoglypha*). Examples: the Pythons (*Pythonidae*), the Boas (*Boidae*), the Grass or Ringed Snake (*Tropidonotus natrix*), the Smooth Snake (*Coronella levis*), the Tree-snakes (*Dendrophidie* and *Dryophidie*).

SUB-ORDER III.—Colubiformia venenosi: poisonous snakes with permanently erect fangs, succeeded by solid teeth (*Proteroglypha*). Examples: Cobras, *Naja*, *Hamadryas* (*Ophiophagus*), Coral-snakes (*Elaps*), Sea-snakes (*Hydrophidie*).

SUB-ORDER IV.—Viperiformes: poisonous snakes with a few erectile maxillary teeth specialised as fangs (*Solenoglypha*). Examples: Vipers (*Viperidie*) and Rattlesnakes (*Crotalidie*).

Distribution.—The number of species is certainly above 1000 and is sometimes estimated at about 1800. They are represented in most parts of the world, abundantly in the tropics, commonly in temperate countries, dwindling towards the poles. They are absent from New Zealand and most Oceanic islands, and it is a proverbial saying that 'there are no snakes in Iceland.' In Ireland also they are unrepresented, except by casual importations.

The Grass or Ringed Snake (*Tropidonotus natrix*) and the poisonous Viper or Adder (*Pelias* or *Vipera berus*) are the two common kinds of snake found in Britain. There is indeed only one other species, the Smooth Snake (*Coronella levis*), and this is of rare occurrence. The smooth snake and the ringed snake are non-poisonous Colubrine snakes; the viper is a small representative of a very venomous family. As the viper is discussed in a separate article, and as the smooth snake is restricted to a few parts of the south of England, we need only describe the ringed snake. It sometimes attains a length of 3 or 4 feet, is very fond of water, and feeds chiefly on frogs, small fish, young birds, mice, and other small animals. Its colours are beautiful—usually brownish gray with a green tinge above, dull pale bluish beneath. In summer it is fond of basking among the long grass; in winter it hibernates in some sheltered nook in company with several of its fellows. Unlike the adder, the ringed snake is oviparous, laying 16-20 eggs in some well-sunned spot. It is common in some parts of Britain. These three species also form the Ophidian fauna of Scandinavia, Denmark, Holland, and Belgium; but there are over a dozen other European species, of which one of the commonest is the Asp (*Viperu aspis*).

The North American Ophidia include a large number of Colubrine snakes and about a score of pit-vipers or rattlesnakes. Among the Colubrine forms are the water-snakes (*Tropidonotus*), the black snakes and coachwhip snakes of the genus *Coluber*, the pine-snakes (*Pityophis*), species of *Elaphis*, the king-snakes (*Ophibolus*), the ring-necked snakes (*Diadophis*), and so on. Besides the rattlesnakes proper (*Crotalus*) there are related genera, such as *Ancistrodon*, the copperheads and moccasins. And outside the two families of Colubridie and Crotalidie there are representatives of the burrowing Typhlopidae, of the boa-like Erycidae, and of the venomous coral-snakes (*Elapidae*)—the

harlequin snake (*Elaps fulvus*) being a well-known representative of the last.

The Colubridæ form the largest and most cosmopolitan of Ophidian families, being abundantly represented in all the great regions except Australia, where the venomous Elapidæ predominate. 'The tree-snakes proper (*Dendrophidie*) are found in all the tropical regions; the nocturnal tree-snakes (*Dipsadidæ*) and the arboreal whip-snakes (*Dryophidæ*) are also essentially tropical, but they are either wholly, or almost wholly, wanting in Australia' (Heilprin).

The Pythons and Boas are distinctively tropical snakes: the Pythons in Africa, India, Malaya, Australia; the Boas in tropical America. Among the most important venomous snakes of India are the following: the Cobra (*Naja tripudians*), the Hamadryas or Sunkercher (*Ophiophagus elaps*), the Krait (*Bungarus coruleus*), and the Sankni (*B. fasciatus*), various species of *Callophis*, the Chain Viper or 'Bora Siah Chunder' (*Daboia russellii*), *Echis carinata*, various species of *Trimeresurus*, and the sea-snakes (*Hydrophis*, &c.).

Zoological Position.—It may be granted that snakes are more nearly allied to lizards than to other living reptiles, but the affinities are not close, nor does palæontology help us much, for fossil remains of Ophidia are scarce. 'Only one species, the *Simuliophis rochebruni*, from the Upper Cretaceous deposits of the Charente, France, is known to antedate the Tertiary period.' 'Whether or not the snakes are in part the modified descendants of the extinct lacertilian Pythonomorphs, to which they seem to approximate in certain points of structure, still remains to be determined.'

Superstitions about Snakes.—As snakes fill most men with fear, which is the prolific mother of fiction, hundreds of strange superstitions surround these animals. Born from the soil, they lick the dust for their food; powerful indeed, they are killed by spiders, and cannot stand before crabs; venomous many of them, they are poisoned by human saliva, and flee from the shadow of the ash or the odour of rosemary; their maximum size has been stated at a mile. It is not surprising that many peoples should have found in the serpent 'a divine hieroglyph of the demoniac power of the earth—of the entire earthly nature,' or even a symbol of the principle of evil. 'As the bird,' Ruskin says, 'is the clothed power of the air, so this is the clothed power of the dust; as the bird is the symbol of the spirit of life, so this of the grasp and sting of death.' For serpent worship, see SERPENTS.

We cannot wonder that the ingenuity of despair should have sought out many strange antidotes to the poison of serpents. Various kinds of herbs, portions of the snake's own body, a diet of 'anti-pathetic' animals, spells, charms, and amulets have been often resorted to, often of course with successful results, for the bite is not always fatal, and confidence is the best of tonics; often of course uselessly when the Fates were cruel. Among the most famous, and for the most part quite useless, 'cures' for snake-bite is the application of a 'snake-stone.' Although the nature of this so-called 'stone' is sometimes kept secret by the native quacks who prepare it, the substance is often a piece of charred bone, and its only possible efficacy lies in its power of absorbing the poisoned blood from the wound to which it is applied. But the results of actual experiments with snake-stones are entirely against any belief in their virtue. The same name is sometimes given to Ammonites (q.v.), on the idea that they are petrified snakes. Another kind of snake-stone or adder-stone, also called *ovum anguinum*, *adder-gem*, and *druvidical bead*, was carried about as a miscellaneous charm

in Britain, and was believed to have been produced by a number of adders laying their heads together and hissing till the foam produced was turned into stone. Such charms when examined have often been found to be simply ancient—possibly prehistoric—spindle-whorls. See also BEZOAR.

As a superstition we must also regard the widespread belief that snakes 'fascinate' their prey. Although many observers are convinced of this, the use of the word 'fascinate' has not been justified. No doubt snakes, having no movable eyelids, have an unusual power of steady staring; no doubt birds whose nestlings are threatened will flit anxiously about regardless of danger. In countries where venomous snakes are common, it is possible that the animals on which they prey have an inherited dread of them. It is certain that both men and animals when brought suddenly face to face with something terrible are often panic-stricken and incapable of motion; but there is no evidence that snakes have a power of fascination.

Scarcely a superstition, but rather an insufficiently confirmed opinion, is expressed in the common belief that snakes swallow their young ones when danger threatens. Were not errors of observation exceedingly common, we should be inclined to accept this strange fact, for the shelter afforded by the mouth is a convenient if somewhat hazardous one, and the young snakes might live there for some time. It is known that a few fishes and amphibians carry their young in their mouths. But the possibilities of mistake are many; thus, some snakes eat other snakes, and their bodies have often been found in the food-canals of their larger neighbours. Moreover, some snakes are viviparous, and unpractised observers might mistake the oviducts for the alimentary canal.

Serpent-charming.—This art has been practised from very ancient times in Africa and the East, and often remains from generation to generation the profession of a family. Pliny and older writers frequently describe it, and there are several allusions to it in the Old Testament Scriptures; see Exod. vii. 11, 12; Psalm lviii. 4, 5; Eccles. x. 11; Jer. viii. 17. It is sometimes practised for alleged useful purposes, since the 'charmners' are often employed to clear a house of its unwelcome snake visitors, though common report says that they are yet more successful in removing inanimate objects. For the most part, however, it is, like conjuring, a form of popular amusement. In India it is practised by several distinct classes of men, who vary in the methods and success of their art. The subject has not as yet been studied with adequate scientific precision, so that it is difficult to separate what is due to trickery and to dexterity from any residual facts which cannot be thus explained. There is no reason to believe that the charmners possess the constitutional immunity from snake-bite which they often claim, for a tragic end to their exhibitions sometimes belies their pretensions, and they usually take good care to play with snakes whose fangs or even poison-glands have been carefully removed, or even to use those which are not venomous at all. Nor can we, without further evidence, believe that the professional snake-finders have, beyond the cleverness of long experience (including an educated sense of smell), any peculiar power of discovering concealed snakes, especially since it is well known that they often use simple sleight of hand, producing snakes from within the folds of their robes, or merely discover what they themselves have previously hidden. The frequent use of a musical pipe, and the way in which the snakes seem to respond to the sounds, are facts interesting to naturalists, who believe that at least many snakes are very deaf. Experi-

ments should be made to determine how far the rhythmical motions which often accompany the music may have any influence on the snakes. That the charmners govern their snakes by their eye is another of the vague assertions of common report; but more interesting is the ancient habit of spitting down the snake's throat, closing its mouth, laying it flat on the ground, and sending it into a cataleptic—perhaps hypnotic—state, or 'turning it into a stick.' The charmners sometimes manifest a fearlessly confident dexterity in handling intact venomous snakes, and they sometimes suffer for it.

Snake-bites.—The extent of the mortality from snake-bite among inhabitants of warm countries is rarely appreciated by those who live in conditions of relative immunity. Official statistics show that in the decade 1880-89 the deaths of persons reported from snake-bite in British India varied from 18,670 (1881) to 22,480 (1889), without taking account of 2000 or 3000 cattle annually killed by snakes. Even if we doubt whether all deaths referred to snake-bite are really due to this, whether the Cobra and its allies are not blamed for more than they are really responsible for, it is certain that the mortality from snake-bite is relatively great when compared with that which any other animals cause. We cannot, however, regard it as absolutely great, for, as British India had in 1891 a population of over 22 millions, the mortality of human beings from this cause in a maximum year does not much exceed 1 in 10,000. In the decade referred to rewards were paid for snakes destroyed to the number of from 212,776 (1880) to 578,415 (1889); but the result is less satisfactory when it is known that in some places snakes are bred in order to be killed for the premium.

The effect of a snake-bite depends, on the one hand, on the species of snake, on its vigour at the time, on the extent to which the teeth closed on the flesh of the victim, and so on; on the other hand, on the species and vigour of the organism bitten. In connection with the effects of different snake-poisons Dr A. H. Hilson divides venomous snakes into two classes: in the first, including the Cobra, Krait, Daboia, and other Indian snakes, the poisoning causes paralysis of the lower extremities and the muscles of articulation, is associated with a regular or intermitting action of the heart, with paralysis of the respiratory muscles, with persistent consciousness, with little effect on the sensory ganglia, and is unaffected by injection of ammonia into the veins; in the second class, including the common Australian poisonous snakes, the Rattlesnake, and the Indian genus *Trimeresurus*, the poisoning causes no paralysis or only as an adventitious symptom, is associated with failure of the heart's action, but with no impeding of respiration, with rapid obliteration of consciousness, with disordered sensory functions, and is curable by injection of ammonia into the veins and by the use of stimulants. Snake-poison is usually regarded as (a) a neurotic paralyzing the nerve-centres, (b) an irritant producing inflammation, and (c) to some extent a septic. It acts through the circulation on the nerve-centres, and also affects the blood itself.

Fayrer summarises the treatment of snake-bite as follows: 'Apply at once a ligature, or ligatures at intervals of a few inches, as tight as you can possibly tie them; and tighten the one nearest to the wound by twisting it with a stick or other such agent. Scarify the wound, and let it bleed freely. Apply either a hot iron or live coal, or explode some gunpowder on the part; or apply either carbolic or some mineral acid, or caustic. Let the patient suck the wound whilst you are getting the cautery ready; or if any one else will run the risk, let him do it.

'If the bite be on a toe or finger, especially if the

snake has been recognised as a deadly one, either completely excise, or immediately amputate at the next joint. If the bite be on another part, where a ligature cannot be applied, or, indeed, if it be on the limbs above the toes or fingers, cut the part out at once completely.

'Let the patient be quiet. Do not fatigue him by exertion. When, or even before, symptoms of poisoning make their appearance, give the ammoniacal preparation called eau-de-luce, or liquor ammoniæ, or carbonate of ammonia, or even better than these, hot spirits and water. There is no occasion to intoxicate the person, but give it freely, and at frequent intervals. If he become low apply sinapisms and hot bottles, galvanism or electro-magnetism over the heart and diaphragm. Cold douches may also be useful. If the respiration be failing, artificial Respiration (q.v.), by the Marshall Hall or Sylvester method, may be employed.

'The antidotes, in addition, may be used by those who have faith in them; but, as I have said, I fear there is no reason to believe that they are of any use. Encourage and cheer the patient as much as possible. As to local effects, if there be great pain, anodynes may be applied or administered, and antiseptic poultices to remove sloughs; collections of matter must be opened. Other symptoms are to be treated on general surgical principles. This, I believe, is the sum and substance of what we can do in snake bite. If the person be not thoroughly poisoned we may help him to recover. If he be badly bitten by one of the more deadly snakes we can do no more.'

Into the debated question of the value of antidotes we cannot enter here. Nearly every drug in or out of the Pharmacopœia has been recommended; most reliance has been placed on ammonia, permanganate of potash, arsenic, iodine, bromine, the poison and bile of other snakes, the guaco plant, ipecacuanha, aristolochia, senega; but that an experienced authority like Sir Joseph Fayrer has no faith in them is comment enough. Of course it is quite possible, or indeed likely, that some toxic directly antagonistic to snake-poison will in the course of time be discovered.

Uses of Snakes.—Some snakes—e.g. Ophiophagus—eat one another; many help to keep down the numbers of small animals, such as rats and mice, whose increase is disadvantageous. Several are used for food; the poison is sometimes used by native physicians as a medicine—'a promoter of the virtue of other drugs, an anti-spasmodic, a digestive, a stimulant, &c.; it is also used to increase the deadliness of weapons. The oil extracted from the abundant fat of many snakes is said to be very useful for external application, and there is hardly a part of the body from which it has not been employed in superstitious therapeutics.

See ANACONDA, BOA, COBRA, PYTHON, RATTLESNAKE, VIPER, &c.; Hoffmann's 'Reptilia' in Bronn's *Thierreich* (Leip. and Heidelberg, 1859 et seq.); Duméril and Bibron, *Erpétologie Générale* (9 vols. Paris, 1834-54); Günther, *Reptiles of British India* (Lond. 1861); Blanford, *Fauna of British India* (1891); Fayrer, *Thanatophytia of India* (1874); Bell, *British Reptiles* (1839); Boulenger and others, *Catalogue of the Snakes in the British Museum* (3 vols., 1882-96); Jan and Sordello, *Icomographie des Ophidiens* (Paris, 1860-80); Baird and Girard, *Catalogue of North American Reptiles in the Museum of the Smithsonian Institution, part i.—Serpents* (Washington, 1853); Kreff, *The Snakes of Australia* (Sydney, 1869). A popular book with much interesting information is C. C. Hopley's *Snakes* (New York, 1882).

Snakewood. See BREAD-NUT.

Snapdragon (*Antirrhinum*), a genus of plants of the natural order Scrophulariaceæ, consisting of annual and perennial herbaceous plants, chiefly natives of the temperate parts of the northern

hemisphere. They have the calyx five-parted; the corolla swollen at the base, but without a spur, and *personate* (Lat. *persona*, 'a mask')—i.e. its mouth closed by the pressure of the lower against the upper lip; and the fruit is a two-celled oblique capsule, opening by three pores at the apex.

The English name refers to a peculiarity of the corolla, the lower lip of which, if forcibly parted from the upper so as to open the mouth, shuts with an elastic spring or snap. Some of the species have very pretty flowers. *A. majus* has long been a favourite in British gardens, in which there are many fine varieties of it. The whole plant is bitter. An oil is extracted in Persia from the very abundant seeds, by heating and then submitting them to pressure.—Snapdragon is also the name for a Christmas pastime in which raisins are snatched out of a dish in which brandy is burning, in a room otherwise dark.

Snaphaunce, a term originally applied to the spring-lock of a gun or pistol, but afterwards applied to the gun itself, a Dutch firelock of the 17th century. See FIRE-ARMS.

Sneek, a town in the Netherlands, province Friesland, 13 miles SW. of Leeuwarden, with an active trade in agricultural produce, especially in butter and cheese. Pop. 11,465.

Sneezing consists in a sudden violent expiration, preceded by one or more inspirations. During the expiration the fauces are generally closed so as to direct the current of air through the nose. Sneezing is most frequently produced by the presence of irritating substances in the nose, and indeed its purpose seems to be mainly to expel these from the nasal cavities. Irritants stimulate the terminal branches of the fifth nerve which are distributed over the nasal mucous membrane, and the stimulus conveyed to the 'respiratory centre' in the medulla leads to the respiratory efforts described. Sneezing is therefore a 'reflex act,' and as such is beyond the control of the will. It may, however, sometimes be prevented by the application of a strong stimulus to the nasal nerve, such as by compressing it at its exit from the nose, and it may also be prevented sometimes if a bet be made that it will take place. Sneezing may also be induced by irritation of other nerves than the nasal: thus, by gazing at a very bright light the strong stimulation of the optic nerves will sometimes bring on a sneeze. Sneezing not only rids the nasal cavity of foreign substances, but acts in a special way upon the general and especially the cerebral circulation. For the respiratory centre in the medulla is in close proximity to the vaso-motor centre, and the stimulus which leads to the sneeze produces at the same time increased activity of the vaso-motor centre, whereby the pulse is quickened, the blood-pressure rises, and the blood-vessels of the brain are dilated. Hence sneezing exerts a stimulant effect on the brain. Substances employed to induce sneezing are termed 'sternutatories' or 'errhines,' the principal ones being snuff, ipecacuanha, and euphorbium.

Paroxysmal sneezing is an expression of a special



Snapdragon (*Antirrhinum majus*).

idiosyncrasy, and occurs most frequently, if not always, in persons of nervous habit. The attacks are often periodic, recurring like 'morning-sneezing' with great regularity at certain times or under certain conditions. In others the attacks are provoked by the inhalation of dust or by particular odours. All these forms of morbid sneezing are due either to an increased irritability of the nerves in, or to chronic congestion of, the nasal mucous membrane, or to an increased excitability of the central nervous system, or to both, and they are largely maintained by *habit*. The disease is not infrequent in persons of gouty or asthmatical tendencies. The treatment consists in the choice of a climate most suitable to the individual, but no rule can be laid down for any one case; in some cases change of air appears to exert little influence, in others a change even to the opposite side of a street will effect a cure. Diversion of the attention will often prevent the appearance of a paroxysm at its wonted time. The drugs employed most successfully in combating the affection are opium, morphine, the combined bromides or iodides of sodium, potassium, and ammonium, *Lobelia inflata*, and nervine tonics. Locally, snuffs composed of iodol and gum acacia, or containing morphine, cocaine, or bismuth are useful. See also HAY-FEVER.—The custom of formally invoking a divine blessing on one who has just sneezed is of venerable antiquity, and is very widely spread, but its real significance is by no means so easy to determine. Rabbinical legends connect it with Jacob, but it is not possible to give any fuller answer to Pliny's question, 'Cur sternuntis salutamus?' than to say that it expresses respect to a divine intimation or to a natural sign of mortality. The most famous historical sneeze is that which was hailed as a good omen by Xenophon's ten thousand at a moment of despair.

Sneeze-wood (*Pteroxylon utile*; nat. order Sapindaceæ), one of the largest and most valuable trees in Cape Colony, sometimes yielding logs 80 feet long by 4 feet in diameter. The wood is of a yellowish colour, and has a handsome appearance somewhat resembling satinwood in the grain. It is difficult to work owing to its great hardness, but is believed to be very durable. It is employed for cabinet-making, for carpentry work, and for engineering purposes. Neither the white ant nor the teredo, it is said, will penetrate it. Its native name is *Umtati*, and it derives its English name (a translation of the Dutch *Nies-hout*) from the irritating nature of the dust which results from sawing or otherwise working it, and which causes sneezing.

Snehetten, a mountain of the Dovrefjeld (q.v.) in Norway, 7566 feet high.

Snell Exhibitions. See GLASGOW (UNIVERSITY), Vol. V. p. 236.

Sniatyn, a town of Austrian Galicia, on the Pruth, 25 miles NW. of Carlowitz. Pop. 10,832.

Snider, JACOB, the inventor of a method for converting Enfield muzzle-loading rifles into breechloaders (see BREECH-LOADING, and RIFLES). Originally a Philadelphia wine-merchant, he busied himself in inventions connected with dyeing, brewing, coach-wheels, the sheathing of ships, &c., and crossed to England in 1859 to induce the British government to adopt his system of breech-loading or converting. In this he succeeded, but for one reason or another found himself unable to obtain the expected remuneration. He died 25th October 1866, without having received the reward of his labours, worn out by delays, lawsuits, poverty, and debts.

Snipe, the name of a genus (*Gallinago*) and of a family (*Scelopacidae*) of birds, order Gralla.

The birds of this genus, which has been separated from the genus *Scelopax* of Linnaeus, have a very long, straight, flexible bill, slightly elevated towards the tip of the upper mandible, which expands a little, is decurved at the point, and projects over the lower. The whole bill is smooth, soft, and extremely sensitive. The head is compressed; the eyes are large and are placed far back. The wings are moderate in size; the legs are rather long; the three toes in front are long, slender, and divided to the base; the hind-toe is slender. The Common Snipe (*G. caelestis*, *media*, or *scelopacina*) is about 11 inches in entire length, the bill almost 3 inches.



Common Snipe (*Gallinago caelestis*).

The sexes are alike in plumage, but the female is rather larger than the male. The general colour of the upper parts is blackish brown, finely mixed with pale brown and with a rich buff colour; three pale brown streaks along the head; the neck and breast pale rust colour mottled with black; the belly white. The tail consists of fourteen feathers. The snipe when flushed changes its course several times in a zigzag manner in the air, and then darts off very swiftly, so that young sportsmen find it a very difficult bird to shoot. The snipe makes a very inartificial nest of a little dry herbage in a depression of the ground, or sometimes in a tuft of grass or rushes. The eggs are four in number, large for the size of the bird, pale yellowish or greenish white, the larger end spotted with brown. This species of snipe is plentiful in all the moory and marshy parts of Britain, and generally throughout Europe and as far as Iceland, also extensively in Asia, and it is found in the north of Africa, its representative in South Africa being a distinct species (*G. equatorialis*). It breeds in Britain, even in the south of England, and migrates in autumn, to return in the following spring, while the winter birds are migrants from Scandinavia, arriving in the end of summer and departing in spring. The note of the snipe is a *scape, scape*; but during the breeding season the bird emits a peculiar drumming or bleating sound (hence the name 'heather-bleater' given to the snipe in Scotland) when executing its extraordinary aerial evolutions. The origin of this sound has been much disputed. The snipe is capable of being tamed, and becomes very familiar, but is difficult to keep, from the prodigious quantity of worms and other such food which it requires. A tame snipe has been known to eat nearly twice its own weight of worms in twelve hours. The snipe is in high esteem for the table, and is included amongst game in Britain. The habits of all the other species of snipe correspond very nearly with those of the common snipe. The Great Snipe, or Solitary Snipe (*G. major*), an annual visitor in

small numbers to eastern and southern parts of England, very rare in Scotland and Ireland, but abounding in the extensive marshes of continental Europe, is found also in Asia and in many parts of Africa. Its entire length is about 12½ inches, the bill not quite so long in proportion as that of the common snipe. There are sixteen feathers in the tail. The Jack Snipe, or Judcock (*G. gallinula*), the smallest and most beautifully coloured of the group, is like the common snipe in plumage. It is common in Britain, but mostly as a winter visitant, and is found also during summer and winter in most parts of Europe and of the north of Asia and in North Africa. North America has a number of species. The Common American Snipe (*S. or G. wilsoni*) is about equal in size to the common snipe of Europe, and much resembles it also in plumage, but has sixteen feathers in its tail. The name snipe is extended in popular usage to include the genus *Macrorhamphus*, in which the outer toes are connected at the base by a membrane. In other characters, as well as in plumage and habits, the similarity to the true snipes is very great. The Red-breasted Snipe, or Brown Snipe (*M. griseus*), of North America has been occasionally seen in Britain and in Picardy and Normandy. In size it is nearly equal to the common snipe.

Snipe-fish. See TRUMPET-FISH.

Snizort, LOCH, a large and picturesque inlet of the sea in the north-west of Skye, between Trotternish and Vatarnish Points. It narrows from 9 to 3½ miles, and is 8½ miles long.

Snoring, an abnormal and noisy mode of respiration produced by deep inspirations and expirations through the nose and open mouth, the noise being caused by the vibrations of the soft palate and uvula. Sometimes the noise arises in the glottis, the vocal chords vibrating loosely. Keeping the mouth shut will usually make snoring impracticable.

Snorri Sturlason, an Icelandic historian and politician, was the son of a chief of the western fjords, and was born in 1179. The grandson of Sæmund Sigfusson, the compiler of the *Elder* or *Poetic Edda*, instructed him in the history, mythology, and poetry of the North, as well as in classical literature. By a wealthy marriage Snorri early sprang into a position of influence, and was elected (1215) supreme judge as well as president of the legislative assembly of the island. But his ambition, avarice, and love of intrigue led him to take part not only in private quarrels, but in the intestine troubles of Norway, and thus drew upon him the ill will of the Norwegian king, Hakon, who sent secret instructions to Iceland for his arrest, or, if need be, his assassination. The king's commands were carried out by one of Snorri's bitter enemies, who attacked him in his own house, and murdered him in the year 1241. Snorri was a poet of no mean order; and besides numerous laudatory poems on contemporary kings and jarls, he composed the *Younger* or *Prose Edda* (q.v.) and the *Heimskringla*; this last is a series of sagas or biographies of the Norwegian kings down to 1177, based on trustworthy sources and critically sifted evidence, and is written in a lively and interesting style. It has been translated by S. Laing (1844; new ed. by Rasmus B. Anderson in 4 vols. 1889).

Snow is the crystalline form into which the excess of vapour in the atmosphere is condensed when the temperature is below freezing. It is not, like hail or sleet, frozen rain, but is formed directly by the invisible aqueous vapour condensing in minute spicules of ice round the dust-particles that float in the air. More than 1000 different forms of crystals have been observed, and many of the chief or typical forms sketched by Scoresby, Glaisher,

Kaemtz, and others; but in all of them the filaments of ice are arranged at angles of 60° or 120°, and they may be grouped into five classes. (1) Thin

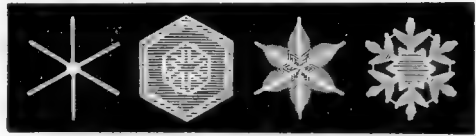

Fig. 1. Fig. 2. Fig. 3. Fig. 4.

plates or stars of six rays (figs. 1 to 5), the forms getting more complex the lower the temperature. (2) A solid nucleus or a flat plate, with needle-like crystals projecting in all directions: fig. 7 is a section through one of these. (3) Fine hexagonal

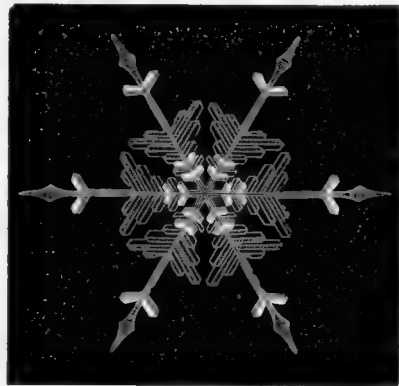

Fig. 5.

or three-sided prisms about ¼th of an inch long. (4) Prisms having thin plates perpendicular to their length: this form is rare (fig. 6). (5) Pyramids with six faces (fig. 8): this form also is rare, and is often associated with electrical disturbances. Each shower generally consists of flakes of one class only. Their form is best seen in calm weather; if there is much wind the crystals are broken and



Fig. 6. Fig. 7. Fig. 8.

irregular, and during gales tend to agglomerate in spherical masses. The size of flakes varies from about an inch down to ¼th of an inch in diameter, the size being smaller the lower the temperature, but isolated crystals occasionally fall in calm cold weather. The snow-fall of the British Isles is rarely so great as to cause serious inconvenience, except when accompanied by wind and consequent drifting: it then accumulates in railway cuttings and other sheltered places very rapidly, and to an extent limited only by the depth of the sheltered place. In the New England states the average annual fall ranges from 4 to 7 feet. In the Arctic regions and Siberia, though the fall is not greater than this, the snow lies unmelted much longer. To the south of lat. 40° snow is rare, except on hills; but it has been known to fall and lie for several days in Algeria and Morocco; and at Canton, within the torrid zone, it has fallen to

a depth of 4 inches. Fresh-fallen snow is very light, owing to its looseness of structure—a foot of such snow gives only about an inch of water when melted; but it increases in density when lying, partly by compression due to its own weight, partly by the filling of the interstices with condensed and frozen moisture from the air, and greatly by partial thawing and refreezing. In this way the snow on mountains that rise to a height sufficient to have a temperature mostly below freezing gets hardened into *névé*, and ultimately into the ice of the glacier, by which it is transferred to lower regions; but if the depth on a steep slope gets too great before it has time to harden it is liable to sweep down suddenly as an avalanche of dry snow. On the other hand, the sudden melting of snow may cause dangerous floods, such as occur when the warm wind, called the Föhn, blows over the Alps; but the more gradual melting of the snow-mantle of hills feeds the deep-seated springs of rivers. The flooding of the Nile, the source of the fertility of Egypt, is due to snow melting on the mountains of Central Africa. The snow of the Arctic regions, where solar radiation is weak, does not compact together, but remains dry and powdery; in eastern Siberia the prevalent wind is north-west, and all winter there is a continual drift of dry snow along the surface towards the south-east. The white colour of snow is due to reflection of the light from the innumerable surfaces of the crystals, each of which is composed of clear ice, just as glass loses its transparency when pulverised. Snow is feebly phosphorescent, absorbing light during the day and giving it out at night. The loose texture of freshly fallen snow makes it an admirable non-conductor of heat, and in the temperate zone it often preserves the ground from the chilling action of short spells of intense cold. The latent heat set free when vapour condenses into snow also sometimes mitigates the severity of a frost.

Snow is sometimes, in polar and alpine regions, where it lies unmelted from year to year, and the annual fall is small, coloured red by the presence of innumerable small red plants. In its native state the plant consists of brilliant red globules seated on a gelatinous mass. It is an Alga, and is now known as *Protococcus nivalis*; it is probably near akin to the not uncommon *Hematococcus pluvialis*. Red snow seems to have been observed by the ancients, as a passage in Aristotle apparently refers to it; but it attracted no attention in modern times till 1760, when Saussure observed it in the Alps, and from chemical experiments concluded that the red colour was owing to the presence of some vegetable substance, which he supposed might be the pollen of a plant. The next observations on red snow were made in the Arctic expedition under Captain Ross, when it was found extending over a range of cliffs on the shore of Baffin Bay for 8 miles, and the red colour penetrating the snow in some places to a depth of 12 feet. Less frequent is a green growth on snow. See also BACTERIA, BLIZZARD, ICE.

SNOW-LINE.—This is the usual term employed to signify the height below which all the snow that falls during the year is melted in the course of the summer, or, in other words, the limit above which snow perpetually lies. It is no hard and fast line, but varies greatly in different localities, and in most localities varies more or less from year to year. Hence it would be more appropriate to speak of a zone, having superior (upper) and inferior (lower) limits, within which the snow-line moves up and down. The altitude at which this line (or zone) falls depends upon several conditions—viz. the volume or quantity of snow precipitated during the winter, the amount of the rainfall and the position of the mountain-slope with reference

to the principal rain-bringing winds, the latitude or distance from the equator, the degree of exposure to the sun's rays, the angle of the slope or the relative steepness of the mountain-side, and the general humidity or dryness of the atmosphere. Other things being equal, the following rules hold good: the snow-line is higher in north latitudes on the south than on the north side of mountains; higher on the east than on the west, owing to the greater prevalence of westerly winds in regions where snow accumulates; and higher in the interior of continents than near the sea, because in the former situations the precipitation is less and the heat of summer greater. In each separate locality the snow-line must be determined by a proper series of observations. To the general rules quoted above must be superadded those that depend upon the latitude: between 20° N. and 20° S. of the equator the altitude is pretty uniform; from 20° to 70° on both sides of the same central girdle it falls as the latitude increases in a pretty regular manner; but beyond 70° N. and S. and up to 78° in both directions it sinks very rapidly.

To these general rules there are of course in actual fact some important exceptions. In the Himalaya the snow-line runs 4000 feet higher on the north than it does on the south side; this is caused by the greater depth of snow that falls on the south side, by the greater dryness of the climate of Tibet, which increases the evaporation and consequently the heating power of the sun's rays, and by the comparatively treeless rocks and barren soil on the northern side absorbing more heat and attracting less precipitation than the well-wooded southern slopes. In the Andes the snow-line rises very rapidly between the equator and 18° S. lat., and more rapidly in proportion on the west than on the east side, owing to the comparatively small quantity of snow that falls on the Pacific side of the mountains. The subjoined table gives the snow-line on some of the most important mountain-ranges and peaks on the globe.

Mountains.	Latitude.	Snow-line in feet.
Greenland	75° N.	2,350
Norway (interior)	62°	5,100
" (coast)	61°	8,100
Kamchatka	59°	5,250
Altai	50°	7,000
Alps	45-47°	8,860
Pyrenees	43°	8,950
Caucasus	43°	11,000
Rocky Mountains	43°	12,500
Atlas Mountains	32°	14,000
Himalaya (north side)	30°	19,500
" (south side)	27°	15,500
Killimanjaro (East Africa)	3° S.	16,000
Andes of Bolivia (east side)	16°	16,000
" " (west side)	16°	18,400
" Chill	33°	14,700
Australian Alps	37°	6,600
Andes of Patagonia	42°	6,000

Snowball Tree. See GUELDER ROSE.

Snowberry (*Symphoricarpos* or *Symphoria racemosa*), a bushy deciduous shrub of the natural order Caprifoliaceæ, a native of the northern parts of North America, and now very common in British shrubberies. It has simple leaves, small flowers, and white uneatable berries about the size of black currants, remaining on the bush after the leaves. The name is also given to *Gaultheria serpyllifolia*, a native of North American bogs.

Snow-bird (*Fringilla hyemalis* or *hudsonia*), a North American bird of the Finch family (Fringillidæ), common from the Gulf of Mexico to the Arctic Circle, in all the eastern parts of North America. The wings are rather short, the tail slightly notched. The whole length is about six inches; the upper parts are lead-colour, the lower parts white, the two outer tail-feathers white, the next white margined with black. This bird

migrates northwards early in spring, and southwards late in autumn. They are first found in small flocks; their favourite haunts are roadsides, but they always take to trees when disturbed. In cold weather they visit farmhouses and villages; and before a snowstorm they assemble in large flocks, visiting barn-yards, and hopping about with the domestic poultry and small birds. The song of the male in the breeding season consists of a few very low, sweet warbling notes. From its frequent familiar approach to human habitations, the snow-bird is regarded with favour throughout great part of North America, as the Redbreast is in Britain. The name is also given to all the species of the fringilline genus *Junco*, including *J. hiemalis*, found both in the United States and in Canada.

Snow-bunting, or **SNOWFLICK** (*Plectrophenax nivalis*), a bird of the Finch family (Fringillidæ), Bunting sub-family (Emberizinae), abundant in summer in the Arctic regions generally, where it has been found nesting nearly as far north as man has reached; in winter migrating southwards to

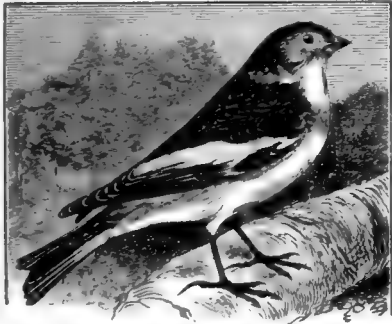

Snow-bunting (*Plectrophenax nivalis*).

Georgia in North America, to Japan, northern China, Turkestan, southern Russia, the northern shores of the Mediterranean, and Morocco. In Iceland it abounds all the year round; in the Faroes it is common in winter, and many remain to breed; in the British Isles it occurs in large flocks in winter, and it has also been found nesting on high mountains in Sutherland and in the Shetlands. It is a bird about 6½ inches long; plumage black and white; bill, legs, and feet black; but in autumn the feathers of the upper parts are broadly edged with dull chestnut, the bill is yellow with a black tip, and the bird is then known as the Tawny Bunting. In habits it differs in several respects from the true buntings: it runs rapidly on the ground, it also hops, and not infrequently perches on trees; and the song of the male while the female is on the nest is a low, melodious warble. The food in summer consists of insects, in winter of seeds. The nest, made of dry grass and moss, and lined with hair and feathers, is in northern breeding haunts placed on the ground not far above the sea-level; but in more southern latitudes it is generally built in rocks on the rugged sides of mountains. The snow-bunting is generally very fat, and is highly esteemed for the table. The Greenlanders kill great numbers, and dry them for winter use. See the article BUNTING.

Snowdon, a mountain-range in Carnarvonshire, North Wales, stretches in a north-east-by-north direction from a point 5 miles N. of Criccieth, near the head of Cardigan Bay, to near Conway, but is broken up by valleys and river-courses into five distinct summits, the chief of which, Moel-y-Wyddfa ('conspicuous peak'), the highest mountain in south Britain, was shown by the new Ordnance

map of 1889 to rise only 3560 (not 3571) feet above sea-level, and is crowned by two huts, the 'Hotel.' Seen from the top, Moel-y-Wyddfa, the 'King of Snowdonia,' appears to send out three ridges, which gradually divide and subdivide, giving birth to numerous valleys and corries. Its ascent is effected from Llanberis (on the north), Beddgelert (on the south), Snowdon Ranges station (on the west), and Capel Curig (on the east). The first is short (5 miles) and the easiest—a railway was opened in 1896; the last the longest (9 miles) and most difficult, but far the grandest. 'Snowdonia' was made a royal forest by Edward I. of England, and disafforested in 1649. In 1889 Sir E. W. Watkin purchased Snowdon for £5750. See Huson, *Round about Snowdon* (1893).—Snowdon was also an old name for Stirling.

Snowdrop (*Galanthus*), a genus of plants of the natural order Amaryllidaceæ, of the same tribe with Amaryllis, Snowflake, Crinum, &c. The three outer segments of the perianth spread, so as to make a bell-shaped flower; the three inner are shorter, erect, and notched at the summit. The flowers arise from a spathe. The root is bulbous, and produces two leaves and one single-flowered leafless stem (*scape*). The Common Snowdrop (*G. nivalis*), a plant too well known to need description, is a native chiefly of the south of Europe, growing in woods and pastures. It is found apparently wild in some places both in England and Scotland, but is probably rather naturalised than native, having long been much cultivated in gardens. This welcome harbinger of spring flowers usually in Britain in February and March. Another species of snowdrop (*G. plicatus*), with much broader leaves, is found in the south of Russia and in Asiatic Turkey.

Snow-shoes, a species of shoe whose broad surface prevents the foot from sinking in the snow. The Canadian snow-shoe (3 to 5 feet long and 1 to 2 feet wide) presents somewhat the shape of a tennis racquet with a short handle behind and long oval body contracted in front. It consists of a light frame of tough wood supporting a web of raw hide, to which, on the widest part, the foot is fastened by thongs, which leave the heel free. The Norwegian *ski* is simply a long, narrow wooden runner (5 to 10, but usually 8 feet long, by some 4 inches wide), about 1 inch thick at the middle, but thinner towards the ends, and turned up in a curve at the front (sometimes slightly at the back also).



Common Snowdrop (*Galanthus nivalis*).

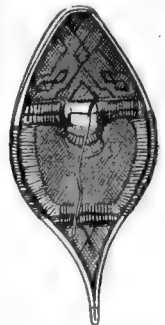

Snow-shoe.

Snuff. See TOBACCO.

Snyders, FRANCIS, a Flemish painter, born at Antwerp in 1579, studied under Van Breughel and Van Balen. Originally he confined himself to painting fruits, game, vegetables, and other typical models of still-life; but under the influence of Rubens, for whom, as well as for Jordaens, he frequently painted animals and still-life subjects to go in their larger pictures, he cultivated more especially the painting of animals. His bear, wolf, and boar fights have hardly ever been surpassed. He painted a stag-hunt and similar hunting subjects for Philip III. of Spain. Snyders died at Antwerp in August 1657.

Soane, SIR JOHN, an English architect, born of humble parentage at Reading on 10th September 1753. He managed to get trained as an architect, and, having gained the travelling scholarship of the Royal Academy, spent three years (1777-80) in Italy. After his return home he secured several official appointments—e.g. architect to the Bank of England, St James's Palace, Office of Woods and Forests—and was elected professor of Architecture at the Royal Academy (1806). He designed numerous country-houses in the eastern counties and parts of public buildings (Bank of England) in London, showing in his plans considerable ingenuity, but an uncertain taste, and frequently a lack of harmony in his completed plans. At his death, in London on 20th January 1837, he bequeathed his own house in Lincoln's Inn Fields, and the valuable art and antiquarian museum it contained, including pictures by Hogarth, Reynolds, Turner, models by Flaxman, the MS. of Tasso's *Gerusalemme Liberata*, &c., to the nation. He published amongst other books a set of folio plates of *Public and Private Buildings* (1828), and a *Description* (1832) of his own house and museum.

See the Memoir by J. Britton (1834), and the *Art Journal* (1882).

Soap is the term applied to that class of compounds formed when alkalis act upon fats or fatty acids. Chemically it includes also the insoluble compounds formed from metallic oxides, as lime, litharge, &c.; but industrially it is confined to the compounds of soda and potash. Soap is first mentioned by Pliny, who states that it was prepared from goat's tallow and beech-tree ashes, and was employed for giving brilliance to the hair. The excavations at Pompeii brought to light a complete soap-making establishment, containing some well-preserved soap. The industry, however, advanced very slowly, and it is only within comparatively recent years that it has really flourished. The most important discoveries which have assisted its development and led to its present enormous proportions are Chevreul's researches on the constitution of fats and Leblanc's process for the manufacture of soda on a large scale. It has also been stimulated in Britain by the repeal in 1853 of the duty (amounting to from 1d. to 3d. per lb.), first imposed in 1711. Chevreul showed that the neutral fats are mixtures of 'glycerides,' consisting of glycerine combined with the elements of certain fatty acids. In the process of saponification the fat is decomposed, the fatty acids combining with the alkali to form soap, while the glycerine is set free.

Soaps are distinguished as 'hard' (soda-soaps) and 'soft' (potash-soaps). They have a characteristic taste, and are soluble in water and in alcohol. When agitated with water a 'lather' is produced, and when their hot aqueous solutions are allowed to cool jellies are formed. Salt precipitates them from their solutions, but in the case of a potash-soap the bulk is converted into a soda-soap by double decomposition. The cleansing power of soap has not been satisfactorily explained; it is

generally supposed to be due to the 'hydrolysis,' or partial decomposition into free alkali and insoluble acid-soap which takes place when the soap is dissolved in water. Dittmar considers that the cleansing power of soap may be attributed to 'the inherent property of its solution to emulsionise fats,' which seems a more plausible theory.

The principal fats and oils employed in the manufacture of soap are tallow, greases, palm-oil, lard, cocoa-nut oil, and olive-oil for 'hard' soaps; distilled fatty acids are also used, and rosin in conjunction with tallow, &c. For 'soft' soaps linseed-oil, castor-oil, and fish-oils are used, as well as some of those already mentioned. The caustic alkalis, potash and soda, were formerly prepared from the carbonates by the soap-maker himself, but are now almost entirely procured from the soda-manufacturer.

The following processes, arranged in order of simplicity, are those used in the manufacture.

(1) The direct union of free fatty or resinous acids and alkalis.—This process is seldom used. The fatty acid (e.g. oleic) is run into a steam-jacketed pan, provided with a mechanical agitator, and raised to about 300° F. by super-heated steam. A strong solution of the necessary quantity of alkali is then added, and the whole well stirred. The mixture is allowed to stand for some time, some water added, again stirred, and removed to cooling-frames.

(2) Treatment of fats with definite quantities of alkali, the glycerine remaining with the soap; known as the 'cold process.'—Given weights of fat are melted at the lowest possible temperature, and mechanically mixed in a pan with a definite quantity of caustic lye of known strength, just sufficient to effect complete saponification. After standing for from one to four days, according to the quantity, the soap is hard enough for use. This process possesses the advantages of economy and retention of the glycerine. Soaps made in this way, however, are liable to contain free alkali, and of necessity contain also the impurities of the soda.

(3) Treatment of fats by boiling with indefinite quantities of alkaline lye.—This process is the most important of the three, and will now be described as it is carried out for 'hard soaps.'

Hard Soaps constitute the great bulk of the soaps used, and may be divided into three varieties—curd, mottled, and yellow. The general method is the same for the three. The vessel used (called the 'copper') is made of wrought-iron plates riveted together, and is provided with coils for supplying open and close steam. These 'coppers' are generally of circular form, and capable of turning out from 20 to 30 tons of soap at one operation, although some of them are much larger. In the first stage (called 'killing the goods') a quantity of the fat is melted in the 'copper,' weak caustic lye added, and the steam turned on. The mass becomes pasty after some time, and the boiling is continued, and fat and lye added, until a sample appears somewhat firm, and has very little or no caustic taste. In the second stage ('cutting the soap' or 'salting') the water is separated from the soap (the boiling being continued) by the cautious addition of common salt, or strong brine, until clear liquor runs from a small sample taken out. After standing for a few hours the 'spent lye' (containing the bulk of the glycerine of the fat, common salt, and the impurities of the caustic soda) is removed. In the third operation ('clear boiling') the granulated soap is boiled for two to three hours with fresh lye, in order to cause more complete saponification, and to remove the brine retained by the soap. After settling, the lye is removed, and may be used for the treatment of

more fresh fat. The contents of the 'copper' are again boiled with open steam and lye for several hours, to complete the saponification of the last traces of fat, and 'make' the soap.

The method of finishing the soap varies with the kind of soap required, and will now be explained under the names of the three varieties.

Curd Soaps.—The finest quality is made from tallow, but other fats may be used. When the soap has been 'made,' as just explained, the lye is concentrated by means of close steam, until a sample of the soap appears hard. The boiling is then stopped, and the soap removed, after settling.

Mottled Soaps, as far as composition is concerned, are practically 'curd' soaps; darker fats, however, are used in their manufacture, and after the soaps have been 'made' the lye is not concentrated so far as with 'curd' soaps. Many precautions require to be observed in order to obtain the natural 'mottling' which characterises them. It is due to the presence of small quantities of lime, magnesia, &c., from the materials used, and to oxide of iron, from the 'copper.' These oxides form insoluble soaps, and when the soap, retaining a little lye, is transferred to the cooling frames, they collect together, producing the well-known appearance.

Natural 'mottling' may be accepted as a guarantee of the absence of an undue amount of water in a soap. Artificial 'mottling' of inferior qualities of soap with ultramarine, oxide of iron, &c. is largely practised, sometimes with fraudulent intentions. 'Mottled' soaps are much used for laundry work and such purposes.

Yellow Soaps contain rosin as an essential constituent. The finest qualities are made from the best tallow and light-coloured rosin; inferior qualities from darker tallow, bleached palm-oil, &c., and darker rosin. The rosin is usually introduced after the second stage of the general process. The finishing operation, or 'fitting' of yellow soaps, requires much experience. After the soap has been 'made' the 'copper' is allowed to stand for about twelve hours, the lye removed, and the soap well boiled until homogeneous, with some fresh lye if necessary. When a sample has been found to be in the proper state, the 'copper' is covered up, and allowed to stand for some days, when a separation into three layers takes place—the scum or 'fob' on the top, the 'nigre' (or dark alkaline soap-lye) underneath, and the finished or 'neat' soap in the centre, which is then removed to frames. The 'nigres' are utilised in the making of darker soaps. The principal soap-manufacturers now recover the glycerine from their 'spent lyes.'

Cocoa-nut or Marine Soap.—Cocoa-nut oil is saponified in the heat, with strong lye, without salting out, &c. A hard soap is formed, although much water may be present, and is serviceable on board ship, when condensed water is not available, on account of its solubility in salt water.

The operations subsequent to the soap leaving the 'copper' require little explanation. When no 'filling' substances are to be added the melted soap is run, or ladled, into large oblong boxes of wood or iron, called 'cooling frames.' After standing for several days to allow the soap to harden, the sides of the frames are removed, and the blocks of soap cut, first into slabs, by means of a thin steel wire, and then into 'bars' by a special machine, consisting generally of a strong frame or lever, carrying a number of wires stretched across it. The 'bars,' after having been stamped with the name of the maker, and the brand of the soap, are ready for being sent out.

The demand of the public for cheap soap has led to what is known as 'filling.' This consists in mechanically mixing with or 'crutching into' the

soap, after it leaves the 'copper,' certain substances, added either with the view of increasing the detergent power of the soap, or simply to lessen the cost. Silicate of soda belongs to the first class, and is used with advantage in certain soaps. Such substances, however, as water, talc, clay, chalk, sulphate of baryta, &c. must be looked upon merely as adulterants.

Soft Soaps are really impure solutions of potash-soaps, with glycerine, in caustic lye. They form transparent jellies, and often exhibit, in cold weather, a white graining, or 'figging,' due to alkaline stearates. The oil (e.g. linseed, or any other of those named above) is run into the 'copper,' potash lye added, and the steam turned on. The boiling is continued, latterly by close steam or fire heat, and lye added, until a small sample appears clear on cooling, and no liquid separates from it. When finished the soap is run into barrels or tins.

Toilet Soaps.—The basis or 'stock' of the better qualities is generally good curd or yellow soap, special precautions being taken to ensure absence of free alkali. The finest toilet soaps are now 'milled.' For this purpose the soap is cut into shavings, dried partially, the colouring material and perfumes added, and passed several times between granite rollers, to make it perfectly homogeneous. It is then subjected to great pressure, or 'plotted,' to form it into bars, which are afterwards cut, and stamped into tablets. The lower qualities of toilet soaps are generally made by the 'cold process.'

'Transparent' soaps are prepared by dissolving good dry soap in alcohol, pouring off the clear solution, and removing the bulk of the spirit by distillation. The remaining soap is transferred to moulds, allowed to cool, and preserved in warm chambers for several months, until it becomes quite transparent. Many transparent soaps, however, are made by the 'cold process,' their transparency being obtained by the addition of sugar. Glycerine is often added to both opaque and transparent soaps, imparting to them its characteristic emollient properties, while such substances as carbolic acid, coal-tar, eucalyptus-oil, &c. are added to soaps intended for disinfecting purposes.

The following table gives the average composition of some genuine soaps of English make :

	Fatty Anhydr.	Alkali (Na ₂ O).	Water.	Salts.	Glycerine and Salts.
Curd	63·21	8·44	26·76	1·59	..
Mottled	64·17	7·80	26·66	2·37	..
Yellow					
(best).....	61·95	7·07	30·45	0·53	..
Cocoa-nut ..	52·95	8·55	30·08	..	8·77
Toilet					
('milled')	80·06	9·56	9·11	1·27	..
Soft.....	40·26	(K ₂ O). 9·18	44·78	..	5·68

The commercial value of a soap depends upon its percentage of fatty anhydride. Soap is used otherwise than as a detergent—as a handy ointment for skin irritated by friction, as a laxative medicine, in making pills, liniments, and plasters, and as a test for the hardness of Water (q. v.).

See R. S. Cristiani, *Technical Treatise on Soap and Candles* (1881); W. L. Carpenter, *Soap, Candles, Lubricants, and Glycerine* (1885); A. Watt, *The Art of Soap-making* (1885; 4th ed. 1890); J. Cameron, *Soap and Candles* (Churchill's 'Technological' series, 1888); and C. F. Cross's 'Health Exhibition Lecture on Soap' (1884).

Soapberry. The fruits of several species of trees belonging to the genus *Sapindus* (natural order Sapindaceæ) contain a pulp which is useful as a substitute for soap in cleaning linen and other

textile fabrics. In the West Indies the fruit of *Sapindus Saponaria*, and in the East Indies those of *S. emarginatus* and *S. attenuatus* are much used for this purpose. The frothy mixture which these fruits make with hot water is said to be very serviceable for cleaning dyed fabrics which soap would injure. In France silk stuffs are cleaned with the seed vessels of *S. emarginatus*. The seeds of *S. Saponaria* are made up into rosaries, and were formerly worn in England tipped with gold, silver, &c. as buttons.

Soap-bubbles. As a form of amusement for children the blowing of soap-bubbles is of great antiquity, and is to be seen depicted on an Etruscan vase in the Louvre. In their scientific aspect soap-bubbles and soap-films have been studied specially by Plateau, who, by adding glycerine in a certain proportion to the soap solution, obtained remarkably durable films and bubbles. The beautiful play of colours familiar to all is due to the excessive but variable thinness of the soap-film. It is in fact an illustration of the interference phenomenon known as Newton's Rings (see INTERFERENCE, NEWTON). If at any part the film becomes thin enough the black spot appears. If this black portion is touched the film is shattered at once, although it may in its thicker portions be pierced by a needle without losing continuity. The spherical form of the ordinary soap-bubble is a direct result of the action of Surface-tension (q.v.), the geometrical condition being that with given volume the surface must have minimum area. With soap-films formed on frames of wire the same principle holds—for given boundary and given internal volume the area must be a minimum. Thus, by a skilful arrangement of soap-films, we may make visible many highly interesting problems in pure mathematics. See *Soap-bubbles*, by Professor Boys (S. P. C. K., 1890).

Soap-stone. See STEATITE.

Soap-tree. See SOAPBERRY.

Soapwort (*Saponaria*), a genus of plants of the natural order Caryophyllaceæ, having a cylindrical or ventricose five-toothed calyx, without any



Soapwort (*Saponaria officinalis*).

outer calyx or attendant bractee, five undivided petals with long claws, ten stamens, two stigmas, and a capsule opening at the top by four valves. Some of the species have very beautiful flowers. *S. calabrica* is one of the most favourite annuals of British flower-gardens. Common Soapwort (*S. officinalis*) is found on waysides, in thickets, and on the banks of streams in most parts of Europe, although it is a somewhat doubtful native of Britain. Both the root and the leaves contain Saponin (q.v.), in consequence of which they are sometimes employed for washing. The brownish-red colour of the bark of the root, however, is apt to tinge white articles. The root of this plant has also medicinal properties, being aperient, resolvent, and alterative. It is sometimes sold as Red Soap-root.

Nearly allied to the genus *Saponaria* is the genus *Gypsophila*, some species of which are called Soap-root, and contain much saponin. Thus, the Egyptian Soap-root (*G. struthium*), and the Spanish Soap-root (*G. hispanica*), called *Jabonera* in Spain, have been employed for washing from time immemorial, and the roots, not having a dark rind, can be used for washing white articles, and are to some extent an article of commerce, being used for silken and other stuffs, the colours of which will not bear the application of soap. The roots of *Lychnis dioica*, one of the most common British plants, possess the same properties in an inferior degree. The bark of *Quillaja saponaria*, a Chilean tree of the natural order Rosaceæ, contains much saponin, is generally used for washing in Chili and Peru, and there forms a considerable article of commerce. It is said to give a remarkable lustre to wool, and to be an invigorating wash for the hair. Some of the tropical South Sea Islands produce a species of vine (*Vitis saponaria*), the stem of which, especially the thicker part, cut into pieces, and softened by cooking on hot stones, produces in water a rich lather almost equal to that of soap. See also SOLANUM.

Sobat, a tributary of the Nile (q.v.).

Sobbing is merely a modification of the ordinary movements of respiration excited by mental emotions. It is the consequence of a series of short convulsive contractions of the diaphragm, and is usually accompanied by a closure of the glottis, preventing the entrance of air into the lungs.

Sobieski, the surname of JOHN III., king of Poland, one of the greatest soldiers of the 17th century, was born at Olesko in Galicia on 2d June 1624, his father being castellan of Cracow. He early distinguished himself in the wars in which Poland was at that period almost constantly engaged, against the Russians, the Tartars, and the Turks. Upon the last he inflicted crushing defeats at Buczacz (in Galicia) in 1669, and at Choczim (Khotin) on 11th November 1673, capturing the green standard of Hussein Pasha, commander of the Turks, and slaying more than 20,000 of his soldiers. In the next year he was chosen king of Poland. A high-minded, brave, and disinterested man, and a shrewd statesman, he conceived it to be his special mission to contend with all his energy and power against the enemy of Christendom that threatened from the shores of the Bosphorus. He again routed the Turks at Lemberg in August 1675, and in 1676 successfully defied their utmost efforts to storm his entrenched camp near the Dniester. After a truce of five years—a breathing-time employed by the sultan to gather fresh armies and war material—the Turks once more overran Hungary, and even laid siege to Vienna. Sobieski, always swift in his marches, and vigorous and determined in his attacks, hastened to its relief at the head of 18,000 Poles. With these, and 50,000 German troops, who joined him on the way, he smote the 100,000 men of the Turkish commander so terribly, on 12th September 1683, that the siege was at once raised and the Turks hastened to retire. Sobieski died at his castle of Willamow on 17th June 1696. This prince was a lover of books and of knowledge, and himself a clever linguist.

See his *Letters to his wife* (French trans. 1826); Salvandy, *Histoire du Roi Jean Sobieski* (Paris, 1876); and an article by Lady Verney in the *Contemporary* (1876).

Sobral, a town of Brazil, in the state of Ceara, on the Aracaty, 78 miles by rail SSW. of the seaport Camossin. Pop. 10,500.

Sobraon, a village of the Punjab, on the west bank of the Sutlej, opposite which, on the east bank, was fought on 10th February 1846 a most

obstinate battle between the British under Sir Hugh Gough and the Sikhs (q.v.), which put an end to the first Sikh war. Pop. 4000.

Socage. See TENURE.

Social Contract. See GOVERNMENT, ROUSSEAU, SOPHISTS.

Socialism. As opinion is still so much divided regarding the significance and tendency of socialism, it would not be advisable to attempt a preliminary definition of the word. According to Mr Holyoake (in his *History of Co-operation*), the word originated in 1835 in connection with the Association of all Classes of all Nations, founded in that year by the socialist Robert Owen. The name laid special emphasis on the necessity for social reconstruction and renovation, as contrasted with the political reforms which were then so much agitated, and was therefore soon adopted as suitable and distinctive. It was borrowed by Reybaud, an eminent French writer, in his *Reformateurs Modernes* (1839), and gained a wide currency on the European continent; and it is now the recognised name for a movement which has affected almost every country of the civilised world.

In this article our chief aim obviously is to expound socialism as a historical phenomenon or set of phenomena. But even in this sphere the task is not without its difficulties, as there is little agreement even with regard to the historical application of the word. The application of words is determined by use and wont, and it cannot be said that we yet have anything like a settled use and wont to guide us in this matter. And the difficulty is greatly aggravated by the fact that socialism is a historical movement which is not complete. Indeed, it is probably only in its earliest stage, and what now strikes many observers as its most important features may prove to be merely passing phases of a great world-historic development.

The first difficulty that meets us lies in the question whether socialism is an ancient or purely modern phenomenon. If socialism be essentially a form of communism, as is sometimes maintained both by friends and opponents of the movement, then it is simply a revival of one of the oldest phenomena in history, the only novelties in it being the modern facts by which it is alleged to be justified or to which revolutionists seek to adapt it. If so, the problem would be greatly simplified, for the arguments against the practicability of communism, grounded in human nature and repeatedly brought out in history, are so strong that the identification of the socialistic movement with it would be sufficient almost to remove it from the region of serious discussion. Again, if we regard socialism as a social and economic system by which the individual is unduly subordinated to society, we must still pronounce it to be an old phenomenon, because in many primitive societies and in many ancient states, both of Greece and Italy, the subordination of the individual to the community in which he lived was excessive. Or again, if we define socialism as a systematic discontent and revolt against prevailing economic conditions, the wide range of the phenomenon at the present day may give it a unique place in history; but it cannot reasonably be considered a new thing, as social discontent was often strong even in old societies, and in a more or less conscious form may be said to have existed in every community from the beginning. The great historic instances of such discontent are found at the declining period of the Greek and Roman republics and during the economic changes which attended the fall of feudalism and of the Catholic Church in so many countries of Europe. The same periods were marked by far-reaching

schemes of reform, and by books like the *Republic* of Plato and the *Utopia* of Sir Thomas More, which embodied the ideals of eminent thinkers. Thus we see that dissatisfaction with the present state of things and the longing for the ideal are very old phenomena in the history of the world. The same features are observable in the Hebrew prophets who wrote during the declining period of Jewish history. Lastly, should we grant that socialism is simply a modern phase of the revolutionary spirit, we should still require to know the grounds and motives of it, as a revolution is only the form assumed by the activity of a new force which is powerful enough so to express itself. The violent change called a revolution is one of the oldest things in history; and it really throws little light on a movement when we describe it as revolutionary.

The claim of socialism to be distinctly a new movement may be regarded as resting on two great facts—the industrial revolution and the development of the modern democracy. As England led the way in the industrial revolution, the course of it can be best followed by reference to the history of that country. On the downfall of feudalism towards the close of the 15th century the retainers of the barons were dispersed. Whereas it had been the interest of the feudal noble to support the largest possible number of fighting men, the prestige of the new court aristocracy depended mainly on the rents they could raise. Thus the commercial spirit became a prominent feature of land-owning; the small holdings were transformed into large sheep-runs, because the latter paid better; and the old tenants were forced from the land, either to sink into hopeless vagrancy or to drift into the towns. All those tendencies were greatly aggravated through the confiscation of the churchlands on the downfall of the Roman Church and the suppression of monasteries. In this way began the divorce of the worker from the land, which is at once the material of labour and the source of subsistence and of culture. At the same time great changes of enormous magnitude were proceeding abroad. The discovery of America and of the sea-route to India opened up vast countries to European enterprise and colonisation, resulting in the establishment of a world-market, which again gave fresh impetus to the economic change at home. The demand for goods created by the world-market particularly stimulated invention, till during the course of the 18th century a series of new mechanical appliances brought the industrial revolution into full activity. This revolution is still going forward. It is spreading over all countries of the world; and the new motive-power electricity is already beginning to supersede steam. The results of the industrial revolution in so far as they have a bearing on the present subject may be thus summed up. Production is no longer carried on by individual or family labour for local or family use. The labourer has no control of the instruments of labour. Instead of working on his own account with his own small capital, he toils in large factories and other undertakings under employers who own and control the capital embarked in them. Industry is carried on by the united efforts of thousands of men, and is therefore no longer an individual function, but a social and collective one. On these grounds socialists maintain that the energetic individualism which originated and established the industrial revolution has been superseded by the results of that revolution. Individual industry is no longer the normal or prevalent form of industry.

It has been shown (see DEMOCRACY) that the modern democracy is the solid, enduring, and inevitable result of far-reaching causes. The most

famous historic expression of it was the French Revolution; and though the ideals of that revolution, liberty, equality, and fraternity, were sadly discredited by the extravagant and sanguinary proceedings in France, it will generally be admitted that a great moral and political gain to the world has been achieved through the growth of democracy. At least no one will deny that its influence has been vast, and as yet is far from exhausted. One of the first effects of the democratic movement was to bring the middle-class into prominence. More recently the working-class has received the chief share of attention. While the middle-class in most civilised countries do more than any other in controlling industry and politics, the working-class is everywhere struggling into action.

The general result of the industrial revolution, therefore, has been the growing concentration of industry and of the capital with which it is carried on; and the development of democracy has tended to inspire working-men with a desire for a larger share of political power and for a fairer distribution of the means of culture and happiness. The rise of socialism as a modern phenomenon was conditional by the two revolutions. It was the industrial revolution, which had made the working people the victims of machinery and the factory, that Robert Owen had chiefly in view; the great aim of his socialism was to render mechanical invention subservient to human well-being. Saint-Simon (q.v.) was a Frenchman who had lived through the troubles and excesses of the Revolution; and his theories were moulded by that great event. After the destructive liberalism of the Revolution he believed that the time had come for a positive reconstruction of society. His views were more thoroughly elaborated by his disciples. In history they recognised two kinds of epochs, the negative or destructive, and the organic or constructive. The former was marked by the spirit of criticism, anarchy, and war; during the latter religion, love, and the spirit of association were dominant. But the spirit of association will more and more prevail till it embrace the entire world. The keynote of the history of the world during the past has been the exploitation of man by man in its three stages, slavery, serfdom, and wage-labour. The keynote of the future will be the 'exploitation of the globe by man associated to man.' But according to the Saint-Simon school a better society is possible only through the abolition of the hereditary principle, by which ruling classes are from generation to generation secured in the possession of the good things of the world, while the other classes are handed over to perpetual misery. There is only one way to break the fatal chain of continuity, and that is to vest the instruments of production in the state, which will administer them for the benefit of all its members. The state would delegate to associations the practical industrial work, and each man would be rewarded according to his services. Saint-Simon and his school would therefore answer the problems raised at the Revolution not by the restoration of the old feudal and priestly régime, not by following out the negations of liberalism, but by a new positive order, in which the spiritual direction would be given to the men of science and the practical control of production to chiefs of industry. His system was not reactionary; nor was it democratic or revolutionary.

The system of Fourier (q.v.) is in several respects an entire contrast to that of Saint-Simon. Whereas Saint-Simon insisted on the principle of authority, Fourier carried to its extreme development that liberty which had been the chief watchword of the French Revolution. While the school of Saint-Simon gave the state the ownership and control of the instruments of production, Fourier left the

capital in private possession, thus securing a fresh guarantee for freedom, but providing against the abuses of private capital by placing it under social control. And Fourier devised another guarantee for freedom by making the commune, or local association, which he called the *phalange*, the cardinal and decisive factor in social reconstruction. In the Saint-Simon school the state is the point of departure and the controlling power, to which the associated bodies are subordinate. With Fourier the commune is substantive, self-sufficing, and independent. The federal organisation into which his communes may enter is entirely voluntary. In short, Saint-Simon's is a centralised socialism, Fourier's is a communal socialism. In this respect Owen agrees with Fourier.

The three systems of Saint-Simon, Fourier, and Robert Owen had been produced during the reaction which set in after Waterloo. Though they had been elaborated in full consciousness of the great events which had marked the closing period of the 18th century, they were intended rather as a corrective of the democratic movement than as a continuation of it. They had little faith in the ordinary democratic ideals. In one important respect, however, they fully participated in the illusions of the early period of the French Revolution. They shared in the comfortable and confident optimism which believed it to be a simple thing to reconstruct society. They thought that they had found a short and easy way to regenerate society. They knew little or nothing of the principles which determine social development, and this perhaps more than anything else lends an air of utopianism and unreality to all their speculations. Their theories never really took root in the practical life of the time.

The French socialism of 1848 had a solid basis in the real life of the time, inasmuch as it entirely and enthusiastically accepted the democratic principles. The first condition of the socialistic proposals of Louis Blanc (q.v.) was the thoroughly democratic organisation of the state; the first duty of such a state was to place its resources at the service of the poor. The state, he maintained, was the banker of the poor. In the social workshops, which he advocated, membership was to be voluntary, and they were to be self-governing, as became the institutions of a democratic state. It has now been fully proved that Louis Blanc's schemes never had a fair trial under the republican governments of 1848. The *national workshops* were only a travesty of his *social workshops*, expressly intended to discredit them. Louis Blanc had not robustness of character or enduring political influence enough to enforce attention to his plans.

While Louis Blanc may thus be regarded as the first historic advocate of the social-democracy, another man who was prominent during the troubles of 1848 must be considered as the founder of a form of socialism still more revolutionary. Proudhon (q.v.) first associated socialism with *anarchism*, which holds that the goal of society is freedom without government. Proudhon was one of the storm-birds of the revolutionary period of 1848; but, with all the violence and extravagance of his utterances in the press and in the chambers, he was too shrewd and kindly a man to have any concern in the rising of June of that year. That was an outbreak of the proletariat, for which the socialist leaders were not responsible.

After the revolution of 1848 France ceased to be the pioneer in socialistic speculation and agitation. Germany and Russia have since produced the foremost men in both departments of activity. The German thinkers, Rodbertus, Lassalle, and Karl Marx, undoubtedly take the first place in the history of socialism as the scientific exponents of

the subject, and controversy still thickens chiefly around these three names. To them, and above all to Karl Marx, we are indebted for the prevailing forms of contemporary socialism. While the French socialism that preceded them may be regarded for the most part as ingenious speculation very inadequately grounded in facts, Rodbertus, Lassalle, and Marx seek to justify their theories by a vast and elaborate learning, especially historical learning. They were men of philosophic training, and had a knowledge of economic literature and of the historic economic forces which has seldom been equalled.

The earliest writings both of Rodbertus and Marx were prior to 1848. The manifesto of the Communist party, perhaps the most violent revolutionary document of the 19th century, was drawn up by Marx and Fr. Engels in 1847-48. But their work did not really become historic till a later period. Lassalle, the youngest of the three, was the first to run a very remarkable career as the founder of the social-democracy of Germany. His proposals for the founding of productive associations were substantially the same as those of Louis Blanc, and were even to some degree enforced by the same arguments. The two agitators also resembled each other in the fiery and persuasive eloquence with which they captivated the workmen of their respective countries. But Lassalle as far surpassed Louis Blanc in philosophic and historical erudition as he was inferior to him in simple integrity and straightforwardness.

While Lassalle therefore was greatly indebted to Louis Blanc for his practical schemes, he derived his theoretical principles to a large degree from Rodbertus and Karl Marx. It would be unjust, however, to regard him as an ordinary borrower. All his activity both as thinker and agitator bore the stamp of his own temperament, which was one of remarkable originality; and indeed the main burden of his teaching is not traceable to any theorist, but had already become the common possession of all socialists who were tolerably well versed in the literature of their subject. The same remark applies to the controversy, whether to Rodbertus or Marx belongs the priority of having established what are considered the fundamental principles of scientific socialism. These principles have already been briefly sketched in the articles LASSALLE and MARX, and need not be repeated here; but we may point out that, while Lassalle dwells chiefly on the small share of the result of production which goes to the labourer as a subsistence wage, Marx finds the keynote of the evolution of capitalism in the large share which falls to the capitalist under the name of surplus value. Both start from the open contradiction in the Ricardian economics, according to which labour is the source of value, but of this value the labourer only gets enough for subsistence according to the usual standard of living, surrendering the remainder to the possessors of land and capital. These deductions from Ricardo formed also the basis of the system of Rodbertus. In other respects, however, he differed greatly from Lassalle, and particularly from Marx. Rodbertus was a Prussian lawyer and landholder, and from temperament and social standing was entirely opposed to agitation and revolution. His general position was social, monarchical, and national. He accepted the monarchic institution in his own country and hoped that the German emperor might undertake the rôle of a social emperor. The socialism which he advocated was a thoroughgoing national socialism, but he did not expect its full realisation, except as the goal of five centuries of moral and political effort. He proposed that the two classes of landholders and capitalists should continue to enjoy their present

share of the national income, but that the results of an increasing production should go entirely to the workers. The state would establish a normal working day, a normal day's work, and a normal wage, which would be periodically revised, and increased according to the increase of production. In this way the practicability and superiority of a national socialism would be shown, the characteristic note of which would be that all income should be dependent on *service*, as contrasted with the ancient income derived from property in slaves, and the incomes of the existing era, drawn from private property in land and capital.

The International was the outcome chiefly of the activity of Karl Marx. The social-democratic movement in Germany originated with Lassalle. At his death in 1864 his union counted only 4610 members, and its history was for some time chequered by petty jealousies and mean intrigues. It succeeded better under the leadership of Schweitzer (1867-71). In the meantime, Bebel, a Saxon workman, and Liebknecht, a disciple of Marx, who naturally were opposed to the Prussian national socialism favoured for purposes of propaganda by Lassalle, had led a strong combination of workmen's societies over to the International. The two parties quarrelled violently for some years, till in 1875 their common interests, and especially the severe treatment of both by the Prussian police, drew them into a union, which was settled at Gotha (1875). They called themselves the Socialistic Working-men's Party of Germany, and drew up a programme, which is still the creed of the German social-democrats. The progress of German social-democracy both before and since the union at Gotha has been marvellous. Five members were elected to the North German Reichstag of 1867. At the elections to the first German Reichstag in 1871 they only polled 120,000 votes; but the number had increased to 339,000 in 1874, and to nearly half a million in 1877. The rapid growth of the party, and the excitement occasioned by two attempts on the emperor's life, led to the passing of exceptional laws against socialists in 1878; but in spite of such legislation their voting strength continued to increase, till in 1887 they counted 763,000 votes, and in 1890 1,427,000, or about 20 per cent. of the total poll. It was also a notable feature of the election of 1890 that, whereas in rural and Catholic districts the socialistic propaganda had hitherto shown little or no symptoms of success, it had at that date made very material progress. The discontinuance of the severe anti-socialist laws, and the more sympathetic attitude of the young emperor on social questions, have also made an important change in the tactics of the party. While their methods and their language, in the press and on the platform, had previously been bitter, violent, and aggressive, there is now a marked tendency to moderation among their leaders. They see the hopelessness of overt opposition to the government, and they are content to await the development of the economic forces, which, following their teacher Marx, they believe will inevitably establish socialism in the fullness of time. But this change of tactics has not received the unanimous approval of German socialists, and a small party has already seceded from the main body.

Next to the Marx socialism the most prominent form of socialism is anarchism. As we have seen, the originator of anarchism was Proudhon; and its most notable expounder was the Russian Bakunin (q.v.). The characteristic feature of anarchism is really a political theory, the denial of government, and may be held with or without the economic principles which constitute the essence of socialism. The anarchic socialism of Bakunin was atheistic,

materialistic, and revolutionary. He condemned all forms of government, whether based on the will of a single ruler or on universal suffrage, as necessarily leading to tyranny. The one great aim of every reasonable creature is scientifically to know the laws of nature and to put himself in harmony with them. Thus the goal of social progress is an enlightened freedom, in which external control is superfluous and despotic, and every man is a law to himself. For attaining this end Bakunin advocated a policy of unsparing destruction of the existing society. The future organisation would proceed from the free initiative of the people, who will group themselves in associations, all the arrangements of which, including the institution of marriage, will depend on the free consent of the members. And these free associations will group themselves into a federation, formed and maintained on the same principle of freedom. In economics the school of Bakunin advocate a collectivism which is essentially the same as that of Marx. The International (q.v.), however, was broken up through the differences between the Marx party and that of Bakunin. The theories of anarchism have had a very considerable influence in France, Spain, Italy, and Russia. The risings in southern Spain in 1873 were stimulated by anarchist teaching. In 1883 the great trial of anarchists at Lyons made an interesting revelation of the theories and methods recognised by that school of socialists. It is not clear how far the revolutionary party in Russia has been affected by anarchist doctrines. Kropotkin, the eminent Russian exile, and the distinguished French geographer Reclus may be regarded as the chief living exponents of anarchism. The Russian revolutionary party has no doubt been greatly influenced by men like Bakunin and Kropotkin, but it has also owed much to Lassalle, Marx, J. S. Mill, Herbert Spencer, and other thinkers who have no sympathy with anarchism as a special form of political and economic thought.

During the last generation socialism has undoubtedly made great progress throughout the civilised world. Yet, except in Germany, and perhaps Denmark, the number of the avowed and active adherents of the movement is still comparatively small. The growth of the socialist voting power in Germany has been already noted. In Denmark the numbers of the socialist party are numerous enough to organise great demonstrations and to support a daily newspaper with a large circulation. French socialism is influential only in Paris and the industrial centres, and has returned a few representatives to the Chambers. In Italy and Spain there is a considerable socialist feeling, but it is mostly latent, and therefore cannot easily be measured. The movement is spreading in Austria and Belgium; whilst as regards Holland, Sweden, and Norway we can only say that the party, though increasing, fills as yet but a small portion of the national life. The revolutionary party in Russia has been exceptionally active, but its numbers have been small. In England, after having died out almost for a generation, the movement took a fresh start about 1883. For some years after that date it attracted great attention, and gained a number of able and active adherents; but it has again entered upon a quiescent stage. Socialism has also spread to America and the Australian colonies; yet, while the labour movement has most powerfully affected both continents, it cannot be said that organised and avowed socialism has made very marked progress.

The general result is that outside of Germany and Denmark the number of avowed and active socialists is comparatively small. On the other hand, few will doubt that the direct and indirect

influence of socialism on social economic and political thought has been very great.

Looking to the main drift of speculation on this subject both in the past and present, we may briefly define the fundamental principles of socialism as follows. Socialism holds that the present system of industry, which is carried on by private competing capitalists, served by competitive wage-labour, must be superseded by a system of free associated workers utilising a collective capital with a view to an equitable system of distribution. On this theory private capital will be abolished, and rent and interest will cease. The method of distributing the fruits of labour advocated by many socialists cannot be distinguished from communism. But this is not an implicate of the historic socialism. Several methods of remuneration professing to be equitable have been put forward, and each member of an association of workers would be free to use his special income as he pleased. In fact, all such moderate wealth as would be devoted, not to production, but to consumption, might be regarded as at the free disposition of the owner. And a method of distribution which fixed the remuneration of each in proportion to his services might admit of a very considerable variety in the amount of incomes. But the individual ownership of capital and the free disposal of it and the individual appropriation and possession of the advantages derivable from private capital in the form of rent and interest would terminate. A conspicuous exception to such an arrangement is found in Fourier, who made the continuance of private capital a substantial feature of his system. It remains, however, that the historic socialism in general as well as the active and organised contemporary forms of socialism demand the absorption of private in an absolutely collective capital. In the definition above given socialists of the Marx and of the anarchist schools would agree.

Probability is the guide of life, and it is extremely improbable that any system of industry involving the abolition of private capital should ever become prevalent. And if it were practicable it would greatly limit the legitimate and reasonable interests of human freedom. The materialism of the Marx and anarchist schools is also a grave objection to their theories as historically presented to us. Both schools too have laid most excessive stress on the virtues and possibilities of the revolutionary method of action. The evils of the existing society are not due merely to bad social-economic and political mechanism; they are rooted in human nature itself. No revolution can produce a magical change in human nature. A revolution can indeed remove abuses; but they always return in a modified form, or the old abuses are replaced by new ones. Human society and human nature can be radically improved only by a long and gradual organic change, economic, political, and ethical. It is particularly utopian of the Marx school to believe that the struggle of classes can be terminated by a great revolutionary act. In short, the socialism of Marx is altogether too absolute, abstract, and remote from the facts of history and existing human nature. His theory of surplus value is the most striking example of this abstractness; instead of being the key to the development of capitalism, it is really the vitiating element in a great and elaborate historical production.

Must we then regard socialism as a passing and errant phase in human development, which, after exciting wide-spread attention, like the forms of communism that have emerged at certain periods, is, like them, doomed to disappear? The answer to this question can really be given only in the history of the future. For socialism is not an

abstract and completed system identifiable with the theories of Marx or Bakunin; it is a thing in movement and subject to incessant change. But so far as the movement has proceeded we may justly say that it has had the following permanent results: (1) It has greatly helped to give prevalence to the historical conception of political economy. The idea of change has been natural to socialists; their subject has led them to study the rise, growth, decline, and fall of economic institutions. The great principle of evolution, as taught by Hegel and Darwin (see below), has been a commonplace in socialistic speculation. (2) Socialism has greatly deepened and widened the ethical conception of political economy. It has in season and out of season taught that the entire technical and economic mechanism should be made subordinate to human well-being, and that moral interests should be supreme over the whole field of industrial and commercial activity. The charge sometimes brought against socialism that it appeals only to the lower instincts of man is very wide of the mark. It would be a juster criticism to say that it inculcates an altruism unattainable by any probable development of human nature. (3) Socialism has brought the cause of the poor most powerfully before the civilised world. As the cause of the poor represents the social and economic side of the vast and inevitable movement of modern democracy, it is not likely again to pass out of the attention of the world, but will be the burning question in every civilised country for a long time to come. (4) Socialism has given an exhaustive criticism of the existing society and of the prevalent economic theories. In many things the criticism has been exaggerated, but it has been also in many things most valuable. Almost every economic treatise now appearing bears the marks of socialistic criticism of the present society.

Under all the above heads socialism has made a deep and abiding impression on the thought and activity of the world. Here, again, Germany leads the way in the recognition of the influence of socialistic theories, and this is particularly observable in the *Socialism of the Chair* and in the *State Socialism* which have played so great a rôle in recent German discussion and legislation. The socialists of the chair are an influential group of professorial and other economists, whose position may be best described as illustrating the influence of the socialist movement in the above directions. They recognise the historical and ethical character of economics; labour in all its aspects—in other words, the cause of the poor—is the subject of the most serious and exhaustive investigation; and all of them make important concessions to the socialistic criticism of the existing society. Bismarck was the redoubtable antagonist of the social democracy, regarding it as subversive of church and monarchy and fatherland; but he had considerable respect for socialistic principles, and he was prepared to hold the state as so far responsible for its suffering members. The state socialism of Bismarck was an outcome of this sense of responsibility, and the same feeling has been emphatically expressed by the Emperor William II.

The above considerations point to large and important changes in the existing society; yet they are perfectly consistent with the continuance of the present system of industry, the characteristic feature of which is, as we have seen, that it is carried on by private capitalists served by wage-labour. In spite of all such changes the worker would remain divorced from land and capital; he would have no control of the sources of subsistence and culture; and he might still have to be content with little better than a subsistence wage. Socialism, however, desires not a modification, but a renovation of the existing industry, and through it of the

existing society. While, therefore, we may admit that it has exercised a very considerable influence on social-economic thought and practice, the probability is that it will fail in making the revolution in society which it proposes to accomplish.

But it may also be maintained that, though the historic and contemporary socialism has been so much disfigured by extravagance, and has taken too little account of the fundamental principles of human nature, the main aim of the movement may be perfectly sound. The extravagances of socialism are obvious and confute themselves. Like other systems making great claims on mankind, it must be tried by its fundamental principles, which should be distinguished from the accidentals that have been associated with it in history. It may be said that we have only to liberate the historic socialism from its too abstract, absolute, and ultra-revolutionary forms and we have a new type of industrial organisation which has a reasonable claim to supremacy in the future. We can conceive industry as under the entire and efficient control of associated workers, making an equitable distribution of the produce, while private capital could be maintained in so far as it is necessary to freedom and individual development. In like manner the hereditary principle with all the implicates so important to society would be preserved, and by social control protected from existing abuses. As the co-operative workers would have effective control of the instruments of labour, that divorce of the labourer from the means of subsistence and culture which was one of the most lamentable results of the industrial revolution would terminate. The present differences between capital and labour would cease, inasmuch as labour would be united with capital under one and the same social management. The hours of labour and the remuneration of labour would be mainly and normally regulated not by competition, but by reference to reasonable human needs. For the realisation of such a condition of things much would depend on the growth of habits of free self-government and self-control. It could be brought about, not by a political catastrophe, but by a long and gradual process of organic change, especially in the minds and morals of the masses of the industrial population.

In short, socialism is the extension to industry and economics of the free self-governing principle recognised in democracy. It is industry of the people, by the people, for the people. When we remember that this type of organisation has from the time of Simon de Montfort taken more than six centuries to attain to imperfect realisation in the English parliament, it will be clear that it cannot succeed in the industrial sphere in a day. It may be maintained, however, that we can see the substantial beginnings of such an economic change in the extension of social control through (1) the state and (2) the municipality or commune, and (3) in the growth of the co-operative system. The company is at present the growing power in industry; but even as regards the great companies (4) the control of the state and of social opinion is continually extending. In the application of the profit-sharing principle we may discern a possible change towards a system in which the workers may have an interest in and control of the large industry. And in the continual development and concentration of business of all kinds in these great industries we may see the mechanism by which they might be brought under social management. The great companies are no longer conducted by the owners of the capital as such, but by a paid staff of officials under a manager; and the whole organisation could without shock be transferred to the direct service of the community.

It will be clear that socialism is a question for the future. Only the future can disclose how far and how soon any system of free associated workers can supersede the prevalent system of competitive industry served by wage-labour. And, as we indicated at the outset, the drift of opinion about socialism will largely depend simply on the meaning which prevalent use and wont give to the word.

Relation of Socialism to Darwinism.—Many students of socialism find a difficulty in understanding its relation to the Darwinian theory, according to which development depends on the struggle for existence, resulting in the survival of the fittest. Reasonable socialists must admit that such a struggle is a prime fact in the history of human society, and that it is a cardinal principle of human progress that the competitive system is only a modern form of the struggle for existence, and is therefore a necessary stage in the progress of mankind. On the other hand, it is enough to point out that the struggle for existence is only one side of human evolution. Another side not less important is seen in the development of the principle of association or community, in the continual effort to moralise the struggle, to place it under the regulation of rational, ethical, and artistic ends and ideals. In short, the moral and social progress of the world has largely consisted in mitigating, limiting, and regulating the struggle for existence. The struggle for existence, however, is not thereby abolished. It is only carried forward to a higher plane. The development of the social principle or principle of association is itself a potent element in the struggle; for the struggle is not one between individuals merely; it is waged also between communities, which on the whole are continually progressing, and an improvement in social organisation may be decisive of the result. In the great struggle for existence which is always proceeding between the nations of Europe a large advance, for example, in the education and social condition of the people of one nation may more than any other factor turn the scales in its favour. The family virtues—good faith, justice, and humanity—have always been powerful elements in the development of society. They are all phases of the moral and social progress of the world. Socialism claims to have brought forward a type of industrial organisation which can best continue and promote the ethical and social progress of mankind. The competitive system is the latest form of the struggle for existence, and socialism is the latest theory for its regulation.

See the articles COMMUNISM, CO-OPERATION, EVOLUTION, FRIENDLY SOCIETIES, GEORGE (HENRY), INTERNATIONAL, KNIGHTS OF LABOUR, LASSALLE, MARX, NIHILISM, PEASANT PROPRIETORSHIP, PROFIT-SHARING, TRADE-UNIONS, &c. Marx, *Kapital*, of which two vols. have appeared (the first in an Eng. trans.), remains the classic work on socialism; see also *Eugen Dühring's Umwälzung der Wissenschaft*, by Marx's friend Fr. Engels; A. Schäffle, *Quintessenz des Socialismus, Bau und Leben des sozialen Körpers* (vol. iii.), and *The Impossibility of Social Democracy* (Eng. trans. 1892); Franz Mehring, *Die Deutsche Socialdemokratie*; Rudolf Meyer, *Der Emancipationskampf des vierten Standes*; Laveleye, *Le Socialisme Contemporain* (Eng. trans.); *Les Procès Anarchistes* (Lyons, 1883); John Rae, *Contemporary Socialism* (new ed. 1891); *Fabian Essays in Socialism*; Hyndman, *Historical Basis of Socialism in England*; Ed. Bellamy, *Looking Backward*; W. Morris, *News from Nowhere*; Graham, *Socialism New and Old* (2d ed. 1892); *An Inquiry into Socialism* (1887), and *A History of Socialism* (1892) by the present writer; books by Gilman (1892), W. Morris and Belfort Bax (1893), Ely (1894), Flint (1895); Göhre, *Six Months in a Workshop* (trans. 1895); Nitti, *Catholic Socialism* (trans. 1895); Stammhammer's *Bibliographie des Socialismus und Communismus* (1893); and the relevant chapters in the economic works of Roscher, Wagner, Mill, and Sidgwick.

Societies are associations for some particular object, such as the promotion of science, art, and literature; the diffusion of knowledge, religion, and morality; intercourse between those of the same profession or trade; the removal of legal grievances; mutual aid in case of distress; and an abundance of other aims, which are either beneficial to the general public or to the members of the society alone. The great scientific, literary, and art associations are many of them separately treated in this work (see ROYAL SOCIETY, ROYAL ACADEMY, &c.). So are many special institutions like the Humane Society (q.v.), the S.P.C.K. (see CHRISTIAN KNOWLEDGE). Others are dealt with in the articles on the subjects with which they concern themselves (LIFEBOAT, TEMPERANCE, BROWNING, &c.). In Britain the term academy is usually reserved for art associations; but on the Continent the great national literary and scientific organisations are usually styled academies, and are treated at the article ACADEMY. So with many American learned associations. See also MISSIONS, BOOK-CLUB, and SECRET SOCIETIES.

The following is a list of the best-known British societies, associations, and institutions in order of date, fuller information as to which may be sought in the *Year-book of the Scientific and Learned Societies of Great Britain and Ireland* (published annually since 1884). It should be noted that in some cases the society arose out of a minor and older organisation; was itself founded under a somewhat different name; or received its charter of incorporation years after its foundation.

Royal Society (London).....1660	Statistical.....1834
Royal Dublin Society.....1684	Numismatic.....1836
Christian Knowledge.....1698	Ornithological.....1837
Society of Antiquaries.....1707	Royal Agricultural.....1838
Society of Dilettanti.....1734	Royal Microscopical.....1839
Society of Arts.....1753	Royal Botanical.....1839
Manchester Lit. and Phil.....1781	Irish Archeological.....1840
Royal Soc. of Edinburgh.....1783	Chemical.....1841
Highland and Agricultural.....1784	Pharmaceutical.....1841
Royal Irish Academy.....1786	Philological.....1842
Soc. of Antiquaries of Scotl.....1780	Ethnological.....1843
Linnean.....1788	Brit. Archeological Assoc.....1843
Royal Institution.....1799	Royal Archæol. Institute.....1843
Royal Horticultural.....1804	Sydenham.....1843
Royal Med. & Chirurgical.....1805	Ray.....1844
London Institution.....1806	Royal Meteorological.....1850
Geological.....1807	Photographic.....1852
Peace.....1816	Anthropological.....1863
Inst. of Civil Engineers.....1818	London Mathematical.....1865
Hunterian.....1819	Palestine Explor. Fund.....1865
Royal Astronomical.....1820	Royal Historical.....1868
Royal Soc. of Literature.....1823	Christian Evidence.....1871
Royal Asiatic.....1823	Anthropological Institute.....1871
Zoological.....1826	Paleogeographical.....1873
Diffusion of Useful Knowl.....1827	English Dialect.....1873
Royal Geographical.....1830	(New) Shakspeare.....1873
Harveian.....1831	Folklore.....1873
United Service Institution.....1831	Egypt Exploration Fund.....1881
British Association.....1831	Psychical Research.....1882
British Medical Assoc.....1852	Royal Scot. Geographical.....1884

Of American learned associations, whether calling themselves Academy (q.v.) or not, the following are among the more important of several thousand.

American Philosophical Society.....1743
American Academy of Arts and Sciences, Boston.....1780
Connecticut Academy of Arts and Sciences.....1799
New York Historical Society.....1804
Academy of Natural Sciences, Philadelphia.....1812
New York Academy of Sciences.....1818
Boston Society of Natural History.....1830
Smithsonian Institution.....1846
American Association for the Advancement of Science.....1847
American Geographical Society.....1852
National Academy.....1863
Social Science Association.....1865
Numismatic and Archeological Society.....1865
American Folklore Society.....1888

Society Islands. See TAHITI.

Socinus, the name of two celebrated heresiarchs, uncle and nephew, who have given name to a sect of Christians, the Socinians, whose doctrines, though

by no means identical, are to a large extent those of the modern Unitarians.—**LÆLIUS SOCINUS**, or **LELIO SOZZINI**, was born in 1525 at Sienna in Tuscany, of a family long distinguished for its cultivation of literature and science. His father, Marianus Socinus, was an able lawyer, and designed his son for the same profession. But Lælius soon displayed a strong preference for theological inquiry, and in order to better prosecute his biblical studies he made himself familiar with Greek, Hebrew, and Arabic. The only result of his legal training that one can discern is an obstinate aversion to believe anything 'unreasonable.' The principles of the Reformation had slowly found their way into Italy, and in 1546 a secret society of forty distinguished men was formed at Vicenza for the discussion of religious questions. The conclusions at which they arrived were unfavourable to the dogma of the Trinity, which they held to have been borrowed by the early church from the speculations of Greek philosophers. The purpose of their meetings together having been discovered, the society broke up. Some of the members were arrested and put to death, others sought safety in flight. Among the latter was Socinus, who travelled in France, England, Holland, Germany, and Poland, making the acquaintance, and acquiring the esteem, of many transalpine scholars, and finally settled in Zurich, where he died in 1562, when only thirty-seven years of age. Lælius Socinus, unlike most heretics, was a modest and reticent man. He united in altogether unexampled degree the warmest piety with complete freedom in theological speculation.—See Ilgen's *Vita Lælii Socini* (Leip. 1814), and *Synbolæ ad Vitam et Doctrinam Lælii Socini* (Leip. 1826).

FAUSTUS SOCINUS, or **FAUSTO SOZZINI**, nephew of the preceding, was born at Sienna, 5th December 1539. He lost his parents while still young, hence his education was neglected; but this rather helped than hindered him to become a heretic before he was out of his teens. At twenty-two he repaired to Lyons, where he was when he got news of his uncle's death. He immediately proceeded to Zurich to take charge of his papers, next entered the service of the Grand-duke of Tuscany's sister, and during twelve years seemed to forget, amid the cares of office and the dissipations of society, the thorny questions of theology. In 1575 he retired to Basel, to prosecute his studies more closely, and in November 1578 he set out for Klausenburgh, at the request of George Blandrata, whence next year he went to Poland. Anti-Trinitarianism was even stronger here than in Transylvania, and Socinus soon obtained great influence. He preached and disputed and wrote with a zeal that his successors never displayed. His position in relation to the Reformers was that Luther and Calvin had rendered great services to the cause of religion, but that they had not gone far enough, that the only solid basis on which Protestantism could rest was human reason, that everything that contradicted it should be rejected as false and incredible, and that dogmas that were absurd should not be allowed to shelter themselves from criticism because their defenders chose to call them mysteries. The Protestants were alarmed, and the ablest among them undertook publicly to confute Socinus. A disputation was held in the college of Posna, which ended in Socinus reducing all his opponents to silence; but they retaliated after the unscrupulous fashion of the times by trumping up against their vanquisher a charge of sedition, which, although ridiculously groundless, made it necessary for Socinus to withdraw from Cracow. While living in retirement on the estate of a Polish noble, Christopher Morsztyn, he married the daughter of his protector. She seems to have been a tender

and affectionate wife; and when Socinus lost her in 1587 he almost broke his heart through grief. About this period his property in Italy was confiscated; but he had powerful and wealthy friends in Poland, who proved generous to him in his needs. In 1588 he took part in the synod of Brest (on the borders of Lithuania), and combated all the principal dogmas of the church—the divinity of Christ, propitiatory sacrifice, original sin, human depravity, the doctrine of necessity, and justification by faith. In 1598, on the publication of his *De Jesu Christo Servatore*, his enemies stirred up the populace of Cracow against him; and Socinus was torn from a sick-bed and nearly murdered. Soon after he left the city and found a refuge with one of his friends in the village of Luclawice, where he died, 3d March 1604. The works are no longer read; but his opinions have never wanted advocates in any Protestant country. He and his uncle may be regarded as precursors of that spirit of Rationalism which has rooted itself so deeply in the thought of the modern world.

See Przyrkowski's *Life*, prefixed to a collection of the works of Socinus in the *Bib. Frat. Polonorum* (Amst. 1636; Eng. trans. 1653); Bayle's article in the *Dictionnaire*; Toulmin's *Memoirs* (Lond. 1777); a *Life* by Wallace (1850). See also Fock, *Der Socinianismus* (1847), and the article UNITARIANS.

Sociology, a hybrid word brought into currency by Comte with the meaning of 'social politics,' deals with man as a social being (Aristotle's *zōon politikon*), and so has for its subject the origin, organisation, and development of human society and human culture, especially on the side of social and political institutions. The field of Anthropology (q.v.) is usually restricted to the discussion of the earlier stages of social development and survivals from that stage into the present. Speculation on the subjects included in the wide field of sociology is as old as literature; and the names of Plato, Aristotle, Hobbes, Vico, Herder occur as prominent amongst those who have dealt with its problems. But it was Comte who may be said to have made the first serious attempt to make sociology a science, and a sketch of his views will be found at POSITIVISM. The methods of modern sociology are, however, especially identified with the work of Herbert Spencer, who makes the science a series of generalisations on the correspondences and contrasts between individual organisms and communities or societies as social organisms, with their structures and functions, their periods of growth and decay. The forms of government—civil, ecclesiastical, military, industrial, ceremonial—are the structures of communities; sentiments, ideas, industrial processes, fine arts may be regarded as functions. See the article SPENCER, and his *Principles of Sociology*; ANTHROPOLOGY, CRIMINOLOGY, EVOLUTION, FAMILY, FEUDALISM, GOVERNMENT, MARRIAGE, POLITICAL ECONOMY, POLITICS, POOR-LAWS, PRISONS, SOCIALISM, WOMEN'S RIGHTS, and the works cited under these heads.

The name of SOCIAL SCIENCE has in Britain been specially given to the study of all that relates to the social improvement of the community. A society, called 'The National Association for the Promotion of Social Science,' was organised at a meeting held under Lord Brougham's auspices in July 1857, to consider the best means of uniting together all those interested in social improvement; and till 1884 held annual congresses in large towns throughout the United Kingdom. At the last congress the Association comprised five sections—(1) Jurisprudence and Amendment of the Law (sub-section, Repression of Crime); (2) Education; (3) Health; (4) Economy and Trade; (5) Art.

Socotra, an island in the Indian Ocean, 150 miles E. by N. from Cape Guardafui, and 220 from the southern coast of Arabia. Seventy miles long by twenty broad, it has an area of 1380 sq. m. The interior embraces numerous barren plateaus (1500 to 2000 feet), with several well-wooded mountains, rising to 4500 feet; there are fertile valleys between the ranges and belts of rich soil along the coasts. The climate is moist and warm, but healthy. Aloes and dragon's blood are the chief commercial products. The inhabitants, about 10,000 in all, live on dates and the produce of their sheep, goats, and cows. They belong to two distinct types—one with a comparatively light-coloured skin and straight hair, the other darker with curly hair. But all alike speak the same peculiar language, which has certain affinities with the South Arabian dialect of Mahra. The people show traces of intermixture with Negro, Arab, and Indian tribes; and in ancient times the inhabitants of Socotra were believed to have been acquainted with Greek civilisation and later to have been Nestorian Christians. From the 16th century at least they owed some sort of allegiance to the sultan of Keshin on the Arabian coast. After being occupied by Britain in 1835-39, the island was taken under British protection in 1876 and formally annexed in 1886. The chief town is Tamarida on the north coast. The Royal Society and the British Association sent out in 1880 a commission of scientific men to investigate the botany and zoology of the island; and a German expedition followed them the year after.

See Yule's *Marco Polo* (vol. ii.), Bent in *Nineteenth Century* (June 1897), and the *Royal Scottish Geographical Magazine* for December 1898.

Socrates, the Athenian philosopher, was the son of Sophroniscus, a sculptor, and Phanaretē, a midwife. As he was at least seventy years old at his death, he cannot have been born later than 469 B.C. He is said, though only by late writers, to have followed his father's profession for a time; and, in the days of the traveller Pausanias (about 160 A.D.), a statue of the Graces, standing at the entrance to the Acropolis, was ascribed to him—with what amount of truth it is impossible to say. He received the usual education of an Athenian youth, and learned also geometry and astronomy. He was acquainted with the philosophy of Anaxagoras (q.v.), probably only through reading his books, and with other speculations about the physical universe. But he came to consider such inquiries fruitless and disappointing. 'To know one's self' was a more pressing task than to know about nature. The most important influence on his mental development was his intercourse with the various Sophists (q.v.) who frequented Athens. Plato (*Meno* 96 D) makes him speak as if he had been a pupil of Prodicus; but he was in no sense a disciple of that sophist. Though in Xenophon's *Memorabilia* (ii. 1) he reproduces Prodicus' moral tale of 'The Choice of Hercules' with approval, he apologises, with obvious irony, for not adorning it with the fine language employed by the sophist, who, we know from Plato's *Protagoras*, was fond of pedantic verbal distinctions. With the other famous sophists of the time (Protagoras, Gorgias, Hippias, &c.) Socrates stood only in the relation of a controversial disputant, though it is clear from the caricature of him by Aristophanes in the *Clouds* (423 B.C.) that ordinary Athenian opinion regarded Socrates as a typical sophist. It may be noted also that Aristophanes, following the vulgar conception of a philosopher, represents his sophist Socrates as engaged in physical researches, though many of the sophists, like Socrates himself, occupied themselves not with nature but with

questions of direct practical human interest. Socrates, in bringing down philosophy from heaven to the common life of men (as Cicero puts it), was only carrying out in a conspicuous and earnest way one of the new intellectual tendencies of his age. Socrates, we might say, was the greatest of the sophists, and therefore more than a sophist. Euripides, the poet of the new ideas, is said to have been intimate with Socrates; and the comic poets alleged that Socrates helped him with his tragedies. Whether Socrates really met Parmenides (q.v.), as represented by Plato, we have no means of saying.

Socrates took part in three campaigns: he served at Potidæa between 432 and 429, at Delium in 424, and at Amphipolis in 422. His bravery, his extraordinary physical vigour and indifference to fatigue, or cold, or heat, became known to his comrades during these campaigns. He was a good citizen, obedient on principle to the laws of his city; and he did not hesitate to face the anger of the people or of tyrants when duty required. The only political office he ever held was when in 406 he was one of the senate of Five Hundred, and then, whilst he was one of the presiding tribe, he alone refused, at great personal risk, to put to the vote the illegal proposal to try in a body (instead of individually) the generals who had deserted the disabled vessels and left the dead unburied at Arginusæ. And, again, during the usurpation of 'The Thirty' he dared to disobey an illegal order. He held aloof from politics, restrained by what he believed to be a divine warning, and considering that he had received a call to the pursuit of philosophy and could serve his country best in that way. Socrates wrote no books. He set up no regular school of philosophy. He simply lived constantly in public, frequenting the gymnasias and the market-place. He did not care to go outside the city walls; 'the trees had nothing to teach him' (as he says in Plato's *Phædrus*). It was from men and about men, men of all sorts and conditions, that he desired to learn, wiser than others only in being conscious of his own ignorance. It was in this sense that he interpreted the Delphic oracle, which had said that no one was wiser than Socrates. Out of his wide circle of acquaintances some came to be attached to him more closely by ties of affection and admiration; yet there was no formal bond of discipleship. We should rather speak of the young friends or the companions than of the disciples of Socrates. From two of these, Xenophon and Plato, we learn all we can know with certainty about his strange personality and his way of thinking. Yet there is this difficulty, that, while Plato often makes Socrates the mouth-piece of ideas that were in all probability not held by him, Xenophon, a soldier and by no means a philosopher, makes Socrates a very much more commonplace person than he must have been. And it must be remembered that Xenophon wrote expressly to justify Socrates to the average Athenian. If we were dependent on Xenophon alone, it would be unintelligible how Socrates could have been the initiator of a great movement in philosophy, and how the Athenians could have been suspicious of so safe and conservative a moralist. Though Plato is apparently not bound by any rigid considerations of historical accuracy in his dialogues, we may yet accept the picture he gives us of the habits and conversation of Socrates as a true portrait—a portrait painted by a great imaginative artist. Aristotle, though of course he could only know about Socrates through Plato and others, sometimes supplies us with a valuable test to discriminate the genuinely Socratic from the purely Platonic elements in the dialogues. Xenophon becomes a useful authority

when read in the light of what we know from Plato. Many sayings of Socrates convey profounder meanings to the readers of Plato than they probably did to Xenophon himself. Where Xenophon sees only a prudential maxim, Plato finds the germ of a philosophical principle.

In personal appearance Socrates was odd and even ugly, conspicuously so among a handsome race. He had a flat nose, thick lips, prominent eyes. Alcibiades (in Plato's *Symposium*) compares him to a figure of Silenus. His robust constitution has already been referred to. He always went barefooted, even during a Thracian winter, and wore the same homely clothing all the year round. He was indifferent to luxury and even to ordinary comfort; but he was by no means an ascetic. Habitually abstemious and simple, and possessing perfect control over all his appetites, he could at a banquet drink more than any one else without being overcome. He delighted in the society of youths, especially if they had fair minds in fair bodies. From a modern point of view, he might seem to pay too little regard to the duties of family life. But we must remember that, though above his age in many ways, he was still of it, an Athenian living almost entirely in a society of men. The well-known gossip about his wife Xanthippe comes to us mostly from late sources. Xenophon only tells us that she had a shrewish temper, which Socrates bore patiently, admonishing his eldest son Lamprocles of the duty of gratitude to his mother (*Mem.* ii. 2). It is easy to believe that a man who had a mission, who was willingly poor, and lived very much in public may have been a trying husband, even to an Athenian wife.

There has been much discussion about the 'divine sign' (*daimonion*) of which Socrates used to speak as a supernatural voice which guided him every now and then, according to Xenophon telling him to act or not to act, according to Plato only restraining him from action, never instigating. Later writers, especially in Christian times, speak of it as a daemon, genius, or attendant spirit. For this there is no authority whatever in Plato and Xenophon. On the other hand, we cannot, with some modern writers, identify it with the voice of conscience. Socrates speaks of it as a peculiarity of his own, and it had not to do with the moral quality of actions in general: it was an occasional inward oracle about the future. Socrates, not disbelieving in oracles and divinations (though very likely laying less stress on them than the pious Xenophon would have us suppose), seems to have had certain vivid presentiments which he took for special divine monitions; and it is possible, as has been suggested, that he was subject to occasional hallucinations of hearing, such as may occur even in quite sane and healthy persons. Socrates was eccentric in some ways, and we know that he occasionally became so absorbed in meditation as to become insensible of the outer world. Alcibiades (Plato, *Symp.* 220) relates that Socrates once stood still for twenty-four hours continuously, entranced in thought. It has also been suggested that in some of his allusions to the divine sign there is a trace of irony, and that he may be indirectly satirising the prevalent belief in divination, claiming to have an oracle of his own.

In any case the average Athenian thought there was something blasphemous in the attitude of Socrates to religion. He was charged in 399, under the restored democracy, (1) with neglecting the gods of the state and introducing new divinities (*daimonia*), and (2) with corrupting the morals of the young. These were very much the same charges which had been made against him as the typical sophist by Aristophanes twenty-four years before. They were now made the subject of a

legal prosecution by Melétus, Anytus, and Lyco. The Athenian people, though generally tolerant, were liable to outbursts of fanaticism; and it must be remembered that the religion of a Greek state was an integral part of its social and political institutions. Furthermore, among the companions of Socrates had been several of the leading men in the oligarchical faction, such as Critias, Charmides, &c.; and he had also been associated with Alcibiades, who had done so much injury to Athens. A mixture of democratic indignation with that bigoted religious and moral conservatism which is not incompatible with democracy must account for the prosecution and its issues. Plato's *Apology* probably gives the substance of the actual defence made by Socrates—a bold vindication of his whole life, and not such as would be likely to conciliate an Athenian popular jury. Yet the vote of condemnation was carried only by a very small majority (six out of, probably, 500). The punishment had still to be decided on. Socrates himself declared that, if he were treated as his life deserved, he should be maintained at the public expense in the Prytaneum. But at length, yielding to the pressure of his friends, who were trying to save him, he agreed to pay a fine of thirty minæ (i.e. about £120), for which his friends undertook to be his sureties. Provoked by what doubtless seemed to them obstinacy and insolence in the old man, the judges voted the penalty of 'death,' which Melétus had proposed in the indictment: according to Diogenes Laertius (q.v.), this was carried by eighty more votes than the original condemnation. The execution of the sentence was delayed for thirty days because of a sacred embassy to Delos. His friends, who had free access to him, planned his escape from prison; but he refused to break the laws of the state. His last day was spent with his friends, as described in Plato's *Phædo*; and in the evening he drank the hemlock. 'Such was the end,' Plato makes Phædo say, 'of our friend, whom I may truly call the wisest and justest and best of all the men whom I have ever known.' Later writers tell how the Athenians repented and punished his accusers; but there is no evidence for this in the writers of the 4th century B.C.

The life and philosophy of Socrates are inseparably connected. Yet he must not be thought of as simply a good man who tried to influence others for good. He sought to base conduct on knowledge. He went about convincing men not so much of sin as of ignorance. What is called the 'irony' of Socrates is his manner of affecting ignorance in the presence of the seeming wise, in order to draw from them an admission of the confusions and contradictions resulting from their opinions. But his conclusion was not mere scepticism or despair of knowledge. He claimed to follow, in the intellectual sphere, his mother's profession, and to help those in labour with new ideas to bring them to the birth: this is his 'maieutic,' i.e. obstetric art. For this reason he always adopted the method of question and answer—the 'dialectic' method in its literal sense. Aristotle (*Met.* xiii. 4) says that Socrates introduced the method of *induction* and the search for *general definitions*. This is a somewhat technical and formal description of the manner and aim of the conversations of Socrates. The Socratic 'induction' consists in going to particular instances. Socrates was laughed at for the homeliness of his illustrations: he was always talking about carpenters and weavers and shoemakers.

Ethics was the only part of philosophy with which Socrates cared to occupy himself, and in ethics his main doctrine may be summed up in the formula 'Virtue is knowledge; vice is ignorance.' (Bentham's saying, 'Vice is miscalculation,' is a

somewhat mean-looking version of this.) It follows from this fundamental principle that virtue is one, the excellence of each good quality just consisting in the *knowing* what ought or ought not to be done. It follows also that no one can know (in the truest sense) what is right and yet do what is wrong. In Xenophon we do not find Socrates maintaining any of these opinions in quite so explicit and paradoxical a form. In Plato they are carried out to their logical consequences (see PLATO). We find, e.g., that Xenophon makes Socrates say that rulers should be those who *know* the art of ruling. This sounds commonplace enough. But we cannot say that Socrates did not go on to propound Plato's paradox that the perfect state would therefore be one in which the rulers were philosophers.

Xenophon represents Socrates as using the argument from design to prove the existence of the gods. But we cannot say with certainty how far his opinions about the gods differed from those of the popular religion. We may fairly suppose that they approached more nearly to those of Plato than to those of the average Athenian. On the other hand, from the language of Plato's *Apology*, it seems pretty clear that Socrates did not hold the definite views about the immortality of the soul which are maintained in the *Phaedo*, but left the question of a future life quite uncertain.

Socrates founded no special school of philosophy, but gave their starting-point to several distinct schools. Euclides of Megara (not to be confounded with the great mathematician of Alexandria who lived a century later) took up the Socratic dialectic as his main object of study, and, combining Socratic with Eleatic influences, became the founder of the Megaric or 'Eristic' (i.e. disputatious) school. On the other hand, Antisthenes (q.v.) the 'Cynic,' who taught that virtue was the sole end of life, and Aristippus (q.v.) of Cyrene, who taught that pleasure was the end, neglected the intellectual and logical aspects of the Socratic teaching and took a narrowly practical view of the object of philosophy, each maintaining an opposite extreme in his view of goodness. These are often called the 'one-sided' or imperfect Socratics. Plato alone inherited his master's spirit in its fullness.

The part of Zeller's *History of Greek Philosophy* dealing with Socrates is published separately in the English translation. The materials for the life and teaching of Socrates are Xenophon's *Memorabilia* and *Symposium* (the *Apology* ascribed to Xenophon is probably spurious), and Plato, *Apology* (most strictly historical of his writings), *Crito*, the narrative parts of the *Phaedo*, *Symposium*. For further references, see XENOPHON, PLATO; see also article on 'the daemon of Socrates,' by H. Jackson, in *Journal of Philology*, vol. v.

Socrates, a church historian, born and brought up at Constantinople about the end of the 4th century A.D. Little is known of his life save that he followed the profession of an advocate. His *Eccleniatikē Historia* covers the period from 306 to 439, and was most probably written about 440. As history its chief value lies in its transparent honesty, for the writer's grasp of the subject was feeble and his knowledge small. He borrowed from Eusebius, Rufinus, Athanasius, besides eyewitness and oral tradition, mainly from the members of the Novatian party at Constantinople. He had a profound reverence for Origen, and a high regard for Greek culture; and while he himself maintains an easy orthodoxy, he is indifferent to dogmatic definitions and tolerant of erroneous opinion when not noisy. Editions are by Hussey (1853) and W. Bright, with Introduction (1878); there is an English translation in Bohn's Library (1851), another by Professor A. C. Zenos in Schaff's 'Select Library of Nicene and Post-Nicene Fathers' (2d series, vol. ii., New York, 1891).

Soda. In its widest sense the manufacture of soda embraces a chain of operations which includes the making of Sulphuric Acid (q.v.), sulphate of soda, Hydrochloric Acid (q.v.), Bleaching Powder (q.v.), caustic-soda, soda-ash (alkali), and crystals of soda (washing-soda). From some of these processes valuable by-products are also obtained, such as iron, copper, and even silver from the pyrites, after the latter is burned to yield the sulphur required to make the sulphuric acid. This sulphur is now recovered on a very large scale from exhausted black-ash by Chance's process.

Copyright 1892, 1897, and 1900 in the U. S. by J. B. Lippincott Company.

Formerly most of the soda of commerce was extracted along with other products from the ashes of certain seashore plants (see BARILLA, and KELP). Natural carbonates of soda (sodium carbonates) are found in different parts of the world, and in some places are worked for use. See SODIUM. The quantity of soda obtained from all other sources is, however, now quite insignificant in comparison with that produced by the decomposition of common salt (chloride of sodium), either by Leblanc's process, or by the comparatively recent Ammonia-soda process. This manufacture, which is conducted on a gigantic scale, is the chief among British chemical industries. Cryolite (q.v.), a Greenland mineral, is used in the United States as a source of soda, and of its bicarbonate.

Leblanc's process was first made known to the world by a commission of the French republic in 1794, although dating some years earlier. It has been one of the most valuable discoveries in the entire range of chemical manufactures, and has been practised for a century without any important alteration. The author of this invention reaped no benefit from it himself, but spent the last of his days in an hospital, 'a wreck in fortune, health, and hope.' Owing partly to the war between France and England, and partly also to the existence of a duty of £30 per ton on common salt, which continued for eight years after the close of the war, Leblanc's process was not adopted in Great Britain except on a very limited scale till 1823. After the repeal of the tax in that year Mr James Muspratt erected his celebrated works at Liverpool, adopted the process in its entirety, and succeeded, after overcoming many difficulties, in establishing this great industry in Great Britain. The object of the process is (1) to convert common salt by the action of sulphuric acid into sulphate of soda (sodium sulphate); (2) to reduce this sulphate to the sulphide of sodium by the abstraction of oxygen; and (3) by certain reactions, in which carbonate of lime (calcium carbonate) takes part, to produce either carbonate of soda (sodium carbonate) or caustic-soda. The several stages are as follows.

Production of Salt-cake or Sulphate of Soda (Sodium Sulphate).—The decomposition of common salt is effected by treating it with sulphuric acid, which converts it into sulphate of soda and hydrochloric acid, thus:

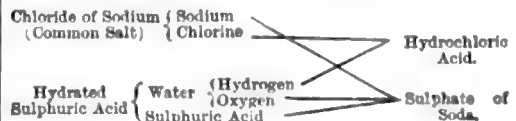

The reaction is represented by the equation



This operation was long conducted in a reverberatory furnace, which allowed the gaseous hydrochloric acid produced to escape into the air, to the destruction of all vegetation in the neighbourhood. Fig. 1 will serve as a diagram to explain the nature of the salt-cake furnace, called

a *blind-roaster* or *muffle-furnace*, for making salt-cake. A is the iron pan in which the charge of common salt and sulphuric acid is first placed, and B is the muffle in which the calcination of the half-finished sulphate is completed, the charge being raked from A into B. The fire (C) heating

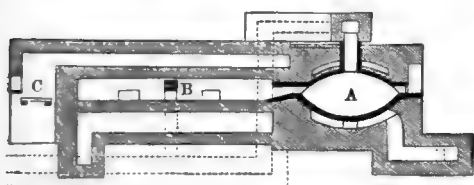

Fig. 1.—Vertical Section of Furnace for making Sulphate of Soda.

the muffle is so placed that the fire gases do not get inside, but heat it by external flues. Usually the pan is heated by a separate fire, but in some instances by the waste heat from the muffle fire. The gaseous hydrochloric acid evolved during the time the reaction between the salt and the sulphuric acid is going on in the pan is sometimes led away to a separate condenser; but if a comparatively pure acid is not required then the gases from both pan and muffle go into the same condenser.

In the case of the *open roaster*, an older kind still used, there is a direct opening from the fire into the bed of the furnace, which is then of an ordinary reverberatory type (see COPPER, fig. 1, and LEAD, fig. 1), with the pan placed at the end as in the blind-roaster; but in this case the pan has always a separate fire. Coke is generally used for fuel in the open roaster, and with it the pan gas is usually separately condensed. Each of these kinds of furnaces has its advantages and disadvantages. The usual charge for open roasters is about 9 cwt. of common salt, and for close roasters one-half more. With the equivalent quantity of sulphuric acid 100 parts by weight of pure chloride of sodium would theoretically yield 121.45 parts of sulphate of soda, but in practice only about 110 are obtained, owing to the presence of moisture in the common salt. The specific gravity of the sulphuric acid employed varies from 1.700 to 1.720.

Rotating furnaces for making sulphate of soda have been introduced in recent years, the one patented in 1875 by Jones and Walsh being the first which came into actual operation. It has since been improved by the patentees and others, and is now in use at several large alkali-works. Fig. 2 is a diagram of this furnace. It consists of a rotating iron pan, 16 feet and upwards in diameter, placed in a chamber arched over with firebrick. From the fireplace at one side the fire gases pass over the surface of the charge to the flue at the other side. The salt is admitted by hopper closed by a balanced cone, and there are lead-pipes for admitting the sulphuric acid at the edge of the pan. Fixed stirrers or ploughs are used for turning over the charge, which, in the largest sized pans, is now sometimes as much as 25 tons of common salt, and this with 20 tons of sulphuric acid gives 27 tons of sulphate of soda every twelve hours. Gas from a producer is sometimes used to heat the furnace, and a self-acting method of emptying the pan was patented by the inventors in 1880. There is a great saving of manual labour by the use of

this furnace. Sulphate of soda, although chiefly consumed as an intermediate product in alkali-making, is used by itself in glass-making, in the manufacture of ultramarine, for cold-producing mixtures, and for making various chemicals.

From any of these salt-cake furnaces the hydrochloric acid gas is led away by pipes or flues to condensing towers sometimes 100 feet high, and filled with pieces of coke. The acid vapour enters at the bottom of the tower, and in ascending through the piled coke meets with a descending stream of water from the cistern on the top by which it is absorbed, and flows away as liquid acid through a pipe at the base of the tower to stock-cisterns. Strong hydrochloric acid, which is chiefly used in the manufacture of Bleaching Powder (q.v.), is easily obtained by good condensing appliances either from the rotatory pan furnace or from the pan of a stationary furnace, but the acid from the roaster gas is usually weak. The Alkali Acts of 1863 and 1874 make the condensation of nearly the whole of the gaseous hydrochloric acid produced at soda-works imperative.

Conversion of the Sulphate of Soda into Black-ash.—The sulphate of soda is roasted with coal

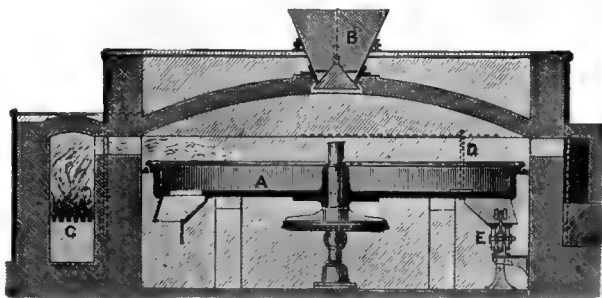

Fig. 2.—Rotating Furnace for making Sulphate of Soda :

A, iron pan for containing charge; B, hopper, with balanced cone for charging; C, fireplace; D, one of the stirrers; E, self-acting arrangement for discharging pan.

and limestone to produce crude carbonate of soda. In this operation the oxygen of the sulphate combines with carbon furnished by the coal to form carbonic oxide, which escapes into the air. The remaining sodium sulphide interchanges combinations with the carbonate of lime (limestone), forming carbonate of soda, easily soluble in water, and calcium sulphide, which is insoluble. The action of the carbon in reducing the sulphate of soda to the sulphide is shown by the equation



The further change which occurs is thus represented :



The proportions of the materials as now used are the same as those first recommended by Leblanc—viz. sulphate of soda, 100 parts; carbonate of lime (limestone), 100 parts; carbon (charcoal), 55 parts. But as coal is employed in England instead of charcoal, the quantity used is generally 75 to 100 of each of the other two ingredients. The 'balling furnace' used in this operation is shown in fig. 3. It has two beds, the one being raised a few inches above the other. F is the fireplace, the waste heat from which is usually employed in boiling down the tank liquor or soda-lye as indicated in the section. The charge of about 8 cwt. of the above mixture is thrown into the bed, A, of the balling furnace, after it has been raised to a bright red heat, and

remains till it becomes sufficiently heated throughout the whole mass. It is then transferred to the *fusing bed*, B, which is next the fire, and exposed to a higher heat, when it shortly begins to soften and flux into a mass like dough. In about fifty minutes the charge is withdrawn in a red-hot state by the working door, and received into iron barrows,



Fig. 3.—Section of Balling Furnace, showing an evaporating pan, P, P, for Soda-liquor in connection with it.

where it solidifies into blocks of crude soda, termed ball soda or black-ash.

Black-ash is now extensively made in a revolving furnace, which does away with the arduous manual labour required in a stationary furnace, and which was first patented in 1853, though many difficulties had to be overcome before it became a success. Mr J. C. Stevenson, of the Jarrow Chemical Works, after much labour succeeded about 1870 in establishing its superiority over the older kinds of balling furnaces. A longitudinal section of this furnace is shown in fig. 4. It is either cylindrical or barrel-shaped, about 18 feet long and 10 feet in diameter, lined with firebrick. The furnace is driven by steam and the necessary gearing, a spur-wheel being placed round and fixed to the cylinder, which turns on friction rollers. At one end it is

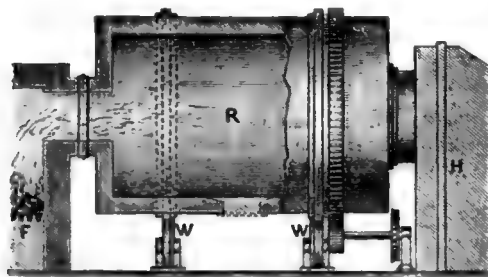

Fig. 4.—Revolving Black-ash Furnace, partly in section: F, fire; R, revolving cylinder; W, friction wheels; H, tanks, &c., for evaporating soda-lye by waste heat of furnace.

furnished with a large fireplace, the fire gases from which pass through the 'barrel,' and onwards to heat the boiling-down pans, which are placed at the opposite end and arranged much in the same way as in the stationary furnace. The larger-sized revolving furnaces produce 30 tons of black-ash in twenty-four hours.

Lixivation of the Black-ash.—The crude soda so named requires to be porous, so that water will easily penetrate the broken lumps of it when placed in iron tanks. Formerly a series, say of four of these, was placed in a step-like arrangement in which the lowest contained the fresh black-ash and the highest that which was nearly exhausted of its soda. Fresh water flowed in at the top, and, as it dissolved out the soda, became gradually stronger in descending from tank to tank, till it reached its full strength in the lowest one. A more recent plan is to have the tanks all on a level and communicating with each other by tubes; but the exhaustion of the black-ash takes place in a similar way. Weak soda liquor is present in the tank with the nearly exhausted ash, and strong

liquor in the one containing fresh black-ash, while the other two have liquors of intermediate but unequal strengths. The level of the liquor differs in each, being highest where weakest and lowest where strongest. When communication is opened between these tanks circulation is caused by hydrostatic pressure. The soda liquor from the black-ash is treated differently, according to whether soda-ash or caustic-soda is to be made from it.

Caustic-soda.—As the tank liquor consists of a strong solution of carbonate of soda, it requires to be diluted before it can be causticised with lime. Long iron cylinders contain this diluted liquor, into which lime is placed, and at the same time it is heated and agitated. After being allowed to settle, the clear liquor is drawn off and pumped into liquor settlers, the lime mud in these being saved and used in the black-ash furnace. Several iron concentrating cisterns are successively used with the aid of heat to bring up by degrees the causticised soda liquor to the required strength. From the last of these cisterns (boat-pans) the liquor, having a specific gravity of 1.550, is run into cast-iron pots, each of a capacity of 10 tons, which are heated by strong fires, and here the concentration of the liquor is completed, and the caustic-soda laddled into sheet-iron 'drums' containing 6 cwt. each. On cooling it solidifies into a white mass of sodium hydrate or caustic-soda, NaOH, which is now manufactured in large quantities, containing as much as 77 per cent. of sodium monoxide, Na₂O. During the concentration nitrate of soda is used to decompose any sodium sulphide present in the liquor. Caustic-soda is most largely used in soap-making and paper-making, but also in the manufacture of some coal-tar dyes and oxalic acid.

Soda-ash.—When this substance (carbonate of soda) and not caustic-soda is to be made, the black-ash liquor is differently treated. In referring to the black-ash furnaces (see figs. 3, 4) it has been stated that their waste heat is used to boil down the black-ash liquor. As the concentration of the liquor proceeds granular crystals of soda are deposited and scraped out into drainers. When heated these crystals yield soda-ash; but impure soda remains in the boiling-down vessel. This soda, which is mostly carbonate but also contains caustic-soda and sodium sulphide, is mixed with some sawdust and evaporated to dryness. The black-salt, as this residual substance is called, is then heated in a carbonating oven in which the burning off of the sawdust generates carbonic acid, and this converts the caustic-soda and sodium sulphide present into carbonate, and soda-ash is the result. The composition of commercial soda-ash is very variable, but it frequently contains about 80 per cent. of the carbonate, the remainder consisting of other compounds of sodium and small quantities of other substances. None of these, however, interfere with its use for the purposes for which it is usually employed. When it is sold the available percentage of soda (sodium oxide or Na₂O) is quoted. For certain purposes soda-ash is refined by dissolving, settling, evaporating, and calcining. It is then called *refined* or *white alkali*, which should be free of caustic-soda and contain no trace of sodium sulphide, sodium sulphite, or of iron.

Crystals of Soda, Washing-soda, Na₂CO₃.10H₂O.—The soda-ash used for making soda-crystals is previously calcined and dissolved in hot water in iron vessels, the solution being then allowed to cool

From this solution large crystals of almost pure carbonate of soda separate. Ordinary washing-soda consists of these crystals, which are of uniform composition and easily dissolved. They contain ten molecules of water—that is to say, they are composed of 37 per cent. of carbonate of soda and 63 per cent. of water. Crystal soda being quite free from caustic-soda and other compounds acting on the skin, the hands of washerwomen suffer less from it than from other kinds of alkali.

Bicarbonate of Soda, 2NaHCO_3 .—As will be presently explained, this salt is now prepared on a large scale as a stage in the ammonia-soda process. See SODIUM.

Sulphur Recovery.—The recovery of sulphur from the exhausted black-ash, which forms the waste heaps of the alkali-maker, is now, after many unsuccessful attempts to do so economically, practised on a large scale by Chance's process patented so recently as 1888. This residue, as has been stated, is essentially calcium sulphide, which when brought into contact with carbonic acid in the presence of water is converted into carbonate of lime, and sulphuretted hydrogen is liberated. The practical difficulty had long been the getting of hydrogen sulphide in a sufficiently concentrated state. Mr Chance's process is as follows: The vat mud (black-ash waste) has the coarser extraneous pieces removed by a sifting process, and is then made into a creamy consistency with water. In this state it is distributed into a series of cylindrical iron vessels for the purpose of having carbonic acid passed through it. These cylinders have three main pipes passing over them, with branches to each. By one pipe the carbonic acid is introduced at the bottom of the liquid, and the other two lead the gases away from the top of the cylinder.

The carbonic acid is produced in a limekiln, and passes, unavoidably mixed with nitrogen, into the cylinders, which successively become richer in sulphur compounds. The result is that for a time little else than nitrogen comes away from the last cylinder. But when the reactions in the cylinders are completed the final vessel of the series gives off gas rich in sulphuretted hydrogen. By means of stopcocks one of the pipes at the top of each cylinder conveys the nearly unmixed nitrogen to an open chimney, and the other takes the rich mixture of nitrogen and sulphuretted hydrogen to a gasholder. When the carbonic acid from the limekiln passes into the first cylinder containing the black-ash waste, carbonate of lime is produced with evolution of sulphuretted hydrogen, H_2S . The latter passes on with the excess of nitrogen into the second cylinder, where there is formed sulphhydrate of calcium, CaH_2S_2 , which is a compound of H_2S and CaS . In this way we have the sulphur concentrating from first to last in the series of cylindrical vessels until it is finally expelled as sulphuretted hydrogen gas. In the process the carbonic acid combines with the calcium of the sulphhydrate, giving off the two atoms of sulphur as H_2S , so that for a given amount of carbonic acid used we get a double quantity of sulphur. All the time the vessels at the beginning of the series remain unsaturated, the nitrogen, amounting to about 70 per cent. of the gases pumped in, passes away in pipes, and is allowed to escape. It contains little or no sulphur; but by-and-by the gas in the vessels consists of from 30 to 35 per cent. of sulphuretted hydrogen and from 1 to 2 per cent. of carbonic acid, the remainder being nitrogen. This mixed gas is collected in a gasholder to enable it to be treated as required. The carbonated mud left in the vessels is drained, and used in place of limestone in the black-ash furnaces, so that any soda this dried mud contains is recovered.

The sulphur is obtained from the gas in the gasholder in a very pure state in cakes and flowers of sulphur by this operation. A definite mixture of the sulphuretted hydrogen (present in this gas) and air is passed through a layer of anhydrous oxide of iron in a Claus kiln, the oxygen present being only enough to unite with the hydrogen (of the H_2S) to form water, the sulphur being set free. Iron oxide has the power of producing the combination without itself suffering change, the bed of this material becoming (without the use of fuel) sufficiently hot, by the chemical change which goes on, to volatilise the sulphur vapour along with the steam produced. The change is represented by the formula $\text{H}_2\text{S} + \text{O} = \text{H}_2\text{O} + \text{S}$. But the sulphuretted hydrogen may also be itself burned to make vitriol, which is obtained of the same purity as when made from sulphur.

The Ammonia-soda process has within the last few years come into competition with and threatens to supersede that of Leblanc. It is based on the mutual reaction which takes place at ordinary temperatures between common salt and bicarbonate of ammonia in strong aqueous solutions. The sodium of the salt combines with the carbonic acid and the chlorine with the ammonia, giving bicarbonate of soda, which is insoluble, and chloride of ammonium, which remains dissolved in the liquid, thus:

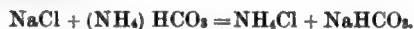

The ammonia is recovered from the chloride and one-half of the carbonic acid from the bicarbonate for future use. Where possible natural brine is used, and this is brought to a specific gravity of nearly 1200, either by the addition of salt if too weak or by adding water if too strong. Ammonia in the free gaseous state is now passed into the brine until the required quantity is present, which is known by the amount of increase in the volume of the liquid. The ammonia enters a mixing tank under a perforated diaphragm, and the liquid is kept in agitation. A great rise of temperature is caused by the condensation of the gaseous ammonia, and this necessitates the running of a stream of water through a coil of piping inside the mixer to keep the heat as low as possible. The brine in running off passes through a filter to retain solid impurities, and then through another worm of piping surrounded by cold water. To form the bicarbonate of soda the ammoniacal brine requires to be saturated with carbonic acid. Air-pumps draw the carbonic acid from the limekiln and force it (after being properly cooled) at a pressure of nearly two atmospheres in at the bottom of a tower 50 feet high, which is kept nearly full of the liquid. This tower has perforated plates at every three feet of height to make sure that the gaseous bubbles are spread equally through the liquid. Every half-hour some of the pasty mixture in the tower is run off at the bottom. This is full of the small crystals of bicarbonate of soda, and these are separated by running the mass over a wire-gauze filter covered by a cloth, a vacuum being maintained below. The bicarbonate of soda on the filter is nearly pure, and the liquid which passes through is ammonium chloride. The bicarbonate thus obtained is washed with water and carefully dried in apparatus of which there are various forms. As there is a comparatively limited demand for this kind of soda, it is afterwards heated in close vessels in which half of its carbonic acid is given off, thereby reducing it to the normal or common carbonate of soda (soda-ash). The gas given off is pumped back to the tower and used along with the kiln gas for carbonating fresh material. To expel any ammoniacal salts adhering to the carbonate of soda and render it denser for packing, the heat is

continued until fusion takes place. The ammonia is recovered from the liquid filtered from the bicarbonate of soda by heating it with lime. After the ammonia is driven off by heat the remaining liquid is calcium chloride, which is generally run to waste.

See Lunge's *Treatise on the Manufacture of Sulphuric Acid and Alkali* (1880); Diagram, with Key of the Leblanc Soda Process, by J. J. Miller, 1891 (for students); *Journal of Chemical Industry* (vol. for 1888), containing a paper by Mr Chance on Sulphur Recovery.

Soda Water. See AERATED WATERS.

Söderhamn, a seaport of Sweden, on a bay of the Gulf of Bothnia, 13 miles N. of Gefle, exports some 250,000 tons of iron and timber (in 600 vessels) annually. It has been frequently burned down, the last time in 1865. Pop. 9044.

Sodium (sym. Na; equiv. 22.29; sp. grav. 0.973) is one of the metals of the alkalis, its oxide being soda. Its properties closely resemble those of the allied metal potassium. It is of a bluish-white colour, is somewhat more volatile than potassium, and further differs from that metal in having a higher fusing-point—about 208° (97° C.), a greater specific gravity, and in not catching fire when dropped in water (unless the water is heated), although, like potassium under similar conditions, it partially decomposes it and liberates hydrogen, and at the same time communicates a strong alkaline reaction to the solution. If, however, a piece of unsized paper is placed on the surface of cold water, and the sodium is placed on the paper, the metal takes fire and burns with a deep yellow flame. Strictly speaking, it is the liberated hydrogen rather than the metal which burns; but a little sodium, volatilised by the heat, burns with the hydrogen. When heated in the air it burns with its characteristic yellow flame, and is converted into soda. When exposed *in vacuo* to a red heat it assumes the form of vapour, and admits of distillation. Like potassium, it must be kept immersed in naphtha, so as to exclude the oxidising action of the air. As a reducing agent it is little inferior to potassium; and as its combining power is lower, and it is obtained much more cheaply, it may usually be advantageously substituted for potassium in reducing operations. Sodium does not occur in the metallic form in nature, but its compounds are very widely distributed. It is found by far the most abundantly in the form of chloride of sodium (or common salt), but it likewise occurs as albite or soda-felspar, cryolite (the double fluoride of sodium and aluminium), borax (the biphosphate of soda), trona (the sesquicarbonate of soda), and Chili saltpetre (nitrate of soda). Dubamel in 1736 discovered that potash and soda (now known to be the oxides of potassium and sodium) were distinct bodies. Sir H. Davy first obtained the metal *Sodium* in 1807. The symbol of this metal, Na, is the abbreviation of *Natrium*, which is derived from *Natron*, one of the old names of native carbonate of soda.

The methods of obtaining sodium are similar to those already described for obtaining potassium. Intimately mix 30 parts of common soda-ash with 13 parts of small coal and 3 parts of chalk, knead them into a stiff paste with oil, heat them in a covered iron pot till the oil is decomposed, and finally distil them in an iron retort with the precautions which are noticed in describing the preparation of potassium. The object of adding the chalk is to prevent the separation of the charcoal from the carbonate of soda when the latter fuses. This mixture ought to yield nearly one-seventh of its weight of sodium.

Sodium combines with all the elementary gaseous

bodies, and two of these combinations, those with oxygen and chlorine, are of extreme importance and value. With oxygen sodium forms two compounds—an oxide, Na₂O, and a peroxide, Na₂O₂. The latter is of no practical value. The oxide (soda) was formerly known as *fossil* or *mineral alkali*, to distinguish it from potash, which, from the source from which it was procured, was termed *vegetable alkali*. Anhydrous soda, Na₂O, is procured by burning the metal in dry air; it is of a yellowish-white colour, powerfully attracts moisture, and retains the water so firmly that it cannot be expelled by heat. Hydrated or caustic soda, NaHO, closely resembles, both in its properties and in the mode of procuring it, the corresponding potash compound. It is, however, not so fusible as the latter, and is gradually converted, by exposure to the air, into carbonate of soda, which is also an infusible salt in its anhydrous state. Solution of hydrate of soda (or soda lye) is largely employed in the arts. It is prepared by boiling a tolerably strong solution of carbonate of soda in milk of lime until a portion of the filtrate ceases to effervesce on the addition of an acid. The solid hydrate has a specific gravity of 2.13, and the quantity of anhydrous soda in any solution may be closely approximated to by determining the specific gravity of the fluid and referring to a table indicating the strength corresponding to the specific gravity.

Many of the combinations of the oxide of sodium (soda) with acids—constituting soda-salts—are of great importance. Carbonic acid forms three salts with soda—a normal carbonate, a sesquicarbonate, and a bicarbonate of soda.

Carbonate of Soda, Na₂CO₃ + 10H₂O, the *Soda* of commerce, is a colourless, inodorous salt, with a nauseous alkaline taste. It crystallises in large transparent rhomboidal prisms, which contain nearly 63 per cent. of water, but it readily parts with all this water on the application of heat. The crystals also lose the greater part of their water on mere exposure to the air, when they effloresce, and fall to powder. Water at 60° (15° C.) dissolves half its weight of the crystals, and boiling water considerably more, the solution acting like an alkali on vegetable colours. This salt, the *natron* of commerce, occurs native in the natron-lakes of Hungary, Armenia, &c., in association with sulphate of soda and chloride of sodium. In other regions it appears in an efflorescent form on the surface of the earth. It is now, however, almost entirely manufactured from sea-salt. For its manufacture, see SODA.

Sesquicarbonate of Soda, Na₂CO₃ + 2NaHCO₃ + 3H₂O, occurs native in the form of large, hard, non-efflorescent prisms, in Hungary, Egypt, Mexico, &c., under the name of *Trona*. When strongly heated it loses one-third of its carbonic acid, and becomes converted into the preceding salt.

Bicarbonate of Soda, NaHCO₃, may be formed by passing a current of carbonic acid through a strong solution of carbonate of soda, till saturation takes place, and allowing the mixture to crystallise; or it may be produced on a large scale by exposing crystals of carbonate of soda to a prolonged current of carbonic acid. Most of the bicarbonate in commerce is now, however, prepared by the ammonia-soda process (see SODA). In this a current of carbonic acid gas is passed through a solution of salt in aqueous ammonia, when chloride of ammonium and bicarbonate of soda are produced. The bicarbonate crystallises in four-sided prisms, which require 10 parts of water at an ordinary temperature for their solution. This salt is used largely in medicine. See AERATED WATERS.

Sulphuric acid forms with soda a normal and an acid sulphate. The normal *Sulphate of Soda*,

$\text{Na}_2\text{SO}_4 + 10\text{H}_2\text{O}$, has been already described under its synonym of *Glauber's Salt* (q.v.). The acid salt, or *bisulphate* of soda, NaHSO_4 , is of no special interest.

The *Hyposulphite of Soda*, $\text{Na}_2\text{S}_2\text{O}_5 \cdot 5\text{H}_2\text{O}$, occurs in large colourless, striated, rhombic prisms, of a cooling and sweet taste. When strongly heated in the air it burns with a blue flame. It dissolves readily in water, depositing sulphur if the solution be kept in a closed vessel. It may be obtained by digesting a solution of sulphite of soda with powdered sulphur. The sulphur is gradually dissolved, and forms a colourless solution, which, on evaporation, yields crystals of hyposulphite of soda. This salt is largely employed in photography, and is occasionally prescribed medicinally. Sulphurous acid forms two salts with soda—viz. a sulphite and a bisulphite. The *Sulphite of Soda*, $\text{NaHSO}_3 + 7\text{H}_2\text{O}$, is obtained by passing sulphurous acid over carbonate of soda, dissolving the resulting mass in water, and crystallising; when the salt is obtained in efflorescent oblique prisms, which are soluble in 4 parts of cold water, the solution having a slightly alkaline reaction and a sulphurous taste. This compound was at one time commercially known as *Antichlore*, and was largely used in paper-manufactories for the purpose of removing the last trace of chlorine from the bleached rag-pulp. The term is now applied only to the hyposulphite, which is both cheaper and more efficacious. The *Bisulphite* is of no importance. *Nitrate of Soda*, NaNO_3 , known also as *Cubic Nitre* or *Chili Saltpetre*, occurs as a natural product on the surface of the soil of certain South American districts. In most of its properties, excepting its crystalline form, and further in its being deliquescent, it resembles nitrate of potash. It is used as a Manure (q.v.). The *Phosphates of Soda* are comparatively numerous. *Hypo-chlorite of Soda*, NaClO , is at present known only in solution, in which it occurs as a yellowish-green fluid, evolving a smell of chlorine; it has strong bleaching power, and when boiled becomes decolorised, and evolves chlorine freely. It is formed by passing a stream of chlorine gas through a solution of carbonate of soda, the resulting solution containing the hypochlorite, together with undecomposed carbonate of soda and chloride of sodium. This solution is useful as a bleaching agent, as an oxidising agent in analytical chemistry, and as a disinfectant agent. There are two *Borates of Soda*, of which the only important one, the *Biborate*, is already described under its ordinary name of *Borax* (q.v.). Various *Silicates of Soda* have been formed (see SILICON, GLASS, SLAGS).

The *Haloid Salts* of sodium resemble, in their general characters, the corresponding salts of potash. Of these by far the most important is *Chloride of Sodium* or *Common Salt*, formerly known as *Muriate of Soda*, NaCl . It occurs naturally in far greater quantity than any other soluble salt, and is fully described at SALT. The other haloid salts—the iodide, bromide, and fluoride of sodium—require no notice.

Sodium has been recently found to enter into various groups of organic bodies—the sodium-alcohols for example. When sodium or potassium is gradually added to anhydrous alcohol the temperature rapidly rises, the metal is dissolved, hydrogen is evolved, and a fusible deliquescent compound is formed, which has received the name of *Sodium-alcohol* (or potassium-alcohol), or of *ethylate of soda* (or potash), its composition being such that it may be regarded as alcohol in which one atom of hydrogen is replaced by one of the metal.

The tests for the salts of sodium are not very satisfactory, because the metal forms scarcely any insoluble compounds. A salt of sodium is usually

concluded to be present when, the absence of all other bases having been proved, a saline residue remains, which, with bichloride of platinum, yields yellow striated prisms by spontaneous evaporation. Before the blowpipe the salts of sodium are known by the intense yellow which they communicate to the outer flame, and if a weak alcoholic solution of one of the salts is burned a similar yellow tint is communicated to the flame. Spectrum analysis is too delicate to be of much practical use.

The *medicinal uses* of the sodium compounds may be considered alphabetically. *Acetate of Soda* is a mild diuretic, similar in operation to acetate of potash, for which it may be substituted. *Arseniate of Soda* is serviceable in periodic affections, chronic skin diseases, and the cases in which arsenic is generally employed in medicine. Paper impregnated with a solution of arseniate of soda sweetened with sugar is sold as a poison for flies. *Biborate of Soda*, or *Borax*, is employed principally as a topical astringent, and is used with advantage in aphthous eruptions of the mouth and throat. *Bicarbonate of Soda* is a most popular remedy in cases of dyspepsia, but its use is highly injurious when there are phosphatic deposits in the urine. *Carbonate of Soda* is not employed as an antacid so frequently as the bicarbonate, in consequence of its disagreeable taste; but in the dried state, when deprived by heat of its water of crystallisation, it is much used as an alterative. In dyspepsia attended with acidity a combination of the dried carbonate with blue pill and rhubarb pill is often extremely useful. As it has a very acrid taste, it should be combined, if given in powder, with some bland substance, such as Compound Tragacanth Powder. A solution of *Chlorinated Soda* is preferable to hypochlorite of lime in destroying noxious effluvia, as the salt which is left does not deliquesce. *Phosphate of Soda*, known also as Tasteless Purging Salt, is a mild saline purgative, with a far less unpleasant taste than sulphate of magnesia. *Sulphate of Soda* and *Tartrate of Soda* and *Potash* have been already described under their ordinary names of Glauber's Salt (q.v.) and Rochelle Salt (q.v.).

Sodom, APPLE OF, the name given to the fruit of a species of *Solanum* (q.v.). But it is possible that the true Apple of Sodom, or Mad Apple, of the shores of the Dead Sea, mentioned by Strabo, Tacitus, and Josephus, and described as beautiful to the eye, but filling the mouth with bitter ashes if tasted, is a kind of gall growing on dwarf oaks, and produced by a species of gall-insect.

Sodom and Gomorrah, two ancient cities, almost invariably spoken of in conjunction in the Bible, and forming with Admah, Zeboiim, and other towns the 'cities of the plain,' which, on account of the enormous wickedness of their inhabitants (the nature of which is indicated in the term Sodomy), are said to have been overthrown—not submerged—by some terrible convulsion of nature. Modern writers on sacred topography are not agreed as to the site to be assigned to these cities. It used to be generally held that they stood on the southern shore of the Dead Sea, near the salt ridge of Usdom (a form of the word 'Sodom'). Conder believes, however, that he can fix the site of Zoar, at least, at the foot of the mountains of Moab, to the north-east of the Dead Sea (q.v.). The popular belief that the cities were miraculously overwhelmed by the waters of the Dead Sea, and that their remains may still be seen at the bottom, is an idle tale of superstitious travellers, uncountenanced either by fact or by the terms employed by Scripture to describe the catastrophe.

Sodoma, or SODONA, IL, was the usual appellation of Giovanni Antonio Bazzi (1477-1549), religious and historical painter, born at Vercelli; he painted in Rome, but chiefly at Sienna, where he died. His best-known pictures are the famous frescoes in the Villa Farnesina at Rome. See German Life by Jansen (1870).

Sodomy, an unnatural crime, is punishable with penal servitude for life, or any term not less than ten years, and the attempt to commit it is punishable with penal servitude for from three to ten years. In Scotland it was till 1887 nominally a capital offence, though punished only by penal servitude and imprisonment.

Sodor and Man. See HEBRIDES, and MAN.

Soest, in Westphalia, 37 miles SE. of Münster by rail, was once a Hanse town and a free imperial city, with a population of 30,000; now it has but 15,407 inhabitants (half of them Catholics). The Gothic Cathedral (Catholic), built in 1314, was restored in 1846. The municipal law of Soest served as the model for Lübeck, Hamburg, &c. In 1180 the Archbishop of Cologne seized the sovereignty; but in 1441 the people rose and sought the protection of the Duke of Cleves, and this led to a siege and heroic defence.

Sofala, the name given to that portion of the south-east coast of Africa which extends from the Zambesi as far south as Delagoa Bay. The inland region at the back of the coast district, partly corresponding to Matabeleland, was anciently known as the Empire of Monomotapa (though the word is rather the name of the prince than of the state). Sofala was described by the old geographers as a very rich, gold-producing country, and was judged by some to be the Ophir of Solomon, an idea afterwards long discredited, but lately revived since Mauch discovered the disused mine-workings around Zimbabwe (q.v.), and interest was aroused in them through the British South Africa Company penetrating into that region. Sofala belongs to the Portuguese, who established themselves here in 1505. Their headquarters, the town of Sofala, once a large commercial town, is now a wretched place of 1000 inhabitants.

Sofia, the capital since 1878 of the principality of Bulgaria, stands in a broad valley of the Balkans, beside the railway connecting Constantinople with Belgrade and Vienna. The city since 1891 has undergone thorough reconstruction, most of the crooked dirty streets, with their tumble-down houses and ruinous mosques, of the old Turkish city being demolished to make way for broad tree-planted boulevards, with paved sidewalks and electric-light posts, new French-looking houses, shops and hotels, and large public buildings (baths, national library, banks, post-office, &c.). The principal streets converge upon the new government palace. For centuries the place has been renowned for its hot mineral springs (117° F.). Sofia is the seat of a metropolitan of the Greek Church, and of the national university. There is a considerable trade in hides, spirits, maize, and wheat. Pop. (1870) 19,000; (1895) 47,500, of whom two-thirds were Bulgarians, and about 5000 Jews (originally emigrants from Spain). Sofia is the *Serdica* of the Romans, and was the seat of a famous church council in 343. Attila plundered it; and it was in the possession of the Bulgarians from the beginning of the 9th century until its capture by the Turks in 1382. Both Hunyady and the Albanian chief Mustapha Pasha (in 1829) utterly devastated the place, and it was occupied by the Russians under General Gourko in January 1878. See *Contemporary*, April 1891.

Softa, a student of Mohammedan theology and sacred law.

Soft-grass (*Holcus*), a genus of Grasses (q.v.).

Sogdiana, anciently a province of the empire of Persia in the time of the Achemenians, corresponded to the modern districts of Samarcand and Bokhara and the valley of Zerafshan. Under the Greeks, after its conquest by Alexander the Great, it was united with Bactria. The Arab geographers describe its fertility and beauty in terms of exaggerated eulogy.

Soham, a small market-town of Cambridgeshire, with a fine church, 5 miles SE. of Ely. Pop. of parish, 3980.

Sohar, a seaport of Oman in Arabia, stands on the Gulf of Oman, 130 miles NW. of Muscat, and is a well-built place with town-walls and a castle, some weaving and working of metals, a good harbour, and an active trade. It was a famous trading-town in the end of the 10th century, but not long after its commerce fell away entirely. The Portuguese occupied it from 1508 to 1650. Pop. probably 5000.

Soignies, a town of the Belgian province of Hainault, 22 miles by rail S. by W. of Brussels. The church of St Vincent dates from the 12th century, though it was first founded in 650. Pop. 8683. Near here the French defeated the Netherlanders on 10th July 1794.

Soils. Soils are generally said to be derived from our primitive rocks by that disintegrating process called weathering (see DENUDATION). The doctrine that commonly obtains is that lichens, the first occupants of the thin initial layer so formed, contributed by their life and death in turn to soil formation, and thereby made life possible for the mosses. These in like manner yielded their increase, and rendered it possible for plants of a still higher order to grow and flourish, and so on, until perfect soils were produced in which all plants might luxuriate. It is perhaps convenient to adopt the lichens as the starting-point; but it would probably be more accurate to presume that these were preceded by other forms, for the origin of soils may indeed have been the origin of life itself, and until we can clearly define the one there must of necessity be indefiniteness about the other. Recent experiments go to show that sterilised soils are infertile soils; and if that be an unassailable doctrine, then it follows that micro-organisms aided in the formation of that soil which was sufficient for the growth of the lichen. The origin of soil organisms must be left to the bacteriologist to discuss, but it may not be out of place to state here that the growing, sowing, and feeding of the desirable soil germs is of as much importance to the agriculturist of to-day as is the sowing of seeds, or the growing and feeding—by manuring—of plants; indeed, it may almost be asserted that manures applied to soils do not always act—as they do in water-culture experiments—as direct plant-food, but rather as food for those soil bacteroids which are the great agricultural workers, or preparers of food for plants. It may be affirmed that it is quite as necessary for the agriculturist to have certain conditions of soil—physical and chemical—which are essential to the growth and working of the desirable germs, and accordingly essential for the growth of good crops, as it is for the brewer to have those more or less definite physical and chemical conditions which are essential to the growth and working of the yeast plant in the production of good beer. Moreover, what is universally stated in text-books as being due to a 'selective power' of plants is entirely ascribable to the biological condition of the soil; and far from its being a power of selection or instinct possessed by plants, these have no choice in the matter.

Popularly speaking, the breaking down of rocks—by weathering—results in the building up of soils, and the composition of soils so formed must vary in proportion to the kind and number of minerals employed in the process. The principal minerals so employed are felspar, quartz, mica, talc, limestones (including chalks, marls, &c.), hornblende (amphibole, augite, olivine, &c.), clays, and zeolites. Soils formed from the rocks underlying them are designated *sedimentary*, while *transported* soils are those derived from rocks at higher levels: thus, if carried down by glaciers they are termed *drift soils*, if carried by running water they are known as *alluvial soils*, and the combination of these two agents results in *co-alluvial soils*. Anderson classified soils according to 'their general physical characters, and the ordinary mode followed in practice of dividing them into clays, loams, &c.' They are also frequently classed thus: siliceous or sandy, calcareous, argillaceous, and vegetable or peaty, while a somewhat elaborate subdivision of these is given in Schubler's classification.

Generally speaking, a mixed soil will possess important advantages over clay, chalk, or siliceous soils, and this mixing is performed by nature herself, as already described, where there is a dual outcropping of rocks; while the art of man effects what is practically the same thing by claying, liming, marling, &c. The chemical composition and physical conditions of soils have until quite recently been about the only features which received consideration, but it is now beyond doubt that the biological condition is of at least equal importance, for, in regard to a well-drained soil, *sterility* and *infertility* are synonymous terms. This new doctrine solves at once the problems which for many generations have been insurmountable—in such cases, for instance, as two soils having the same *chemical* composition, and one being fertile and the other barren. Another highly important consideration is that sterile soils are practically *non-retentive*; and if that be so, all the hitherto obtaining doctrines which have ascribed to silicates, oxides, &c. such unerring precision in forming new and definite but purely chemical relationships with added substances, such as phosphates, potash and ammonia salts, &c., must fall. It has been (and is still) customary for exponents of agricultural science to remark that it was a curious thing that the valuable nitrates were not retained by soils—were indeed easily washed out, and were more or less always to be found in drainage waters, while phosphoric acid, potash, or ammonia was rarely if ever so; but according to the germ theory there is nothing curious about it, and it could not be otherwise in a fertile soil. It is evident that many of the heretofore established certainties of soil science and of agriculture are destined to be overthrown. Capillarity, for instance, is doomed; for fertility of soil is incompatible with that condition, and it is scarcely compatible with drains operating at the lower end of the capillary tubes. Drainage dogmas also require modification, in so far, at least, as they declare the removal of water—which is surely antithetic to capillarity—and the opening up of a path for the entrance of atmospheric air to be the chief functions of drains. Plants can live in water, but not in an atmosphere of carbon dioxide; a fertile soil is as prolific a source of this gas as the brewer's fermenting tun, and but for the presence of drains—i.e. the removing *per descensum* of carbonic acid—no plant could grow. It is also maintained that the entrance of carbon dioxide is essential because of its function as a soil solvent; but from what has been said it is evident there is something wrong with the theories. Free entrance of oxygen to soils is necessary for root life, and that is the reason why removal of the over-abundant carbonic acid becomes

imperative; but it is not the case that it is necessary to nitrification, and the leguminosæ can grow robustly in what is practically an atmosphere of carburetted hydrogen, so long as calcium carbonate is maintained in the surface soil. Strange as this may seem, it has been demonstrated on fields in Midlothian; and the fact goes to show that the nitrifying organisms in soils can produce from calcium carbonate all the oxygen required by them for their life and work. This, indeed, is one of the great functions of lime in soils. Lime cannot be replaced by magnesia in soils, nor magnesia by lime; thus in fruit formation lime cannot perform the functions of magnesia, while lime—in addition to its all-importance as a salifiable base—becomes the great carrier of food-stuffs into the plant, where again it is of paramount importance as a fixer of the acid product of the oxalic fermentation, in which rôle magnesia is useless.

An article on soil formation would be incomplete if reference were not made to the important part played by earthworms (*Lumbricus terrestris* especially; see EARTHWORMS); but while they bring up much valuable material from the subsoil, they are great robbers of lime from the surface soil.

The views above stated are more fully treated in a work on the subject by the present writer and Mr A. N. M'Alpine (1892). There are also works by Scott Burn, Fream, Scott and Morton, Johnson, Munro and Wrightson, Brant, &c. See also AGRICULTURE, MANURES, NITRIFICATION, &c.

Soissons, a town and fortress of France, dept. Aisne, stands on the river Aisne, 65 miles N.E. of Paris by rail. Soissons is the key of Paris for an army invading France from the Netherlands, and is the meeting-point of several military roads. The principal building is the cathedral, founded in the 12th century, the library of which contains many rare MSS. There are also some remains of the great castellated abbey of St Jean des Vignes (1076), where Thomas à Becket found refuge when in exile. The church of St Peter (Romanesque) dates from the 12th century; there are slight remains of the once celebrated abbey of Notre Dame (founded 660) and of the abbey church of St Léger (1139). Quite near to Soissons is an institute for deaf and dumb, which occupies the site of the famous abbey (560) of St Médard, where Clothaire and Siegbert were buried. The civil buildings embrace a college and a museum of antiquities. Pop. 11,850, who carry on varied industries. Soissons is one of the oldest towns in France, and was celebrated even in the time of the Romans, when it bore the name first of *Noviodunum*, and afterwards of *Augusta Suessionum*; hence its modern name of Soissons. It was the second capital of Gallia Belgica, and subsequently the most important town of the Romans in northern Gaul. Near to it Clovis overthrew Syagrius, the Roman commander, in 486. The same prince made Soissons the seat of the Frankish monarchy of Neustria. Here Pepin was crowned king, and Louis the Pious imprisoned. It was the gathering-place of more than one important council and has been repeatedly captured and sacked in war—e.g. six times during the Hundred Years' War, by the Armagnac party in 1414, by Charles V. (1544), the Huguenots (1565), three times in 1814, and by the Germans in 1870.

Soke, a form of the word *Soc*, meant in old English times both the privilege of holding a court and the district held by tenure of Socage (q.v.).

Sokoto, a Central African state, bounded by the Sahara, the Niger, the Benue and Bornu. The mass of the population are Hausa (q.v.), but ruled by Fulahs (q.v.). Gando is dependent on Sokoto, which itself is largely controlled by the British Niger Company.

The area is stated to be nearly 200,000 sq. m. The country is generally level, but rises to 10,000 feet in the province of Adamawa; and it is well watered by the Benue and its tributaries. There are large deposits of good iron. The inhabitants number 10 or 12 millions. The ruling race are the Fulahs (q.v.); their subjects Hausa (q.v.) and various Negro tribes. In 1885 the sultan of Sokoto put his kingdom under the protectorate of Britain, and granted to the Royal Niger Company a monopoly of the trade. The town of Sokoto, in the north-west corner of the kingdom, shares with Wurnu, 18 miles east, the rank of capital. Near it Clapperton died (1837); and Sokoto has also been visited by Barth (1853), Rohlfs (1866), Flegel (1880), and J. Thomson (1885).

Solanaceæ, or SOLANÆ, a natural order of exogenous plants, mainly herbaceous plants and shrubs, but including a few tropical trees. The leaves are mostly alternate, undivided or lobed, without stipules. The flowers are regular, or nearly so; the calyx and corolla generally five-cleft; the stamens generally five. The fruit is either a capsule or a berry, usually two-celled. The plants of this order are mostly natives of tropical countries, a small number extending into the temperate climates; in the coldest regions they are entirely wanting. They are mostly distinguished by an offensive smell and by containing a narcotic, poisonous substance, usually associated with a pungent principle, and some of them are amongst the most active poisons. Sometimes the narcotic substance predominates, as in Mandrake (q.v.) and Henbane (q.v.); sometimes the pungent substance predominates, or is alone present, as in Cayenne Pepper (*Capsicum*); sometimes both are present in more or less equal proportion, as in Tobacco, Thorn-apple, and Belladonna. The fruit is generally poisonous; but that of a considerable number of species, in which acids and mucilage predominate, is eatable—e.g. the berries of the Winter Cherry and other species of *Physalis*, of the Egg-plant (q.v.) and some other species of *Solanum*, and of the Tomato (q.v.). The tubers, which occur in a few species, contain much starch, and serve for food, the Potato being the chief example. The seeds of all contain a fixed oil, which in the south of Germany is expressed from the seeds of the Belladonna itself.

Solan Goose. See GANNET.

Solanum, a genus of plants of the natural order Solanaceæ, containing a great number of species, distributed all over the world, but particularly abundant in South America and the West Indies. Some are herbaceous, others shrubs; some unarmed, and some spiny; many covered with a down of starlike hairs. The flowers are in false umbels, or almost in panicles; seldom in racemes or solitary. The anthers open by two holes at the top. The berries are two-celled, and contain many smooth seeds. The species of this genus almost always contain in all their parts a poisonous alkaloid, *Solanine*, sometimes so much that the

leaves or berries cannot be eaten without danger, whilst in a few species the quantity present is so small that these parts are eaten freely, being agreeable and harmless. By far the most important of all the species is the Potato (q.v.), in which, however, solanine is found in considerable quantity, so that not only the herbage, but the juice of the raw tubers, is unwholesome. Of the species with eatable fruit the principal is the Egg-plant (q.v.). The only British species are the Bitter-sweet (q.v.) and Common Night-shade (q.v.), both of which possess poisonous and medicinal qualities. The berries, leaves, bark, and roots of various species are employed for different medicinal uses in warm countries. The berries of *S. saponaceum* are used as a substitute for soap. The fruit of *S. sodomium*, Apple of Sodom, a native of North Africa, contains a greenish pulp when ripe, which if eaten causes headache, madness, and death. *S. quitense* yields a wholesome fruit resembling an orange in appearance and somewhat also in flavour. The fruit of *S. muricata* is eaten in Peru and has the flavour of a melon. The Kangaroo-apple of Australia is the fruit of *S. laciniatum*, which is wholesome when ripe, but poisonous when unripe. The berries of *S. coagulans* are employed in Egypt to curdle milk.

Solar Microscope is an apparatus for projecting upon a screen by means of sunlight an enlarged view of any object. It is essentially the same as the combination of lenses used in the Magic Lantern (q.v.) taken in conjunction with a heliostat. A heliostat is a plane reflecting mirror which by means of clockwork follows the sun's apparent motion so as always to throw its rays in the direction in which they are first adjusted. By this instrument the rays are thrown horizontally into the solar microscope, and are concentrated first by a large lens and then by a small lens upon the small object that is to be projected. As they diverge the rays are collected by an adjustable system of lenses and focussed sharply on a screen. Uncertainty of sunlight very much circumscribes the usefulness of the apparatus. For solar cycle, solar engine, see CYCLE, AIR-ENGINE.

Solar Myth, a myth allegorising the course of the sun; by some mythologists constantly invoked to explain the problems of Mythology (q.v.).

Solar System, the planets and comets which circle round the sun; also called *planetary system*. No change of much magnitude can take place in the elements of the planets without having effect on the earth and its inhabitants, on account of the mutual attractions of the planets for each other; in fact, they appear as members of one family, bound together by common ties, which could not be ruptured in the case of one individual without communicating a general shock to the others. The various members of the solar system, and their motions, are noticed under PLANETS, COMET, SUN, MOON, SATELLITES, METEORS, GRAVITATION, CENTRE, PRESSION, ECLIPSES, &c., so that it only remains here to tabulate the more interesting numerical facts connected with them.

Name.	Diameter in Miles.	Density, Earth's being = 1.	Mass, Sun's being = 1.	Distance from Sun in Millions of Miles.	Period of Revolution, in Days.	Velocity in Orbit—Miles per Hour.	Velocity of Rotation at Equator—Miles per Hour.	Force of Gravity on Surface (Earth = 1).
Mercury.....	3,008	1.20	1/10000	36	88	107,012	392	0.47
Venus.....	7,480	0.92	1/10000	66	225	78,284	1,006	0.87
Earth.....	7,926	1.00	1/10000	92	365½	66,579	1,040	1.00
Mars.....	4,900	0.45	1/10000	141	687	55,938	638	0.28
Jupiter.....	88,439	0.23	1/1000	483	4,332	29,208	28,001	2.55
Saturn.....	75,030	0.11	1/1000	886	10,759	21,500	22,476	1.15
Uranus.....	30,875	0.25	1/1000	1783	80,687	15,202	10,210	0.85
Neptune.....	87,205	0.17	1/1000	2794	60,187	12,156	1	0.80
Sun.....	866,200	0.25	6,567	28.71
Moon.....	2,160	0.63	1/100000	2,273	10	0.15

Solder, a fusible alloy used for joining metals. For some of these there are two classes of solders, called hard and soft. Under the head BRAZING the composition of hard solders for brass and copper is given. Common brass makes a solder for iron. 'Silver solders,' which melt at a lower temperature than ordinary hard solders, are used for brass, copper, and sometimes even for iron. One kind is composed of equal parts of silver and brass; another variety consists of these two metals and zinc in equal proportions. These solders are a little costly, but when they can be used they give much satisfaction. The solder used by silversmiths is usually made of two of silver and one of brass. Goldsmith's solder varies with the fineness of gold to be joined, the coarsest kind being formed of three of gold, two of silver, and nearly two of copper; but the proportion of gold is much higher for fine work. Soft solders for brass consist of two of tin and one of antimony, and of lead and tin in equal or nearly equal proportions. The latter is also used for lead, but plumbers use besides a mixture of one of tin to two of lead. For pewter a little bismuth is added to these two metals. A solder of two of tin and one of lead does for zinc. Suitable solders for the above metals can be purchased already prepared. The fluxes usually employed are borax or sal ammoniac for hard solders, and resin, muriatic acid, or Baker's mixture for soft solders.

Soldier. See ARMY, ENLISTMENT, MARTIAL LAW, TACTICS, WAR.—**SOLDIER BEETLE** is a name given to coleopterous insects of the genus *Telphorus*, from their red colour and combativeness.—**SOLDIER BIRD** is an Australian Honey-Eater (*Meliphaga sanguinolenta*), named from the male's crimson plumage. For Soldier-crab, see HERMIT-CRAB.

Soldo. See SOLIDUS.

Sole (*Solea*), a genus of flat-fishes (Pleuronectidæ), distinguished by the following characters: mouth rather small and not terminal, its lips curved on each side towards the ventral edge of the head; teeth present only on the lower or left side, where also the jaws are larger and stronger than on the right; eyes small and not prominent, on the right side, the dorsal anterior to the ventral; scales small, ctenoid—i.e. fringed with spines posteriorly; lateral line straight on the body, but with an anterior dorsal curve on the head; tactile filaments on the lower side of the snout. Paired fins may be rudimentary or absent. The dorsal fin commences on the snout, and is not continuous with the caudal. The shape of the fish is oval, the outline of the snout being semicircular, and projecting somewhat beyond the mouth. The Common Sole (*S. vulgaris*) is a fish

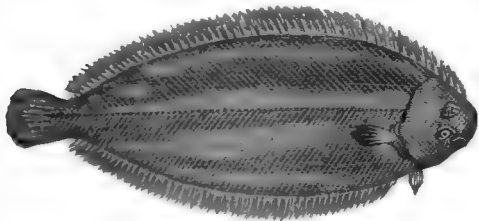

Common Sole (*Solea vulgaris*).

of high value in the market, and its price has risen greatly of late years: in 1890 it was over £6 per cwt. at the place of landing. It is captured in the North Sea from Yorkshire southwards, in the English Channel and Irish Channel, and off the south coast of Ireland. Off the Scottish coasts it

occurs only in small numbers. Beyond Britain it ranges along the west coast of Europe and throughout the Mediterranean. The largest supply of soles comes from the North Sea, nearly four times as many being landed on the east coast as on the south coast of England, while the west coast produces about the same quantity as the south, the produce of the Irish grounds being included in the former. The Common Sole is the largest of the British species; it is distinguished by the following characters: pectoral fins well developed on both sides, nostrils on the two sides similar, filaments of the lower side of the snout crowded without arrangement. The colour of the upper side consists of longitudinal series of black blotches on a yellowish-brown ground. The sole has been known to reach a length of 26 inches and a weight of 9 lb., but its usual size varies between 10 and 20 inches and its weight from $\frac{1}{2}$ to 2 lb. It spawns in March and April chiefly, but some individuals may shed their ova in May. It breeds on the grounds where it lives, and its ova are small and buoyant. The young, at a very early stage after they have metamorphosed, are occasionally found in tidal pools, but after about 1 inch in length they are probably to be found in deep water. The adults are frequently taken in estuaries in summer time, and have been said to thrive in fresh water, though that is doubtful: they certainly do not breed in fresh water.

The Sand Sole, sometimes called Lemon Sole (*S. lascaris*), is distinguished from the common sole by having specks instead of blotches on its coloured side, and a dilated nostril on the lower side. Its habits are similar to those of the common sole, and it is sent to market with it without distinction, but it is very scarce. The Thickback (*S. variegata*) is found only on the south coasts of England and Ireland, extending thence to the Mediterranean. It is smaller than the two previous species, seldom exceeding 9 inches in length. It is distinguished by its rudimentary pectoral fins, and its markings of dark transverse bands on a reddish ground. The Solenette (*S. Eutea*) is the smallest British species; it has rudimentary pectorals, and markings like the common sole, with the addition of a black line along every fourth or fifth fin-ray in the dorsal and ventral fins. It is common both in the North Sea and on the south coasts; it does not exceed 5 inches in length. There are a large number of species of *Solea* in temperate and tropical seas all over the world, but no others are of value as food. There are no soles of any value on the Atlantic coast of the United States. There are numerous closely allied genera. *Synaptura* is distinguished by the continuity of the longitudinal fins with the caudal; it includes the curiously marked East Indian *Synaptura zebra* mentioned by Cuvier, which is reddish olive, with twelve pairs of transverse brown bands. In some species of *Solea* and allied genera the pectorals are absent altogether. See *A Treatise on the Common Sole*, by the present writer, J. T. Cunningham (1890).

Sole Bay. See SOUTHWOLD.

Solecism. A solecism is the term applied to any violation of the grammar or idiom of a language, or of the usages of society. The word (Gr. *Soloikismos*) is derived from the city of Soli in Cilicia, whose inhabitants spoke very bad Greek, in consequence of their intercourse with the Cilician natives, and provoked the fastidious Athenians to coin the epithet.

Soleiman II. See SOLYMAN.

Solen. See RAZOR-FISH.

Solenhofen Stone. See LITHOGRAPHY.

Solenoid. See MAGNETISM, Vol. VI. p. 793.

Solent, the western portion of the strait that intervenes between the Isle of Wight and the mainland of England. It is 17 miles long, and about 3 in average breadth, but contracts to $\frac{3}{4}$ mile at Hurst Castle (1535), built by Henry VIII. to guard its entrance on the south-west; and here the tide flows with a rapidity which at certain times no boat can stem.

Soleure (Ger. *Solothurn*), a canton in the north of Switzerland, bounded on the W. and S. by Bern, and on the N. and E. by Basel and Aargau. Area, 306 sq. m.; pop. (1880) 80,424; (1888) 85,621, mostly Roman Catholics and speakers of German. The greater portion of the canton is fertile and well cultivated, especially in the valley of the Aar. But it also embraces outlying ranges of the Alpine and Jura systems. Besides grain, the principal products are fruit, timber, cherry-brandy, cheese, cotton, paper, iron, hose, clocks, &c. The canton consists of the territories acquired by the town of Soleure. The legislative council is elected by the people, and that body chooses the executive (5 members), both for four years. But both bodies are subject to the immediate control of the people, as well as every act they do, by means of the referendum.—The town of Soleure, the capital of the canton, is situated on both sides of the Aar, 18 miles NNE. of Bern by rail. The most notable building is the cathedral of St Ursus, built in 1762-63 on the site of an older church (1050), with a cupola and façade of Corinthian columns. There are also a curious old clock tower, an arsenal with a museum of ancient trophies of war, and collections of antiquities. The principal objects of industry are cotton, clocks, and cement. Pop. 8305. Soleure (*Salodurum*) was a place of some consequence in Roman times, was made a free city of the empire (1218), joined the Swiss Confederation in 1481, and in 1828 was chosen the bishop's see for the diocese of Basel. Close by are the baths of Weissenstein, with a celebrated 'wey-cure' that is very much frequented.

Sol-fa System. Attempts have been made at various times to introduce a musical notation in which the staff with its lines and spaces is dispensed with. Jean Jacques Rousseau suggested, but afterwards discarded, a notation where the notes of the scale were indicated by the Arabic numerals—a principle which is the chief feature of the Chev e system, now largely used in France. A system similar to Rousseau's in its leading features, called the Tonic Sol-fa, has been brought into use in many singing-schools in Britain and America—its chief promoter being the Rev. John Curwen (q.v.), who obtained his main principles about 1840

from Miss Glover, a teacher at Norwich. It is believed that now a million and a half of children are learning to sing on this method in British primary schools. The system proceeds on the principle of giving the chief prominence to the fact that there is in reality but one scale in music, which is raised or lowered according to the pitch of the key. The seven notes of the diatonic scale are represented by the Solfeggio (q.v.) syllables, or rather Miss Glover's modification of them—*Doh, Ray, Me, Fah, Soh, Lah, Te*; *Doh* standing for the keynote in whatever key the music is written. In the early exercises the pupils are accustomed to a scale or diagram, called the Modulator, representing pictorially the exact intervals of a key, with the semitones in their proper places. In written music only the initial letters of the solfeggio syllables are used—*d, r, m, f, s, l, t*; the higher octaves of a given note being distinguished by a ¹ above, as *d¹, r¹*; and the lower by a ₁ or ₂ below, *m₁, m₂*. The name of the key is prefixed to a tune as its signature, as 'Key A,' 'Key B flat'—the keynote being, in all the major keys, *doh*. To indicate

rhythm a perpendicular line | pre-
cedes the stronger or louder accent,
a colon : the softer accent, and, where
necessary, a shorter perpendicular
line | the accent of medium force.
A note immediately following an
accent mark is supposed to occupy
the time from that accent to the
next. A horizontal line indicates
the continuance of the previous note
through another pulse or beat. A
dot divides a pulse into equal sub-
divisions. A dot after a mark of
continuance indicates that the pre-
vious note is to be continued through
half that pulse. A comma indicates
that the note preceding it fills a
quarter of the time from one accent
to the next; a dot and comma to-
gether three-quarters. An inverted
comma , is used to denote that the note preceding
it fills one-third of the time from one accent to the
next. An unfilled space indicates a rest or pause
of the voice. A line below two or more notes
signifies that they are to be sung to the same
syllable. We subjoin an example of the tonic sol-
fa shown alongside of the ordinary notation, and
illustrating most of the features named :



Modulator.

KEY A.

GOD SAVE THE QUEEN.

| d : d : r | t₁ : -d : r | m : m : f | m : -r : d | r : d : t₁ | d : - : - | s : s : s

| s : -f : m | f : f : f | f : -m : r | m : f : m : r : d | m : -f : s | l₁ s₁ f : m : r | d : - : - |

In modulating into a new key the note through which the transition is taken is indicated by a combination of the syllabic name which it has in the old key with that which it has in the new—*me lah*, for example, being conjoined into *m¹lah*; and in writing this note (termed a bridge note) the initial letter of its syllable, as a member of the old key, is placed in small size before and above the initial

of the syllable of the new, as *m¹, d_s*. In the case, however, of an accidental, where the transition is but momentary, a sharpened note changes its syllabic vowel into *e*, and a flattened note into *aw*, spelled *a*, as *fah, fe*; *soh, se*; *te, ta*. In the minor mode *lah* is the keynote; the sharp sixth is called *bay*, and the sharp seventh *ss*. The signature of the key of A minor is 'Key C;'; *lah* is A. The

time-names of the French Chev  system have lately been adopted. The method of teaching, based on a wide experience, is of equal importance with the notation itself.

For a full explanation of this system, see Curwen's *Course of Lessons and Exercises in Tonic Sol-fa*. Its advocates maintain that it possesses advantages over the common system in the facility of its acquisition; the distinctness with which it indicates the keynote and the position of the semitones; the cheapness with which it is printed; and the manner in which, they say, it explains the proper mental effects of notes in harmony and key-relationship, and employs them in teaching. It has, however, been objected to by others, from its withdrawal of the direct indication of both absolute and relative pitch to the eye which exists in the common notation, from its limited applicability to instrumental music, and from its acquirement not being, like that of the ordinary notation, an introduction to the world of musical literature. It presents, however, no barrier, but rather a road to the acquisition of the older notation; and its widespread use and the testimony of the general body of practical teachers are eloquent arguments in its favour. Of the children in English primary schools who can sing from notes 80 per cent. learn on this system, which has practically ousted the 'Fixed Do' system of Hullah, its rival in earlier days. The Tonic Sol-fa College, founded in 1869, with its system of examinations, carries on a vast amount of useful work.

Solfata'ra (Fr. *Soufriere*, Ger. *Schwefelgrube* or *Schwefelsee*), the Italian names for such volcanoes as, having ceased to be violently active, emit from crevices gases, steam, and chemical vapours, chiefly of sulphurous origin. The most notable are found in Italy, in the Antilles, in Mexico, in the interior of Asia, and in Java. Probably the best known are those between Rome and Tivoli, and that at Pozzuoli (q.v.), near Naples. This last is an irregular plain almost surrounded by the walls of an ancient crater. From the crevices rise steam and gases, chiefly sulphuretted hydrogen, mixed with minute quantities of muriatic acid and muriate of ammonia. The cracks and fissures of the rocks abound with sulphur, alum, and sulphate of iron. The vapours exhaled are used as medicinal baths, which are taken in wooden huts on the spot. The *Soufriere* of the island of St Vincent, West Indies, about 3 miles in circuit and over 500 feet in depth, was in active eruption in 1880.

Solfeggio, in Music, a vocal exercise, in which the syllables Ut (or Do), Re, Mi, Fa, Sol, La, Si—corresponding to C, D, E, F, G, A, B—are employed in lieu of words. Their use as a method of nomenclature originated, as far as the first six are concerned, in the 11th century with Guido Aretinus (q.v.), who substituted his hexachord system for the old Greek tetrachords. Observing in the melody of an ancient hymn for the festival of St John the Baptist, beginning

*Ut queant laxis Resonare fibris
Mira gestorum Fumuli tuorum
Solve polluti Labii reatum
Sancte Ioannes,*

that the notes on which the successive phrases began were identical in order with the sounds of the hexachord, he adopted the syllables to which they were allied in the above stanza as names to represent the degrees of his new scale. When, early in the 17th century, the octave was completed by the seventh or 'leading note,' the syllable Si, formed of the initials of 'Sancte Ioannes,' was added; while Do generally took the place of Ut, as being more easily sung. The art of thus illustrating the construction of the musical scale by the use of syllables is called *solmisation*.

Solferino, a village of Northern Italy, 19 miles NW. of Mantua, stands on a hill, and has a tower, called the Spy of Italy, from which the whole plain of Lombardy may be seen. There, on June 24, 1859, the Austrians were defeated by the allied French and Piedmontese—the first named losing 20,000 men, and the allies 18,000. Pop. 1284.

Soli. See SOLEICISM.

Solicitor-general, the name given to one of the law-officers of the crown appointed by patent. The Solicitor-general of England has powers similar to those of the Attorney-general (q.v.), after whom he ranks and to whom he gives aid in discharging his functions. His tenure of office in practice terminates with the fall of the ministry of which he is a member. He receives on appointment the honour of knighthood.

The Solicitor-general for Scotland is one of the crown counsel, next in dignity to the Lord Advocate (see ADVOCATE, LORD), and exercising all his functions along with him, but he does so as his deputy and not of original right. An act, however, of 1887 provides that, if the office of Lord Advocate be vacant, indictments may be raised in the name of the Solicitor-general. Like the Lord Advocate, he has the privilege of pleading within the bar. This right was recognised by the court as early as 1662, though it was afterwards lost for some time.

Solicitors are lawyers, who prepare deeds, manage cases, instruct counsel in the superior courts, and act as advocates in the inferior courts. Their full title is Solicitors of the Supreme Court, and since 1st November 1875 the class includes attorneys, solicitors, and proctors at law. They are deemed officers of court, and the court exercises special jurisdiction over them, committing to prison such of their number as are guilty of misconduct, and in extreme cases 'striking them off the roll'—i.e. erasing their name from the official list of solicitors and so preventing them from practising. Action is now taken on the motion of the Incorporated Law Society, and after a preliminary investigation by that body, which also keeps the roll (Solicitors Act, 1888). Before a person is admitted a solicitor he must be articled to a practising solicitor for a term of five years (reduced to three years in certain cases). He must pass one general (preliminary) and two legal (intermediate and final) examinations. He must also pay about £120 in stamp fees. Solicitors in good practice also require a premium (often as much as £600) from each of their articulated clerks. After admission a solicitor must take out an annual certificate enabling him to practise. He must pay for this from £3 to £9 annually; a solicitor of five years' standing may become a barrister on giving one year's notice, passing two legal examinations, and paying certain fees. Penalties are provided for unqualified persons acting as solicitors, and for qualified persons allowing them the use of their name.

Retainer and Authority.—A solicitor is employed by a Retainer (q.v.), which ought to be in writing to avoid after disputes. The exact authority differs in each cause, but includes power to compromise the dispute. If once employed in an action he has authority to manage it to the end. He is liable to his client for gross or crass negligence; he may often, but not always, protect himself by taking (and following) the advice of counsel. A solicitor is not allowed to make a gain for himself (save the ordinary profits of his profession) at his client's expense, so transactions between them, as sales of property, &c., are very narrowly looked into, nor can he generally take a gift from his client. He cannot be a justice of peace in the county where

he practises. He has no right of audience in the supreme court save in bankruptcy matters, and that only before the judge in bankruptcy or a divisional court of Queen's Bench. He has certain privileges. Thus, he cannot be made liable for statements honestly made by him as an advocate, and he cannot be forced to reveal written or oral communications made to him by his clients. He is privileged from arrest whilst attending the courts, but this is now of little importance, for it does not extend to punitive attachment.

Remuneration.—The remuneration of solicitors is carefully provided for by various statutes, but often in practice much less than the allowed rate is accepted and much more is exacted. The Solicitors Act, 1876, allows a solicitor to make an agreement in writing for a lump sum or otherwise in lieu of the regular fees. The agreement must be in writing signed by both parties to be binding on the client, but a verbal agreement is binding on the solicitor. The amount agreed on is not payable till the agreement has been examined and approved of by the taxing-master, nor can any action be brought on it. It is enforced by motion before or petition to the proper court. These provisions apply to contentious business. The Solicitors' Remuneration Act, 1881, provides, as regards non-contentious matters, that solicitor and client may agree as to any mode of remuneration. The agreement must be in writing and signed by the party bound by it; it may be enforced by action, and reviewed under any order for taxation. A solicitor winning a case is entitled to two sets of costs—(a) those between party and party; and (b) those between solicitor and client (extra-judicial expenses in the terminology of Scots law). The first are usually taxed as a matter of course; the other may be taxed on application of either party. A solicitor cannot sue (but may counter-claim) for his costs till one month after he has delivered a signed bill, and except under special circumstances taxation will not be ordered twelve months after delivery of bill. The costs of taxation are paid by the solicitor when more than one-sixth is struck off his charges; if less, the expense falls on the client (see FEES).

Solicitors' Lien.—A solicitor has at common law a twofold lien: (1) a general lien on all deeds and papers which have come to him in his professional capacity—but this merely gives him a right of retention till his claims are satisfied; (2) a particular lien (made more effectual by the Solicitors Act, 1860) on property recovered or preserved by his exertions. It may be actively enforced by means of a charging order, which the court will grant him on such property. Collusive agreements between the parties to deprive him of his rights will be set aside. He is not, however, allowed to retain papers so as to prejudice the trial of an action. He must give them up to be held subject to his lien. In Ireland the law is practically the same on this subject as in England.

Scots Law.—In Scotland the term solicitor is so extensively used as almost to have superseded the old designation of writer. The legal expression is Law-agent. This includes Writers to the Signet, Solicitors before the Supreme Courts, and Procurators in the sheriff courts. They must have served five years as indentured apprentices to a law-agent, have passed examinations in law and general knowledge, and been admitted by the Court of Session. Writers to the Signet, &c. have still certain privileges not here necessary to be discussed. In all cases stamp-duties are paid on admission. Law-agents have a preference, in the nature of hypothec, over expenses of process, and also a right, similar to solicitors' lien, to retain property in their hands.

See Cordery's *Law Relating to Solicitors*; Begg, *On Law Agents*; and E. B. V. Christian, *A Short History of Solicitors* (1897).

Solidity. See MATTER.

Solidungula. See HORSE.

Solidus, a Roman gold coin (see NUMISMATICS, Vol. VII. p. 552). The 'solidus aureus' was adopted by the Franks (at 87 to the Roman pound) till the time of Pepin, who suppressed it; but another solidus of silver, or 'solidus argenteus'—the $\frac{1}{20}$ th of the libra or pound—which had been used only as a money of account, was soon after made a coin. In later times this 'sol' or 'sou,' like all other coins, underwent an infinity of variations in fineness and value (see LIVRE). On the introduction of the decimal system (1793) into France the sou was abolished, and a piece of five centimes ($\frac{1}{20}$ th of a franc) substituted; but the name continued in common use, and the old sou was retained in circulation. The solidus also appears in the *soldo* of some parts of Italy, which was substantially the same as the sou. A trace survives in the s. of £ s. d.

Soliman. See SOLYMAN.

Solingen, a town of Prussia, situated 13 miles E. of Düsseldorf and not far from the river Wupper. Ever since the 12th or 13th century it has been famous for its steel and iron ware, especially for sword-blades, helmets, cuirasses, knives, scissors, surgical instruments, &c., which are exported to all parts of the world. These are made by the workmen in their own homes, and some 30,000 persons are employed in this industry throughout the district. Solingen has also iron-foundries, cigar-factories, &c. Pop. (1895) 40,843.

Solls, JUAN DIAZ DE, Spanish navigator, was born at Lebrija, between Cadiz and Seville, near the middle of the 15th century. He was sailing along with Pinzon when the latter discovered (1499) the mouth of the Amazon. In 1515 he himself was sent out, in command of three ships, to find a sea-passage through the American continent that should lead to the East Indies. This led to his discovery of the Paraná (i.e. the Rio de la Plata). But he suffered himself to be drawn into an ambuscade by the warlike Charruas, who dwelt on its banks, and was killed by them (1516).

Solitaire (*Pezophaps solitarius*), a bird allied to the dodo, and like it now exterminated. It lived on the island of Rodriguez, and was described by Leguat, a Huguenot refugee, who in 1691 settled with a small colony on the island. In his *Voyages et Aventures* Leguat describes the solitaire as a large bird, the male sometimes weighing 45 lb.; taller than a turkey, the neck a little longer in proportion, and carried erect; the head of the male without comb or crest, that of the female with something like a widow's peak above the bill; the wings small, and the bird incapable of flying, but using the wings to flap itself or to flutter when calling for its mate, or as a weapon of offence or defence; the bone of the wing thickened at the extremity so as to form a round mass about the size of a musket-bullet; a roundish mass of feathers instead of a tail; the plumage very full and beau-



Solitaire
(*Pezophaps solitarius*).

tiful. He says the bird is called *solitaire* because it is very seldom seen in flocks, and tells us that the bird is with difficulty caught in the forests, but easily on open ground, because it can be out-run by a man; and that its flesh is very good to eat. In 1865 Edward Newton visited Rodriguez and discovered abundant remains of the *solitaire*, from which he was able to confirm part of Leguat's description. Since Professor Newton's visit many more skeletons have been discovered, and the osteology of the bird is now well known. Reconstructed skeletons are preserved in the South Kensington Museum, in the Royal College of Surgeons, and in the Museum of the University of Cambridge. The figure here given is derived from a rude cut in Leguat's work. It has been shown that the Dodo (*Didus ineptus*) of Mauritius did not occur on Rodriguez; bones formerly referred to the dodo all belong to the slightly divergent male and female *solitaires*.

See Strickland and Melville, *The Dodo and its Kindred* (Lond. 1848); also Newton, *Phil. Trans. Roy. Soc.* (Lond. 1869); and *Proc. Zool. Soc.* (1875).

Solmisation. See SOLFEGGIO.

Solo, a term used in musical compositions of several parts, whether vocal or instrumental, to indicate a voice or instrument that is to perform alone or in a more prominent manner, as *soprano solo*, *violino solo*. The plural, *soli*, is used when two or more voices or instrumental parts are to be performed together, such parts, of course, never being doubled.—A composition for a single instrument accompanied is also termed a solo.

Solofra, a city of Southern Italy, 31 miles by rail E. of Naples, with important manufactures of parchment, &c. Pop. 5178.

Solomon (Salomon, Salomo, Suleimán, Solyman; Heb. Shelómó, from *shálóm*, 'peace,' and so meaning 'the Peaceful,' like Ger. Friedrich), the second son of David and Bathsheba, successor of the former on the throne of the Israelitish kingdom for forty years (1015-977 B.C.). See *Jews*, Vol. VI. p. 323. In later Jewish and Mohammedan literature Solomon appears not only as the wisest of men, but as gifted with power to control the spirits of the invisible world. As the builder of the Temple his name is much quoted in the literature of the Freemasons (q.v.). For the so-called Song of Solomon, see **CANTICLES**; for the other biblical works long attributed to Solomon, see **BIBLE**, **ECCLESIASTES**, **PROVERBS**. The *Wisdom of Solomon*, one of the books of the Apocrypha (q.v.), makes a claim, real or hypothetical, to have been written by Solomon, but from internal evidence it is obviously the work of an Alexandrian Jew, written in the period 150-50 B.C. The book is a hymn in praise of Wisdom—the Wisdom of Proverbs (q.v.), but containing approximations to the doctrine of the Logos (q.v.), and combines the ethical doctrine and speculation of the Hebrews with Platonic and Stoic philosophy. There are commentaries on it by Grimm (1860), Gutberlet (Münster, 1874), and Deane, *The Book of Wisdom* (1881). The *Psalms of Solomon*, also called the Psalms of the Pharisees, were apparently written in Hebrew by a Pharisaic Jew in Jerusalem about 70-40 B.C., and are a protest against modern corruptions. They are an imitation of the canonical psalms, and seem to have been known by the authors of much apocryphal and later Jewish literature. There is an edition of the existing Greek text, with a translation and notes, by Ryle and James (1892).

Solomon Islands, an archipelago in the western Pacific, belonging in part to Germany, in part to Great Britain. The islands lie 500 miles E. of New Guinea, and stretch south-eastwards in

two parallel chains for 600 miles towards the Santa Cruz group. The north-eastern chain embraces Bougainville, Choiseul, Ysabel, and Malaita; the south-western Vella Lavella, Kulambangra, New Georgia, Guadalcanar, and San Cristoval. Besides these, which vary between 70 and 110 miles in length, and are 20 to 30 in width, there are a number of smaller ones. They have a total estimated area of 15,000 sq. m.; are nearly all of volcanic formation, there being one active volcano and several quiescent and extinct volcanoes; and are covered from the seashores to the summits of the highest mountains (10,000 feet in Bougainville, 8000 in Guadalcanar, 4100 in San Cristoval) with dense tropical vegetation. There is an extraordinarily heavy annual rainfall, estimated by Dr Guppy at 400 and even 500 inches on the mountains, and 150 on the coasts. The atmosphere is consequently very moist; and the temperature ranges from 75° to 95° F. The people, stated to number 167,000, show decidedly Papuan or Melanesian characteristics; they are divided into a great number of tribes, constantly at war with one another, and are very suspicious towards strangers. Cruel and savage, they indulge in cannibalism, wear little or no clothing, and tattoo their bodies. Their religion is a kind of ancestor-worship, with attendant mysteries. Totem castes exist on Guadalcanar and some others of the islands. Yams, vegetables, and the cocoa-nut are the principal productions used as food. The fauna of the islands includes a phalanger (cuscus or flying fox), bats, gigantic rats and frogs, very large and very brilliant butterflies. This group was discovered by the Spaniard Mendaña in 1567. Then for two hundred years it was never visited by Europeans, and was virtually rediscovered (1767-88) by Carteret, Bougainville, Surville, Shortland, and other navigators.

See Guppy, *The Solomon Islands* (2 vols. 1887), and Woodford, *A Naturalist among the Head-hunters* (1890).

Solomon's Seal (*Polygonatum*), a genus of plants of the natural order Liliaceæ, differing from Lily of the Valley (q.v.) chiefly in the cylindrical tubular perianth, and in having the flowers jointed to their flower-stalks. There are three British species. The Common Solomon's Seal (*P. multiflorum*) is found in woods and copses in many parts of England and in a few places in Scotland. It has a stem about two feet high, the upper part of which bears a number of large, ovate-elliptical, alternate leaves in two rows. The flower-stalks are generally unbranched; the flowers not large, white, and drooping. The roots are knotty, and a transverse section of them reveals characters which the fanciful have imagined represent the impress of the famous seal of Solomon, to which very ancient legends attributed magical properties; the appearances on the cut root being variously described as looking like the 'marke of a seale,' like the magical Pentacle (q.v.), or like Hebrew letters. The Narrow-leaved Solomon's Seal (*P. verticillatum*) is a rare British plant, only found in a few



Angular-stemmed Solomon's Seal (*Polygonatum officinale*).

places in Scotland. The leaves are whorled. The Angular or Sweet-smelling Solomon's Seal (*P. officinale*) is also rare in Britain, and is found only in England. It more nearly resembles the Common Solomon's Seal, but is smaller, and has greenish, fragrant flowers. All these species are common in many parts of Europe. They are very similar in their properties. In America there is a *P. giganteum*, 2 to 7 feet high, and a smaller *P. biflorum*. The young shoots of *P. officinale* are eaten by the Turks like asparagus. The root is white, fleshy, inodorous, with a sweetish, mucilaginous, acid taste. It contains *Asparagin*. It is a popular application to bruises, to prevent or remove discoloration, and its use is well known to those who are too apt to get a black eye now and then. A kind of bread has been made of it in times of scarcity. The berries are emetic and purgative.

Solon, the famous lawgiver of ancient Athens, was born probably about 640 or 638 B.C., and died about 558 or 559. His father, Execestides, who traced his descent from the royal family of Attica, had squandered an ample fortune. His son became a trader, an occupation which at once brought him wealth and opened up rich stores of observation and experience to his inquiring mind. Doubtless to the wide extent of his travels must be ascribed that unprejudiced political genius by which he was to create a constitution such as had never existed in the world before. He was known also as a writer of graceful and amatory verses, but later his muse soared to a higher strain and sang the triumphs of his legislation and the blessing of the gods on his reforms. One of the finest of his elegies owes its preservation to its being quoted by Demosthenes in his *De Falsa Legatione* (sects. 286-289), 'to show (as he says) how Solon hated fellows like Æschines;' several quotations—one of twenty lines otherwise unknown—occur in Aristotle's *Constitution of Athens* (first edited from a papyrus acquired by the British Museum, by F. G. Kenyon, 1891). The Megarian war (610-600) saw the occasion of Solon's first political achievements. The sarcasms of his stirring Tyræan verse induced the desponding Athenians to continue the struggle, and Solon was placed at the head of an expedition to Salamis. Suddenly landing there, he drove out the Megarian garrison, and won the 'lovely island' for Athens; finally the dispute was settled by the arbitration of Sparta in favour of Athens. No story of antiquity is better known than that which tells how Solon attempted to influence the award by the insertion of a line in the *Iliad* (ii. 558), which speaks of the Salaminian Ajax ranging his ships with the Athenians. Solon's influence, already wide, was increased by the strong position he took up a little later in behalf of the Delphic oracle against its oppressors. But the unholy murder of Cylon still rested as a stain upon Athens; Nisæa and Salamis were again lost; and superstitious fears took hold of the people.

But the distress of Attica was not so much religious as economic. The particular grievance which brought matters to a head was the law of debt. The want of a middle class made the contrast between the opulence of the nobility and the indigence of the poor more glaring. A desperate conflict was imminent, when in 594 both parties concurred in inviting the poet and devoted patriot, Solon, to assume the archonship and pacify his distracted country. 'It is not the will of the gods that our city should perish,' sang the poet in noble numbers; 'it is the desire of gain which will bring us to ruin: the thoughts of our leaders are not honest, and their greed will bring great evils upon them. Many of the poor go into foreign lands, sold as slaves, and burdened with shameful bonds.' His

first measure was the famous *Seisachtheia*, and the remedy was severe. A limit was placed on vast accumulation of lands, the person of the debtor was safe whatever his obligations, all debts public and private were cancelled. The reform of the money-standard was made, with the view not so much of assisting debtors by reducing their debts (73 of the old drachmas were received into 100 of the new) as of simplifying trade with Asia Minor and opening up new fields for Athenian enterprise. Then the poet sang the end of his labours: 'Many citizens who had been sold into slavery I brought back to Athens their home; some of them spoke Attic no longer, their speech being changed in their many wanderings. Others who had learned the habits of slaves at home, and trembled before a master, I made to be free men. All this I accomplished by authority, uniting force with justice, and I fulfilled my promise.' On laying down office at the end of the year he was requested to reform the entire political constitution of Athens. Solon's object was to destroy the power of the Gentes, and give the poorest class some control over the officers and the law. On the division of the people into four classes, rated according to income, a division which our latest authority, the *Constitution of Athens*, assigns to Draco, his reforms were based. The first class (Pentacosiomedimni) were such as possessed an annual income of not less than 500 medimni of corn, the second class (Hippeis) were rated at 300, the third (Zeugitai) at 200, the fourth (Thetes) consisted of all below the Zeugitai.

On each of the four certain duties were imposed. The three highest provided the land army of Attica, while the Thetes, as rowers in the triremes, formed the most important part of the navy, one day to prove the salvation of Greece and the mainstay of the Athenian empire. The chief offices of state were restricted to the Pentacosiomedimni; the second and third classes were eligible for minor functions. If the Thetes were not admitted to office, their inclusion in the Attic tribes or phylæ, their new right of sitting in the Assembly, electing the public magistrates and passing sentence on their conduct at the end of their year of office, made them practically the sovereign power in the state; and Aristotle traces the swift development of Athenian democracy to the judicial powers received from Solon. The Boule of 400, another of the great lawgiver's creations, was formed by the election of 100 members from each tribe, and took the place of Draco's council of 401, of which we first learn also in the newly-discovered Aristotelian papyrus. The democratic nature of Solon's Council is proved by its subsequent history. The Areopagus continued as before to be the guardian of the laws and the public morals; it decided also on all grave criminal cases. If he did not originate it, Solon saw the wisdom of preserving and strengthening a body which, by its nature, comprised the best representatives of the highest class of citizens. 'It was,' says Æschylus, 'the bulwark of the land and city, the like of which no man had seen either in Scythia or in the island of Pelops; a council incorrupt, awful, and severe; a watchful guardian over those who slept.' The last of his political reforms was the institution of the Heliaea or popular court of law, the members of which were men of more than thirty years of age chosen annually by lot from every class. The object of its creation was to serve as a balance to the Areopagus, whose judicial supremacy might go too far in the interests of the aristocracy who composed it.

But Solon's work was not yet done. The laws of Draco were not suited to a more civilised age; not only was the severity of punishment for infringement out of all proportion to the

offence, but Draco's conception of law appeared inadequate to the comprehensive views of Solon, to whom the function of law was contained not less in directing the citizen's most intimate relations and arrangements than in the guidance of his political and public conduct. Solon's regulations ranged over every province of life. All Draco's laws were repealed except those relating to murder. A limit was placed on the quantity of land that might be held in Attica; no citizen could be enslaved for debt, and absolute freedom in bequeathing property was ensured to any citizen who died childless. Arbitrary power of fathers over their children was restrained and arbitrary disinheritance forbidden. Any citizen who maintained neutrality in a sedition lost his civic status. The Areopagus was empowered to deal severely with luxury in food and dress. No woman might leave home with more than three changes of clothing, or with a basket of more than a cubit's length, and excessive wailing at funerals was forbidden. The laws, inscribed on wood, were placed in the Acropolis, whence they were removed to Salamis during the Persian wars.

The later years of Solon belong more to legend than to history. We are told that he left Athens for ten years, after binding the Athenians by oath to observe his laws till his return. His travels took him far afield. Cyprus, Asia Minor, and Egypt, probably the scenes of his early career, were revisited. Historical investigation may deny the possibility of a dialogue between Solon and Cræsus, but cannot spoil the charm of a story which Herodotus has rendered immortal. The king, then at the height of his prosperity, was said to have asked him who was the happiest man in the world, expecting to hear himself named. Solon first mentioned Tellos, an Athenian who had died for his country at Eleusis. Nor could Cræsus obtain the second mention in the ranks of the happy; that place was assigned to two Argive youths, Cleobis and Biton, to whom the gods had given to die in their sleep as the reward of an act of filial piety. The wrath of Cræsus at the moment was unrestrained, but bitter experience taught him to appreciate the wisdom of Solon, and 'to account a prosperous man happy only when he ended his life as he began it.' Solon's meetings with Anacharsis and with Thales, one of the seven wise men like himself, were among the moral apologues of the ancients. The last years of Solon were passed at Athens, where the wild conflict of parties disturbed the application of the new constitution. He saw the failure of his plans with the deepest distress. His suspicion of his kinsman Pisistratus was justified by the issue. Again he entrusted his warnings to elegiac verse: 'Fools, ye are treading in the footsteps of the fox; can ye not read the hidden meaning of these winning words?' The protest was in vain; Pisistratus seized the government. The opposition of Solon continued; undeterred he laid down his arms before his door, and called heaven to witness that he had stood by his country. Retiring into private life he died soon after the usurpation of Pisistratus, with the last injunction that his ashes should be scattered over the island of Salamis, the 'lovely island' which had been the scene of his earliest exploit.

Solon died the subject of a despotic monarch. His labour might seem wasted, but its eclipse lasted only for a season, and even during the years of the tyranny of Pisistratus its influence was strong. Morally and politically a power among his countrymen, Solon saw that to imprison men in a relentless political machine like

Lycurgus, or to humble a refined aristocracy beneath a paid proletariat like Pericles, were policies equally dangerous. His constitution was a graceful compromise between democracy and oligarchy. In poetry he represents a high Ionian type; as a traveller and a soldier his experience of men was large. In the higher realms of constructive statesmanship he rivals the greatest legislators not only of Greece but of the world.

See the Greek histories of Thirlwall, Grote, Curtius, Cox, and Evelyn Abbott; for the poems, Bergk, *Lyrici Græci* (4th ed. 1878); also editions of the *Constitution of Athens*, by Kenyon (1891), Kaibel and Wilamowitz-Moellendorf (Berl. 1891), and Sandys (1893); and Eng. trans. by F. G. Kenyon (1891), Thomas J. Dymes (1891), and E. Poste (1891).

Solor Islands. See TIMOR.

Solothurn. See SOLEURE.

Solstice (Lat. *solstitium*, from *sol*, 'sun,' and *sto*, 'I stand'), that point in the ecliptic at which the sun is farthest removed from the equator, and where it is consequently at the turning-point of its apparent course. There are two such points in the ecliptic, one where it touches the tropic of Cancer, the other where it touches that of Capricorn. The former is the summer, and the latter is the winter solstice to those who inhabit northern latitudes, and *vice versa*.—The term is also employed to signify the *time* at which the sun attains these two points in its orbit, the 21st of June and about the 21st December.

Solution, the liquefaction of a solid or gas by contact with a liquid, the product being a homogeneous liquid called a solution. Like many other terms, 'solution' is difficult of exact definition, chiefly because of the loose manner in which it is employed. One liquid is said to *dissolve* in another when the solubility is limited; but when they are mutually soluble to any extent they are said to be *miscible*. Solution depends on the mutual attraction of the molecules of the bodies concerned. A distinction is made between *simple* solution and *chemical* solution. The solution of salt in water is an example of the former; of zinc in sulphuric acid, of the latter. In reality there is

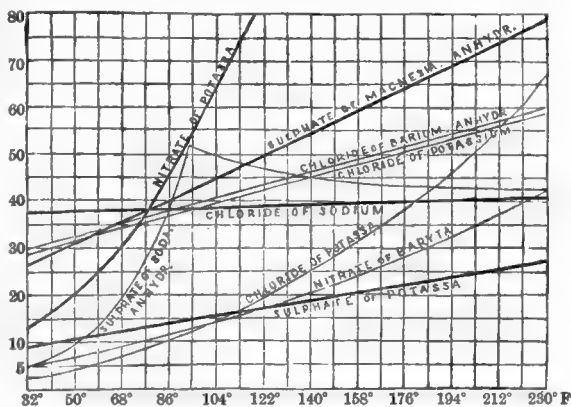

only the one form of solution, though it may be preceded by chemical action, as in the conversion of the zinc into sulphate. In some cases a solid is soluble in a liquid to any extent—i.e. the solid may be continuously dissolved in the liquid until the solution becomes viscous or semi-solid. This, however, only occurs with certain amorphous compounds. In the great majority of cases (certainly with all crystalline bodies) there is a definite limit to the solubility, which varies according to the temperature. When a liquid has taken into

solution as much of another body as it is capable of dissolving, the solution is said to be saturated. If two or more salts are treated with water at the same time, a proportion of each is dissolved, but the amount of each salt dissolved is less than if the same had been added to the water singly, and is less the greater the number of salts dissolved. As a rule, though not invariably, the solubility increases as the temperature rises. The accompanying diagram shows the unequal solubility of various of the more common salts in water of different temperatures. The lines of solubility cut the verticals raised from points indicating the temperature upon the lower horizontal line at heights proportional to the quantities of salt dissolved by 100 parts of water. Solution is of great service in chemical and manufacturing processes. By the difference in the degree of their solubility we can separate one substance from another, and by dissolving a body we can purify it by filtration or crystallisation.

Solway Firth—in its upper part best regarded as the estuary of the river Esk, in its lower as an inlet of the Irish Sea—separates the north-west of Cumberland from the south of Scotland. Its entire length, until lost off Balcarry Point in the Irish Sea, is 36 miles; its breadth for the first 13 varies from $1\frac{1}{2}$ to $8\frac{1}{2}$ miles, but afterwards it gradually, although irregularly, increases to 22. The principal rivers flowing into it, besides the Esk, are the Annan, Nith, Dee, and Urr from the north or Scottish side, and the Eden and Derwent from the south or English side. The most striking feature of the Solway Firth is the rapidity with which its tides ebb and flow. The spring-tides are peculiarly swift and strong—the bore rushing in from 3 to 6 feet high, and at the rate of 8 to 10 miles an hour, occasionally inflicting serious damage on the shipping; while after it has retreated great stretches of the bed of the firth are left bare, and in some places one can even cross over from the English to the Scottish shore. The salmon-fisheries of the Solway are valuable. Near Annan the Solway is spanned by a railway viaduct, 1960 yards long, which, originally constructed in 1866-69 at a cost of £100,000, was almost destroyed by floating ice in January 1881, but was reopened to traffic in 1884. Scott paints the scenery of the Solway Firth in both *Guy Mannering* and *Redgauntlet*.

The *Solway Moss* is a district of Cumberland about 7 miles in circumference, lying west of Longtown, and immediately adjoining Scotland. As its name implies, it was once a bog, but is now drained and cultivated. It is historically notable as the scene in November 1542 of the rout of a Scottish host under Oliver Sinclair by a handful of English borderers under Thomas Dacre, the 'Bastard of Lanercost,' and Jack Musgrave of Bewcastle—a disaster which broke the heart of James V. (q.v.), and which forms the theme of an interesting article by Mr W. Manson in *Transactions of the Cumberland Antiquarian Society* (vol. viii., Kendal, 1886). Here, too, on 13th November 1771, an extraordinary disaster occurred. The boggy ground, surcharged with moisture—the effect of heavy rains—rose, swelled, and burst like a torrent, sweeping along with it trees and houses, and destroying some thirty small villages.

Solyman, or SULEIMAN II., surnamed 'The Magnificent,' the greatest of the Ottoman sultans, was born in 1496, and at twenty-four succeeded his father Selim I. His first care was to refund a large amount of property that had been unjustly confiscated, his next to remove incompetent and corrupt officials, and to begin a comprehensive scheme of internal reform. But before this task was completed he led an army into Hungary, to extort the

tribute that its king refused to pay him at his accession. He took Schabatz, Semlin, and Belgrade (1521), and left Turkish garrisons in them. Then he carried a very formidable army to attack the Knights of St John at Rhodes; they had beaten off a Turkish army with a loss of 25,000 forty years previously. On this occasion they inflicted a loss of nearly four times that number upon the Turks before surrendering (1523) after a six months' siege. The following three years were devoted by Solyman to the internal government of his domains. But in 1526 he again led a force of 100,000 men into Hungary, slew King Louis at Mohacs (29th August) and all but annihilated his army, and pushing on farther captured both Buda and Pesth. He was recalled by tidings of an outbreak in Asia Minor. By 1529, however, he was back again in Hungary, ostensibly as the supporter of John Zapolya, who claimed the crown of Hungary against Ferdinand of Austria. Ferdinand was turned out of Buda and driven back into Vienna, which city the sultan besieged (September to October). After delivering a desperate assault, which cost him 40,000 soldiers, he was obliged to retreat without taking it. Returning home he directed his arms against Persia, and conquered (1534) large portions of Armenia and Persia proper, including the strong cities of Tabriz and Bagdad. At the same time he sent out his fleets against the Christian powers of the Mediterranean, and his lieutenants (Barbarossa, Piyala, and others) conquered the whole of the north of Africa except Morocco—Egypt was his already. But Tunis was recovered by Charles V. in 1535. In 1542 the widow of John Zapolya appealed to Solyman to aid her son against Ferdinand. Solyman allowed the young prince to retain Transylvania, but Hungary he kept for himself. Six years later a truce was made between the Turks and imperialists, Solyman being left in possession of the greater part of Hungary and Transylvania, and being granted a yearly tribute of 50,000 ducats. In 1565 the fleet and army of Solyman sustained a severe reverse in an unsuccessful attempt to reduce Valetta, the headquarters of the Knights of St John in Malta. And in the following year, whilst besieging the small fortress of Szigeth in Hungary, the great sultan died (4th September). Solyman is equally renowned as a lawgiver and just ruler, as a patron of learning and an encourager of the fine arts.

Soma is the name of a god worshipped by the Aryan Indians in Vedic times, as well as of a certain plant, and its juice used for the preparation of an intoxicating drink. The word is most probably derived from the root *su* (cf. *śu*), 'to press out,' 'distil,' and thus originally meant 'extract.' The Soma cult, with its copious libations and potations of the sacred beverage, is not confined to India, but was already a prominent feature of the religious system of the Indo-Iranians; the old Persian *haoma* sharing all the characteristics and uses of the Indian *soma*. In his divine form Soma is conceived of as a powerful deity of a fiery and luminous nature, the inspirer of heroic deeds of arms, as well as of the flights of fancy and song, the bestower of health, long life, and even immortality. Indeed, in accordance with his physical origin, this fiery deity is at the same time the *amrita* (ambrosia), or the drink of immortality, alike for gods and men. At the Soma sacrifice, therefore, not only are libations of Soma juice made to the principal deities, but the sacrificer himself and the priests freely partake of the potent liquor. Among the celestials it is especially the god Indra, the *Jupiter pluvius* of the Vedic pantheon, with whom Soma stands in close connection; the ever welcome draughts of the fiery juice supplying him with the requisite strength

and nerve for battling with the demons of drought and darkness. In the later Vedic literature Soma appears completely identified with the moon; this luminary in its varying phases being considered as the vessel containing the celestial supply of Soma juice on which the gods subsist, and which consequently requires periodical replenishment. Whilst this notion was formerly regarded as merely a secondary development of Indian mythology, recent research suggests that the identity of Soma with the moon may after all hold good for the whole of the Vedic times, if not also for the Indo-Persian period. The conception of a heavenly receptacle of the Soma juice forms, however, only one part of the Vedic Soma myth, which, indeed, pictures the god in all the various forms which the earthly Soma undergoes, from the time when the golden-stalked plant is brought down from its mountain-home till the final consummation of the Soma cup, as the 'supreme offering.' For his regeneration Soma descends periodically to the earth, either in the shape of the heavenly plant carried off by an eagle (probably the lightning) from his jealous demon keepers, or in the form of the fiery germ received by the cows or waters of heaven, and carried down by them to the earth, there to be taken up and matured by the plants springing up luxuriantly after the rains. The question as to what particular plant may claim to be regarded as the true Soma or 'moon-plant' is surrounded with difficulties; probably, however, the stems of several varieties of *Asclepiads*, akin to the common milk-weed, such as *Asclepias acida*, *Sarcostemma brevistigma* or *viminale*, and *Periploca aphylla*, all of them containing a rich, milky juice, were used for this purpose. The Brahmans of the Deccan, as well as the Parsees or fire-worshippers of Kerman and Yezd in Persia, and those in Bombay, make use of this day of different species of this genus. The Soma sacrifice, as practised in the later Vedic times, is surrounded by a complicated ceremonial of great solemnity. Sixteen priests officiate at its performance. A feigned purchase of Soma plants for a cow, at the conclusion of which the low-caste vendor is beaten off the sacrificial ground with sticks, is apparently a symbolical representation of the acquisition of the Soma by the gods from the demons. The bundle of Soma plants is henceforth treated as the veritable King Soma: he is driven in a car in state to the sacrificial hall, where he is placed upon a throne-seat, a guest-meal being then provided for him, and a solemn covenant concluded between him and the sacrificer. The Soma juice is subsequently obtained by means of two pressings; and the libations are made at three different services, the morning, mid-day, and evening service. The ninth book of the *Rigveda-sankhitā* consists of over a hundred hymns composed for the special purpose of being recited in honour of *Soma pavamāna*—i.e. of the Soma juice, whilst fermenting and 'clarifying.' Animal offerings form a necessary part of the Soma sacrifice.

For further details, see Eggeling, *Translation of the Satapatha Brāhmana*, vols. ii. and iii. (in the Clarendon Press series of Sacred Books of the East). On the divine personality of Soma, cf. J. Muir, *Original Sanskrit Texts*, vol. v.

Somaliland, an eastern projection of Africa, washed by the Gulf of Aden on the north and by the Indian Ocean on the south-east; the western boundary may be defined by a line drawn south from Zeyla, on the Gulf of Aden, through Harar to the River Jub or Juba. Besides this river the only considerable stream is the Webi-Shebeyi, which, however, does not reach the Indian Ocean, its waters being lost in the sands near the southern extremity of the region. The country is apparently

an undulating plateau, in very many parts parched and barren; though in the rainy seasons (two of two or three months' duration each) numerous swamps are formed. Game and wild animals—elephant, hippopotamus, lion, leopard, crocodile, antelopes, water-buck, monkeys, ostriches, vultures, marabout storks, &c.—are generally plentiful. The vegetation is on the whole arid, though in suitable localities there grow luxuriant grasses, mimosas, acacias, gum-bearing trees, palms, sycamores, cactus, aloe, and others. The inhabitants, the Somal, numbering probably half a million, are for the most part a pastoral people, who lead the life described as characteristic of the Old Testament patriarchs. They have herds of camels, sheep, and oxen, and keep horses and goats. Fond of liberty and warlike, they are ruled by a number of petty chiefs, and are jealous of strangers entering their territory (on which account it is almost wholly unknown); nevertheless, they are said to be a light-hearted, merry, affectionate race, though quick-tempered, and in their wrath savage and cruel. They are Mohammedans in religion. Ethnically they belong to the Hamitic stock, and are closely akin to the Galla and the Abyssinians; but they are not a pure race, for there is a strong blending of Semitic (Arab) blood in them, and easily discernible traces of Negro as well. What trade there is in the natural products (myrrh and frankincense, hides, ostrich-feathers, coffee, salt, &c.) finds an outlet through the ports on the coast, principally through Berbera and Zeyla on the shore of the Gulf of Aden.

The Somali coast protectorate of Britain extends from Ras (Cape) Jibuti, on the west of Zeyla, to Ras Hafun, south of Cape Guardafui, and includes the towns of Zeyla, Berbera, Bulhar, and Karam. The cattle, sheep, hides, ostrich-feathers, gums, &c. exported reach an annual value of £600,000. Annexed by Egypt in 1875, this territory has been under British protection since 1884; delimited by arrangements with Italy (1894) and Abyssinia (1897), the protectorate has 68,000 sq. m. area.—The French call Obock (q.v.), &c., *Côte des Somalis*.

See F. L. James, *The Unknown Horn of Africa* (1888); Wolverton, *Five Months' Sport in Somali-land* (1894); Swayne, *Seventeen Trips through Somaliland* (1895); Donaldson Smith, *Through Unknown African Countries* (1897); E. N. Buxton, *Short Stalks* (1898); F. B. Pearce, *Rambles in Lion-Land* (1898); and for the (non-Bantu) Somali language, the grammar and English-Somali dictionary of the Franciscans Larajasse and Sampont (1898).

Sombreréte, a town of Mexico, 105 miles NW. of Zacatecas, famous for rich silver-mines. Pop. 5200.

Sombrero (Span. *sombra*, 'shade'), a broad-brimmed felt hat common in parts of America.—For Sombrerite, see APATITE.

Somers, SIR GEORGE (1554–1611), an English navigator, born at Lyme Regis, whose shipwreck on the Bermudas (q.v.) led to their colonisation from Virginia by him in 1611.

Somers, JOHN, LORD, Whig statesman, was born at Worcester, an attorney's son, on 4th March 1652, and in 1667 entered Trinity College, Oxford, in 1669 the Middle Temple, being called to the bar in 1676. Associated with the 'Country party,' he was one of the counsel for the Seven Bishops (1688), and from the Revolution onwards took a prominent part in politics, being returned for Worcester to the Convention parliament, and successively made Solicitor-general, Attorney-general, and Lord Keeper of the Great Seal, until in 1697 he became Lord Chancellor, and was raised to the peerage as Baron Somers of Evesham. He was William's most trusted minister, and as such was the object of frequent attacks, one of which in

1700 resulted in his being deprived of the seal, and another in 1701 in an impeachment by the Commons, rejected, however, by the House of Lords. He returned for two years to power as President of the Council (1708-10), and died of apoplexy, 26th April 1716. The *Somers Tracts* (16 vols. 1748), a valuable collection of state papers from his library, were re-edited by Sir Walter Scott (13 vols. 1809-15).

Somersby, a pretty village of Lincolnshire, stands on the Wolds, about 7 miles E. by N. of Horncastle and the same distance N.W. of Spilsby, and is celebrated as the birthplace of Tennyson. The rectory, in which he was born, is an ordinary country parsonage, not without touches of picturesque-ness. Pop. 43. Illustrations will be found in J. C. Walters, *In Tennyson Land* (1890).

Somerset, DUKES OF. See SEYMOUR. For the Earl of Somerset, see OVERBURY.

Somerset House, London, fronting both on the Strand and on the Thames Embankment, stands on the site of a palace built by the Protector Somerset about 1549, which fell to the crown on Somerset's execution. The original edifice was pulled down and rebuilt in 1776-86, after designs by Sir William Chambers, in the Palladian or Italian style. The building accommodates the offices of the Audit and Exchequer, Inland Revenue, Wills and Probate, and the Registry-general of Births, Deaths, and Marriages for England and Wales. The east wing, built in 1828, accommodates King's College and School.

Somersetshire, an important maritime county in the south-west of England, is bounded on the N. and W. by the Bristol Channel (the ancient 'Severn Sea'); by Gloucestershire, Wiltshire, and Dorsetshire on the NE. and E.; and by Devonshire on the S. and SW. In form oblong, with a length of some 80 miles and a breadth of 36, it has an area of 1640 sq. m. Pop. (1801) 273,577; (1841) 435,599; (1881) 469,109; (1891) 484,336. The surface is exceedingly diversified, with every variation from lofty hills and barren moors to rich vales and wide marshy levels, whence the sea is banked out by an elaborate system of dykes and sluices. The frontier between Somerset and the adjacent counties consists for the most part of a broken and picturesque hilly district. Sundry ranges of hills, running east and west, give to the county its leading physical characters. Chief of these is the Mendips (q.v.), which stretch from near the city of Wells to the coast at Brean Down, with a seaward continuation in the islets of the Steep and Flat Holms. South of the Mendips lies the great alluvial plain of central Somerset, broken by the line of the Polden Hills, which rise from the marshy levels like a long low island some 300 feet. Still farther south, beyond Taunton, are the Black-down Hills, about twice this elevation, and continuing eastward into the broken upland which once formed part of the ancient forest of Selwood, where Somerset, Wilts, and Dorset meet. To the north-west of Taunton, bordering Bridgwater Bay, are the Quantock Hills, rising at Will's Neck to 1262 feet; and west, again, is the wild district of Exmoor Forest (q.v.), partly in Devon, but mainly in Somerset. At several points on the inland borders heights of between 800 and 1000 feet are attained. The only two rivers of commercial importance in Somerset originate elsewhere. The Bristol Avon, which forms the boundary of the county for many miles, rises near Badminton in Wilts, and enters Somerset near Bath. The Parret rises near South Perrot in Dorset, and drains the middle of the county: it is tidal to beyond Bridgwater, and is one of the streams possessing a tidal 'bore.' These two rivers with their feeders dis-

charge the bulk of the waters of the county. Between them the chief independent streams are the Axe and the Brue, south of the Mendips, and the Yeo, north. The Exmoor district is drained by the Exe, which falls into the sea at Exmouth, and by the Devonshire Axe, which rises, however, in Dorset.

The geological features of the county are singularly varied, ranging from Devonian upwards. Carboniferous strata occupy a wide area in the north, east, and centre, and are worked for coal in the Radstock and Nailsea basins of the Bristol coal-field; while the mountain-limestone is largely developed in the Mendips and near Bristol, where it is traversed by the magnificent gorge of the Avon. Oolitic rocks stretch along the east of the county from Yeovil to Bath, and in the neighbourhood of the latter city are extensively worked for the production of the well-known Bath building-stone; while other beds are wrought at Doulting and Ham Hill. Liassic rocks are well developed, chiefly in the central region, though in somewhat scattered fashion. Triassic rocks occupy a very wide area in the west of the county, ranging with breaks from Wellington to Bristol; and there is Greensand on the extreme south-west. Extensive caverns in the limestone of the Mendips have yielded abundant remains of prehistoric mammalia, with relics of their human contemporaries. The Mendip mining area is one of the oldest in the kingdom, for lead was raised there before the advent of the Romans, and the iron ores of the Brendon Hills, on the eastern flank of Exmoor, were also worked at a very early date.

The agriculture is mainly pastoral, the proportion of tillage to grazing and dairy-farming being small, though the low lands generally are exceedingly fertile—the fertility of the valley of the Tone, near Taunton, having passed into a proverb. Even this is exceeded by the luxuriance of the marshy meadows of the Bridgwater Level, which are, however, liable to be flooded, and are maintained against the sea at considerable expense. The orchards of Somerset are second only to those of Devon in area and importance, and cider is largely made; while Cheddar cheese has a national reputation. Manufactures maintain considerable importance, particularly in textiles (chiefly woollens), potteries, paper-making, and gloving; and though the city lies mainly on the Gloucestershire side of the Avon, and is a county to itself, Somerset may fairly claim a share also in the commercial importance of Bristol (q.v.).

The bone-caves of the Mendips have supplied evidence of the presence in Somerset of neolithic if not of palæolithic man; and there is abundant evidence of the occupation by strong and comparatively civilised tribes prior to the Roman invasion in the remains of important hill fortresses (Hamdon, Castle Neroche, Dolbury, Maesbury, Worlebury, Cadbury), while the megalithic circles and other remains at Stanton Drew are among the most interesting in the kingdom. Immediately prior to the Roman invasion under Claudius the north of the county was inhabited by the Belgæ, while the territory of the Dumnonii seems to have extended over the Devon border to the marshy and central district, which probably formed a strong natural frontier, though there is evidence that part of this area had been embanked against the sea in pre-Roman times. The Mendips must, however, have formed part of the earliest Roman conquest, as pigs of lead have been found there bearing the names of Claudius, Britannicus, and Vespasian. Somerset became one of the chief seats of Roman civilisation in Britain. Bath (q.v.), as the city of *Aquæ Solis*, was a centre of refinement and luxury. The remains of the baths built by the Romans far-

the reception of the famous mineral waters are among the most important relics of the Roman period in England. But the impress of the Roman has been left in nearly every part of the county—in villas, roads, pottery kilns, interments, and coins; while Ilchester, like Bath, was a Roman city. Tradition claims for Glastonbury (q.v.) the honour of being the first seat of Christianity in Britain. Under the Saxons the district became known as the home of the Somerset, and took its present name, the origin of which is disputed. Part first came under Saxon sway in 658, but its inclusion in Wessex was not complete until 710, when Gerente was defeated by Ine, who made Taunton (q.v.) his chief fortress, and founded the cathedral of Wells (q.v.), which became the seat of the bishopric of the Somersætas (since Bath and Wells) in 909. Somerset was the last home of Saxon freedom when Alfred took refuge at Athelney, defended by trackless marshes. It was at Wedmore that Alfred made his treaty with Guthrum, though the claims of Edington to be the Æthandune where he won his most memorable victory are doubtful. In the wars of the Roses Somerset was in the main Lancastrian; in the wars of the Commonwealth it was chiefly parliamentary, and the stout defence of Taunton first made famous the name of Admiral Blake. The county was also the centre of Monmouth's operations; and it was chiefly Somersetshire men who fell at Sedgemoor (1685). The county has two cities—Bath and Wells; parliamentary boroughs in Bath and Taunton; an important manufacturing port in Bridgwater; one of the finest watering-places on the western coast in Weston-super-Mare; manufacturing towns in Frome, Yeovil, Shepton Mallet, and Wellington; and seven county parliamentary divisions.

See Collinson, *Somerset*; Phelps, *Somerset*; Rutter, *Delineation of the N.W. Division of Somerset*; *Proceedings of Somersetshire Archaeological and Natural History Society*; Jeboult, *W. Somerset*; Pulman, *Book of the Aze*; Eyton, *Somerset Domesday*; Hugo, *Medieval Nunneries of Somerset*; W. A. J. Archbold, *The Somerset Religious Houses* (Camb. 1892); Martin, *Somerset*; and numerous histories cited at Bristol, Bath, Taunton, Wells, Glastonbury, and other towns.

Somers' Islands. See BERMUDAS.

Somerville, a city of Massachusetts, a suburb of Boston, 2 miles from the central station. It has many handsome residences, contains tube-works, bleaching-works, and large slaughter-houses, and manufactures flour, leather, iron, oil, bricks, &c. Pop. (1880) 24,933; (1890) 40,152; (1900) 61,643.

Somerville, MRS MARY, a lady famed for her mastery of mathematics and physical science, was the daughter of Admiral Sir William Fairfax, and was born on 26th December 1780 at Jedburgh in the manse of her uncle and future father-in-law, Thomas Somerville, D.D. (1741-1830), the author of *My own Life and Times*. She was brought up at Burntisland and Edinburgh, amid somewhat narrow family circumstances. It was in an algebraic sum in a magazine of fashions that she first made acquaintance with the subject that most engaged her attention in after-life. In 1804 she married a cousin, Captain Greig, of the Russian navy, Russian consul in London. He died in 1806, and it was not till her return north as a widow that she was free to buy the books she wanted, and to study the subject that most interested her. In 1812 she married another cousin, Dr William Somerville, inspector of the army medical board, who entered warmly into all her ideas. They removed to London in 1816, where Mrs Somerville went much into society, and became known as possessed of scientific interests and gifts. In

1823 she was invited by Lord Brougham to try to popularise for the English public Laplace's great work, the *Mécanique Céleste*; and the *Celestial Mechanism of the Heavens* (1830) was received with the greatest admiration. Mrs Somerville was awarded a royal pension of £300 in 1835. Other works by her were *The Connection of the Physical Sciences* (1835), *Physical Geography* (1848), and *Molecular and Microscopic Science* (1866). Mrs Somerville, who for many years resided in Italy, died at Naples, 29th November 1872. An autobiography, edited and supplemented by her daughter, was published in 1873. After her is named Somerville Hall, a college for women at Oxford (1879).

Somme, a river of northern France, rises not far from St Quentin in the dept. of Aisne, flows in a south-west, then north-west direction, and after a course of 150 miles falls into the English Channel not far from St Valéry. It is navigable for vessels of 300 tons up to Abbeville (q.v.), and its upper course is canalised.—*The department of Somme*, in the north of France, formerly part of the province of Picardy, touches the English Channel on the north-west. Area, 2378 sq. m. The dept. is level, very fertile, and amongst the best cultivated districts of France. Much cider is made and poultry reared. The textile industries (wool, cotton, linen, hemp, silk spinning, and the weaving of mixed stuffs, cloth, velvet, carpets) give the principal mechanical employments; but there are also large iron-foundries, lock, soap, candle, chemical, paper, and beet-root sugar factories, distilleries, and breweries, employing in all nearly 70,000 hands. There are the five arrondissements of Abbeville, Amiens, Doullens, Montdidier, and Péronne; chief town, Amiens. Pop. (1872) 557,015; (1891) 546,495.

Somnambulism (Lat. *somnus*, 'sleep,' *ambulo*, 'I walk') is a disorder of sleep. It is symptomatic of more or less activity in some of the psychical and motor areas of the brain, while the centres that preside over consciousness are slumbering soundly. There are different forms, as sleep-crying, sleep-talking (somniloquy), and sleep-walking. These all involve sensori-motor acts.

Sleep-walking is closely related to hysteria and epilepsy, and it occasionally alternates with these and allied diseases. It occurs mostly in youth, affecting males and females in almost equal proportion; commonly, although not invariably, it disappears when adult age is attained. It is met with chiefly in persons of nervous temperament, and in those who have an inherited proclivity to neurotic disease. The exciting causes embrace mental excitement, overwork, fright, bodily fatigue, hepatic and digestive disorders, worms, and an overloaded bladder, and in females uterine and ovarian troubles. Sleep-walking is one of the neuroses of deep sleep. It occasionally presages graver maladies; generally these may be prevented by suitable treatment. It is important to recognise that it is a pathological state, and that no one who is in perfect health walks in his sleep. Sleep-walking is an acted dream, which generally supervenes when sleep is deepest—often during the first deep sleep. The dreamer usually stages it so precisely that he is able to act it with admirable exactness. In the first visitation the dream may be simple, and merely impel the sleeper to rise from bed to walk round the room and then return to bed. Eventually the dreams become more elaborate, and may embrace many complex operations, in which the individual has to elude articles of furniture, unlock doors, open windows, walk along dangerous roofs, or beside the edge of precipices—in short, perform feats he could not possibly execute in his waking moments.

Sleep-walkers have achieved the most diverse exploits without awaking. They have swum across rivers, thrashed corn, ridden on horseback, and even transacted their usual daily work. They are oblivious to danger, and untrammelled by fear; this, combined with an exaltation of muscular sense, enables them to effect their movements precisely and quickly. Their feats, however, are sub-conscious, and not, as it is popularly supposed, superhuman. Their senses, which are not connected with the dream, slumber; they do not see, hear, or smell, so they perform with their eyes shut as well as open, and they may be shaken, and may themselves cough and sneeze without being awakened. A certain degree of anæsthesia appears to render them insensitive to pain. After the dream-act is ended the sleeper returns to bed, to sleep until the usual hour for rising, and when he awakes he either does not recollect anything about his escapade, or remembers it only as a dream. Most frequently he recollects it in a subsequent sleep-walk, just as some dreams are only remembered in recurring dreams. Sleep-walking leads the actor into situations which endanger life, and annually many deaths are recorded from fatalities so arising. If the sleep-walker be awakened at a critical moment, coolness and precision are replaced by agitation and fright, and movements become halting and clumsy, and accident usually follows. Many tragedies have been enacted in this state, and these are of great forensic interest. From every point of view sleep-walking is a source of much anxiety to the afflicted and his relatives.

A sleep-walker found in his wanderings ought not to be awakened, but led back to bed as gently as possible. Abrupt awakening may give rise to shock, and may mark the onset of grave nervous disorders. Whilst it is always advisable to seek medical advice, it may be indicated that the general health should be attended to, so that it may be improved; and all exciting causes should be remedied or avoided, as, for example, all undue excitement and fatigue of mind and body. The sleeping conditions require consideration; in some cases it is advisable that some one should sleep in the same room. Occasionally, it is advantageous to awaken the sleeper at the end of the first hour of sleep, when it is deepest, to prevent it becoming too profound. Hypnotism is sometimes called artificial somnambulism. See the works and articles cited at SLEEP.

Somnath, an ancient town of Gujarat, in India, is situated on the south-west coast of the peninsula of Kathiawar, with a population of 6644, mostly Mohammedans. The town is defended by a strong fort and by a trench cut in the solid rock. It contains many ruins and memorials of Krishna, who died and was buried close by. Not far from the town stand the ruins of the celebrated Hindu temple of the idol Somnath. Its great sanctity and the fame of its enormous wealth attracted the imagination and avarice of the sultan Mahmud of Ghazni (1024). He took the temple after a desperate defence by its guardians, destroyed the sacred idol, and carried off its stores of jewels, and (according to the tradition) the wonderful temple gates. It is, however, more than doubtful whether the 'gates of Somnath' which Lord Ellenborough brought back from Afghanistan in 1842, and purposed to have restored to Somnath after having carried them in solemn procession through great part of Northern India, really are the gates of the ancient temple beside the Arabian Sea in Kathiawar. The gates that were brought from Afghanistan, and eventually placed in the arsenal of Agra, are made of cedar and richly carved, and measure 11 feet in height by 9 feet 6 inches in width.

Sonata, a musical composition usually of three or four movements, designed chiefly for a solo instrument. Before the 17th century the overwhelming tendency of musical development had been to increase by every possible device the vocal resources of the art, a culminating point being reached in the works of Palestrina and the school of madrigal writers. Instrumental music had been represented for the most part by dance tunes which had no great formal development, whilst the early attempts at opera relied almost entirely on the vocal element for their effect. In fact, abstract music, independent of external impressions and deriving all its interest from intrinsic qualities, was up to this time unknown. Some very early sonatas, published at Venice in 1624, consisted of a single movement; but the principle of a succession of contrasted movements, as in the case of the suite, was eventually established, all existing musical forms being pressed into service to secure its fulfilment. Thus, the 'first movement' consisted of a kind of canzona, imitated from a choral form kindred to the madrigal; the declamatory recitative of the opera was the source of the 'second movement'; and the remaining portions of the sonata were founded on dance-rhythms. Its progress tended towards emancipation from originating influences, whereas the suite adhered closely to dance forms. To secure for each movement structural balance and diversity of material additional 'subjects' were introduced, and the several portions were divided into 'sections,' balanced and contrasted both as to melody and key; whilst, as to time, the alternation of quick and slow movements became a recognised principle. Corelli and other writers of his school wrote sonatas chiefly for the violin, the genius of Handel and Bach being also employed in the same field. The improvements effected in the construction of the harpsichord and clavichord at length obtained for the a due measure of attention from Domenico Scarlatti and C. P. Emanuel Bach, whose complete mastery of these instruments enabled them to write clavier-sonatas with the happiest effect. The subsequent efforts of Haydn and Mozart brought the form of the sonata to great perfection of elegance and symmetry, a result to which Clementi and Dussek also contributed. But the acme of development was reached by Beethoven, who infused into the somewhat mechanical forms of his predecessors the spirit of human emotion. Under him the different parts of the sonata, instead of being mere adjacent sections, became items of one complete organic whole. The progression of his thoughts constituted a work of art, a poem in sound, in which, while the idea was paramount, the form was more or less veiled, the perfection of the whole resulting from a true and just balance between the two. Weber and Schubert continued to employ the old model, but with them its rules and restraints gradually gave way before the growing importance of the idea. At a later period Schumann attempted a compromise by means of ingenious devices, and Brahms in two early pianoforte-sonatas had worked along similar lines; while notable composers of the present day are still trying to extend the limits of sonata-form in conformity with modern tendencies. See the article by Dr C. Hubert H. Parry in *Grove's Dictionary of Music*.

Sonderbund, a union of the Catholic cantons of Switzerland (q.v.), which led to civil war in 1845.

Sonderburg. See ALSEN.

Sondershausen, the chief town of the German principality of Schwarzburg-Sondershausen (q.v.), pleasantly situated on the Wipper, 34 miles by rail N. of Erfurt. It has a large castle. Pop. 6336.

Sondrio, an Italian town, capital of a province, on the Adda, 25 miles E. of Lake Como; pop. 3989.

Song, a short poem, adapted for singing, or set to music. A song generally turns on some single thought or feeling simply expressed in a number of stanzas or strophes (see LYRIC, BALLAD, POETRY, and the articles on the great song-writers). The music to which it is allied should serve to add force and clearness to its meaning with or without the assistance of an instrumental accompaniment. The vast stores of simple ballads, of which various nations in time became possessed, are known as 'folk-songs' (*volkslieder*), as being the unstudied outcome of their popular tastes, feelings, and aspirations. In the modern 'art-song' (*kunstlied*) the cultivated instincts of the musician are brought to bear upon the utterances of the poet. The range of this class of song is extremely wide, and includes examples resembling the folk-song in simplicity, as well as those of a more ambitious character, which for adequate interpretation often depend very largely on the accompaniment, the voice part sometimes consisting of little more than declamation of words whose meaning is further conveyed by instrumental devices. Between these two extremes every variety and combination of treatment is displayed, some songs being strophic in form, the same melody serving for each stanza, whilst others are 'composed throughout,' both melody and accompaniment changing in sympathy with the narrative and sentiments expressed by the words. The pinnacle of perfection in song-writing has been reached by German composers, and pre-eminently by Schubert, Schumann, Brahms, and Loewe. Among celebrated English composers of song music may be named Henry Lawes, who very early excelled in the art of setting words with due regard for accent and emphasis; Henry Purcell, the greatest among English song-writers; with Carey, Arne, and Boyce. To these must be added Dibdin, famous for his 'Tom Bowling;' Davy, whose memory is kept green by his 'Bay of Biscay;' John Braham, who wrote the 'Death of Nelson;' and Charles Horn, composer of 'Cherry Ripe.' Sir Henry Bishop also enjoyed a lengthened popularity. The growth of national taste in respect of song has not kept pace with its advance in other branches of music, many excellent writers belonging to the later part of the 19th century being as yet for the most part unappreciated, while publishers find a large sale for vapid compositions in the so-called 'drawing-room' style. Songs written for several voices are known as part-songs, glees, madrigals, &c. See CATCH, GLEE, MADRIGAL, ROUND; and the article 'Song' in Grove's *Dictionary of Music*. For the song of birds, see BIRD, Vol. II. p. 169; and for the Song of Songs, or Song of Solomon, see CANTICLES.

Songhay, or SONRHAI, a former kingdom of Africa, extended on both sides of the Niger below its great bend. In the 15th century the empire extended from Lake Tsad almost to the Atlantic, but early in the 17th century it was overthrown by the sultan of Morocco.

Song-ka, the chief river of Tong-king (q.v.).

Sonnblick, a hill 10,277 feet high amongst the Salzburg Mountains, on whose summit is a meteorological observatory, with a shelter built in 1886 by the Austrian and German Alpine Clubs.

Sonnet (Ital. *sonetto*, dim. of *suono*; Fr. *sonnet*). In poetic art the sonnet—a stanza mostly iambic in movement, properly decasyllabic or hendecasyllabic in metre, always in fourteen lines arranged properly according to some law that is recognised at once as having universal acceptance—belongs entirely to the rhymed poetry of the modern world. Sonnets are divided into regular and irregular. All regular sonnets are divisible

into: (1) The sonnet of simple stanza in which the staves follow each other in three quatrains of alternate rhymes clinched at last by a couplet. This form is for obvious reasons called the Shakespearian sonnet. (2) The sonnet of compound stanza divided generally, but not always, both as regards sense-rhythm and metre-rhythm, into two parts—an octave consisting of eight lines (the first line of which rhymes with the fourth, the fifth, and the eighth lines, the second line with the third, the sixth, and the seventh), and a sestet consisting of six lines running on two or else three rhymes in an arrangement which, though free from prescription, must always act as a response by way of either ebb or flow to the metrical billow embodied in the octave. This form is for equally obvious reasons called Petrarchan. Within the space at our command it is impossible even to glance at the history of the sonnet here, save as it now and then discloses itself in our remarks upon the general principles governing the sonnet's matter and its form.

Though poetic art has many functions and many methods, the two following among its functions seem specially to concern us in treating of the sonnet: The function of giving spontaneous voice to the emotions and passions of the poet's soul; and the function of poetising didactic matter and bringing it into poetic art. With regard to the first of these functions, although the sonnet is a good medium for expressing passion and emotion, it cannot be said to take precedence in this respect of other and less inherently monumental forms. The ode of Sappho, the bird-like song of Catullus, and the free-moving rhymed lyric of modern times are probably better adapted to give expression to simple passion at white heat—while on the other hand they are certainly better adapted to give voice to that less intense form of passion which can pause to 'deck itself with the flowers of a beautiful fancy—than is the sonnet—even the sonnet of simple stanza of Shakespeare and Drayton. With regard, however, to the second of the above-mentioned functions of the poet—that of poetising didactic matter—a function which of course can only be exercised by passing the didactic matter through a laboratory as creative and as recreative as nature's own, the laboratory of a true poet's imagination, the pure lyric must of course yield to the sonnet. Indeed, it is an open question whether since the Romantic revival the sonnet has not been gradually taking precedence of most other forms as an embodiment of poetised didactics. And should this on inquiry be found to be the case, the importance of this form will be made manifest. For as the mind of man widens in mere knowledge and intelligence fresh prose material is being furnished for the poetic laboratory every day. And the question, What is the poetic form best suited to embody and secure this ever-increasing and ever-varying wealth?—a question which has to be answered by each literature, and indeed by each period of each literature, for itself—goes to the root of poetic criticism. Of course, before didactic matter can become anything more than versified prose, it has to be excarnated from the prose tissue in which all such matter takes birth, and then incarnated anew in the spiritualised tissue of which the poetic body is and must always be composed. Hence it is not enough for the poet to use the sieve, 'as Dante would say,' in selecting 'noble words.' The best prose writers from Plato downwards have been in the habit of doing this. When Waller said:

Things of deep sense we may in prose unfold,
But they move more in lofty numbers told,

he meant by 'lofty numbers' those semi-poetic 'numbers' of the English couplet in which poetised

didactics were in his time embodied—as in the time of Shakespeare such poetised secretions of the mere *intellectus cogitabundus* were put into the mouths of dramatic characters after the approved old fashion of the classical dramatists.

Since the Romantic revival, however, poetic art has undergone an entire change. Acted drama cannot now receive poetised didactics, which would in these days slacken the movement and disturb the illusion required, while as to the kind of epigram-in-solution or half-poetised quintessential prose which is embodied in the 18th-century couplet the criticism of the Romantic revival is apt to consider this not so much as poetry as an intermediate form—and an extremely rich and precious one—between poetry and prose. Epigrammatic matter must, to exist at all, be knowing, and as knowingness and romanticism are mutually destructive, it is evident that some form other than the couplet, which is so associated with epigram, must in our time be used for the poetising of didactic matter of the unworldly and lofty kind. And the sonnet of octave and sestet is a form less epigrammatic than any other—a form moreover which can never, as certain other stanzaic forms can do, embody mere quintessential prose without proclaiming its poverty, but must always be poetic in its very texture—a form indeed which will not bear one line that is not either in essence or in method poetic or else ‘rhetorical’ in Dante’s sense when he defined poetry to be ‘a rhetorical composition set to music.’ So absolutely poetic a form is this that if it should happen that the diction will not on account of the subject bear elevation, it has to be at once poetised by one of those skilful disturbances of the prose order of the words of which Wordsworth was so great a master.

The fact of the word sonnet being connected with *suonare*, to play upon an instrument, shows that a knowledge of music, though perhaps not essential, is of great value to a sonnet-writer. Indeed, owing to the consonantal character of our language a knowledge of music is really of more importance to the English than to the Italian sonnet-writer. Although the ‘singing words’ essential to a good song for music need not perhaps be greatly sought in the sonnet (save in the special and somewhat rare form mentioned further on), still vowel-composition and that attention to sibilants which Pindar is constantly showing in his odes—that attention which Dionysius of Halicarnassus extolled—and also the softening of consonantal feet by liquids are extremely important in the sonnet even although it is no longer written to be set to music. After much practice in the art of rhymed poetry—when every feasible rhyme leaps into the brain of the poet the moment that a line-ending has suggested itself to his mind—this attention to structural demands becomes instinctive, and is exercised in that half-unconscious and rapid evolution of the mental processes which the witty conversationist shows in repartee, and which the pianist exhibits when touching the keyboard—supposing of course that the poet is a born rhymist. It is, however, a curious and interesting fact that ever since the time of Piers Plowman (when alliterative measures gave way to rhymed measures) English poets have been clearly divisible into two classes—those to whom rhyme is an aid and those to whom rhyme is more or less a check. And still more curious and interesting is it, that while three of the greatest poets, Shakespeare, Marlowe, and Milton, belong to the one class, Coleridge (who by endowment perhaps stands next to them) belongs to the other. This is why some of the strongest English poets have not been successful in the sonnet, where the rhyme-demands are very great. For some reason or another the rhythmic impulse

within them has not been stimulated but crippled and tortured by the spur of rhyme.

With regard to prescription in the number of the lines and the arrangement of the rhymes of the sonnet, metrical art offers the reader two opposite kinds of pleasure; the pleasure derived from a sense of prescribed form, as in the sonnet, the ballade, the *rispetto*, the *stornello*, &c., and the pleasure derived from a sense of freedom from prescribed form as afforded by those pure lyrics, in which the form is, or at least should be, governed by the emotion. Now every poetical composition should show at once which of these kinds of pleasure is being offered to the reader and should also satisfy the expectation raised, for he will experience a sense of disappointment on being proffered one kind of poetic pleasure when he has been led, by the stanzaic arrangement or otherwise, to expect another. Nevertheless a certain few of our great sonnets are irregular, for a great poet can do anything.

With reference to regular sonnets it is self-evident, as regards the sonnet of compound stanza, that there are four different forms into which may fall a metrical structure consisting of an octave of a prescriptive arrangement of rhymes and a sestet consisting of another set of rhymes that are free in arrangement from prescription. And some years ago the present writer exemplified these in ‘four sonnets on the sonnet,’ one only of which, under the name of ‘The Sonnet’s Voice,’ originally printed in the *Athenæum*, was widely circulated in sonnet-anthologies. These varieties of the sonnet of octave and sestet are: (1) The sonnet in which the stronger portion both in rhythm and in substance is embodied in the sestet. (2) The sonnet in which the stronger portion both in rhythm and in substance is embodied in the octave. (3) The sonnet in which the sestet is not separated from the octave, but seems to be merely a portion of the octave’s movement rising to a close more or less climacteric. (4) The sonnet in which the sestet seems to be added to the octave’s movement, added after its apparent termination in a kind of tailpiece, answering to what in music we call the ‘*coda*.’

With regard to the second of these varieties—the one exemplified in ‘The Sonnet’s Voice’—perhaps the ideal form has the octave in double rhymes and the sestet in single rhymes. But it has to be remembered by the poet that between the effect of Italian rhymes and the effect of English double rhymes there is a great difference. Save in the hands of a sonnet-writer of great practice in the art of vowel-composition, in the art of using singing words, and in the art of softening our consonantal language, by the proper use of liquids and subtle and concealed alliterations, the English rhyme-beat in the double-rhyme octave of this variety is apt to become too heavy for the single-rhyme rhyme-beat in the sestet. By attention to these requirements, however, the rhyme-beat may be so lightened that this variety may become the most brilliant of all.

With regard to the sonnet of simple stanza, it has two special glories: it was the form adopted by Shakespeare, and in it is written Drayton’s famous love-sonnet. Hartley Coleridge wrote some fine sonnets in this form; so did Keats: but on the whole it has been neglected in recent times. A renewed attention has, however, been lately given to it by critics of the sonnet both in England and America owing to Dr Gordon Hake’s book of nature poems, *The New Day*, where the Shakespearian form of sonnet is used. Here, by a free use of double rhymes the poet gives a lyrical movement to his verse, which, though an occasional feature of Shakespeare’s sonnets, is not a characteristic one.

Sonmiáni, a miserable town and port of 4000 inhabitants on the coast of Beluchistan, 52 miles N.W. of Kurrachee.

Sonora, a frontier state in the north-west of Mexico, on the Gulf of California. It is the second largest in the republic. Area, 77,528 sq. m.; pop. (1888) 105,391. The coast is flat and sandy, the interior filled with wooded mountains and fertile valleys. Malaria is mostly confined to one part of the coast. Here the climate is hot, but in the mountains there is frost for five months in the year. The chief rivers are the Sonora, Yaqui, and Mayo. The principal wealth of the state is in its minerals, especially gold, silver, mercury, and iron. Agriculture, wine-growing, and cattle-rearing are also successful, and cottons, hats, shoes, and soap are manufactured. Capital, Hermosillo; chief port, Guaymas.

Sonsonate, a town of Salvador, on the Rio Grande, 15 miles by rail N. of Acajutla. It was founded by Alvarado in 1524. Pop. 8000.

Sontag, HENRIETTA, COUNTESS ROSSI, a German singer, was born at Coblenz on 3d January 1806, and was educated by her parents to their own profession of the stage. She learned singing at Prague, and made her début there when only fifteen. After a brilliant operatic career at Vienna, Berlin, and Paris, she married Count Rossi in 1828, and shortly afterwards left the stage. Compelled by pecuniary difficulties to reappear in 1849, she met with renewed success both in Europe and America, but died in Mexico on 17th June 1854.

Sonthals. See SANTALS.

Soochoo, or SUCHAU, previous to the Taiping rebellion one of the largest cities in China, is situated on the Imperial Canal, 50 miles WNW. of Shanghai, in the province of Kiang-su. It stands on numerous islands separated by canals, and since 1896 has been accessible as a treaty-port. The city walls have a circuit of 10 miles. Soochoo has for generations been a noted centre of the silk manufacture and of the printing of cheap Chinese classics. It was captured by the Taipings, but recovered by 'Chinese' Gordon in 1863, on which occasion the city with its many handsome buildings was almost wholly destroyed. Pop. 500,000.

Sooloo Islands. See SULU ISLANDS.

Soot. The soot both of wood and of coal is serviceable as Manure (q.v.) on account of the sulphate of ammonia it contains, especially for young cereals, for grasses, and for carrots. See SMOKE.

Sophia, the capital of Bulgaria. See SOFIA.

Sophia, Electress of Hanover, born on 13th October 1630, was the youngest of the thirteen children of Elizabeth (q.v.), queen of Bohemia. In 1658 she married Ernest Augustus, Duke of Brunswick-Lüneburg, and afterwards Elector of Hanover, and by him she was the mother of George I. She died 8th June 1714. See her *Memoirs* (Eng. trans. by H. Forester, 1888). For Sophia Dorothea, the wife of George I, see KÖNIGSMARK.

Sophia, ST (Greek *Hagia Sophia*, 'Holy Wisdom'—i.e. the eternal wisdom of God or the Logos, and not a human saint), to whom Greek churches were often dedicated; especially the great church of Constantinople (q.v.), erected by Justinian in 538-568 A.D. Its dimensions and a sectional plan are given at BYZANTINE ARCHITECTURE.

Sophists. The Greek word *sophistês* (from *sophos* = 'skilled,' 'wise') meant originally any one of acknowledged or professed skill; thus, the term was applied to the seven sages (whether philosophers, like Thales, or statesmen, like Solon),

to poets, musicians, &c. In the 5th and 4th centuries B.C. it came to be applied specially to those who made a profession of teaching all or any of the higher branches of learning. The great intellectual awakening of Athens after the Persian war, and the growth of democracy in Sicily and elsewhere, as well as at Athens, which gave skill in public speaking a new importance, led to the demand for an education which should go beyond the old training in 'gymnastic' and 'music' (i.e. reading, writing, singing, and reciting from the poets). To meet this demand there arose a class of professional teachers, wandering scholars, who undertook to provide what we should call 'higher education.' This new movement presents certain resemblances to the rise of the universities in the 13th century, to the popularising of learning and science in the 18th and 19th centuries, to the 'University Extension' movement of to-day. Some of these 'Sophists' were more specially teachers of rhetoric—i.e. they gave particular attention to the *form* of public speaking, and as such they are the beginners of Greek prose style. Originally artistic expression takes the form of verse. The poet is the 'maker,' the artist in language: prose is simply 'ordinary speech.' But from the time of the rhetoricians, such as Gorgias (q.v.) of Leontini, prose also becomes an art. The first effect of the deliberate pursuit of artistic form in prose was to produce a pedantic and artificial style. (We can trace the evil influence of Gorgias in the 'speeches' in Thucydides.) But this attention to language was the preparatory training for the simple beauty of the best Attic prose. Other Sophists gave more attention to the *matter* of public speech—the questions of right and wrong which come before law-courts and political assemblies—and in this way they were the beginners of moral and political philosophy. The earlier Greek philosophers, with the partial exception of the Pythagoreans, had hardly treated of human matters: they had been ontologists and cosmologists. Protagoras (q.v.) of Abdera and Prodicus of Ceos may be taken as famous and favourable examples of the professors of 'virtue.' It must be remembered that the teacher of conduct and the moral philosopher were not distinguished even by Plato and Aristotle. Other Sophists, like Hippias of Elis, professed to teach universal knowledge—what we call 'general culture.' Others again, like Euthydemus and Dionysiodorus (who appear in Plato's dialogue named after the first of them), devoted themselves specially to the art of disputation, and thus prepared the way for the science of logic.

The ambitious youth of Athens flocked to a fashionable Sophist from intellectual interest in the new learning and in order to acquire an education which would fit them to obtain success in the law-courts and in the popular assembly, or to acquit themselves with distinction in a discussion on any subject whatever. The various Sophists naturally differed much from each other in ability, in character, and in the degree of seriousness with which they regarded their function as teachers; and some may very well have deserved the censure expressed in Aristotle's definition of the Sophist as 'a man who makes money by sham wisdom' (in *Soph. Elench.* i). In the eyes of old-fashioned persons the whole class was regarded with suspicion: the skill of the clever orator or disputant seemed to have something immoral about it, because it might enable the worse cause to appear the better. And to discuss the nature of right and wrong, or to theorise about the foundations of society, was then, as in other ages, regarded as dangerous. In the eyes of such persons Socrates and Plato were 'Sophists' just as much as the rest, although

Socrates and Plato, conscious of their own intellectual honesty and earnestness, and not teaching for 'pay,' disowned the title. When the various branches of the new learning came to be differentiated, we find the rhetorician Isocrates (q.v.), to whom the term would certainly be applied by the average Athenian and by Plato, applying the term to Plato, but not to himself. Again, whereas Plato applies it to Protagoras, Gorgias, Hippias, &c., we find that Aristotle in a passage (*Eth. Nic.* ix. 1) where he speaks disparagingly of the Sophists contrasts Protagoras with them. The word had come to acquire an evil connotation, such as survives in our use of the term 'sophistry.' But it is quite a delusion, as was conclusively shown by Grote (*History of Greece*, pt. ii. chap. 67), to suppose that the Sophists were a sect of philosophers, with pernicious principles, who systematically undermined the morality of the Hellenic world. They were not a sect, but a profession: and on the whole they were neither better nor worse than their age. Like the journalist or litterateur of our own time, they succeeded by supplying what the public wanted. The Platonic Socrates, their adversary, himself says, 'Our youth are corrupted, not by the individual Sophists, but by the public, which is the great Sophist, against whose influence any private teacher wages an unequal contest' (*Republic*, vi. 492).

There is no common 'Sophistic' doctrine. Different Sophists were influenced by different schools of philosophy. They were the popularisers of older doctrines. Thus, Protagoras was influenced by Heraclitus (q.v.), whose doctrine of universal flux gives a basis for Protagoras' assertion of the absolute relativity of knowledge ('man is the measure of all things; nothing is true but the sensation of the moment'). The alleged influence of his fellow-townsmen, Democritus (q.v.), seems less likely; for Democritus was about twenty years younger. Still the Atomist resolution of all things into mere arrangements of the only real existences (the atoms and the void) very likely helped to supply a basis for the distinction between 'convention' and 'nature,' which was much used by some Sophists and became a commonplace of the period. Gorgias is said to have been a disciple of Empedocles (q.v.), and was certainly influenced by the Eleatics (q.v.). His paradoxical treatise on 'Nature or the non-existent' is clearly a sceptical working out of the Eleatic principle of the unreality of the manifold. We have no sufficient knowledge to justify the attempts made by some German scholars to classify the Sophists according to different philosophical schools; and it is, moreover, unlikely that popular philosophers should admit of any very precise affiliation. We can only group them in a very rough way, such as has been attempted above. Some historians of philosophy (e.g. Zeller and Ueberweg) lay stress on the distinction between the earlier and later Sophists, considering the 'later Sophists' (such as Polus of Agrigentum, a pupil of Gorgias, Thrasymachus of Chalcedon, Euthydemus, &c.) to represent a distinct degeneracy in the class. This, however, seems doubtful, except in the sense that, as time went on, 'rhetoricians' and 'philosophers' came to be more clearly differentiated from among the mass of the profession; and the name Sophist degenerated as we have seen. Professor Sidgwick has argued that the 'Eristic' or disputatious Sophists are really a degenerate offshoot of the Socratic school; but against this hypothesis there are many objections.

While Grote is perfectly correct in holding that the Sophists are not a sect and have no common doctrine, he errs in ignoring the fact that they represent a common tendency, the new spirit of the

age. The awakening of reflection on political and social institutions, on morals and religion, and the wider diffusion of enlightenment produced in Hellas the same spirit of 'freethinking,' individualism, and sceptical criticism which we find among the 'Humanists' of the Renaissance, and still more among the English 'Deists' and French 'Encyclopaedists' of the 18th century. Of this intellectual movement the Sophists were at once the outcome and the leaders. The differences between the Sophists might be paralleled by the differences between Voltaire, Diderot, Rousseau, &c., and yet all these writers share a common tendency. The very opinions maintained by certain Sophists reappear in more fully developed forms among English and French writers of the 17th and 18th centuries. Thus, Thrasymachus, in Plato's *Republic*, bases right simply on the command of the stronger, by which he means the sovereign power in the state—the theory of Hobbes, developed afterwards in its legal aspects by Bentham and Austin. From the second book of Plato's *Republic* it appears that the Social Contract theory had already been propounded, almost certainly by some Sophist. Aristotle (*Politics*, iii. 9) quotes Lycophon the Sophist as holding that government was only concerned with the protection of individual rights. Alcidas, the rhetorician, maintained that 'God made all men free; Nature has made none a slave.' This and similar sentiments, which we may call 'Sophistic,' in the sense that they belong to the new Rationalism, are to be found frequently expressed in the extant plays and fragments of Euripides. Even Herodotus, though his style is unaffected by the rhetorical schools, has also imbibed a certain tolerant scepticism, which appears in his treatment of the diversity of customs and religious beliefs; and the debate about the best form of government (iii. 80-82), which he unhistorically puts into the mouth of Persians, is probably due to a 'Sophistic' source, and may indeed be called the earliest piece of Greek political philosophy that has come down to us. Much of the teaching of the Sophists was undoubtedly destructive of the old fabric of Greek belief and of Greek society, which rested on the narrow basis of an exclusive citizen caste with a substructure of slavery. The modern student will not necessarily think the worse of the Sophists on that account; though the majority of them were probably by no means conscious of the significance of the critical weapons they handled. By raising problems in almost every department of thought, for which they could find no satisfactory answers, they prepared the way for the great period of Athenian philosophy (see SOCRATES). In later times the term 'Sophist' came into reputation again; and some of the Greek professors of rhetoric under the Roman empire were described as Sophists on their tombs.

Besides the histories of Greek philosophy referred to under PLATO, and Grote's chapter mentioned above, may be named two articles by Professor Henry Sidgwick, defending Grote's view, in the *Journal of Philology*, vols. iv. and v. In A. W. Benn's *Greek Philosophers* (2 vols. Lond. 1883) chap. ii. deals with the Sophists, and is entitled 'The Greek Humanists.' The significance of the Sophists in the development of Greek thought was first put in a true light by Hegel in his *History of Philosophy*.

Sophocles, the Athenian tragic poet, was born in 496 B.C., and died in 405 at the age of ninety-one. His father's name was Sophillus, and his native district was Colonus, a suburban quarter on the banks of the Cephissus, much frequented by the knights and wealthy citizens of Athens. He partook in full measure of the highest education of his time, and was especially distinguished in music, which he learned from Lamprocles. At sixteen he was chosen to lead the chorus of youths who

celebrated the naval victory of Salamis (480). At the age of twenty-eight he came to the front by entering into competition with Æschylus, his elder by thirty years, whose pre-eminence as a tragic poet had long been undisputed. The judges on this occasion, according to an oft-repeated tradition, were Cimon and his fellow-generals, just returned from Scyros. The younger poet was preferred; and his triumph had a decisive influence on the future of the tragic art. For not only are the mature works of Sophocles and those of Euripides, his younger brother in poetry, the fulfilment of the promise then given, but the Oresteian trilogy of Æschylus, in which Greek tragedy attained its highest limit, was brought out ten years after this, and bears unmistakable proofs of the impression which the art of Sophocles had made upon his elder and greater rival. Sophocles never forsook Athens as both Æschylus and Euripides did, but he was repeatedly employed on embassies to other Grecian states, and in the Samian war of 440 he was appointed general in a joint command with Pericles. This choice is said to have been due to the success of the *Antigone*, one of the earliest of the poet's seven extant plays, as the *Œdipus Coloneus* and *Philoctetes* are certainly the latest. The probable order is *Ajax*, *Antigone*, *Electra*, *Œdipus Tyrannus*, *Trachiniæ*, *Œdipus Coloneus*, *Philoctetes*. Less than a tithe of the work of Sophocles remains to us; but of the seven plays each one has superlative excellences, and stands prominently forth amongst the master-works of the human spirit. The characteristics of Sophocles are a dramatic structure all but faultless, the combination of wonderful subtlety with intense fire, and of a noble ideal with truth and naturalness. His subjects were necessarily drawn from Hellenic legend. His motives in selecting them were mainly artistic, but to some extent also religious or patriotic. In his treatment of them he never loses sight of the main principles of tragic art. His method turns largely on pathetic contrasts (1) of situation, (2) of character.

(1) The change of fortune which forms the crisis of each play is often rendered more impressive through the profound unconsciousness, at the beginning of the action, of the persons who are to be affected by it. The case of *Œdipus* is the capital illustration of this remark; but it applies also to Creon in the *Antigone*, to *Electra*, *Deianira*, *Philoctetes*, and to the chorus in the *Ajax* and *Œdipus Coloneus*. Sometimes the chief agent, *Antigone* for example, is fully conscious of the real position of things, but in every case appearance and reality are strongly opposed.

(2) The persons in Sophocles are most skilfully adapted to the main situation and action of each play. The addition of a third actor to the two that had formerly sufficed enabled the poet not only to contrast opposed natures, such as *Antigone* and *Creon*, but to introduce finer shades of difference, as between *Antigone* and *Ismene*, or *Agamemnon* and *Odysseus*. Perhaps the most notable instance of such delicate portraiture occurs in the *Philoctetes*, where *Neoptolemus*, the ingenious youth, is contrasted equally with the politic *Odysseus* and with the hero of the play, in whom a generous nature has been embittered by ill-treatment and solitude.

The *Ajax* may be described as the tragedy of wounded honour. *Ajax* and *Odysseus* had recovered the dead body of *Achilles*, whose armour, the miraculous work of *Hephestus*, was then awarded not to *Ajax*, the most valiant of the surviving Greeks, but to *Odysseus*, the wisest. Half-maddened by repulse, *Ajax* would have assassinated the generals; but, to defend *Odysseus*, *Athena* made the *Telamonian* warrior wholly mad,

and turned his violence against the flocks and herds belonging to the army. On awaking from his delirium, finding his honour lost, he resolves on death. *Agamemnon* would have refused him burial; but *Teucer* vindicates him, and *Odysseus*, with becoming magnanimity, ends the strife. *Tecmessa*, the captive bride, who in her helplessness defies the Argives and protects the hero's child, is one of those female characters which *Sophocles* portrays with so much skill.

In the *Antigone* the claims of piety and natural affection are seemingly overborne by the exaggerated assertion of state-authority in the person of the ruler, but in the end it is the ruler who succumbs. The virgin martyr is vindicated.

In the *Electra*, in place of the fiery Theban maiden, the poet represents the faithful endurance of the Argive princess, who in the *Oresteia* of Æschylus had played a subordinate part, but here rises to the height of female heroism.

The *Œdipus Tyrannus* was regarded by Aristotle as the *chef d'œuvre* of tragedy, and nowhere else is there to be found an equal combination of constructive ingenuity with tragic power. The hero is represented as the most loyal and affectionate, but also the most passionate, and, partly for that reason, the most unfortunate of men. Doomed to misery in his very birth, he appears to himself and others at the opening of the play to be at the height of prosperity. A stranger, he has earned the affection of Thebes, and lightly he undertakes the quest imposed by the god. In the sequel he discovers that he is the forbidden child of the king—whom he has slain—and of the queen—whom he has married! The poignancy and pathetic interest which *Sophocles* extracts from this unnatural story is a triumph of poetic skill. In the construction of the piece the employment of the Theban slave, who had been charged with the exposure of the child, and had also witnessed the death of *Laius*, is especially noteworthy.

The subject of the *Trachiniæ* is the death of *Heracles*, but the fatal act of *Deianira* in sending the poisoned robe (which she believes to be a charm for recovering the affection of her lord) forms the central motive. She is one of the most charming of poetic creations, 'the rival of *Imogen* in purity, of *Katharine of Aragon* in her great patience, and of both in wifely spirit.'

There was an interval probably of at least ten years between the *Œdipus Tyrannus* and the composition of the *Œdipus at Colonus*, which indeed is said to have been exhibited for the first time only after the death of the poet. Meanwhile the genius of *Sophocles* had mellowed, and the spirit of the age had undergone some change. What in *Euripides* becomes a sort of moral casuistry appears in *Sophocles* at this period as a serenely contemplative mood immersed in ethical reflection. He has adorned the legend of his birthplace with undying beauty. But the moral dignity of the *Coloneus* is different in kind from the tragic fire of the *Tyrannus*.

The *Philoctetes* was produced in 409. It is a marvellous work for one in his eighty-seventh year to have composed. The characters are powerfully distinguished, and their mutual interaction is a new thing in dramatic poetry. *Philoctetes*, like the *Œdipus of the Coloneus*, is rejected by man, but accepted by the gods. Ill-usage and solitary musing have fixed in him the resolution never to return. The policy of *Odysseus* and the affectionate pleading of *Neoptolemus* are alike in vain, until the hard knot is loosed by the apparition of *Heracles* (in *Euripidean* style), who had been the hero's master and patron in the world of men. The interest of the action, which would else be stationary for so long, is sustained by the conflict

in the soul of Neoptolemus, in whom ambition and public duty are struggling with pity for Philoctetes, and with the love of truth which the young chief inherits from his father Achilles. The victory of his better nature forms the culminating point in the action of the play.

Of other subjects known to have been treated by Sophocles those most suggestive of tragic interest are Alcmaeon, Atreus, Danaë, Hermione, Thamyra, Thyestes in Sicyon, Iphigenia, Clytemnestra, Creusa, Laocöon, Meleager, Niobe, Ctenomäus, Peleus, Telephus, Tereus, Troilus, Phædra, Phineus. The remaining fragments of these and other plays are on the whole disappointing. Sophocles even less than other poets can be fairly represented by isolated passages.

Amidst much variety, the dramatic work of Sophocles presents some constant features. Each play has a preliminary scene in which the main situation is set forth. This is followed by the entrance of the chorus, consisting of persons who stand in some well-considered relation to the chief agent. Then fresh complications supervene, and the action rises in steady climax to the turning-point. The reverse of fortune is generally announced by a messenger, after whose speech the *kommos* or interchange of lamentation between the stage and orchestra naturally comes in. Between the scenes choice odes or *stasima* are interposed. But the lyric numbers are not confined to these. At suitable moments the chorus, and sometimes the actors themselves, break out into song, which on the part of the chorus is sometimes accompanied with dancing of a more or less animated description. This takes effect particularly in the *hyporchema*, or dancing-ode, which Sophocles is fond of employing at some conjuncture where the *dramatis personæ* have been deceived for the moment into a false and short-lived joy. This relieves the monotony of gloom while ultimately rather heightening tragic effect, by emphasising the contrast above noticed between appearance and reality.

Sophocles has not impressed the world with superhuman grandeur as Æschylus has done. Nor has he charmed mankind by the witchery of style in particular scenes and descriptive passages, as appears to have been the case with Euripides. But to some of the greatest critics—e.g. Lessing—his merits as a dramatic artist have appeared to be supreme. The purely human note in tragedy is dominant for the first time in him. Matthew Arnold in an early sonnet described him well :

Be his
My special thanks, whose even-balanced soul,
From first youth tested up to extreme old age,
Business could not make dull, nor passion wild;
Who saw life steadily and saw it whole;
The mellow glory of the Attic stage,
Singer of sweet Colonus and its child.

If not quite holding the first rank with Homer, Æschylus, Dante, and Shakespeare, Sophocles is at least one of the immortals.

The *editio princeps* was printed at Venice in 1502. In the long list of editors of the whole or part of the seven the most important names are Brunck, Gottfried Hermann, Wunder, Dindorf, Schneidewin, Hauck, Bergk, Lobeck (*Ajax*), Bickh, Meineke, Elmsley, Buttman, Linwood, Kennedy, Wolf, O. Jahn. The chief modern English annotated editions are those of F. H. M. Blaydes and F. A. Paley (2 vols. 1859-80), Prof. Lewis Campbell (2 vols. 1873-81), and Prof. Jebb (Cambridge Press, vols. i.-vii., 1884-97)—a masterly edition, in which Sophocles is treated with admirable thoroughness and clearness. Of English translations may be named those of Francklin, Potter, Dean Plumtre, Sir G. Young, R. Whitelaw (1883), and Prof. Lewis Campbell (complete, 1883) in verse; and those given in Prof. Jebb's edition, in admirable prose.

There is an excellent *Lexicon Sophocleum* by F. Ellendt (2d ed. by H. Genthe, Berlin, 1867-72), supplemented by an 'Index Commentationum' (1874). See

Hense, *Studien zu Sophocles* (1880); Patin, *Études sur les Tragiques Grecs* (vol. ii., new ed. 1877); Prof. Lewis Campbell, *Sophocles* in Green's 'Classical Writers' (1879), and *A Guide to Greek Tragedy* (1891); also Schlegel's *Lectures*, and Bishop Thirlwall's *Remains for a famous essay on the Irony of Sophocles*.

Soprano (Ital.), the highest species of voice. Its average range extends from C below the treble stave to A above it; but the greatest variety in compass and quality is found. The highest compass on record is that of Agujari, which on the testimony of Mozart reached to C in *altissimo* (three octaves). Music for this voice is now written with the G or treble clef; but in German full scores the old soprano clef, C on the first line, is still used. The *mezzo-soprano* has a somewhat lower range, usually from A beneath the treble stave to F on the fifth line. See VOICE.

Sora, a city of Italy, on the Garigliano, 55 miles E. of S. of Rome. Pop. 5411.

Sorata, a volcanic peak of the Bolivian Andes, to the east of Lake Titicaca, rising to 21,470 feet above the sea.

Sorau, a town of Prussia, 60 miles by rail SSE. of Frankfort-on-the-Oder, has three castles (one dating from 1207), some good churches, and manufactures of cloth, linen, cigars, &c. Pop. 13,665.

Sorb. See SERVICE.

Sorbonne, the earliest, as it was by far the most famous, of all the colleges of the mediæval university of Paris. The system of colleges, of which the Sorbonne was the first example, dates only from the later part of the 13th century, more than a hundred years after the beginnings of the university itself. The system sprang out of the necessity for the adequate accommodation of the vast numbers of students who flocked to Paris from all the countries of Europe. Previous to the erection of colleges the students had mainly to content themselves with such lodging as they could find, and experience had shown that they had suffered both in their purse and their morals from this system.

It was the happy inspiration of Robert of Sorbon, in the diocese of Rheims, to conceive and carry out the idea of combining a place of residence and a place of study. With the consent of St Louis, to whom he acted as chaplain, Robert founded the college of the Sorbonne in 1253, though it was not formally opened till 1256. By a bull of Clement IV. (1268) the new institution received the indispensable sanction of the pope as the head of all the mediæval universities. At the head of the college was the *provisor*, who was chosen by the whole university, though its business was mainly in the hands of the *prior*, elected every year from the members of the college itself. The members were divided into two classes, *Hospites* and *Socii*. The *Hospites* received the full benefit of the educational provisions of the college, but they had no part in its administration. On the attainment of the doctorate in theology at the age of thirty-five their residence came to an end. The *Socii*, who were restricted to the number of thirty-six, had the entire management of the college in their hands, and all, whatever their age or academic rank, were on a footing of absolute equality. The life of the college was according to the strictest monastic rule, and its inmates with proud humility styled themselves 'the poor masters of the Sorbonne.'

The Sorbonne was exclusively devoted to the study of theology, and no student could enter it till he had taken the diploma of Bachelor of Arts, and had sustained a thesis, known as the *Sorbonica* or *Robertina*, before all the members of the college. The discipline through which he had then to pass

was the severest in all the Paris colleges. It was above all by the system of disputation that his progress was stimulated and his proficiency tested. By its rigorous methods of conducting these disputations the Sorbonne gained the reputation of being the first theological school in Europe; and its opinion on disputed points of doctrine was universally accepted as the weightiest that could be obtained. In affiliation with his larger college Robert of Sorbon in 1271 also founded a smaller college—that of Calvi, or the Little Sorbonne—where students were prepared in subjects preliminary to their study of theology. It was the distinctive feature of the Sorbonne, however, and one which greatly helped to win for it its predominance in the university, that its members were drawn from every country in Europe, and not confined to a particular nation.

The history of the Sorbonne is a signal instance of a great institution admirably fulfilling its original intention, but incapable of making a new departure when such a departure was necessary for its continued vitality and efficiency. Till the close of the 15th century, when the scholastic theology was fast losing its hold on all the best minds, the Sorbonne filled a place of the first importance in the intellectual life of Europe. Throughout the middle ages the theological faculty of Paris was the main support on which the highest teaching had rested, claiming for itself the right, denied to the pope himself, of sovereign decree on the truth or falsity of all religious doctrine. But the Sorbonne virtually constituted the theological faculty, and in common speech was identified with it. Its voice therefore carried an authority that influenced the councils of the nation. Through its efforts France was saved from Peter's Pence and the Inquisition; and it was due to its encouragement that printing was introduced into Paris immediately subsequent to its invention.

From the beginning of the 16th century, when the new studies of the Revival of Learning found their way into France, the Sorbonne gradually ceased to represent the best thought of the country. To all reform alike in studies and religion it offered the most dogged resistance, and it was largely due to its action that Paris lost its place as the first school in Europe. Among the men of the new order the 'Sorbonnian bog' became a byword for bigotry and obscurantism. In the succeeding centuries the Sorbonne followed the same retrograde policy. In 1621 it actually obtained an edict, mainly directed against Descartes, forbidding all teaching that ran counter to accepted authorities. On the occasion of the erection of new buildings by Richelieu (1627), who was provisor of the college, a satirical Latin couplet declared that so long as its original home was in decay the Sorbonne was unassailable, but now that that home was renewed it would certainly go to ruin. The butt of the wits of successive generations, Boileau and Voltaire among the rest, the Sorbonne clung to its original traditions till at the Revolution (1792) its property was confiscated to other objects.

When in 1808 Napoleon reorganised the university of France, the Sorbonne was revived and became the seat of the *Académie de Paris* (see UNIVERSITIES) and of the three faculties of theology, science, and literature. In 1884-93 new buildings were erected at a cost of £880,000, to take the place of the college erected by Richelieu; the largest theatre can seat 3000. By a curious fatality the Sorbonne is still associated in France with undue respect for tradition in matters of education.

See the various histories of the university of Paris by Du Boulay, Crevier, and Denife; also Duvernay, *Histoire de la Sorbonne* (2 vols. Paris, 1790), and Franklin, *La Sorbonne* (Paris, 1875).

Sorcery. See MAGIC, WITCHCRAFT.

Sordello. See BROWNING (ROBERT).

Sorecidae, a family of Mammalia, to which the Shrew (q.v.) belongs.

Sorel, a town of Quebec, seat of Richelieu county, on the St Lawrence, at the mouth of the Richelieu River, 45 miles (by rail 78) NE. of Montreal. It manufactures machinery, leather, and bricks, and was formerly the summer residence of the governors-general. Pop. (1891) 6669.

Sorel, AGNES, the mistress of the worthless dastard Charles VII. of France, was born in 1409 in the village of Fromenteau in Touraine, and came to court in 1431 in the train of the Duchess of Anjou. Her influence was beneficial as long as she lived, but she died suddenly in 1450.

Soresina, a town of Northern Italy, 16 miles by rail NW. of Cremona, with 6765 inhabitants.

Sore Throat. See THROAT.

Sorghum. See DURRA.

Sorrel (*Rumex*), a genus of plants of the natural order Polygonaceæ (q.v.), very closely allied to Polygonum and Fagopyrum (see BUCKWHEAT), but having the perianth divided into six segments, the three inner of which enlarge and cover the *achenium*. The genus is very naturally divided into two sections, the first of which is already noticed in the article DOCK. The name

Sorrel belongs only to the second, characterised by dioecious flowers and acidity of stems and leaves. Common Sorrel (*R. acetosa*) is a perennial found in meadows and pastures throughout the whole of Europe, and is very plentiful in Britain. Its stem is from a foot to two feet high, its leaves arrow-shaped.

It is an agreeable salad, and is used in soups and sauces and as an addition to dishes of greens. It is therefore sometimes cultivated in gardens.

French Sorrel, or Roman Sorrel (*R. scutatus*), a native of France and Italy, has broader and blunter leaves, and is more frequently cultivated than

Common Sorrel, being considered of finer flavour. Sheep's Sorrel (*R. acetosella*) is a very similar plant, but of much smaller size, and its roots run very much under ground, so that it is a very troublesome weed in gardens and fields of poor dry soil, in which it is very common in all parts of Britain. *R. patientia* and *R. sanguinea* are both regarded on the Continent as good spinach plants. For Wood-sorrel, a totally different plant, see OXALIDEE. For the Red Sorrel of the West Indies, see HIBISCUS.

Sorrel Tree (*Oxydendron arboreum*), a small tree of the natural order Ericaceæ, which grows chiefly on the Alleghany Mountains. The leaves are acid, and are sometimes used for dyeing wool black.

Sorrento (Lat. *Surrentum*), a city of Italy, on the south-east side of the Bay of Naples, on the promontory which separates it from the Gulf of Salerno, 7 miles SW. of Castellamare. It is an archiepiscopal see, and possesses a cathedral. The



Common Sorrel
(*Rumex acetosa*).

manufacture of silk and the making of parquetry are extensively carried on. It is celebrated for the mildness and general salubrity of its climate, for its beautiful situation in the midst of orange-groves and fruit-gardens, and for the picturesqueness of the adjacent coast; on these accounts it is much resorted to by summer visitors. In the time of Augustus it was noted for its fine buildings; but few traces of these now exist. Among the Romans the wine of Sorrento was held in high repute. Tasso was a native. Pop. 6089.

Sortes Virgillianæ, a favourite mode of divination among the ancients, in which an oracular answer was found in a doubtful juncture by opening Virgil's *Æneid* at random, and pricking a pin into the book, or taking the first passage on which the eye chanced to rest. Another method was to take a number of his verses, shake them together in an urn, and draw out one, from whose contents to infer good or evil. The ancient Sibylline oracles naturally afforded a subject, and the strange magical reputation early attached to Virgil helped to make his great poem the book most frequently used for this purpose. The mediæval mind read Christianity into Virgil, and consequently found no difficulty in ascribing equal value to the *Æneid* and the Bible for purposes of divination. We are told that Severus fore-read his high destiny in the line, 'Tu regere imperio populos, Romane, memento;' and Gordianus, who was to reign for but a few days, read his doom in the words, 'Ostendunt terris hunc tantum fata, nec ultra esse sinunt.' Gundulf, afterwards bishop of Rochester, and two other monks one day at Caen turned over the pages of a book of the gospels to read their future fortunes, and the Abbot Lanfranc foretold from Gundulf's passage that he should yet become a bishop. Rabelais found his license to escape from the bondage of the convent in the line, 'Heu! fuge crudeles terras, fuge littus avarum;' and we may see all the weakness of this method in the perplexity of the answers it yielded in the great question of Panurge's marriage. Dr Welwood tells us that Charles I. and Lord Falkland once made experiment of their future fortunes at the Bodleian in Oxford, and found passages equally ominous to each. The lines which the king read (*Æn.* iv. 615-620) from Dido's imprecation against Æneas plainly foretold rebellion, defeat, and a shameful death; Falkland opened at Evander's lamentation over the untimely death of his son Pallas (*Æn.* xi. 152-181). Unfortunately for this beautiful story, Aubrey in his *Remains of Gentilisme and Judaisme* tells it of Prince Charles and the poet Cowley at Paris just before the trial of the king. At any rate Cowley himself tells us that he found some light from Virgil about the Scottish treaty, when employed as a secretary in affairs of state; and we read how the Lord Chamberlain used the passage in 2 Chron. xix. 5-8 during Charles I.'s miserable Sunday of hesitation about the execution of Strafford to convince the king that the responsibility really rested upon the judges. Sir Thomas Browne in his *Vulgar Errors* denounces the *Sortes* as an ancient fragment of pagan divination; and Dr Nathanael Hoine, in his *Dæmonologie* (1650), deploras the loss to the state and the sin to the church engendered through lots by sieves and books.

The early Christian writers denounced divination by lots as magical, and therefore a form of idolatry. Still the practice continued to be common — 'per sortes sanctorum,' by the first passage found in the psalter or gospel, the lectionary or sacramentary. St Augustine condemned this as an abuse of the divine oracles, yet preferred to see men turn in this way to the gospels rather than to demons.

And we find that an unsought omen from a psalm ended the opposition to the choice of St Martin as bishop of Tours. The *Sortes Apostolorum* was a collection of pious sentences much employed for divination, a bread and water fast of three days being prescribed before using it. A similar use of the Bible long survived amongst Protestants, and indeed is not to this day extinct among people of simple faith in corners of England and Germany. A characteristic instance is told of his own experience by the great Cambridge evangelical leader, Charles Simeon, when downcast about the opposition to his ministry in his earlier years. 'I prayed that God would comfort me with some cordial from His word, and that, on opening the book, I might find some text which should sustain me. It was not for direction I was looking, for I am no friend to such superstitions as the *Sortes Virgillianæ*, but only for support. The first text that caught my eye was Matt. xxvii. 32. . . . Simon was the same as Simeon. What a word of instruction was here, what a blessed hint for my encouragement!' The obstinate survival of this superstition depends upon the naturalness of the notion, where there is a strong conviction of the power and watchful care of an overruling Providence, and a belief in the Bible as the literally inspired hand-book of divine guidance to man. Bibliolatry makes the notion of such divination perfectly rational, and we may well believe that its disuse has been merely a consequence of the decaying respect for the mere letter of Scripture. See DIVINATION, and MAGIC.

Sorus. See FERNS.

Soteriology, that part of theology which treats of salvation by a redeemer (Gr. *Sotēr*). See ATONEMENT, CHRIST, CHRISTIANITY, JESUS CHRIST.

Sothern, EDWARD ASKEW, comedian, was born in Liverpool, 1st April 1826, and, declining the church, medicine, or the bar, in 1849 joined a company of players in Jersey, and soon afterwards passed into the stock company of the Theatre Royal, Birmingham. From 1852 he appeared in the United States, without much success, until in 1858 *Our American Cousin*, by Tom Taylor, was brought out in New York, with Sothern cast for the small part (forty-seven lines) of Lord Dundreary. The piece was a poor thing, and the character of the English peer as playgoers know it was Sothern's own creation, bit by bit. In November 1861 the play was produced in London, at the Haymarket, and ran for over 400 nights; and it was again and again revived in later years. Sothern essayed many other characters, but he is remembered chiefly as Dundreary; his other most memorable parts were David Garrick in Robertson's comedy, and perhaps Fitzaltamont in *The Crushed Tragedian*; the latter failed utterly in England, but was always popular in America, whither Sothern returned several times. He died in London, 21st January 1881. See the *Memoir* by T. E. Pemberton (1890).

Soto, FERNANDO DE. See DE SOTO.

Sotheville-les-Rouen, a town of France, dept. of Seine-Inférieure, 4 miles by rail S. of Rouen, with railway workshops and cotton industries. Pop. (1891) 15,608.

Sou, or SOL. See SOLIDUS.

Soubise, an ancient French family, whose property and title came in 1575 into the house of Rohan by the marriage of their heiress, Catherine de Parthenay, with the Vicomte René II. de Rohan. Memorable as champions of the Huguenot cause were both sons of this marriage, the elder, Henri, Duc de Rohan (q.v.), and the younger son, Benjamin de Rohan, to whom the seignury of

Soubise fell as heir of his mother. The latter was born about 1589, served under Prince Maurice in the Low Countries, and in the religious war commanded the Huguenots in Poitou, Brittany, and Anjou, and distinguished himself throughout by his reckless courage, especially in the bold attack on the royal fleet in the harbour of Blavet and the occupation of Oleron. When all hope was at an end he found a refuge in England, and died in London childless, 9th October 1642.—In the collateral line of descent was Charles de Rohan, Prince de Soubise, peer and marshal of France, who was born 16th July 1715. His grandmother had been a mistress of Louis XIV., and he himself became a favourite of Louis XV., and early in the Seven Years' War was given the command of an army of 24,000 men, which was utterly defeated by the great Frederick at Rossbach, 5th November 1757. His later exploits were less disastrous; he even won some small successes, and he kept the command until the peace in 1763. After the death of Madame de Pompadour he found the same patroness in Du Barry. When Louis XV. died he was the only one among the courtiers who followed his body to the grave—a piece of loyalty which made the new king retain him in his place in the ministry. He died 4th July 1787, and with him ended the line of Soubise-Rohan.

Soudan, or **SUDAN**, the Arabic equivalent (*Beled es-Sudan*—i.e. 'Land of the Blacks') of Negroland or Nigritia, a geographical term which in its widest sense embraces the vast region of Africa that stretches from the Atlantic to the Red Sea and the Abyssinian highlands, and from the Sahara and Egypt proper in the north to the Gulf of Guinea, the central equatorial regions, and the Albert and Victoria Nyanzas in the south. This is the home of the true Negro race, though there are various other pure and mixed elements in the population derived principally from Hamitic and Semitic (Arab) stocks. The Soudan in this sense falls naturally into three divisions: (1) *Western Soudan*, comprising the basins of the Senegal, Niger, Benue, and other rivers draining to the Atlantic, and including the political regions known as the French Soudan (see *SENEGAMBIA*), Sokoto (q.v.), and others; (2) *Central Soudan*, including the basins of the rivers draining into Lake Tsad, and covering the countries of Bornu (q.v.), Bagirmi (q.v.), Kanem, Wadai; (3) *Eastern Soudan*, the rest of the Soudan area east of Wadai, mainly the basin of the Middle and Upper Nile. This portion of the Soudan is also frequently styled the *Egyptian Soudan*.

Until 1882 the Egyptian Soudan formed one ill-organised province, with its capital at Khartoum. But in that year it was subdivided into four sections: (1) *West Soudan*, including Dar-Fûr (q.v.), Kordofan (q.v.), Bahr-el-Ghazal (the province on a western tributary of the White Nile, south of Kordofan), and Dongola (q.v.); (2) *Central Soudan*, comprising Khartoum (q.v.), Sennaar (q.v.), Berber, Fashoda (south-east of Kordofan), and the Equatorial Province, stretching along the Upper Nile to the great lakes; (3) *East Soudan*, along the Red Sea, including Taka, Suakin, and Massowah; (4) *Harar*, east of Abyssinia and north of the Somali country, abutting on the Gulf of Aden. This wide region differs considerably in physical features in its different parts. All the regions watered by the Nile and its tributaries (Taka, Sennaar, Fashoda, Bahr-el-Ghazal, and the Equatorial Province) possess highly fertile soil, capable of yielding immense quantities of cotton, durra, indigo, sugar, rice, maize, tobacco, fruits; while Kordofan and Dar-Fûr are bare and waterless, except in the rainy season, after which their wide grassy steppes give sustenance to numerous herds

of camels, cattle, sheep, and goats. Besides the products mentioned, ivory, ostrich-feathers, caoutchouc, salt, cloth, gums, iron, gold, honey, wax, and hides are important articles of internal traffic and foreign trade. The area of this portion of the Soudan has been estimated at 2½ million sq. m., and the total population at about 15,000,000. Of these three-fourths are of Negro descent, and mostly pagans or nominal Mohammedans; the rest are of Hamitic or Semitic origin and are fanatical in their adherence to Islam. The Egyptians established themselves at Khartoum in 1819, and during the next fifty years gradually extended their power over the provinces lying west and south of that city, and were more especially active during the third quarter of the century. In 1874 Dar-Fûr was conquered with help of Zebehr Pasha, a noted slave-hunter. Not receiving, however, the reward he conceived himself entitled to, he provoked insurrections in that district and in the Bahr-el-Ghazal province (1877-79), which were successively crushed by Gordon and Gessi. But in 1882 the Mahdi (q.v.) again raised the flag of revolt, and preaching a religious crusade overpowered the distant Egyptian garrisons, annihilated the Egyptian forces led by Hicks Pasha, cut off Emin Bey in the Equatorial Province, and shut up in Khartoum Gordon (q.v.), whom the English government had sent out to restore peace by friendly means; while his lieutenant, Osman Digna, after defeating the Egyptian army commanded by Baker Pasha, prevented the English from penetrating into the interior from Suakin and the Red Sea. Gordon's mission ended in disaster, and with the fall of Khartoum, Egyptian influence in the Soudan seemed at an end. Anarchy prevailed, the Sheik Senussi (q.v.) became a power, and to the Mahdi succeeded the Khalifa.

But, after the English reorganisation of Egypt, in 1896 an Anglo-Egyptian army forced its way to Dongola; and in 1898 the Sirdar (see *KITCHENER*) completed the reconquest of the Soudan by totally defeating the Khalifa's forces at Omdurman and occupying Khartoum. The discovery that Fashoda had been occupied by Major Marchand with a French force caused strained relations between Britain and France; but the question was amicably settled by the departure of Marchand in November 1898. The Sirdar was in January 1899 appointed Governor-general of the Soudan, 'by decree of the Khedive with the sanction of the British government.' His first official act was the founding of a college at Khartoum with funds (£120,000) raised by subscription in England.

See Schweinfurth, *The Heart of Africa* (1874); Nachtigal, *Sahara and Sudan* (3 vols. 1879-89); James, *The Wild Tribes of the Soudan* (1884); the War Office *Report on the Egyptian Provinces of the Sudan* (1884); Felkin and Wilson, *Uganda and the Egyptian Soudan* (1881); Paulitzschke, *Die Sudanländer* (1884); A. H. Keane in *Nature* (1884); Junker, *Travels in Africa* (Eng. trans. 1890-91); numerous papers by Emin Pasha in divers periodicals; Wingate, *Mahdism and the Egyptian Soudan* (1891); H. Russell, *The Ruin of the Soudan* (1892); Ohrwalder, *Ten Years' Captivity in the Mahdi's Camp* (1892); Bennet Burleigh, *Sirdar and Khalifah* (1898); Steevens, *With Kitchener to Khartoum* (1898); Alford and Sword, *The Egyptian Soudan, its Loss and Recovery* (1898). See also the articles *EGYPT* (with Map), *NUBIA*, *NILE*, *FULAHS*, *HAUSSA*, *KHARTOUM*, *MAHDI*, and *SCHNITZER*.

Soul, a term used with various significance both in philosophical terminology and in the language of everyday life. Soul is sometimes the immaterial and immortal part of man as opposed to his body; soul is sometimes distinguished from intelligence as the resolute, energetic, emotional from the calmly contemplative; and when soul and spirit are contrasted, the soul is the lower phase of

conscious life (sometimes the animal soul) as contrasted with the highest, noblest, and godlike element. A like confusion obtains in other languages; the German *seele* and *geist* are opposed nearly as life principle to mind, and as the emotional to the intellectual and spiritual. The confusion dates from the early times of Greek philosophy. In general, *psyche* (usually translated 'soul') is opposed to *nous*, 'intelligence,' and also, especially in religious philosophy, to *pneuma*, 'spirit,' the divine element in man. Plato (q.v.) divided the soul into (1) the rational, (2) the spirited or irascible, and (3) the appetitive elements. With Aristotle the *psyche* is practically the vital principle in plants as well as animals. In Neoplatonism (q.v.; and see also PLOTINUS) the psychical side of man was treated with disrespect as the part to be mortified. The doctrine of a world-soul has its roots in early speculation (see ANIMA MUNDI), and connects with some types of Pantheism (q.v.); see also MICROCOSM. Opposing views as to the origin of the individual soul, creationism, and traducianism are explained in the article dealing with the belief in Pre-existence (q.v.). The Transmigration (q.v.) of the soul is separately treated. See also the articles PSYCHOLOGY, PERSONALITY, IMMORTALITY, APPARITIONS, SECOND SIGHT, HELL, ANIMISM, and those on the great authors named at PHILOSOPHY.

Söul. See SEUL.

Soulouque. See HAYTI.

Soult, NICOLAS-JEAN DE DIEU, Duke of Dalmatia, and Marshal of France, was born the son of a notary at Saint-Amans-la-Bastide, in the dept. of Tarn, March 29, 1769. In 1785 he enlisted as a private in the Royal Infantry regiment, and was only sergeant after six years' service. Thereafter, however, his rise was rapid; in 1792 he became adjutant-major, and his conduct at Fleurus gained for him (October 1794) the brevet of general of brigade. From 1794 to 1799 he was in constant service on the eastern frontier and in Germany, and in the retreat after the defeat of Stockach (March 25, 1799) it was his able handling of the rear-guard alone that prevented the annihilation of the French army. The new chief Masséna made him general of division (April 1799), and owed to his courage and capacity much of the glory of his Swiss and Italian campaigns. In 1802 Soult was appointed by Napoleon one of the four colonels of the consular guards; in 1804 a marshal of France. He led the emperor's right wing in the glorious campaign closed with the crowning victory of Austerlitz, which he decided by piercing the Russian centre. He also did good service in the Prussian campaign, and took an important though not a prominent part in the Russian campaign of 1806-7, and after the peace of Tilsit was created Duke of Dalmatia. Soult was next placed at the head of the second corps in Spain, pursued the retreating British, attacked them at Corunna, and, though repulsed, forced them to evacuate the country and leave their stores behind. He then conquered Portugal, and governed it till the sudden arrival of Wellesley at Coimbra made him retreat rapidly to Galicia. In September 1809 he became commander-in-chief in Spain, gained a brilliant victory at Ocaña (18th November), and at the commencement of the following year overran and subdued Andalusia, continuing to command in person the southern army. In attempting to succour Badajos, which he had captured and garrisoned (March 11), he was defeated by Beresford at Albuera (May 16, 1811). After the battle of Salamanca and the advance of the British on Madrid, Soult, mortified at the obstinacy of Joseph Bonaparte and the rejection of his

admirable plans for transferring the theatre of war to Andalusia, demanded and obtained his recall; but Napoleon, as soon as the tidings of Vittoria reached him, sent him back to the command in Spain, as the only captain capable of turning the tide of ill-fortune. By brilliant tactics he neutralised the consummate strategy of Wellington, and reduced the seven months' campaign to a mere trial of strength, the defeats which he sustained at Orthez and Toulouse being due to the superiority of the British soldiers, not of their general. With his usual suppleness of character, he became an ardent royalist after the abdication of Napoleon; but on the return of the latter from Elba he threw over Louis XVIII. to become major-general of the imperial army. After Waterloo he rallied the ruins of the army at Laon, and at the council of war (July 3) coincided with Carnot as to the uselessness of further resistance. He was banished and not recalled till May 1819, but within a few years he was restored to all his former honours. In 1838 he was sent as ambassador to England to the coronation of Victoria, and was received by Wellington with warmth and by the nation with enthusiasm. In 1845 he retired from active duty, and was honoured with the appointment of 'Marshal-general of France'—a rank held before him only by Turenne and Villars. He now retired to Soultberg, his château near his birthplace, where he died, November 26, 1851.

See Soult's *Mémoires*, written in 1816 at Düsseldorf (3 vols. 1854); also Napier's *History of the Peninsular War*; Thiers's *Histoire de la Révolution et de l'Empire*; Salle's *Vie Politique du Maréchal Soult* (1834); and Combes, *Histoire Anecdote* (1870).

Sound, in ordinary language, is that which appeals to us through our organs of hearing. Experience teaches us that almost every sound can be traced to a source outside of us, and that as a rule the sound is characteristic of the source from which it comes. Different voices are easily recognisable, and there is no difficulty in distinguishing a trumpet-call from a violin-note. Here we have brought out the *quality* or *timbre* or colour of a sound. Another very obvious characteristic is the *pitch* of a sound. On it the whole theory and practice of music is based. Even the most unmusical ear can distinguish between a deep-toned note and a shrill one, between, for example, the extreme notes on a piano or organ. Then there is the question of the *intensity* or loudness of a sound. In terms of these three fundamental characteristics all differences of sound can be expressed. It is the object of the science or theory of sound to investigate the physical or mechanical nature of whatever under suitable conditions can be heard by the ear, and to express in terms of motion of matter these three ever-present characteristics—quality, pitch, and intensity.

Generally speaking, the air is the medium through which sound travels towards us. Whatever be the sound-producing body, it must first transfer something to the air, which in its turn conveys a corresponding something to our ear. Within us the sensation produced is a purely subjective one, and must not be confused with the objective cause existing outside of us. There is, however, a distinct relation between the two; for when the external conditions are physically identical, so are the resulting sensations. The very fact that air can transmit to us such a variety of sounds shows that it is capable of responding more or less completely to the varied characteristics of the sound-producing body. The necessary condition for the production of sound is that the body must, by its own vibrations or in some other way, set the air into vibration. Bells, tuning-forks, violin-strings,

and drums are familiar instances of vibrating bodies; but if these are made to vibrate *in vacuo* no sound will be heard. Vibrating in air they give forth their appropriate sounds. In the Siren (q.v.) we have an instrument which produces sound by breaking up a continuous blast of air into a succession of pulses. The instrument is valuable as proving that the pitch of a note depends on the number of pulses per second. The faster the siren spins, the more quickly the pulses follow each other, the greater is the frequency or number of pulses per second, and the higher is the pitch, as the ear at once tells us. The same fact can be proved by holding the edge of a card against the teeth of a revolving toothed wheel. If the wheel is going fast enough, the successive noises of the card as it frees itself from each tooth and impinges itself on the next succeeding are no longer distinguishable, but coalesce to produce a note of definite pitch which rises as the wheel rotates faster. Now it may be shown that, when the ear is satisfied that the notes produced by a siren and a tuning-fork have the same pitch, the number of pulses given by the siren in one second is exactly equal to the number of vibrations of the tuning-fork in the same time. Thus the vibrating tuning-fork transfers to the air a series of pulses timing accurately with the vibrations. It is not difficult to see how this takes place. As the forks vibrate to and fro they push the air first on one side and then on the other; and just as a hand moved slightly to and fro in water starts a series of waves travelling outwards along the surface, so the tuning-fork starts in the air a series of waves of condensation and rarefaction which travel outwards through the air. In the case of the water-waves gravitation supplies the force which, by its tendency to keep the surface level, gives the power of recovery that is indispensable to all wave-motion. In the case of the sound-waves the air's own Elasticity (q.v.), or power of resisting change of bulk and of recovering completely its original density, is the essential factor in producing and sustaining the wave-motion (see WAVE).

The essential features of the wave-motion in the air may be indicated by the behaviour of a row of points, each of which oscillates to and fro about its mean position. The time or period of oscillation is the same for all; and we shall suppose the oscillations to be of the simplest type known as Simple Harmonic Motion (see WAVE). When at rest the points are all at equal intervals apart, as in fig. 1, *a*. When in motion so that each point moves through its mean position a little later than



Fig. 1.

does the immediately preceding point, then the points will be crowded together in some regions and widely distributed at others (fig. 1, *b*). As the points continue their oscillations the configuration will not remain steady, but will move along among the points (fig. 1, *c* and *d*). Any given region will become alternately more crowded and less crowded, a region now of condensation, now of rarefaction. This ever-changing condition, which we have supposed to be the characteristic of a row of points, may easily be imagined to be possessed by a swarm of space-filling particles; and, from the analogy of the circular ripples which expand outwards over the surface of a lake which has been disturbed by a stone being dropped into it, we can readily picture a succession of spherical waves of condensation and rarefaction radiating out through

air from the source of disturbance, in the present instance the source of sound. The mode by which the condensation or rarefaction is passed on from one region of air to another may be explained as follows: Because of its elasticity air resists compression and will tend to recover its original density as soon as the compressing force is removed. But because of its inertia it will, if left perfectly free, overdo the recovery—just as a pendulum when drawn aside and let go swings to the other side of its natural position of rest. Now if any small region of air undergoes rarefaction it can only do so by itself expanding and thereby compressing the surrounding layer of air. But as it, so to speak, swings back through its condition of normal density to a state of condensation, the surrounding layer will swing from its state of condensation to a state of rarefaction, that is, expansion, compressing thereby in its turn the next encompassing layer of air. This second layer, having thus acquired an oscillatory character, will in the same way impress the next layer with a like character, and so on indefinitely.

Returning to the case of the tuning-fork, we see how the energy of its vibrations is gradually transferred to the air and transmitted through it to the farthest limits at which the sound is heard, if not farther. Thus the motion of the tuning-fork gradually decays, and the intensity of the sound heard at any given distance simultaneously diminishes. Ultimately the sound dies away, and the tuning-fork comes to rest. What is called the intensity of a sound depends in some way upon the degree of agitation communicated to the air—in accurate language, upon the vibratory energy existing in the air at the place where the sound is heard. Now it is a familiar experience that with great variations of intensity the pitch of a sound remains unchanged. The pitch depends upon the number of vibrations per second, and the intensity upon the energy of vibration. We find then that within wide limits the extent or amplitude of the vibration, or (as in air) the range through which the density may vary, does not affect the periodic time of the vibration. The quantitative relation between the energy and the amplitude, and therefore between the intensity and the amplitude, is that the former varies as the square of the latter. With double the amplitude we have four times the intensity, with half the amplitude one-fourth the intensity. That the intensity falls off at a much quicker rate than the amplitude is at once evident to any one closely inspecting the diminishing range of motion of a tuning-fork and at the same time paying attention to the decreasing loudness of the tone. The ear is by no means so sensitive in comparing intensities as it is in comparing pitches. When two notes are of very different pitch it is often difficult to say which is the louder.

We now pass to the consideration of the quality of a musical sound. A tuning-fork gives a colourless inexpressive sound, whose one useful property is the constancy of the pitch. When sounding the same note the pianoforte, the violin, the trumpet, the clarinet, and the human voice all impart their own peculiar flavour, which is readily recognised by the ear. Not only so, but we can distinguish different pianofortes, different violins, different voices, and so on. These differences of quality cannot depend on the frequency or number of vibrations per second, for that determines the pitch; nor upon the energy of vibration, for that determines the intensity. Quality, in fact, can depend only on the internal nature of the vibration. This may be shown synthetically, as König has done, by making siren discs, each perforated with its own peculiar shape of hole, but all identical as

regards number of holes and rate of rotation. It is evident that if the blast of air is broken up into successive portions which have issued through, say, triangular instead of the usual circular holes, the form of the pulses which build up the note will be changed. And such a change is recognised at once by the ear.

Most instructive in this connection are the laws of vibration of stretched strings. If we fix one end of a pretty long rope to a wall, and, with the other end in the hand, keep it in a stretched condition free of the floor, we may observe any slight disturbance given to it running as a solitary wave along the rope and back again after reflection at the wall. The tighter the rope is stretched the quicker will this disturbance travel to and fro along it. It is not difficult to show that the speed at which such a disturbance or wave will travel along a stretched cord depends on the tension (T) and on the mass (m) per unit-length of the cord, being given by the simple formula $v = \sqrt{T/m}$. Suppose we have such a stretched cord of indefinite length, and that a series of exactly equal waves are running along it from left to right, as shown in fig. 2, *a*, in which the straight line indicates the undisturbed position of the string. Now let there be propagated along the string from right to left an exactly equal series of waves, which, if existing alone, would throw the string into some such form as shown in *b* (fig. 2).

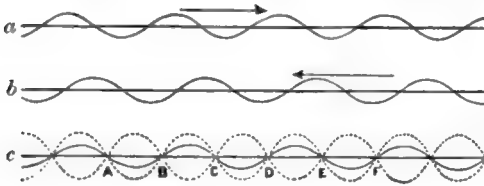

Fig. 2.

The superposition of these two exactly similar series of waves propagated in opposite directions gives rise to a resultant motion indicated in *c* (fig. 2). Here the points ABCDEF, being once at rest, are always at rest; since, whatever be the displacement due to the *a* waves, an exactly equal and opposite displacement is produced by the *b* waves, now and forever. Intermediate points, however, will move up and down between the limits indicated by the dotted loops in *c* (fig. 2). The string, in fact, will vibrate in segments whose ends are fixed at the points ABCDEF. The segments will be, at any instant, alternately above and below the undisturbed position of the string. The motionless points are called *nodes*; and it is evident that we may fix any two of them, and cut away all the string lying beyond these chosen nodes without in any way affecting the motion of the part lying between them. If we fix two contiguous nodes, for example A, B, we have a definite length of string vibrating as a whole. If A and C are fixed we get twice that first length of string vibrating in two segments; if A and D, we have three times the length vibrating in three segments; if A and E, four times the length vibrating in four segments; if A and F, five times the length vibrating in five segments; and so on. Now all these are simply different ways of producing exactly the same vibration, so that a note which is given by one length of stretched string vibrating as a whole may be given by L lengths of a similar string similarly stretched, vibrating in L segments. But we may have this string of length L itself vibrating as a whole. We have merely to suppose the oppositely directed series of waves to be L times longer than those shown in fig. 2 (*a*, *b*). If n is the

frequency of any vibration, and l the wave-length or distance from crest to crest, it is easy to see that a given wave will travel over a distance nl in one second. That is, we have $nl = v = \sqrt{T/m}$, a quantity depending only on the tension and mass of the string. Consequently, if we double the wave-length we halve the frequency; if we halve the wave-length we double the frequency; and so on. Generally then the frequency of vibration of a string of given tension and density varies inversely as its length. This is the principle on which all instruments of the violin and guitar types are played. The player, by pressing the string down with the finger at different points, can shorten the string in the required ratio, thereby producing a correspondingly higher note.

From what precedes we see that a stretched string, which vibrates as a whole, say, 100 times per second, can also vibrate 200 times per second in two segments, 300 times per second in three segments, and, in general, n hundred times in n segments, if the segments are not too short. By lightly touching, without pressing, a violin-string at the proper point, so that that point is made a node, any of these higher notes (overtones) may be obtained. This is a very common practice in playing the violoncello. Not only, however, may a string be so made to utter any of the overtones, but it is practically impossible to prevent some of them sounding along with the fundamental note. It is, in fact, upon the presence of these overtones that the quality or character of the sound depends. They give the *form* to the vibration. In fig. 3 we see how the form of the wave is changed by superposing upon a given vibration the first and second overtones, having frequencies twice and three times the frequency of the fundamental tone. The musical relations of these overtones of stretched strings are discussed under HARMONICS (q.v.). The harmonics of a note are the simple harmonic vibrations

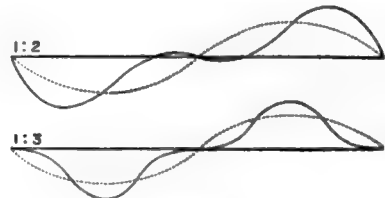

Fig. 3.

into which, according to Fourier's analysis, any steadily recurring periodic motion can be decomposed. The prime or fundamental tone is the first harmonic; and higher harmonics are all overtones. But, as we shall see hereafter, all overtones are not necessarily harmonics.

Air-columns, such as we have in organ-pipes (see ORGAN), vibrate according to laws very similar to those which rule the vibrations of strings. The frequency of the note is inversely as the distance between two successive nodes. One essential difference is that the ends of a stretched string must be nodes, whereas in pipes one or both ends may be *loops*, where the velocities experience their maximum change and the pressure is invariable. In the open organ-pipe both ends are loops, between which one node at least must exist if a sound is produced. This gives the fundamental vibration, and may be diagrammatically indicated, as in fig. 4, *a*. The wave-length is (approximately) double the length of the tube. The second harmonic is produced when two nodes intervene, as in *b* (fig. 4); the third when three nodes intervene, as in *c* (fig. 4); and so on. The wave-lengths of these are respectively the length of the tube and two-thirds

the length of the tube. Hence, if the fundamental tone has frequency 100, the second has frequency 200, the third 300, and so on. In the closed or stopped organ-pipe, again, one end is a node and the other a loop. In fig. 5, *a*, we have a diagrammatic representation of the prime tone, whose wave-length is (approximately) four times the length of the tube. Thus by

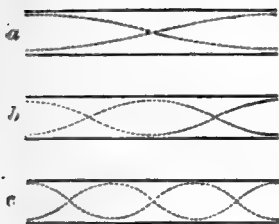

Fig. 4.

simply stopping the one end of an open organ-pipe we lower the prime tone a whole octave. The next possible mode of vibration is indicated in *b* (fig. 5), in which are two nodes. Here the wave-length is $1\frac{1}{2}$ times the length of the tube. In the next mode, with three nodes (fig. 5, *c*), the wave-length is $\frac{2}{3}$ of the length of the tube; and so on to higher harmonics.

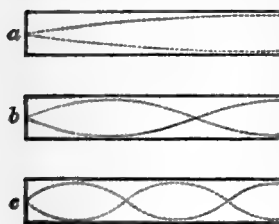

Fig. 5.

If the fundamental tone of a closed pipe has frequency 100, the next possible harmonic will have frequency 300, the next 500, and so on. Thus in any note uttered by an open pipe all the harmonics may enter; but in a closed organ-pipe only those

of odd number can be present. This lack of the even harmonics gives a curious nasal quality to the tone of the closed organ-pipe. By overblowing we may so accentuate the second harmonic in the open pipe as to make it sound a note appreciably an octave higher than the fundamental note. By overblowing the closed pipe the pitch of the note jumps up an octave and a fifth. With flutes and whistles similar effects may be produced.

A tuning-fork is a vibrating bar whose one end is a node. In producing its fundamental tone each prong vibrates so that there is no other node, as in fig. 6, *a*. The next possible mode of vibration is when a second node exists, as shown in fig. 6, *b*. This first overtone is not related to the fundamental tone according to the harmonic series already given for strings and air columns. For example, if the fundamental tone of the tuning-fork is C of the bass clef, the first overtone is two octaves and 7-7736 mean semitones higher—i.e. a little flatter than G \sharp above the treble C. In the case of stretched membranes, vibrating plates, and bells similar complexities hold; and it is impossible to get from them overtones harmonically related to the fundamental tone and to one another. There is no



Fig. 6.

doubt, however, that the characteristic clang of a bell is due to the presence of these anharmonic overtones; and the art in bell-making is to prevent them having a pronounced discordant effect on the ear. By careful manipulation the first anharmonic overtone of a large-sized tuning-fork may be made to sound instead of the fundamental tone, and not infrequently it may be heard along with it. In this latter case it rapidly dies away, and the tuning-fork continues to utter a

pure tone of the simplest harmonic type. When strings or columns of air are vibrating, the harmonic overtones may be picked out by the ear with tolerable ease after a little practice. Their presence may, however, be made evident to the most unmusical ear by the use of resonators.

The function of a resonator is to reinforce the intensity of a note produced by some vibrating body in its neighbourhood. The principle is made use of in all musical instruments. For instance, in the violin the greater part of the energy of vibration of the string does not pass directly to the air, but indirectly through the body of the violin, which vibrates with the string. The sounding-board of a piano plays the same rôle, being set into vibration by the impacts of the waves upon the terminal fixed points of the strings. In these and similar cases a greater mass of air is influenced by the vibrations of the system, the energy originally given to the string is more quickly transferred to the air, and the result is increased intensity. The word resonator is, strictly speaking, applied to a body which resounds to one note only or to one of a definite harmonic series. If a tuning-fork be held in front of the lip of an organ-pipe, one of whose own harmonics has the same pitch as the note of the tuning-fork, the sound uttered by the tuning-fork will be distinctly reinforced. This reinforcement will not occur in the case of a tuning-fork having no harmonic relation to the pipe. The pipe in the above case acts as a resonator. Again, hold down any note on the piano so as to leave the corresponding strings free, and then strike the note an octave lower, or an octave and a fifth, or two octaves lower. Release this latter note, so that its strings become damped, and the former note will be heard distinctly as if it had itself been struck. Its intensity may be reinforced again and again by repeated striking of a lower note of which it is an harmonic. Here the strings of the note that is being held down act as resonators to the corresponding harmonic of the note that is struck. The same effect may be produced by singing a suitable note, or playing it on some other instrument. The boxes to which large tuning-forks are attached are so shaped that the mass of air within them vibrates naturally to the note of the tuning-fork. And just as a pendulum or ordinary swing may be made to describe larger and larger arcs by properly timed impulses, so a resonator responds to the timed pulses of the note to which it is tuned. Helmholtz's spherical resonators, tuned to the successive harmonics of a particular note, are an indispensable part of the equipment of a physical laboratory. Each is a hollow sphere provided with two apertures diametrically opposite each other. The smaller aperture is made in the form of a small projecting tube which can be fitted close into the ear. Through the other and larger aperture the outside disturbance sets the mass of air inside the sphere into vibration. As an example of their use, take the case when the note to which one of the resonators is tuned is sounded by (1) an open organ-pipe, (2) a closed organ-pipe. By placing in turn each resonator to the ear we readily convince ourselves that the successive harmonics are all present in the sound of the open organ-pipe, but that with the closed pipe the even harmonics are absent. When the proper resonator is placed behind a tuning-fork the sound becomes powerfully reinforced. By taking advantage of this principle Helmholtz proved synthetically that vowel-sounds of the same pitch have different harmonics present. By means of the Phonograph (q.v.) Jenkin and Ewing analysed the vibrations produced by vowel-sounds at various pitches; and their results show that the relative intensities of the principal

harmonics present in any given vowel-sound vary with the pitch.

As with all forms of wave-motion, sound may be reflected (see ECHO) and refracted. When a string or air-column is thrown into a steady state of vibration with nodes occurring at regular intervals there is in reality a reflected wave, which, travelling backwards along the vibrating substance, interferes with the forward-travelling wave in the manner already described. Interference (q.v.) is also shown by the phenomenon of beats.

The existence of beats is determined by the coexistence of two notes differing very slightly in pitch; and the number of beats per second is simply the difference of the frequencies. Because of the absence of upper harmonics in the note given by a tuning-fork, the phenomenon is produced in its purest form by means of two tuning-forks originally in unison but thrown slightly out of tune by weighting the one tuning-fork with a small piece of wax attached to it. If the tuning-forks, for example, have frequencies 300 and 302, there will be heard two beats per second—i.e. the intensity of the resultant sound will vary from zero to a maximum and back to zero again twice every second. The reason of this will be easily seen if we consider the resultant effect of the two sets of waves at different times. For, since the two sounds have the same velocity, it is clear that across any surface set in the path of the rays of sound the higher note will transmit two more waves per second than the lower note, or one more wave in half a second, or half a wave extra in a quarter of a second. Suppose that at the beginning of the second chosen the nearly equal waves combine crest to crest and trough to trough, so as to produce an increased intensity; then a quarter of a second later the slightly quicker vibration will have gained half a wave-length on the other, crest will fall with trough and trough with crest, and little or no vibratory motion will be the result. At the half second, crest and crest will again coincide, and the resultant sound once more reach a maximum; and so on indefinitely. The transition from maximum to minimum loudness is of course gradual. If notes in which higher harmonics exist are used the beating is not so simple. For example, with open organ-pipes tuned to frequencies 300 and 302, not only will the primes beat twice a second, but the second harmonics 600 and 604 will beat four times a second, the third harmonics six times a second, and so on. There is generally no difficulty getting beats from a piano-forte note, since the two or three strings that belong to the note are rarely in accurate tune.

In general if m and n are the vibration numbers of two notes sounding together which give beats, ($m - n$) will be the number of beats per second. If this beating does not occur oftener than two or three times a second the ear is not distressed. Rapid beating, however, produces very unpleasant sensations even after it has reached a rapidity too high to be counted. When the difference of frequencies ($m - n$) is greater than 25 or 30, the note of frequency ($m - n$) is heard in addition to the two original notes. There is no difficulty in hearing this differential tone, as it is called, when the two notes are sufficiently loud. On instruments giving sustained sounds, such as the organ, harmonium, and concertina, very marked differential tones are produced; and to an ear trained to their perception they are recognisable on the piano. When the difference of the frequencies lies between 30 and 100 the rattling of the beats may often be distinguished from the low hum of the differential tone; so that we are not warranted in regarding these two phenomena as of the same nature. By bringing the two notes by different

courses to the two ears we can hear the beats, but cannot hear the differential tone. Moreover, in addition to the differential tone ($m - n$), there are other differential tones of frequencies ($2m - n$), ($m - 2n$), &c., and also at times a weak summational tone of frequency ($m + n$). This last-named tone was discovered by Von Helmholtz, to whom we owe the complete discussion of the origin and significance of these Combinational Tones, as they are collectively termed. Two kinds are distinguished by him. If the vibrations transferred from the vibrating body to the air are very large the simple law of superposition may not hold. A simple pendular vibration, such as a tuning-fork may give, will when transferred to the air lose to some extent its simple harmonic character, and higher harmonics will enter in. If two simple pendular vibrations act powerfully on the air combinational tones will be produced in addition to the higher harmonics of the two original notes. These combinational tones existing in the powerfully disturbed air can be reinforced by use of resonators. Combinational tones of the second kind cannot be so reinforced, since they are produced in the ear itself. They are due to the asymmetric character of the drum of the ear, which cannot respond to two coexisting vibrations without producing combinational tones. The frequencies of these combinational tones, whether of the first or second kind, are all included under the general formula $Mm \mp Nn$, where m and n are the frequencies of the original notes, and M and N are integers from zero upwards. As experiment shows, only the first few integers are of any importance, and no summational tone of higher order than $m + n$ (M and N both unity) has ever been heard. As an example, take two notes having frequencies 200 and 315. Their principal combinational tones will have frequencies 115 (315 - 200) and 85 ($2 \times 200 - 315$). This latter may be regarded as the differential tone between the lower prime and the first combinational tone. These two tones can both be heard if the intensities of the sounds are sufficiently strong. Both theory and experiment show that the comparative intensity of combinational tones grows rapidly as the intensities of the real notes are increased, and also that combinational tones of low pitch are most prominent.

As first brought out clearly by Helmholtz, combinational tones are of peculiar interest when the two notes form a consonant interval. Thus, take any two notes a musical fourth apart. Their vibration numbers may be represented by $3n$ and $4n$. Their principal differential tone will have the frequency n ($= 4n - 3n$), and will therefore form the fundamental tone of which the given two are harmonic overtones. Again, take any perfect triad (*do, mi, sol*) having frequencies $4n$, $5n$, $6n$. Each successive pair gives the same differential tone n ; the first and last together give the differential tone $2n$. Thus we hear the low tone which is harmonically fundamental to all, and its octave. In some cases the differential tone becomes so loud that the real notes which are being sounded become merged in it as upper harmonics. If the notes of the triad are not in perfect tune the differential tones will not be harmonically related. On an organ tuned in equal Temperament (q.v.) the chord built upon the treble C consists of notes having frequencies 522, 657.7, 782.1 (see PITCH). The two lowest differential tones have frequencies 135.7 and 124.4—notes which, sounding together, produce 11.3 beats per second. The ear that has accustomed itself to the pure harmony of the perfect triad will easily recognise a certain dissonance in the triads given by pianos and organs.

Beats always mean the coexistence of two notes of nearly the same frequency. If on any organ

or harmonium any note and its fifth are struck together beats are heard. It is indeed by getting rid of these beats that we finally effect a perfect tuning of say two contiguous violin-strings. These beats on the tempered instruments are due to the fact that the interval is not a true fifth, so that the higher harmonics which are present cause beating combinations. This is shown by comparing the first three harmonics of notes which form (1) a perfect fifth and (2) a tempered fifth.

PERFECT FIFTH.			TEMPERED FIFTH.		
C.	G.	Beats.	C.	G.	Beats.
523	783	..	522	782.1	..
1044	1044
1566	1566	0	1566	1564.2	1.8
&c.	&c.	..	&c.	&c.	..

Similar results may easily be obtained for all tempered intervals, if the higher harmonics exist in sufficient strength. We may, however, make use of the combinational tones in producing beats. For instance, by the rule given above, we get for the first combinational tones 260.1 and 261.9, which beat also 1.8 times a second. The second combinational tone is intensified by the actual presence of the second harmonic of C; and we can make the beating still stronger by sounding the octave along with C and G.

All vibrations in air of sufficient intensity and suitable frequency produce sound-sensations. The highest frequency which gives an audible sound is about 70,000. This is much higher in pitch than the highest notes used in music. For example, the frequency of the highest note on the pianoforte falls short of 4000. Very high pitched sounds near the limit of audibility are very disagreeable to the ear; and sounds which are heard by one person may be, because of their high pitch, quite inaudible to another. There are many noises of whose pitch it is impossible to say anything definite. They are no doubt confused mixtures of tones of fluctuating pitch. König has pointed out that the peculiar quality or timbre of trumpet notes and other notes of piercing quality is in great measure due to a fluctuating character in the vibration. The various overtones, both harmonic and anharmonic, do not combine with the prime in a steady periodic manner. Anharmonic overtones must of necessity produce fluctuations in the periodic character of the note; and the theory of quality cannot be complete without taking their existence into account. In this direction Helmholtz's theory requires extension.

Of great value and interest are Helmholtz's investigations on the forms of vibration of strings, especially of violin strings. If we can experimentally determine the form of the wave into which the string is thrown when bowed, we can by Fourier's mathematical process calculate the harmonics that enter in. Helmholtz solved the problem by viewing through a microscope the motion of a small white speck at different points of the string, the microscope itself being attached to the vibrating end of a tuning-fork, and being so made to execute a simple harmonic motion at right angles to the direction of vibration of the white speck. The principle of the method is identical with that introduced by Lissajoux in obtaining what are known as Lissajoux's Figures. Two tuning-forks, with bright reflecting surfaces fixed to their vibrating ends, are arranged so that while one vibrates to and fro vertically, the other vibrates to and fro horizontally. A beam of light is reflected from the one upon the other, and after a second reflection is focussed sharply upon a screen or viewed in a telescope. When either fork is vibrating alone the image on the screen will vibrate also along a straight line. But when both are vibrating together the light spot on the screen will execute

the motion which is the resultant of the two mutually perpendicular vibrations. Definite figures are obtained only when the two forks are tuned accurately in unison, or by some simple interval apart. For example, if the two forks give the same note the figure on the screen will be an ellipse or one of its extreme forms, the circle or straight line. If the forks are *very slightly* out of tune—imperceptibly so to the ear—the ellipse will gradually change shape, passing from the circle to the straight line. The figures obtained when the ratio of the frequencies is as 1 : 2 (the octave), 2 : 3 (the fifth), 3 : 4 (the fourth), and so on, are very beautiful; and if the interval is just short of perfect tuning the gradual passing of the figure through a series of related but slightly differing forms is very instructive. The experiment is valuable as giving an optical demonstration of the laws of combination of vibratory motions in lines inclined to one another. Compare the explanation of elliptical and circular Polarisation (q.v.) of light.

Although sounds come to our ear through the air or other fluid as waves of compression and rarefaction, they may have their origin in vibrations of quite a different type. In solid substances there are distortional waves as well as compressional waves. In a pure distortional wave the substance changes form and does not change bulk. Its existence depends upon the Rigidity (q.v.) of the substance. In gases and liquids only compressional waves can exist, and these depend upon the compressibility (see COMPRESSION). When a bar, stretched string, or plate is set into vibrations a certain kind of elasticity is brought into play, and a certain strain produced, which in general involves both change of form and change of bulk. Corresponding to this there is an appropriate stress whose ratio to the strain is the coefficient or modulus of elasticity upon which the velocity of the wave depends. Calling this modulus E , we find for the velocity of a vibratory wave the expression $V = \sqrt{E/D}$, where D is the density of the substance set into vibration.

This formula was first applied by Newton to the case of air. Assuming Boyle's Law (see GAS), he obtained the expression $\sqrt{P/D}$ for the velocity of sound, where P is the pressure. But when the proper numbers are put in the velocity is found to fall short of its true value by about 180 feet per second, or by one-sixth of the whole. Newton's assumption is in fact false. Boyle's Law holds only when, throughout the changes of pressure and density, the temperature remains constant. But in the rapid condensations and rarefactions which accompany audible sounds the temperature varies, increasing during condensation and decreasing during rarefaction. Now rise of temperature means increase of pressure and fall of temperature decrease; so that the result of these temperature changes is to increase the forces at work—i.e. to increase the elasticity. Laplace first made this necessary correction to Newton's calculation. We must in fact multiply the pressure by 1.41, which is the square of 1.2 nearly. The complete theory gives for the velocity of sound in dry air at a temperature of t° F. the value

$$V = 1122 + 1.09(t - 60) \text{ feet per sec.,}$$

which is as near as may be to the mean of experimentally determined values.

The quantity E is the same for all the true gases. Hence the velocity of sound in gases varies inversely as the square root of the density. In other words, a given wave-length will vibrate proportionately faster. Thus, if an organ-pipe be blown with hydrogen gas in it instead of air, the note will leap up nearly two octaves in pitch, since the density of air is 14.4 times that of hydrogen.

In the case of any liquid the quantity E is the reciprocal of the compressibility, which is not appreciably affected by slight changes of temperature. For water the density is unity, and E is 2.08×10^{10} . Hence $V = 144,000$ centimetres (4730 feet) per second. Colladon's value, determined by experiments on the Lake of Geneva, was 143,500. Thus sound travels four times faster in water than in air. In the case of solids, in the form of thin rods or wires, waves of compression will travel at still higher speeds. The quantity E is practically Young's modulus of elasticity. In steel $E = 2.14 \times 10^{12}$, and $D = 7.85$; hence $V = 522,000$ centimetres (17,130 feet) per second, or nearly sixteen times the velocity of sound in air.

The standard book on Sound is Lord Rayleigh's *Theory of Sound* (1878; 2d ed. 1894). Tyndall's *Sound* is a popular exposition of the subject, illustrated by well-chosen experiments. Helmholtz's *Tonempfindungen, or Sensations of Tone* (Eng. trans. 1875), discusses in a highly original manner the borderland between sound as a branch of physics and music as a branch of æsthetics. Sedley Taylor's *Sound and Music* (2d ed. 1883) is a simple exposition of the chief of Helmholtz's discoveries. König's *Expériences d'Acoustique* (1889) contains some valuable novelties. See *Nature*, vol. xliii. 1890; also the articles ACOUSTICS, HARMONICS, MICROPHONE, TELEPHONE, VOICE.

Sound (A.S. and Ger. *Sund*), the strait which leads from the Cattegat into the Baltic Sea, having Sweden on the east and the Danish island of Zealand on the west. It forms the usual passage from the North Sea to the Baltic, is 50 miles long and nearly 3 miles wide at its narrowest part, between the towns of Helsingborg and Elsinore. Its passage, defended by the strong Danish castle and fortress of Kronborg, was forced by Nelson in 1801 (see COPENHAGEN). From the 15th century all ships using this channel, except such as belonged to certain of the Hanseatic towns and one or two others in the Baltic, were charged toll for passing through. These Sound Duties were abolished on 14th March 1857 by a treaty between Denmark and the principal maritime powers. A pecuniary compensation of £3,386,260, of which Great Britain paid £1,125,206, was given to Denmark, which bound itself to maintain the lighthouses and superintend the pilotage of the Sound.

Sound, in fishes. See AIR-BLADDER.

Sounding. From the earliest times navigators have ascertained the depth of the sea in shallow waters by means of a hand-lead. This consists of a hempen rope, marked off into fathoms by worsted of different colours, to which is attached a leaden weight armed with tallow or having a valved cavity to bring up a sample of the deposit at the sea-bottom. In addition to the hand-line steamers are now often furnished with a machine to ascertain the depth while under way. This consists of a winch, wire rope, fair-lead, and a sinker provided with a glass tube, which, on being removed after a sounding, indicates by the action of sea-water on a chemical coating the hydrostatic pressure on the air in the tube and consequently the greatest depth reached by the sinker. One of the latest inventions to ascertain the depth of water while a ship is in motion is the 'submarine sentry.' This is a kind of submarine kite, which is trawled after the ship at a depth of 25 or even 40 fathoms, and as soon as the kite strikes the bottom the fact is indicated in the chart-room. Very many attempts were made to sound the deep sea before satisfactory results were obtained. Magellan during the first voyage round the world attempted to sound the open ocean in the Pacific. Not having reached bottom in 200 fathoms he naively concluded that he had crossed the deepest part of the ocean. Ellis in 1749 and Mulgrave in 1773 failed to sound the deep

sea. Sir John Ross was more successful, for in 1818 he sounded in the Arctic seas in 1050 fathoms, bringing up a specimen of the bottom. Sir James Ross during his Antarctic expedition sounded in 2425 fathoms, and on two occasions no bottom was found with 4000 fathoms of line. There was a great uncertainty about these depths owing to there being no sure indication when the weight reached the bottom. Brooke, an officer of the United States navy, in 1854 gave a great impulse to deep-sea sounding by introducing a detaching weight, the sinker being left at the bottom, and only a small tube with a sample of the bottom being hauled up with the line. A modification of this apparatus was used during the *Challenger* expedition, 3 or 4 cwt. of iron sinkers being left at the bottom in each sounding. A sudden decrease in the rate at which the rope was running out showed when the sinkers had struck the bottom. The sounding line was $\frac{3}{4}$ inch in circumference, and in addition to the sinkers and sounding tube there were attached to it several thermometers, a water bottle, piezometers, and other instruments. Deep-sea sounding for telegraphic purposes is now carried on by means of wire rope which was introduced by Sir William Thomson (Lord Kelvin). The friction of the wire in passing through the water is much less than that of the hemp rope. It runs out and can be hauled in much more rapidly; a smaller sinker can be used, and this often can be pulled up along with the wire. When only the depth is required a fine twine with a weight is now used in sounding in deep water, the whole being cut adrift when the depth is ascertained. The time employed in hauling in the line is thus saved, which well repays the loss of twine and weight. The deepest soundings and results are noted at SEA, PACIFIC, &c.

See *Narrative of the Cruise of H.M.S. Challenger*, vol. i.; *Deep-sea Sounding and Dredging*, by Sigsbee; and *Challenger Report on Deep-sea Deposits*, by Murray and Renard.

Soup. As a general rule a soup is made by boiling meat or vegetables in what is called 'stock.' To prepare the latter the cook obtains fresh meat, bones, and vegetables such as carrots or leeks, and after the addition of salt allows them to simmer for some hours in sufficient water. The stock is the infusion thus prepared, and contains small quantities of starch, if vegetables have been used, and in any case some gelatine, which will often cause it to solidify on cooling. Together with a small quantity of nourishment, the infusion has extracted from the meat and vegetables those pleasant flavoured extractives which give it taste. Taking this stock as a basis, the various soups are made by boiling with it the bones and flesh of the hare, ox-tails, &c., and vegetables such as carrots, potatoes, turnips, rice, sago, &c.

If we view the preparation of soups from the point of domestic economy, the following facts must be kept in mind. Bones, otherwise valueless to the householder, contain much nutritive gelatine, which is extracted from them in the preparation of stock; no bones should therefore be thrown away, for their use is a clear gain. It is to be remembered that meat on the other hand yields little of its nutritive matter to the stock, and if the meat be thrown away, as it generally is in England, the greater part of its value is lost. It is the greatest waste of nutritive material to prepare a stock from gravy beef, which yields hardly more to the water than its flavouring extractives; yet householders regularly buy meat for this wasteful purpose. If then it is an object to obtain the nutritive value from the food, the meat should as much as possible be retained and eaten. While the greatest extravagances may be thus committed by using meat, which might be eaten as such, in the

preparation of stocks and clear soups, it is certainly the case that equal wastefulness is frequently committed by throwing away the water in which meat, fowls, fish, bacon, and pork have been boiled. These always contain some nutritive matter, and every capable cook should be able to make it the basis of an excellent soup.

From a dietetic point of view we may regard soups as gastric stimulants and as articles of nutrition. They owe their stimulating properties to their warmth, and the salt and flavoured extracts they contain, and are of value inasmuch as they cause a ready flow of digestive juice preparatory to the more substantial portions of the repast. To some persons this stimulating action is a necessary preliminary to a properly digested meal, and it is often obtained by more harmful resorts, say to sherry and bitters. Most persons after a hard day's work, and with the bodily energies below par, have experienced the difficulty of at once facing a plate of cold mutton or beef, which would however have been quite acceptable if it had been introduced by a basin of hot broth.

From the point of view of nourishment little can be said of clear soups and beef-tea, and numberless invalids are yearly starved out of existence by doctors and nurses who imagine that by stewing a pound of gravy beef the nourishment goes to the water. Soups thickened by vegetables, such as peas, potatoes, &c., are highly nutritious, and pieces of meat and thick gravy retained in the soup add greatly to its nutritive value.

Soutane, the French for a Cassock (q.v.).

South, SIR JAMES (1785-1867), astronomer, in 1829 elected President of the Astronomical Society, and knighted the following year.

South, ROBERT, a great English preacher, was born a London merchant's son at Hackney in 1633, educated for four years under Busby at Westminster, and elected student of Christ Church, together with Locke, in 1651. Three years later he took his bachelor's degree, and that same year wrote a Latin copy of verses congratulating the Protector Cromwell on his peace with the Dutch. He took his M.A. in 1657, but not, it is said, without some opposition from Dr John Owen, then Dean of Christ Church. Next year he received orders from a deprived bishop, and was appointed in 1660 public orator to the university. During his tenure of this office occurred many striking occasions for his eloquence—the installation of Clarendon as chancellor in 1661; the burial of Juxon and the translation of Laud in July 1663; the visit of the king and queen, and the presentation of Monmouth for a degree, in September 1663; the foundation of the Sheldonian Theatre in 1664, and its formal opening in 1669. His vigorous sermons, full of sarcastic mockery of the Puritans, were delightful to the restored royalists. He became domestic chaplain to Clarendon, and further preferment followed quickly. In 1663 he was made prebendary of Westminster, canon of Christ Church in 1670, and rector of Islip in Oxfordshire in 1678. He went as chaplain with Clarendon's son, Laurence Hyde, afterwards Earl of Rochester, on his embassy to congratulate John Sobieski on mounting the throne of Poland (1677), and in December wrote from Danzig his impressions in the long and interesting *Account* sent to Pocock, the Oxford professor of Hebrew. It is supposed that South might have been a bishop if he would, and there is one story on record of his preaching in 1681 before the king on 'The lot is cast into the lap' (Prov. xvi. 33). Speaking of the strange accidents of fortune he said, 'And who, that had beheld such a bankrupt, beggarly fellow as Cromwell, first entering the parliament-house with a threadbare, torn cloak and a

greasy hat (and perhaps neither of them paid for), could have suspected that in the space of so few years he should, by the murder of one king and the banishment of another, ascend the throne, be invested in the royal robes, and want nothing of the state of a king but the changing of his hat into a crown?' At these words the king fell into a violent fit of laughter, and turning to Lord Rochester, said, 'Ods fish, Lory, your chaplain must be a bishop, therefore put me in mind of him at the next death.' Unfortunately for the story, this sermon—one of those published by South himself—is inscribed as 'Preached at Westminster Abbey, February 22, 1684-85,' a fortnight after Charles's death. South appears to have thought Charles too lenient rather than too severe against religious sectaries, but during the reign of James he suppressed his disapproval of the 'Declaration of Indulgence,' although Papists were almost as hateful to him as Puritans, and it is interesting to find in three of his published sermons, preached in 1688, not a single intelligible political allusion. Yet we are told that during Monmouth's rebellion he professed himself ready, if occasion required, to exchange his black gown for a buff coat. After some hesitation South acquiesced in the Revolution, but blazed out with anger against the proposed schemes of Comprehension and Toleration which quickly came to nothing. In 1693 began his great controversy with Sherlock, Dean of St Paul's. The latter, at first a Nonjuror, had been suddenly converted to the more politic course by Bishop Overall's *Convocation Book* (written 1606, but not published till 1690), and had been rewarded by being reinstated as Master of the Temple and appointed Dean of St Paul's. To the Socinian controversy then disturbing the minds of Englishmen he had contributed *A Vindication of the Doctrine of the Trinity*, the intention to prove that there was nothing in the dogma contradictory to right reason. In his endeavour to adapt it to the more modern philosophy he unhappily employed phraseology too capable of ambiguity, and such phrases, for example, as his description of the Three Persons of the Divine Tri-unity as 'Three distinct infinite Minds or Spirits' having 'self-consciousness and mutual-consciousness,' were loudly denounced as mere Tri-theism. South flung his *Animadversions* anonymously into the fray, but the bitter irony and fierce sarcasms quickly betrayed his hand. The book showed ample learning and masterly incisiveness of logic, but too large a part was mere abuse and personal invective. Not content with demolishing Sherlock's learning, he abuses his style, his orthography, the errors of the press, and even descends so low as to sneer at him as a henpecked husband. Sherlock published a *Defence*, to which South rejoined, and still anonymously, in his no less vigorous *Tri-theism charged upon Dr Sherlock's new notion of the Trinity*. The controversy became the talk of the town, and an extant doggerel ballad, beginning 'A dean and prebendary had once a new vagary,' satirises it together with Burnet of the Charterhouse's attack upon the Pentateuch in his *Archæologia*, as having by its noise driven religion itself away the while. The king himself interposed by an injunction addressed to the archbishops and bishops to the effect that no preacher should advance views on the Trinity other than those contained in Scripture, and agreeable to the three Creeds and the Thirty-nine Articles. One of the last things recorded of South is his activity in making interest on Dr Sacheverell's behalf, and he is said to have refused the see of Rochester and deanery of Westminster on the death of Dr Sprat (1713). He survived till eighty-three, died on Sunday, 8th July 1716, and was buried in Westminster.

South's sermons are masterpieces of clear thought expressed in direct vigorous English, sometimes rising to splendid eloquence, and often seasoned with a wit and sarcasm altogether unusual in the pulpit, and sometimes far beyond the limits of propriety. A masculine intellect, a mastery of arrangement and analysis, and an uncompromising strength of conviction and of confidence in his own opinions were qualities enough to make a great preacher, but the one supreme gift of the orator, that of genuine and quickening enthusiasm, was denied him. Still more, even his noblest passages are too often marred by a bitterness and party-spirit which warped his judgment and clouded his intellect with prejudice. 'A learned but ill-natured divine,' as Burnet calls him, he abhorred all mysticism and extravagance, sneers at the new philosophy and the recently founded Royal Society, and carried to a height unusual even among royalists the fatal Stuart theories of passive obedience and the divine right of kings. Yet, though South loved to be called the 'preacher of the Old Cavaliers,' he did not spare their vices, while it still remains true, as Dean Lake says, that hatred of vice is far less prominent in his preaching than hatred of Nonconformity. Yet South could rise to the height of a great argument, and such sermons as that on 'Man made in the Image of God' give him rank among the greatest masters of English eloquence. Just as on the one side his power of wrapping up in homely words the bitterest ridicule and invective recalls the stronger hand of Swift, so on the other his positiveness of mind, dialectic skill, and power of passionate indignation reminds us of the greater Bossuet.

He himself published many single sermons, and a collected edition in six volumes in 1692, which went through various editions, and was supplemented by five additional volumes in 1744. In 1717 appeared his *Posthumous Works*, with a Memoir, also his *Opera Posthuma Latina*. The foregoing were republished at the Clarendon Press, Oxford, in 7 vols. in 1823 (5 vols. 1842). A useful edition of the sermons was that published by Bohn (2 vols. 1844). See the *Quarterly Review*, vol. cxxiv. (1868), and Dean Lake in 'Classic Preachers of the English Church,' 1st series (1877).

South African Republic. See TRANS-VAAL.

South African Company. See RHODES (C. J.), and ZAMBESIA.

South America. See AMERICA.

Southampton, a municipal, parliamentary, and county borough and important seaport, in the south of Hampshire, 12½ miles SSW. of Winchester, 23½ NW. of Portsmouth, and 79 SW. of London by the London and South-western Railway (1840). It occupies a peninsula at the head of Southampton Water, and between the estuary of the Test on the west and south and the mouth of the Itchen on the east. There are considerable remains of the 14th-century town-walls, and four out of seven gates, the Norman Bargate being much the finest, though shorn of its effigies of Sir Bevis of Hampton and the giant Ascapard. Southampton is furnished with the usual municipal and other institutions common to all thriving towns, and has besides the Watts Memorial Hall (1876), a grammar-school (1553; rebuilt and reorganised 1872-75), the Hartley Institution (1862), and the headquarters of the Ordnance Survey (1857). St Mary's Church (1878-79), by Street, is a memorial to Bishop Wilberforce. St Michael's Church, the oldest in the borough, contains Norman tower arches, and several of the private houses are of Norman architecture. The *Domus Dei*, or God's House, dates from the end of the 12th century, and is one of the earliest hospitals in England; in its chapel (now used for French service) are buried the Earl of Cambridge, Lord Scrope, and Sir Thomas

Grey, executed by Henry V. for treason in 1415. The docks, first opened in 1842, can float the largest steamers, and have been greatly extended and improved. A new tidal dock, 18 acres in extent and having a minimum depth of 26 feet at low-water spring-tides, was opened by Queen Victoria on 26th July 1890; its cost was £300,000. A handsome pier was opened by the Duke of Connaught in 1892; and a new graving-dock, 750 feet long by 112½ feet broad, was opened by the Prince of Wales in 1895. Southampton is the place of departure and arrival of the West India and Brazil and the South African mail steam-packets, and has a large trade with the Continent. In 1896 the gross tonnage of the shipping was 2,998,254 tons. Yacht and ship building and engine-making are actively carried on. Incorporated as a borough by Henry I., Southampton returns two members to the House of Commons. Pop. (1801) 7913; (1851) 45,305; (1881) 60,051; (1891) 65,325.

Southampton supplanted the Roman station of *Clausentum*, which stood about one mile to the north-east, and its foundation is ascribed to the Anglo-Saxons. It is called Hamtune and Suth-Hamtun in the Saxon Chronicle, and Hantune in the Domesday Book. After the Conquest Southampton, from which there was ready transit to Normandy, began to prosper rapidly, and in early times it traded with Venice and Bayonne, Bordeaux and Rochelle, Cordova and Tunis. A great part of it was burned by the combined French, Spanish, and Genoese fleets in 1338, and in the following year its defences were strengthened. Southampton is the birthplace of Isaac Watts (to whom in 1861 a monument was erected in the West Park), of Charles Dibdin, and of Sir J. E. Millais.

SOUTHAMPTON WATER is a fine inlet, stretching north-westward from the point at which the Solent and Spithead unite. It is 11 miles long and nearly 2 miles wide. The Isle of Wight, which intervenes between the Southampton Water and the Channel, forms a magnificent natural breakwater, and occasions a second high-water two hours after the first. Southampton Water receives the Test or Anton, Itchen, and Hamble.

See the map at the article PORTSLOUGH; J. Silvester Davies' *History of Southampton* (1883); and F. M'Fadden's *Vestiges of Old Southampton* (1891).

Southampton, HENRY WRIOTHESLEY, EARL OF (1573-1624), the friend and patron of Shakespeare (q.v., p. 364), was mixed up with Essex's insurrection, took part in the colonisation of Virginia, was imprisoned in 1621 for opposition to the court in parliament, and died of fever at Bergen-op-Zoom whilst fighting for the Dutch.

South Australia has Western Australia on one side and Queensland, New South Wales, and Victoria on the other. Originally it lay between 132° and 141° E. long., extending only to 26° S. lat. Inclusive of the Northern Territory, it now crosses the continent between 129° and 141° E., being 1850 miles in length. The present area is 903,690 sq. m. (of which the Northern Territory contains 523,620), or more than fifteen times the size of England and Wales. Less barren than Western Australia, it has not the fertility of the eastern colonies, from want of sufficient rain. Two dry peninsulas, Yorke and Lincoln, or Eyria, point southward, enclosing two great inlets—Spencer's Gulf and Gulf St Vincent. Kangaroo Island lies between. A chain of mountains runs from the south-east up to the Lake District depression. Ranges, with outliers, are seen right across to, and through, the Northern Territory; but few points rise to 3000 feet: Lofty, near Adelaide, is 2300 feet. The Murray River of eastern Australia has its mouth in South Australia. Torrens, by Adelaide, and a few other short streams reach the

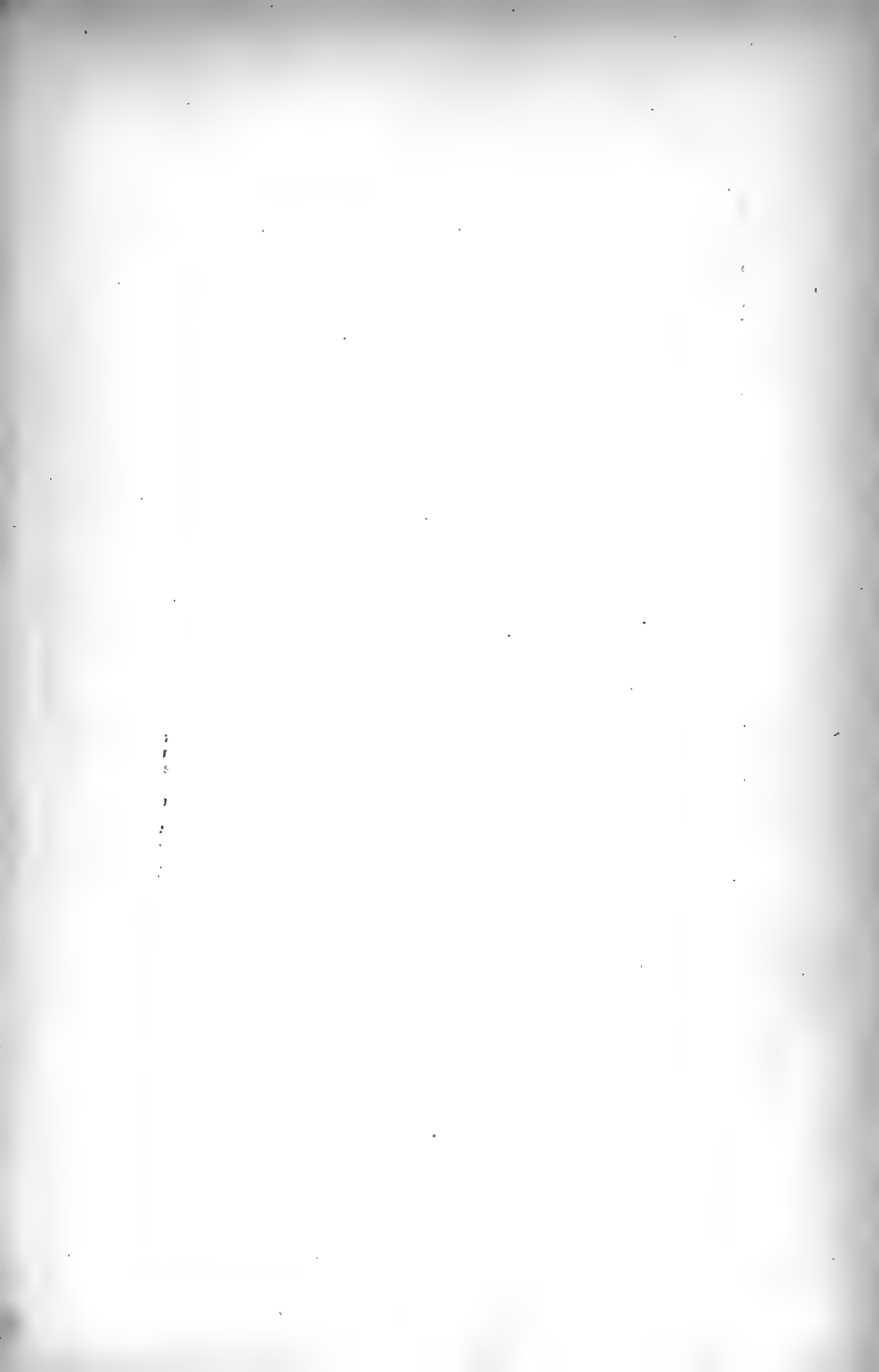

SOUTH AUSTRALIA

PROPER

EXCLUSIVE OF NORTHERN TERRITORY

Scale of English Miles
0 50 100 150 200

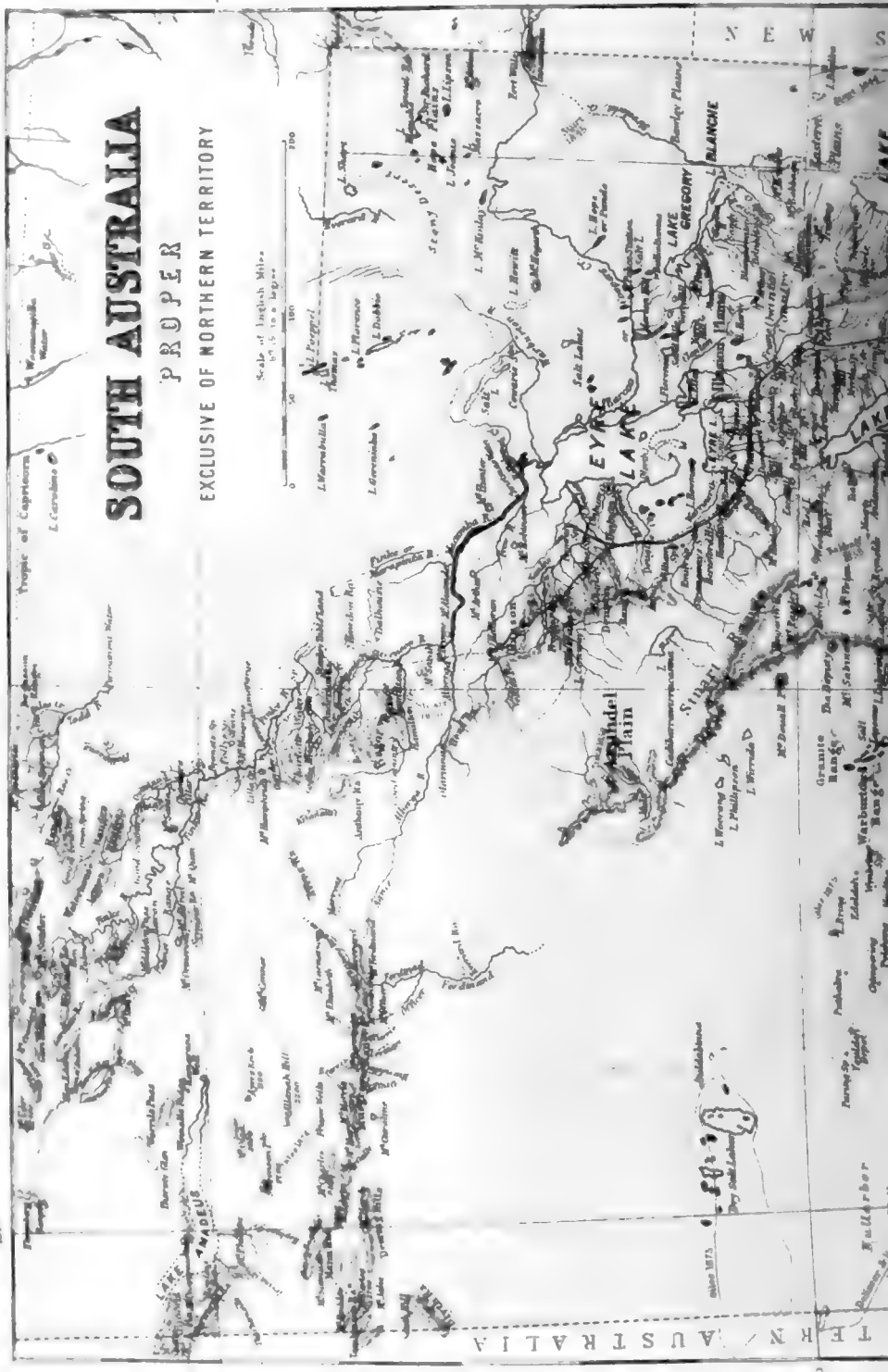

WESTERN AUSTRALIA

NEW SOUTH WALES

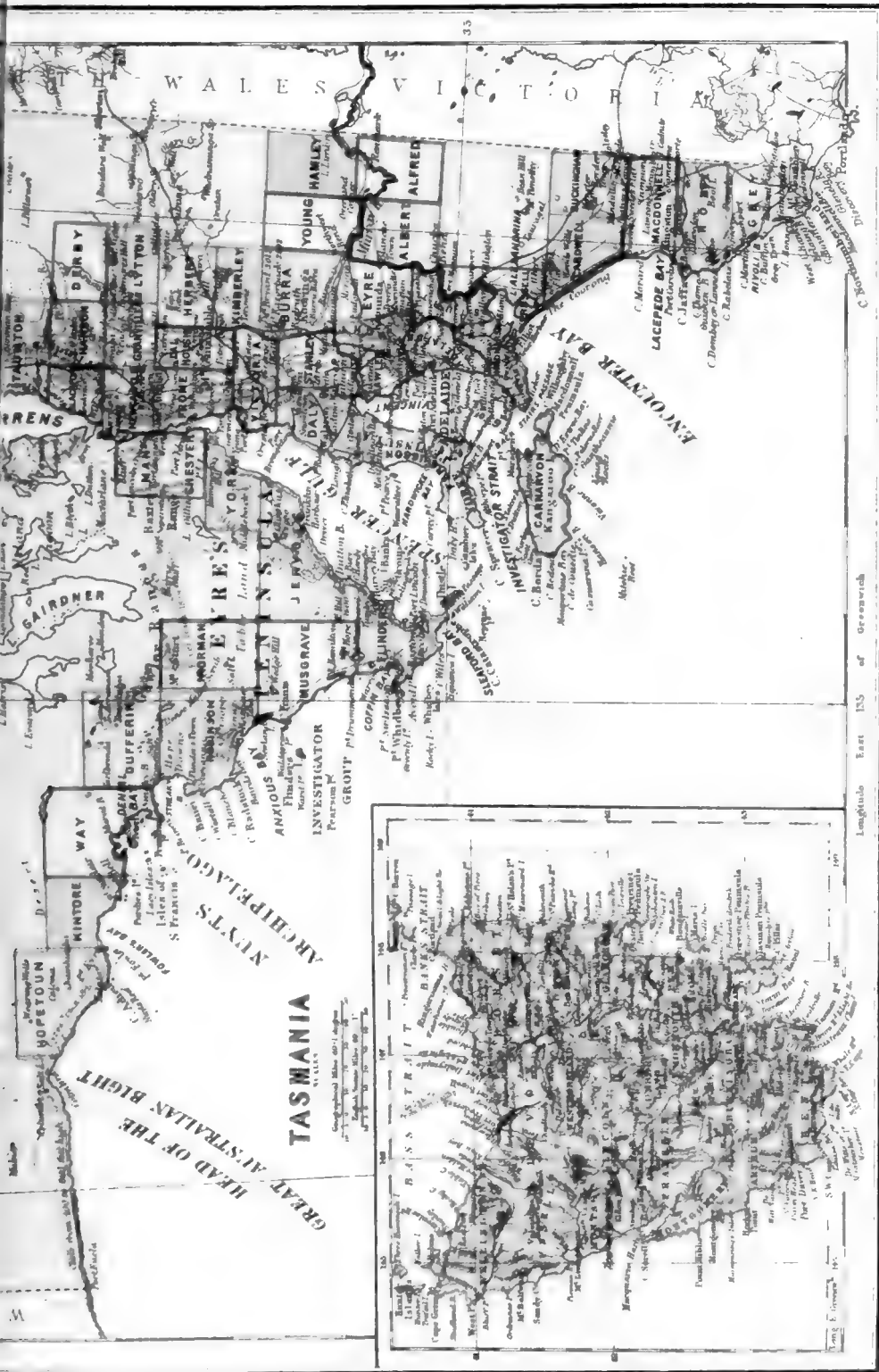

Scale of Greenwich

Longitude East 135 of Greenwich

W & R CHAMBERS LIMITED LONDON & EDINBURGH



sea. Macarthur, Roper, Victoria, and Liverpool enter the Indian Ocean. Salt lakes, as Torrens, Gairdner, and Eyre, are inland; Victoria, Albert, and the Coorong are near the Murray outlet. Adelaide, the capital, is in 34° S. lat. The ports are Glenelg, Adelaide, Wakefield of St Vincent's Gulf, Lincoln, Pirie, Augusta of Spencer's Gulf, Macdonnell in the south-east. The area of settlement is mainly in the south-east corner of the colony.

History.—The north coast was clearly laid down in charts of the 16th century—even as soon as 1542, the primary discovery being due to the Spaniards or Portuguese. The Dutch ship *Gulde Zeepard*, 1627, sailed along the south coast, eastward of Cape Leeuwin, as far as the western border of South Australia. Flinders made known in 1802 the two great gulfs and Kangaroo Island, meeting the French explorer Baudin in Encounter Bay. Grant, in the *Lady Nelson*, 1800, sighted land to the south-east. The settlement of the region was proposed by a private company in 1831, and in 1835 a grant of land was made to the South Australian Association. The first party landed on Kangaroo Island, July 1836, and possession of the country was taken on the Adelaide Plains, December 28th. In 1841 South Australia became a Crown colony. After the usual colonial fluctuations of fortune, progress was established by the Burra Burra copper-mine (see Vol. I. p. 588), and the cultivation of large areas of corn.

Geology.—South Australia is undeniably of more recent formation, as a whole, than eastern or Western Australia. It is comparatively deficient in both flora and fauna, and has a larger surface of later formed rocks. Several ancient formations have few or no fossils to indicate their age, though Lower Silurian beds are recognised as decidedly fossiliferous. Mountain-ranges illustrate the primary rocks, and show traces of a Cambrian period. The rise from Cape Jervis to the Lake District appears older than that more northward, which may be Devonian. Metamorphisms are abundantly exhibited, and both granite and basalt occur frequently as intruding veins, as well as in mountain masses. Silurian beds are declared 30,000 feet thick; granite over extensive areas is detected westward and northward; Palaeozoic slates of superior quality are of commercial value. Mining for metals is conducted in these older rocks. The Secondary or Mesozoic beds are not so common, though Jurassic ones are crossed in the interior. The Cretaceous development rests on the upturned edges of earlier and disturbed strata. The Tertiary rocks are of great extent and considerable variety. The upper reaches of the Murray River are marked by Miocene, a formation conspicuous in other localities under the appellation of *Desert Sandstone*, the disintegration of which furnishes the material for far-sweeping sands. In parallel and yet shifting sand-dunes they proved a trial to early explorers. Sand drifts, the debris of Pliocene beds, have swept over what had been fertile tracts and increased the aridity. The Lower Murray has dug its way through hundreds of miles of limestone bearing marine fossils. The land is poor where the arenaceous quality predominates, but fertile where the calcareous is near the surface. As coralline limestone one observes the banks of the great sea-lake Coorong. Farther to the south-east, near the Victorian border, lies the charming and productive Mount Gambier district, with its extinct craters, subterranean rivers, native wells, stalactitic caverns, and luxuriant vegetation. Lava and volcanic ash walls rise through the Tertiary limestone to form the Devil's Punchbowl or the Devil's Inkstand. Around the hollowed cone of Mount Schank are bands of flint in the limestone. Singular soda-

springs occur in the recent beds of the interior, with silt around the basins. Pleistocene strata cover a large area, but are not of great depth. The Mount Gambier discharges of lava and ash belong to that period. Extensive remains of the gigantic herbivorous Diprotodon bear witness to different meteorological conditions; the drying up of inland waters must have caused its destruction. Evidences exist of glacial action at another age. During this century a decided rise of part of the southern coast-line has been observed.

The *climate* over so extensive an area as that of a third of Europe cannot but be varied, though no other Australian colony has so much uniformity of weather. Generally speaking, it is both dry and warm. The great mass of land is so compact, and so little relieved by lofty hills or dense forests, that climatic conditions are pretty similar. Travellers in the central desert complain of piercing cold, even to ice formation, in the early hours, though followed after sunrise by a temperature of from 80° to 100° in the shade. Contiguity to the coast gives a night sea-breeze. A thermometer of 175° in the sun and 135° in the shade can hardly be exceeded elsewhere. Adelaide itself, in 34° S., has known 120° in the shade; its winter is superior to the Riviera or Algiers in uniform mildness and absence of frost. The north hot wind, so trying to the weak, seems to come from about lat. 26°. On Black Thursday, of 1850, the scorching winds caused terrible destruction. Dust storms accompany the blast, and add to the discomfort; but they introduce grateful showers. On the northern coast the deposition is effected by the monsoon, whose influence more or less extends even to lat. 28° S. Thus during the short rainy season the northern shore may have three to four times the fall experienced in Adelaide. The Great Austral Plains know but few and slight showers, with excessive evaporation. Yet, though the grass fails under the dryness, abundant shrubs give sustenance to live-stock. North of Goyder's Line it is of little use to attempt farming; still artesian wells can draw a constant supply from subterranean flowing streams. Droughts are often produced by the failure of the monsoon to come southerly enough, and they lower the bushels of corn per acre even to five only. While the north coast at Port Darwin received 60 to 70 inches of rain in the year, Mount Lofty had 40, Gambier 30, Mount Barker 29, Port Lincoln 19, Adelaide 20, Blanchetown 12, Port Augusta 9 (but 2 in 1859). Cyclones are very rare. The Adelaide climate is thus averaged: temperature from 34° to 113°; barometer, 30.53 to 29.09; wet-bulb, 55°. Barometer rises when the wind is from NW. by S. to SE., the highest; falling by N. to NW., lowest. The effect of climate on health is generally most favourable; though the summers are trying to infants, they do not hinder field labour for Europeans. Many consumptives have gained strength in South Australia.

Fauna.—Marsupial animals predominate—the kangaroo, jerboa, wallaby, native cat or *Dasyurus*, Phascogale or brush-tails, Myrmecobius or ant-eater, Perameles or bandicoot, Hapalotis or marsupial rat, Hydromys or beaver rat, Hypsiprymorus or kangaroo rat, Phalanger or flying-opossum, Phascalarectos or koala, Echidna or porcupine, Ornithorhynchus, bats, &c. Among 700 birds are the eagle, hawk, owl, king-fisher, swallow, finch, thrush, robin, diamond-bird, honey-bird, crow, cuckoo, parrot, cockatoo, quail, ibis, heron, black swan, and penguin. Insects are not wanting. Of fish there are 42 peculiar genera. Whales and seals were once numerous around the southern coast.

Flora.—The colony is not so rich in vegetable forms as either of its neighbours. It has but 5 of

19 Australian casuarinas, 70 of 300 acacias, and 30 of 130 eucalypts. In the Northern Territory are many Indian forms. Xanthorrhæe or grass-trees are seen on poor soil, and stunted shrubs on arid wastes. With few native trees in the country, government has established forest reserves and forest nurseries. The mulberry is cultivated for silkworms. Pines are numerous in some parts.

The *pastoral* resources can hardly compare with those of the eastern colonies of Australia, owing to greater dryness of climate. While live-stock may be found on farms in the more settled districts, the larger flocks and herds are upon the leasehold squatting *runs* outside the area of cultivation. The four pastoral districts contain 313,000 sq. m.

Agriculture has received great attention. In spite of frequent droughts bread-stuffs head the export list. The first land sales were in farming areas of 80 acres each, which led to cultivation rather than to pasturage; the land devoted to the growth of crops was recently 2,864,877 acres. Successive land acts have increased facility for the acquisition of the soil. Though cereals occupy most ground, potatoes are readily raised in the moister south-eastern quarter, and vines are of successful culture. In favourable seasons the drier interior can furnish good wheat. Railways, 1700 miles long, afford assistance to the farmer; and good roads extend nearly 5000 miles. The Northern Territory, being mostly tropical, has a fine future before it for the growth of rice, spice, and sugar, when suitable coloured labour can be procured. Though much of the interior is leased for pasturage, the state has only sold 9 million acres out of 569 millions. German settlers introduced the vine industry. The conversion of grapes into currants and raisins provides a fresh article of export. Olives and fruits are raised in abundance, and Adelaide now ships apples to London.

Mining.—The first lead-mine was opened in 1841; the first copper at Kapunda, 1843; the first gold at Montacute, 1846. The copper Burra Burra began in 1845, Wallaroo and Moonta in 1861. Copper is found along ranges for hundreds of miles. Tin, bismuth, and precious stones have been obtained. Gold workings exist in several places, but the best are in Northern Territory. The Barrier silver-mines are just over the New South Wales border. There are no coal beds. Excellent quarries exist of granite, marble, and slate. Mineral lands are leased from government. The high price of labour and cost of carriage hinder the working of mines that yet have a rich percentage of ores.

Population.—In 1891 the population was 320,431 (including 3848 Chinese and 3369 aborigines). Of places of worship the Wesleyans had 46,415 sittings; Roman Catholics, 44,138; Church of England, 22,250; Bible Christians, 19,260; Primitive Methodists, 16,144; Independents, 14,960; Baptists, 13,525; Lutherans, 11,000; Presbyterians, 6600. The public day schools were 550, with 1067 teachers; the private schools, 262 teachers. State education is free. The university was established in 1872.

The *government* is similar to that of other Australian colonies. The governor is appointed by the crown. There are 30,000 voters for members of the legislative council or upper house, and 60,000 of the assembly or lower house. The Constitution Act was passed in 1856. The revenue for 1890 was £2,557,771, the expenditure £2,579,257; for 1894, £2,496,544 (a fourth from customs) and £2,526,787 respectively. The customs department brought in £675,085 from duties, and £4522 from excise. The public debt, £23,153,725 in 1895, was incurred for improvements, railways taking more than half, and other public works eight millions.

The bulk of the *commerce* (total imports £6,227,000 in 1894, and exports £7,302,000) is with other

Australian settlements. While the total imports for 1890 came to £8,262,673, those from Great Britain were only £2,483,416; but of £8,827,387 exports the mother-country took £4,296,647. The exports of colonial produce included wool, £1,353,762; wheat, £1,382,418; flour, £613,823; live-stock, £60,735; skins and hides, £174,137; bark, £56,000; tallow, £16,951; wine, £50,738 (762,776 gallons); gold, £20,808; copper, £155,417; copper ore, £71,575. But the exports included importations of silver-lead from the New South Wales side, £1,822,826, and ore £736,282. The exports to the Barrier district were £1,186,149. The Northern Territory imported £114,135, and exported £155,008. The tariff is protectionist: the *ad valorem* duty, 5, 10, 15, 20, and 25 per cent., produced £233,723 of the customs' £615,266 in 1891. During 1890 there entered 1041 vessels of 1,075,133 tons, and cleared 1081 vessels of 1,115,309 tons. The banks at the beginning of 1891 showed average liabilities of £7,759,926, and assets of £11,489,842. There were 609 post-offices, and 182 money-order offices. The telegraph and telephone lines were 5623 miles in length; one line runs north from Adelaide 700 miles. Northern Port Darwin is connected by the electric line with the extreme south ports.

See, besides South Australian government handbooks and Australian handbooks generally, Harcus' *South Australia* (1876); Newland, *The Far North Country* (Adelaide, 1887); Dutton's *South Australia and its Mines*; the present writer's *Climate and Health in South Australia and Resources of South Australia*; Gill's *Bibliography of South Australia* (Adelaide, 1888); Hodder's *History of South Australia* (1893); and J. D. Woods, *The Province of South Australia* (Adelaide, 1894).

South Bend, capital of St Joseph county, Indiana, on the St Joseph River (navigable for small steamers), 86 miles by rail ESE. of Chicago. It contains a Roman Catholic university and academies, and manufactures of wagons, agricultural implements, furniture, woollens, paper, flour, &c. Pop. (1880) 13,280; (1890) 21,819; (1900) 35,999.

South Bethlehem. See BETHLEHEM.

Southbridge, a town of Massachusetts, on the Quinebaug River, 70 miles by rail SW. of Boston, with manufactories of cottons, woollens, knives, boots, &c. Pop. (1890) 7655.

South Carolina, one of the thirteen original states of the American Union, is bounded on the N. and NE. by North Carolina, SE. by the Atlantic Ocean, and SW. by Georgia. Area 30,570

sq. m., including 400 sq. m. of water-surface. It is nearly triangular in outline. Numerous islands near the southern part of the coast are separated from the mainland and from each other by shallow sounds and inlets. For 100 miles inland the land is generally low and level, much of it still covered with pine forests (*Pinus palustris*). West of this alluvial plain is a range of undulating sandhills about 60 miles in width. This 'middle country' was long the least fertile part of the state. Farther west the 'ridge country' rises, generally abruptly, from the Savannah to the Broad River on the north, presenting a region of rare beauty and fertility. The average elevation of the western third of the state is nearly 2000 feet above the sea-level. Mount Pinnacle, Caesar's Head, and Table Mountain, belonging to the Blue Ridge range, in the north-west part of the state, rise to the height of about 4000 feet. Geologically the eastern part of the state is quaternary or alluvial and the western is cozoic, with extensive tertiary and older formations intermediate. Most of the rivers—the largest the Santee (q.v.)—are navigable by steamboats nearly to the foot-slope of the ridge region, where they supply abundant water-power. South Carolina

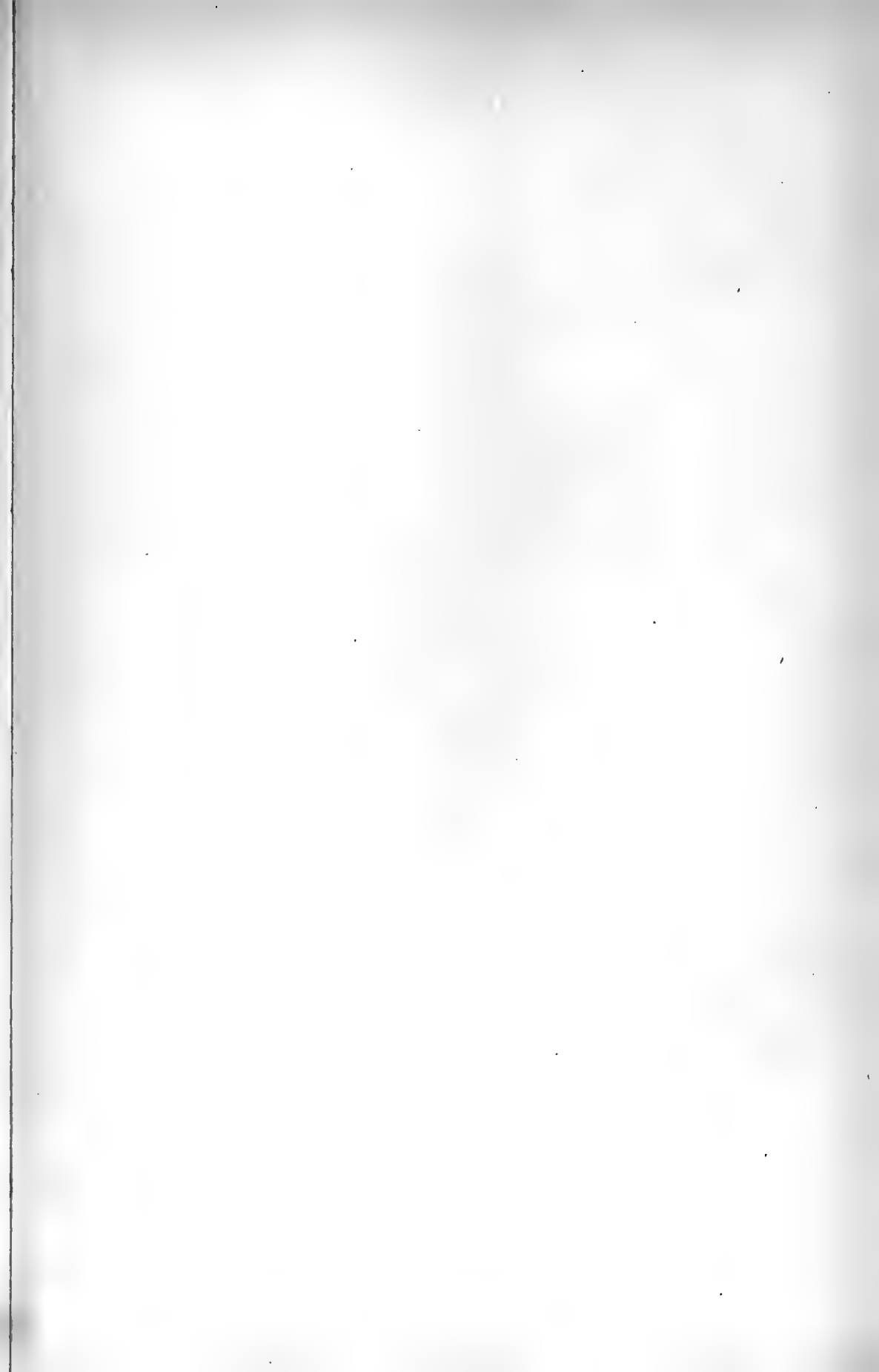

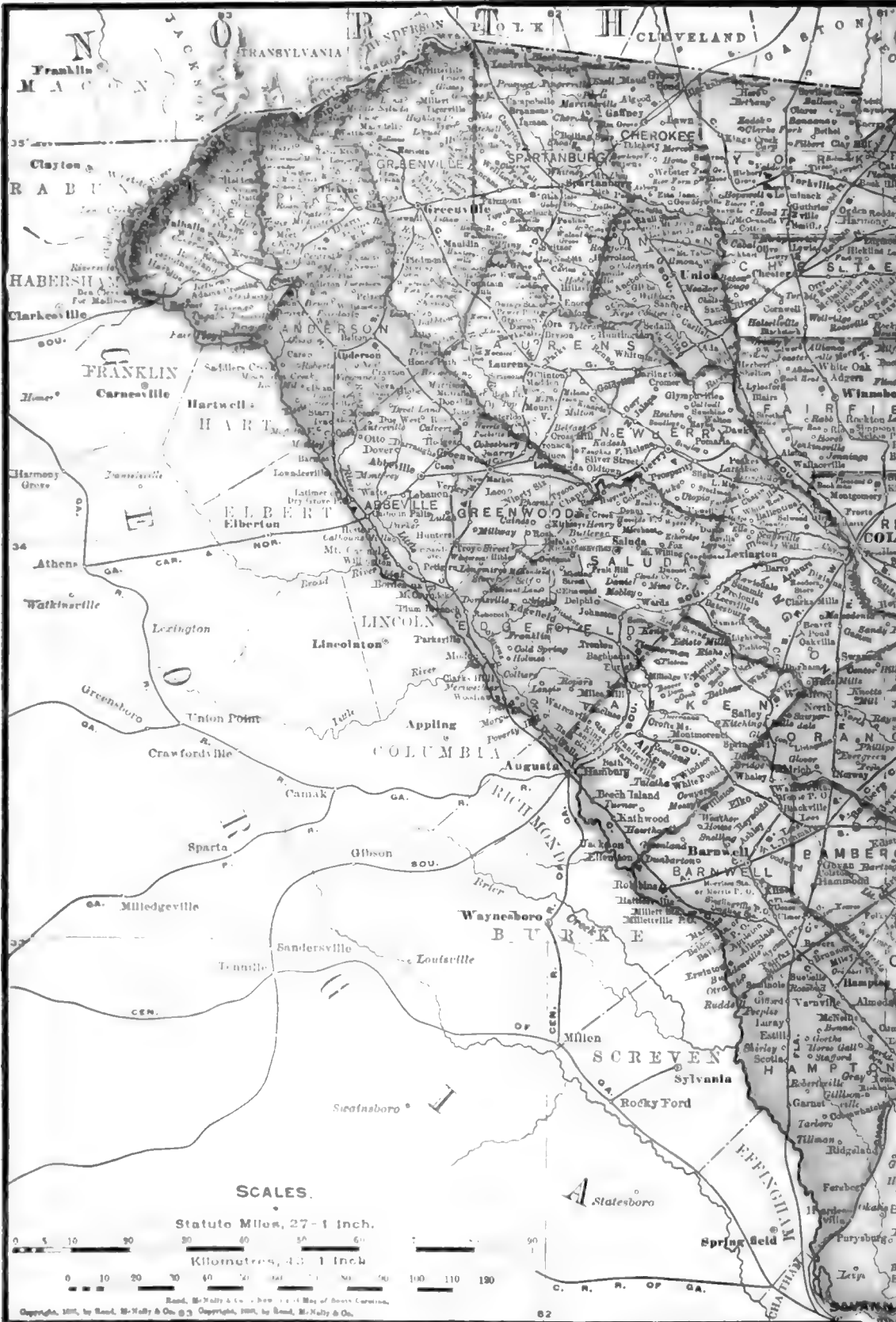

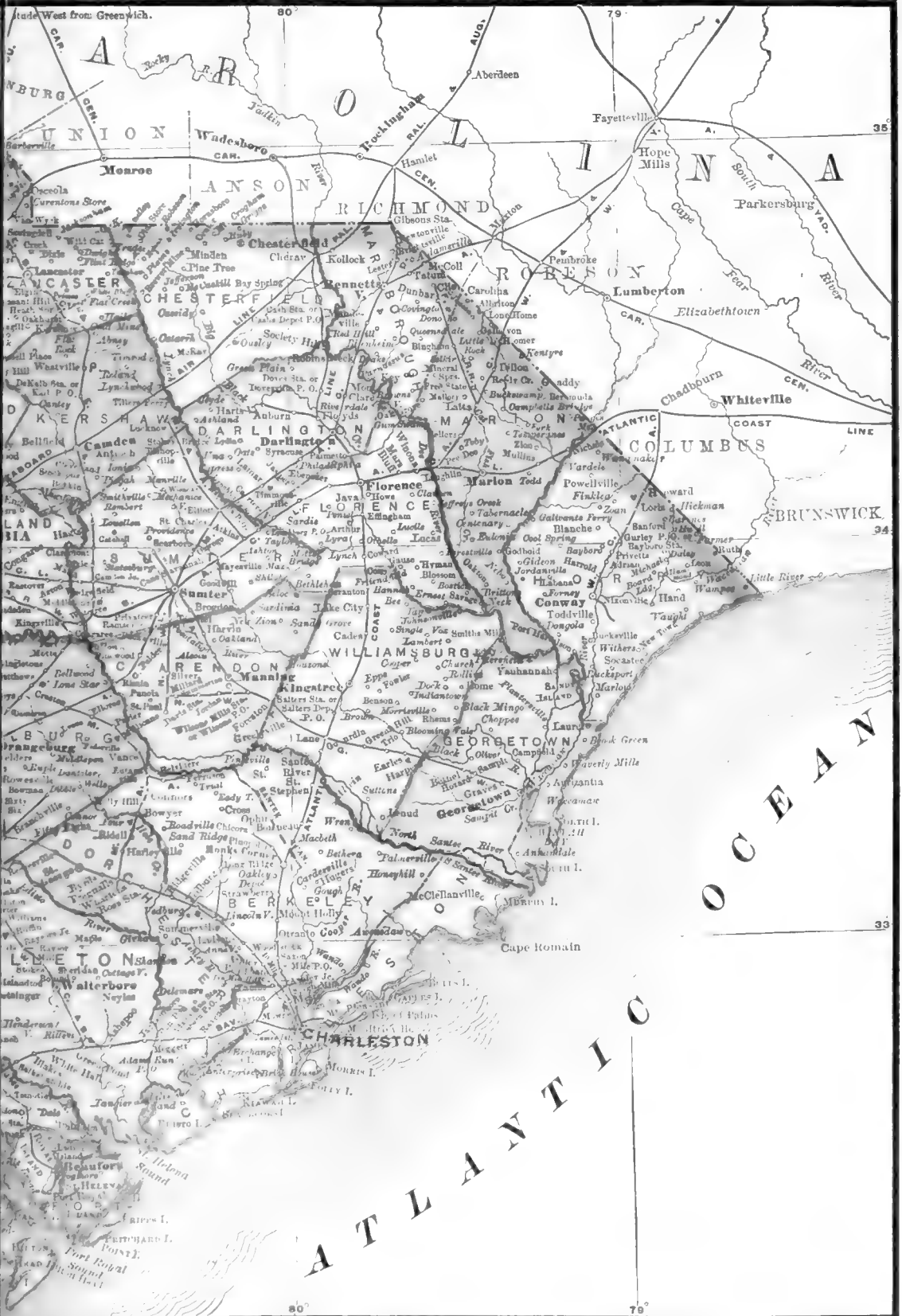



has three customs districts, with ports of entry at Georgetown, Charleston, and Beaufort.

The state is rich in mineral products, which recent enterprise is profitably developing. The gold-belt extends from the North Carolina line in a south-westerly direction, the most productive mines being in York, Lancaster, Chesterfield, and Spartanburg counties. Granite is abundant in Abbeville, Fairfield, and Newberry counties; and itacolumite, a flexible sandstone, is quarried for grindstones in Spartanburg. Kaolin of superior quality, and used for artificial teeth, is obtained in Chester county. Pliocene marl is abundant in Horry, Sumter, and Marlborough counties. Post-pliocene is found in Edisto island and near the Savannah, Santee, Ashley, and Cooper rivers. But the most important mineral product of South Carolina is its famous deposit of phosphate rock, extending about 70 miles from the mouth of the Broad River near Port Royal to the head-waters of the Wando, north of Charleston. Its direction is parallel with the coast, and its width in some places is 30 miles. It crops out near the Ashley River, where it was first observed. This immense phosphate bed is generally covered with quaternary clays and sands, and its nodular phosphatic layer rests upon deep strata of calcareous marl, beneath which cretaceous marls extend along the entire eastern part of the state. In 1892 about twenty companies found profitable investment for more than \$4,000,000 capital in the mining and manufacture of nearly 4,000,000 tons of phosphate rock. It is obtained as a tribasic phosphate, and is used mainly in the manufacture of superphosphates. The average of lime phosphate is from 52 to 60 per cent. of the rock. Gray iron ore (magnetite) is found in Union, York, and Spartanburg counties; and copper pyrites (chalcopyrite), galena, limonite, malachite, pyrolusite, and pyromorphite or phosphate of lead have been found in the western part of the state, and sand for glass in Aiken and Barnwell counties. Deer, wild turkeys, raccoons, foxes, squirrels, and other small game are still numerous in the forests; and the rivers, sounds, and inlets are stocked with a great variety of fish. Alligators of large size inhabit the tidal rivers.

South Carolina, called the Palmetto State from the growth of the cabbage-tree (*Sabal palmetto*) near the coast, ranks twenty-third in the list of forty-four states. By the census of 1890 the population was 1,151,149, consisting of 692,503 coloured persons, 458,454 white, 172 Indians, and 20 Chinese. Of the thirty-five counties (districts previous to 1868) Newberry alone failed to show increase from 1880 to 1890. Charleston, the largest city, had a population of 54,955 in 1890, and Columbia, the capital, 15,353. The mild climate is salubrious except in the rice-lands. The low islands along the coast afford desirable summer-resorts, as well as the western mountain-region known as 'the land of the sky.' The average rainfall in the eastern part is from 42 to 44 inches. The coast lies within the usual limits of West India cyclones, which are often destructive of life and property. Charleston (q.v.) suffered severely from a cyclone in 1885, and, much more terribly, from an earthquake in 1886, which caused twenty-seven deaths and over \$6,000,000 of loss in property. The principal crops are maize, rice (on the coast), oats, yams, cotton (in 1894, 818,330 bales were harvested in this fifth of the cotton-growing states), and, since 1895, tobacco in increasing quantities.

In 1562 John Ribault, at the head of a party of French Protestants sent over by Admiral Coligny, built a fort on an island in the harbour of Port Royal, and named it *Arx Carolina*, in honour of the king Charles IX. The twenty-six colonists left by Ribault soon abandoned the fort to return to

France. In 1630 Sir Robert Heath obtained a grant from Charles I. reaching from latitude 36° to the Gulf of Mexico, but failure to colonise forfeited the title. In this grant the territory was named Carolana for Charles I. In 1662 Charles II. granted to Lord Clarendon and seven associates all the territory from the Atlantic to the Pacific lying between parallels 31° and 36° N. Two years later the northern boundary was made 36° 30'. In 1670 three ship-loads of English settlers under William Sayle landed at or near Port Royal, but the next year moved to the right bank of Ashley River. In 1680 they moved again to the present site of Charleston. The proprietary government under the 'model Constitution,' drawn up by John Locke (see NORTH CAROLINA), lasted till 1729, when George II. bought out the proprietors and divided Carolina into two royal provinces. Subsequently South Carolina became one of the most flourishing of the British colonies and attracted an intelligent and enterprising class of settlers from Europe, including many French Huguenots, who came soon after the revocation of the edict of Nantes in 1685. Hence the Gallic origin of so many distinguished names in the history of the state.

Sir John Yeamans, who had been appointed governor, brought from Barbadoes two hundred negro slaves in 1671. The blacks in a few years nearly equalled the whites, and since 1820 have been more numerous in the state. During the revolutionary war South Carolina furnished her full quota of men and means, and suffered much from British invasion and occupation. This state was the first to ratify the Articles of Confederation, February 5, 1788, and the eighth to ratify the constitution, May 23, 1788. In 1833 a convention called by the legislature passed the ordinance known as the Nullification Act (q.v.). South Carolina was the first state to secede from the Union. A convention called by the legislature met on the 17th December 1860, and passed an ordinance of secession by a unanimous vote on the 20th. Six sister slave-states soon followed the example of South Carolina, and formed the Southern Confederacy, which was subsequently increased by four more. South Carolina was re-admitted into the Union, June 25, 1865. Since the accomplishment of reconstruction the state has attained a high degree of prosperity. It sends seven representatives to the national congress. The excellent public school system affords good educational advantages to pupils of both races in primary and intermediate studies; and provision is made for industrial and higher education.

See UNITED STATES; Histories of South Carolina by Simms (new ed. 1860) and Ramsay (1867); and E. McGrady, *The History of South Carolina under the Proprietary Government* (1898).

South Chester. See CHESTER.

Southcott, JOANNA, a more than usually strange specimen of the religious visionary, was born in Devonshire, of humble parentage, about 1750. In youth a domestic servant at Exeter, she joined the Methodists, and learned the art of prophecy from one Sanderson. About 1792 she declared herself to be the woman driven into the wilderness of Rev. xii., and boldly gave forth predictions in prose and verse. She soon came to London on the invitation of Sharp the engraver, and here she published *A Warning, &c.* (1803), *The Book of Wonders* (1813-14), and *Prophecies concerning the Birth of the Prince of Peace* (1814). She also issued 6400 sealed papers to her followers, which she termed her *seals*, and which ensured salvation; their cost was from a guinea to twelve shillings. Strange to say, otherwise intelligent men believed in her. At length she imagined

herself to be pregnant, and announced that she was to give birth, at midnight on the 19th October 1814, to a second Shiloh or Prince of Peace. Her followers received this announcement with devout reverence, and prepared an expensive cradle for the occasion. But she merely fell into a trance, and on 27th December 1814 she died. It was found that the appearance of pregnancy which had deceived others, and perhaps herself, was due to dropsy. Her followers continued to believe that she would rise again from her trance. In 1851 they still numbered over 200, with four places of worship, and were not quite extinct in 1897.

South Dakota, one of the two states constructed in 1890 out of the former territory of Dakota (q.v.).

South Easton, a borough of Pennsylvania, at the mouth of the Lehigh River, opposite Easton, with manufactures of cottons, wire, &c. Pop. 5616.

Southend, an Essex watering-place, at the mouth of the Thames estuary, 42 miles E. of London. Dating from a visit here of Queen Caroline and the Princess Charlotte in 1804, it was in great part built by Sir S. Morton Peto (1809-89), has a public hall (1872), a new pier, over a mile in length, with tramway and concert-room, and in 1899 it was proposed to reclaim enough of the foreshore for a handsome promenade. Pop. (1851) 2462; (1871) 4561; (1881) 7979; (1891) 12,333.

Southern Cross, one of the star groups in the southern hemisphere of the heavens. It lies in right ascension 12 hours, and dec. 60° S., being thus a considerable distance from the south pole

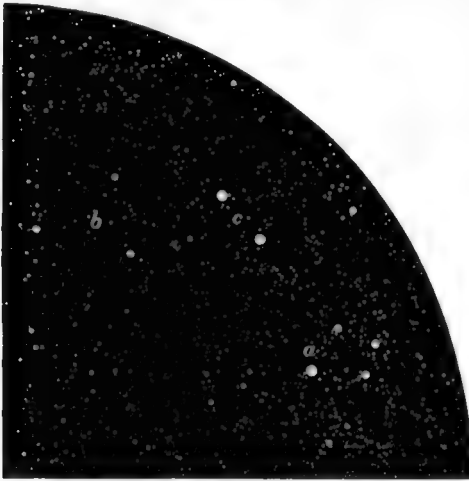

Quadrant of the Southern Heavens from the Pole to the fortieth degree, showing the Southern Cross, *a*, and the Triangle, *b*. The two bright stars at *c* are α and β of Centauri.

of the heavens. It was added to the list of constellations by Royer in 1679. The four principal stars form a rough cross when seen above the pole. The figure is of considerable size, being about 6° of dec. in height.

Southerne, THOMAS, dramatist, known as 'honest Tom Southerne' in the world of his day, was born at Oxmantown in County Dublin in 1660 or 1661, studied at Trinity College, Dublin, and entered at the Middle Temple, London, but in 1682 began his career as playwright with a compliment to the Duke of York in *The Loyal Brother*, or *the Persian Prince*. Dryden wrote the prologue and epilogue, raising his fee on the occasion, and Southerne had the honour of finishing Dryden's *Cleomenes*, or *the Spartan Hero* (1692). Southerne

served a short time under the Duke of Berwick, and at his request wrote the *Spartan Dame*, receiving £120 for the copyright. His best plays, both tragedies, were produced in the reign of William III.—*The Fatal Marriage* (1694), and *Oroonoko*, (1696) based on Afra Behn's novel. His comedies are thin, and hardly more decent than the rest in that day. Southerne contrived to thrive in his vocation, and is pleasantly described as a venerable old gentleman, regular in attendance on evening prayers, always neat and decently dressed, commonly in black with his silver sword and silver locks. Pope describes his friend as him whom Heaven sent down to raise the price of prologues and of plays. He died May 26, 1746.

Southernwood (*Artemisia abrotanum*), a shrubby species of *Artemisia* (see WORMWOOD), found wild in south Europe, and cultivated in old-fashioned gardens for its pleasant aromatic odour.

Southey, ROBERT, poet-laureate, was born at Bristol on 12th August 1774. His father, Robert Southey (1745-92), was an unlucky linen-draper; his mother, Margaret Hill (1752-1802), who likewise came of good old yeoman ancestry, was a bright, sweet-tempered woman, who could whistle like a blackbird. Much of his lonely childhood was passed with her half-sister, Miss Tyler (1739-1821), a rich, genteel old maid who hated noise and matrimony, and had a passion for cleanliness and the drama. With her he saw many plays; read Shakespeare and Beaumont and Fletcher, Hoole's *Tasso* and *Ariosto*, the *Faerie Queene*, Pope's *Homer*, and Sidney's *Arcadia*; and himself scribbled thousands of verses. He had meanwhile had four schoolmasters, and in 1788 was placed by an uncle, the Rev. Herbert Hill, at Westminster. There Picart's *Religious Ceremonies* led him 'to conceive a design of rendering every mythology the basis of a narrative poem'; there he formed lifelong friendships with C. W. W. Wynn and Grosvenor Bedford; and thence in 1792 he was expelled for writing an article against flogging in a school magazine. Next year, however, he entered Balliol College with a view to his taking orders. He went up to Oxford a republican, his head full of Rousseau and 'Werther', his religious principles shaken by Gibbon; and he left it in 1794 a Unitarian, having learnt a little swimming and a little boating, and ingrained his very heart with Epictetus. And at Oxford he had a visit from Coleridge, who infected him with his dream of a 'Pantisocracy' on the banks of the Susquehanna. The Pantisocrats required wives; and wives were forthcoming in three Miss Frickers of Bristol. The eldest, Sara, fell to Coleridge; the second, Edith, to Southey; and Mary, the third, to a Robert Lovel, who with Southey in 1794 published a booklet of poems, and died two years afterwards penniless. The Pantisocrats furthermore required money, and money was not forthcoming; so, having tried medicine, and been sickened by the dissecting-room, having been turned out of doors by his indignant aunt, having lectured with some success, and having on 14th November 1795 secretly married his Edith, Southey started the same day on a six months' visit to Lisbon, where his uncle was chaplain to the British factory, and where he laid the foundation of his profound knowledge of the literatures and history of the Peninsula. He returned to England to take up law, but reading Coke to him was 'threshing straw'; so after sundry migrations—Westbury near Bristol, Burton near Christchurch, Lisbon again for a twelvemonth (1800-1), and Ireland (a brief secretaryship to its Chancellor of the Exchequer), with intervals of London—in September 1803 he settled at Greta Hall, Keswick, in the Lake Country. The Cole-

ridges were there already, and thither came Mrs Level: three households were to rest on Southey's shoulders.

His school friend Wynn allowed him £160 a year from 1796 till 1807, when a government pension of a like amount was granted him (he was turning meanwhile a Tory), and on this he devoted himself to a life of strenuous, incessant authorship. *Joan of Arc* had already appeared in 1795, and *Thalaba* in 1801; there followed *Madoc* (1805), *The Curse of Kehama* (1810), *Roderick* (1814), *History of Brazil* (1810-19), *Lives of Nelson* (1813), *Wesley* (1820), and *Bunyan* (1830), *A Vision of Judgment* (1821), *Book of the Church* (1824), *History of the Peninsular War* (1823-32), *Colloquies on Society* (1829), *Naval History* (1833-40), and *The Doctor* (1834-47), in which comes the nursery classic of 'The Three Bears.' His works number nearly fifty, and fill more than a hundred volumes; and to them must be added his contributions to the periodicals—to the *Quarterly* alone ninety-three articles (1808-38). These paid him handsomely, so that he died worth £12,000; but the *History of Brazil* brought him in eight years only the price of one article, and *Madoc* in a twelvemonth only £3, 17s. 1d.—*Madoc*, which Scott read and thrice re-read, and which Southey himself with naïve vanity admitted to be 'the best English poem since *Paradise Lost*.' His life was a busy and happy one: at forty-six he could say, 'I have lived in the sunshine, and am still looking forward with hope.' It flowed quietly on, the chief events in it his visit to Scott and Scotland (1805), his first meeting with Landor (1808), the visits from Shelley and Ticknor (1811, 1819), his appointment to the laureateship (1813), the death of his first boy Herbert (1806-16), the surreptitious publication of his revolutionary drama *Wat Tyler* (1817; written 1794), little tours in Belgium (1815), Switzerland (1817), Holland (1825, 1826), and France (1838), an honorary D.C.L. of Oxford (1820), his return as M.P. for Downton (unsolicited and declined, 1826), and Peel's offer of a baronetcy, with the welcome addition of £300 a year to his pension (1835). It came at a time of sorrow, for his wife, who had 'for forty years been the life of his life,' had six months before been placed in an asylum, and though she was brought back to Keswick, she was brought back only to die (1837). Southey never held up after that, though in 1839 he married the poetess Caroline Anne Bowles (1787-1854), for twenty years his friend and correspondent, and returned with her to Greta Hall, intending resolutely to set about two great works which he had long had in contemplation—a *History of Portugal* and a *History of the Monastic Orders*. It was not to be, for Wordsworth in 1840 found him vacuous, listless in his noble library, the 14,000 books he had collected, 'patting them with both hands affectionately like a child.' The end came on 21st March 1843; he is buried in Crosthwaite churchyard.

Macaulay in 1830 expressed a doubt whether 'fifty years hence Mr Southey's poems will be read'; the doubt has been amply justified. No poet probably so well known by name is so little known by his poetry. There are some short exceptions of course—the 'Holly Tree,' 'Battle of Blenheim,' 'Stanzas written in my Library,' half-a-dozen more. But the 'Simorg,' the 'Glendovers,' 'Mohareb'—how many can localise these creations of Southey's muse? His epics repel, not so much by prolixity or by their irregular, sometimes rhymeless metres, as by the unreality of their fact and fancy. They remind us of scene-paintings; and a scene-painting even by Roberts will fetch just nothing in the auction-room. With Southey's prose it is otherwise. He wrote out of the fullness of knowledge, for something more than the mere

sake of writing; and his was that rarest gift of good pure English. Yet even here he wrote far too much, and he was often unhappy in his choice of subjects. One book alone by him, the *Life of Nelson*, belongs to universal literature. But though there have been better poets than Southey, no poet has been a better man than he.

His *Life and Correspondence* (6 vols. 1849-50), by his younger son, the Rev. Cuthbert Southey (1819-89), contains a delightful fragment of autobiography, written in 1820-25, but coming down only to 1789. It also gives hundreds of his letters to Cottle (q.v.), Landor, Lamb, William Taylor, Rickman, Ebenezer Elliott, Kirke White, Bernard Barton, Charlotte Brontë, Crabb Robinson, Sir Henry Taylor, &c. A *Selection* from these was edited by his son-in-law, the Rev. J. W. Warter (4 vols. 1856), who also issued Southey's *Commonplace Book* (4 vols. 1849-51); his *Correspondence with Caroline Bowles* has been edited by Professor Dowden (Dublin, 1881). See, too, the latter's *Southey* ('English Men of Letters' series, 1880); Dennis's *Southey: Story of his Life* (Boston, 1887); Sir Henry Taylor's essay in *Ward's English Poets* (vol. iv., 2d. ed., 1883); the brief memoir by Sidney R. Thompson in the 'Canterbury Poets' series (1888); and Smiles's work on John Murray (1891).

South Georgia, a group of islands, uninhabited, and almost perpetually ice-bound, in 54° 30' S. lat. and 36°-38° W. long., nearly 800 miles E. by S. of the Falkland Isles, of which they are a dependency. Area, 1000 sq. m. Discovered in 1675, they were taken possession of by Captain Cook in 1775; and here in 1882-83 lived the German expedition for observing the transit of Venus.

South Island, the southern of the two large islands which, with the small Stewart's Island, form the British colony of New Zealand (q.v.).

South Molton, a municipal borough (1590) of Devonshire, on the Mole, 10 miles ESE. of Barnstaple. It has a fine Perpendicular church (restored 1865), a market-house (1864), and some manufactures of woollens. Pop. (1891) 3126.

South Omaha, a city (founded 1885) of Douglas county, Nebraska, 4 miles from Omaha. It is on several railway lines, and has exceedingly extensive stock-yards and packing-houses, hotels, public buildings, &c. Pop. (1890) 8062; (1900) 26,001.

Southport, a watering-place of Lancashire, at the mouth of the Ribble estuary, 18 miles N. of Liverpool. Its growing popularity dates from 1830. It has a mild climate, and broad level sands. The esplanade (3 miles long) commands views of the Welsh and Cumberland mountains, and from it projects a pier of 1465 yards, along which is a steam tramway. Other features of Southport, with date and cost, are the Pavilion and Winter Gardens (1874; £140,000), comprising a theatre, concert-hall, aquaria, &c.; opera-house (1891; seating 2000); the Cambridge Hall (1874; £25,000), with a clock-tower 127 feet high; the Victoria Baths (1871; £45,000); the Atkinson Public Library and Art Gallery (1878; nearly £15,000); the Grecian town-hall (1853); the market-hall (1881; £40,000); the Victoria Schools of Science and Art (1887); the convalescent hospital (founded 1806; present building 1854-87); the Hesketh Public Park of 30 acres (1868); and a marine park and lake (1887; £13,000) on the foreshore fronting the town. Nathaniel Hawthorne, then United States consul at Liverpool, describes Southport as it was in 1856 in vol. iii. of his *English Notebooks* (1870). It was made a municipal borough in 1867, the boundary being extended in 1875. Pop. (1851) 4765; (1871) 18,085; (1881) 32,206; (1891) 41,406.

Southsea, a south-eastern suburb of Portsmouth, is a fashionable watering-place of recent growth, with two piers, a fine esplanade 2 miles long, a canoe lake, a common, a modernised castle of 1540, and other fortifications, barracks, &c.

South Sea Scheme (or **BUBBLE**) was originated by Harley (q.v.), Earl of Oxford, in 1711, with the view of restoring public credit and providing for the extinction of the floating national debt, which at that time amounted to £10,000,000. This debt was taken up by a number of eminent merchants, to whom the government agreed to guarantee for a certain period the annual payment of £600,000 (being 6 per cent. interest), a sum which was to be obtained by rendering permanent a number of import duties. The monopoly of the trade to the South Seas was also secured to these merchants, who were accordingly incorporated as the 'South Sea Company,' and at once rose to a high position in the mercantile world. The extravagant ideas then current respecting the riches of the South American continent were carefully fostered by the Company, who also spread the belief that Spain was prepared to admit them to a share of its South American trade. In 1717 the Company advanced to government other 5 millions. Their shares nevertheless rose day by day; and even when the outbreak of war with Spain in 1718 deprived the most sanguine of the slightest hope of sharing in the treasures of the South Seas, the Company continued to flourish. Far from being alarmed at the expected failure of the Mississippi Scheme (q.v.), the South Sea Company believed sincerely in the feasibility of Law's scheme, and resolved to avoid what they considered as his errors. In the spring of 1720 they proposed to take upon themselves practically the whole national debt (at that time upwards of 30 millions), on being guaranteed 5 per cent. per annum for 7½ years, at the end of which time the debt might be redeemed if the government chose, and the interest reduced to 4 per cent. The directors of the Bank of England, jealous of the prospective benefit and influence which would thus accrue to the South Sea Company, submitted to government a counter-proposal; but the more jangling nature of their rivals' offer, in spite of protest from Walpole and other long-headed leaders, secured its acceptance by parliament. During the passing of their bill the Company's stock rose steadily to 330 on April 7, falling to 290 on the following day.

Up till this date the scheme had been honestly promoted; but now, seeing before them the prospect of speedily amassing abundant wealth, the directors seem to have thrown aside all scruples and made use of every effective means at their command for keeping up the factitious value of the stock. Their zealous endeavours were crowned with success; the £100 shares were quoted at 550 on May 28, and 890 on June 1. A mania of gambling seized the nation; preposterous companies of all kinds were floated, some of which were even prosecuted by the South Sea Company (under the 'Bubble Act') and exposed as swindling schemes. A general impression having by this time gained ground that the Company's stock had reached its maximum, so many holders rushed to realise that the price fell to 640 on June 3. Thereupon the directors sent agents to buy up eagerly; and on the evening of June 3, 750 was the quoted price. This and similar artifices were employed as required, and had the effect of ultimately raising the shares to 1000 in the beginning of August, when the chairman of the Company and some of the principal directors sold out. On this becoming known a wide-spread uneasiness seized the holders of stock, every one was eager to part with his shares, and on September 12 they fell to 400. The consternation of those who had been either unwilling or unable to part with their scrip was now extreme; many capitalists absconded, either to avoid ruinous bankruptcy or to secure

their ill-gotten gains, and the government became seriously alarmed at the excited state of public feeling. Vain attempts were made to prevail on the Bank to come to the rescue by circulating some millions of Company's bonds.

The country was now wound up to a most alarming pitch of excitement; the punishment of the fraudulent directors was clamorously demanded; and parliament was hastily summoned (December 8) to deliberate on the best means of mitigating this great calamity. Both Houses, however, proved to be in as impetuous a mood as the public; and, in spite of the moderate counsels of Walpole, it was resolved to punish the authors of the national distresses, though hitherto no fraudulent acts had been proved against them. An examination of the proceedings of the Company was at once commenced, with results discreditably to the management; the private property of the directors was confiscated (to the amount of upwards of 2 millions) for the benefit of those who had suffered; seven millions due to the government were remitted; various eminent persons in and about the government were openly charged with receiving direct money bribes from the Company; the Chancellor of the Exchequer, Aislaby, being found clearly guilty, was expelled from the House of Commons, and imprisoned in the Tower. The ruin wrought by the Bubble was incalculable. See the histories of Stanhope and Lecky, and Coxe's *Walpole*.

The South Sea House in Threadneedle Street was the headquarters of the South Sea Company. When the company ceased to be a trading concern its capital was converted into annuity stock; and its premises are now subdivided into numerous offices. John Lamb was a clerk in South Sea House; and his brother Charles was admitted here to learn book-keeping.

South Shetlands, a group of islands in the South Atlantic, lying on the lines of 60° S. lat. and 60° W. long., and covered ever with ice and snow.

South Shields. See **SHIELDS**.

Southwark, or 'The Borough,' on the Surrey side of the Thames, was annexed to the City of London (q.v.) in 1327. For its innumerable memories reference may be made to *Old Southwark and its People* (1878), by W. Rendle, or to Mr Besant's romance, *The Bell of St Paul's*.

Southwell, a town of Nottinghamshire, since 1884 a cathedral city, on the ancient Ermine Street, 7 miles W. by S. of Newark and 12 N.E. of Nottingham. A church was founded here by Paulinus about 630; but the stately cruciform minster, which with its three towers resembles York on a smaller scale, is wholly of post-Conquest date, comprising Norman nave and transepts (1110), Early English choir (1250), and Early Decorated chapter-house (1300). It measures 306 feet by 123 across the transepts, and the lantern tower is 105 feet high. A collegiate church until 1841, it became in 1884 the cathedral of a new diocese including the counties of Notts and Derbyshire, and taken from Lincoln and Lichfield; and in 1888 it was reopened after restoration. Its eagle lectern originally belonged to Newstead priory, having been fished out of the lake there about 1750. In the old 'Saracen's Head' Charles I. surrendered to the Scots commissioners (1646); Byron's mother occupied Burgage Manor House (1804-7); and there are picturesque ruins of the palace of the Archbishops of York (c. 1360; much altered and enlarged by Wolsey). The collegiate grammar-school was refounded in Henry VIII.'s time; and there are a literary institute and free library. Pop. (1851) 3516; (1881) 2866; (1891) 2831.

See works by Rastall (1787, 1801), Shilton (1818), Dimock (1884), Livett (1883), and Leach (1890).

Southwell, ROBERT, poet and Jesuit martyr, was born about 1562, son of Richard Southwell of Horsham St Faith's in Norfolk, the family being ancient and now represented collaterally by Viscount Southwell. He was stolen from his cradle by a Gypsy woman, but soon recovered, and at fifteen was sent to Paris for his education. Challoner states that he studied also at Douay, but certain it is that he soon went to Rome, being received into the Society of Jesus on the festival of St Luke 1578. After a residence at Tournay he returned to Rome and distinguished himself so highly in the course of philosophy and theology as to be appointed prefect of the English college there. He was ordained priest in 1584, and three years later arrived in England in company with Father Henry Garnet, who was also to earn the martyr's crown. Southwell was first sheltered by Lord Vaux, and next became domestic chaplain to the Countess of Arundel. Six years of quiet followed in which he fearlessly followed his vocation, and wrote his *Consolation for Catholics* as well as most of his poems. At length in 1592 he was betrayed into the hands of the authorities, was kept some weeks and infamously tortured ten times in the house of an abandoned ruffian named Topcliffe, then transferred to the Gatehouse, and next to a noisome dungeon in the Tower. 'Though thirteen times most cruelly tortured,' writes Cecil, 'he cannot be induced to confess anything, not even the colour of the horse whereon on a certain day he rode.' After three years' close imprisonment he wrote to entreat the grace of an open trial to Cecil, who is said to have made the brutal reply that 'if he was in so much haste to be hanged he should have his desire.' He was transferred to Newgate, and, after three days of confinement in *Limbo*, carried to Westminster for trial. The inevitable sentence followed, and on the 22d February 1595 he suffered at Tyburn, the victim of a barbarous statute, with all the high courage of the primitive martyrs. His prose writings are no longer interesting, but his poems retain their value. His longest poem is *Saint Peter's Complaint*; his most famous, *The Burning Babe*, a beautiful little piece of sanctified fancy, to have written which Ben Jonson told Drummond he would have been content to burn many of his poems.

Southwold, a Suffolk watering-place, 41 miles by a small branch-line N.E. of Ipswich. A municipal borough since 1489, it was almost destroyed by fire in 1659, but retained its fine Perpendicular church (1460), 144 feet long. In Southwold or Sole Bay a bloody but indecisive sea-fight was fought between the English and the Dutch on 28th May 1672. Pop. (1851) 1955; (1891) 2311.

Souvestre, ÉMILE, French novelist and playwright, was born at Morlaix, April 15, 1806, and, after some years of struggle, drifted into journalism, and at thirty went up to Paris, where he soon made some reputation by his charming sketches of Brittany and its people. These form the still delightful books, *Les Derniers Bretons* and *Foyer Breton*, his best work. Another deservedly popular book, *Un Philosophe sous les Toits*, was crowned by the Academy in 1851. Souvestre's plays were less successful than his stories, which, although didactic, are really seldom dull. He died in Paris, 5th July 1854. His *Causeries historiques et littéraires* (2 vols. 1854) are interesting.

Souza, MADAME DE, a charming French writer, was born in Paris, 14th May 1761, her maiden name Adélaïde-Marie-Émilie Filleul. Her parents died early, and she was brought up in a convent, from which she emerged only to marry the Comte de Flahaut, then fifty-seven, a union which was not

happy. At the outbreak of the Revolution she found refuge, together with her only son, first in Germany, then in England, and here learned of her husband's execution at Arras (1793). For solace she turned to writing, and, in the midst of grief and poverty, wrote her first book, the fresh and delightful *Adèle de Sénange* (Lond. 1794). After Thermidor she tried to return to France, but had to tarry a while at Hamburg, where she met the Marquis de Souza-Botelho (1758-1825), afterwards Portuguese minister at Paris, whom she married in 1802. The charm of her conversation and manners, her bright wit, and above all her goodness made her the queen of a group that numbered many of the most distinguished men in Paris. The Restoration brought her the great grief of long separation from her son, who had been aide-camp to Napoleon. She died in Paris, 16th April 1836. Later novels were *Émilie et Alphonse* (1799); *Charles et Marie* (1801), a delightful story, something in Fanny Burney's manner, and coloured throughout by English impressions; *Eugène de Rothelin* (1808), an exquisite piece of work, its hero a Grandison without insipidity; *Eugénie et Mathilde* (1811), her longest and best sustained story, in which we find close traces of her own history; and *La Comtesse de Fargy* (1822). Madame de Souza was a product of the best side of the 18th century, and she helps us to understand the politeness, the harmoniousness, the taste, the reticence—all that was noble and exquisite in the old régime. See Patin's *Mélanges* (1840) and Sainte-Beuve's *Portraits de Femmes*.

Sovereign, in Politics, the person or body of persons in whom the supreme executive and legislative power of a state is vested. In limited monarchies sovereignty is in a qualified sense ascribed to the king, who, though the supreme magistrate, is not the sole legislator. A state in which the legislative authority is not trammelled by any foreign power is called a sovereign state. See GOVERNMENT; and for the 20s. piece, see POUND.

Sowerby, JAMES (1757-1822), was a native of Lambeth, who commenced as a portraitist and miniaturist, but now is remembered by his *English Botany, or Coloured Figures of all the Plants Natives of Great Britain* (36 vols. 1792-1807; new ed. 11 vols. 1863-72), the descriptions being written by Sir J. E. Smith, M.D. Other works dealt with Fungi, Conchology, and Mineralogy. Three sons who followed in their father's footsteps were James de Carle Soverby (1787-1871), George Brettingham Sowerby (1788-1854), and Charles Edward Sowerby (1795-1842); and a son of the second was also George Brettingham Sowerby (1812-84), the author of many illustrated works on natural history.

Sowerby Bridge, a manufacturing town in the West Riding of Yorkshire, on the Calder, 3 miles SW. of Halifax. It has a town-hall (1857) and manufactures of worsted and cotton, oilcloth, chemicals, iron, &c. Tillotson was a native of the parish. Pop. (1851) 4365; (1891) 10,408.

Sowing-machines. Formerly sowing was always performed by scattering the seeds from the hand over the prepared surface of the soil. This mode, distinguished as *hand-sowing*, is still employed in many places, especially on smaller holdings and in garden husbandry. In the United States there are broadcast-sowers carried in the hand, in which a mechanism turned by a crank expels the seed from the receptacle very evenly. In the more extensive operations of the farm it has been very much superseded by the use of sowing-machines of various kinds drawn by horses—the broadcast sowing-machine, the drilling-machine, and the dibbling-machine. The first is

employed exclusively for cereals and grasses, the other two for any kind of crop.

Cereals.—As above mentioned, cereals may be sown either broadcast, drilled, or dibbled. If the first method is to be adopted, the land receives what is called the seed-furrow, or, if rough, it gets a single stripe with the harrows, and the seed is then sown either by hand or by the broadcast machine. This machine consists of a triangular frame with the apex to the front, supported on three wheels, and carrying a long wooden box of the form of a triangular prism, set with a flat side—the lid—uppermost. This box, which is placed at right angles to the line of draught, is furnished with a row of small holes at the bottom, about 7 inches apart; and a little above this row is placed a longitudinal spindle, carrying a set of hard circular brushes, one opposite each hole, and deriving a rotatory motion from the axle of the hind-wheels. The size of the apertures can be adjusted to the desired quantity of seed per acre by means of a movable plate outside provided with holes corresponding to those of the box. When the box is supplied with seed, and the machine set in motion, the grain drops through the holes, which are kept from clogging by the rapid rotation of the brushes. The box is made of such a length (16 to 20 feet) that 30 to 35 acres may be sown in a day. The seed is then covered by harrowing. This machine is much used in Scotland, being rather better suited to hilly and uneven surfaces, and, from its more rapid execution, to a climate which frequently interferes with agricultural operations. In England, where the climate is more favourable and the surface more level, the drilling-machine is the favourite. So it is now in certain parts of Scotland, where the amount of seed deposited by drilling has increased immensely. The land is prepared for sowing by as complete pulverisation as possible, and its surface is made quite even by the harrow and roller. The drill (fig.), which in the arrangement of some of its essential

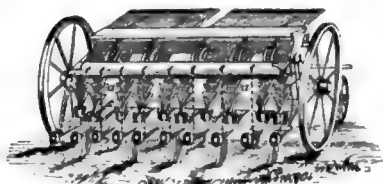

Corn-drill.

parts corresponds to the broadcast-machine, differs from it in being furnished with a set of coulters, which are hollowed behind to enclose the lower ends of a corresponding set of tin tubes, whose upper ends are fixed opposite to the holes in the seed-box. By this machine a series of furrows of uniform depth are made by the coulters; into these furrows the seed is directed by means of the tin tubes. The modern drill-machine covers the seed most uniformly. The harrowing is generally completed before drilling begins. The spindle inside the seed-box is provided with grooved cylinders or pinions in place of brushes, and the seed-rows are generally made from 4 to 10 inches apart. The advantages of this machine over the former consist in the greater regularity of deposition of the seed, which admits of hoeing and other cleaning operations during the early period of growth; in the uniform depth at which the seed is planted, so that none of it is lost by being buried, while it is all covered; in the protection of the operation from the disturbing influence of winds; in the saving of seed and greater yield of grain, it being often found

that if drilled seed be to broadcast, in quantity, as two to three, their respective yields are nearly as five to four; in the free access of sun and air during growth; and in the less liability of the crop to 'lodge' flat at the root. But it has one disadvantage: an ordinary drill cannot sow more than 10 to 12 acres per day, and employs more men and horses than the broadcast-machine. From 2 to 3 bushels of seed per acre suffices with the drill, whereas from 3 to 4 is necessary with the broadcast-machine, and from 5 to 6 bushels with the hand. The great saving of seed and other advantages thus fully atone for the extra work involved by the drill. Many kinds of grain-drills are in use in the United States; the drill for maize being a special modification of these.

The third method of machine-sowing, by dibbling, is employed chiefly on the light soils in the south of England, and now even there not generally, at least in the case of cereals, so that a minute description of the machines by which the operation is effected is unnecessary. Suffice it to mention that dibbling only requires about one-third of the seed which is necessary in drilling, and presents still greater opportunities for weeding and stirring the soil in the early stages of growth, but is attended with various important defects, and is more expensive.

When a cereal crop is to be followed by grass the grass seeds are sown a few days, perhaps even a week or two, after the other crop by a broadcast-machine or by the hand.

Beans.—The sowing of this crop (see BEAN) is performed by means of the *bean-barrow*, a machine the same in structure as the drilling-machine for corn, but wanting the coulters, and having only three tubes, through which the seeds fall. Peas are frequently sown along with beans, the latter acting as a support to the former, and the two together better preventing the growth of weeds. The hand is also sometimes adopted.

Turnips.—For this crop the ground must be more thoroughly cleaned and broken down than for any other; after which—if the drill-system is pursued—it is formed into drills from 26 to 29 inches apart, which are then supplied with manure, and covered with the drill-plough, splitting the original drills. The new ridges thus formed being directly above the manure, the seeds are sown on the top of each ridge by means of the *turnip-drill*. This machine has, instead of a seed-box of the ordinary form, two tin or tinned-iron barrels, placed on a spindle. Each cylinder has a row of holes round its middle circumference, the row being covered by a circular sliding collar of thin metal, perforated with corresponding holes. Each seed-box has its corresponding seed-tube and hollow coulters, as in the corn-drill; but the turnip-machine has in addition a roller in front of the coulters for compressing the crests of the ridges, and some machines have two light rollers attached behind which slightly compress the earth raised by the coulters and cover the seeds. In the southern counties of England a different form of machine is used, one which sows the seed in rows on the flat surface, and perhaps at the same time drops artificial manure, or waters the seed-bed, or both.

Sow-thistle (*Sonchus*), a genus of plants of the natural order Compositæ, sub-order Cichoraceæ. The Common Sow-thistle (*S. oleraceus*) abounds in Britain and in most parts of Europe as a weed in gardens and cultivated fields. It is an annual plant, delighting in rich soils, grows to the height of 2 or 3 feet, with somewhat branching stem, and small yellow flowers in corymbs. The tender tops and leaves are much used in the north of Europe as greens. It is a favourite food with hares and rabbits, is eaten by swine, sheep, and goats, but

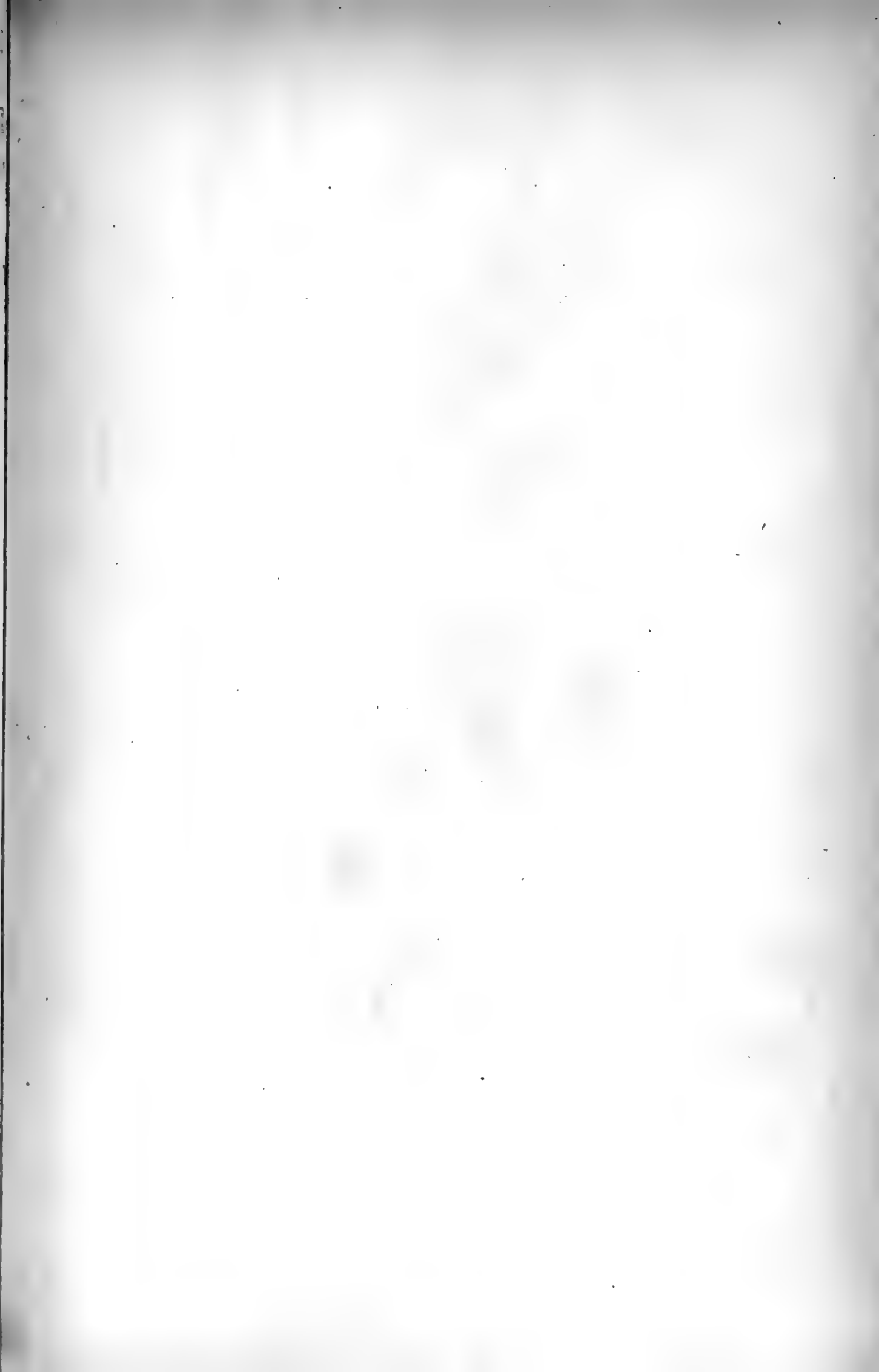

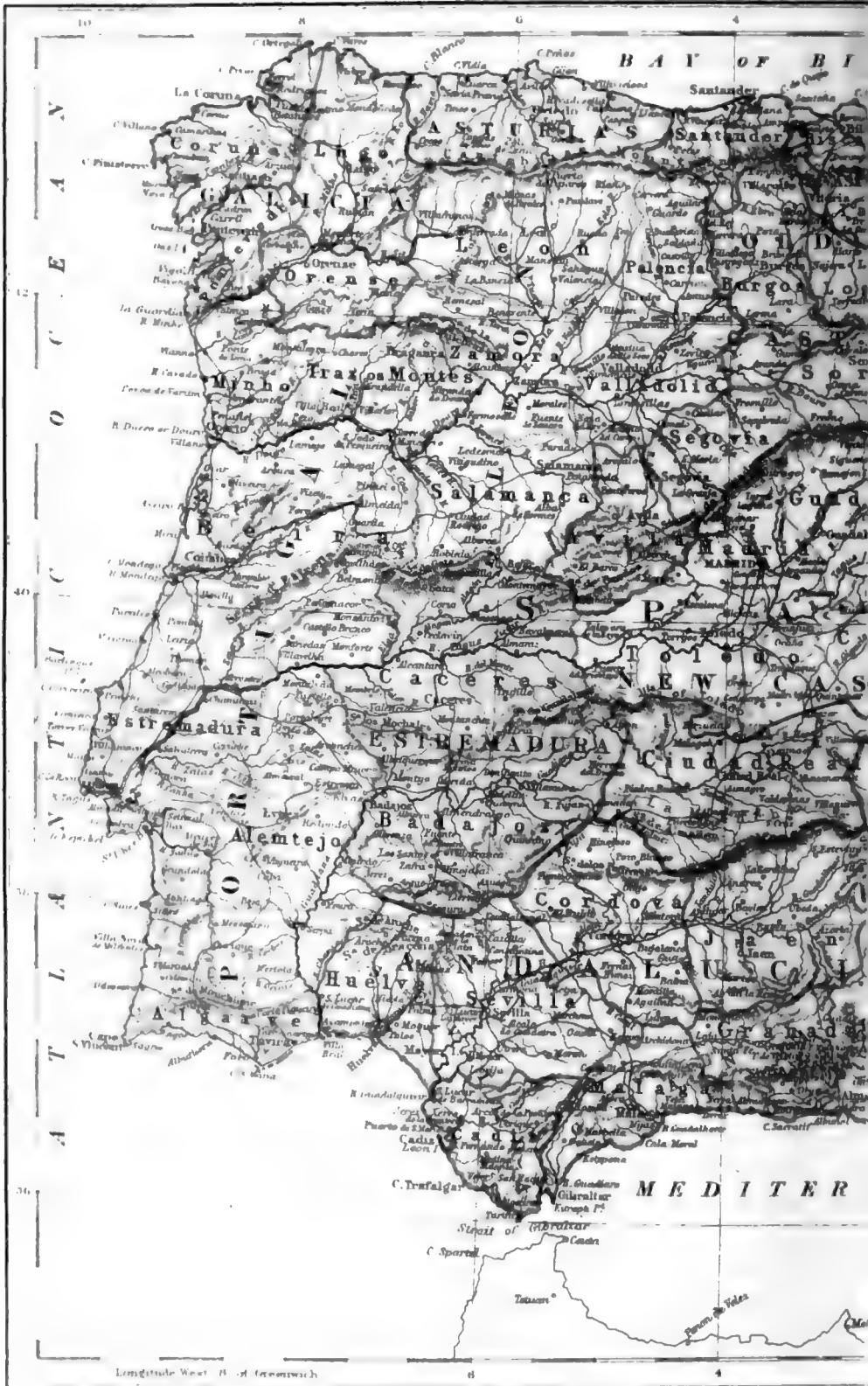

Longitude West of Greenwich

6

4



SPAIN & PORTUGAL

Scale of English Miles
 0 10 20 30 40 50 60 70 80 90 100

Railways thus

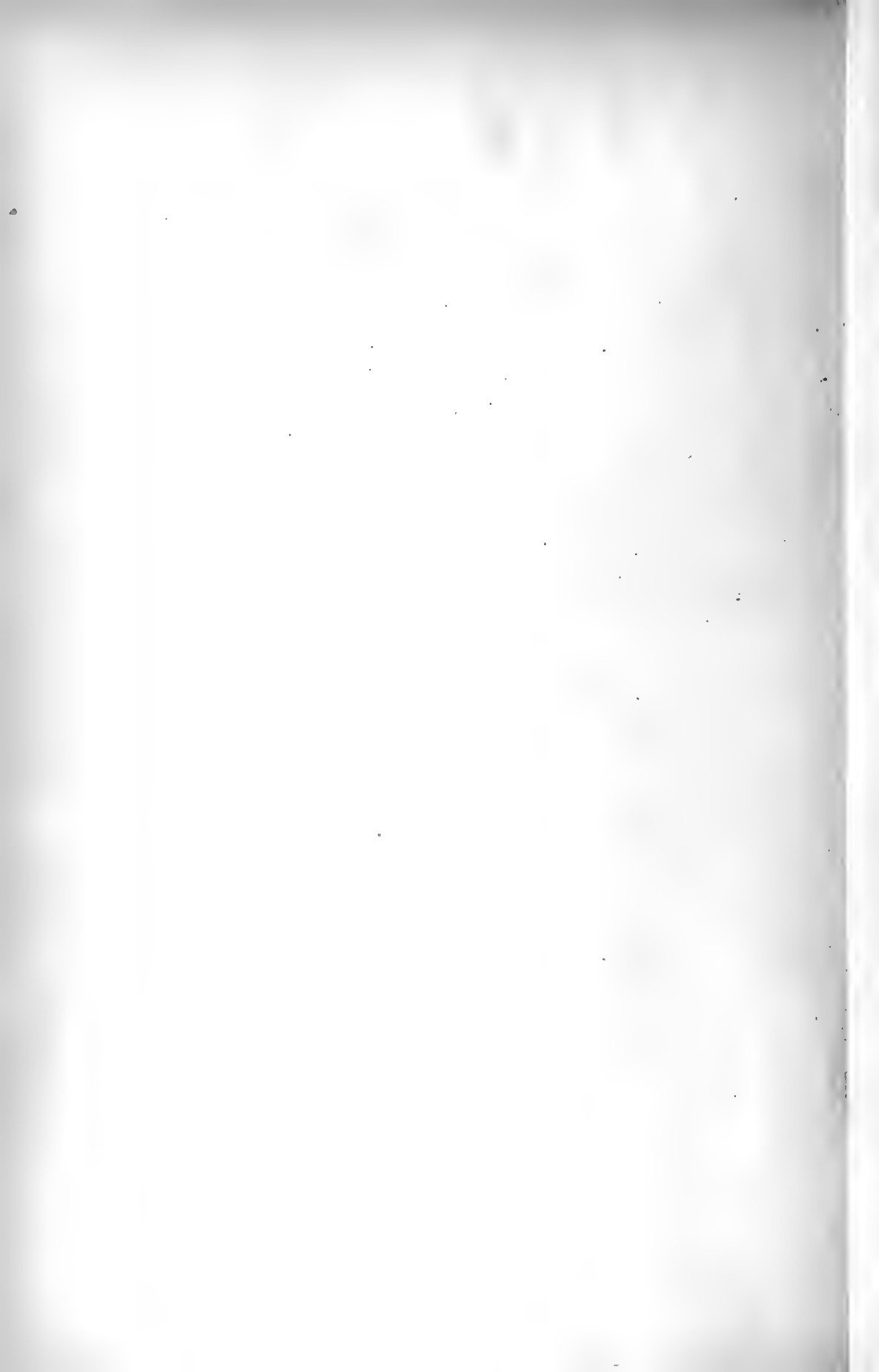

not relished by cattle and horses. The Corn Sow-thistle (*S. arvensis*) is a perennial with large yellow flowers, frequent in cornfields in Britain and throughout great part of Europe. Nearly allied to the genus *Sonchus* is Mulgedium, to which belongs the Alpine Blue Sow-thistle (*M. alpinum*), the beautiful blue flowers of which adorn some of the most inaccessible spots of the mountains of Switzerland and of Scotland.



Sow-thistle (*Sonchus oleraceus*).

is also common in India, although probably not a native of that country. The seeds resemble those of the Kidney Bean, and are used in the same way. The Japanese name is *Shōyu* (see JAPAN, Vol. VI. p. 236). Soy is made by mixing the beans softened by boiling with an equal quantity of wheat or barley roughly ground. The mixture is covered up and kept in a warm place to ferment, then put into a pot and covered with salt. Water is poured over the mass, stirred daily, then poured off and filtered.

Soyer, ALEXIS, cook and author of books on gastronomy, was born at Meaux in 1809, and, designed for the church, was trained as chorister in Bossuet's famous old cathedral. But his inclinations turned another way: he went through a systematic training as cook in several notable restaurants in the provinces and in Paris, and, suppressing some temptation to give scope to his dramatic powers and fine voice on the stage, he became the most famous cook of his time. He had a post in Prince Polignac's kitchen in 1830, and was nearly murdered there by the revolutionists, but escaped to London, and was cook in various hotels, private houses, and latterly in the Reform Club (1837-50). For a time he managed a 'symposium' or restaurant of his own. He had gone to Ireland during the famine (1847); contributed greatly to improving the food of the army and navy; and in 1855 he went for a time to the Crimea to reform the food-system under which the army was suffering. His works greatly increased the public interest in economic, scientific, and tasteful cookery, and comprised *Culinary Relaxations* (1845); *Charitable Cookery* (1847); *The Gastronomic Regenerator* (1846; 9th ed. 1861); *The Modern Housewife* (1849; 36th thousand, 1866; new ed. 1872); *Skilling Cookery-book* (1854; 123d thousand, 1858). He wrote an account of his experience in the Crimea, and died 5th August 1858. See the memoirs by Volant and Warren (1858).

Sozomen, a Constantinople lawyer (5th c.), born at Gaza, who wrote a church history largely based on Socrates. See CHURCH HISTORY.

Spa, a watering-place of Belgium, stands amid wooded and romantic hills 20 miles by rail SE. of Liège. The principal buildings are the casino,

bath-house, and similar institutions for the use of visitors. One of the chief charms of the place is its beautiful drives. The springs, all chalybeate and alkaline, are cold, bright, and sparkling, and efficacious in anæmic complaints, nervous diseases, &c. This water is exported to all quarters of the globe. Spa is famed for the manufacture of fancy wooden lacquered ware. Pop. 7278. The number of visitors during the season is about 12,000. The virtue of the waters was known as early as the 14th century, and the place was particularly famous as a fashionable resort in the 16th and 18th centuries. Its public gaming-tables were suppressed in 1872. From Spa the generic term for a watering-place or mineral baths is derived.

Spaccaforno, a town in the south-east corner of Sicily, 30 miles SW. of Syracuse. In an adjoining valley are some remarkable 'Troglodyte' caves, ranged tier upon tier. Pop. 8588.

Space. See PSYCHOLOGY, Vol. VIII. p. 475; DIMENSION; and GEOMETRY.

Spade-husbandry. The operation of digging is performed with a spade, or pronged fork, or with a steam-digger. The spade or fork is thrust in with the foot, and the mass of earth is first loosened by the lever-power of the handle, then lifted and inverted. When this operation is performed in spring or summer, the ground should be dry, so as to obtain pulverisation as easily and to as great extent as possible. In stronger soils, which are dug in autumn, a little moisture is desirable, as the land lies fallow, and the frosts of winter afterwards pulverise and reduce it to a proper degree for receiving the crops in spring. Digging by hand is mainly confined to the cultivation of gardens and small 'crofts,' for, though a most efficient means of cultivating the soil, it is too expensive for field-crops. It is resorted to, however, for digging over or trenching land which has been in timber or full of stones or boulders. Formerly the spade was the only implement used for digging, but steel forks are now more largely used, being lighter and more easily driven into the soil. Besides preparing the land for plants, the spade and the fork, chiefly the latter, are used for taking crops, such as potatoes and carrots, out of the ground. For the important subject of spade-husbandry and cottage-farming as an economic and social problem, see PEASANT PROPRIETORSHIP.

Spadix. See SPATHE.

Spagnoletto. See RIBERA.

Spahi, the Turkish form of the Persian word *Sipahi* (from which we get Sepoy), was the term for the irregular cavalry of the Turkish armies before the reorganisation of 1836.

Spain (Span. *España*) occupies the larger part of the south-western peninsula of Europe, and attains in Cape Tarifa the most southerly point of the whole continent. It lies between 43° 45' and 36° 1' N. lat., and between 3° 20' E. and 9° 32' W. long. It is bounded on the N. by the Bay of Biscay and by the Pyrenees, on the E. and S. by the Mediterranean, on the SW., W., and NW. by the Atlantic and by Portugal. From Fuenterrabia in the north to Tarifa in the south is 560, from Cape Finisterre in the north-west to Cape Creux in the north-east is 650 miles. The area is 191,367 sq. m.; the population in 1890 was estimated at 17,500,000. The country, including the Balearic and Canary Isles, was divided in 1834 into forty-nine provinces; but the names of the fourteen more ancient kingdoms and provinces are still in use (see table). The census of 1897 was expected to show a total of 18,000,000; but national troubles delayed statistical work. The table shows the census of 1887.

Copyright 1892, 1897, and 1900 in the U. S. by J. B. Lippincott Company.

Ancient Provinces.	Modern Provinces.	Area in sq. miles.	Pop. in 1887.
NEW CASTILE	Madrid	2,997	684,630
	Toledo	5,586	359,562
	Guadalajara	4,869	201,496
LA MANCHA	Cuenca	6,726	242,024
	Ciudad Real	7,840	292,291
	Burgos	5,651	337,822
	Logroño	1,945	181,465
OLD CASTILE	Santander	2,112	242,843
	Soria	3,836	151,471
	Segovia	2,714	154,457
	Ávila	2,962	193,003
	Palencia	3,126	188,954
LEON	Valladolid	3,043	267,297
	Leon	6,167	380,229
	Zamora	4,135	269,621
	Salamanca	4,940	314,424
ASTURIAS	Oviedo	4,090	595,420
	Coruña	3,078	613,792
GALICIA	Lugo	3,787	431,644
	Orense	2,759	405,074
ESTREMADURA	Pontevedra	1,759	443,385
	Badajoz	3,698	480,418
	Cáceres	3,014	339,793
ANDALUSIA	Sevilla	5,429	543,944
	Cádiz	2,829	429,331
	Huelva	4,122	254,831
	Córdoba	5,800	420,714
	Jaén	5,134	437,842
	Granada	4,937	434,341
MURCIA	Almería	3,302	339,838
	Málaga	2,824	519,377
	Murcia	4,477	491,438
VALENCIA	Albacete	5,972	229,492
	Valencia	4,353	733,978
	Alicante	2,098	432,335
ARAGON	Castellón	2,446	292,437
	Zaragoza	6,607	414,007
	Huesca	5,378	254,958
CATALONIA	Teruel	5,494	241,835
	Barcelona	2,985	899,264
	Tarragona	2,451	343,579
BASQUE PROVINCES	Lérida	4,775	285,417
	Gerona	2,272	305,539
	Navarra	4,046	304,051
North African Settlements	Viscaya	849	235,659
	Guipuzcoa	728	181,856
	Alava	1,205	92,893
	5,086
	Total	191,367	16,949,872
ISLANDS	Balearic	1,860	312,646
	Canaries	2,944	287,728
	General Total	196,171	17,550,246

The population of Spain includes 18,480 French, 6755 Portuguese, 5719 English, 3877 Italians, 1826 Germans, and 5738 of other nationalities.

Of the once great colonies of Spain, all that remained in 1898 were the Philippine Islands, Cuba, Porto Rico, the Caroline and Pelew Islands, the Ladrões, with Fernando Po, Annobon, &c. Of these the Philippines, Cuba, Porto Rico, and Guam (the chief island of the Ladrões) were ceded to the United States in 1898 as a result of the war with that power; and the Carolines, Pelews, and remaining Ladrões were sold to Germany in 1899.

Coast-line.—The coast-line is estimated at 1317 miles, of which 712 belong to the Mediterranean and 605 to the Atlantic. Spain has thus but 1 mile of coast-line to 145 sq. miles of area, while Italy has 1 to 40 and Greece 1 to 7. The shore of the Bay of Biscay presents an almost unbroken wall of mountain and rock, but in the north-west and west appears the most southerly prolongation of the fiord or firth system of Norway, western Scotland and Ireland, forming as usual fine harbours—Ferrol, Corunna, Vigo, &c. Portugal indents a frontier of nearly 400 miles; to the south, from Portugal to Gibraltar, the Atlantic coast is low. Cadiz is here the chief harbour. The southern Mediterranean shore is rocky, backed up by the huge mass of the Sierra Nevada and its prolongations to Cape Gata. Malaga and Almería are the chief harbours here; in the south-east and east are

the naval arsenal of Cartagena and the commercial ports of Valencia and Barcelona and others. Though almost a peninsula, this uniform character of the coast-line and the great elevation of its central plateau give Spain a more continental character in its extreme range of temperature than any of the other peninsulas of Europe. The greater part of its surface consists of a plateau of between 2000 and 3000 feet above the sea-level, traversed by loftier ranges. On the east the plateau is buttressed by chains which descend rapidly to the Mediterranean. The mountains of Oca, the Sierra de Moncayo, and the Idubeda Mountains rise sharply from the valley of the Ebro on the north; the Sierra Morena on the south is of inferior elevation; the western ranges run into the frontier of Portugal, and lose themselves in the Atlantic. Outside the plateau lie the highest summits of the whole country, the Pic de Néthou in the Pyrenees (11,151 feet), and the Pic de Velate in the Sierra Nevada (11,670), while the Picos de Europa in the Cantabrian Range attain over 8000 feet. The plateau itself is traversed by four mountain-ranges, the Oca and Idubeda Mountains above mentioned, which separate the valley of the Ebro from that of the Douro; the Guadarrama Range, which divides this river from the basin of the Tagus; the Sierra de Toledo, which forms the watershed between the Tagus and the Guadiana; while the southern buttress, the Sierra Morena, forms the northern wall of the valley of the Guadalquivir. The whole plateau has a general slight inclination from east or north-east to south-west, and hence all the considerable rivers of Spain except the Ebro flow westward to the Atlantic. The general elevation of the plateau conceals the real height of its mountains and passes; thus, the highest point of the railway from the north to Madrid is about 60 feet higher than the tunnel of Mont Cenís, and that of the old coach-road through the Guadarrama is 300 feet higher still.

Geology.—A mass of granitic, Cambrian, and Silurian rocks extends from Galicia south-east to the valley of the Guadalquivir. The Carboniferous formation occupies the north and south-west corners of the great plateau. The valley of the Ebro is a trough of Secondary rocks extending from the Bay of Biscay to the Mediterranean; another band of Secondary rocks forms the region of Andalusia south of the Guadalquivir; the Upper Cretaceous formation stretches from the basin of the Ebro to the granite of the Guadarrama and to the east of Madrid; these older formations are overlaid by Tertiary, Eocene and Miocene, marine and fresh-water deposits. The visible surface of Spain consists of 37 per cent. of crystalline and Palæozoic rocks, 34 per cent. of Tertiary, 19 of Secondary rocks, and 10 per cent. of Quaternary deposits. The remains of undoubted volcanoes are found at Olot in Catalonia, at Cabo de Gata in the south-east, and at Ciudad Real in La Mancha. To the frequency of older igneous action, and to the fractured condition of the later rocks, is perhaps due the great mineral wealth of Spain.

Climate and Products.—The configuration of the country renders the climate very varied. In parts of the north-west the rainfall is among the heaviest in Europe. In the east and south-east occasionally no rain falls in the whole year. Even in the north the contrasts are striking. The rainfall in the Western Pyrenees is very great, yet on the northern slope of the valley of the Ebro there are districts almost rainless. The western side of the great plateau, speaking generally, is more humid and much colder than the eastern, where irrigation is necessary for successful cultivation. With this difference in climate goes a corresponding difference in products. Galicia is almost a cattle country;

Extremadura possesses vast flocks of sheep and herds of swine. The vegetable productions of Galicia and the Asturias are almost those of Devonshire and of south-west Ireland. Till the 18th century cider was the great beverage in the north; but in the basin of the Minho, in the Riojas on the Ebro, in Navarre, Aragon, and Catalonia strong red wines are grown in abundance. The productions of Catalonia and Tarragona are almost those of Provence and the Riviera. The plains of Leon and of Old and New Castile are excellent corn-growing regions. From Valencia southwards the products are semi-tropical; the climate is almost more tropical than that of the opposite coast of Africa. Fruits of all kinds, luscious or fiery wines, oil, rice, esparto grass, and sugar are common along the coast. No other part of the soil of Europe is so rich in varied produce. It is curious to note how much of this is originally exotic, but has become naturalised. Like all other countries of western Europe, the agriculture of Spain has been depressed of late years by competition with America; but her export of wine to France has been greatly increased owing first to the destruction of the French vineyards by the phylloxera, and afterwards to the war of tariffs between France and Italy; the export of wine to France is over £10,000,000, while that to England is only £866,000. The quantity of agricultural produce in Spain in cereals, wine, oil, and fruit seems to be limited only by the paying demand, and is checked only by the cheaper competition of other countries. Large tracts of Spain once cultivated in Roman or in Moorish times now lie abandoned and unproductive; 46 per cent. of the territory is uncultivated.

Population.—For a moment in the 16th century Spain was the most important country in Europe; but the population was unequal to the drain upon it caused by constant warfare, emigration, expulsion of portions of the inhabitants of the peninsula, and above all by adverse economical and industrial conditions. Thus a population of over 10 millions at the end of the 15th and beginning of the 16th centuries fell to little more than 6 millions in the 17th; the numbers then slowly rose: (1768) 9,307,804; (1797) 10,541,221; (1857) 15,464,340; (1860) 15,673,536; (1870) 16,835,506. Spain, if the census can be trusted, has increased in population some 7,000,000 during the 19th century. As in other countries, the town and industrial population has augmented in a greater ratio than the rural and agricultural. In 1887 there were in Spain one city with over 400,000 inhabitants, Madrid; one of 250,000, Barcelona; three of between 150,000 and 100,000, Seville, Valencia, and Malaga. The most densely populated provinces are Madrid, Barcelona, Galicia, and the Basque Provinces. Emigration, which is steadily on the increase, is proving a heavy drain on the country; already there are not enough labourers in the agricultural districts, and every year thousands of families are seeking new homes and higher wages in South America, Algeria, and elsewhere.

Industries.—Some 60 or 70 per cent. of the population are engaged in agriculture of various kinds, and 10 or 11 per cent. in mining or manufacturing industries and trade. Since the sale of church, crown, and much of the municipal property during the 19th century the land has become much divided; it is estimated that there are about 3½ millions of farms, of which ¾ million are occupied by tenants, the rest by proprietors. The seat of the manufacturing industries—mainly cotton—is chiefly Catalonia; and the manufacture of corks (1,400,000,000 yearly) employs over 8000 men in that province. The mineral wealth is more widely

distributed—iron in Biscay and the province of Huelva; copper at Huelva, in the Rio Tinto and Tharsis mines; lead at Liñares; quicksilver at Almaden; coal chiefly in the Asturias; salt in Catalonia, and by evaporation near Cadiz. The amount produced in 1888 was as follows:

Minerals.	Production in Tons.	Exported in Tons.
Iron.....	5,609,876	4,464,385
Lead.....	856,545	2,168
Argentiferous Lead.....	183,441	8,825
Copper.....	8,202,416	825,046
Zinc.....	74,358	82,004
Quicksilver.....	27,847	..
Salt.....	413,886	285,182
Coal, Coke.....	1,225,178	..
Smelted Metals.	Production in Tons.	Exported in Tons.
Iron and Steel.....	252,116	96,801
Lead.....	161,462	58,957
Argentiferous Lead.....	75,876	70,686
Copper.....	70,719	45,080
Zinc.....	26,173	1,089
Quicksilver.....	1,865	1,104

Until lately the only religion tolerated was that of the state, the Roman Catholic; now a certain toleration is allowed to other denominations. The Catholic clergy are paid by the state; ecclesiastical matters are regulated by the Concordat of 1851. There are nine archbishops, with fifty-seven suffragan bishops, four unattached bishops, and about 35,000 clergy. Since 1868 the theological education is given in seminaries entirely under the hands of the bishops.

Education varies greatly among different classes and in different provinces. In the large towns and in some of the provinces a great effort is made to keep the higher and the technical schools on a level with the best in other European countries. In other parts the neglect is very great. There are ten universities—Madrid, Barcelona, Granada, Oviedo, Salamanca, Seville, Santiago, Valencia, Valladolid, and Saragossa: the number of students is about 17,000. In the episcopal seminaries and religious schools about 9000 are educated. Of secondary institutions there are about 70, with 356 affiliated colleges. The primary schools number some 25,000, with 1,500,000 pupils, and the private schools 5000, with about 300,000 pupils. Many of the primary schools in the provinces are in a wretched condition, the salary of the teachers being only about £5 per annum, and the buildings and other appliances to match. The great fault of the higher Spanish education is in the numbers who press into professional, literary, and political careers in comparison with those who dedicate themselves to commercial, industrial, or agricultural pursuits. By reason of this Spain loses great part of the advantages of her natural wealth. All her principal mines are worked, her railways built, schemes of irrigation carried out with foreign capital, and in spite of the excellence of her labourers the higher employees are often foreigners. The progress of agriculture is impeded in the same way, and legislation is too often founded on merely theoretical ideas, instead of any practical knowledge of the real needs of the country.

The total imports and exports of Spain have much increased of late years. The imports in 1877 amounted to £16,340,672, and the exports to £18,175,140; in 1887 £22,550,072 and £25,326,612; in 1890 £37,645,517 and £37,510,395 respectively. The recent increase is chiefly due to the export of wine to France and imports from that country. The exports from Spain to Great Britain are about £11,500,000, and the imports £5,000,000; but the statistics are always behind-hand and often very confused. Since October 1848 over 6000 miles of railway have been constructed. Madrid, the capital, is now in railway communication with all the chief harbours and commercial routes in the kingdom, and also with Portugal. Two lines

at either extremity of the Pyrenees connect the Spanish with the French and European lines, and a third was in 1892 constructed through the centre of the chain. 10,670 miles of telegraph are open.

The government of Spain is a hereditary monarchy founded on the constitution of 1876. The Cortes consists of two bodies—the Senate, one-third of the members of which sit by hereditary right, one-third are appointed by the sovereign for life, and one-third elective. The Chamber of Deputies is elected at the rate of one member to every 50,000 inhabitants. Universal suffrage (1890) and trial by jury have lately been introduced. The provinces are administered by governors and provincial deputations, and the towns by *alcaldes* and municipal councils, all formed more or less after the model of the French prefects, councils-general, *maire*, &c. All these and other employees are under the control of the government, who are thus able to manipulate elections, except in the large towns. The public debt of Spain, funded and floating, is about £259,900,000, bearing an interest at 4 per cent. of over £10,750,000. The revenue and expenditure, nominally nearly balanced, have risen from £31,000,000 in 1881 to £35,000,000 in 1891, and the wealth of the country is gradually increasing.

The navy of Spain consists of two great ironclads (with another building), six cruisers of the first class, of 44,000 tons collectively, three smaller ironclads, and thirty-five unarmoured cruisers, gunboats, and torpedo-catchers, besides fifty torpedo-boats and small gunboats. A large proportion of the naval ships were captured or destroyed in the war with the United States, 1898.

The legal official currency is founded like the French on a decimal system, the *peseta* of 9·6 pence being the unit; but the terms of the older coinage are still in use, especially for copper money and small change. The legal measures are still more closely copied from those of France; but the older measures of capacity and weights are still in use in many of the provinces.

See, besides the standard Spanish topographical and statistical books, *Borrow's Bible in Spain*, *Ford's Handbook and Gatherings from Spain*, A. J. C. Hare's *Wanderings in Spain*, and later books on the country and its life by Mrs. Harvey (1875), Rose (1875-77), Campion (1876), Frances Elliot (1882), Gallenga (1883), Hope-Edwardes (1883), Olive Patch (1884), Willkomm (Prague, 1884), Lomas (1885), Parlow (Leip. 1888), H. T. Finck (1891), and the present writer (1881).

HISTORY.—Spain (*Spania*, *Hispania*, *Iberia* of the Greeks and Romans), from its position as the south-west peninsula of Europe, beyond which was the ocean only, early became a very eddy of tribes and races. Its prehistoric ethnology is not determined. The earliest race of which we have authentic testimony is the Iberian. It occupied nearly the whole of Spain and the south of France before the Roman conquest. Overlying these Iberian tribes are probably two invasions of Celtic peoples: the earlier mingled with the Iberians, and formed the Celtiberian tribes of central and western Spain; the later has left the more purely Celtic names in the north and north-west. There was probably never any Iberian nation—only a congeries of tribes of the same race like that of the North American Indians, but in a higher state of civilisation—a civilisation excelling that of contemporaneous Gaul or the more purely Celtic tribes to the north. The Iberians were adepts at mining, and used writing (see *BASQUES*). Omitting traces left by mere traders, such as the Phœnicians on the south and south-west, the Egyptians on the east, Greeks from Massilia on the north-east, the first power which seriously attempted to occupy Spain was Carthage (q.v.). The Carthaginians

had probably succeeded to the commercial enterprises of their mother-country Phœnicia; but it was not until they had retired baffled from Sicily that the occupation of Spain was seriously begun. Hamilcar, first of the great line of Carthaginian generals, opened the conquest in 238 B.C. (see *CARTHAGE*, *HAMILCAR*, *HANNIBAL*). Here again they were met and thwarted by the Romans (see *ROME*, *HANNIBAL*, *SCIPIO*). It then became the task of the Romans to conquer Spain. In subjugating the Iberian and Celtiberian tribes of Spain they found far greater difficulty than with any more purely Celtic race. Spain early showed her tenacity of resistance. The sieges of Saguntum, Numantia, Clunia are memorable in history. Even when conquest seemed assured Viriathus (147-140 B.C.), probably a native, and Sertorius, a Sabine leader (83-72 B.C.), tried the capacity of the best generals of Rome. It was in Spain too that the final issue between Caesar and the Pompeians was fought out at Munda. Spain was not completely brought under Roman rule till the time of Augustus. Once subdued, it became thoroughly Roman. The impress of Rome has been deeper on the language, manners, and religion of Spain than on those of any other country. Under the Romans Spain was divided first into two provinces—Nearer and Farther Spain: in the time of Augustus these became three—Bætica, embracing nearly the modern Andalusia; Lusitania, Portugal with some of the western Spanish provinces; and Tarraconensis, comprising the remainder of the country. Local rule and customs and speech were, however, not wholly obliterated in the varied *Municipia* and *Respublicæ*. Celtiberian coinage continued contemporaneously with that of Rome, and for probably 200 years after Augustus. All the great arts and works of Roman civilisation flourished. Latin was the language of the educated classes, and Spain furnished a large contingent of authors to the silver age—Martial, Seneca, Quintilian, Lucan, Silius Italicus, Columella, Pomponius Mela. Trajan was a Spaniard. Some of Spain's greatest cities still bear Latin names—Legio (Leon), Emerita Augusta (Merida), Cæsar Augusta (Zaragoza or Saragossa), Pompeiopolis (Pamplona). During Roman rule Christianity was introduced into Spain, and rapidly spread. In 325 A.D., at the Council of Nicea, Hosius of Cordova was the greatest name in the west, overshadowing that of the bishop of Rome. Prudentius (338-405), almost the first Latin Christian poet, was a native of northern Spain. Two centuries later (560-636) Isidore, bishop of Seville, was the most learned writer of the west.

With all western Europe Spain felt the effects of the downfall of the Roman empire. The native Spanish legionaries were serving in all parts of the empire; barely two foreign legions garrisoned the whole of Spain. Thus, when the Suevi, Alans, Vandals (c. 409), Visigoths (414; see *GOTHS*) invaded Spain, the country, which had cost the Romans two centuries to subdue, had little means of resistance. The Suevi established themselves in Galicia and Lusitania, the Vandals penetrated farther south, and gave their name to (V)andalusia; thence in 429 they crossed to Africa. The Visigoths brought with them more than a tinge of Roman civilisation. Though both Visigoths and Vandals were nominally Christians, their Arian heresy placed them in opposition to the native bishops, the most ardent defenders of the Nicene faith. For some time Spain was only a province of a larger Visigothic kingdom. Theudis (573) was the first Visigothic king who fixed his court in Spain. It was not till the reign of Leovigild (584) that the Suevi were definitely dispossessed, and not till the reign of Suintilla (624) that the Byzantine Romans were finally expelled from the east coast; and even to the end they

retained the Straits of Gibraltar and a few towns in southern Portugal; and some native tribes in the Orospeña Mountains preserved their independence. The abjuration of Arianism by the sons of Leovigild strengthened the church at the expense of the monarchy. The bishops were supreme in the councils of Toledo, which were also the chief councils of the state. The Jews, unmolested by the Arians, were now persecuted and rendered hostile. They intrigued with the Mohammedan Arabs, who had conquered North Africa and crushed out Christianity. Their assistance and that of the count of the Roman possessions in the straits enabled Tarik to land at Tarifa; and the Gothic monarchy was destroyed at the battle of the Guadelete (711), where fell also Roderic, last of the Gothic kings. The chief mark left by the Goths in Spain was in legislation; first in the *Lex Romana Visigothorum*, then in the *Fuero Juzgo* or *Forum Judicum*. The tradition of a conquering caste and the events of the reconquest made the Spanish aristocracy look on the Visigoths as the English gentry do on the Normans; otherwise their influence has been exaggerated. The few remains of art are copies of Byzantine models. Of literature not a trace remains.

The Moors in Spain.—Seldom has there been so rapid a conquest as that of Spain by the Arabs and Moors. In 714 they had gained the whole of Spain except the north and north-west. In 719 they had added the Narbonne to their dominions; in 732 they reached their extreme northern limit when defeated by Charles Martel at the battle of Tours. The Arabs and Moors were divided by racial, tribal, sectarian, and dynastic differences. The old quarrels which had existed in Arabia before the time of Mohammed broke out again in Spain as soon as the first enthusiasm of conquest had subsided. Arabs and Berbers of North Africa were ever at strife; the feuds between the sects of Islam raged bitterly in Spain, and the claims of rival dynasties—e.g. the Abbasides and Omniades—weakened the common cause. Whenever the Moors were united the progress of the reconquest was checked; the Christians gained ground when division and disunion spread among the invaders. The final expulsion was delayed for centuries through the civil strife of the Christian kingdoms. The rule of the early emirs was by no means harsh; a Gothic chief Theodoric preserved an independent Christian kingdom, Todmir, in Valencia and the neighbouring provinces. The Jews were treated almost as equals, the Christian religion was tolerated to the Mozarabes (see MORISCOS). There were differences in the several provinces, but at Cordova only, which became the capital of the western califate (see CALIF, MOORS), was any persistent persecution carried on. Under Abderrahman I., the heir of the Omniades, and his successors the Arab rule in Spain attained its highest glories. He (756) and his son Hakam I. (796) made Cordova the finest city in the west; its mosque (786-796) is still one of the grandest remains of Arabic architecture. No Christian people in the west was then capable of such work. The greatest chief of this period was Almansor, who forced back the tide of Christian conquest and penetrated to Compostella in Galicia (997); but all his conquests were lost at Catalañazor (1002). Many Moorish names survive in Spanish topography (see NAMES). The origin of the various Spanish kingdoms of the reconquest is obscure. Pelayo, said to be of Gothic or mixed Roman blood, began the reconquest at Covadonga in 718. A little later a distinct organised resistance commenced in Navarre and in Aragon. The counts of Barcelona established themselves in the Spanish March which dated from Charlemagne (q.v.) and Louis. The most

important of these kingdoms was that of Asturias. Galicia on the west was soon annexed to it, then Leon to the south. Alfonso I. 739-756) had already overrun the country as far as the Mondego and the Sierra de Guadarrama. Alfonso II. (791-842), the ally of Charlemagne, pushed his raids as far as Lisbon, and founded in the north the cities of Compostella and Oviedo. Alfonso III. (866-909) removed the capital to Leon, and reached in one expedition the Sierra Morena. The unwise division of his dominions among his sons retarded the advance for a time. After the battle of Catalañazor the Christian frontier stretched from the Tagus to Tudela on the Ebro; and Castile (the land of frontier castles), which had been governed from 932 by semi-independent counts, rose into a new kingdom. From this period date the constitutional liberties of Spain. The councils summoned by the king continued those of Toledo, and were as much political as ecclesiastical: assemblies of the nobles and magnates to settle the succession or election of kings were held in 931 and 933; but the first more general Cortes was that of Leon, 1020. In it was established the right of *behetria*—i.e. of changing lords, which in Spain prevented many of the worst feudal abuses, but encouraged civil war. Many of the fueros were now granted in order to attract defenders to towns reconquered and denuded of inhabitants (see FUERO).

After the death of Bermudo III. (1037) the crowns of Leon and Castile were united under Ferdinand the Great; his son, Alfonso VI., by his capture of Toledo (1085) made the Christian power predominate. In spite of a defeat at Zalacca (1086) and at Ucles (1108), Toledo was never reconquered by the infidels, and the Guadiana instead of the Tagus was now the Christian boundary. To the reign of Alfonso VI. belongs the story of the Cid (q.v.), of his strange career as ally alternately of Moor and Christian, of his occupation of Valencia from 1096 to 1102. Henry of Burgundy founded the country or kingdom of Portugal in 1095 (see PORTUGAL). Alfonso VII. lost the battle of Alarcos (1194), but the great victory of Navas de Tolosa (1212), under the allied kings of Castile, Navarre, and Aragon, broke entirely the power of the Almohades, and made New Castile secure. The separation of Leon from Castile (1157-1230) weakened for a time the Christian forces. Under St Ferdinand, the grandson of Alfonso IX., the crowns of Leon and Castile were finally united. He wrested Cordova from the Moors (1236), Jaen (1246), Seville (1247), Jerez and Cadiz (1250), Granada became a tributary kingdom, and the line of the Guadalquivir was held by the military orders of Calatrava, Santiago, and Alcantara. Ferdinand died in 1252. Navarre (q.v.) by the succession of the line of Champagne had become almost a French kingdom. To the east Saragossa had been taken in 1118. Valencia had been lost for a time, but first Majorca and the Balearic Isles (1228), then Valencia (1237) fell before the arms of Jaime I. of Aragon, and Murcia was won for Castile (1244).

In constitutional progress Navarre and Aragon kept pace with Castile. Each had its separate Cortes, with three estates in Navarre and four in Aragon, and its own code of laws. Castile used the *Fuero Juzgo* and the *Fuero Real*, limited by local fueros; in Navarre and Aragon the fuero was supreme. Catalonia had her *usutges*. The *Siete Partidas* of Alfonso X. did not become law till 1384. In ecclesiastical matters Spain had become more closely papal; the Roman rite had superseded the Isidorian or Mozarabic after the taking of Toledo; the finest of the cathedrals of Spain—Leon, Burgos, Toledo, &c.—date from this period. Christian Spain had increased immensely in wealth,

yet it took nearly two and a half centuries to destroy the remains of Moorish power. The period between the death of St Ferdinand and the accession of Isabella of Castile (1468) was one of trouble and almost constant civil war. The influence of the Moors on Christians was in some ways more marked than before. Alfonso the Wise (1252-84) in his court at Toledo adopted the best of Moorish science and literature, and the philosophy and art which they had acquired from the Greeks and Byzantines, and henceforth Spanish was not inferior to Moorish civilisation. A century later the Moorish influence was almost wholly ill in the Sevillian court of Pedro the Cruel, the ally of the Black Prince, whose whole career and death by his brother's hand was more like that of an oriental sultan than of a western monarch. The troubles of Castile arose from disputed successions, from long minorities, from the claim of the nobles, even those of the royal family, to transfer their allegiance to any sovereign they might choose (*behetria*). The Infantes de la Cerda and Henry of Trastamare acted alternately as subjects of Castile, Aragon, or France, or entered into alliance with the Moors, as might serve their private interests. The only trustworthy allies of the crown were the burghers and the clergy, but the rivalry of the cities made their allegiance doubtful. At the death of Henry IV. (1474) the crown of Castile was left with two female claimants, his daughter Juana (the Beltranaja) and his sister Isabella. The election of the former meant union with Portugal; by the marriage of Isabella with Ferdinand of Aragon her election united Castile and Aragon. Under a series of strong monarchs, whose authority was limited by a powerful aristocracy, Aragon had become a strong Mediterranean power—to the Balearic Isles had been nominally added Corsica and Sardinia, more really Sicily and Naples, with claims on Northern Italy; these claims and possessions after the union led to the waste of Spanish blood and treasure for centuries, without any corresponding advantages. The conquests from the Moors in this period were few but important—Tarifa (1292), to recover which the African Moors made their final effort of conquest; their defeat on the Salado (1340) entailed the loss of Algeciras in 1344; and Gibraltar, which they had recovered after 1309, became Spanish in 1462. Henceforth the Moors existed in the Peninsula on sufferance only, while the Christians were gathering their forces for the final blow.

Small as were the resources left to the Moors, they were weakened still further by dissensions in the ruling families. Boabdil, the last king of Granada, would have made terms with Castile; his uncle, Muley Hacem of Malaga, and his nephew, El Zagal, opposed a strenuous resistance. Alhama was taken 1482, Ronda 1485, Malaga 1487, Baza 1488, and the Spanish sovereigns with an army of 100,000 men sat down to the siege of Granada in 1491. January 2, 1492, the city surrendered; October 12, 1492, Columbus discovered America; in 1512, after the death of Isabella, Ferdinand wrested Spanish Navarre from its Gascon king.

Henceforth the history of Spain is no longer exclusively Spanish, but also European. The whole of the Peninsula except Portugal was united under one rule, but true political unity was very far from having been attained. Aragon and Navarre still preserved their separate Cortes, privileges, and regnal titles; the Basque Provinces continued almost a republic under a Spanish suzerain. In Castile, however, the royal power had been greatly strengthened; the fatal mistake of the *procuradores* in accepting royal pay under Pedro the Cruel ensured the ultimate subserviency

of Cortes. The masterpieces of the great military orders had become the gift of the crown in 1476, and in 1513 Pope Hadrian VI. annexed them permanently to it; the *Hernandades* (q.v.), or ancient associations, first of the bishops, afterwards of civil bodies, for defence of their rights and for the suppression of disorder, became a powerful governmental police; the Inquisition, first employed on a large scale against the Albigenses by the Dominicans in 1248, had been remodelled (1478) to the profit of the crown. But the increased power of the monarchy lay chiefly in the condition of the conquered provinces. Their incorporation was an immense gain to the country, but it gave the king a basis for despotism, and a standing force wherewith he could crush any revolt in the north. The still advancing wave of Mohammedan power was not finally rolled back until the battle of Lepanto (1571) and the raising of the siege of Vienna (1683). The Moors of Barbary were still able to harass Spain and seriously to check her trade; but the most fatal legacy of the Moors was the fact that Spain had won her glory as champion of Christianity against Islam in the peninsula, and continuing this rôle she wasted all her resources, and failed, as champion of Roman Catholicism against Protestantism in Europe.

On the death of Isabella her eldest daughter Juana, who had been married to Philip, son of the Archduke Maximilian, sovereign of the Netherlands, succeeded, jointly with her husband, to Castile. Ferdinand retired to Aragon. Philip died in 1506, and Ferdinand resumed the government of Castile as regent for his daughter, who was incapacitated by insanity. Ten years afterwards he died, leaving all his kingdoms to Juana, with her son Charles as regent. Till the arrival of Charles Spain was really governed by Archbishop Ximenez (q.v.), whose work in the interest of the crown was almost as important in Spain as that of Richelieu later in France; his intolerance to the conquered Moors brought on revolts, and all the subsequent troubles with the Moriscos were the result of the policy which he initiated. For the history of Charles I. as Charles V. Emperor of Germany, and of his action towards the Protestants and his campaigns in Italy and Germany, see CHARLES V. His reign was marked by the triumph of absolutism in Castile. His appointment of Flemings to high offices in Spain, and his exorbitant demands for supplies, led to the rising of the cities of Castile and to the war of the *comuneros*. These were vanquished at Villalar in 1521, and Toledo surrendered soon afterwards. A more popular movement in Valencia was crushed by the nobles of that province. Charles by timely appointments had separated the cause of the nobility from that of the cities; and on the refusal in 1538 of the nobles and clergy to share the burden of taxation these bodies ceased to be summoned to Cortes. The conquest of Tunis in 1535 was a brilliant feat of arms; the attempt on Algiers (1541) utterly failed. The troubles in Germany prevented Charles from following up these campaigns, which might have had results of great benefit to Spain. Worn out by disease, frustrated in all his plans, having failed in the election of his son Philip as emperor, Charles resigned first his hereditary dominions in 1555, and in 1556 abdicated the empire in favour of his brother Ferdinand, and his other crowns in favour of Philip, and retired to the monastery of Yuste, where he died in 1558.

When Philip II. (q.v.) ascended the throne of Spain her dominions were at their greatest. Spain, to which Portugal was added in 1580, Sicily, a great part of Italy, the Low Countries (Holland and Belgium), the whole of North America except

the English and French possessions, the whole of South America after 1580, the Philippine and other islands in the East, and possessions in Africa formed the first empire on which it could be said that the sun never set. Philip had inherited the difficulties and complications of his father's policy without his father's ability. Dull, tenacious, yet irresolute, the type of a conscientious bigot, he lived ruthlessly up to his own ideal. He acted as the champion of orthodoxy in Europe; wherever the faith was in danger there would he protect it. He sacrificed everything to this. And he ruled alone, with no assistant body of councillors, with secretaries only. Well served he was by generals, ambassadors, admirals, by great men in all departments; he had the finest fleets and armies of his age; he never swerved from his purpose; he did not, like his father, retire when baffled, but died working in his life's cause to the end. His return to Spain in 1559 was marked by his presence at the autos de fé at Valladolid and Seville. He failed in his attempts on Tunis and Algiers, but raised the siege of Malta in 1565; he put down the rebellion of the Moriscos in 1568-71, and Don John of Austria gained for him in 1571 the great sea-fight of Lepanto, which stayed the advance of the Turks in the Mediterranean. The action of Philip in introducing the Inquisition (q.v.), popular among the lower classes in Spain, but abhorred elsewhere, the license of the Spanish soldiery, and the stern rule of Alba produced a revolt in Flanders in 1559, which led to the formation of the United Provinces in 1609 (see HOLLAND). The abilities of the regents and generals, especially of the Duke of Parma, who took Antwerp in 1585, gave for a time hope of reconquest; but the loss of the Armada (1588), and the diversion of Parma's forces against France (1590-92), made the contest hopeless. Henceforth Philip's power evidently declined. A quarrel with his secretary, Antonio Perez, led to an outbreak in Aragon and the restriction of its liberties in 1592. His communications and commerce with the colonies and with Flanders were continually threatened by Dutch and English corsairs. Philip had introduced the practice of raising money in Spain without consent of the Cortes, which was no longer regularly summoned. From ignorance of the true principles of political economy the very wealth of Spain hastened her decline. The false colonial policy of the time, with its restrictions and monopolies, gave all the profit of the commerce to contraband trade; the supply of only the precious metals made gold and silver cheaper in Spain than elsewhere and all other commodities dearer. Her rising industries died away. The bullion left her to purchase from foreigners things which she no longer produced and for which she had nothing else to give. Districts cultivated by the Moors became desert, population declined, and both the forces and resources of Spain by sea and land diminished yearly. Philip II. died September 13, 1598, in the palace of the Escorial.

Philip II. had reigned alone; with his son Philip III. began the reign of favourites, which continued with slight intermissions through both Austrian and Bourbon dynasties to the Revolution. The Duke of Lerma was the real sovereign. The ability of Spinola, who recovered Ostend in 1604, and of the captains trained in the school of Flanders upheld the prestige of the Spanish arms for a while; but her power was declining. The expulsion of the Moriscos, an agricultural population, in 1609 weakened her still more. In 1618 Lerma fell from power, but no improvement took place. Philip IV. (1621-65) possessed some taste for literature and art, but was as incapable of governing as his father. In the Thirty Years' War Spain fought

on the side of the emperor, and her soldiers greatly contributed to his success, but she had no share in the profit. The government was in the hands of the Conde-Duke of Olivares, whose ambitious projects and wasteful expenditure introduced corruption everywhere. All offices became venal. The rights of the more independent kingdoms of Spain were violated, bringing about the revolt of Catalonia; the navy was almost destroyed by the Dutch at Dunkirk in 1639; Rousillon was lost in 1642; with the battle of Rocroy (1643) departed the renown of the Spanish infantry, and the military supremacy henceforward belonged to France; Naples and Catalonia rose in revolt in 1648. In 1655 Jamaica was taken by the English. The marriage of the Infanta Maria Teresa to Louis XIV. and the peace of the Pyrenees (1659) assured to that monarch the supremacy in Spain which had formerly been exercised by Philip II. in France. After an inglorious struggle Portugal and all her colonies were lost in 1640. The reign of the childless Charles II. (1665-1700) closed the Austrian dynasty, a period of degradation surpassed only by that of the Bourbon Charles IV. a century later. Spain was considered as a prey to whichever of the great powers of Europe could lay hands on her. A brief war against France in alliance with Holland lost Franche Comté. Spain shared in the great wars of Louis XIV., but whoever else won she was always a sufferer; and the lack of a navy left her commerce and her richest colonies at the mercy of the buccaneers. A first treaty of partition of her dominions was made in 1698, followed by a second in 1700, after the death of the rightful heir, Leopold of Bavaria, in 1699. Contrary to his father's provisions, Charles left the throne to the grandson of Louis XIV. This did not avert the War of Succession (q.v.) and the losses which it occasioned. At the beginning of the 17th century the Spanish armies were the first in the world, her navy was the largest; at its close the latter was annihilated, her army was unable without assistance from Louis XIV. to establish the sovereign of her choice; population had declined from 8 to less than 6 millions, the revenue from 280 to 30 millions; not a single soldier of talent, not a statesman, remained to recall the glories of the age of Charles V. and Philip II.; the whole country grovelled in discontent at the foot of unworthy favourites raised to power by court intrigues, and dependent on a foreign prince.

The first of the Bourbon kings of Spain, Philip V. (q.v.), was proclaimed in Madrid, May 1700. He was accepted by the Cortes of Castile, but not by Aragon or Catalonia. His rival, the Archduke Charles, was supported by all the enemies of Louis XIV. The theatre of the War of Succession included Flanders, Germany, and Italy, as well as France and Spain and their colonies. In Flanders and Germany the English under Marlborough were victorious, but in Spain they fought with less success. Gibraltar was taken by Sir George Rooke in 1704, Valencia and Barcelona were occupied by Peterborough in 1705, and Philip was twice driven from Madrid. But with the aid of Berwick he won the battle of Almansa (1707), and Vendôme defeated Stanhope at Brihuega and Villaviciosa in 1710. The exhaustion of France, and the elevation of the archduke to the empire, led to the treaty of Utrecht in 1712. Catalonia submitted in 1714, and Spain was forced to adhere to the treaty, losing all her Italian possessions, Sardinia, Minorca, Gibraltar, and Flanders.

Philip V.'s first care was to alter the law of Spanish regal succession in accordance with the Salic law of France, a change productive of serious consequences later. Though during the war Philip had shown much spirit, a constitutional melancholy

led him to resign his crown in 1724 to his son Louis, or whose death, after a reign of a few months, Philip resumed power. The entire government was in the hands of his second queen, Isabel Farnese, and her minister Alberoni. Their whole policy was directed to the establishment of her sons in Italy as duke of Parma and king of Naples and Sicily. In this she succeeded, but the gain was simply for the House of Bourbon; it brought no advantage to Spain. To Philip V. succeeded his son Ferdinand VI. (1746-59). His choice of ministers was good, and his avoiding war gave the country an opportunity of internal development. This led to the greater reforms of his half-brother Charles III. (1759-88). He had already been successively duke of Parma and king of Naples and Sicily, and his was the most flourishing of all the Bourbon reigns. He brought with him his Italian ministers, Grimaldi and Esquilache, who made the policy of the early part of his reign too subservient to that of France. Afterwards he gathered round him the most intelligent Spaniards of his day. Superstitiously religious though he was in private life, his reign was yet notable for the expulsion of the Jesuits in 1767, for reasons which have never been clearly explained. The years 1764-66 were marked by reforms in the administration of the colonies, where great abuses existed. Only 840,000 dollars out of a revenue of 4 millions really entered the treasury. These revenues rose shortly from 6 million to 20 million dollars for Mexico alone. His home policy was equally successful: new manufactures were established, roads were improved, more beneficial commercial treaties were made, banks were introduced, and population increased with wealth. Through fear of the movement spreading to her own colonies, Spain wisely remained neutral during the war of independence of the United States. The foreign events of the greatest importance were a fruitless expedition to Algiers in 1775, the recovery of Minorca in 1782, and the fruitless siege and blockade of Gibraltar (1779-82). The great defect of this reign was that nearly all Charles's ministers were *afancesados*; their reforms were based rather on the theories of the French encyclopædists than on the real needs and the principles of liberty still existing in Spain. There was a wide gulf between the educated classes and the body of the nation. Charles IV. (1788-1808) retained for a short time his father's ministers; but they were soon replaced by Godoy, whose unbounded influence over Charles and his queen, limitless greed, and shameless subservience to the French, especially to Napoleon, brought the nation to the verge of ruin. He not only accumulated almost all offices in his own person, but in secret schemes with Napoleon bargained for himself half of Portugal as an independent kingdom, or a hereditary vicerealty in America. On the outbreak of the French Revolution, in spite of ties of blood and of old treaties, Charles IV. was the last to protest against the overthrow of royalty and the execution of Louis XVI. A campaign was then begun on the Pyrenean frontier in 1793, with some success at first, changed to defeat as soon as the Republic could spare forces to turn against her southern neighbour. In 1795 the peace of Basel gained for Godoy his title of Prince of Peace; and the treaty of Ildefonso (1796) bound Spain to an offensive and defensive alliance with France against England. The result was disastrous. In 1797 Jervis won the naval battle of St Vincent; Trinidad was taken, and Cadiz bombarded. But Nelson was repulsed at Teneriffe, Puerto Rico was preserved, and the expeditions of Berezford and White-locke in La Plata eventually failed. The commerce and communications of Spain with her colonies was almost wholly destroyed. A scan-

dalous quarrel between Charles IV. and his son Ferdinand (1807) augmented the hatred of the nation against Godoy. All three parties appealed to Napoleon for his arbitration and intervention. In view of the utter degradation of the crown many of the best men in Spain believed that a short rule by Napoleon might stem the tide of corruption. The royal family and the favourite attempted flight, but this was prevented by a popular outbreak at Aranjuez. Godoy was hurled from power. Charles IV. abdicated in favour of his son, Ferdinand VII., March 17, 1808. French troops entered Madrid. Charles IV., his queen, and son Ferdinand, with Godoy, were summoned to Bayonne. There the crown was renounced by Ferdinand in favour of his father, who in turn ceded it to Napoleon. But on May 2 an unsuccessful outbreak in Madrid had begun the war of liberation, and Napoleon had to face a nation in arms. June 6, Joseph Bonaparte was proclaimed king of Spain. Nominally he reigned till 1813, but the Juntas, the representatives of the nation, acknowledged only the captive Ferdinand VII. For details of the French occupation of Spain, their forcible expulsion by Spanish, Portuguese, and English, see MOORE, WELLINGTON, PENINSULAR WAR, &c. While these operations were going on, the patriots were making great efforts to reform the government, and to give more real liberty to the people. The task was difficult; the absolutist party was still strong, and the liberals were divided; but the Constitution of Cadiz of 1812 is really the commencement of modern Spain. When Ferdinand returned in March 1814, he found the absolutists still powerful enough to enable him to reject the constitution to which he had sworn, to re-establish the Inquisition, and to remove all restrictions to his rule. An insurrection headed by Riego and Quiroga forced him to accept the Constitution from 1820 to 1823, but through the mistakes of the liberals, with the aid of 100,000 French soldiers under the Duc d'Angoulême, he regained his authority, and remained absolute master till his death. In December 1829 the childless Ferdinand married his fourth wife, Christina of Naples. Up to this time his brother, Don Carlos, had been considered heir. In prospect of issue, Ferdinand promulgated (March 31, 1830) the pragmatic law of Charles IV., 1789, restoring the old law of Spanish succession. In September 1832 he revoked this sanction, but again recalled his revocation. Don Carlos was exiled to Portugal. April 4, 1833, Cortes acknowledged Ferdinand's daughter Isabella as heir to the throne, with her mother as regent. Ferdinand died 29th September 1833. During his reign the whole of Spanish continental America was lost (see AMERICA, Vol. I. p. 224, PERU, &c.), and of all the vast colonies there remained only Cuba, Porto Rico, the Philippine, Caroline, and Mariana islands, Fernando Po, the Canaries, and a few ports and towns in Africa and the Straits. The opinion of Europe, which in 1823 had been conservative, and had enabled Ferdinand to regain absolutism by French help, had in 1833-40 become liberal, and this, with English help far more than the skill of her own armies, enabled Christina to vanquish Don Carlos; but her government was far from strong, revolts and *pronunciamientos*, both by liberals and conservatives, were continually occurring. Monks were massacred in Madrid and Catalonia in 1834-35; church property was confiscated. The constitution of 1812, enlarged in 1836, was sworn by Isabella on attaining her majority in 1843. The marriage of the queen to her cousin, Francisco de Assisi, and of her sister to the Duc de Montpensier, only weakened her position. Successive ministries rose or fell from power, all inefficient or corrupt. Narvaez in 1844 showed some energy. O'Donnell

conducted successfully a campaign in Morocco in 1859-60. On the whole, liberalism advanced; republicanism appeared after 1848. In disgust at corrupt administration the country accepted a *pronunciamiento* by Prim and Topete at Cadiz in 1868. Isabella fled to France, and there resigned in favour of her son, Alfonso XII. The programme of the military leaders was simply destructive. A provisional government of two years (the chief event of which was to furnish the pretext for the Franco-German war of 1870) ended in the choice of Amadeus (q.v.) of Savoy as king. In 1873 he resigned the crown. The republic which followed showed the wide differences between the Federalists and the conservative Republicans. This occasioned the second Carlist war, 1872-76 (see CARLISTS). On the waning of their cause, Isabella's son, Alfonso XII., was proclaimed king, 29th December 1874. February 27, 1876, Don Carlos withdrew to France. Mainly through the talents of his minister, Cánovas del Castillo, Alfonso's reign of eleven years (1874-85) was a time of relative prosperity and improvement, and enabled his queen Christina quietly to succeed as regent for his posthumous son, Alfonso XIII., born 17th May 1886. Since then the liberals have returned to power, and changes of ministry are no longer marked by bloodshed or exile. The queen-regent is personally respected; but both Carlists and Republicans still agitate. The constitution embraces all modern liberties. Since the last Carlist war Spain for the first time is under one legal rule; but whether liberal or conservative, the ministries are chosen largely by corruption and intrigue. In Cuba (q.v.) there had been trouble since 1895, intensified by the threatened interference of the United States and by the mysterious blowing-up of the U.S. war-ship *Maine* in Havana harbour on 15th Feb. 1898. In April the United States submitted an ultimatum to Spain, and the two countries drifted into war. Havana was immediately blockaded; but the first serious blow was struck at Manila, where the Spanish fleet was destroyed by the American squadron under Admiral Dewey. In June, Cuba was invaded by the American troops, with the result that Santiago and the whole of the eastern part of the island surrendered, and the squadron of ships under Admiral Cervera was destroyed. Overtures for peace were then made on behalf of Spain, and after negotiations by a joint commission, which met in September at Paris, Spain surrendered Cuba, Porto Rico, and the Philippines, receiving \$20,000,000 for improvements on the latter. The Caroline, Pelew, and Ladrone Islands were sold to Germany in 1899. In January 1899 Spain abolished her Colonial Office as being 'no longer necessary.'

From the *Historia General de España* (30 vols. 1850-66; new ed. 1877 et seq.) to Major Hume's *Spain, its Greatness and Decay*, works on the history of Spain are very numerous. In addition to those named under more special headings (FERDINAND and ISABELLA, CHARLES V., PHILIP II., and the several kingdoms and provinces), we may mention M. M. Siret, *Les Premiers Ages du Metal dans le Sud-Est de l'Espagne* (Antwerp, 1887); Hübnér's *La Arqueología de España* (Barcelona, 1888). In mediæval Spain Schirrmacher's *Geschichte Castiliens, 12 und 13 Jahrh.* (Gotha, 1881), and *Geschichte Spaniens im 14 Jahrh.* (Gotha, 1890), with a volume to follow, will lead up to Prescott's works. The reign of Philip II. has attracted numerous recent writers. Ferrer del Río's *Historia del Reinado de Carlos III. en España* (4 vols.) is good. The *España Sagrada* (51 vols.) is a useful collection, chiefly for ecclesiastical events. The Academy of History in its *Boletín* and *Memorias* has valuable materials. See also Colmeiro's Introduction to the Cortes of Leon and Castile (1883), Cárdenas' work on Property (1873), and the *crónicas* and contemporary writers; also Meyrick, *The Church in Spain* (1892); H. E. Watts, *Spain* ('Nations' series, 1893); Ulrick R. Burke, *A History of Spain* (1895); and the articles ARAGON, NAVARRE, &c.

SPANISH LANGUAGE AND LITERATURE.—Three Romance Languages (q.v.) are still spoken in Spain: the Castilian, generally known as Spanish; the Catalan, a dialect of Provençal; and the Galician, closely allied to Portuguese. Castilian, which has been deservedly called 'the noblest daughter of Latin,' is spoken, with slight local variations, by more than two-thirds of the population. The reason for its having to a great degree supplanted Catalan and Galician is to be found quite as much in political causes as in its own richness of vocabulary and stately measured cadence. Its chief characteristics are the purity of its vowel-sounds and the strong guttural, the origin of which is doubtful, though its introduction is undoubtedly modern. The Castilian vocabulary contains a large number of Arabic words, chiefly connected with agriculture or science; Greek words, mostly of learned and modern introduction; the traces of Basque and Gothic are slight. The influence of French is very noticeable, particularly during the 18th and 19th centuries. Castilian is the form of Spanish spoken in Mexico, Central America, South America (excepting Brazil), Cuba, Puerto Rico, and the other Spanish colonies.

See on the subject generally, Grober, *Grundriss der Romanischen Philologie*; Diez, *Grammaire des Langues Romaines* (Fr. trans.); the admirable article by Alfred Morel Fatio in the *Encyclopædia Britannica*; the Dictionary of the Spanish Academy (1st ed. 1726); the Spanish-English dictionaries by Neumann and Baretti, Velasquez, Garnier. Grammars—Wiggers, *Grammatik der Spanischen Sprache* (Leip. 1884); Knapp, *Spanish Grammar* (Boston, 1887); *Simplified Grammar*, by the present writer (1892). For Catalan, Milá y Fontanals, *Estudios de la Lengua Catalana*. For Galician, Aroe, *Gramática Gallega* (Lugo, 1868).

Castilian Literature.—The earliest existing documents in Spanish belong to the first half of the 12th century. The first monuments of Spanish literature are poetical. The *Poema del Cid* (see CID), ascribed to the latter half of the 12th century, is a typical *chanson de geste*; picturesque and spirited at times, it breathes the spirit of the turbulent age which produced it. Written in unformed and uncouth language, it displays a barbarous and irregular versification. The lines vary in length from twelve to sixteen syllables, and the same rhyme is carried on through long passages. To the 13th century belongs a body of religious poetry of tame character and slight merit. Gonzalo de Berceo is the first Spanish author whose name has come down to us. He wrote rhyming lives of saints and praises of the Virgin, which closely resemble in style, subject, and versification those of other monkish authors of his own and the succeeding century. The 13th century saw the formation of literary Castilian. To this period belongs Alfonso the Wise, king of Castile (see ALFONSO X.), who left behind him a large and valuable body of works written either by himself or at his direction. The most important of these is the code of laws, with digressions on moral and political philosophy, known as *Las Siete Partidas*. This treatise, embodying anterior Gothic codes, has been the groundwork of all subsequent Spanish legislation; it forms also a most important monument of the language, which now for the first time appears as an instrument fitted for literary production. A collection of verse, mostly of a religious character, and undoubtedly belonging to this period, has been long a puzzle to scholars from the circumstance that, appearing as the work of Alfonso the Wise, it is written in the Galician dialect. Alfonso's literary tastes were shared by his nephew, Don Juan Manuel, author of several works of great interest which have come down to us, and of many others now unfortunately lost. He is best known by the *Conde Lucanor* or *Libro de Patronio*, a series of stories mostly of eastern

origin, loosely connected together and with rhymed morals attached. The most original writer of the 14th century is Juan Ruiz, archpriest of Hita, a disreputable cleric, who relates his love adventures in poetical form, interlarding them quaintly with moral fables and religious hymns. In spite of great blemishes and frequently recurring obscene and blasphemous passages, the work is valuable from its vivacity and the excellent picture it gives of one side of life at the time. The verse is still that of the earlier poets, fourteen syllable lines, stanzas of four lines with one rhyme repeated. In prose these early centuries produced little that is worthy of note, as Latin was still much used. By the direction and, probably, under the supervision of Alfonso the Wise, was compiled the *Grande y General Historia*, extending from the creation nearly to his own times. This work was continued by official chroniclers, generally as a bare record of events, down to the time of Ferdinand and Isabella. Pedro Lopez de Ayala wrote the history of the kings under whom he lived in somewhat more picturesque and lively style than his predecessors; his *Rimado de Palacio* is a caricature of the different classes of society of his time, for studying which his high position and many adventures gave him admirable opportunities.

In the 15th century two new and important branches of Spanish literature appear—the Romances of Chivalry (*Libros de Caballerías*) and Ballads (*Romances*). The *Amadis de Gaula* (see *AMADIS*), first and best of books of chivalry, has come down to us in a translation from a Portuguese version, of which the original is lost. It is, however, certain that this is not the earliest form of the story in Spanish. The *Amadis* is not free from the exaggerations and stilted style that deface later books of its class, but, unlike them, it contains passages of great beauty, and, in spite of its being a translation, its language is generally dignified and pure. The popularity of the class was great; but successive authors rivalled one another in wild exaggeration and the frigid impossibility of the adventures of their heroes, who live under social conditions that have never existed, and in a world without geography. The Romance of Chivalry was dying a natural death when Cervantes gave it the *coup de grâce*. The origin of the Spanish ballads is very uncertain: they are probably of indigenous growth, as no striking parallels can be cited to support the theory that they are imitated from the poetry of the Moorish conquerors of Spain. The great mass of them was collected in the 16th and 17th centuries from the mouths of the people, but many of them are of much earlier date. Handed down orally from generation to generation, they underwent considerable modification, and their language alone cannot be taken as a sufficient clue to their date. Their structure is characteristically Spanish; the lines may be considered either as octosyllabic or as of sixteen syllables with *cæsura*; the same *asonante* or vowel-rhyme is continued throughout whole compositions. In subject these ballads range from sacred history to the Arthurian and Carolingian cycles, but the most valuable and interesting are those which celebrate the national heroes and the Moorish champions against whom they fought.

Thus far the works mentioned have been of purely national character or derived from sources common to the writers of the middle ages; but at the court of John II. the influence of Provençal literature began to make itself strongly felt, and a generation of stilted and affected poetasters arose encouraged by the king, who formed one of their number. The works of many authors of this school are collected in the celebrated *Cancionero de Baena*; with the exception of a few religious pieces they

are of slight merit, but they succeeded in enriching Spanish with new lyric metres. At the end of the 15th century appeared the *Tragicomedia de Calisto y Melibea*, better known as the *Celestina*. It is said to be the work of two authors, but the wonderful evenness of its style makes this hard to believe. The *Celestina* partakes of the nature of novel and drama. Written entirely in dialogue, but at the same time immoderately long and unsuited for dramatic representation, it is unique amongst works of its time and country, being perfectly unaffected in style. Taking its subject from a side of life that must have been familiar to its authors, it neither shirks nor courts obscene details, but aims at and thoroughly succeeds in giving a true and animated picture, and at the same time enforcing a moral lesson. It soon became one of the most popular books in Spain, and was translated into most European languages.

It is probable that from Roman times the Drama (q.v.) never became extinct in Spain. It is mentioned in the *Siete Partidas*, and one of the earliest extant pieces of Spanish is a miracle-play, *El Misterio de los Reyes Magos*. The modern Spanish drama, however, must reckon its origin from the end of the 15th century, when Juan del Encina wrote *églogas* or *representaciones* of pastoral character, some of which were undoubtedly acted. Gil Vicente and Torres Naharro imitated and improved upon the methods of Encina, but Lope de Rueda, playwright and actor (fl. 1550), must be considered as the father of the Spanish dramatists, and as such he is mentioned by Cervantes. Continuing the pastoral drama of his predecessors, Rueda also wrote regular plays, divided into acts. In these the influence of the Latin stage is perceptible. The best part of Rueda's work consists of his spirited interludes (*entremeses, loas*) of a popular and burlesque character. Cervantes (q.v.) commenced his career as a dramatic author, but his two earlier pieces, *La Numancia* and *El Trato de Argel*, though finely conceived, were unsuccessful.

With the decay of the popularity of the romances of chivalry is coincident the rise of the novel in its different forms. In the *Diana Enamorada*, Montemayor and Gil Polo directly imitated the Italian. Cervantes and Lope de Vega each produced a novel of the kind, but the false and exaggerated sentiment and inferior verse to which the impossible shepherds generally treat one another in these compositions make it hard to understand the popularity which they undoubtedly enjoyed. Side by side with the pastoral novel, but with stronger growth, thrived the realistic *novela picaresca*, or rogue's story (see *NOVELS*), subsequently brought to perfection by Le Sage, who in his *Gil Blas* drew largely upon his Spanish models. The earliest book of the kind is *Lazarillo de Tormés*, ascribed, apparently without reason, to Diego Hurtado de Mendoza (see *MENDOZA*), a poet and historian of the time of Charles V., at whose court he played a considerable part. *Lazarillo*, the hero, like his brethren of the other books of the class, is a poor boy of shady antecedents, who, by his own ingenuity and unscrupulousness, with varying fortune pushes his way, generally as a servant, amongst all classes of society. So admirable a vehicle for amusement and satire was not neglected, and *Guzmán de Alfarache*, *Marcos de Obregón*, *La Pícarra Justina*, and many others go to prove the popularity of this kind of story. A solitary and not very brilliant example of the historical novel at an early date is the *Guerras de Granada* by Hita.

Some of the older poets, amongst them the Marqués de Santillana, had imitated Italian models, but the influence of Petrarch and his school is most directly felt in Juan Boscán and Garcilaso de la Vega, who flourished in the first half of the 16th

century. The latter in his *églogas* brought hendecasyllables to perfection in Spanish, and left at his early death a small collection of the most beautiful poetry in the language. An imitator of, and at times a translator from, Virgil and Petrarch, he is not unworthy of his models; the harmony of his verse is unsurpassed, unless it be by the *Coplas de Manrique*, probably one of the finest elegies extant.

Lyric poetry reached its culmination in the first half of the 16th century. Most of it is of religious character. In sublimity of conception and perfection of execution Herrera's (see HERRERA) odes and elegies are entitled to a very high place in European literature. Whilst Herrera sang of the victories and reverses of his time, Luis de León drew his inspiration from nature, solitude, and religious meditation. Sweetness of language never deserts him, but his productions are uneven in merit. The brothers Argensola (q.v.) owe their fame rather to good taste than to poetic inspiration. These writers come within the Spanish golden age, during which prose reached its highest development in the religious and mystic writings of Luis de León, Luis de Granada, St Teresa, and Juan de la Cruz, in the histories of Mariana (q.v.) and Solís, and in parts of the writings of Cervantes (see CERVANTES). The *Don Quixote*, with its quaint humour, rollicking fun, melancholy touches, and profound views of human nature, is deservedly, both at home and abroad, the best-known and best-loved book in Spanish. Unique amongst the works of its time, and far superior to the other efforts of its author, it belongs to no class, and has no successor in Spanish or any other literature. Cervantes' other works, the *Galatea*, *Persiles y Segismunda*, *Viage del Parnaso*, dramatic works and novels, are read chiefly on account of the interest which must be felt for the author of *Don Quixote*.

Contemporary with Cervantes was Lope de Vega (see VEGA), the idol of his time, the 'prodigy of nature' (*monstruo de la naturaleza*), as he was called on account of the immense mass and great variety of his writings. Almost every branch of literature was familiar to him. Of dramas alone he wrote over 2000, besides a great body of lyric verse, epic and mock epic, novels both pastoral and of adventures, and criticisms. It is by his dramas that he is best known, and especially by those of cloak and sword (*capa y espada*). These within certain well-defined limits afford considerable scope for variety. The scene is invariably laid in some Spanish town. The principal characters are two lovers, whose adventures and somewhat stilted dialogue are parodied and relieved by those of their servants, one of whom is generally the *gracioso* or buffoon, whose homely pleasantries sometimes jar disagreeably in the midst of fine and solemn passages. The metre of the Spanish drama is generally the same as that of the ballads; some variety, however, both of grouping of rhymes and of metre is admitted. A distinctive feature is the exceeding intricacy of the plots. This characteristic is so marked as to have led several critics to believe that a Spanish drama requires a Spanish audience to follow it intelligently. The great amount of the productions of Lope de Vega precluded all attempt at finish. His verse, however, is always flowing, and he generally attains success by thoroughly carrying out his own maxim that the drama is a purely popular form of literature, and that the only critics to be regarded are the mass of those who pay their money at the theatre-door. Calderón de la Barca (see CALDERON) outlived the golden age of the drama of his country. More philosophic, careful, and with a higher ideal than Lope, he is generally incapable of carrying out his gigantic enterprises, and is,

broadly speaking, a poet of fine passages rather than a dramatic author of high merit. In attempting sublimity he frequently becomes bombastic and misty, and is deeply infected with the bad taste of his time. He perfected the *auto sacramental*, a religious play, or rather a dramatised theological discussion, in which such characters as Conscience, Free-will, Hope, and the cardinal virtues take part. On these, to modern taste, somewhat dull compositions, in which Christian theology is frequently jumbled up with pagan mythology, Calderón lavished a great deal of his best verse, and to them his reputation amongst his contemporaries was largely due. Equal to Lope or Calderón as dramatists, though inferior as poets, are Tirso de Molina (see TELLEZ) and Moreto. The former handled to perfection his native language, and is, more than any other, characteristically a Spaniard of his time. His defects are the want of a high ideal and the frequent coarseness of his language. Outside his own country he is chiefly known as the author who first dramatised the story of Don Juan Tenorio, the *Burlador de Sevilla*, a theme whose impressive nature he well knew how to take advantage of. Moreto is the most correct of Spanish dramatists, and his *Desdén con desdén* merits special mention, even in an age which produced, besides the authors already mentioned, Rojas and Alarcón (q.v.). The number of dramas produced at this time is almost incredible, and some, even of the anonymous ones, are such as in a less fertile age would have sufficed to found a reputation.

Spanish eloquence has always had a tendency to become bombastic; mannerisms and affectation of the worst kind have been mistaken for cultured style; extravagance of metaphor was rife even at the best period (see EUPHUISM); but when literature began to decay all these defects became more marked. The typical representative of this *culto* school is Luis de Góngora (see GONGORA), a poet who enjoyed great popularity in the golden age, and whose example probably did much to hasten a climax which had already become inevitable. In his youth he wrote simply and correctly short lyric pieces of great beauty. It is difficult to believe that this is the same Góngora who, a few years later, produced the *Soledades* and *Polyfemo*, poems so obscure, bombastic, and crammed with *concetti* that before his death they required lengthy commentaries. Amongst those who protested against the tendency of the times, whilst frequently allowing themselves to be carried away by it, was Francisco de Quevedo y Villegas (see QUEVEDO), the bitter satirist and writer of trenchant verse. Extremely versatile, his writings include erotic verse, light lyrics, essays on government, picaresque novels, and theological discussions. In his merits and defects he closely resembles Swift. The best known of his works are his *sueños*, or visions, in which the motives and manners of his time are held up to ridicule with a masterly and unsparing hand.

At the end of the 17th century the sun of Spanish glory set, and with it the sun of Spanish literature, so suddenly and completely as not to leave an afterglow behind it. Of the succeeding century only a few names deserve mention. Padre Isla (q.v.) in *Fray Gerundio* ridiculed the low ebb of education, and particularly of pulpit oratory, with wit and good sense worthy of a better age. Samaniego and Yriarte wrote some clever fables in the style of the inimitable Lafontaine. The Academy, founded during the first half of the 18th century, produced the magnificent dictionary which is its chief claim to the gratitude of scholars. When literature seemed at its lowest ebb, and nothing found favour unless slavishly imitated from

the French, Moratin (q.v.) came to add one more name to the glorious list of dramatists.

The war of independence roused the Spaniards from the seemingly hopeless state of lethargy into which they had sunk. In lyric poetry Quintana and the Duke de Rivas attached themselves to the classical school, whilst the influence of Byron pervades the noble verse of Espronceda, whose successors are Zorrilla, Nuñez de Arce, and Campoamor. Historians, critics, and scholars like Juan Valera, Menendez Pelayo, Pascual de Gayangos, and Cánovas del Castillo worthily carry on the work commenced by Sanchez and Sarmiento. The drama flourishes, though still overshadowed by the French. The novel is, however, the department in which most progress has been made. In the early part of the 19th century Fernán Caballero (q.v.) and Trueba left the old and worn-out track, and drew their inspiration and characters from the people of their own country and age. At the present time Spain possesses novelists worthy to rank with those of any other European country. Juan Valera's *Pepita Jimenez* is one of the best novels of the century. Pereda writes delightfully of his northern mountains. Emilia Pardo Bazán thoroughly understands her own people and time. Names like those of Alarcón, Perez Galdos, and Palacio Valdés have only to be better known to secure their possessors a wide appreciation outside their own country. History is occupied chiefly in the collection of materials, and many valuable monographs have been published. As a historian of his country the name of Modesto Lafuente must not be forgotten. Periodical literature of a not very high order is abundant. Signs of literary activity are visible in South America, but as yet no work worthy of separate mention has appeared.

Catalan Literature.—The intercourse between Catalonia and Provence has been great from the earliest times. The troubadours of Provence carried with them across the Pyrenees their own language as well as their own poetical forms. Their influence may be seen in the works of Raymond Lully, whose poem 'Despair' (*Lo Desconort*) is deeply impregnated with their mannerisms. At the later end of the 14th century a consistory of the *gay saber* was founded at Barcelona in imitation of the one already existing at Toulouse. From this may be dated the partial emancipation of Catalan verse. Two Valencian poets distinguished themselves in their native language. Ausias March, whose songs of love and songs of death are fine in spite of intentional obscurity, and Jaume Roig, whose bitter satire, *The Ladies' Book*, is supposed to contain details of his own life. Roig died in 1478, and at the union of Castile and Aragon Catalan sank to the position of a dialect. In prose the principal monuments of old Catalan are the works of Lully, including the interesting *Book of the Order of Knighthood*; the *Chronicles*, some of which are interesting both in matter and manner, especially that of Ramón Muntaner; and one romance of chivalry entitled *Tirant lo Blanch*, an exaggerated example of the defects of the class. In the 19th century Catalan verse has been revived, probably owing to the jealousy that has always existed between Madrid and Barcelona. This revival is largely owing to Jacinto Verdaguer, some of whose verse in archaic language is really charming and natural. In the Galician, which has never been a literary language, few books exist, with the exception of collections of popular songs.

Bibliography.—Castilian: Nicolas Antonio, *Biblioteca Hispana* (1788); Ticknor, *History of Spanish Literature*, with notes by Pascual de Gayangos (1851). For the earlier period, Amador de los Rios, *Historia Crítica de la Literatura Española*; Von Schack, *Geschichte der Dramatischen Literatur in Spanien*; Ferdinand Wolf,

Studien zur Geschichte der Spanischen und Portugiesischen National-literatur; Menendez y Pelayo, *Historia de las Ideas Esteticas en España* (1885). A good short manual is Sanchez de Castro, *Historia de la Literatura Española* (1890). Catalan: Ballot y Torres, *Gramática de la Lengua Catalana*; Ximeno, *Escritores del Reino de Valencia*; Milá y Fontanals, *De los Trovadores*; Rubió y Ors, *Literatura Catalana*. There are histories of Spanish literature by the present writer (1893) and Fitzmaurice Kelly (1898). For Spanish painting, see Vol. VII. p. 701.

Spalato, or less correctly SPALATRO (Slav. *Split*), the busiest town of Dalmatia, stands on the Adriatic, 160 miles SE. of Fiume. Here in a beautiful situation the Emperor Diocletian built a colossal palace (*Salona Palatium*, whence perhaps Spalato, though more probably from 's palátov'), to which he retired when he abdicated the throne in 305. The palace faced the sea, looking southwards; its walls were from 570 to 700 feet long and 50 to 70 feet high, and enclosed an area of 9½ acres. It stood square like a Roman camp, and had a gate in the middle of each side, and was of the most solid construction. Architecturally it is of the highest interest in that it contains several features that prefigure the architectural styles and devices of modern times. Inside the palace the roads connecting the gates crossed at right angles in the middle, and two of the four courts thus formed were each occupied by a temple (or similar building), one to Æsculapius, the other to Jupiter. So at least says an ancient tradition, though some modern authorities claim the latter, and others the former, as the mausoleum of the emperor. The temple of Jupiter is externally an octagon with a colonnaded peristyle and internally a circle covered by a dome. Where the projecting portico was built there now stands a tower built in the 14th and 15th centuries, thoroughly restored in 1891-92. Since the year 650 this temple has been a Christian cathedral; it contains a magnificent marble pulpit. The interior was extensively restored in the years immediately preceding 1885. The other temple is used as a baptistery; it is of small size and rectangular in shape. All the interior buildings and nearly all the exterior walls of this gigantic palace are still standing in a fairly good state of preservation. But the interior was converted into a town in 639 by the citizens of Salona (q.v.) who escaped the destruction of their town by the Avars, and it has been occupied ever since. The existing city of Spalato lies, more than half of it, outside the palace walls. It contains a museum rich in the remains of Salona, and has a lively trade; the Lasva railway (1895-97) connecting it with Bosnia and the Danubian lands. Its industries embrace the manufacture of liqueurs (rosoglio and maraschino), bricks, ropes, &c. Pop. 14,513. See ROMAN ARCHITECTURE; Freeman's *Historical Essays* (3d series, 1879); and T. G. Jackson's *Dalmatia* (vol. ii. 1887).

Spalding, a Dutch-looking town on the Welland in Lincolnshire, 14 miles SW. of Boston, with a fine church (Decorated and Perpendicular), built in 1284 and restored by Sir G. Scott, who also planned two of the remaining three churches in the town. The grammar-school, of which Bentley was master in 1682, was founded in 1568; new school buildings were erected in 1881. Ayscoughsee Hall, dating originally from 1420, was the residence of the antiquary Maurice Johnson, who helped to found the Society of Antiquaries and the Spalding Gentlemen's Society (1710; resuscitated in 1889). This town had a castle and a monastery prior to the Conquest. The latter eventually became a priory (1051), attached as a cell to Crowland; the ruins of the chapel (1300) at Wykeham (3 miles from Spalding) belonged to a country-house of the

priors. The river is navigable up to this town for vessels of 70 tons. Spalding is an important railway centre, and has an active trade in the agricultural produce of the fertile fens. Pop. (1851) 7627; (1891) 9014. See *Sat. Rev.* (July 22, 1882).

Spalding, JOHN (fl. 1624-45), was the commissary clerk of Aberdeen and diarist, after whom is named a well-known northern Book-club (q.v.).

Spallanzani, LAZARO, naturalist and traveller, was born at Scandiano, in the duchy of Modena, Italy, on 12th January 1729. After studying, at Reggio di Modena and Bologna, natural science, mathematics, the classical tongues, law, and other subjects, he was in 1754 appointed to the chair of Logic, Metaphysics, and Greek at Reggio, and soon afterwards was transferred to Modena. But he took the greatest interest in natural history and physiological questions. Amongst other things his attention was directed to the doctrine of spontaneous generation propounded by Needham and Buffon, which after careful study and experiment he overturned. On the re-establishment of the university of Pavia Spallanzani was appointed (1768) professor of Natural History and keeper of the museum, which he greatly enriched with fishes, crustacea, and testacea, the fruits of his numerous excursions. In 1785-86 he spent nearly a twelvemonth in Turkey engaged in scientific observation, and during the year 1788 visited Naples whilst Vesuvius was in eruption, the Lipari Isles, and Sicily, and wrote an account of his inquiries, *Viaggi alle due Sicilie* (6 vols. 1792). He died of apoplexy, 11th February 1799. In *Dissertationi de Fisica Animale e Vegetale* (2 vols. 1780) he clearly demonstrated the true physiological nature of digestion, and established, on the basis of experiment, the respective functions of the spermatozoa and the ovum in reproduction.

Span, a measure of length, being the distance between the tips of the thumb and little finger when the fingers are expanded to their fullest extent. This space averages about 9 inches, which accordingly is the fixed measure given to the span.

Spandau, a town and first-class fortress of Prussia, is situated at the confluence of the Havel and the Spree, 8 miles by rail W. by N. of Berlin. The principal defence of the capital on that side, it has very strong modern fortifications, including a citadel. In the 'Julius tower' of this structure is preserved in gold the 'Reichskriegschatz' of £6,000,000 that the government, according to a law of 11th November 1871, keep in reserve for a great war. Spandau is the seat of large government cannon-foundries, factories for making gunpowder and other munitions of war, and has an arsenal. Pop. (1875) 27,630; (1890) 44,611, including a garrison of nearly 4000 men. Spandau, one of the oldest towns of Brandenburg, was a favourite residence of the electors. It surrendered to the Swedes in 1634, to the French in 1806, and in 1813 to the Prussians.

Spanheim, FRIEDRICH, theologian, was born at Amberg, January 1, 1600; studied at Heidelberg and Geneva; visited Paris and England; was appointed in 1631 to the chair of Theology at Geneva, in 1641 at Leyden; and died there, April 30, 1648. He contributed to the controversy with Anyraut *Disputatio de gratia universalis* (1644), &c.—**EZECHIEL SPANHEIM**, son of the foregoing, was born at Geneva, 7th December 1629, studied at Leyden, and was appointed professor of Rhetoric there in 1651. He next became tutor to the sons of the Elector Palatine, and with them travelled in Italy and Sicily. In 1665 he represented the Palatinate and Brandenburg as resident in England; in 1680 he went for nine years to Paris as ambassador extraordinary. He took part in the peace of

Ryswick, later went on missions both to Paris and London, and died at the latter, 7th November 1710. He had great learning in the history of ancient law and in numismatics, and his *Dissertationes de usu et præstantia numismatum antiquorum* (best ed. 1706-16) and *Orbis Romanus* (1704) made his name widely known.—**FRIEDRICH SPANHEIM**, his brother, was born at Geneva, May 1, 1632, studied at Leyden, was appointed to the chair of Theology at Heidelberg in 1653, at Leyden in 1670, and died there, May 8, 1701. He defended Calvinism against Descartes and Cocceius. His collected works fill 3 volumes (1701-3).

Spaniel, one of the longest established breeds of dogs. Dr Caius gives a description of the spaniel in his treatise *Of English Dogges* (1576). The working spaniel may be divided into the Clumber, the Sussex, and the Field Spaniel. The clumber derives his name from the estate of the Duke of Newcastle, who originally imported them from the kennel of the Duc de Noailles, and bred them for many years at Clumber Castle (q.v.). The pure breed was guarded with such jealousy that until recent years it was difficult to obtain a pure clumber. Clumbers are usually worked in a team of four or five; as they generally hunt in silence, they are extremely useful in thick cover, the game not being alarmed without cause. In appearance the clumber is a handsome lemon and white dog, short in the leg, long in body, coat like a setter, a massive head with large drooping ears.

The Sussex is also a variety of long standing, though the pure breed was only resuscitated in 1870 with great difficulty. In colour the Sussex should be a 'golden-liver' or brown, otherwise it closely resembles the clumber.

The Black Spaniel is gradually becoming the commonest, as it is certainly the handsomest variety of field spaniel; it is bred mainly from Sussex blood. The 'cocker' and the 'springer' are names indiscriminately applied to field spaniels of unknown breeding; they are generally liver and white, and are probably cross-bred Sussex.

Though there are records of the existence of an English water-spaniel, yet the breed has been entirely eclipsed by the Irish water-spaniel, a variety maintained in purity through the efforts of the late Mr Justin M'Carthy. The Irish dog resembles a large poodle in face and size, an untrimmed coat curling all over the body; in colour it should be a reddish liver.

Toy Spaniels, though identical in name, have little in common with the working spaniel. They are divided into the black-and-tan King Charles, first brought into notice by Charles II., and the red and white Blenheim, established by the Duke of Marlborough. The toy spaniel should not weigh more than 10 lb., and should have a short turned-up face like a pug-dog. From their long coats and small size these dogs are only fitted for pets, but are bright and cheery in disposition.

Spanish Fly. See CANTHARIS.

Spanish Legion. See EVANS (DE LACY).

Spanish Main (i.e. *main-land*), a name given to the north coast of South America from the Orinoco to Darien, and to the shores of the former Central American provinces of Spain contiguous to the Caribbean Sea. The name, however, is often used of the Caribbean Sea itself, especially in connection with the Buccaneers (q.v.). See Rodway, *The West Indies and the Spanish Main* (1896).

Spanish Marriages. See GUIZOT.—**SPANISH SUCCESSION.** See SUCCESSION WARS.—**SPANISH TOWN.** See JAMAICA.

Spar (Ger. *Späth*), a miners' term for any bright crystalline mineral, used in books for certain minerals

—calcareous spar, Fluor Spar (q. v.), &c.—in which, however, it has no proper generic significance.

Sparks, JARED, American historian, was born at Willington, Connecticut, May 10, 1789, graduated at Harvard University in 1815, and became tutor in mathematics and natural philosophy there, and one of the conductors of the *North American Review*. In 1819 he was settled as a Unitarian minister at Baltimore, where he wrote *Letters on the Ministry, Ritual, and Doctrines of the Protestant Episcopal Church*. In 1821-23 he edited the *Unitarian Miscellany*, in which he first published his *Letters on the Comparative Moral Tendency of Trinitarian and Unitarian Doctrines*. In 1821 he was chosen chaplain to congress, but two years later he abandoned preaching owing to ill-health, and for seven years was proprietor and editor of the *North American Review*. In 1828 he published a *Life of John Ledyard*, and from 1834 to 1837 edited at Boston 12 volumes of the *Writings of George Washington*. This important national work was followed by the *Diplomatic Correspondence of the American Revolution* (12 vols. 1829-30), and the *Life of Gouverneur Morris* (3 vols. 1832). At this period he commenced the *American Almanac*, and began also his *Library of American Biography*, first issued in two series of 10 and 15 vols. In 1836-40 was published his collection of the *Works of Benjamin Franklin* (10 vols.), and in 1853 his *Correspondence of the American Revolution* (3 vols.). Besides these multifarious literary labours, combining laborious research with clear arrangement, a simple style, and accurate statement, he was from 1839 to 1849 McLean professor of History at Harvard, and from 1849 to 1853 president of the college. He died March 14, 1866. See memoirs by Brantz Mayer (1867), G. E. Ellis (1869), and H. B. Adams (1892).

Sparling. See SMELT.

Sparrow (*Passer* or *Pyrgita*), a genus of birds of the family Fringillidæ, having a strong conical bill, the upper mandible slightly curved, the lower mandible compressed and shorter than the upper, the nostrils partly concealed by the short feathers at the base of the bill, the legs moderately long and stout, the claws sharp and curved, the tail moderately long, and nearly even at the tip. The species are not very numerous, and are exclusively found in the Old World. The Common Sparrow, or House-sparrow (*P. domesticus*), is plentiful almost everywhere in the British Islands, its distribution following cultivation even to the Outer Hebrides. It is found also throughout Europe as far as to the Arctic Circle, but not in the Faroes, abounding particularly in the northern countries, from which its range extends eastwards into Siberia, and southwards in Africa to Lake Albert Nyanza, Morocco, and Madeira. A paler variety is found in Siam, Burma, and the Indian region as far west as southern Persia. Of all British birds the sparrow is the boldest in its approaches to man, and it is too well known to require description. Town sparrows are not mere visitors from the neighbouring country, but constant inhabitants of the town itself, with the smoke of which their plumage is begrimed. The sparrow in its best plumage is not a very beautiful bird, nor so elegant in form as many others of the finch tribe; it has no melodious song, but its habits are interesting, and its frequent lively chirp is pleasing. Sparrows often congregate in great flocks, particularly in autumn. The sparrow is one of the most omnivorous of birds, devouring animal and vegetable food indiscriminately, and eating vast numbers of insects and their larvæ during summer. Their depredations on crops have induced many farmers to use means for their destruction. They are good

to eat, though little used for this purpose in Britain. It is otherwise in France, where all the small birds are sought after as articles of food. But the destruction of sparrows may be carried too far; and in France it has been followed by an increase of caterpillars, vastly more injurious to crops than the sparrows themselves. Since the young are fed upon caterpillars and insect larvæ, the killing of the fledged young has been recommended as the best method of taking advantage of the usefulness of the sparrow and at the same time checking its autumn ravages among the grain. The sparrow makes a very inartificial nest, collecting a quantity of hay or some similar material, in a hole of a wall, and lining it with feathers; sometimes, but more rarely, building a rude dome-shaped nest in the higher branches of a tree. Apart from the habitations of man, which it so much frequents, it often builds in crevices of rocks, or in cliffs on the seacoast, or under the shelter of the nests of rooks, one rook's nest sometimes covering several nests of sparrows. Several broods are produced in succession, and the breeding season is prolonged over the whole summer, one brood succeeding another. In summer the plumage of the sparrow is more brilliant than in winter, and the female is of more sober plumage than the male, exhibiting indeed almost no variety of colour. In Italy a species, *P. italia*, is found; and in Sardinia, Sicily, and Malta another species, *P. hispaniolus*, occurs, which in Spain breeds in the woods, while the common sparrow keeps to the towns. About 1862 the house-sparrow was introduced into the United States, and it has also been acclimatised in Australia and New Zealand, in all which places it has become a great pest. The Tree-sparrow (*P. montanus*), the only other British species, is very similar to the common sparrow, but of rather smaller size; rarer and more local, but extending in its range, being found in the Hebrides and St Kilda, very sparingly in the south-west of England, and resident in Ireland near Dublin. It is multiplying in the Faroes, and extends beyond the Arctic Circle. It is more abundant in some parts of Europe than the house-sparrow. It visits Egypt and Arabia, and is found in the south of Asia as far as the Philippine Islands and the Malay Peninsula. In Java a variety has developed (*P. malaccensis*). The White-throated Sparrow (*Zonotrichia albicollis*), an American form, is really a bunting. It has been found in the east of Scotland and the south of England. Other American sparrows have little in common with the genus *Passer*. The nostrils are in a small groove, and the tail is slightly forked.—The Hedge-sparrow (see WARBLE) is a bird belonging to an entirely different group; and the name sparrow is loosely given to various different birds in various parts of the world. For accounts of the destructiveness of the sparrow, see *The House Sparrow*, by J. H. Gurney, Russell, and Cones, and Miss Ormerod's Reports.

Sparrow-hawk (*Accipiter*), a genus of long-legged, short-winged falcons, nearly allied to and closely resembling the goshawks, but distinguished from them by their smaller size, weaker bill, and long, slender middle toe. The genus is represented in almost all parts of the world. The Common Sparrow-hawk (*A. nisus*), notwithstanding the constant war waged against it by gamekeepers, is still comparatively abundant in wooded districts throughout Great Britain and Ireland. It nests in trees, sometimes building a nest of its own, sometimes adopting one deserted by a crow or other bird. The eggs, four to six in number, are laid early in May, and are of a bluish-white colour marked with reddish brown. The food of the sparrow-hawk ordinarily consists of small birds, which it takes while on the wing, but when rearing

its brood it often commits great havoc among young game-birds and poultry. The adult male measures 12 inches, and has the upper parts of the body bluish gray, the under parts buff-coloured, with bright rufous bars. The female is paler in colouring and measures about 15 inches. The sparrow-hawk was used in falconry, but its feebler



Common Sparrow-hawk (*Accipiter nisus*).

powers of flight made it of less value than the true falcons. It is bold and active, however, and is still often trained to take partridges and small birds; and it is recorded that a single trained sparrow-hawk took 327 birds in less than two months. The American Sparrow-hawk (*Falco sparverius*) is similar in size to the European, but is more nearly allied to the kestrel.

Sparta, anciently LACEDÆMON, the capital of Laconia, and the most famous city of the Peloponnesus, situated on the right bank of the Eurotas, about 20 miles from the sea, in a plain shut in by mountains, of which that on the west side, Mount Taygetus, rises to a height of 8000 feet. The natural defences of the valley of Lacedæmon were so great that it continued unfortified down to the Macedonian period, and indeed was not regularly fortified till the time of the tyrant Nabis (195 B.C.). Previous to the Dorian conquest the primitive Achæans of Sparta seem to have dwelt in four or five scattered hamlets. These in course of time were grouped into one city by the conquerors, and became known as town-districts. Sparta had no striking public buildings—its Acropolis was merely a steep hill in the northern part of the city, crowned with the temple of Athena *Polinchos* or *Chalciecus*. Here, as in all Dorian states, were found the three classes—*Helots*, or slaves; *Perioikoi*, a subject class of freemen without political rights; and the *Spartiates*, or the governing class of pure Dorian blood. The foundation of Spartan greatness was attributed to the legislation of Lycurgus (q. v.), and it is at any rate true that there survived a very ancient legal code, consisting of *πῦραι* ('compact'), supposed to have the special sanction of the Delphic oracle. At the head of the government stood two *kings*, one of the family of the Agidæ, the other of the family of the Eurypontidæ, their royalty hereditary in the main line, but limited to sons born while the father was actually king. Their powers were equal, and they were originally priests as well as judges and generals. After 506 B.C. only one king at once might take the field, and his powers came to be

much curtailed by the growing power of the Ephors. These were five in number, elected annually by the people—the first giving his name to the year. Two accompanied the king on campaign, advising the three at home by the *συντάλαι*, or secret despatches. They received foreign ambassadors, imposed taxes, and judged in all matters except those which specially belonged to the kings as priests. The standing council of kings and ephors was the *Gerousia*, consisting of twenty-eight Spartans above sixty, and elected from the chief families by the people. Once a month was held the *apella*, or assembly of all Spartans above thirty, who might vote but could not speak, which only the king, ephors, and members of the *gerousia* had the right to do. The Spartans never ceased to look upon themselves as merely a military garrison, and all their discipline pointed to war. No deformed child was allowed to be brought up; boys began to be drilled at seven, entered the ranks at twenty, and thereafter had to dine every day in one of the military messes (*ἀνδρεία* or *φιδίτια*) in tents pitched in the public street. From twenty till sixty all Spartans were obliged to serve as Hoplites. In the 5th century the army was divided into twelve *lochoi*, commanded by *lochagoi*. Each *lochos* consisted of 500 men. After the Peloponnesian war the army was rearranged in six *morai*, each under a *polemarchos*. They never were strong at sea, although at Salamis they had ten ships, and under Lysander defeated the Athenian fleet and so ended the Peloponnesian war.

The earliest struggles of Sparta were with Messenia and Argos. The Messenian war terminated (668 B.C.) in the complete overthrow of the Dorians of Messenia, who were reduced by the victorious Spartans to the condition of *Periæci*. Similar struggles occurred both with the older Achæan inhabitants in the centre of Peloponnesus and with the Dorians of Argos, &c., in which the Spartans were generally successful. Under their stern discipline the Spartans became a race of resolute, rude, and narrow-minded warriors, capable of a momentary self-sacrificing patriotism, as in the story of the 300 heroes who fell at Thermopylæ, but utterly destitute of the capacity for adopting or appreciating a permanently noble and wise policy. The outbreak of the Peloponnesian war (431 B.C.) brought the rivalry between Sparta and Athens to a head, and in the mighty struggle that ensued victory declared on the side of the combatant least capable of maintaining the greatness of Greece. Sparta now attained the hegemony of Greece; but her insolent tyranny in the hour of her triumph excited the indignation of those whom she held in virtual subjugation, and the glorious retaliations of the Thebans under Epaminondas stripped her of all her splendid acquisitions, and reduced the Laconian state to its primitive boundaries. Later the rise of the Macedonian power limited still more the Spartan territory, nor did it ever after attain its earlier dimensions. After a series of vicissitudes Sparta passed into the hands of the Romans, became a portion of the Roman province of Achaia, and finally shared the fortunes of the rest of Greece (q. v.). The growth of the town of Misthra, 2 miles S.W. of Sparta, in the 14th and 15th centuries, led to the total desertion of the more ancient city; but the modern town of *Sparti* (pop. 5000), which was founded by the Greek government in 1836, occupies part of the site of old Sparta, and is again capital of the province of Laconia.

Spartacus, leader of the Roman slaves in the great revolt which broke out about 73 B.C., was a Thracian by birth, and from a shepherd had become a leader of a band of robbers when he was

captured and sold to a trainer of gladiators at Capua. He formed a conspiracy to escape, and, when it was discovered, broke out with some seventy followers, with whom he made for the crater of Vesuvius, where hordes of runaway slaves soon joined him. He first overpowered and seized the arms of a force sent against him from Capua, next routed an army of 3000 men under C. Clodius, and so passed from victory to victory, overrunning Southern Italy and sacking many of the cities of Campania, his numbers growing to forty, seventy, and even a hundred, thousand men. Great part of Central and Southern Italy had been thrown into pasture-land, on which the flocks belonging to rich absentee nobles were tended by gangs of discontented slaves, who flocked eagerly to the standard of revolt. Spartacus, who failed to get support from the Italian communities, and from the first knew the real weakness of his position, strove to persuade his victorious bands to march northwards to the Alps and disperse to their native regions; but they were intoxicated with victory, and saw glittering before their eyes all the plunder of Italy. Against his better judgment he continued the war, showing himself a consummate captain in the strategy and valour with which he routed one Roman consular army after another, and the policy by which for long he assuaged the jealousies and dissensions amongst his followers. At length in 71 M. Licinius Crassus received the command, and after some time of cautious delay forced Spartacus into the narrow peninsula of Rhegium, from which, however, he burst out through the Roman lines with a portion of his force. Crassus, in despair, urged the senate to recall Lucullus from Asia and Pompey from Spain, but meantime he himself pursued active hostilities against the dreaded enemy. Spartacus finding all hope at an end made a dash on Brundisium, hoping to seize the shipping and get across the Adriatic, but was foiled by the presence of Lucullus, whereupon he fell back upon the river Silarus, and there made a heroic stand against Crassus until he was cut down.

Spartanburg, capital of Spartanburg county, South Carolina, 93 miles by rail NNW. of Columbia. Bricks and carriages are manufactured; and here are boys' and girls' high schools and the Wofford (Methodist; 1853) College. Pop. (1890) 5544.

Spasm (Gr. *spasma*) consists in an irregular and violent contraction of muscular parts—involuntary even when the voluntary muscles are concerned. There are two sorts of spasm. In one there is an unusually prolonged and strong muscular contraction, not rapidly alternating as usual with relaxation, the relaxation only taking place slowly, and after some time. This is known as *tonic spasm* (Gr. *tonos*, 'a bracing up') or *Cramp* (q.v.). When in a more moderate degree affecting the voluntary muscles generally it constitutes *Catalepsy* (q.v.), in which, from the muscles remaining contracted, the limbs will retain whatsoever attitude they are placed in, until the spasm is over. But the extreme example is *Tetanus* (q.v.), in which the spasms are so violent and so enduring that they may be said to squeeze the patient to death. In the other form of spasm the contractions of the affected muscles take place repeatedly, forcibly, and in quick succession; the relaxations being, of course, equally sudden and frequent. This is named *clonic spasm* (Gr. *klonos*, 'an agitation'), and is popularly known as *convulsions*. The spasmodic twitchings which sometimes occur in the muscles that close the eyelids (*orbicularis palpebrarum*) are familiar to almost everybody, and are an example of clonic spasm on a very small scale. Epilepsy and convulsive hysteria afford the best examples of this kind of spasm. Chorea (q.v.), or *St. Vitus's*

dance, is an allied but less regular and characteristic form.

The treatment varies according to the cause of the excessive muscular irritability. Firm pressure on muscles affected with spasm will promote their relaxation, and by strong steady pressure on the masseter muscles the lower jaw has been depressed, so as to open the mouth, in cases of lock-jaw. The medicines which are employed to counteract irregular or inordinate muscular action are termed *anti-spasmodics*; but spasm may depend upon so many different causes that the remedies which are found most successful in combating it must vary extremely in their nature. There are, however, a few medicines which appear to exercise a control over spasmodic action generally. These may be termed *pure or true antispasmodics*. They are Asafoetida, *Cotyledon umbilicus* (or Common Navel-wort), Wood-soot, Galbanum, Musk, Rue, Sagapenum, Sumbul (*Jatamansi* or Musk Root), and Valerian and the Bromides. Amongst the narcotics often useful in these affections we may especially mention *Belladonna*, *Cannabis Indica* (or Indian hemp), Chloral, Opium, and Stramonium. Sulphuric ether in draught or inhaled, and inhaled chloroform, are often of service. In some cases, remedies which directly depress the vital powers, such as the prolonged use of the warm bath, or even, in rare cases, the abstraction of blood, are the most effectual means of subduing spasm.

Spasmodic School, a name applied to a group of English poets about the middle of the 19th century, among whom were Philip James Bailey, Sydney Dobell, and Alexander Smith. The name implied an overstrained and unnatural method of sentiment and expression, which sometimes grew out of sheer affectation and not seldom sank hopelessly into bathos. Professor Aytoun's *Firmilian* (1854) was an excellent burlesque of the high-strung and grandiose style of these poets who took themselves much too seriously, and were for a moment also taken at their own valuation by the world.

Spathe (*Spatha*), in Botany, a sheathing bract which encloses one or more flowers, as in the *Narcissus*. Very frequently the flowers within a spathe are arranged upon a *spadix*, which is a succulent spike, with numerous flowers, and of which a familiar example may be seen in *Arum maculatum*. The spadix is a characteristic feature of the Palms, and in them is compound or branching, and in general is provided not only with a common spathe, but with secondary spathes at its divisions.

Spathic Iron Ore. See IRON, Vol. VI. p. 216.

Spavin, a disease of horses, occurs under two different forms, both interfering with soundness. In young, weakly, or overworked subjects the hock-joint is sometimes distended with dark-coloured thickened synovia or joint-oil. This is bog spavin. Fomentations, occasional friction, a laxative diet, and rest should be diligently tried; and if such remedies prove unsuccessful the swelling must be dressed with strong blistering ointment or fired. The second variety of spavin is the more common. Towards the inside of the hock, at the head of the shank-bone, or between some of the small bones of the hock, a bony enlargement may be seen and felt. This is bone spavin. At first there is tenderness, heat, swelling, and considerable lameness; but as the inflammation in the bone and its investing membrane abates the lameness may entirely disappear, or a slight stiffness may remain. In recent and slight cases cold water should be applied continuously; but in serious cases, when the part is swollen and tender, hot fomentations are best. For several days they must be perseveringly employed. When

the part is again cool and free from pain an iodide of mercury or fly-blister should be applied, and the animal treated to three months' rest in a small paddock, the end of a barn, or a roomy loose-box. In persistent cases firing or setoning usually gives much relief.

Speaker. See PARLIAMENT, Vol. VII. p. 774.

Speaking-trumpet, an instrument for enabling the sound of the human voice to be conveyed to a greater distance. It is of the utmost use on shipboard in enabling the officers to convey orders during windy weather from one part of the deck to another, or to the rigging. The invention is ascribed to Sir Samuel Morland, in 1670, though Athanasius Kircher laid claim to it. Morland's trumpet was of the same form as that now in use—viz. a truncated cone, with an outward curve or lip at the opening. The theory of the action of this instrument is much the same as that of the sounding-board of a musical instrument, but the sounding-board is aerial instead of solid. The air immediately in front of the instrument is acted upon over so wide a surface that it cannot effectively evade compression and rarefaction by any process of overflow and inflow towards the sides, and the result is as if the air were well laid hold of and firmly set in vibration.

Spear, a weapon of offence, consisting of a wooden shaft or pole varying in length up to 8 or 9 feet, and provided with a sharp piercing point. The spear may be regarded as the prototype of the various forms of piercing weapons, such as the arrow, bolt, and dart, which are projected from bows, catapults, or other engines, and the javelin, assegai, and lance, held in or thrown by the hand. The longer and heavier spears and lances are mainly retained in the hand while in use, but there is no absolute distinction, and the throwing of a spear has in all ages been a form of offensive warfare. There can be no doubt that a weapon such as the spear is the most ancient, as well as the most universal, of warlike and hunting weapons. In its earliest form the spear would naturally consist of a simple pole of tough wood sharpened to a point at one extremity, which point might be both formed and hardened by charring in fire. From this an improvement would consist in fitting to the shaft a separate spear-head of bone, as is still practised amongst primitive races. No trace of these early spears remains to us, but of the more developed forms having heads of chipped flint or other hard stones examples are plentiful, and most ingenious methods of fixing such heads are yet practised by South Sea tribes, who carve, paint, and otherwise ornament their spears in an elaborate manner. To flint-heads succeeded heads of bronze (see Vol. II. p. 478), but these came only late in the bronze period, and were still in use when the Homeric poems were composed. The bronze spear-heads found in Great Britain and in northern Europe generally were cast with sockets, into which the end of the shaft was inserted, but on the eastern Mediterranean coasts tanged spear-heads were used. These spear-heads were various in form and size, some being three-edged like the old bayonet, others with expanded leaf-shaped blades, some barbed, and some having loopholes either in socket or blade by which they were lashed to the shaft. The war-lance of the mediæval knights was 16 feet long; the weapon of modern cavalry regiments known as lancers may be from 8½ to 11 feet long, usually adorned with a small flag near the head. The Persians at the present day forge spear-heads, for ornamental purposes only, with two and sometimes three prongs. The modern spears of savage tribes, used equally for hunting and for warlike purposes, are frequently

barbed with fish and other bones, and their fighting-spears have sometimes poisoned tips. Among the South Sea Islanders a fishing-spear having several slender barbed points is an important weapon. Among civilised communities the hunting-spear continues to be used for following the wild boar and other large game. See also PIKE, HALBERT, TRIDENT.

Spearmint. See MINT.

Spearwort. See RANUNCULUS.

Special License. See MARRIAGE, p. 58.

Specialty Debts. See DEBT, p. 716.

Species. This is a term which it is very difficult to define with precision. The word itself means a look, an appearance, a kind; and in common usage things that look the same are said to be of the same species. With more definiteness naturalists speak of a mineral species, and of a species of plants or animals. It is with this last usage that we are here concerned.

In classifying plants or animals we form conceptions of various degrees of comprehensiveness (see BIOLOGY), and for these we use a series of terms, such as class, order, family, genus, species, variety. The need for precision is that every one may know exactly what is meant when any individual or group of individuals is named. In the ordinary system of classification a species is a group of individuals which closely resemble one another, and the species is usually subordinated to a genus—a wider group of similar, but less closely similar, forms—and is superior to a variety, of which there may be several in a species. Thus we group the lions as a species (*Felis leo*) of the genus *Felis*, in the family Felidae, order Carnivora, class Mammalia, and call the tigers, leopards, cats, and the like other species of the same genus *Felis*. As no one could confuse lion, tiger, and leopard, for the peculiarities of each are well marked, it may be wondered what difficulty there is in defining species.

Let us consider the matter practically. We observe our fellow-men; we see that they differ in many ways from one another, in stature, in features, in complexion, in colour of eyes and hair, and so on; but we do not think of speaking of a red-haired or a blue-eyed species of man. We should as soon think of saying that the red-haired or blue-eyed child in a family was of a different species from its brothers and sisters or from its parents, which would be absurd. We at once agree with the systematist when he says that the term species should not be given to a group of individuals which are distinguished from other groups by no greater differences than distinguish members of a family, and when he says that the characters of a species must have some constancy from generation to generation, which is not of course the case with red hair or blue eyes. This is a common-sense way of limiting the term, but it leaves many difficulties untouched. It is not readily applied to extinct species, of whose generations and individual variations we cannot know much; nor has it been applied to a vast number of forms recorded as species sometimes on the strength of single specimens, and often without any knowledge of their generations.

But, again, we observe men with much greater peculiarities than red hair or blue eyes; we contrast Britons and Chinamen, Lapps and Negroes, and we wonder if these really belong to the same species. Here, however, the systematist reminds us that the members of a species are fertile *inter se*, which cannot be denied of the different races of mankind. But a little knowledge is enough to keep us from attaching very much weight to this distinction, since both among plants and animals

there are many cases of fertile hybrids between different species. We can no longer talk as if the mule were the only known hybrid. See HYBRID.

Or if we turn to the systematic treatises which classify plants and animals, and compare half a dozen of them, we find ample evidence of the elasticity of the conception of species. *Quot homines tot sententiae*. Thus, as Haeckel notices, one botanist enumerates 300 German species of the common Composite, Hieracium; another reduces them to 106, another to 52, another to about a score! Bechstein said that there were 367 species of birds in Germany, but according to Reichenbach there are 379, according to Meyer and Wolf 406, according to Pastor Brehm 900! But Haeckel himself supplies the best example, for in his important monograph on Calcareous Sponges he admits that as the naturalist likes to look at the problem there are 3 species, or 21, or 289, or 591! We are told that species are groups of individuals agreeing in essential characters which remain constant from generation to generation. But what are essential characters? and how much constancy is demonstrable?

We cannot forget, for instance, how one species may include forms so very different as Shetland pony, hunter, and dray horse; or as poodle, bulldog, and greyhound; or as carrier, pouter, and fantail; or as cabbage, cauliflower, and Brussels sprouts. Yet it is probable that in each of these four groups the diverse forms have been derived from the same ancestral wild species, and in each case the diverse forms are connected by intermediate stages.

In short, the fact is that there is no such thing as species. Individuals are real; but a species is a subjective conception. It is based on structural resemblances between individuals, and the degree of importance attached to these depends, as we have seen, on the mind of the observer, or is, in other words, entirely relative.

But while there can be no perfectly strict definition of a species in terms of morphology, it may be asked, where is there a possible one in terms of physiology, in terms of functional peculiarities about which there can be no dispute? At one time it almost seemed that there might be some solution in terms of fertility and infertility. But, although this distinction is certainly helpful and very important, it also breaks down. It is not of course doubtful that species have physiological peculiarities; lions differ from tigers in habit and chemical composition as well as in form and structure; but every individual has also its peculiarities—chemical as well as personal; the difficulty is to decide when these peculiarities are important enough to make it useful to give a precise name to their possessors.

As to the practical question of determining species it should be borne in mind that the differences between one form and another are often very marked, and that the gap between related forms is not always bridged by any unbroken series. The New Zealand lizards (*Hatteria punctata*) not only form a species, but are the sole living representatives of an order, or of a class; and the same may be said of the lancelet and other forms. It is with those organisms of which there are very many more or less different forms that there is real difficulty—with Bacteria, Algae, Protozoa, Sponges, Crustaceans, Insects, Fishes, Birds, and so on. In such cases the naturalist who admits that species is but a relative conception, and who, as an evolutionist, recognises the variability of species and the links of relationship which bind form to form, cannot do more than try to make sure that the peculiarities on account of which he gives a new name to any group of creatures are greater than those

which distinguish the members of a family of these, are relatively constant from generation to generation, and are associated with reproductive variations which tend to restrict the range of mutual fertility to the members of the proposed new species. Unfortunately, however, species often are and sometimes must be established for single specimens, without any knowledge of their reproduction and generations, without any statistics of their variations, or careful comparison of these with those of related forms. Where the form in question is conspicuously unique the erection of a new species is of course readily justified.

History.—The history of the biological conception of species can be rapidly sketched. We need not go farther back than John Ray (1628–1705), who gave to the term species that meaning which it bore until evolutionary conceptions prevailed. Linnæus adopted the usage defined by Ray, and by introducing the 'binomial nomenclature' made it more serviceable. He believed in real species, and said: 'Species tot sunt diversæ, quot diversas formas ab initio creavit infinitum ens,' though some hesitancy in regard to this is shown when he elsewhere expresses the idea that all the species of a genus *ab initio unam constituerunt speciem*. Although Lamarck in 1809 declared species to be artificial conceptions, the Linnæan idea prevailed—even in Agassiz' *Essay on Classification* (1859)—until Darwin and his fellow-workers modified this among many other conceptions by establishing the doctrine of evolution, 'by which,' as Ray Lankester says, 'universal opinion has been brought to the position that species, as well as genera, orders, and classes, are the subjective expressions of a vast ramifying pedigree in which the only objective existences are individuals.'

See BIOLOGY, BOTANY, DARWINIAN THEORY, EVOLUTION, GENUS, VARIATION, ZOOLOGY. See also Darwin, *Origin of Species* (1859); Haeckel, *Generelle Morphologie* (1866); *Natürliche Schöpfungsgeschichte* (1868; 8th ed. 1889; trans. *Natural History of Creation*, Lond. 1879); *Die Kalkschwämme* (1872); Spencer, *Principles of Biology* (1864–66); Wallace, *Darwinism* (1889).—The species of Logic is originally suggested by Natural Species, and may be defined as a group of individuals agreeing in some common character and known by a common name; two or more species constituting a genus. The relation of species to the other logical elements of classification are treated at PREDICABLES and GENERALISATION. The great controversies as to the real existences of species and other universals are sketched at NOMINALISM.

Specific Density, the mass of any given substance contained in unit volume. On the centimetre-gramme-second system of physical units, since a cubic centimetre of water at standard temperature and pressure weighs 1 gramme, the density of water = 1, and water is the standard of density; and the specific density of a body is the number of grammes' mass per cubic centimetre. Since, according to the law of gravity, weights are proportional to masses, it is convenient to ascertain specific densities by ascertaining the specific gravities of the substances tested. For example, an English gallon of water weighs at standard temperature and pressure (62° F. and barometer 30 inches) 10 lb. avoirdupois; a gallon of ether weighs 7.2 lb.; the specific density of ether is therefore $7.2 \div 10 = 0.72$. Similarly, a gallon of strong sulphuric acid weighs 18.4 lb., and the specific density of sulphuric acid is 1.84. The specific densities of solids may be determined by the hydrostatic balance (see ARCHIMEDES, PRINCIPLE OF), which gives the weight of a quantity of water equal to that of the solid; or by using a 'specific gravity flask.' This is a flask marked distinctively at a certain level; the solid is put into this; the flask is filled with water up to the

mark, and weighed; the whole is then emptied and filled with water alone up to the mark, and again weighed. The two weighings give the data for ascertaining the ratio between the weight of the solid and that of an equal bulk of water. If the solid is acted upon by water, some other liquid of known specific density must be employed, and the calculation varied accordingly. If it be lighter than water, it is coupled with a piece of heavy substance whose weight and specific density are separately known, and the aggregate apparent loss of weight incurred by the combination on being immersed in liquid is found by the hydrostatic balance. Of this aggregate so much is due to the heavy substance and the remainder to the light solid. This gives data for calculating the specific density of the light solid. The specific density of a liquid is ascertained by simply comparing the weights of quantities of that liquid and of water successively made to fill the specific gravity flask up to the same marked level; or by comparing the apparent losses of weight incurred by a solid on being immersed in water and in the liquid respectively; or by the use of hydrometers or areometers. The areometer (*araios*, 'thin,' and *metreō*, 'I measure;' Fr. *aréomètre* or *pèse-liqueur*; Ger. *Aräometer* or *Senkwaage*) or hydrometer is a graduated instrument which floats in a liquid, without being wholly submerged, under the equilibrium of the weight of the whole body acting downwards, and the buoyancy of the liquid, equal to the weight of the part of the liquid displaced, and acting upwards. The specific density of a uniform cylinder, say of ice, floating vertically in water is the volume immersed ÷ the whole volume; and in liquids of different specific densities such cylinders would sink to different depths. But it is more convenient to use graduated hollow glass instruments weighted with mercury at one end to make them float vertically (see fig. 1). AB is graduated; C is a large bulb; D is a small bulb containing mercury, the quantity of which is so adjusted that the instrument sinks in water, say to the point W. If the liquid be heavier than water the instrument will not sink so far; the position of equilibrium in which the weight of the whole instrument is equal to the weight of the liquid displaced will be sooner reached; and, conversely, if the liquid be lighter than water the instrument will sink farther. Each instrument must be experimentally graduated by placing it in liquids of known specific densities. By varying the adjustment of the mercury a series of instruments may be made, serviceable in ascertaining the specific densities of liquids within particular ranges of density—e.g. instruments for sulphuric acid, milk, alcohol, &c. The delicacy of such an instrument depends on the bulb C being large and the stem AB thin. The chief modes of graduation are (1) Gay-Lussac's areometer or volumometer. In water the instrument



stands at 100°. All the degrees are equal, and each = $\frac{1}{125}$ the volume of that part of the instrument which is immersed when it floats in water. If n be the numerical reading when the instrument is floated in a given liquid, the specific density of that liquid is $100 \div n$ —e.g. if the instrument stand at 80°, the specific density = $100/80 = 1.25$. (2) Baumé, for liquids heavier than water. Water at 17.5° C. = 0°; an aqueous solution containing 10 per cent. by weight of common salt (NaCl) at 17.5° C. = 10°; the scale is uniformly graduated; specific density = $146.8 \div (146.8 - n)$. (3) Baumé, for liquids lighter than water; 10 per cent. by weight salt-solution at 12.5° C. = 0°; water at 12.5° C. = 10°; specific density = $146 \div (136 +$

$n)$. (4) 'Rational' Baumé, for liquids heavier than water; water at 15° C. = 0°; sulphuric acid, specific density = 1.842 = 66°; specific density = $144.3 \div (144.3 - n)$. (5) Cartier, resembles Baumé; for liquids lighter than water, 21° Cartier = 21° Baumé; otherwise 15 Cartier degrees = 16 Baumé degrees; specific density = $136.8 \div (126.1 \mp n)$. (6) Beck; pure water = 0°; specific density, 0.850 = -30°; uniform graduation; specific density = $170 \div (170 \mp n)$. (7) Twaddell, most used in England; water = 0°; graduation not uniform, but readings direct; specific density = $(1000 + 5n) \div 1000$ —e.g. a gallon of acid of 24° Twaddell weighs 10 lb. $\times \frac{1000 + 120}{1000} = 10 \text{ lb.} \times 1.12 = 11.2 \text{ lb.}$ (8) Tralles,

an alcoholometer scale used on the Continent, adjusted so as to show directly the volume-percentage of alcohol in alcohol and water. (9) Sikes, used in the British Customs and Excise; graduated so as to show how many volumes of water must be added to or taken from 100 volumes of the mixture under examination to reduce it to proof-spirit (a mixture whose density = $\frac{1}{3}$ that of water at 51° F.—i.e. 57.09° Tralles), the instrument being adjustable to different ranges of density by a set of movable weights. Instead of making the quantity of liquid displaced to vary, as in the above instruments, the displacement may be kept constant and the weight of the instrument varied. Fig. 2 shows Nicholson's areometer—a hollow brass case, BC; cups at A and D; a weight at E. Suppose it weighs 2000 grains; and let it sink in water to a certain mark between B and A when 500 grains weight is put in A. If it be now transferred to another liquid in which only 250 grains are required to make it sink to the same mark, the second liquid is lighter than water in the ratio of 2250, the whole weight of the apparatus, to 2500, its former whole weight; and its specific density is therefore $\frac{2250}{2500} = 0.9$. The same instrument may be used to find the specific density of small solids thus: put a little stone or gem in A; to make the apparatus sink to the mark say 440 grains are required; therefore the stone weighs 60 grains. Now put it in D. More weights, say 20 grains, must now be



Fig. 2.

put in A; the 20 grains represent the apparent loss of weight in water; the specific density = $\frac{\text{weight in air}}{\text{apparent loss in water}} = \frac{60}{20} = 3$. By reversing D, which is perforated, the specific density of bodies lighter than water may be ascertained. Fahrenheit's areometer, the original form, differs from Nicholson's in having no platform or cup D. Rousseau's densimeter combines the two methods described above. It bears a cup or cavity at its summit. This is filled successively with various liquids; each induces a different amount of sinking. The instrument-maker has to do the preliminary graduation by the use of known liquids. Specific-gravity bulbs are also used; they are marked with numbers representing specific densities. Those which are too heavy sink; those which are too light float; the one exactly corresponding to the density of the liquid, if there be one, neither rises nor sinks. The most accurate method is that by the specific gravity flask. The specific density of a gas or vapour is determined (1) by weighing a copper flask when empty, when filled with the gas, and when filled with air, which method gives the density of the gas relatively to that of air, when proper corrections are made so as to compare the two gases at the same temperature and pressure; (2) by ascertaining the volume occupied by a given weight of the gas or vapour at a

known temperature and pressure; (3) by measuring the weight of vapour which can occupy a known volume, this being effected by putting liquid into a vessel of known capacity and heating until there is, at a known temperature and the atmospheric pressure, nothing but vapour in the vessel, then closing and weighing when cool. The last two methods are specially applicable to vapours rather than to permanent gases. It is often convenient, instead of taking the true specific density of a gas or vapour—e.g. that of air, the number of grammes per cubic centimetre of which is 0.0012932—to state its density as compared with air or hydrogen as a standard. In this way air is said to have a density = 1 or = 14.47, according as air or hydrogen is taken as the standard. The use of hydrogen as a standard is of special convenience in chemical calculations, for the densities of gases or vapours so measured are, as a rule, proportional to their molecular weights. The following are the specific densities of some common substances:

Air.....	0.0012932	Hydrochloric acid solution at 32° F.....	0.908
Alcohol.....	0.80	Hydrocyanic acid gas (= $0.9476 \times \text{air}$).....	0.1225
Aluminium.....	2.56 to 2.67	Hydrogen (= $0.06926 \times \text{air}$).....	0.0000959
Ambler.....	1.08	Ice.....	0.91674
Ammonia gas (= $0.589 \times \text{air}$).....	0.000762	Iridium.....	22.42
Ammonia solution.....	0.88	Ivory.....	1.8 to 1.9
Amorphous arsenic.....	4.71	Lead.....	11.37
Anthracite.....	1.4 to 1.7	Lignum-vitæ.....	1.33
Antimony.....	6.715	Limestone.....	2.6 to 2.8
Arsenic crystals.....	5.73	Liquefied oxygen.....	1.124
Ash.....	0.84	Lithium.....	0.5686
Bismuth.....	9.9	Limestone.....	4.9 to 5.2
Blood.....	1.04	Manganese.....	7.2
Bone.....	1.6 to 2.0	Marble.....	2.5 to 2.8
Brown coal.....	1.2 to 1.4	Mercury.....	13.59
Butter.....	0.94	Milk.....	1.03
Calcium.....	1.578	Nitric acid.....	1.517
Cannel coal.....	1.16 to 1.27	Nitrogen ($0.9718 \times \text{air}$).....	0.00126
Carbonic acid gas (= $0.524 \times \text{air}$).....	0.00197	Oak, English.....	0.97
Cast-iron.....	7 to 7.6	Oil of cloves.....	1.03
Chalk.....	2.45	Oil of turpentine.....	0.87
Charcoal.....	0.3 to 0.5	Olefiant gas (= $1.9784 \times \text{air}$).....	0.01265
Chlorine ($2.4502 \times \text{air}$).....	0.00317	Oxygen (= $1.1056 \times \text{air}$).....	0.00143
Clay.....	1.8 to 2.6	Platinum.....	21.1 to 21.7
Cobalt.....	8.96	Poplar.....	0.38
Copper.....	8.85 to 8.94	Potassium.....	0.86
Cork.....	0.24	Ruby.....	4.3
Cyanogen ($1.806 \times \text{air}$).....	0.00234	Sand in bulk, dry, about.....	1.5
Diamond.....	3.53 to 3.55	" " wet.....	1.9 to 2.0
Dry peat.....	0.5	Silver.....	10.53
Elm.....	0.67	Sodium.....	0.972
Flint.....	2.6 to 2.7	Spanish mahogany.....	1.06
Glass.....	2.4 to 3.5	Steel.....	7.6 to 7.8
Gold.....	19.26 to 19.55	Sulphuric acid.....	1.854
Granite.....	2.5 to 2.9	Sulphuric ether.....	0.72
Honey.....	1.45	Sulphurous acid gas (= $2.24 \times \text{air}$).....	0.0029
Human body alive.....	0.89	Tin.....	7.29
Hydrolic acid (= $4.44 \times \text{times that of air or } 64.11 \times \text{times that of hydrogen}$).....	0.00574	Topaz.....	3.4 to 3.6
Hydrochloric acid gas (= $1.26 \times \text{air}$).....	0.00163	Wrought-iron.....	7.25 to 7.79
		Zinc.....	6.86 to 7.21

Specific Gravity, the weight of any given substance as compared with the weight of an equal bulk or volume of water or other standard substance at the same temperature and pressure. See SPECIFIC DENSITY.

Spectacles, for the purpose of aiding the sight when impaired by age or otherwise (see EYE), are commonly said to have been invented during the 13th century. The merit is variously attributed to Alessandro di Spina, a monk who died at Pisa in 1313, and to Salvino degli Amati, who died at Florence in 1317; but spectacles seem to be referred to by the Arab writer Alhazen (11th century) and by Roger Bacon (c. 1214-94). In 1482 there were spectacle-makers at Nuremberg. At first spectacles were exceedingly clumsy, both in the lenses themselves and also in their frames; and very little improvement took place in them until the beginning of the 19th century, when light metal frames were introduced instead of the cumbersome horn or tortoiseshell mountings, which are

still occasionally seen, and have obtained the name of goggles. So skilful are the workmen of Wolverhampton, where they are chiefly made, in the manufacture of steel frames that some of exquisite workmanship are now turned out, which, with their lenses complete, are under a quarter of an ounce in weight. They have consequently displaced gold, silver, and all other materials, when comfort and effectiveness are desired. The lenses themselves are nearly always made of the best optical glass, and by the best makers are ground with extreme care. Many profess to be made of 'pebbles' or rock-crystal; but lenses really made of that material are exceedingly rare and have no real advantage over good glass. The spectacle-frame ought to be so fitted that the optic axes of the lenses shall coincide with those of the eyes; otherwise there is a strain on the eyes.

It is most important that the glasses worn should be properly selected, otherwise they may do much harm. In cases of Astigmatism (q.v.), and those where the two eyes are different, competent medical advice should always be sought. In simple myopia (short-sight) and hypermetropia (long-sight; see EYE, Vol. IV. p. 515) the general principles of selection are less complex, though their proper application is often a difficult matter. In short-sight the glasses (concave) used should be the *weakest* with which distant objects are clearly seen, or somewhat weaker; in long-sight the glasses (convex) should be the *strongest* with which distant objects are clearly seen; for reading and near work still stronger glasses are often required. In presbyopia or old-sight (Vol. IV. p. 512) the glasses should be of such a strength as to enable print to be comfortably read at about 10 inches from the eyes.

Spectrum. As explained under the article COLOUR, light emanating from any ordinary source is rarely if ever homogeneous. It is composed of rays of different wave-lengths, each of which if viewed singly would appear to have an appropriate colour. The general colour-sensation produced by such a heterogeneous ray can teach us very little concerning its composition. Not until we have formed its spectrum by appropriate means are we able to analyse it. A spectrum is in fact an image in which the component parts of a given ray of light are separated from one another so that each may be viewed singly.

Newton was the first who scientifically produced and studied the spectrum of sunlight. This he did by interposing a glass prism in the path of a ray which was allowed to enter a dark room through a small hole in the shutter. The arrangement is shown diagrammatically in fig. 1. Here the rays are bent out of their original course, SA, as they pass through the prism P; and on the screen, H, the spectrum of colours is formed instead of the image A. Newton regarded the spectrum as being divisible into seven differently coloured spaces, which he called in order red, orange, yellow, green, blue, indigo, and violet. It is impossible, however, to settle precisely the exact boundary between any two of these fancied species of colour, which pass by insensible gradations one into another. As Newton clearly demonstrated, the spectrum is produced because the differently coloured constituents of sunlight have different refrangibilities, the red being refracted least of all and the violet greatest of all (see REFRACTION). If light of a particular refrangibility were absent or of less intensity than the other constituents gaps would appear in the spectrum. As a matter of fact such gaps do exist in the solar spectrum, and were first observed by Wollaston in 1802. In 1817 Fraunhofer, with much more perfect optical apparatus, measured the relative positions of a great number of these *dark*

Showing the Character of the light obtained from various sources.

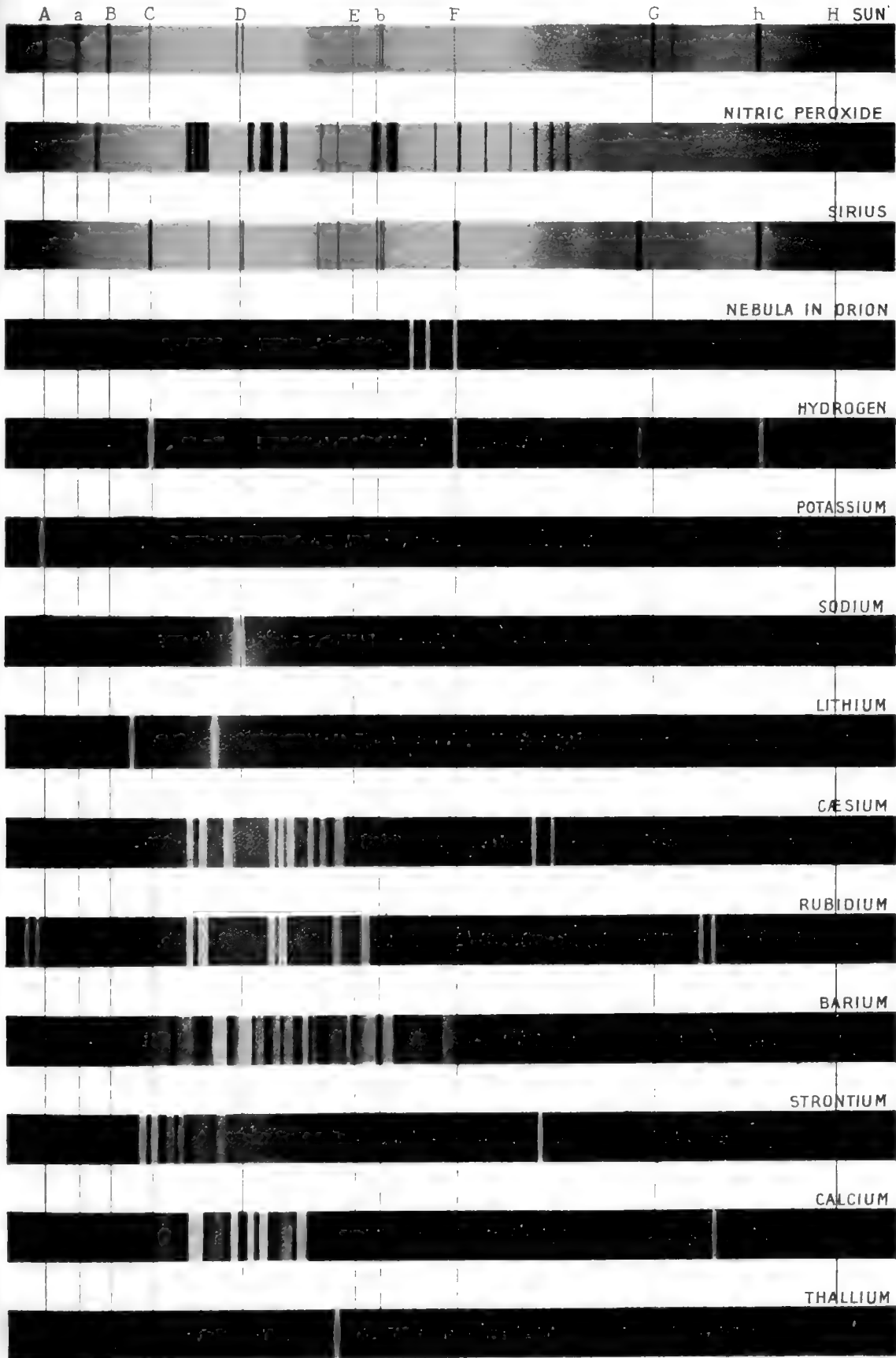

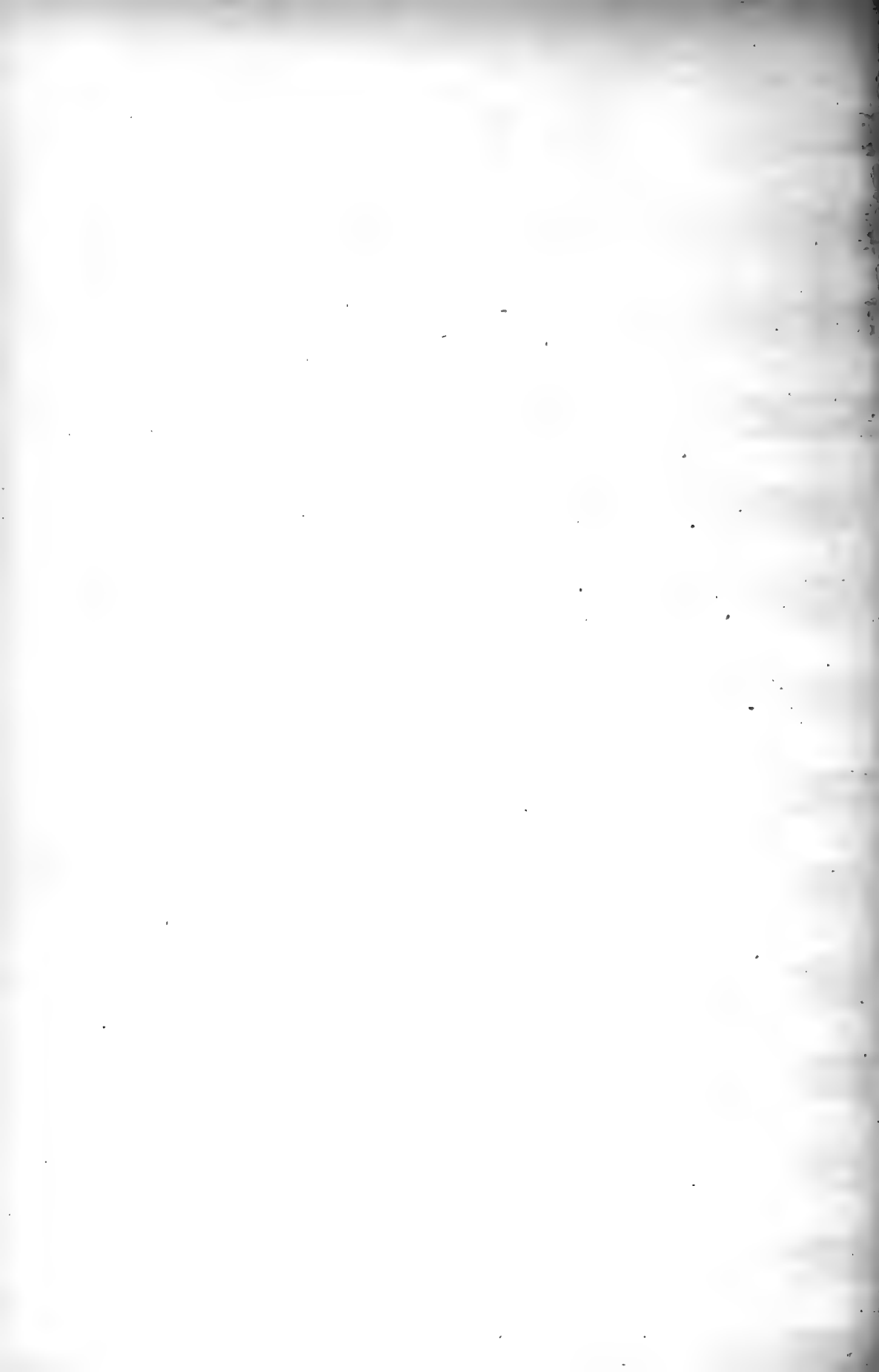

lines, and named the more important of them by the early letters of the alphabet. These are shown in

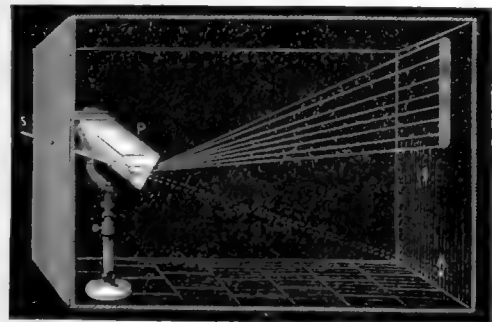

Fig. 1.

the first spectrum in the table of spectra. They are the standard lines with which it is usual to compare the line characteristics of other spectra.

For the careful observation of these lines the spectroscope or spectrometer has been constructed. It consists essentially of a prism or train of prisms, P; a collimator, C, at the focus of whose lens, L, is placed a narrow slit, S, parallel to the edge of the prism; and a telescope, T, for producing a magnified image of the spectrum of the illuminated slit. Nearly all transparent refractory substances give similar spectra, although the dark lines may be somewhat differently spaced in the different cases. This arises from the fact that substances vary in

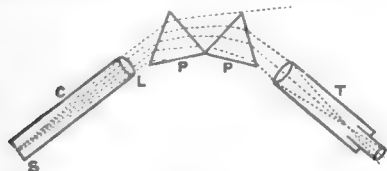

Fig. 2.

their dispersive as well as in their refractive powers (see DISPERSION). The optical value of the spectroscope is that it gives us the means of accurately determining the refractive indices of different substances for rays of definite wave-lengths. Now, although refrangibility depends on wave-length, being in general greater for the shorter wave, it does not depend upon it according to any simple or common law. Hence in prismatic spectra the characteristic lines are not spaced in accordance with any simple relation to the wave-lengths of the corresponding rays. If, however, we substitute for the prismatic part of the spectroscope a diffraction-grating, we obtain a spectrum in which the rays are spaced according to a law of extreme simplicity.

A diffraction-grating is formed by ruling a series of fine lines on a glass or metal surface. For the production of a good spectrum it is necessary that the lines should be equidistant and so close that several thousands go to an inch. If the image of an illuminated slit be viewed by a telescope through or after reflection from such a grating, a remarkable appearance is presented. A central luminous line is seen, just as if no grating existed, and for some distance on either side the field is dark. But soon on both sides spectra appear, with their blue ends nearest the central line. Still farther to left and right secondary spectra appear, their blue ends overlapping the red ends of the primary spectra. These are followed by a third but fainter set, and so on. These successive spectra are due to the Interference (q.v.) of the rays emanating from the

discontinuous wave-front which has been made so discontinuous at the grating. The absolute position and breadth of the spectra depend on the closeness of the lines of the grating; but the relative positions of the coloured rays in any spectrum depend only on the wave-lengths. Thus in the solar spectrum produced by a diffraction-grating Fraunhofer's lines are so distributed that their distances from the central luminous line above mentioned are proportional to the wave-lengths of the corresponding rays of light. This spectrum is accordingly called the Normal Spectrum. Compared with it, the ordinary prismatic spectrum is much crushed towards the red end and extended towards the violet end. A rough comparison is shown in fig. 3, the principal Fraunhofer lines being given in the two spectra, which are of the same total length.

Professor Rowland, by means of his concave gratings, or gratings marked on a concave cylindrical surface of speculum metal, has produced remarkably fine spectra. Because of the slight concavity the grating focusses the spectrum clearly at a particular distance, so that the object-glass of the telescope may be dispensed with.

We have now to consider the significance of the dark lines in the solar spectrum. These gaps may be imagined as originating in two ways. They may be absent in the sunlight from the very beginning, or they may be absorbed by some substance through which the ray passes from the sun to the earth. As Brewster showed long ago, many of the lines are really due to absorption by the earth's atmosphere, and are more marked when the sun is low than when the sun is high. These lines which are certainly due to absorption by the earth's atmosphere are called telluric. Near the Fraunhofer D lines there exists a very remarkable group of lines known as the Rain-band. It is due to water-vapour in the air, and gets very dark as the humidity approaches saturation. The principal lines in the solar spectrum are, however, not telluric. Nor can they be explained as due to the absorptive action of the ether, inasmuch as the various spectra of stars, though broadly similar to that of the sun, differ from it and from one another greatly in detail. (Compare, for example, the spectra of Sirius and of the sun in the table.) In short, solar and stellar spectra are very characteristic in the number and distribution of the

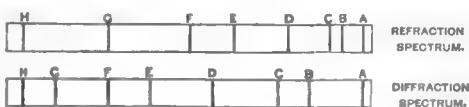

Fig. 3.

lines which cross what is otherwise a continuous spectrum (see STARS). If then these lines are due to absorption, it must be absorption in the atmosphere enveloping each star or sun. That this is the true explanation of the dark lines has been for long regarded as established beyond a doubt.

Previous, however, to the discovery of the principle which lies at the basis of stellar and solar spectroscopy, the great variety of spectra given by different substances had been recognised. Some of these are shown in the accompanying table of spectra; and, as suggested by Talbot and Herschel in 1825, an obvious application of the prism is to the qualitative determination of small quantities of substances in minerals. In the accompanying coloured plate, the characteristic spectra of the vapours of ten of the metals taken by themselves may be compared with the very different spectra of

the sun, of nitric peroxide, and of Sirius; that of the nebula in Orion almost rivals in simplicity the visible spectrum of sodium vapour. The case of Thallium (q.v.) is of peculiar historic interest, since it was the observation of its very characteristic line spectrum which led to its discovery. Of even greater interest historically is the spectrum of sodium, which may be observed by burning common salt in a spirit-flame. Fraunhofer observed that the two bright yellow lines so characteristic of the sodium spectrum coincided in position with the double line known as D in the solar spectrum. A very careful test of this coincidence was made by Professor Miller, following upon which Stokes (in 1850) gave for the first time the physical explanation of the phenomenon—viz. that the Fraunhofer double D is produced by the absorptive action of sodium vapour in the sun's atmosphere. Foucault (in 1849) had already obtained an evident darkening of the D lines when the ray of sunlight was passed through the electric arc, which gave in its spectrum the bright sodium lines; but he failed to grasp the significance of the experiment. Ten years later Kirchhoff made a similar experiment, and to him we owe the complete statement of the principle on which spectrum-analysis is based. (For the important work of Balfour Stewart in this connection, see HEAT.) The principle is defined by Kirchhoff thus: the ratio of the emissive and absorptive powers for any given radiation is the same for all bodies at the same temperature. If we imagine the existence of an ideal black body which is at once a perfect absorber and a perfect radiator, we may, following Tait in his development of Stewart, express the principle in this wise: for any given temperature the emissivity of a radiating body is equal to its absorptivity. Here emissivity is the emissive power of the chosen body compared with that of the ideal black body; and similarly absorptivity is the ratio of the absorptive powers of the chosen body and the black body for the same radiation at the same temperature. Suppose we have a body A exposed to radiation r from a body B. If A were black the whole radiation would be absorbed. As it is, however, the body A will absorb only er , where e is the emissivity. Again, if R is the measure of the radiation which a black body at the temperature of A would radiate, eR will measure the radiation of A. Hence the amount of radiation which reaches us from A, and through A from B, will be $eR + (r - er) = r - e(r - R)$. Hence there will be a real resultant absorption by A as the rays from B pass through it if, and only if, r is greater than R —i.e. in accordance with experience, if B is at a higher temperature than A. The ultimate basis of the argument is the Second Law of Thermodynamics (q.v.); and it should be noted that the principle fails to apply to cases of phosphorescence or fluorescence. Thus we conclude that the Fraunhofer lines in the solar spectrum are due to the absorptive action of the comparatively cool atmosphere of the sun upon the radiation which comes from the hotter interior parts. At the instant of a total eclipse of the sun, when the hot interior is screened off, the spectrum of the cooler but still self-luminous envelope is seen to consist of several bright lines. With the exception of one peculiar line in the yellow, these are all coincident in position with certain of the dark Fraunhofer lines. The most conspicuous of the lines that so become reversed are the four hydrogen lines. The b line due to magnesium, the double D, and some of the iron lines have also been observed reversed at the instant of totality.

The identification of the dark lines in solar and stellar spectra with the bright lines in the spectra of the various elementary substances raised to a

high enough temperature is one of the most important labours of the spectroscopist. A list of the elements which have been proved to exist in the solar atmosphere will be found in the article SUN. In fig. 4 a small portion of the sun's spectrum near the b line is given, showing the identification of certain constituents of the sun's atmosphere with iron, magnesium, nickel, and calcium.

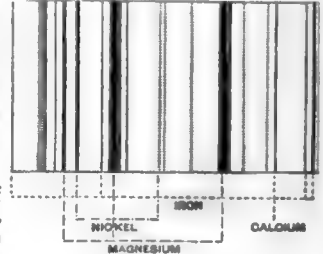

Fig. 4.

The character of the spectrum of a given substance changes with temperature and pressure. For example,

although hydrogen, like all gases, gives at ordinary pressures a bright line spectrum with sharp thin lines, these lines become broader and broader as the pressure is increased, until at very high pressures the spectrum becomes almost continuous like that given by a glowing white hot solid. Thus we learn that a highly compressed gas at a high temperature ceases to give the discontinuous bright line spectrum so characteristic of it at low pressures. One tolerably safe conclusion to draw is that stars which all have continuous spectra crossed by dark absorption lines or bands consist of a highly condensed nucleus; whereas true nebulae, which show bright line spectra (see the table of spectra), are luminous because of the presence of glowing gas in a comparatively attenuated condition. In the case of Comets (q.v.) the spectrum is faintly continuous with bright lines crossing it—a mingling of solar reflected light with the proper gaseous spectrum of the comet itself. The planets give in like manner the spectrum of sunlight modified more or less by the absorptive character of their atmospheres.

If a ray of sunlight, or a ray from the electric or lime light, is passed through various liquids, very characteristic absorption bands are obtained across the otherwise continuous spectrum. For example, arterial and venous bloods give absorption spectra, which are readily distinguishable one from the other. The second spectrum in the plate is an absorption spectrum produced by passing the electric ray through peroxide of nitrogen. It shows the band characteristics of such spectra.

A very remarkable application of spectrum-analysis is to the measurement of the rate of approach or recession of any heavenly body. If we are approaching a star the waves of light will meet us at a somewhat quicker rate than if we were relatively steady with regard to it. That is, the waves of light will appear to be shorter—hence all the lines in the spectrum will be displaced towards the violet end. On the other hand, if we are receding from the star, the spectrum lines will appear to be shifted towards the red end. For example, in the spectrum of Sirius, the F line is very slightly shifted towards the red by an amount which is measurable in a fine spectroscope. The interpretation is that Sirius is receding from the solar system with a velocity of about 20 miles per second. Arcturus, on the other hand, is approaching our system with a speed of 55 miles per second. Similar displacements of lines are observed in the spectra of certain sun-spots, which are thereby proved to consist of downrushes of gas.

Throughout this article we have confined our attention to the visible part of solar spectrum. But this extends much further than is apparent

to the eye. Below the red are the dark heat rays, whose presence or absence can be demonstrated by the appropriate means. Professor Langley has specially studied this region with the aid of rock-salt prisms and the Bolometer (q.v.), and has carefully measured the positions of the absorption bands. Captain Abney has, by use of a special preparation of bromide of silver, obtained photographs of the infra-red end of the spectrum, and has identified some of the absorption lines with lines in the spectra of metals of low melting points, such as sodium and calcium. Metals which volatilise at high temperatures do not seem to give lines below the red. Above the visible violet again are the invisible actinic rays. This upper part of the spectrum can be made visible by allowing it to fall upon some suitable fluorescent substance, such as uranium glass or a solution of sulphate of quinine. Photography, however, supplies us with a perfect method for obtaining visible images of the actinic spectrum. Indeed, by properly choosing the sensitive substance, we can now photograph any part of the spectrum from a radiation of nearly four times the wave-length of the red rays up to the highest actinic rays known to exist; and in the extended solar spectrum so obtained we find the same characteristics throughout—a continuous spectrum crossed by dark lines.

Schellen's *Spectralanalyse* (2 vols. 3d ed. 1883; Eng. trans. 1885), with *Atlas* of spectra, is the most complete treatise on the subject. See also Lockyer's *Studies in Spectrum Analysis* (Inter. Sc. Series, 2d ed. 1886).

Specular Iron. See IRON, Vol. VI. p. 215.

Speculum Metal, an alloy used for the specula or mirrors of reflecting telescopes. The best is composed of 126 parts of copper and 58.9 of tin. It takes a fine polish and is not easily tarnished unless exposed to damp. Glass with a film of metallic silver deposited upon it is now taking the place of speculum metal for these mirrors. The silvered glass is equally serviceable and less costly. See TELESCOPE.

Spedding, JAMES, was born at Mirehouse, near Bassenthwaite, in June 1808, the younger son of a Cumberland squire. From Bury St Edmunds, where he was head of the school, he proceeded in 1827 to Trinity College, Cambridge, of which he became a scholar, and of which too at his death he had long been an honorary fellow. Still, brilliant scholar though he was, his degree was only a second-class in classics and junior optime. From 1837 to 1841 he held a post at the Colonial Office; in 1842 he accompanied Lord Ashburton (q.v.) to America as private secretary; and in 1847 he might, had he chosen, have become Under-secretary of State, with £2000 a year. But he had already devoted himself to the task of his life—'to re-edit Bacon's Works, which did not want any such re-edition, and to vindicate his character, which could not be vindicated.' So writes Edward Fitz Gerald, the oldest of Spedding's many brilliant friends—Tennyson and Carlyle were also of the number—and he adds: 'He was the wisest man I have known; not the less so for plenty of the boy in him; a great sense of humour; a Socrates in life and death, which he faced with all serenity so long as consciousness lasted.' That death was in St George's Hospital, on 9th March 1881, Spedding having eight days before been run over by a cab.

His publications were *Works, Life, and Letters of Bacon* (14 vols. 1857-74); *Publishers and Authors* (1867); *Account of the Life and Times of Bacon* (2 vols. 1878); *Reviews and Discussions not relating to Bacon* (1879); *Studies in English History* (1881), in conjunction with J. Gairdner; and *Evenings with a Reviewer* (relating to Bacon, 2 vols. 1881). See the brief Memoir by G. S. Venables prefixed to the last, and also Fitz Gerald's *Letters* (1889).

Speech. See ADAM, DUMBNESS, PHILOLOGY, PHONETICS, VISIBLE SPEECH, VOICE.

Speed, JOHN, antiquary, was born at Farrington in Cheshire in 1542, worked most of his days at London as a tailor, and died July 28, 1629, being buried in St Giles's, Cripplegate. All his life long he had been acquiring historical learning, and his extraordinary attainments at length gained him the acquaintance of Sir Fulke Greville and others, and hence opened up a door for the publication of the great works through which his name survives. These are *Maps* (54) of *England and Wales* (1608-10); incorporated into *The Theatre of the Empire of Great Britain*, 1611; *The History of Great Britain under the Conquests of the Romans, Saxons, Danes, and Normans* (1611). His theological writings are of no importance.

Speedwell (*Veronica*), a genus of plants of the natural order Scrophulariaceæ, distinguished by a four-cleaved wheel-shaped corolla, with the lower segment narrower, two stamens, and a two-celled capsule. The species are very numerous, annual and perennial herbaceous plants and small shrubs, natives of temperate and cold climates in all parts of the globe. Some of them grow in wet ditches and in marshes, some only on the driest soils. They have generally very beautiful blue, white, or pink flowers. The number of British species is considerable, and few wild-flowers are more beautiful than the Germander Speedwell (*V. chamaedrys*), or the alpine species, *V. alpina* and *V. saxatilis*. A number of species are very generally cultivated in flower-gardens. The bitter and astringent leaves of the Common Speedwell (*V. officinalis*), one of the most abundant British species, found also in almost all the northern parts of the world, are in some countries used as a tonic, sudorific, diuretic, and expectorant medicine. They are also employed, particularly in Sweden, as a substitute for tea, as are those of the Germander Speedwell. *V. virginica* is called *Culver's Physic* in North America; it is said to be actively diuretic, and a decoction of the fresh root is violently cathartic and emetic. Brooklime (q.v.) belongs to this genus. Several of the shrubby species of *Veronica* of peculiar and ornamental character, natives of the mountains of New Zealand, are now plentiful, and prove perfectly hardy, in British gardens.

Speier, a town of Bavaria. See SPIRES.

Spelss. This name is given to the product first obtained (an arsenide of the metal) when arsenical ores are smelted. See NICKEL.

Speke, JOHN HANNING, an explorer of Africa, was born on 4th May 1827 at Jordans in Somersetshire, entered the Indian army when seventeen, and saw some active service in the Punjab. During peace he spent great part of his time in making shooting expeditions into the Himalayas, in the course of which he collected natural history



Common Speedwell
(*Veronica officinalis*).

specimens and did a good deal of route-plotting. In 1854 he joined Burton in an excursion into the Somali country, and barely got back with his life. Three years later the Royal Geographical Society sent out the same two travellers to search for the great equatorial lakes of Africa. Speke, whilst travelling alone, discovered the Victoria Nyanza, and was convinced that it was the head-waters of the Nile. In 1860 he returned in company with Captain J. A. Grant (q.v.; died 10th February 1892), and not only explored the western and northern shores of the large lake he had previously discovered, but followed the Nile far enough down its course to establish its identity with the great river of Egypt. Nevertheless his identification was disputed by Burton and others; and Speke was to hold a public discussion with Burton at the British Association meeting at Bath on 15th September 1864, when, on that very morning, he accidentally shot himself whilst out shooting near that city. He wrote *Journal of the Discovery of the Source of the Nile* (1863), and *What led to the Discovery of the Source of the Nile* (1864).

Spell. See INCANTATION.

Spelling is originally phonetic, its aim to convey to the eye the sound heard by the ear; but in modern English the usage of pronunciation has drifted far from the conventional forms established by a traditional orthography, with the result that the present spelling of our written speech is to a large extent a mere exercise of memory, full of confusing anomalies and imperfections, and involving an enormous and unnecessary strain on the faculties of learners. The modern English alphabet consists of twenty-six letters, of which five are vowels, and of these not even the consonants are consistent in sound, as may be readily seen in the current pronunciation of such words as *give, gin; cent, cant; thin, this; cough, dough; sough, hic-cough, hough; loch, arch, patriarch*. Some again are superfluous, as hard *c, q, x*, their sounds being capable of being represented by other letters; while others remain silent in pronunciation, as seen in *through, plough, debt, knell, write, lamb, malign, demesne, trait*. Further anomalies appear in *walk, folk* as opposed to *malt, fault*; while a stranger series still appear in such words as *colonel, lieutenant, foreign, scent, island, scythe, scissors, rhyme, ache, sceptic*. Again, the same vowel or diphthong meets us in such varying forms as the following (from Mr Lounsbury's lists): the short *e* variously in *met, sweat, any, said, says, jeopardy*; the long *e* in *meet, mete, meat, machine, grief, receive, key, quay, people, ægis*. Again, take the varying forms of the same vowel-sound in *rude, rued, rood, routine, rheum, drew, shoe, move, bruise*; while on the other hand six different sounds have the same form in *sour, pour, would, tour, sought, couple*; and five in *heat, sweat, great, heart, heard*. Groups of words like *man, lanc, ask, salt* on the one side, and *why, wine, eye, lie, or air, heir, eyre, ere, e'er* on the other, show equally a violation of the fundamental principle of all rational spelling—viz. that of representing every sound by an invariable symbol.

Examples enough have been given to demonstrate the utterly unscientific character of English spelling; it now remains to ask how this has originated, and whether any measure of relief from such a burden is practicable. It was only slowly that this modern uniformity became rigid, and we may dismiss as completely without foundation the defence put forward by pre-scientific philologists like Trench that the modern spelling is valuable as preserving an index to the derivation. Even if this were true, are we justified in paying so great a price for an end so little? But when we look at the facts we

find that if the conventional spelling in some few cases preserves a hint as to the ultimate origin, as in *ant, newt, knave, debt*, it is far more often the case that it obscures the order of descent, or merely preserves the memory of some error through false analogy or sheer ignorance, as in words like *shame-faced, rhyme, comptroller, singlass, whole, bridegroom, stark-naked, battledoor, belfry, taffrail, spruce-beer*. Again, the infallible writers for the press talk with indignation of being divorced from the tongue of Shakespeare and the Bible; but, as Dr Murray says, the slightest glance at 17th-century orthography will show what an immense amount of spelling reform has been done since then. Thus Psalm cvi., as printed in 1611, differs in 116 spellings from that printed in 1892; the first chapter of Genesis, in 135 spellings. One of the most important spelling reforms in English was that made about 1630 when *u* was made a vowel and *v* a consonant, for up to that time these were only forms of the same letter having a position-rank like long *f* and short *z*. From the 14th century onwards a fashion grew of adapting the spelling of words to their supposed Latin originals, with what confusion to the real history of the words may be imagined from the accidental or capricious errors of sciolists innocent of scientific method. But generally speaking up to the 16th century English spelling was mainly phonetic like the present German. The old scribes allowed themselves large liberty in the forms they adopted, to which Chancer refers in the well-known lines, 'and for there is so great diversite in English, and in writing of our tong.' The *Ormulum* is an interesting example of a consistent attempt at a phonetic spelling. But as literature developed and the printing-press began to assert its authority the spelling became more and more fixed, till at last it became quite stationary, while the pronunciation continued to go on changing without intermission until, as Mr Sweet says, our present spelling does not represent the English we actually speak, but rather the language of the 16th century. This progress towards uniformity went on actively during the 17th century, but it was Johnson's *Dictionary* (1755) that gave universality to the currency. Meantime spoken language grew, and natural divergencies arose, resulting in the modern pronouncing dictionary, which Trench called with justice 'the absurdest of all books.'

Halliwell tells us Shakespeare spelt his name in some thirty different forms; the young Pretender writes of his father indifferently as *Jems* or *Gems*; Claverhouse, says Macaulay, spelt like a washer-woman; and the great Marlborough used the same freedoms as Thackeray's *Jeames* or the ordinary Englishman whose education stopped short for ever at the Fourth Standard. But we may remember that Will Honeycomb never liked pedantry in spelling, and spelt like a gentleman, not like a scholar. And we must not suppose that great as was Johnson's influence all his spellings have been accepted. His *musick, ambassadour, horrou, cimeter, waterfal, parnep, skeptick, sackcloath*, have disappeared; but some of his strange pairs of inconsistencies survive: *moveable* and *immovable, chilsfactory* and *chyle, bias* and *unbiassed*. Similar are *recognize* and *surprise, confer* and *conferred, worship* and *worshipper*. Webster in his 1828 edition gives us many original spellings, as *melasses, pretense, bridegoom*, all of which were swept away in the revision of 1864. Julius Hare and Thirlwall adopted such forms as *forein, sovereign, cherisht, preacht*, from one-sided considerations of philology; Ritson's habit of adding *-ed* to the preterite of all verbs was but one among many of the whimsical notions of a half-crazy antiquary; Pinkerton's vagaries are beneath notice; the usages familiar to readers

of Mr Furnivall's 'fore-words' belong to quite another category, and might be commended altogether, but for the saving caution of Mr Sweet that 'nothing can be done without unanimity, and until the majority of the community are convinced of the superiority of some one system unanimity is impossible.' For spelling reform must proceed by a wise moderation, and Englishmen as yet are far from being ready for such elaborate systems as the Glossic of Mr Ellis, the Romio of Mr Sweet, or even the Phonetik type which Mr Pitman has been bravely printing for fifty years. But to these scholars the cause owes all the progress it has made, and their names will live in honoured memory when rational principles at last prevail over the tremendous forces of inertia and prejudice. It is hard to reason men out of beliefs they have never been reasoned into, and it may yet be long before our children are relieved of an unnecessary burden too heavy to be borne. That we can still read Chaucer and *Piers Plowman* despite Johnson's *Dictionary* should dispose of the one specious difficulty objected to reform; another—viz that uniformity would confound such homonyms as *write, rite, right, and wright*—is answered by the fact that the identity of sound troubles us little in speaking, and would trouble us still less in reading, with the help of the context before us. Meantime the true path of progress should follow such wisely moderate counsels as those of Dr Murray: the dropping of the final or inflexional silent *e*; the restoration of the historical *-t* after breath-consonants; uniformity in the employment of double consonants, as in the American *traveler*, &c.; the discarding of *ue* in words like *demagogue* and *catalogue*; the uniform levelling of the agent *-our* into *-or*, already so common in America; the making of *ea = ē* short into *e* and the long *is* into *ee*; the restoration of *some, come, tongue*, to their old English forms, *sum, cum, tung*; a more extended use of *z* in the body of words, as *chozen, praise, raise*; and the correction of the worst individual monstrosities, as *foreign, scent, scythe, ache, debt, people, parliament, court, would, sceptic, phthisis, queue, schedule, twopence-halfpenny, yeoman, sieve, gauge, burque, buoy, yacht, &c.*

An encouraging success is the improvement of German spelling, introduced in 1880, the chief features of which are the omission of all superfluous signs indicating the lengthening of a syllable, the substitution of *f* for *ph*, the determination of the sound of *s* hard and soft, the use of *sz*, the doubling of consonants, the retention of *h* as indicating vowel-lengthening only in root-syllables: *Akt, Armut, Elefant, tot, Irrtum, Wert*.

See PHONETICS, PHILOLOGY, ALPHABET; also the *Philological Society's Transactions* for 1880-81 (including the Presidential addresses of Murray and Ellis); Sweet's *Handbook of Phonetics* (1877) and *History of English Sounds* (1888); Max-Müller in *Fort. Rev.*, April 1876.

Spelman, SIR HENRY, antiquary, was born in 1562, son of a gentleman of ancient family, at Congham in Norfolk. He was educated at Trinity College, Cambridge, whence he passed to Lincoln's Inn. He was high-sheriff of Norfolk in 1604, and was often employed in public affairs at home and in Ireland by James I. Knighted by the king, he retired in 1612 to prolonged private studies, and died in 1641. His ponderous *Glossarium Archaeologicum*, of which he published A—L in 1626, was completed by his son, Sir John Spelman, and William Dugdale. His next great work, *Concilia, Decreta, Leges, Constitutiones in Re Ecclesiastica Orbis Britannici* (1639-64), he also left incomplete. His other works on Tithes, on Sacrilege, are no less learned, and exhibit his strong devotion to the Church of England. His *Reliquiæ Spel-*

mannianæ were edited, with a Life, by [Bishop] Edmund Gibson (1698).—His eldest son, SIR JOHN SPELMAN, inherited all his tastes and part of his learning. He was knighted in 1641, and died in 1643, author, besides other works, of a life of King Alfred (in Lat. trans. 1678; Spelman's Eng. original, edited by Thomas Hearne, 1709).

Spelt. See WHEAT.

Spelter. See ZINC.

Spence, JOSEPH, anecdotist, was born at Kingsclere in Hants, 25th April 1699. A sickly boy, he went to Eton, but in a short time left it for Winchester, thence passing to New College, Oxford, in 1720, of which he became a fellow in 1722. He took orders in 1724, three years later became professor of Poetry, and was presented to the rectory of Birchanger in Essex. He travelled on the Continent with the Earl of Middlesex, afterwards second Duke of Dorset (1730-33), again with Mr Trevor (1737), and Henry, Earl of Lincoln, afterwards Duke of Newcastle (1739-42). Before first going abroad he had published his *Essay on Pope's Odyssey* (1726), which procured him the lasting friendship of the poet. Almost from the beginning of their intimacy he began to record Pope's conversation and the incidents of his life, to which gradually many curious particulars were added gathered from the conversation of other eminent men. In 1736 he edited *Gorboduc*, and in 1737 became rector of Great Harwood in Bucks, and regius professor of Modern History. In 1747 he published his *Polymetis*, which is said to have brought him £1500, great part of which he spent on landscape-gardening at Byfleet in Surrey. In 1754 he became a prebendary of Durham. He was accidentally drowned at Byfleet, August 20, 1768. He was a constant friend to Pope, Horace Walpole, Shenstone, and Lowth, and was noted for his large charity, a devoted love to his aged mother that rivalled Pope's own, and his kind patronage of such men as Stephen Duck, thresher and poet; Robert Hill, the learned tailor; Thomas Blacklock, the blind poet; and Robert Dodsley, footman before publisher.

His MS. collection of Anecdotes was given by his executors to the Duke of Newcastle, who did not approve of their being published. Some, however, reached the public through Warburton, Warton, Johnson, and Malone—in the case of the first two from Spence himself. Malone's edition (1820) was quickly superseded by that of S. W. Singer (1820; 2d ed. 1858), printed from the original papers, with notes and a memoir.

Spencer, a town of Massachusetts, 64 miles by rail W. by S. of Boston, with several manufactories of boots and woollens. Pop. (1890) 8747.

Spencer, a family which has given several statesmen to the service of their country, was founded by the Hon. John Spencer, youngest son of the third Earl of Sunderland, by Anne, daughter and co-heiress of the great Duke of Marlborough. He inherited much property from his grandmother, Sarah, Duchess of Marlborough, and his only son, JOHN (1734-83), was made Earl Spencer in 1765.—GEORGE JOHN, second Earl (1758-1834), was First Lord of the Admiralty under Pitt's administration (1794-1801), the period of the great naval victories of Camperdown, Cape St Vincent, and the Nile. He retired when Addington became premier, and was famous as a munificent collector of rare books and the first president of the Roxburghe Club. The Spencer Library, dispersed under the hammer in 1881-83, brought £50,581.—JOHN CHARLES, third Earl Spencer, better known under the courtesy title of Lord Althorp, was born in 1782, and educated at Harrow and Trinity College, Cambridge. He entered parliament in 1804 for Oakhampton, and became a junior Lord of the Treasury when in 1806

his father took office as Secretary of State for the Home Department in the Grenville-Fox ministry. He sat for Northamptonshire from this time till the Reform Bill, and in the Reformed parliament for the southern division of the county. He went out with the Whigs in 1807, and gave steady opposition during the long Tory reign thereafter. On the dissolution of the Wellington cabinet in November 1830 he became Chancellor of the Exchequer and leader of the House of Commons in the celebrated Reform ministry of Earl Grey. The Reform Bill was introduced by Lord John Russell, but the task of carrying the bill mainly devolved upon Spencer. In 1833 he brought in and carried the ministerial bill for reforming the Irish Church. In this memorable working session the curious statistician discovered that Spencer, who had, from his post of ministerial leader, naturally been the most frequent speaker, had addressed the House 1026 times, his speeches occupying 387 columns in the then *Mirror of Parliament*. When the Irish Coercion Bill was under consideration in the cabinet Spencer had opposed the clauses prohibiting public meetings, yet had given way rather than break up the ministry, but when the truth was elicited in debate by Mr O'Connell he resigned. He was considered and described by Earl Grey as his 'right-hand man,' and without his assistance the earl felt himself unable to carry on the government. The administration of Viscount Melbourne succeeded (July 1834), in which Spencer consented to resume his office. In November he was called by the death of his father to the House of Peers, which had the effect of bringing the Melbourne administration to an end. When the attempt of Sir Robert Peel to carry on the government failed Spencer declined to take office again. He devoted his time to agricultural pursuits, became president of the Smithfield Cattle Club, and suggested the formation of the Royal Agricultural Society, of which he was elected president in 1838. He died at his seat, Wiseton Hall, Notts, October 1, 1845, without issue, and was succeeded by his brother. During his political career his simplicity of character and integrity of purpose obtained for him the appellation of 'honest Lord Althorp.' He was very little of an orator, but he had a clear and practical intellect, and his influence over the Reformed House of Commons was supreme. Lord Brougham dedicated to him his work on *Natural Theology*; and his *Dialogues on Instinct* are also supposed to be carried on with Spencer, to whose cultivation of philosophy in the midst of his political and agricultural pursuits the author bears friendly testimony. See *Memoir* by Sir Denis Le Marchant, Bart. (1876), Walter Bagehot's *Biographical Studies* (1881), and Ernest Myers' *Lord Althorp* (1890).—JOHN POYNTZ SPENCER, fifth earl, was born October 27, 1835, and was educated at Harrow and Trinity College, Cambridge. He had sat but a few months in the House of Commons for South Northamptonshire when the death of his father in 1857 sent him to the House of Lords. He was Lord-lieutenant of Ireland from 1868 to 1874, in 1880 became Lord-president of the Council, and during 1882-85 was Lord-lieutenant of Ireland. In the Liberal governments of 1886 and 1892 he was again President of the Council. He embraced Mr Gladstone's Home Rule policy, having during his tenure of office at Dublin Castle come to the conclusion that coercion was a failure.

Spencer, HERBERT, who has attempted to work out a complete system of philosophy in harmony with evolution and the results of modern science, was born at Derby, 27th April 1820. His father was a schoolmaster in that town, and secretary of the Philosophical Society; and from him Spencer imbibed that love of natural science

and wonderful faculty of observation so conspicuous in his works. The father was greatly interested in entomology; and Spencer himself used to collect, describe, and draw insects when a boy. Insurmountable aversion to linguistic studies put a Cambridge career out of the question, and at the age of seventeen he entered upon the profession of a railway engineer under Mr (afterwards Sir Charles) Fox, in London; but about eight years afterwards he gave up this profession, which lacked interest for him. He had already contributed various papers to the *Civil Engineers' and Architects' Journal*; and in the later half of 1842 he wrote a series of letters to the *Nonconformist* newspaper on 'The Proper Sphere of Government,' which were republished in pamphlet form in 1843. These letters imply a belief in human progress based on the modifiability of human nature through adaptation to its social surroundings, and maintain the tendency of these social arrangements 'of themselves to assume a condition of stable equilibrium.' From 1848 to 1853 he was sub-editor of the *Economist* newspaper; and at this time he developed the ethical and political consequences of the ideas he had already enunciated, and sought an independent basis for them. Hence his first important work, *Social Statics* (1850; abridged and revised, 1892). It is thus noticeable that Spencer's philosophical activity began with ethical and social questions. The conception of the evolution of man and society as determined by circumstances, and the idea that organic and social evolutions are under the same law, preceded the elaboration of those scientific ideas which, in the complete *System of Philosophy*, are made to serve as their basis. The truth anticipated by Harvey and Wolff, but first put into definite shape by Von Baer—'the truth that all organic development is a change from a state of homogeneity to a state of heterogeneity'—is regarded by Spencer as the organising principle of his subsequent beliefs. It was gradually developed and applied by him in a series of articles contributed in the following years to the *Leader*, the *North British*, *British Quarterly*, *Medico-Chirurgical*, *Westminster*, and other reviews.

In these essays, especially those on *The Development Hypothesis* (1852), *Manners and Fashion* (1854), *The Genesis of Science* (1854), and *Progress: its Law and Cause* (1857), and in the volume of *Principles of Psychology* (1855), the doctrine of evolution began to take definite form, and to be applied to various departments of inquiry. The publication of Darwin's *Origin of Species*, in 1859, gave a wide basis of scientific proof for what had hitherto been matter of speculation, and first showed the important part played by natural selection in the development of organisms.

In 1864 Spencer published an essay on the *Classification of the Sciences*, in which he criticised Comte's serial arrangement of the sciences according to generality, and substituted for it a classification according to abstractness: (1) *Abstract Science*, treating of the forms (space and time) in which phenomena are known to us—logic and mathematics; (2) *Abstract-concrete Science*, treating of the laws of the factors of the phenomena themselves—mechanics, physics, chemistry, &c.; (3) *Concrete Science*, treating of the phenomena in their totalities (the laws of the products)—astronomy, geology, biology, psychology, sociology, &c.

Upon this scheme of the sciences Spencer had now been working for several years. As early as 1860 he had announced the issue of a *System of Synthetic Philosophy*, already in course of preparation, which, beginning with the first principles of all knowledge, proposed to trace how the law of evolution was gradually realised in life, mind,

society, and morality. In pursuance of this comprehensive design Spencer has published *First Principles* (1862); *Principles of Biology* (2 vols. 1864-67); *Principles of Psychology* (2d ed. 2 vols. 1870-72); *Principles of Sociology* (3 vols. 1876-96); *Principles of Ethics* (2 vols. 1879). In the preface to the third volume of the *Sociology* (1896) completing the Synthetic Philosophy, the author explained that the two volumes of the original design had expanded to three; a fourth (Linguistic, Intellectual, Moral, Æsthetic) must remain unwritten by reason of age and infirmity.

These works follow a different plan from his earlier writings. In his occasional essays already referred to he proceeded by means of observation and induction; and in them the law of evolution was the result of a generalisation. But the method of his *System* is deductive; though the deductions, large and small, are always accompanied by inductive verifications. Even the law of evolution only finds a place in it because it can be deduced from a higher and ultimate principle. Just as certain special sciences—mechanics, for example—have already entered into the deductive stage, so, in Spencer's *System*, completely co-ordinated knowledge, to which he gives the name of philosophy, becomes deductive. Hence the importance of determining what is the ultimate test of truth. This, according to him, is the mental inconceivability of the negation of the proposition by the individual thinker. The validity of this test is supported, according to him, by two considerations: first, because no other test is obtainable, and secondly, by the consideration that mental inconceivability is the result of certain uniformities in our experience which are due to uniformities in nature. His appeal to this test, and the way in which he employs it, formed the subject of a controversy with J. S. Mill, and brings out the distinction between his method and principles and those of the empirical philosophy.

Metaphysically, Spencer's system is founded on the doctrine of relativity deduced by Hamilton and Mansel from Kant, but carried by him, as he says, a step further. Along with the definite consciousness of things known in relation to one another there is implied an indefinite consciousness of an absolute existence, in the recognition of which as inscrutable science and religion find their reconciliation. All definite consciousness or knowledge is of the manifestations of this unknowable power; and knowledge, completely unified, is philosophy. The data of philosophy are necessarily those organised components of our intelligence without which philosophising could not go on. 'Our postulates are: an unknowable power; the existence of knowable likenesses and differences among the manifestations of that power; and a resulting segregation of the manifestations into those of subject and object.' Within each segregated mass there are likenesses and differences involving secondary segregations. The modes of cohesion under which manifestations are invariably presented are called, when contemplated apart, space and time; when contemplated along with their manifestations, matter and motion. All these are traceable to experiences of that mode of consciousness whose reality is shown by its persistence—to force. By the 'persistence of force' is meant the unchanging quantity both of that mode of force which is revealed to us only by opposition to our own powers, and is not a worker of change, and of that mode which is a worker of change actual or potential, and is specifically termed energy. The persistence of force—i.e. the persistence of some cause which transcends our knowledge and conception—is the truth which all other truths imply, and from which they all (including the law of

evolution) are derived. From the fact that force can neither arise out of nor lapse into nothing follows the uniformity of law. Force never disappears; it is only transformed. Motion follows the line of least resistance, and is perpetually reversed within limits—is rhythmical. So far of the factors of phenomena. The phenomena themselves must be under a law of the concomitant redistribution of matter and motion, which holds of every change. The law of the entire cycle of changes passed through by every existence is loss of motion and consequent integration—i.e. evolution, eventually followed by gain of motion and consequent disintegration—i.e. dissolution. In its complete shape the 'formula of evolution' is thus stated: 'Evolution is an integration of matter and concomitant dissipation of motion; during which the matter passes from an indefinite incoherent homogeneity to a definite coherent heterogeneity; and during which the retained motion undergoes a parallel transformation.' This law of evolution applies equally to all orders of phenomena—astronomic, geologic, biologic, psychologic, sociologic, &c.—since these are all component parts of one cosmos, though distinguished from one another by conventional groupings. So long as evolution is merely established by induction it does not belong to philosophy. It must be deduced from the persistence of force. And this can be done. For any finite aggregate being unequally exposed to surrounding forces will become more diverse in structure; every differentiated part will become the parent of further differences; at the same time, dissimilar units in the aggregate tend to separate, and those which are similar to cluster together ('segregation'); and this subdivision and dissipation of forces, so long as there are any forces unbalanced by opposite forces, must end at last in rest; the penultimate stage of this process, 'in which the extremest multifariousness and most complex moving equilibrium are established,' being the highest conceivable state.

The various derivative laws of phenomenal changes are thus deducible from the persistence of force, and it remains to apply them to inorganic, organic, and super-organic existences. The detailed treatment of inorganic evolution is omitted from Spencer's plan (which is, he remarks, even too extensive without it), and he proceeds 'to interpret the phenomena of life, mind, and society, in terms of matter, motion, and force.'

It is impossible to give here any but the most general idea of the contents of the volumes in which the law of evolution is applied to these different departments. It is not only made to account for the phenomena within each group, but also for the connection between one science and another. The researches of Darwin had accumulated ample material for showing the continuity of development, structural and functional, in plants and animals; and Spencer's view of biology, and the definition of life he proposes ('the definite combination of heterogeneous changes both simultaneous and successive in correspondence with external co-existences and sequences'), are meant to show its connection both with inorganic changes on the one hand and with mind on the other. Now, just as biology has to deal with the connection between phenomena in the organism, and as physical science treats of the connection between phenomena in the environment, so psychology has to do with the connection between these two connections. For this is said to be the objective aspect of what states of consciousness are subjectively. The functions dealt with by the psychologist are more special than those dealt with by the biologist; but they belong to psychology, not merely because they are more special, but also

because they are the counterparts of the states of consciousness dealt with by the science of subjective psychology.

Objectively, an attempt is made to trace the evolution of mind from reflex action through instinct to reason, memory, feeling, and will, by the inter-action of the nervous system with its environment. Subjectively, mental states are analysed, and it is contended that all of them—including those primary scientific ideas, the perceptions of matter, motion, space, and time, assumed in the *First Principles*—can be analysed into a primitive element of consciousness, something which can only be defined as analogous to a nervous shock. These perceptions have now become innate in the individual. They may be called—as Kant called space and time—forms of intuition; but they have been acquired empirically by the race, through the persistence of the corresponding phenomena in the environment, and from the accumulated experiences of each individual being transmitted in the form of modified structure to his descendants.

This principle of heredity is one of the laws by which individuals are connected with one another into an organic whole; and we thus pass quite naturally to what Spencer calls super-organic evolution, implying the co-ordinated actions of many individuals, and giving rise to the science of sociology. Society, like an individual man, is shown to be an organism from the fact and laws of its growth, the nature of its activities, and the inter-dependence of its parts; though it is distinguished from the individual organism in this, that it is discrete, while the latter is concrete: 'there is no social sensorium.' As societies progress in size and structure, they work on one another profound metamorphoses, now by war-struggles and now by industrial intercourse.

Assisted by a series of elaborate ethnographical charts (*Descriptive Sociology*) prepared under his direction, Spencer has attempted to trace the development of human ideas, customs, ceremonial usages, and political institutions. The genesis of religion is traced to Ancestor-worship (q.v.), or generally to worship of the dead. The notion of another life—from which the notions of gods and God are gradually evolved—is originated mainly by 'such phenomena as shadows, reflections, and echoes—these being looked upon as indications of a 'double' or other self, which is not extinguished with the death of the first self. It is this fear of the dead which is the root of the religious control, just as it is the fear of the living which is the root of the political control. Ceremonies and institutions alike have their root in this fear of the stronger and submission to the conqueror. Thus, early communities being of the predatory or militant type, tended to centralised control; while industrial communities, which are now most frequent, should tend to free institutions and to the restriction of the sphere of government to the negative duty of preventing the interference of one individual with his neighbour's liberty. This principle of government—commonly expressed by the maxim *laissez faire*—is energetically enforced by Spencer, against the tendency of much recent legislation. A still higher type than the industrial is possible in the future, by inverting the belief that life is for work into the belief that work is for life; just as the industrial type inverts the belief that individuals exist for the state into the belief that the state exists for individuals.

The principles of morality are looked on by Spencer as the keystone of his system, all his other investigations being only preliminary to them. Ethics, he holds, has its root in physical,

biological, psychological, and social phenomena, for by them the conditions of human activity are prescribed and supplied. The best conduct is that which most fully realises evolution—which promotes the greatest totality of life in self, offspring, and the race—the balance of egoism and altruism being attained by a compromise between these contending principles. The measure of life is said to be pleasure, but the Utilitarian school are at fault in assuming that the end (greatest happiness) is better known than the means to it (morality); and in ignoring the fact that accumulated experiences of utility have become consolidated in the superior races into a moral sense.

In the above summary it has been impossible to give any idea of either the strength or weakness of the proof by which this elaborate system is supported. In general, it may be said that its strength lies in the author's brilliant power of generalisation, his acquaintance with many departments of science, and his unsurpassed wealth of illustration. The wide knowledge which all his writings display of physical science, and his constant endeavour to illustrate and support his system by connecting its positions with scientific facts and laws, have given his philosophy great currency among men of science—more so, indeed, than among philosophical experts. At the same time, not only have the development and application he has given to the theory of evolution profoundly influenced contemporary speculation and the recent developments of psychology and ethics, but he must also be regarded as one of the very few modern thinkers who have carried out the attempt to give a systematic account of the universe in its totality. The high opinion of his writings formed by foreign contemporaries has led to many academic honours being pressed upon him, which have, however, all alike been declined.

Spencer's most popular works have been a small volume on *Education* (1861), which has been translated into many languages, and *The Study of Sociology* (1872), which points out to the unscientific reader the difficulties of a social science. He has also written *The Man versus the State* (1884), and *The Factors of Organic Evolution* (1887). His occasional papers have been collected and published in three volumes of *Essays: Scientific, Political, and Speculative*. An *Epitome of the Synthetic Philosophy*, by F. Howard Collins, was published with Mr Spencer's authority in 1889 (1 vol.); there are criticisms of the system by Guthrie (1879 and 1882) and McCosh (New York, 1885); and the *Outlines of Cosmic Philosophy*, by John Fiske (2 vols. Boston, 1874), is based on Spencer's system. See also Fischer, *Ueber das Gesetz der Entwicklung* (1875); Michelet, *Spencers System der Philosophie* (1882), and *Spencers Lehre* (Leip. 1891); A. D. White, *Herbert Spencer: The Completion of the Synthetic Philosophy* (1897).

Spencer, WILLIAM ROBERT, minor poet, was second son of Lord Charles Spencer, himself the second son of that Charles Spencer, fifth Earl of Sunderland, who succeeded as third Duke of Marlborough in 1733. He was born in 1770, was educated at Harrow and Oxford, held a Commissionership of Stamps, spent his last ten years in Paris, and died there in 1834. Among his children were Aubrey-George Spencer, Bishop of Jamaica, and George-John-Trevor, Bishop of Madras. He was long a fashionable writer of *vers de société* and such like, but his fashionable verse is clean forgotten, and his name lives alone in a few simple songs and ballads, the chief 'Beth Géleret, or the Grave of the Greyhound.' Yet even these are but commonplace. His poems were collected, with a brief Memoir, in 1835.

Spencer Gulf, a deep inlet on the coast of South Australia, between Eyre's Peninsula on the W. and Yorke Peninsula on the E. It is 180 miles in length, by 90 in greatest breadth.

Spence's Metal is made by melting together a metallic sulphide, such as sulphide of iron (iron pyrites), along with sulphur. The result is a grayish-black substance, without metallic lustre, which takes a good polish. It can be coloured to imitate bronze and other metals, and as it melts at 320° F. it can readily be cast into moulds from which it takes a sharp impression. Busts, medallions, &c. have been made of it, and it is also used like lead for the joints of pipes. It is but slightly acted on by acids. First made in 1879, it is more of the nature of a hard cement than a metal.

Spener, PHILIPP JAKOB, an illustrious German reformer, and the founder of the movement known as *Pietism*, was born at Rappoltsweiler in Upper Alsace, January 13, 1635. Pious from his cradle, he studied at Strasburg, where in Johann Schmid he found his 'father in Christ.' Next he studied under the younger Buxtorf at Basel, afterwards visiting Geneva, Stuttgart, and Tübingen. In 1663 he became a preacher at Strasburg, and three years later was transferred to Frankfort, and here he laboured with the most devoted zeal to reawaken the dormant and mechanical Christianity of the day by constant catechising and earnest preaching based on Scripture and Christian experience. Yet Spener was the very opposite of what is commonly called a mystic. The devotion which he sought to excite was not to show itself in transcendental ecstasies, but in acts of piety, humility, and charity. He had a strong aversion to formal theology, which he considered a hateful caricature of the free word of life; and he commenced in the year 1670, at his house, meetings for the cultivation of evangelical morality. Out of these grew the famous *collegia pietatis*, whose influence for good on the German character, in those days of stony and barren orthodoxy, cannot easily be overvalued. His earnest and plain-spoken *Pia Desideria* (1675) spread the movement far beyond the range of his personal influence, but aroused the enmity of many in high places. In 1686 he became court preacher at Dresden and member of the Upper Consistory. Here he infused new life into the theological teaching of the university of Leipzig, despite the opposition of Carpov and others; but, having in 1689 rebuked the Elector Johann Georg III. for his vices, he soon found his position so intolerable that he gladly accepted an invitation to Berlin to become Provost of the church of St Nicholas and consistorial inspector, offices which he retained to the end of his life. The Elector of Brandenburg encouraged his efforts after religious reform, and entrusted theological instruction in the new university of Halle to Francke, Breithaupt, Anton, and other disciples of Spener—the later leaders of the pietistic movement. This excited great irritation in the theological faculties of Wittenberg and Leipzig, which formally censured in 1695 as heretical no less than 264 propositions drawn from Spener's writings. Spener died at Berlin, February 5, 1705, leaving behind a reputation for piety, wisdom, and practical Christian energy which all the excesses of the later pietists have not obscured. Indeed Ritschl (*Gesch. des Pietismus*) maintains that he himself was not a Pietist, having no part in their characteristic quietist and separatist instincts.

His writings are numerous; the chief are *Pia Desideria* (1675), *Das geistliche Priesterthum* (1677), *Christliche Leichenpredigten* (13 vols. 1677), *Des thätigen Christenthums Nothwendigkeit* (1679), *Klagen über das verdorbene Christenthum* (1684), *Evangelische Glaubenslehre* (1688), and *Theologische Bedenken* (5 vols. 1700-2). See J. G. Waloh, *Religionsstreitigkeiten der Lutherischen Kirche* (5 vols. 1730-39); the Lives by Hossbach (1828; 3d ed. 1861), Thilo (1841), Wildenhalm (1847; trans. by Wenzel, Phila. 1881), and Grünberg (1892-97).

Spennymoor, a town of Durham, 4 miles N.E. of Bishop Auckland, with iron-foundries and coal-pits. Pop. (1851) 659; (1891) 6041.

Spenser, EDMUND, one of the chief Elizabethan poets, was, as we learn from the *Prothalamion* (one of his minor poems), born in London, probably in East Smithfield near the Tower. From one of his *Amoretti* the date of his birth can with fair certainty be concluded to be 1552. As to his family, there are many indications that he was well connected, though his circumstances were poor. He speaks of himself as taking his name from 'an house of ancient fame,' and also of 'the noble familie, of which I meaneest boast myself to be.' This noble family was that of the Spencers of Althorp. With the ladies of it he associates several of his poems. Thus in the dedication of *The Teares of the Muses* to the Lady Strange (in honour of whom in her old age it is interesting to notice Milton's *Arcades* was composed) he writes: 'The causes for which ye have thus deserved of me to be honoured (if honour it be at all) are both your particular bounties, and also some private bands of affinitie, which it hath, pleased your Ladship to acknowledge.' But in what degree he was connected with the Althorp Spencers has not yet been ascertained; it seems clear it was not a close relationship. What is fairly certain is that the poet's branch of the family belonged to the neighbourhood of Burnley in east Lancashire. Possibly his father came from Hurstwood, near Burnley. Gabriel Harvey, an intimate friend of Spenser's, speaks of Lancashire as Spenser's county; and there is much corroborative evidence of that statement to be drawn from the poet's own works as well as from the Burnley parish registers. But, however 'good' his family, Spenser's father was by no means well-to-do. It is conjectured that he was at one time 'a free journeyman' in the 'arte or mysterie of clothmakyng.' It is certain that his pecuniary means were so limited that in the education of his son, or sons, he was glad of assistance, and that even with assistance the poet went up to the university as a 'sizar.' So from the beginning Spenser did not enjoy worldly prosperity; from the beginning the saying of one of his admirers applies: 'Poorly, poor man, he lived; poorly, poor man, he died.' Of his mother nothing whatever is at present known, except that her Christian name was Elizabeth (*Amoretti*, lxxiv.).

His life appears to have been spent in London till his going up to Cambridge in 1569. The publication of 'The Spending of the Money of Robert Nowell of Reade Hall, Lancashire, brother of Dean Alexander Powell, 1568-1580,' has informed us that he was sent to the Merchant Taylors' School, then newly founded. He is first mentioned in those accounts as one of six 'poor scholars' of the Merchant Taylors' School, to whom the generous squire gave stuff for gowns. Thus Spenser would be a pupil of Mulcaster, though it was certainly not from him he learned to write English—unless indeed Mulcaster's theory was a great deal better than his practice, the style of his *Positions* being singularly affected and discommendable.

The Merchant Taylors' School was directly associated with Pembroke Hall (now College) at Cambridge; and in May 1569 Spenser duly proceeded from one to the other. Nowell's beneficence still attended him. Both at 'his going to Pembroke Hall' and twice at least while there he received presents. And these with the benefits of a sizarship must have reduced his university expenses to an amount which can have been no great burden to his father and family. As a scholar he does not seem to have specially distinguished himself at Cambridge. Perhaps, like Wordsworth two centuries later, he did not feel

himself 'of that hour or that place.' There are traces of some friction between him and the authorities. But it is evident from his works that by the time he quitted the university in 1576 he had obtained a considerable acquaintance with both Latin and Greek literature. And he had made friends of note, who highly appreciated his genius; amongst them Gabriel Harvey and Edward Kirke.

And now what to do? He seems to have had no definite programme or prospect. He stayed for some months at least—perhaps for some two years—with his relations near Burnley, probably waiting on fortune. But this time was not all wasted; he had the experience of an unsuccessful love-suit; he pondered many questions of the day; and he perfected his metrical skill. The *Shepherds Calendar* was the result. And its publication in 1579 made an epoch in English literature. It was the first clear note of the great Elizabethan poetry. His contemporaries heard it with delight, and at once acknowledged its freshness and its charm.

Probably the year before its publication, or even in 1577—if, as words of his own seem certainly to prove, he was in Ireland that year—Spenser had gone south again, and had won the friendship of Sir Philip Sidney, to whom it was dedicated. How exactly he passed into the Sidney circle and became at home at Penshurst has not yet been made out. Possibly Gabriel Harvey was able to introduce him to the Earl of Leicester, who was Sir Philip's uncle. However this may be, Leicester and Sidney proved good patrons, and his friendship with the latter was one of the great events of his life (see *Astrophel, Ruins of Time*, &c.). And no doubt it was through Leicester's influence that in 1580 Spenser, long anxious for some employment or 'place,' was appointed private secretary to Arthur Lord Grey de Wilton, himself just appointed Lord Deputy of Ireland.

Ireland was thenceforward to be his home, little probably as such an issue of his secretaryship was expected, and eager as were his hopes and efforts to obtain some preferment in England. We cannot wonder that Spenser was ill content with his lot. The country was in rebellion when he arrived in it. The special mission of Lord Grey was to suppress the combined insurrection of the O'Neils in the north and the Fitzgeralds in the south, assisted by certain Spaniards who had lately fortified themselves at Smerwick in Kerry, a mission executed with a severity so merciless as to lead to his recall in 1582. Strange and fearful sights were presented to the young poet's eyes, of massacre, of desolation, of utter misery. The evil condition of things is vividly illustrated in Spenser's *View of the Present State of Ireland*—a work of ripe, however bitter, experience, and inspired by long and shrewd observation, written probably in the second decade of his Irish residence, and largely circulated in MS., though not printed till 1633. He strongly advocated the policy of strict repression and suppression. No wonder the natives loved Spenser as little as Spenser loved them. To this day, it is said, the peasants of Cork county remember him with detestation. However, it was in Ireland the unfortunate man was to pass his life, except for some two visits and a terror-stricken flight to England. Before his patron's recall he was already forming fresh connections with the country. In 1581 he was appointed Clerk of Degrees and Recognisances in the Irish Court of Chancery. In 1588 he became Clerk to the Council in Munster. Probably in this latter year he took up his abode at Kilcolman Castle near Doneraile, County Cork, though the grant of it and adjacent lands is dated October 26, 1591. He was certainly settled there in 1589, as we learn from himself in his *Colin Clout's Come*

Home Again. His occupancy of a part of the forfeited estates of the Earl of Desmond must have stimulated the native hatred towards him; and it was probably already keen. Certainly he did much to further excite it by the rigour with which he pressed his rights or supposed rights. In one case at least it would seem that he pressed them too far. 'Edmond Spenser of Kilcolman, gentleman,' was ordered by the Lord Chancellor of Ireland to retire from 'three ploughlands, parcel of Ballingerath,' which he had 'entered,' disseising Lord Roche, Viscount Fermoy, thereof, and making 'great waste of the wood of the said land,' and converting 'a great deal of corn growing thereupon to his proper use, to the damage of the complainant of two hundred pounds sterling' (some £900 of our money).

But all this time, amidst all these enmities and horrors, Spenser was going on with his great poem, which, as we know from a letter of Gabriel Harvey's, had been begun before he crossed St George's Channel. The ninth canto of the second book is the first passage that pretty certainly points to his being in Ireland; and all the rest of it that was written was written in Ireland. In his sonnet to Lord Grey he describes his great work as

Rude rymes the which a rustick Muse did weave
In savage soil far from Parnasso Mount,
And roughly wrought in an unlearned loome.

In an interesting account given by his friend Lodovick Brisket of a party assembled at his cottage near Dublin in or about the year 1586, Spenser is reported as mentioning that he had already undertaken a work of ethical purpose 'which is in heroic verse under the title of a *Faerie Queene*,' and that he has 'already well entered into' it. By the year 1589 the first three books were finished, and in that year were shown to Sir Walter Raleigh, whose acquaintance Spenser had probably made some years before (they had certainly met at Smerwick in 1580, if not earlier), and who at this time was in some sort a neighbour, he too having a share (a large one) in the Desmond forfeiture and residing just then at Yonghal. Of Raleigh's visit to Kilcolman in 1589 and its result in a journey to England and the English court Spenser gives a charming account in his *Colin Clout's Come Home Again*, written immediately after his return in 1591, though not published till 1595, and then slightly revised that it might be in its allusions more nearly 'up to date.' He and his poem were warmly welcomed. In 1590 the three books were published, and there arose a demand for other works of his, which was presently met by the publication of *Sundry Poems*, nine in number, some probably of early composition (as *Prosopopoeia* or *Mother Hubberds Tale*, and in the main *Bellay's Visions* and *Petrarch's*), others written quite recently (as *The Ruins of Time* and *The Tears of the Muses*). But no place was found for him at the court or in London. Lord Leicester and Sir Philip Sidney were no longer on the scene to support him; and so once more to Ireland.

However, immense fame was his, if nothing of official or pecuniary advantage; and he devoted himself anew to his great work. Its course was interrupted by another great love-passion, of which he describes the various stages from despair to hope and to triumph in his *Amoretti* and his *Epithalamion*. The lady's Christian name was Elizabeth, as we learn from one of the courtship sonnets; her surname is very plausibly conjectured to have been Boyle. His happiness overflows even into the *Faerie Queene*. In book vi. canto x. his lady-love is introduced as a fourth Grace, and is described with much rapture. Finishing now the second three books, and perhaps proudly accompanied by his bride, he paid another visit

to England. In 1596 was published the second and last instalment of the *Faerie Queene*, except a fragment consisting of two cantos and two stanzas. For a time he was the guest of Lord Essex; and under his roof, once that of Lord Leicester, he composed what is probably his last complete poem, *The Prothalamion, or a Spousal Verse*. Even in this song of congratulation and joy his anxiety and distress find expression. He speaks of himself as one

Whom sullen care,
Through discontent of my long fruitless stay
In Prince's Court, and expectation vain
Of idle hopes which still do fly away
Like empty shadows, did afflict my brain

(his emotion overpowering his grammar), and of his 'friendless case.' But again his suit obtained no success; and again he turned his face to the country, not of his choice, but of his necessity.

Meanwhile in that unhappy island a fresh storm had been gathering, and in 1598 burst furiously on the head of the unpopular occupant of Kilcolman. One of the first exploits of the new insurrection (that under Hugh O'Neil) was to fire Spenser's castle; and he and his had to flee for their lives. About the close of 1598 or the beginning of 1599 he reached London homeless, destitute, exhausted. On January the 13th (not the 16th, as is usually said; see John Chamberlain to Sir Dudley Carlton, January 17, 1599) he died at a tavern in King Street, Westminster, certainly in distressed circumstances, if not, as Ben Jonson stated to Drummond, and we would fain not believe, 'for lack of bread.' At least in his last resting-place he was happy; he was laid by Chaucer—by him who taught him his songs, as he was proud to say—in the south transept of Westminster Abbey. And, if admiration and fame were or are any compensation for his adverse fortunes, such compensation was and is his in no slight measure. His wealth of language, his fine sense of melody, his abundance of fancy, his ardent patriotism, his profound sympathy with all things lovely and of good report gave him at once and have retained for him a foremost position in English literature. It is his special and his supreme distinction to be known, and with good reason, as the 'Poet's Poet.'

See editions by Todd (8 vols. 1805) and A. B. Grosart (10 vols. 1882-84); of the Poems, the Aldine edition, with *Life* by Collier, and the Globe edition, with Memoir by the present writer; Dean Church's *Spenser* and J. A. Symonds' *Sidney* in 'English Men of Letters'; Craik's *Spenser and his Poetry* (3 vols. 1845); Sir John Pope Hennessy's *Sir Walter Raleigh in Ireland* (1883); Dean Kitchin's *Faerie Queene* (books i. and ii.).—The 'Spenser Society,' founded 1867-68, has printed works of Heywood, Taylor the Water-poet, Wither, Drayton, &c.

Spermaceti is a waxy matter obtained mixed with oil from the head of the sperm-whale, *Physeter macrocephalus*. The mass obtained from an ordinary sized whale would fill twelve barrels. It is purified by draining off the oil and repeatedly washing with hot water and weak boiling potash-lye. It is in white, pearly, semi-transparent masses, somewhat unctuous to the touch, lighter than water, and melting a little above 100° (38° C.). It is insoluble in water, but soluble in ether, chloroform, &c. Medicinally it is no longer given internally, but it is an ingredient of many ointments, to which it gives a crystalline appearance. Chemically it is almost pure cetyl palmitate, but contains small quantities of other fats. See WHALE.

Spermatozoa, the male reproductive cells of animals, the physiological complements of the egg-cells or ova. See EMBRYOLOGY, REPRODUCTION.

Sperryllite, the name given to an arsenide of platinum (PtAs₂) discovered in 1888 in the province of Ontario, Canada.

Speusippus (B.C. 394-336?), an Athenian philosopher, who, after the death of his uncle Plato, became head of the Platonic school or Older Academy. Of his philosophical works, in which he taught a doctrine differing but little from Plato's, nothing is left but titles and fragments.

Spey, a river of Scotland, rising at an altitude of 1500 feet above sea-level and running 107 miles north-eastward through or along the boundary of Inverness, Elgin, and Banff shires, until it falls into the Moray Firth at Kingston between Lossiemouth and Portknockie. The Dulnain and Avon are its principal tributaries. The salmon-fisheries, belonging to the Duke of Richmond, at its mouth, above which comparatively few fish penetrate, have a yearly value of from £8000 to £10,000; else the Spey is almost without value, nor can it generally be called a picturesque stream. It has the swiftest current of all the large rivers in Britain, and is subject to sudden and violent freshets, resulting at times in disastrous inundations. See Sir Thomas Dick Lauder's *Moray Floods* (1830); and A. E. Knox, *Autumn on the Spey* (1882).

Speyer. See SPIRES.

Spezia, the principal naval port of Italy, stands near the head of a deep and commodious bay on the west side of the peninsula, 56 miles SE. of Genoa by rail. It was Napoleon I. who first recognised the suitability of this bay for the purposes to which the Italians, instigated thereto by Cavour, have now put it. An artificial break-water (built in 1860), 2400 feet long, covers the entrance; whilst formidable batteries of the heaviest artillery (supplemented by torpedo appliances) bristle on the hills that overlook the bay and on the island of Palmaria that guards its entrance. Here the Italians have constructed the great national arsenal, and build their large war-ships, and have their ship-repairing yards and docks, and their naval victualling yards, store-houses, and so forth. Some of these, however, are at San Bartolomeo, on the opposite shore of the bay. There are also in the town large barracks, a military hospital, schools of navigation, an iron-foundry, and manufactures of cables, sail-cloth, and white-lead. The adjacent country produces excellent olive-oil. The beauty of the bay and the lovely climate cause Spezia to be much frequented as a seaside resort. It was on the shores of this bay that Shelley spent the last few months of his life, while at the town of Spezia Charles Lever was consul for ten years. Pop. (1861) 6105; (1881) 19,864; (1895, estimated) 23,500.

Spezzia (or *Spetsai*; ancient *Pityussa*), a Greek island at the entrance to the Gulf of Nauplia. Area, 6½ sq. m.; pop. 7000, mostly in the town of Spezzia, which has a good harbour.

Sphacteria, the small island that closes in the bay of Navarino (q.v.).

Spharo-siderite, impure earthy or concretionary varieties of carbonate of iron.

Sphagnum, a genus of Mosses, whose sporocase is an urn closed by a deciduous lid, and its brim toothless, the calyptra irregularly torn. Several species are natives of Britain, and are common in bogs, from which they derive their popular name, *Bog Moss*. They are remarkable for the whitish colour of their leaves. They are very elegant plants. They often grow in considerable masses, absorbing water like a sponge, but becoming friable when dry. They contribute much to the formation of peat. Gardeners employ them in preference to other mosses for covering the roots of plants and keeping them moist, as they have in a high degree the property of absorbing moisture from the atmosphere. They have been

used as food. The leaf-cells have a spiral structure and large pores in their sides. See MOSSES; and Braithwaite's *Sphagnaceae* (1880).

Sphakia, a small port (pop. 600) on the south coast of Crete, 60 miles SE. of Canea. The name of Sphakiots is, however, given to all the highlanders in the mountains to the north, always distinguished for their bravery in anti-Turkish risings.

Sphene. See TITANIUM.

Sphenodon, or HATTERIA, the representative of a distinct reptilian order—Rhynchocephalia—which in Permian and Triassic times included several genera. Now there is only one species—*Sphenodon*, or perhaps better *Hatteria punctata*—the Tuatara

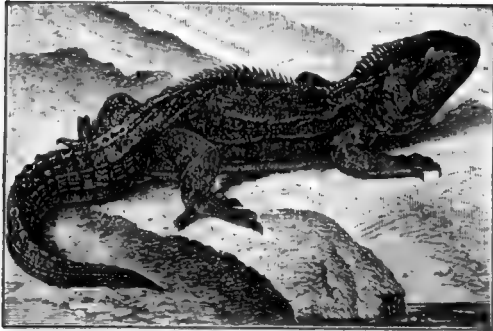

Fig. 1.—*Sphenodon* (*Hatteria punctata*).

of the Maoris. It was formerly abundant along the coasts of New Zealand, but is now restricted to a few small islands in the Bay of Plenty, both the Maoris and the hogs being blamed for its rapidly increasing rarity. In all likelihood it will soon be exterminated, and one of the most interesting of 'living fossils' will be lost.

In appearance the Hatteria is like an Iguana; on the upper surface the general colour is 'dull olive-green spotted with yellow,' on the under surface whitish; the tail is compressed from side to side and dorsally crested, brittle and replaceable as in many of the genuine lizards. The maximum length of the animal seems to be about two feet, but smaller forms are commoner. Nocturnal in its

habits, the Hatteria lives in holes among the rocks or in small burrows, and feeds on small animals.

But the chief peculiarities of this old-fashioned reptile are internal, and cannot be stated except in technical language. The vertebrae are biconcave like those of most fishes, as is also the case in geckos among lizards and in many extinct reptiles. Some of the ribs bear uncinatè processes as in birds and crocodiles. As in crocodiles there are 'abdominal ribs,' or ossifications in the fibrous tissue beneath the skin of the abdomen.

The skull, unlike

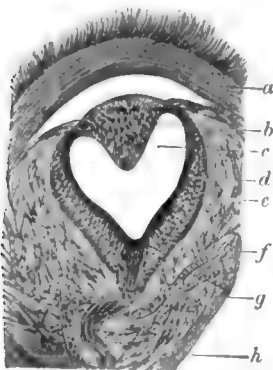

Fig. 2.—Section of Pineal Eye of *Hatteria* (after Baldwin Spencer):

a, a connective-tissue capsule beneath the skin; b, the lens; c, the cavity of the eye; d, e, layers of the retina; f, blood-vessels; g, h, stalk.

that of any lizard, has an ossified quadrato-jugal, and therefore a complete infra-temporal arcade;

the quadrate is immovably united to pterygoid, squamosal, and quadrato-jugal; the pterygoids meet the vomer and separate the palatines. There are teeth on the palatine in a single longitudinal row, parallel with those on maxilla and mandible, and the three sets seem to wear one another away; there is also a single tooth on each side of a sort of beak formed from the premaxille.

It was in Hatteria first that Baldwin Spencer discovered what seems to be the secret of the pineal body. This structure occurs in all Vertebrates, except the very lowest, at the end of an upgrowth from the 'tween brain or optic thalami. Its import remained for long an enigma. But in Hatteria the pineal body reaches the skin on the top of the head, and retains distinct traces of an eye-like structure—for instance a complex retina. As the same vestigial hint of eye-structure has since been seen in several lizards, many naturalists are confident that the pineal body should be called a pineal or parietal eye, and regarded as a persistent vestige of a median, unpaired, upward-looking sense-organ. See PINEAL GLAND.

Near the living Hatteria the Permian Palæohatteria, the Triassic Hyperodapeton, and some other important extinct types must be ranked. Nearly allied too is the remarkable Proterosaurus from the Permian. There is no doubt that the order Rhynchocephalia once included several generalised types, of which Hatteria now alone remains. It is much to be desired that the development of this animal be studied before it also disappears.

Sphenoid Bone. See SKULL.

Sphere, a surface of which every point is equally distant from a definite point known as the centre. It may be described by the rotation of a semicircle (or circle) about its diameter. From every aspect a sphere has the same appearance. Every plane section is a circle—a *great circle* if the cutting plane contains the centre of the sphere, a *small circle* in all other cases. The shortest line that can be drawn on the surface so as to join any two points must be an arc of the great circle passing through these two points. If r is the radius of the sphere its volume is $\frac{4}{3}\pi r^3$ and its surface is $4\pi r^2$. These are intimately related to the volume and curved portion of the surface of the circumscribing cylinder, whose height is equal to the diameter of the sphere. The volumes are as two to three, and the surface areas, so defined, are equal.

Spheroids are species of Ellipsoids (q.v.), and are represented by the same equation. If an ellipse be made to revolve round one of its axes, the curved outline of the ellipse describes the spheroid. Should the major or longer axis be the axis of revolution the spheroid is said to be *prolate*, but if the minor or shorter axis, *oblate*. The Earth (q.v.) is very approximately an oblate spheroid.

Spherometer is an instrument for measuring the sphericity of portions of spherical surfaces—for example, lenses. It rests on three pointed legs, whose points form an equilateral triangle. Midway between these is a fourth leg, which can be screwed up or down as desired through a distance measured by the number of turns given to it. After the spherometer is adjusted on any spherical surface till the four legs are all in contact with the surface it is lifted on to a plane surface and the middle leg screwed up or down until the four legs all lie on the plane. Thus we measure the height of the segment whose base is the circle passing through the equilateral triangle mentioned above, and can by a simple calculation find the radius of the spherical surface. The instrument may also be applied to measure the thicknesses of plates small enough to be pushed within the legs.

Spherical Aberration. See LENSES, and MIRROR.

Spheroidal Condition of liquids is the name usually given to a series of very singular phenomena discovered by Leidenfrost (1715-94), but first carefully investigated by Boutigny (1858). Indeed one, at least, of those phenomena has been popularly known for a very long time, being the foundation of the rough practical method of determining whether or not a flat-iron is so hot as to be likely to singe the linen to which it is to be applied. The test consists simply in letting a drop of water fall upon the iron. The drop will either glance off the surface without wetting it or will spread over the surface and evaporate, according as the iron is or is not too hot.

The common experimental method of exhibiting the spheroidal condition is easily performed thus: A metallic disc, slightly concave, like a watch-glass, is heated by a lamp, and water is cautiously dropped on it from a pipette. If this be done before the disc is sufficiently heated the water boils almost explosively, and is dispersed at once in vapour. But when the disc is



hot enough the water remains suspended, as shown in the cut, above the surface; and the drop, when small, takes nearly the form of an oblate spheroid. The most curious fact connected with the experiment is that the water does *not* boil. In fact it evaporates so freely that the heat carried off from it, as latent heat, by the vapour which is constantly formed keeps its temperature somewhere about 206° F. only. Boiling water, dropped on a red-hot plate of metal, instantly assumes the spheroidal state, and is cooled six degrees below boiling. Other liquids, and even some bodies which are solid at ordinary temperatures, can be easily brought into the spheroidal state—the lowest requisite temperature of the disc being dependent on the boiling-point of the substance. A good example of a solid entering this state is furnished by dropping crystals of iodine on a hot platinum disc. It is not necessary that a metal plate be used. For example, a watch-glass will suffice for the experiment; but hot water must be dropped on it, else the glass will crack. Also we may obtain ether, and even water, in the spheroidal state over the surface of hot oil. The explanation of the phenomenon is to be sought for in the existence of a cushion of vapour between the hot plate and the drop. The high temperature of the plate causes a rapid evaporation of the lower surface of the drop. The vapour particles coming into contact with the hot plate are raised in temperature, that is, have their kinetic energy increased. They tend to rebound with increased energy back upon the drop, whose weight they are thus able to support.

An interesting illustration of the spheroidal state is the fact that the hand may be dipped for a short time with impunity into melted lead, and even into melted copper. The vapour instantly raised from the moisture of the skin prevents, so long as that moisture lasts, more than an endurable amount of radiant heat from reaching the hand, and also prevents direct contact.

Spherulitic Structure. See PETROGRAPHY.

Sphex, a genus of hymenopterous insects of the family Sphegidae, closely allied to the true Wasps (Vespidae). The Sphex wasps are solitary in habit, and there are no workers as in the social forms. The female hollows out, at the end of a long passage, three or four chambers, in each of which she deposits an egg and a store of food for the larva she will never see. The food consists of grasshoppers or other insects, and Fabre gives a minute account of the way in which the Sphex

attacks her victim, and, after a long and violent struggle, throws it on its back and stings it in the neck and between the thorax and abdomen, each time piercing a ganglion. The insect, completely paralysed, but alive, and therefore not liable to putrefaction, is then dragged to the mouth of the nest, where it is relinquished for a short time, while the wasp enters alone to see that all is right. So automatic is this habit of reconnoitring that if the grasshopper be removed to a little distance the wasp drags it back to the same spot and again enters alone. This was tested by the observer forty times in succession, and each time the wasp paid her preliminary visit of inspection. But, in proof that she is not wholly the slave of habit, it should be noted that when Fabre substituted a fresh grasshopper for the paralysed one she at once perceived the difference, and proceeded to attack and sting her recalcitrant victim. Four paralysed insects are placed in each chamber, which is sealed up as it is finished. When all are full the mouth of the passage is also closed, and the nest is abandoned. See WASP.

Sphincter Muscles (Gr. *sphinkter*, 'that which binds tight') surround an opening or canal which, by their action, they are able to close or diminish in size. They are found round the mouth, the opening between the eyelids, round the pupil of the eye, the pylorus of the stomach, the outlet of the urinary bladder, and the anus. It is to the presence of these muscles that the higher animals owe the power of retaining for a considerable period the excrementitious matters collected in the bladder and rectum, and of discharging them at intervals, the sphincter muscles being, like those engaged in the process of respiration, mainly, but not entirely, under the control of the will.

Sphinx, a Greek word signifying the 'strangler,' applied to certain symbolical forms of Egyptian origin, having the body of a lion, a human or an animal head, and two wings. Various other combinations of animal forms have been called by this name, although they are rather griffins or chimeras. Human-headed sphinxes have been called androsphinxes; that with the head of a ram, a criosphinx; and that with a hawk's head, a hieracosphinx. The form when complete had the wings added at the sides; but these are of a later period, and seem to have originated with the Babylonians or Assyrians. In the Egyptian hieroglyphics the wingless Sphinx bears the name of *Neb*, or Lord, and *Akar*, or Intelligence, corresponding to the account of Clement that this emblematic figure depicted intellect and force. Others see in it the idea of resurrection, symbolised by the triumph of the dawn over the darkness of night. The idea that it allegorised the overflow of the Nile when the sun was in the constellations Leo and Virgo appears to be unfounded. In Egypt the Sphinx also occurs as the symbolical form of the monarch considered as a conqueror, the head of the reigning king being placed upon a lion's body, the face bearded, and the usual head-dress. Thus used, the Sphinx was generally male; but in the case of female rulers the figure has a female head and the body of a lioness.

The most remarkable Sphinx is the Great Sphinx at Gizeh (Giza), a colossal form hewn out of the natural rock, and lying about a quarter of a mile south-east of the Great Pyramid. It is sculptured out of a spur of the rock itself, to which masonry has been added in certain places to complete the shape, and it measures 172 feet 6 inches long by 56 feet high (Vyse, *Pyramids*, iii. 107). Immediately in front of the breast Cavaglia found in 1816 a small naos or chapel, formed of three hieroglyphic tablets, dedicated by Thothmes III. and Rameses

II. to the Sphinx, whom they adore under the name of Haremkhu, or Harmachis, as the Greek inscriptions found at the same place call it—i.e. the Sun on the Horizon. These tablets formed three walls of the chapel; the fourth, in front, had a door in the centre and two couchant lions over it. A



Great Sphinx at Gizeh.

small lion was found on the pavement, and an altar between its fore-paws, apparently for sacrifices offered to it in the time of the Romans. Before the altar was a paved causeway or dromos, leading to a walled staircase of thirty steps, repaired in the reign of M. Aurelius and L. Verus on the 10th May 166 A.D. In the reigns of Severus and his sons, 199-200 A.D., another dromos, in the same line as the first, and a diverging staircase were constructed, while some additions had been made to the parts between the two staircases in the reign of Nero. Votive inscriptions of the Roman period, some as late as the 3d century, were discovered in the walls and constructions; and on the second digit of the left claw of the Sphinx an inscription in pentameter Greek verses, by one Arrian, probably of the time of Severus, was discovered. In addition to these walls of unburnt brick, galleries and shafts were found in the rear of the Sphinx extending northwards. The excavations of M. Mariette in 1852 threw further light on the Sphinx, discovering that it was surrounded by a peribolos or outer wall; and showing that the head only was sculptured; that the sand which had accumulated round it was brought by the hands of man and was not an encroachment of the desert; and that the masonry of the belly was supported by a kind of abutment. To the south of the Sphinx Mariette found a dromos which led to a temple of the time of the fourth dynasty, built of huge blocks of alabaster and red granite. In the midst of the great chamber of this temple were found seven diorite statues, five mutilated and two entire, of the monarch Chafra or Chephren, which are fine examples of the oldest Egyptian sculpture. While the dignity and grandeur of the Great Sphinx have often attracted the admiration of travellers (see SCULPTURE, p. 264), its age has always remained a subject of doubt; but these later discoveries prove it to have been a monument of at least the age of the 4th dynasty, or contemporary with the pyramids, and Maspero regards it as anterior even to Menes.

Besides the Great Sphinx, avenues of Sphinxes have been discovered at Sakkara, forming an ap-

proach to the Serapeum of Memphis and elsewhere. Sphinxes of the time of the Shepherd dynasty have been found at Tanis, and another of the same age is in the Louvre; while a granite Sphinx, found behind the 'vocal Memnon,' and inscribed with the name of Amenophis III., is at St Petersburg. An avenue of criosphinxes, each about 17 feet long, is still seen at Karnak, and belongs to the time of Horus, one of the last monarchs of the 18th dynasty. Various small Sphinxes are in the different collections of Europe, but seldom are of any very great antiquity.

The Theban Sphinx of Greek legend, whose myth first appears in Hesiod (*Theog.* 326), is described as having a lion's body, female head, bird's wings, and serpent's tail, ideas probably derived from Phœnician sources. She was said to be the issue of Orthros, the two-headed dog of Geryon, by Chimæra, or of Typhon and Echidna, and was sent from Ethiopia to Thebes by Hera to punish the transgression of Laius, or, according to other accounts, by Dionysus or Ares (see EDIPUS). The Sphinx was a favourite subject of ancient art, and appears in reliefs, on coins of Chios and other towns, and often as a decoration of arms and furniture.

In Assyria and Babylonia representations of Sphinxes have been found, and the same are not uncommon on Phœnician works of art.

Sphinx. See HAWK-MOTH.

Sphygmograph, an instrument for indicating changes of tension in the blood in an artery; practically a pulse-recorder. It was invented by Vierordt, and perfected in 1863 by M. E. J. Marey of Paris. When the instrument is applied to an artery a moving point traces a record on a band of paper moved by clockwork. A sphygmophone is a sphygmograph combined with a microphone. A sphygmoscope renders the pulsations visible. See works by J. B. Sanderson (1867), Dudgeon (1882), Bramwell (1883), and Keyt (1887).

Spice Islands. See MOLUCCAS.

Spices (Lat. *species*, 'kinds;' in later Latin, kinds of goods, or produce in general; and then the most highly prized kind of goods, the aromatic productions of the East), aromatic and pungent vegetable substances used as condiments and for flavouring food. They are almost exclusively the productions of tropical countries. In ancient times and throughout the middle ages all the spices known in Europe were brought from the East; and Arabia was regarded as the land of spices, but rather because they came through it or were brought by its merchants than because they were produced in it, for they were really derived from the farther east. They owe their aroma and pungency chiefly to essential oils which they contain. They are yielded by different parts of plants; some, as pepper, cayenne pepper, pimento, nutmeg, mace, and vanilla, being the fruit or particular parts of the fruit; whilst some, as ginger, are the root-stock; and others, as cinnamon and cassia, are the bark. Tropical America produces some of the spices, being the native region of cayenne pepper, pimento, and vanilla; but the greater number are from the East.

Spicheren, or SPEICHERN, a village on the frontiers of Prussia and Lorraine, 2 miles S. of Saarbrück. Here on 6th August 1870 was fought a bloody battle between the French and Germans, in which the former were defeated. See FRANCE,

Vol. IV, p. 782; and the work on the battle by Major Henderson (1892).

Spider-crab. See CRAB.

Spider-fly (*Ornithomyia*), a genus of dipterous insects closely allied to the Forest-fly, but parasitic on birds, not on quadrupeds. Thus, *O. avicularia* frequently infests the common fowl, the blackcock, and other birds in Britain. It is greenish yellow, with smoke-coloured wings.

Spider-monkey, a name given to an American genus of monkeys, *Ateles*. These monkeys have no thumb, or it is rudimentary. They occur only in South America, Mexico, and Central America. The popular name has been given to them on account of their long, slender limbs. Like

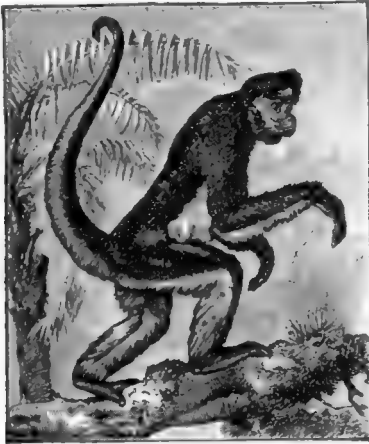

Spider-monkey (*Ateles Bartlettii*).

other New-World monkeys (Platyrrhini), they have a prehensile tail, and are naturally purely arboreal in habit. Although denizens of the tropical forests of the New World, they can, like the tropical apes of the Old World, endure a very considerable amount of cold. One species, *A. vellerosus*, lives in large companies in forests at a height of 7000 feet in Mexico. The Coaita is the *A. paniscus*. About fourteen species of the genus are known.

Spiders (*Araneidae*) form an order within the heterogeneous class Arachnida. The name, which seems to be a corruption of *spinther*, refers to the well-known spinning powers which these animals so cleverly exercise. They are found almost everywhere upon the earth, especially in warm countries, and are of much importance in checking the multiplication of insects. A few tropical forms, notably the bird-catching spiders, exceed two inches in length of body, but the majority measure only some fraction of an inch.

Structure and Functions.—The body is divided into two distinct parts—an unsegmented cephalothorax, bearing six pairs of appendages, and a soft unsegmented abdomen, at the end of which are the spinnerets. On the skin there are hairs of various kinds, some being specialised as sensitive structures. The colours, which are often very brilliant, are due in part to pigments occurring in the tissues, or diffused on the skin, or concentrated in special chromatophores, in part also to the way in which the light is reflected from the hairs and skin. They vary with age and sex, with food and environment, and, as we shall see, are often of importance in courtship and in protective adaptations. Soon after the young spider is hatched it casts its cuticle, and this moulting is repeated at intervals until the full size is reached. It is

probable that the *Attidæ* moult from seven to eleven times before reaching maturity. As this moulting proceeds, the colour, which in young spiders is generally bright yellow or green, whitish or livid, gradually becomes in tints and markings that which is characteristic of the species.

There are six pairs of appendages: (1) the clawed chelicerae or palces, of which the last joint works against the second last and contains a poison-gland; (2) the leg-like pedipalps, the terminal joint of which is modified in the male for copulatory purposes; (3-6) four pairs of walking-legs, of which the foremost pair are much used as feelers. The embryo has four pairs of abdominal legs which abort. Near the anus are situated two, three, or four pairs of closely approximated spinnerets, and on each of these

there are numerous 'spinning-spools,' out of which oozes the viscid fluid which hardens into the silken thread. A figure is given of the foot of the hindmost leg in the Garden Spider, showing the claws and spines, which are of use in drawing out the silken secretion. Among other external characters are the simple eyes, of which a variable number, most frequently eight, occur on the head; the openings or stigmata of the respiratory sacs or tubes; the opening of the reproductive ducts between the anterior stigmata; and (in the female) the adjacent but separate aperture or apertures of the receptacula seminis.

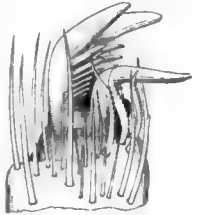

Fig. 1.—Foot of Garden Spider.

The nervous system conforms to the usual Arthropod type, consisting of a dorsal brain, a ring round the gullet, and a ventral nerve-cord; but the ventral ganglia are concentrated in a single ganglionic mass in the thorax, giving off nerves to the limbs and other parts.

As regards the senses of spiders, it seems that few have much power of precise vision. Some discern rapid movements of objects, but seem unable to see their cocoon though it be but a few inches off. The hunting Saltigrades, however, have been observed to stalk prey from a distance of 10 inches, but that this is regarded as exceptional shows how limited the ordinary power of vision is believed to be. In many cases it has been experimentally proved that spiders exhibit an apparent preference (perhaps dependent on sexual associations) for certain colours, and it is certain that the males of some kinds (e.g. *Attidæ*) display their bright colours before their desired mates. The limited nature of visual power is in great part compensated for by the exquisite delicacy of the sense of touch, for the lurking spinner feels rather than sees the insect tangled in its snare or web. Vibrations such as those caused by the whizzing of insects' wings or by a tuning-fork are propagated along the taut lines of the web and interpreted by the spider. According to some observers, the courtship is sometimes conducted in this telephonic fashion. This tactile sensitiveness seems to be in great part diffused over the body, but the hairs towards the ends of the legs are specially sensitive. We know little with regard to the sense of hearing in spiders. That some males, e.g. of *Theridium* and *Mygale*, are able to produce a stridulating noise, suggests that their mates can hear, but the evidence is not conclusive. Nor are the numerous accounts of spiders which descend chandeliers and the like to listen to music, for spiders often do this when there is no music, and are especially likely to do this of an evening, and it is difficult to abstract the influence of vibrations other than those of sound-waves. Many, however, believe that spiders

really hear, and it may be that careful experiments will prove that what are described as 'auditory hairs' on the palps and legs are really such. The sense of smell seems to be slight, though marked for certain strongly-scented substances, and there is a sensory structure, perhaps olfactory or gustatory, on the basal joint of the pedipalps.

All spiders are predaceous and feed on insects, which they entangle in their snares and webs, or stalk, or catch after patient lurking. In most cases they kill their prey with their poisonous fangs. The mouth is small, and behind the gullet there is a powerful suctional region which acts as a suction-pump. From the mid-gut five paired out-growths extend into the bases of the pedipalps and legs. There are also large tubular digestive out-growths, and two excretory Malpighian tubes grow out from the hind-gut. The heart lies dorsally in the abdomen, and has three chambers with three pairs of valved openings. In one set (Tetraneumones, e.g. the bird-catching Mygale; see BIRD-CATCHING SPIDER) there are four pulmonary sacs like those of the scorpion; in the great majority (Dipneumones) there are two pulmonary sacs and two main tracheal tubes.

The sexes are separate except in a few casual hermaphrodites, and the males are often fewer in number, always smaller in size, and usually more brightly coloured than the females. In most cases, as we shall afterwards see, the courtship is elaborate, and is often attended with considerable danger to the males. The fertilised egg segments peripherally, like that of insects, around a central core of yolk. A cocoon is usually formed around the eggs, and this is hidden or carried about by the female, who exhibits much maternal solicitude.

The fertility of spiders varies in different species within wide limits. Thus, as Mrs Peckham notes, one species may lay 800 or 1000 eggs, while another, equally common, lays only fifty. In the family Epeiridae *Argiope cophinaria* lays 500 to 2200 eggs, while *Tetragnatha laboriosa* lays only 34; in the family Attidae *Phidippus morsitans* lays about 180 eggs, while *Synageles peccata* lays only three. While the rate of multiplication is immediately dependent on the constitution of the different species, it also bears some relation to the rate of mortality, or, what comes almost to the same thing, to the efficiency of the protective adaptations by which spiders are saved from their enemies. Those with a low birth-rate are usually protected very efficiently, and have consequently a low rate of mortality.

In many cases female spiders are savage and quarrelsome, fighting with one another, and frequently destroying the smaller males when these offer them amatory attentions. 'Ridiculously small and weak in build, the males of many species can only conduct the rites of marriage with their enormous and voracious brides by a process of active manoeuvring, which, if unsuccessful, is certain to cost them their lives.' In a great number of cases, e.g. in at least two-fifths of all the species of Attidae, the males are more brilliantly coloured than the females, and that this is in part related to sexual selection is rendered almost certain by the observations of Professor and Mrs Peckham, who often worked four or five hours a day for a week in getting a fair idea of the habits of a single species. They describe among many species of Attidae the manner of the wooing, the cautious circling dances of the ardent males, the strange attitudes by which they display their charms of colour, the occasional wooing by vibrations of the web-lines, the captious irritability of the females, who often bring the courtship to a tragic end, the quarrelsome of rival males in presence of the females. 'The males vie with each other

in making an elaborate display, not only of their grace and agility but also of their beauty, before the females, who, after attentively watching the dances and tournaments which have been executed for their gratification, select for their mates the males which they find most pleasing' (see SEXUAL SELECTION).

Spinning-work.—On each of the spinnerets—of which in the majority there are six—there are numerous, usually sixty to seventy, 'spinning-spools,' out of which there flows a viscid secretion formed in the numerous internal glands. The resultant thread into which the secretion hardens, though of a delicacy hardly rivalled except by quartz fibres, is from the nature of its origin a complex structure. Its texture is not always the same; it may be covered with minute adhesive beads, or be stronger and unbeaded, or very light and filmy as in gossamer. In some spiders there is a special chitinous plate—called the cribellum—lying in front of the spinnerets and perforated by the ducts of numerous glands. 'Its presence is correlated with that of the calamistrum, a single or double row of long wavy hairs on the dorsal aspect of the second last tarsal joint of the fourth pair of walking-legs. One of the calamistras is rapidly vibrated over the cribellum, and draws out the secretion from the glands in the form of threads, used to strengthen the web, to assist in forming the cocoon for the eggs, and sometimes perhaps in making a domicile.'

The webs of spiders vary as much as do the nests of birds, but as a single example of their making we may take that of the Common Garden Orb-weaver

(*Epeira diademata*). The spinner first lays down a number of firm foundation-lines, which may be disposed 'by hand' if the situation admits of this, but are more frequently blown fortuitously by air-currents. Having secured a number of these foundation-lines enclosing the area for the web, the spider forms the radii which intersect in the centre.

This done, she begins from the centre and stepping outwards in a wide spiral lays down the spiral scaffolding. Finally, beginning at the circumference and working inwards, the spider lays down the delicate viscid spirals on which the efficiency of the web depends. The primary spirals simply form a scaffolding, and are undone, in fact eaten up, as they are replaced. But the web of the garden spider is a comparatively simple case; we have to distinguish 'orb-webs,' 'ribbed orbs,' 'composite snares and sectional orbs,' 'horizontal snares and domed orbs,' 'unbeaded orbs and spring snares,' and so on, as Dr McCook, in his incomparable work on American spiders, has pointed out



Fig. 2.—*Astia vittata*, male 'displaying his charrins.' (After G. W. and E. G. Peckham.)

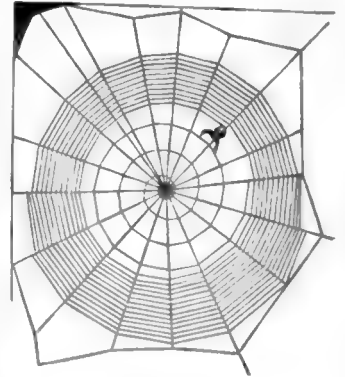

Fig. 3.—Garden Spider spinning her web.

(From 'Riverside' Natural History.)

No structures made by animals—not even the nests of birds, the homes of bees, the hills of the Termites—are more marvellous than the webs and snares of spiders. The framework is so delicate yet so effectively firm, so clever in its construction, so sensitive, we may almost say, in its mechanism, that we must rank it highest among works of instinctive art. Instinctive, for each species of weaver has its characteristic web, and there is no reason to suppose that the art of making this is the result of education. Yet the mode of construction is not rigidly fixed, but varies a little according to the site, according to the wind, and even, it is said, in relation to the abundance of insects in the neighbourhood. We see the strength of the web when it remains unbroken in the wind, and when it is laden with drops of dew, but sometimes it is much stronger than such sights suggest. Mosely tells how Willenoes Suhm on the *Challenger* expedition found a Glossy Starling (*Calornis metallica*) hopelessly entangled in a spider's web, and other naturalists relate the same of humming-birds and other small creatures. Thus a snake, nine inches long, has been found hanging in a web; and Dr McCook, whose carefulness as an observer is worthy of all praise, relates how a young living mouse was in some manner securely entangled in the snare of a spider, how the spinner, by means of silken threads two or three feet long, hoisted the mouse up four inches, and how the mouse after living for ten hours at length succumbed. A spider three-quarters of an inch in length has been seen to land a fish about three inches in length, but perhaps the raising of a mouse in a web is more wonderful. Mr Wallace and other exploring naturalists also tell of spider-webs strong enough to be a serious obstacle to travellers in the woods, and in other reports fancy has magnified this strength tenfold. As to the intelligence involved in modifying the web in various conditions it is not easy to form an accurate estimate. On a long hedge we may see scores of webs disposed so as best to stand the stress of the prevailing wind, but we must remember that the foundation-lines of the web are in most cases wind-blown. Often in the geometric webs there are interesting irregularities which show that equal precision is not always attained. On the other hand fractured snares are sometimes mended by skilfully disposed trusses. Many observers have described cases where small stones were found hung from the web, as if to weight them against the force of the wind. But McCook maintains, and we would agree with him, that it is most likely that these stones have been raised from off the ground by the shrinkage of the web, and that the alleged advantage—which, if foreseen, involves a complex inference—is simply accidental.

The threads which the spiders spin are used not only in fashioning webs and snares, but in many different ways. Behind them, as they move where a footing is insecure, there trails a drag-line, perhaps the rudiment of all their weaving, and this is of special use when they drop from a height. Jonathan Edwards long ago (1716) observed that spiders in order to cross an unbridged gap will form a sort of swinging basket, and he also noticed their exceedingly strange habit of ballooning. Raising themselves on tiptoe and with upturned abdomen on some point of vantage, they allow long threads of gossamer to float out in the air until these acquire sufficient momentum to carry the spider aloft. In this way they have been known to cross considerable sheets of water. 'To this mode of diversion young spiders of several families are very much addicted, especially in the fine days of autumn. Sometimes the flying threads are excessively numerous, and on their descent cover every-

thing; they are particularly striking on hedges, and constitute, at all events, one of the causes of the phenomenon well known in the country as gossamer.' And again, the threads may help to form the cocoon for the eggs, or may be used to bind leaf to leaf and form a well-hidden nest.

Enemies and Protective Adaptations.—While spiders are the fatal enemies of many insects, they are in turn frequent victims. 'To feed the hungry maw of a stronger, more skilful, or more fortunate fellow Araneid; to be paralysed and entombed within a clay sarcophagus by a mother wasp, and serve as food for a growing waspling worm (see SPHEX); to be snapped up as a delicate titbit by birds, toads, and other creatures—these are some of the ways in which the spider meets its doom.' Among birds the chief enemies of spiders are the humming-birds, among insects the wasps. The ichneumon flies often lay their eggs—with destructive results—in the cocoons of spiders. Small monkeys prey upon spiders a good deal, and so do some insectivorous mammals. Between different kinds of hunting and running spiders there is much keen warfare.

Many spiders hide in crevices or in bivouacs of leaves which they roll up or bind together. McCook describes the nest of the Purse-web Spider (*Atypus abbotii*), a purse-shaped tube attached to the bark of trees, with the outer surface dark and covered with sand. The nests of the trap-door spiders have lids which fit accurately, and are covered with moss, earth, and lichen; in fact the nests of a great number of species believed to be trap-door spiders have never been found. In many cases the vibratory sensitiveness of the web is such that an approaching enemy finds the spider forewarned. When *Argiops cophinaria* has not time to drop from her web to the ground, 'she makes use of another power—she will render herself invisible. The web begins to sway backward and forward; the rapidity of the motion increases; the outlines become indistinct, and within a few seconds of the first movement spider, web, and all have vanished from sight! Others, such as *Pholcus atlanticus*, hang by the legs, and whirl the body rapidly with the same bewildering result.' Mr Herbert Smith suggests that the sideways movement of the *Laterigradæ* has a protective value, since the enemies are likely to allow for a forward movement of their prey. Many Epeiridæ and other spiders drop to the ground when danger threatens, and remain motionless on a surface which they often resemble in colour. McCook seems inclined to regard this death-feint as a trick, not as fear paralysis or catalepsy. The cocoons are hidden in crevices, or covered with web and debris, or carried about by the mother—sometimes attached to the abdomen, sometimes in the jaws. For further examples of the thousands of protective habits, see the works of the Peckhams and Dr McCook.

Often the forms and colours of spiders have a protective resemblance to pieces of plants or to dead things. The species of *Uloborus* are like small pieces of bark; *Hyptioides cavatus* resembles a bit of dirt or the ends of the dead pine branches among which it lives; *Cyrtophora conica* is hardly distinguishable from the pieces of light rubbish which it accumulates in its web; *Cerostris mitralis* resembles a woody knot on the branch on which it rests; *Thomisus foka*, a species much dreaded in Madagascar, has a very strange,



Fig. 4.—*Cerostris mitralis* on a branch (after E. G. Peckham).

crab-like form, and resembles in colour and general appearance the fruit of *Hymenax verrucosa*, a tree common in the forests where this spider is found; *Drapetisca socialis* is very like the bark of birches and other trees on which it lives; among the



Fig. 5.

Gasteracantha rufospinosa, female, mag. 2½ diameters. (After E. G. Peckham.)

Lycosidae there are scores of dull-coloured species that live on the ground; Dr McCook describes one form which has a tint like that of the water upon which it is constantly found; about a dozen species which live on leaves are recorded as protectively green; many Thomisidae are coloured like the flowers on which they await their victims; *Ornithoscatoides decipiens*, first described by Forbes, is, as its name suggests, most deceptively like

bird-excrement, so that the discoverer actually plucked the leaf on which the spider was resting, and looked at it for some moments before he discerned his captive. In short, what Mr Wallace said about the leaf-like butterfly is often true of spiders: 'Size, colour, form, markings, and habits all combine to produce a disguise which may be said to be absolutely perfect.'

Again, there are spiders which are rendered inedible by an armature of spines and plates, and many of these (e.g. some *Gasteracanthidae*) are very brilliantly coloured. It is possible that their conspicuousness impresses their enemies with the fact that they are better left alone.

Lastly, there are spiders which exhibit a protective mimicry of animal forms. 'Spiders most commonly mimic ants,' Mrs Peckham says; 'but we hear also of their imitating beetles, snail-shells, ichneumon and horse flies. There is also a curious Madagascar species which looks exactly like a little scorpion, the resemblance being heightened by the habit of curving its flexible tail up over its back when irritated.' Nearly all the species of *Coccorhates* and *Homalotus* resemble beetles; *Cytarachne* is like a snail-shell; *Synageles picta* and *Synemosyna formica* are good examples of those which have a mimetic likeness to ants.

Classification.—Spiders of the Bird-catcher (*Mygale*) type differ from all the others in having four pulmonary sacs (*Tetrapneumones*). The *Dipneumones*, which form the vast majority, including several thousand species, are conveniently classified according to their habits whether sedentary or wanderers, and according to their spinning-work, this physiological classification being also justified anatomically. Another fact of some importance is the presence or absence of a cribellum. Thus we distinguish

- | | |
|-------------|--|
| | Sub-order—TETRAPNEUMONES. |
| | Tribe I.—Tertitellarie: Tunnel-weavers. |
| | Sub-order—DIPNEUMONES. |
| 'Sedentary' | Tribe II.—Tubitellarie: Tube-weavers, including Cribellatae and Cribellatae. |
| | Tribe III.—Retitellarie: Line-weavers. |
| | Tribe IV.—Orbitellarie: Orb-weavers, including Cribellatae and Cribellatae. |
| | Tribe V.—Latiigradae. |
| Wanderers | Tribe VI.—Citiigradae. |
| | Tribe VII.—Saltigradae. |

Numerous extinct species of spiders have been obtained from Tertiary deposits, especially from amber. The oldest known form (*Protolycosa*) occurs in Carboniferous strata.

British Species.—Among the British species the following may be noted: The Common Garden

Spider (*Epeira diadema*), and other species of this genus; the House-spiders (*Tegenaria domestica* and *T. cavilis*); *Agelena labyrinthica*, which makes large cobwebs, very abundant



Fig. 6.—The Garden Spider (*Epeira diadema*).

on heaths; the Water Spider (*Argyroneta aquatica*), which inflates its sub-aquatic dome-shaped web with air brought from the surface entangled among the hairs of the spider's body; the Green Crab-spider (*Sparassus smaragdulus*), whose young are fond of ballooning in autumn evenings; a few Wolf-spiders, such as *Lycosa piratica* and *Dolomedes fimbriatus*; *Salticus scenicus*, exceedingly common on walls and fences, and *Atypus sulzeri*, the only British representative of the Trap-door Spiders (see Systematic List: P. Cambridge, *Proc. Linn. Soc.*, xxx. 1875).

Relations to Man.—The wide-spread prejudice against spiders is not scientifically justifiable. We must admire their dexterity, their instinctive aptitudes, their intelligence, the beauty of their architecture, the elaborateness of their courtship (tragic as it sometimes is for the suitor), and their maternal care. Although there are countless tales of 'black spiders,' rarely preserved for identification, which are alleged to have given dangerously poisonous bites, this is not true except in regard to the famous *Tarantula* (*Lycosa tarantula*), and even the effects of its bite have been grossly exaggerated both by evil intention and credulous superstition. Of a not uncommon line-weaver (*Lathrodictus oculus*), which has a very bad reputation as a venomous biter, one of the authorities on spiders says that he repeatedly allowed himself to be bitten and suffered no inconvenience. In fact, if we except the *Tarantula*, there are few spiders more dreadful than are fleas. In old medical practice a spider was sometimes applied to the wrist in cases of fever, and another custom of applying the web to staunch bleeding is still practised by schoolboys, who are happily ignorant of antiseptic precautions. The great value of spiders is the obvious one that they destroy so many insects; thus, McCook counted thirty-six mosquitoes on a single web.

See especially H. C. McCook, *American Spiders and their Spinning-work* (3 vols. Phila. 1890-94); also Bertkau, numerous papers trans. in *Annals and Magazine of Natural History*; Blackwall, *British Spiders* (Lond. 1861-64); E. Blanchard, *Arachnides* (Paris, 1853-64); P. Cambridge, article 'Arachnida,' *Encyclo. Brit.*; J. H. Emerton, *The Structure and Habits of Spiders* (Salem, 1878); Hahn and Koch, *Die Arachniden* (Nuremb. 1831-49); Hentz, *Spiders of the United States*; O. Hermann, *Ungarns Spinnen-Fauna* (Budapest, 1879); E. Keyserling, *Die Spinnen Amerikas* (Nuremb. 1880-86); Koch and Keyserling, *Die Arachniden Australiens* (Nuremb. 1872-88); Latreille, Dugès, and Milne Edwards, *Arachnida of Cuvier's Règne Animal*; H. Lebert, *Bau und Leben der Spinnen* (Berlin, 1878); Moggridge, *Trap-door Spiders* (Lond. 1872); Menge, *Preussische Spinnen*; G. W. and E. G. Peckham, *Observation on Sexual Selection in Spiders of the family Atidae* (Milwaukee, 1889); E. G. Peckham, *Protective Resemblance in Spiders* (Milwaukee, 1889); E. Simon, *Les Arachnides de France* (Paris, 1874-84); Thorell, *European Spiders* (Upsala, 1870); and Walckenaer and Gervais, *Histoire Naturelle des Insectes Aptères* (1837-47); W. Wagner, *L'Industrie des Aracina* (1894).

Spiegeleisen. See BESSEMER, and STEEL.
Spielberg. See BRÜNN.

Spielhagen, FRIEDRICH, German novelist, was born at Magdeburg on 24th February 1829, but passed all his youth at Stralsund. From the gymnasium there he proceeded in 1847 to the universities successively of Bonn, Berlin, and Greifswald, afterwards settling at Leipzig in 1854 as a *docent*, at Hanover in 1859, and at Berlin in 1862, in the last two places till 1884 as a newspaper editor. His works, of which eight have been translated into English, are some thirty in number, in upwards of fifty vols., and include (besides poems, books of travel, translations, and novellettes) *Problematische Naturen* (1860), *Durch Nacht zum Licht* (1861), *Die von Hohenstein* (1863), *In Reih und Glied* (1866), *Hammer und Amboss* (1868), *Sturmflut* (1876), *Uhlenhans* (1884), *Was will das werden?* (1886), &c. Mostly 'novels with a purpose,' dealing with burning questions of the day, these have a vigour and interest, in spite of their sometimes portentous length, that too often are missing in modern German fiction. A complete edition of his works has been published since 1875.

See his autobiographical *Erinnerungen* (1889 *et seq.*), and Karpeles' *Friedrich Spielhagen* (Leip. 1889).

Spigella, a genus of plants of the natural order Loganiaceæ, having a calyx glandular inside, a long slender valvate corolla, long filaments, and a capsule of two cocci, splitting around at the base. *S. marilandica*, often called Worm Grass and Carolina Pink, is a native of the southern United States, a perennial plant with a simple quadrangular stem. The root (Pink Root) is purgative, narcotic, and poisonous, but is a powerful vermifuge, and is very commonly employed in the United States. *S. anthelmia*, an annual, native of tropical America, with very small purplish flowers, in spike-like racemes, possesses similar properties. The efficacy of both is, however, impaired by keeping; and they are apt to produce unpleasant symptoms when used as medicines. Other species are also known as poisons.

Spike, in Botany, that kind of inflorescence in which sessile flowers, or flowers having very short stalks, are arranged around an axis, as in the greater plantain, common vervain, common lavender, and some species of sedge. In rye, wheat, barley, darnel, and many other grasses there is a sort of compound spike—i.e. the flowers or fruits are arranged together in spikelets upon short stalks, which again surround the top of the culm in the form of a spike. The catkin, the spadix, and the cone may be regarded as varieties of the spike.

Spikenard, or NARD (Gr. *Nardos*), a perfume highly prized by the ancients, and used both in baths and at feasts. It was brought from India, and was very costly. The plant which produces it is the *Nardostachys Jatamansi*, a small plant of the natural order Valerianaceæ, a native of the Himalaya Mountains of the north of India, and found at least as far south as the Deccan. The odour is not, however, generally agreeable to Europeans. Spikenard is popularly believed to have the power of promoting the growth and blackness of the hair, and to be an antidote for poisons. It is now more used medicinally than as a perfume. The aromatic hairy tap-root, which is from 3 to 12 inches long, sends up many stems with little spikes of purple flowers, which have four stamens. The name spikenard was given by the ancients to many perfumes used as substitutes for the true or Indian spikenard, some of which were derived from the roots of plants of the same natural order, the kind called Gallic or Celtic spikenard from those of *Valeriana celtica* and *V. salivca*, which are still used in the East for perfuming baths, and that called Cretan spikenard

from those of *V. tuberosa*, and *V. Phu*. All of these grow on the Alps and other mountains of the south of Europe, and the peasantry of Styria and Carinthia collect them from rocks on the borders of perpetual snow. They are tied in bundles, and sold at a very low price to merchants, who sell them at a great profit in Turkey and Egypt, from which a proportion is transmitted even to India.

Spiking is the operation of quickly rendering a muzzle-loading gun useless, resorted to by troops compelled to abandon their own pieces or unable to remove those of the enemy which they have captured. The process consists in driving a cast-iron spike into the vent or touch-hole and then breaking it off short with a hammer. A spiking party of artillerymen always accompanied a storming party. To render a spiked gun again serviceable it was generally necessary to drill a fresh vent. Breech-loading guns are best rendered temporarily unserviceable by removing part of the breech mechanism.

Spillsby, a market-town of Lincolnshire, 19 miles by rail N.E. of Boston, stands on the edge of the Wolds. The church contains interesting monuments of the Willoughby family (1348–1610), and the market-place has a bronze statue of Sir John Franklin, a native of the town. Pop. 1482.

Spinach, or SPINAGE (*Spinacia*), a genus of herbaceous plants of the natural order Chenopodiaceæ; dioecious, the male flowers consisting of a four-parted perianth, and four stamens; the female, of a two to three cleft perianth, and an ovary with four styles; the perianth hardening around the fruit as it ripens; the fruit an acheneum. Common Spinach, or Garden Spinach (*S. oleracea*), is in



Common Garden Spinach (*Spinacia oleracea*).

general cultivation for the sake of its young leaves, which are a favourite and wholesome vegetable, prepared either by boiling or by frying with a little butter. Two very distinct varieties are cultivated—Prickly Spinach, which has the leaves somewhat triangular and arrow-headed, and the fruit rough with prickle-like projections; and Smooth Spinach, or Round Spinach (*S. glabra* of some botanists), with the leaves more round and blunt, and the fruit smooth. Spinach is an annual. Its stem rises to the height of from 2 to 4 feet; the male flowers are in long spikes, the female in clusters close to the stem. After the stem begins to be developed the leaves become bitter and unfit for use. This bitterness appears also at an earlier period in dry weather or in poor soil; and the more luxuriantly spinach grows the better it is. It is sown in spring, and is ready for use in a very short time; or it is sown in autumn, thinned out, and used early in spring. The smooth spinach

is very generally preferred for the former purpose, and the prickly kind for the latter; but a somewhat intermediate variety called Flanders Spinach, in the seed trade named Viroffley Spinach, is now often used for both, being particularly esteemed for the large size of its leaves. The native country of spinach is not well known, but is believed to be some part of Asia, as the plant was introduced by the Arabs into Spain, and thence diffused over Europe. Another species (*S. tetrandra*) is cultivated and much esteemed in India. The name spinach is also given to a number of other plants of very different botanical characters, but which have the same bland and nutritious qualities, and are used in the same way. New Zealand Spinach is *Tetragonia expansa*, a plant of the natural order Mesembryaceæ, sub-order Tetragoniæ (natural order Tetragoniaceæ of Lindley), a trailing, succulent annual, spreading widely over the surface of the ground, and producing a great abundance of stalked ovate-rhomboid leaves. The young stems and leaves of this plant are much used in New Zealand, and have now come into very general use also in other parts of the world as a kind of spinach. It is cultivated in the middle and south of Europe and in Britain, succeeding well even in Scotland with the slightest aid of a hotbed in spring, and is found particularly useful in light dry soils, in which in summer it is difficult to maintain supplies of the common spinach. Patience Dock, or Garden Patience (*Rumex Patientia*; see DOCK), is called in Germany English Spinach, and was formerly much cultivated in England, but is now neglected.

Spinal Column and Spinal Cord. The spine or spinal column is the most important and characteristic part of the Skeleton (q.v.) of the highest division of the animal kingdom. It is composed of a series of bones placed one above, or in front of another, and called vertebrae; and hence these animals, having this distinguishing characteristic in common, are all included in the term *Vertebrates*. The vertebrae vary greatly in number in different animals, and even in members of the same class, and the number bears no apparent relation to the other organs of the animal. Moreover, in their shape they differ extremely even in different parts of the same spine, in accordance with their special functions. In man the number of vertebrae which collectively form the spinal column is 7 in the neck (cervical vertebrae), 12 in the back (dorsal vertebrae), 5 in the loins (lumbar vertebrae), all of which are capable of being detached from one another, and are termed *true vertebrae*; and 5 vertebrae ossified together and forming the sacrum, and 4 or 5 similarly united forming the termination of the column, and constituting the bone called the coccyx, which are known as *false vertebrae*. However long or short the neck may be, every mammal has 7 cervical vertebrae, excepting the three-toed sloth which has 9, and the sea-cow which has 6. In the other regions of the spine no such uniformity exists. Each vertebra is attached to the two between which it lies by numerous strong and more or less elastic ligaments, and between each pair of vertebrae there is interposed a lenticular disc of fibro-cartilage, which acts as a buffer. By these arrangements the spinal column is rendered highly elastic, the communication of jars or shocks is prevented, and a very considerable general range of movement permitted, although the motion between any two adjacent vertebrae is slight. The elasticity of the column is further increased by the component vertebrae being arranged in curves instead of being placed perpendicularly. The curves should be exactly in the antero-posterior direction, any well-marked lateral deviation from the perpendicular being abnormal;

but a very slight lateral curvature with the convexity to the right may often be detected in the upper and middle parts of the back, and is supposed to be dependent on the more frequent use and greater strength of the right arm as compared with the left. From their position they are termed the cervical, dorsal, lumbar, and pelvic curves. The dorsal and pelvic curves have their concavities in front, and thus enlarge the spaces in which the thoracic and pelvic viscera are contained; the two other curves are convex anteriorly, and thus afford support to the parts above them. The upper three curves are so arranged that their cords are in the same vertical line in the erect position of the body, and this vertical line corresponds with the line of gravity of the head. The cause of these curves is to be sought for partly in the shape of the vertebral bodies, and partly in that of the intervertebral substance. Amongst the uses of these curves it may be mentioned (1) that they enable the spine to bear a greater vertical weight than it could otherwise maintain; it is calculated that nine times as great a vertical force is required to bend it as if it had been straight; (2) that they facilitate the movements of the body, especially in the act of running; and (3) that they are so disposed as to protect the cord in movements of the spine. Similar curves are seen in the spine of other mammals (see ANTHROPOID APES), though the degree of flexure is liable to great deviations. The lumbar curve, which has especial reference to the erect position, is always much less marked than in man.

The vertebral canal formed by the apposition of the spinal foramina or neural arches, and containing and protecting the spinal cord, varies in its size at different parts of the column. It is largest in its antero-posterior diameter in the neck and loins (measuring at the last lumbar vertebra $\frac{1}{2}$ of an inch), where the antero-posterior movements of the spine are greatest, and where the cord is least closely attached to the vertebrae; while in its lateral diameter it is greatest at the atlas, where it measures nearly an inch and a half. A transverse section of the canal is nearly circular through the greater part of the back. The intervertebral foramina through which the nerves emerge vary in shape and position in different parts, but are always of sufficient size to prevent injurious pressure on the nerves during movement of the spine; and in the dorsal region, which is the ordinary seat of angular curvature, the nerves are so protected by

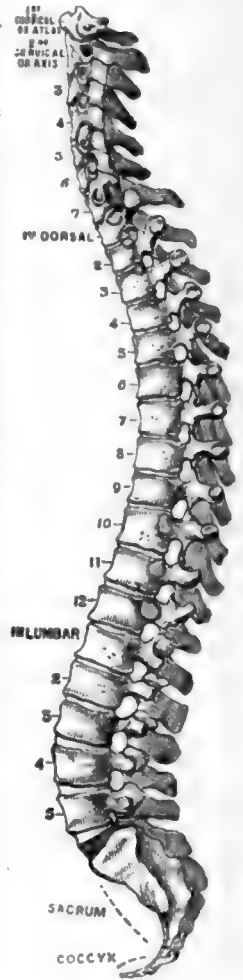

Fig. 1.—Spinal Column.

bony arches that they may escape injury, even when the bodies of several dorsal vertebræ have been destroyed by ulceration.

The *spinal cord* is that part of the central nervous axis which is contained within the vertebral or spinal canal. In man it extends from the foramen magnum, where it becomes continuous with the medulla oblongata, as far down as the lower border of the first lumbar vertebra. Below this point it is continued as a narrow thread containing little nervous matter, the *filum terminale*. The cord is, like the brain, encased in a triple sheath of membranes, the pia, arachnoid, and dura mater, the last two of which are less closely opposed to the cord and the vertebral column than they are to the brain and the cranium. The cord is a somewhat flattened cylinder or column of a whitish colour. It is divided into two lateral halves by an anterior median fissure and a posterior median septum. The former is less deep but wider than the latter, which is merely a process of pia mater. From each side of the cord thirty-one pairs of spinal nerves arise, each by an anterior and a posterior root (see NERVOUS SYSTEM). The cord is not of uniform circumference throughout. There is a slight thickening where the brachial nerves, and another where the lumbar nerves, arise. These are termed the brachial or cervical and lumbar enlargements respectively. The nerve roots in the cervical and dorsal regions pass nearly transversely outwards through the intervertebral foramina; but the lumbar and sacral nerves are directed downwards to attain their points of exit, in such a manner as to obtain the name of *Cauda Equina*.

The cord is seen to be composed of white and gray matter. On a transverse section the gray matter is found in the centre to present the appearance of a double crescent, concave outwards, with a commissural band between the two sides, so that the whole somewhat resembles the letter H. In the gray commissure is the *central canal*, which extends throughout the whole length of the cord and becomes continuous above with the fourth ventricle. The gray matter is divided into an anterior and a posterior horn. It is composed of a basis of connective tissue in which are a fine felt-work of nerve-fibres and nerve-cells. In the anterior horn, which becomes specially developed in the brachial and lumbar enlargements, the cells are of the multipolar type. They send a well-marked axis cylinder process into the anterior nerve root, and by their other processes are connected with fibres which descend from the cerebrum and from the posterior roots and other sources. In the posterior horn the nerve-cells are smaller, rounded, or spindle-shaped, and possess no axis cylinder process. They are probably connected with the posterior roots.

The white matter of the cord is composed of nerve-fibres, united by a small amount of connective tissue. The fibres have mostly a longitudinal direction, with the exception of a small strand which crosses from one side to the other at the bottom of the anterior median fissure—the anterior white commissure. Each half of the cord is divided by the anterior and posterior roots into three columns, named anterior, lateral, and posterior. Though these look almost exactly alike

both to the naked eye and under the microscope, they can, by taking advantage of the facts that their component fibres are not all developed simultaneously, and that as the result of injury they do not 'degenerate' in the same direction or to the same extent, be further subdivided. Thus the posterior column is composed of two tracts—a postero-median and a postero-lateral. In the lateral column there can be distinguished five tracts: a direct cerebellar, an ascending antero-lateral tract, a crossed pyramidal tract, a lateral limiting layer, and a lateral mixed zone; while the anterior column consists of a direct pyramidal tract and an anterior mixed zone. The relations of these tracts have been fairly definitely established. The postero-median column is nearly entirely composed of fibres of the posterior roots which, after entering the cord and passing for a short distance in the postero-external column, are continued upwards as high as the medulla oblongata, where they end. This column then will form a direct path of connection of the posterior roots with the medulla oblongata. The direct cerebellar tract connects a column of nerve-cells in the posterior horn of the lumbar and dorsal regions of the cord (which is termed Clarke's vesicular column) with the middle lobe of the cerebellum. The antero-lateral tract appears to connect the nerve-cells in the posterior horn of one side of the cord with the medulla oblongata of the opposite side.

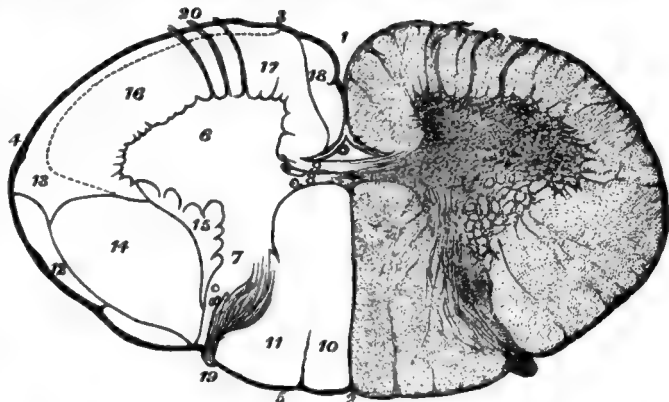

Fig. 2.—Section of Spinal Cord (outline of tracts shown on left side):

- 1, anterior median fissure; 2, posterior median septum; 3, 4, 5, anterior, lateral, and posterior white columns; 6, 7, anterior and posterior horn of gray matter; 8, 9, anterior and posterior commissures; 10, posterior median column; 11, posterior lateral column; 12, direct cerebellar tract; 13, antero-lateral ascending tract; 14, crossed pyramidal tract; 15, lateral limiting layer; 16, 17, lateral and anterior mixed zone; 18, anterior pyramidal tract; 19, posterior, and 20, anterior roots.

All these tracts degenerate, and presumably also conduct nervous impulses in an upward direction. The direct and crossed pyramidal tracts form the downward continuation of the 'motor' fibres from the surface of the brain to the cells in the anterior cornu of the cord. At the lower end of the medulla oblongata (see BRAIN, fig. 7) the greater part of the fibres of the anterior pyramids cross the middle line and descend in the crossed pyramidal tract of the cord to become connected with the motor-cells in the anterior horn. The direct pyramidal tract represents a small remnant of the fibres which descend in the cord without crossing to the opposite side. They cannot as a rule be traced further than the cervical region. Both of these tracts are undoubtedly concerned in the transmission of voluntary motor impulses from the brain. Their degeneration always accompanies paralysis of cerebral origin.

The tracts which lie in immediate contact with the gray matter, the antero-lateral mixed zone,

the lateral limiting layer, and the postero-external column, probably form connections between different levels of the cord. Thus the postero-external column is in great part formed of fibres of the posterior roots passing upwards or downwards for a certain distance in it before entering the postero-internal column; while the antero-lateral mixed zone contains fibres which connect either nerve-cells at different levels, or more probably nerve-cells of one level with fibres which enter the anterior roots at another.

Functions.—The spinal cord provides paths for the conduction of afferent and efferent impulses to and from the brain, and also between different portions of its own substance, as well as arrangements for co-ordination of movements of the muscles of the trunk and limbs, and centres for the regulation of certain of the 'organic' functions of the body.

The efferent impulses are motor, vasomotor, and secretory. The path for the first of these is perfectly well known. It passes from the cerebral cortex (motor area) through the internal capsule and the anterior pyramids of the medulla mainly to the crossed pyramidal tract of the opposite side, and thence, as described, to the cells in the anterior cornu. It is not yet known whether the ultimate destination of the fibres of the direct pyramidal tract is the cells of the anterior horn of the same or those of the opposite side. The fibres from the vasomotor centre in the medulla in all probability pass down in the crossed pyramidal tract and leave the cord by the anterior roots. Division of their path leads to paralysis of the muscular walls and dilatation of the arteries. This is only temporary, as there are probably also centres in the cord which can act independently of those in the medulla. The other efferent paths are unknown.

The afferent paths transmit the various forms of sensory impulses; but, though we may perhaps assume that those which degenerate upwards also conduct in the same direction, it is remarkable how little is known definitely about these. It is generally held that impulses from the muscles pass up the same side of the cord either in the postero-median or direct cerebellar tracts; while the other sensory paths cross the cord as soon as they enter it, and are continued upwards along the other side. It is not determined whether the crossing is complete, or whether the path is in the white or gray matter or in both. Probably it is not identical for each variety of sensation. There is some reason to believe that impulses which give rise to painful sensations travel up the ascending antero-lateral tract.

The cord also has in its anterior cornu cells which, when stimulated either from the brain or from the sensory nerves, originate voluntary or reflex muscular movements. These cells fulfil too the function of keeping up the general tone of the muscles and also their nutrition, for when they are destroyed the nerves and muscles connected with them waste and disappear. In certain regions of the cord these cells form centres for various of the organic functions. These are found mostly in the lower dorsal and lumbar regions. Recent experimental research by Ferrier and Yeo has determined the levels in the cord of the centres for the various movements of the limbs and trunk, and has already given valuable results in practical surgery.

See Quain's *Anatomy*, Obersteiner's *Anatomy of the Central Nervous Organs* (Hill's trans.), Landois and Stirling's *Physiology*, and Foster's *Physiology*.

CURVATURE OF THE SPINE.—There are two main forms of this disease, which are due to different causes—viz. Angular Curvature or Pott's Curvature, and Lateral Curvature.

Angular curvature, which was first described

by the famous surgeon Percival Pott (1713-88), and is hence often named after him, is due to disease of the bodies of the vertebrae and of the intervertebral discs. It usually takes the form of a tubercular disease of the bones, which become carious and destroyed, and of ulceration of the discs between them. The result is that the bodies of the diseased vertebrae give way and the column becomes bent forward on itself, while the spinous processes form a backward projection opposite the diseased part—hence the name angular curvature. This projection is most marked when the disease is in the dorsal region of the spine. If the disease is arrested the bones become firmly united, and the curve of the spine becomes permanent. In unfavourable cases abscesses may develop in the neighbourhood, and either press on the spinal cord or on the spinal nerves, or burrow in various directions, notably in the lumbar region (psoas abscess). The disease is often set up by an injury which may be severe, such as the falling of a heavy weight on the back, or in children may be some trifling twist or fall, such as may occur during rough play or from falling out of bed or from a chair. It most often occurs in delicate children with a tubercular family history, but it is by no means unknown in those whose family and personal history is quite unexceptionable, and it may even affect adults. Its early symptoms are often obscure, and consequently may be overlooked at a time when treatment is of most avail. There is at first little or no deformity, but there may be pain on percussing the spine of the affected vertebrae. There is also usually an avoidance of all movements which may lead to jarring of the spinal column or to painful pressure on the nerves. If the vertebrae of the neck are affected the child often supports its chin by the hands, and does not willingly turn its head round. Disease of the dorsal or lumbar vertebrae is generally indicated by cautious movements, especially in coming down a stair, the avoidance of stooping or bending, or sudden twisting of the body. A child will thus get down on its knees to pick anything off the floor rather than stoop.

The treatment requires to be both local and constitutional. It is always protracted for months or even years. The general treatment is mainly that required for strumous constitutions, such as codliver-oil, iron, hypophosphite of lime, &c. The local treatment involves absolute rest in the recumbent position in the early stage, with counter irritation over the spine in the neighbourhood of the disease. In later stages mechanical supports are also required to keep the vertebrae from pressing on each other. The kind of support needed varies with the region affected; one very valuable form for hospital practice consists in the application, during the suspension of the patient, of a plaster of Paris jacket to the body. The more carefully rest in the recumbent position and mechanical support are carried out, the less, as a rule, will be the resulting deformity, the greater the prospect of avoiding complications and of obtaining permanent cure.

Lateral curvature consists in a twisting of the bodies of the vertebrae on each other round their vertical axis. It is sometimes a result of rickets, but is far more frequently developed in growing girls of feeble muscular development and general health, between the ages of ten and sixteen. It is produced in the first instance by the continued maintenance of asymmetrical positions of the body, such as by sitting sideways or cross-legged before a school-desk, or by carrying a weight on one arm. This curvature is usually to the right in the dorsal region with a corresponding twist to the left in the lumbar region. One shoulder, usually the right,

becomes elevated, and the scapula projects, while the right side of the chest becomes rounded and the left side flattened. The lungs and liver become compressed and subject to disease, and the gait becomes awkward. This disease is due in the first instance to rotation of the bodies of the vertebrae on each other as the result of the irregular pressure. Later the ligaments and articular processes of the vertebrae undergo permanent changes, while the muscles may atrophy or undergo fatty degeneration. The ribs also become distorted, those at the side of the convexity of the curve bending at the angles, those at the other side becoming flattened.

The treatment of this form differs entirely from that of angular curvature. As the disease is due to the continuance of asymmetrical positions of the body, combined with muscular and general debility, general tonics, fresh air, and gymnastic exercise specially directed to the strengthening of the weakened muscles must be adopted. In the later stages, when the deformity has become more confirmed, mechanical supports may be required as an adjunct to the above.

SPINA BIFIDA is a congenital malformation occurring perhaps more frequently than any other except hare-lip, and arising like it from arrest of development. It may be regarded as a congenital hernia of the membranes of the spinal cord through a fissure in the wall of the bony canal. A tumour is thus formed, which is usually of a roundish shape varying in size from that of an egg to that of an adult head, lying in the middle line of the back, fluctuating, and adhering to the adjacent vertebrae either directly or by a pedicle. The usual termination of the disease is death. As the size of the tumour increases, fatal convulsions ensue; or the skin investing the tumour may ulcerate and the contents escape, in which case palsy or convulsion produces death. Occasional cases are, however, recorded in which patients with this affection have survived till middle life. Surgical treatment has, until quite recently, been unsatisfactory; but with improved modern methods successful results have in many cases been obtained. Moderate support by means of a hollow truss, or a well-padded concave shield, may tend to keep the disease stationary; and any interference beyond this is, in the great majority of cases, inadvisable. For other diseases connected with the spine, see **MENINGITIS**, **MYELITIS**, **LOCOMOTOR ATAXIA**, &c.

Spinazzola, a city of Southern Italy, 30 miles SW. of Bari. It was the birthplace of Pope Innocent XII. Pop. 10,353.

Spindle-tree (*Euonymus*), a genus of plants of the natural order Celastraceae. This order contains about 260 known species, all small trees or shrubs. The genus *Euonymus* has a lobed capsule and seeds surrounded by an aril, which in some of the species is remarkable for its brilliancy of colour. The Common Spindle-tree (*E. europæus*), a native of Britain, chiefly of the southern parts, and of great part of Europe, is very ornamental when in fruit, and its aril is of a fine orange colour. It is a shrub rather than a tree. The wood is hard and fine-grained. It is used for the finer articles of turnery and for skewers. It was formerly used for making musical instruments and for spindles, whence the name of the shrub. In Germany the shoots are bored for stems of tobacco-pipes. Charcoal made of it is much valued for crayons.

Spinel is a mineral composed chiefly of magnesia and alumina, and crystallising in octahedra. There are several varieties, which differ in chemical composition owing to isomorphous substitution, sometimes of the protoxides, but usually of the sesquioxides. *Ruby* or *Magnesia Spinel* is clear red or reddish, and contains little or no iron;

Pleonaste (*Ceylonite*), or *Iron-magnesia Spinel*, is dark green to black, containing iron; *Picotite*, or *Chrome Spinel*, is black, containing chromium oxide; *Gahnite*, or *Zinc Spinel*, is green to brown, containing zinc; *Hercynite*, or *Iron Spinel*, is black, and occurs massive, in this variety ferrous oxide replacing magnesia. Ruby spinel occurs as crystals imbedded in granular limestone, also with calcite in serpentine and in various crystalline schists, as also in the alluvial sands, &c. derived from the disintegration of these rocks. Pleonaste is an occasional constituent of eruptive rocks, and also of certain rocks which have undergone alterations from contact with eruptive masses. Picotite has been met with in basalt, but is more commonly seen in peridotite. Gahnite is of sparing occurrence in certain crystalline schists, while Hercynite is occasionally found in such rocks as granulite. The finer varieties of spinel are prized as gems—the red coloured ones being commonly called rubies. See **RUBY**.

Spinello Aretino, an Italian painter, was born at Arezzo about 1330, his father being a Ghibelline exile from Florence. The painter spent nearly all his life between his birthplace and his father's city, and died at Arezzo about 1410. His principal frescoes were done for the sacristy of the church of St Miniatus near Florence, for the *campo santo* (cemetery) of Pisa, and for the municipal buildings of Sienna (a series illustrating the Italian wars of Frederick Barbarossa), with several others in and near Arezzo. Spinello enjoyed a great reputation in his own day, being compared, and by some preferred, to Giotto, whose style his own in some respects resembles. Unfortunately his frescoes have mostly disappeared; and his panel and enamel pictures, of which there are several in the galleries of Europe, do not equal his frescoes in excellence.

Spines. See **THORNS**.

Spinet. See **HARPSICHORD**.

Spinifex, or **PORCUPINE GRASS** (*Triodia irritans*), a very coarse, hard, and spiny grass which grows in tussocks, and in some interior parts of Australia covers hundreds of square miles at a stretch. This grass cannot be eaten by any animal, and as the clumps are three or four feet high they make exploring and travelling very laborious. Horses are badly lamed by the wounds from the spinifex.

Spinning is the art of twisting fibrous substances into rounded strands of yarn fitted for weaving, or for thread or rope making. To form such strands two operations are essential—(1) the drawing out of uniform quantities of fibre in a continuous manner, and (2) twisting the material so drawn out to give it coherency and strain-resisting power. The earliest and for ages the only spinning apparatus was the spindle with the distaff. The latter was a stick or staff upon which a bundle of the fibre to be spun was loosely bound, and it was either held in the left hand or stuck in the belt. The spindle (fig. 1) was a smaller tapering rod, the rotation of which gave the twist, and around which the thread was wound as it was twisted. The twist was given by causing the spindle to rotate against the person, and allowing it to fall towards the ground whilst spinning around. To give the spindle increased momentum it was weighted with a whorl (fig. 1) of stone or metal, but as the weight of the yarn on it increased this make-weight



Fig. 1.—Spindle and Whorl.

was removed. A graphic description of this method of spinning is given by a Scotch rhymester of the 18th century.

To save their plaiding coats some had
Upo' the haunch a bonnet braid
Or an auld wecht or kairding skin
To rub and gar the spindle rin
Down to the ground wi' twirling speed
An' twine upo' the floor the thread.

Simple as it is, the spindle has continued in use from prehistoric times to the present day. In some outlying regions of the Scottish Highlands and Islands, according to Sir Arthur Mitchell (*The Past in the Present*, Rhind Lectures, Edin. 1880), yarn is still made with it, and in the East Indies

the exceedingly delicate yarn for Dacca (q.v.) muslins is made on the spindle. The first improvement on this simple apparatus consisted in fixing the spindle in bearings and causing it to rotate by a belt passed over a wheel. Next came the fitting on the spindle of a separate bobbin to receive the spun yarn, and this in effect constitutes the charka or spinning-wheel of the East, which has there been used from time immemorial, and also the 'muckle wheel,' the use of which continued in Scotland till recent times. This simple wheel was known in Europe as early as the 14th century, but the greatly improved small or Saxon wheel (fig. 2), with a treadle motion giving continuous rotation to the spindle and allowing the spinner to sit with both

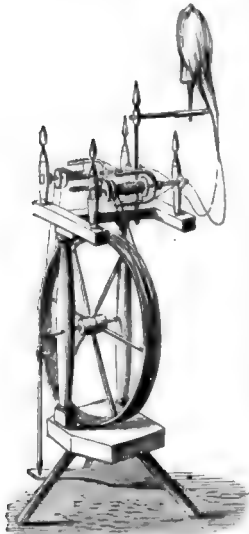

Fig. 2.—Two-handed Spinning-wheel.

hands free, was not known till much later times. In the spinning-wheel in its improved form a bobbin or pirn with a separate motion was placed on the spindle (fig. 3), which had two bent arms, the bobbin and flyer revolved at different rates—the revolutions of the spindle giving the twists and the difference of rotation causing the winding on. In such wheels it was possible to have two spindles and pirns a little apart (the two-handed wheel, fig. 2), with distaff or rock between them, and on these the spinster produced thread with each hand. The introduction of mechanical spinning towards the end of the 18th century gave a death-blow to this great domestic industry, but in the Northern and Western Highlands of Scotland a good deal of worsted yarn still continues to be made for local manufactures on spinning-wheels.

The series of inventions which overthrew hand-spinning may be said to have been begun by Lewis Paul in 1738, when he patented the important principle of drawing out and attenuating a sliver or loose coil of fibre by passing it between successive pairs of rollers revolving at increasing rates of velocity. This principle of drawing out fibres by accelerated motion was developed in the spinning-frame or throstle invented by Arkwright in 1767, and it forms a fundamental feature of all modern

spinning machinery. About 1764 James Hargreaves at Standhill, near Blackburn, invented his spinning-jenny (fig. 4), an apparatus by which eight threads could be spun at once, and this was soon improved upon until eighty could be produced as easily. In this apparatus a number of large reels filled with thickish coils of fibre called rovings were set on upright fixed spindles, and the end of these rovings was passed between two small movable bars of wood placed horizontally and under the control of the spinner, who could thus make them press more or less on the roving, and consequently increase or decrease the draw upon it from the spinning-spindles, which were set in a row at the other end of the frame.

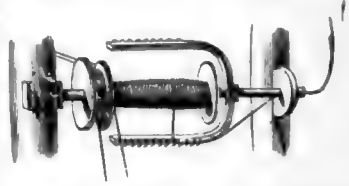

Fig. 3.—Spindle, Bobbin, and Flyer of fig. 2 on larger scale.

These spinning-spindles gave the twist to the rovings when they were fully drawn out, and thereafter wound on themselves the twisted yarn by being moved in the frame towards the bobbins of roving whilst they continued to rotate. The principle of the jenny was important and, developed in the spinning-mule of Crompton in 1779, it is the basis of the second of the two great methods of machine-spinning now in use.

While the operation of spinning is one of the simplest of all arts, requiring as we have seen only the aid of two short pieces of stick, its modern developments have produced more delicate and varied mechanical devices, and have called forth more inventive ingenuity, than any other industrial operation. To convey an adequate idea of the variety of machines used in any single branch of the spinning trade, and of their highly complicated structure, would require much more space than can be here afforded. Different kinds of fibre require different treatment and special machines; and, moreover, yarns of the same fibrous material may be prepared and spun in several different ways according to the uses for which they are intended and other circumstances. Spinning thus becomes a complicated and delicate art, varying widely

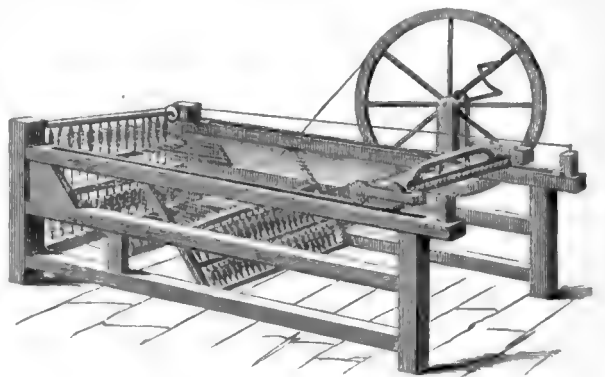

Fig. 4.—Hargreaves' Jenny.

according to the material treated and the purpose to which the yarn is to be devoted. Dealing with wool, for example, the treatment of that fibre for the production of worsted and of woollen yarns is diametrically opposite. For worsted yarns long staple wools are employed. These are combed so

as to separate the short fibres—the 'noils'—from the long or 'top' fibres. The 'top' afterwards passes through a long series of operations, the principal object of which is to lay every single fibre as nearly as possible parallel and level with its neighbour. For woollen yarn, on the other hand, short staple and wavy wools are used. These are carded together so that the fibres may as far as possible cross each other and interlace before being spun, and these peculiarities form the essential distinction between woollens and worsteds. Apart from worsteds, however, there is a general sequence in the treatment of all fibres which may be here briefly outlined.

The object of all operations preliminary to the actual spinning is (1) to free the fibres from all extraneous matter; (2) to lay them side by side in level parallel order; (3) to pull them out in a continuous strand or sliver of uniform thickness; and (4) to attenuate this sliver till the quantity required to form the yarn is reached. The operations necessary for these purposes, combined with a properly regulated amount of twist, constitute the conditions necessary to produce sound, level, and uniform yarn.

Taking the case of cotton, the opening and partial cleaning of the matted fibres are secured by passing the material through two machines called respectively the opener and the scutcher. In these machines are cylinders revolving at a high rate of speed, with their surfaces studded with stout teeth which seize separate locks of the fibre and carrying it round form a broad uniform teased mass which is called a lap. In the first of these machines it is

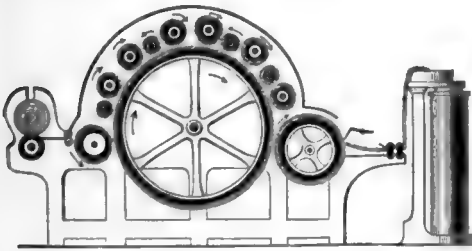

Fig. 5.—Sections of Carding-engine.

also submitted to a strong current of air which blows dust and dirt out of the cotton. From the scutcher a well opened and spread lap of the fibre is delivered to the carding-engine (fig. 5), in which a series of cylinders of various sizes, and rotating at different velocities, further open and tease the fibre. The cylinders are covered with teeth of fine wire (fig. 6) bent at about half their length,

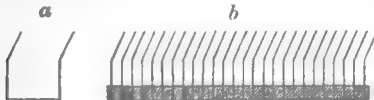

Fig. 6.
a, card wire; b, card setting.

of which there may be from six to seven millions in a single machine. According to the direction in which the cylinders rotate, and the rate of their revolution, the wire points may meet each other, or the points and flat sides of the wires may meet and pass; and in this way certain cylinders lift the fibres from their neighbours and pass it on to others, so that the fibre is gradually teased, brushed, and spread out in a uniform manner. From the carding-engine the fibre is delivered in a broad lap; but by passing it through a ring or

tube it is compressed into a soft rounded coil or sliver. This sliver is taken to the drawing-frame, which consists of say four successive pairs of rollers, each pair in succession going at a greatly accelerated rate, so that the last pair may be going six times quicker than the front pair. In this way a sliver is drawn out six times its original length, and six slivers fed in come out the thickness of one. This drawing out ultimately brings the slivers to a very uniform thickness, and places the fibres in a parallel order. It may be repeated many times, and thereby the fibres which lay together in the original strand may be drawn out to a great length. Thus, passing a sliver of one yard three times through the drawing-frame elongates it $6 \times 6 \times 6 = 216$ yd., or four times passed through it is stretched out to 1296 yd. For fine yarns this drawing out frequently repeated may represent an elongation many thousandfold. In the slubbing-frame comes the beginning of the spinning process; the sliver being here further drawn out and twisted sufficiently to enable it to be wound on a bobbin. The intermediate frame draws out two slubbings to the thickness of one, again slightly twists it, and winds it on a bobbin. In the roving frame the slubbing is drawn out further, slightly twisted, and wound on a bobbin. The rovings or bobbins of rove are then ready for the spinning-frame, which in the case of heavy stout yarns is invariably the throstle, but when fine counts are spun the spinning is done on the mule. In throstle-spinning the roving is attenuated by passing between rollers increasing in speed till the desired tenacity is attained, at which point the final twist is given, and the yarn is wound on the bobbin or pirn ready to receive it.

There are three methods of twisting practised in throstle-spinning. The first and oldest is with spindle, bobbin, and flyer, in principle precisely the same as the arrangement in the spinning-wheel. The second method is cop-spinning, in which the spindle is stationary, but the bobbin which revolves around it is caused at once to give the twist and wind the yarn on its own surface. This is effected by fitting over the bobbin a steel cop or cover of sufficient dimensions to cover a filled bobbin. The cop has a smooth steel edge which keeps the yarn free from the bobbin while the twist is being put on, and which by its motion up and down regulates the winding of the finished yarn on the bobbin. The third and most recent development of throstle-spinning is the ring and traveller frame. In this both spindle and bobbin revolve together and give the twist; but the yarn passes to the bobbin through a traveller or eye of steel set on a flanged steel ring which encompasses the spindle and bobbin. The traveller keeps the yarn free from the bobbin while the twist is being put in, and being carried round by the bobbin it winds the yarn on the bobbin, the filling of which is regulated by an up-and-down motion communicated to the rail on which ring and traveller are fastened. In mule-spinning the bobbins of rove are mounted on a fixed frame, and corresponding yarn bobbins or paper cops are attached to the spindles, which are mounted on a carriage made to travel back and forward over a space of two yards or thereby. The spinning in this apparatus is intermittent. The drawing rollers at the fixed frame give out a certain length of roving; and simultaneously the carriage begins to move away, and the spindles rotating rapidly put twist on the rove. At a certain point the rollers cease to give off roving, but, the carriage still travelling backward and the spindles rotating, the yarn is further drawn out and correspondingly more twist is imparted. The twist becomes hardest at the points where the yarn is weakest, the

drawing power of the carriage is exercised most on the thickest portions of the yarn, and thus twisting and drawing so compensate each other that yarn of great regularity is produced. When the carriage reaches its full stretch the yarn is completely spun, and in returning towards the frame the separate strands are lowered so that they are wound around the cops by their rotation. Then the operations are repeated, and go on doing to perhaps 200 strands of yarn by mechanical agency precisely the series of operations which for ages mankind with a single spindle did for a single strand of yarn—viz. drawing out, twisting, and ultimately winding up the finished yarn. Previous to the invention of the mule few spinners could make yarn of 200 hanks to the pound (the hank being always 840 yards). At the same time the natives of India were weaving yarn of numbers ranging between 300 and 400 (i.e. 400 hanks to the pound). Now, however, our manufacturers have reached such extraordinary perfection that Manchester spinners have made No. 700, which was woven by a French firm. No. 10,000, a pound of which would reach 4770 miles, has been made to test machinery.

Spinola, AMBROSIO, MARQUIS OF, one of the greatest captains of his time, was born at Genoa in 1571. With his younger brother Frederick, already a soldier of fortune under Philip III. of Spain, he raised in 1602 a force of 9000 men, whom he maintained, like the old *condottieri*, at his own expense. In the same year he entered the Netherlands, serving at first under Mendoza. His first exploit was the reduction of Ostend, which the Archduke Albert had been besieging for more than two years. This spread his reputation over Europe, and led to his being placed at the head of the whole Spanish and Italian troops in the Netherlands. Now began a long struggle with Prince Maurice of Nassau, in which neither could gain any decided advantage over the other. The destruction of the Spanish fleet near Gibraltar induced the court of Madrid to conclude in 1609 an armistice for twelve years. At its termination the war began anew, and Spinola found himself once more pitched against his great opponent, who, however, died before the walls of Breda of a marsh-fever caught during his attempts to raise the siege. The town opened its gates in the May of 1625, after having sustained a siege of ten months. This was Spinola's last achievement, his health now obliging him to resign the command. He had spent his whole fortune in the maintenance of his troops, but his pecuniary claims were shamefully neglected by the Spanish government, and his acute vexation at this hastened his death, which took place in Piedmont, 25th September 1630.

Spinoza, BENEDICT (*Benedictus* being a translation of the Hebrew *Baruch*), one of the greatest philosophers of modern times, was born at Amsterdam on the 24th of November 1632. His parents were rich Spanish or Portuguese Jews, whose name (also spelt D'Espinosa and Despinosa) seems to have been derived from a village called Espinoza in Leon. They had their son diligently instructed in the Bible and its commentaries, and the Talmud; but after having mastered both, and imbibed the philosophical spirit of such commentators as Aben Ezra, he was allowed—the more readily that his sickly constitution unfitted him for a commercial career—to devote himself entirely to a life of study. Physical sciences and the writings of Descartes, to which he turned first of all, very soon drew him away from the rigid belief and practices of the synagogue; and Saul Levi Morteira, his Talmudical teacher, who had built the fondest hopes upon the genius of his pupil, was the first to threaten him with the direst

punishment if he did not retract the rank heresies that he began openly to utter. Spinoza, after a time, entirely withdrew from the community of his brethren, who formally excommunicated him (1656). A fanatic even attempted to frighten him by an either real or feigned attack upon him as he left the synagogue one night. At that period the young truth-seeker made the acquaintance of the young and beautiful daughter of Van den Ende, his master in Greek and Latin, and fell passionately in love with her, but was rejected. From that time forth Philosophy became the sole aim and object of his life. In accordance with the teachings of the sages of the Mishna, Spinoza had, apart from his studies, made himself master of a mechanical craft; he had learned the art of polishing lenses, and this now became the means of his subsistence.

When twenty-eight years old he left Amsterdam, and went to Rijnsburg, near Leyden, then the headquarters of a sect of the Remonstrants or Arminians, known as Collegiants, with one of whom he lived; and there he wrote the *Abridgment of the Meditations of Descartes*, with an Appendix—the latter being the first draft, so to say, of his *Ethica*. The year following he removed to Voorburg, a suburb of the Hague, and shortly afterwards, yielding to the solicitations of his, by this time, numerous friends, he removed to the Hague itself. The Elector Palatine, Charles Louis, next offered him a vacant chair at the university of Heidelberg, with full 'liberty of teaching,' provided he would not say aught to prejudice the established religion—i.e. Christianity; but Spinoza declined the lucrative and honourable professorship. His small pittance was enough to satisfy his wants. Similarly he refused generous offers made to him by wealthy friends, like Simon de Vries, who intended to bestow a large sum of money upon him; all he could be prevailed upon to accept was a small annuity of a few hundred florins. An offer of a pension, on the condition of his dedicating a work to Louis XIV., he rejected with scorn. His domestic accounts, found after his death, show that he preferred to live on a few pence a day rather than be indebted to another's bounty. He died, forty-four years old, on the 21st of February 1677. Throughout his life of study, of abstemiousness, of bodily and mental suffering—for his constitution was no less undermined by consumption and overwork than his sensitive mind was wrought upon by the violent severance of all natural ties of affection, to say nothing of the misery of occasional want and of perpetual persecution—no complaint ever passed his lips. Simplicity and heroic forbearance, coupled with an antique stoicism and a child-like, warm, sympathising heart, were the outstanding features of him who was nicknamed epicurean and atheist by his contemporaries.

Spinoza's philosophical system developed itself on the basis of Descartes (q.v.), who, dissatisfied with both the dogma and the scepticism around him, cleared the ground by first doubting everything, and then laying a new foundation in *Cogito, ergo sum*. Spinoza, however, took his 'I think, therefore I am' merely as a starting-point to establish not (as with Descartes) an unreconciled dualism of spirit and matter, but a pure Monism, of which the sole foundation is Substance—'that which is in itself and is conceived through itself;' with an infinite number of Attributes, of which thought and extension, or spirit and matter, are alone dealt with. Spinoza's one Substance, *causa sui*, he expressly calls God; yet this term is not to be understood in the ordinary sense, for Spinoza's God neither thinks nor creates. There is no real difference, he holds, between mind, as represented by God, and matter, as represented by Nature; they are One, and, according to the light undé'

which they are viewed, may be called either God or Nature. The visible world is not distinct from him. It is only his visible manifestation, flowing out of him, who is the first fountain of life and essence, as a finite from the infinite, variety from unity—a unity, moreover, in which all varieties merge again. Extension and thought, which with Descartes had been two Substances, with Spinoza become Attributes—that which the mind perceives as constituting Substance. Extension is visible Thought; Thought is invisible Extension. And this explains the relation between body and mind, and the perfect harmony between them. The mind is the idea of the body—i.e. the same thing considered under the attribute of thought. Substance as thought falls into an infinite number of Ideas, and as extension into an infinite number of Bodies. These Spinoza calls Modes. The *modus* or *accidens* is only the varying form of Substance. Like the curling waves of the ocean, the modes have no independent existence; they are simply the ever-varying shapes of the Substance. Substance thus is the only really existing, all-embracing essence, to which belongs every thing perceptible to our senses, and every thing not perceptible. Thus, every thought, wish, or feeling is a Mode of God's Attribute of thought; every thing visible is a Mode of God's Attribute of extension. God is the 'immanent idea,' the One and All, the *natura naturans*; World, *natura naturata*, is one complex whole and one peculiar aspect of God's infinite Attribute of extension. The variety we behold in things is a mere product of our faulty conceptions, particularly of what Spinoza terms our 'imagination,' which perceives unity as a complex of multiplicity. The connection of things is the same as the connection of ideas; we attain the truth only when, looking away from the multiplicity of ideas and of things, we behold God *sub specie eternitatis*.

His system is mainly contained in his *Ethica*, which is not a treatise of Ethics, but a complete philosophy. The *Ethica* he deduces in a mathematical form, after the method of Euclid, but with a stringency much more apparent than real. Chief doctrines are: The absence of free-will in man—himself only a *Modus* dependent on causes without, and not within him. Will and Liberty belong only to God, who is not limited by any other Substance. Good and Evil are relative notions, and sin is a mere negative; for nothing can be done against God's will, and there is no idea of Evil in him. Utility alone, in its highest sense, must determine the good and the evil in our mind. Good, or useful, is that which leads us to greater reality, which preserves and exalts our existence. Our real existence is knowledge. Highest knowledge is the knowledge of God. From this arises the highest delight of the spirit. Happiness is not the reward of virtue, but virtue itself; and this is to be attained by a diligent following in God's ways. Sin, evil, negation, &c. are merely things that retard and obstruct this supreme happiness. Spinoza's Pantheism was long regarded as 'the most iniquitous and blasphemous human invention,' and had few followers even in Holland. But in the 18th century it attracted the admiration of men such as Lessing, Herder, and Goethe, and became with Fichte, Schelling, and Hegel the acknowledged basis of much of modern German philosophy; and pious theologians like Schleiermacher did not hesitate to apply to Spinoza the epithet of 'pious, virtuous, God-intoxicated.'

Spinoza's principal works are *Renati Descartes Principia Philosophiæ Moræ Geometrico Demonstrata* (Amsterdam, 1663); *Tractatus Theologico-politicus* (anonymous, 1670); and, published as *Opera Posthuma*, in the year of Spinoza's death by Ludwig Meyer: *Ethica*

Ordine Geometrico Demonstrata (written in its essentials in 1662-65), *Tractatus Politicus*, *Tractatus de Intellectus Emendatione*, *Epistole*, *Compendium Grammaticæ Linguae Hebrææ*. Several minor treatises are lost; but the *Tractatus de Deo et Homine*, published in 1862, is a most valuable addition to our materials for tracing the development of Spinoza's system. The *Tractatus Theologico-politicus* contains an acute and rationalistic view of revelation, and in his biblical criticism Spinoza shows much more directly the influence of Maimonides than in his ethics. In his politics he has many points common with Hobbes. The literature on the Spinozistic philosophy is very copious, especially in Germany; Spinoza's life has even been made by Auerbach the subject of a romance. There are editions of Spinoza's works by Paulus (1803), Bruder (1846), and especially Van Vloten and Land (2 vols. 1882-83). There are translations of Spinoza's chief works by Elwes (1884), and of the *Ethica* by W. H. White (1883), as also by H. Smith (with an essay, *Spinoza and his Environment*, Cincinnati, 1886). There are English monographs on Spinoza by Sir F. Pollock (1880), Dr Martineau (1882), and Principal Caird (1888); works in German by Sigwart (1839), Thomas (1840), Camerer (1877), and Baltzer (1888); in French by Saintes (1842). See, besides Ueberweg and the other histories of philosophy, the bibliography by Van der Linde (Hague, 1871). A monument to Spinoza was erected at the Hague in 1880.

Spiræa, a genus of plants of the natural order Rosacæ, and of the sub-order Spirææ, in which the fruit consists of five or fewer capular carpels. The genus Spiræa has one or more follicular, many-seeded carpels. It contains a large number of species, natives of Europe, Asia, and America, herbaceous plants and low deciduous shrubs; of the herbaceous species two are natives of Britain, Dropwort (*S. filipendula*) and Meadow Sweet or Queen of the Meadow (*S. ulmaria*), both with interruptedly pinnate leaves and flowers in cymes.



Spiræa aruncus.

Dropwort is a native of dry upland pastures; it is tonic and fragrant; and its tubers, which are somewhat nutritious, are in Sweden ground and made into bread. Meadow Sweet is well known for the powerful fragrance of its flowers. A fragrant distilled water is prepared from them. A North American species (*S. tomentosa*), called Hardhack in the United States, is there used as a tonic and astringent. Many of the shrubby species are frequently planted for ornament.

Spiral Vessels. See STEM.

Spire, a very acute pyramidal roof in common use over the towers of churches. The history of

spires is somewhat obscure, but there is no doubt that the earliest examples of anything of the kind are the pyramidal roofs of the turrets of Norman date. Those of St Peter's, Oxford (fig. 1), and Rochester Cathedral (fig. 2) are good specimens of

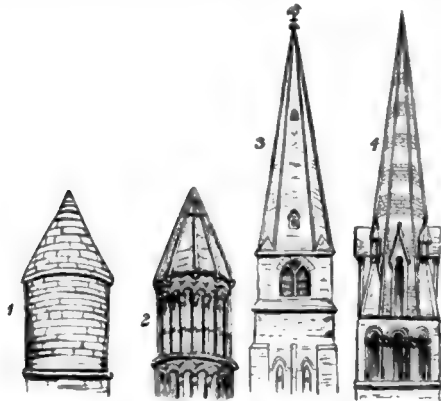

1, Turret, St Peter's Church, Oxford; 2, Turret, Rochester Cathedral; 3, St Mary's Church, Cheltenham; 4, Bayeux Cathedral, Normandy.

circular and octagonal pointed roofs, or spires in an embryo condition. Spires of this early period are much less acute than those of later date. The Early English style has spires of sharply pointed form over the larger towers. They are generally octagonal and what are termed broach spires—i.e. the slopes spring from the cornice of the tower without any parapet, and at the point where the square changes to the octagon there is a small set-off or separate roof (fig. 3). Sometimes the angles at top of towers were occupied with pinnacles or sloping masses of masonry, as at Bayeux Cathedral, Normandy (fig. 4).

In the Decorated style the spires were more ornamented, having generally a parapet and pinnacles at the top of the tower, crockets on the angles, and enriched windows. The spires of the Perpendicular and Flamboyant styles are still more enriched, with flying buttresses at the angles, &c. They are sometimes perforated, and the sides of the spire filled entirely with tracery. Such spires are common in Germany, those of Strasburg and Freiburg on the Rhine being very fine examples, as also that of St Stephen's, Vienna. As in the later styles generally, the character and beauty of the spire give place to dexterity in masonry, and many examples exist of traceried spires more wonderful than beautiful (see GOTHIC ARCHITECTURE). Spires are most frequently constructed of stone, but they are also occasionally made of wood, and covered with lead, copper, slates, or shingles. These are chiefly to be found in localities where stone is scarce. Among famous spires may be mentioned those of Ulm (530 feet), Cologne (q.v., 515), Rouen (of cast-iron, 487½), St Nicholas, Hamburg (482), Strasburg (465), Chartres (q.v., 371), and Salisbury (q.v., 404), the highest in England, as St Mary's Cathedral, Edinburgh (275), is the highest in Scotland, and St Patrick's Cathedral, New York (328), in America. With these heights may be compared the Eiffel Tower (985 feet), the Washington obelisk (555), the North Bridge (361), and the domes of St Peter's at Rome (435) and St Paul's in London (404).

Spires (Ger. *Speier*), the capital of the Bavarian Palatinate, stands on the left bank of the Rhine, 19 miles S. of Mannheim. The most noteworthy edifice is the Romanesque cathedral, built of red sandstone,

which has had a very chequered history. Begun by Conrad II. in 1030 and finished in 1061, it suffered from fire in the 12th, 13th, and 16th centuries, and in 1689 was stripped to the bare walls and even set fire to by the French, who also exhumed and scattered the bones of eight emperors of Germany (from Conrad II. to Albert I.) who lay buried in its crypt. Reconstructed in 1782, it was again desecrated by the French in 1794, but was once more rebuilt in 1797-1822. The interior walls are covered with more than thirty large frescoes by Schrandolph; statues of the eight emperors by Fernkorn (1858) adorn the vestibule; and in front of the west façade is the ancient 'Domnapp,' or cathedral basin. The town itself was also demolished by the French in 1689, and having been rebuilt since that date has broad though irregular streets, but very few ancient buildings, except the gateway or clock-tower (*alta porta*), dating from before 1246, and a few fragments of the imperial palace (Retscher), in which several diets were held. There are a museum, picture-gallery, botanical garden, and library. Pop. 17,587. There is some industry in cloth, paper, tobacco, sugar, &c. Spires was known in Roman times as *Augusta Nemeturum* and *Noviomagus*, but was known as *Spira* from the 7th century. Previous to that, however, it had experienced repeated disasters at the hands of the successive barbarian armies that swept westwards. The early emperors showed it considerable favour, and in the 13th century it became a free imperial city. Several imperial diets were held within its walls, especially that of 1529, at which the reformers first acquired the name of Protestants; and from 1513 to 1689 it was the seat of the supreme law-court of the empire. But the repeated devastations it endured in the Thirty Years' War and from the French (see above) ruined its prosperity. It was the capital of a department of France between 1801 and 1814, and in 1815 passed to Bavaria. See works by Remling (1858-61), Weiss (1877), and Hilgard (1885).

Spirifer, a genus of brachiopods. See the article CARBONIFEROUS SYSTEM.

Spirit, a name of very general application to fluids, mostly of a lighter specific character than water, and obtained by distillation. Thus, the essential oil of turpentine is called Spirit of Turpentine; a looser usage extended the name to Spirit of Nitre (nitric acid) and Spirit of Salt (hydrochloric acid). But in a stricter sense the term spirit is understood to mean Alcohol (q.v.) in its potable condition, of which there are very numerous varieties, deriving their special characters from the substances used in their production.

Spirit, HOLY, or HOLY GHOST, the third Person of the Trinity. The doctrine of the Spirit follows and depends on that of the Son in Scripture and in the development of dogma. It is significant for the whole subject that *ruach* and *pneuma*, Hebrew and Greek for spirit, literally mean 'wind' or 'breath.'

In the Old Testament 'the Spirit of God' is first the principle of life in creation (Gen. i. 2), in particular of man's life (ii. 7). Then to the Spirit are traced the special gifts, intellectual and even bodily, of the instruments of the theocracy, as Moses, Bezalel, Samson, and above all the prophets, who are the men of the Spirit. At length in the later writings—e.g. Ps. li. 11, cxliii. 10—the Spirit is called 'holy' and 'good,' and the agency comes to be spoken of chiefly as moral. But there is nothing at all decisive as to personality, and the action is temporary and external, and is not general except in predictions of the period to be introduced by the spirit-anointed Servant of the Lord,

when the Spirit is to be poured out on all (Joel, ii. 28).

In the New Testament the Spirit is throughout 'the Holy Spirit,' and is now also the 'Spirit of Christ,' the doctrine being conditioned by the two great facts, the coming of Christ, and His return to the Father. The Synoptists deal almost exclusively with the Spirit's influence on Christ Himself, especially in the miraculous conception of His humanity, and in the descent at His baptism, by which He is equipped for His office. But the fulfilment of the predicted baptism by Christ with the Holy Spirit (Matt. iii. 16, &c.; cf. Joel, ii. 28) is found in the Acts in the outpouring of the Spirit at Pentecost, and subsequently, by which not only the apostles, but disciples generally, are endowed with 'tongues' and other miraculous gifts of witness-bearing to Christ. All this, and the similar teaching of Peter and the author of the Hebrews, still runs largely on Old Testament lines. But in Paul and John, along with these representations, distinct developments are found. All the epistles of Paul contain his characteristic doctrine of the Spirit as the principle of the new life, in its beginning and progress. As such, the Spirit is the witness of sonship, the ground of fellowship with Christ, and of every Christian grace, and the earnest of complete salvation. Those so consecrated form the church, the temple of God, the body of Christ. John touches on Paul's view (John, iii. 5). But his special contribution is the farewell words of Christ (xiv. 16, 17, 26; xv. 26; xvi. 7-14), where the Spirit as the Paraclete (Advocate or Comforter) is first expressly presented as a person, proceeding from the Father, and to be sent after Christ's departure, that as the Spirit of truth He may confirm and complete the revelation already given in the Son. Thus, while the personality is implied in the baptismal formula (Matt. xxviii. 19) and the apostolic benediction (2 Cor. xiii. 14, and other passages), it comes clearly out only in the 'He' of this latest writer of the New Testament.

After apostolic times the church's faith in the Spirit was for long simply that of the baptismal formula held without dogmatic definition. Montanism, with its conception of the Spirit as still operating in the manner of the apostolic age, called attention to the subject. But it was as complementary to the doctrine of the person of Christ, the starting-point of the Trinitarian dogma, that the Spirit doctrine was elaborated, at first incidentally, then directly. The reply to the Gnostic emanation theories, and to the Sabellian view of the Trinity as merely modes of God's manifestation, helped to draw out the church's mind on the Spirit's essential deity and personality, though, in distinguishing the persons, Origen and others unduly subordinated the Son, and especially the Spirit. The doctrine was directly handled after the middle of the 4th century, when Arianism, which carried this subordination to the extreme in denying the deity of the Son, was explicitly extended to the Spirit by Eunomius, and diverted thereto by the Semi-Arians, hence called Pneumatomachi. Against their view that the Spirit is only a creature Athanasius and others brought the consubstantiality of the Spirit into line with that of the Son, and in 381 the Council of Constantinople added to the bare Nicene profession of faith in the Holy Spirit—the Lord, and giver of life, who proceedeth from the Father, who with the Father and Son together is worshipped and glorified, who spake by the prophets.' From that day to this almost all the divergencies from the church doctrine of the person have been of the Sabellian order. It remained to define the essential relation of the Spirit to the Son. Western theology tended to emphasise the unity of essence in the

Trinity, Eastern the Father as the fountain of godhead. Accordingly the doctrine of the Spirit's eternal procession from the Father and the Son (*Filioque*), fully developed by Augustine, rooted itself in the West, while in the East the procession was held to be from the Father only, or from the Father through the Son. At or before the Synod of Toledo in 589 the *Filioque* was inserted in the Creed of Constantinople, and this interpolation became one of the main causes of the schism between East and West. The churches of the Reformation accepted the procession from the Son, which as recently as 1875 was discussed at the Bonn conference between Easterns, Anglicans, and Old Catholics. But Protestantism was long naturally occupied rather with the Spirit's work. From strong interest in the latter peculiar views have sometimes emerged, not least in the religious movements of the 19th century, which has seen Montanism revived in Irvingitism.

The dogmatics of the Spirit, in its two divisions of the person and the work, encounters the two great problems of theology. In exhibiting the Spirit's work in conviction, regeneration, and sanctification, and also in inspiration, the relation of the Spirit's activity to man's falls to be determined. See CALVIN, ARMINIUS, JANSEN, WILL, and INSPIRATION. All progressive dogmatics not rationalistic addresses itself more and more to a thorough-going recognition of both factors. As for the Trinitarian problem, which has come again to the front, a stricter biblical theology has somewhat narrowed the basis of dogmatics, so far as the Scripture evidence of the Spirit's personality is concerned. And it is now more clearly recognised that not the ontological or essential, but the economic, Trinity—i.e. the Trinity in relation to man—is presented in Scripture, even the 'proceedeth' of John, xv. 26, being understood as temporal, not eternal. All the more does theology feel called upon to rise to the ontological Trinity, and labours, especially in Germany, to deduce it from the idea of the Divine self-consciousness, the Divine love, &c. Philosophy itself takes similar paths. Many, however, who call themselves Trinitarian are so only in a pantheistic or Sabellian sense, and regard the Spirit as merely a divine energy, or, with Schleiermacher, as God operative in the church.

Literature.—(1) Patristic: Athanasius, *Epistola ad Serapionem*; Didymus Alex., Basil the Great, and Ambrose, *De Spiritu Sancto*; Gregory Nazianzen, *Orationes de Theologia*, v.; Augustine, *De Trinitate*, iv. v. xv., *Tractatus in S. Joannem*, and *Contra Maximinum*. (2) Modern: Owen, *Pneumatologia* (1674), still, though prolix, the profoundest of the numerous English works; Heber, *Personality and Office of the Comforter* (Bampton Lectures, 1816); Burton, *Testimonies of the Anti-Nicene Fathers to the Divinity of the Holy Ghost* (Works, vol. ii. 1831); Hare, *Mission of the Comforter* (1846; 4th ed. 1877); Kahnis, *Die Lehre vom Heiligen Geiste* (Halle, 1847—historical); Cardinal Manning, *Temporal Mission of the Holy Ghost* (1865) and *Internal Mission of the Holy Ghost* (1877); Swete, *Early History of the Doctrine of the Holy Spirit* (Camb. 1873) and *History of the Doctrine of the Procession* (1876); Smeaton, *Doctrine of the Holy Spirit* (Cunningham Lectures, 1882). For the different departments of the subject reference should also be made to the standard works on biblical theology, the history of doctrines, and dogmatics. See also the articles CHRIST, TRINITY.

Spirit-fresco. See MURAL DECORATION.

Spirit-level. See LEVELLING.

Spiritualism (on the Continent usually termed Spiritism) is the name applied to a great and varied series of abnormal or pre-ter-normal phenomena purporting to be for the most part caused by spiritual beings, together with the belief thence arising of the intercommunion of the living and

the so-called dead. The following is a definition given in the London *Spiritual Magazine*, for many years the best exponent of the subject in Great Britain: 'Spiritualism is a science based solely on facts; it is neither speculative nor fanciful. On facts and facts alone, open to the whole world through an extensive and probably unlimited system of mediumship, it builds up a substantial psychology on the ground of strictest logical induction. Its cardinal truth, imperishably established on the experiments and experiences of millions of sane men and women, of all countries and creeds, is that of a world of spirits, and the continuity of the existence of the individual spirit through the momentary eclipse of death; as it disappears on earth reappearing in that spiritual world, and becoming an inhabitant amid the ever-augmenting population of the spiritual universe.'

The movement known as 'modern spiritualism' is usually considered to have commenced in the year 1848, with certain mysterious noises and movements occurring in a house temporarily occupied by Mr Fox and family at Hydeville in the state of New York; and his two daughters, Margaret and Kate, aged twelve and nine years respectively, were the first individuals recognised as mediums, in whose presence the phenomena more particularly occurred. It must not be supposed that the phenomena themselves were at all new. Throughout all history there are records of similar occurrences. Such were the disturbances at the ancient palace of Woodstock in 1649; at Mr Mompesson's at Tedworth in 1661; at Epworth parsonage in 1716, in the family of Mr Wesley, the father of the founder of Methodism; the Cock Lane ghost in London investigated by Dr Johnson, Bishop Percy, and other gentlemen; the extraordinary occurrences in the house of Mr Jobson in Sunderland in 1839, which were investigated and published by Dr Clanny, F.R.S., and authenticated by sixteen witnesses, including five physicians and surgeons; and numerous less important cases recorded in the works of William Howitt, Robert Dale Owen, Dr Engene Crowell, and many older writers. But none of these occurrences attracted much attention or led to any systematic investigation of the subject. What especially distinguishes the year 1848 is that it was the starting-point of a movement which has grown and spread continuously, till, in spite of ridicule, misrepresentation, and persecution, it has gained converts in every grade of society and in every civilised portion of the globe. Spiritualism is now to be found as frequently among the highest aristocracy as among the middle classes and the poor. It has its full proportion of believers in the foremost ranks of science, literature, and art, and in all the learned professions. In every European country, in America, and in Australia there are numerous periodicals which diffuse a knowledge of its phenomena, its teachings, and its philosophy; while it claims to have profoundly modified the teaching of some among our clergy as to the nature and purpose of the future life. These facts and characteristics broadly distinguish modern spiritualism as being very different from anything that has preceded it, and claim for it a respectful consideration.

When the knockings and movements of furniture were first heard and seen they were assumed to be due to some trick or other natural cause, and there was in every case and throughout the whole course of the movement a strong prejudice against any other explanation of them. When the Fox family could not detect this cause the neighbours were called in, but equally without result. It was soon observed that the more violent sounds or motions occurred in the presence or in the immediate vicinity of one or other of the little girls, and

every precaution was taken against possible trick on their part. They were closely watched, were held hand and foot, were tied in bags or put to stand barefooted on pillows, but all in vain. The raps or loud knockings on doors or tables, on floor or ceiling, occurred just the same. But this was only a part of the phenomena. It was observed that the noises occurred at request, or as if in reply to observations. Then the alphabet was used, and questions were answered by raps at certain letters which, when written down, formed connected words and sentences. In this way the statement was elicited that the sounds were made by the spirit of a man who had been murdered in the house and buried in the cellar. After several explorations human bones with charcoal and lime were discovered there. Some confirmatory evidence as to this murder was obtained, and some of the previous dwellers in the house stated that they also had been disturbed by unaccountable noises. The excitement caused by these occurrences was so great that in order to satisfy the curiosity of visitors the Fox family were obliged to submit to public exhibitions and tests of the remarkable phenomena occurring in the presence of their children, and thus public mediumship began. But at the same time other mediums were discovered in different parts of the country, as if a special development of this abnormal power were then occurring. A few of the more remarkable of these mediums may be here briefly referred to.

In 1845 an altogether illiterate youth, Andrew Jackson Davis, the son of a poor weaver and apprenticed to a shoemaker at Poughkeepsie, New York, began to exhibit remarkable powers as a trance speaker and a clairvoyant healer of diseases. During his trances he exhibited such extensive knowledge of subjects quite beyond his waking abilities or acquisitions as to attract the attention of learned men, and under their auspices he delivered in New York 157 lectures which were afterwards published in a volume of 800 pages. These powers have continued to be exerted during a long life. One of his disciples was Thomas Lake Harris (q.v.), whose *Lyric of the Golden Age*, a poem of 384 pages, was dictated in ninety-four hours, and in the opinion of William Howitt deserves the praise that has been given it of possessing almost Miltonic grandeur. Just about the same time (1846-50) the Davenport brothers began to exhibit the remarkable physical phenomena that puzzled so many observers in every part of the world; and it was about the year 1846 that the celebrated medium Home, then thirteen years old, had his first vision of a boy friend, 300 miles away, who intimated to him that he had died three days before at a certain hour, which was afterwards found to be perfectly correct.

Nature and Range of the Phenomena.—In almost every case the medium is a person who in youth sees visions and hears voices which often communicate intelligence of distant and sometimes future events quite unknown to himself or family. Following such phenomena, and apparently to attract the attention of other persons, noises usually occur; sometimes voices are heard, and sometimes musical sounds. Then follow movements of material objects, either visibly or more often in the dark, or in such a way that the result only is seen. Rooms and even houses are sometimes shaken; bells sometimes ring violently without material cause; flowers, fruits, or other objects are brought from a distance into closed rooms, sometimes of particular kinds as desired at the moment by those present. Another curious phenomenon is the tying and untying of knots. Sometimes the medium is tied in such a manner that it is plainly impossible he could have so tied himself; some-

times when tied by other persons, and the knots and ends of the cords out of his reach, he is almost instantaneously released. Knots are sometimes tied on endless cords in a manner impossible by human agency, as in the experiments of Professor Zöllner.

A frequent phenomenon is the playing on musical instruments without human agency, as on an accordion held by the medium by one hand, and sometimes when held by spectators. Closed pianos are sometimes played on, while accordions or tambourines are, as it were, floated in the air and played upon at the same time.

Writing or drawing is often performed without human agency. Sometimes the writing occurs on papers held or thrown under the table, or when placed in locked drawers, or enclosed between slates tied or screwed together. Sometimes the writing thus obtained is in answer to questions which may be spoken or written, and either known or unknown to the medium. The drawings are of various kinds. Some are on slates with pencil or chalks, some on paper. Very effective drawings in crayons, water-colours, or oils are produced with extreme rapidity and under conditions which render normal human agency impossible. A Scottish medium was accustomed to produce small landscapes in oils on cards privately marked by the witnesses and in total darkness, the result being seen with the paints still wet. These were usually effective and artistic works. In another case the space under a table was enclosed by a large shawl hanging to the ground. Marked cards were thrown underneath, and in from ten to fifteen seconds the drawings were complete. A number of these drawings were in the possession of the late Mr Benjamin Coleman, and were shown to the present writer. One in particular was on paper marked by Mr Coleman with two pin-holes by pins which were stuck through a small strip of paper which was kept as a proof of the identity of the paper so marked. The drawing that was made on this paper consisted of two birds holding a garland of flowers in their bills, and was so executed that the two pin-holes which had been made on the paper formed the eyes of the two birds, while their exact correspondence with the strip kept with the pins in it showed that the very paper Mr Coleman had so marked had been used. Lord Borthwick was present when these drawings were described, and confirmed Mr Coleman's account of them before the committee of the Dialectical Society in 1869.

One of the most striking of the physical phenomena is the levitation of the human body, which has occurred with many mediums, but has never been more thoroughly tested than with the late Mr Home. The extraordinary elongation of his body was also tested by many competent observers; while in his presence, as in that of some other mediums, heavy tables were often raised to a considerable height, or inclined at an angle of nearly 45°, without the numerous objects on the table, as books, glasses, lamps, &c., falling off.

A very marvellous phenomenon exhibited by Mr Home, and a very few other mediums, is the power of neutralising the action of fire, both in their own persons and in that of some of the spectators. Lord Lindsay (since 1880 Earl of Crawford) made the following statement before the Dialectical Society: 'I have frequently seen Home when in a trance go to the fire and take out large red-hot coals and carry them about in his hands, put them inside his shirt, &c. Eight times I have myself held a red-hot coal in my hands without injury, when it scorched my face on raising my hand. . . . A few weeks ago I was at a séance with eight others. Of these seven held a red-hot coal without pain, and the two others could not

bear the approach of it.' Lord Adare, Mr Jencken, and several others saw Mr Home stir the fire with his hands and then put his face right among the burning coals, moving it about as though bathing it in water. Mrs S. C. Hall, the Earl of Crawford, and several others saw Mr Home place a large lump of burning coal on Mr S. C. Hall's head and draw up his white hair over the red coal. It remained there several minutes. After it was taken away it burned the fingers of some who attempted to touch it. A number of other persons of the highest character have testified to similar occurrences with Mr Home.

Even more extraordinary, and still more remote from the normal powers of mankind, is the production of visible and tangible hands—which lift objects, and sometimes write, and then dissolve away—of faces, and even of entire figures, all under conditions which render imposture impossible. Both visible and invisible phantoms have had their objectivity proved by being photographed, and this has been done by experts who are above suspicion and under conditions which render the reality of the phenomena demonstrable. Both hands, feet, and faces of these phantom forms have produced moulds in melted paraffin, again under conditions which render imposture on the part of the mediums out of the question.

Yet another and final series of phenomena, which may be termed psychological or spiritual, are the seeing of spirits or spiritual forms invisible to others, hearing their voices, and by this means obtaining knowledge of circumstances occurring at a distance; or of facts unknown to any one present, but afterwards verified; or of future events which afterwards happen as predicted—of all of which there is ample evidence. Persons gifted with this power often give long and eloquent addresses, or have elaborate essays written through their hands, but without any conscious mental agency on their part; and it is from these communications that we acquire our most complete knowledge of the teaching and philosophy of modern spiritualism.

Some Characteristics of Mediums.—These numerous distinct classes of phenomena exhibit endless modifications in detail with different mediums, and there are several important considerations which are inconsistent with their being, to any considerable extent, due to imposture. In the first place, almost every medium exhibits his powers in youth or even in childhood without any opportunity of learning the methods employed by professional conjurers. In the second place, each medium exhibits considerable individuality, and rarely, perhaps never, offers an exact reproduction of the phenomena occurring with other mediums. In the third place, all the phenomena occur sometimes in private houses, to which the medium comes without any apparatus whatever. In the fourth place, every class of phenomena has occurred with unpaid mediums, as well as with those who make mediumship a profession. And lastly, many of the most remarkable mediums have submitted to elaborate and careful tests by scientific and intelligent observers with results wholly beyond the powers of professional conjurers.

Notable Investigators of the Phenomena.—In order to appreciate the important bearing of such investigations on the theory that the whole body of spiritualistic phenomena are due to delusion or imposture, a few of the best known of these inquirers must be referred to. Perhaps the earliest scientific investigator was Dr Robert Hare (q.v.) of Philadelphia, an eminent chemist, especially known for his invention of ingenious apparatus. He, like all other earnest and patient inquirers, began under the impression that he would be able to expose a delusion; but all his experiments and

tests, with apparatus of his own devising, proved that he had to deal with a great reality. He accordingly tried to induce the legislature to appoint a committee to examine and report on the experiments, and failing to succeed in this published his results in a volume entitled *Experimental Examination of the Spiritual Manifestations*.

Judge Edmonds, one of the most acute and painstaking of American lawyers, devoted years to a thorough examination of the phenomena, with the assistance of the most intelligent men of science and education among his acquaintance. He himself became a medium, as did his daughter; and this young lady, though possessing only the ordinary American school acquirements, was able when in a trance to speak many foreign languages, including modern Greek, and to hold conversations in them with natives.

Professors Mapes and Loomis, both chemists, assisted by two physicians and other friends, tested the Davenport brothers, and found that the phenomena occurring with them were in no way due to conjuring. This verdict was confirmed by many inquirers in England, among others by the late Sir Richard Burton, the last man to be imposed upon by conjuring, and to endorse it as reality. Yet he says, in a published letter, 'I have now witnessed four of the so-called dark séances. These were all in private houses—one of them in my own lodgings. We rejected all believers, and chose the most sceptical and hard-headed of our friends and acquaintances, some of whom had prepared the severest tests. We provided carefully against all possibility of confederates, and brought our own cords, sealing-wax, tape, diachylon, musical instruments, and so forth. . . . Sparks of red and pale fire have fallen from the ceiling, sometimes perpendicularly, at other times crossing the room. Mr Fay's coat was removed whilst he was securely fastened hand and foot, and a lucifer match was struck at the same instant showing us the two gentlemen fast bound and the coat in the air on its way to the other end of the room. . . . I have spent a great part of my life in oriental lands, and have seen there many magicians. . . . I have read and listened to every explanation of the Davenport "tricks" hitherto placed before the public, and if anything would make me take that tremendous leap "from matter to spirit," it is the utter and complete unreason of the reasons by which the manifestations are explained.'

Among other investigators of known integrity and ability are Robert Dale Owen and Dr Robert Chambers, who investigated the phenomena with Kate Fox in New York, while the latter was the friend of Home, and wrote for him the introductory chapter and the appendix to his *Incidents of my Life*. Dr George Sexton, an earnest secularist teacher and lecturer, was converted by phenomena occurring in his own house and through mediums who were members of his own family or personal friends; and he afterwards investigated the materialisation phenomena occurring through Miss Cook. Mr Cromwell Varley, the electrician, tested the same phenomena by means of electrical apparatus. Dr Lockhart Robinson, after a long experience in the treatment of the insane, and having been a violent opponent of spiritualism as wholly founded on imposture and delusion, was converted by phenomena occurring in his own house in the presence of the American medium Squire. Professor Zöllner of Leipzig, in his work *Transcendental Physics*, has described the most marvellous phenomena occurring in his own study and under the strictest test conditions, in the presence of the medium Slade with some of his fellow-professors as witnesses. And lastly, we have Mr William Crookes, one of the first chemists and physicists in

Europe, who for several years (from 1870 to 1874) devoted a considerable portion of his time to the investigation of the phenomena, and had the courage to make public these experiments and their results. With several different mediums, in his own house and subject to the conditions of scientific experiment, he satisfied himself of the reality of the whole range of the phenomena here briefly described. So recently as 1889 he has published his notes of several séances with Mr Home, in the introductory observations to which he makes this important statement: 'Their publication will at any rate show that I have not changed my mind; that on dispassionate review of statements put forth by me nearly twenty years ago I find nothing to retract or to alter. I have discovered no flaw in the experiments then made, or in the reasoning I based upon them.'

The Value of these Phenomena.—In view of this long series of investigations by men of special training in science and of the highest reputation, spiritualists urge that the facts on which their beliefs are based are proved to be realities beyond all reasonable doubt. It may be asked, however, as many do ask, what is the meaning or the use of these strange phenomena? We feel no interest in moving furniture, floating bodies, fire-tests, or slate-writing. The answer is that to a very large number of minds these physical phenomena, however low and trivial they may seem, are the most effectual and often the only means of compelling attention to the subject, and this is more particularly the case with those imbued with the teachings of modern science. The moment such persons are really convinced that physical phenomena occur which they have always held and declared to be impossible, they see that there is something more in the matter than imposture or delusion, and further inquiry shows them that this class of facts constitute the mere outskirts of the subject. Almost all the agnostics and students of physical science who have become spiritualists—and they are to be counted by hundreds in every civilised country—have begun the investigation because they have been convinced that some of these lower physical phenomena are realities; and this fact is a complete answer to those who urge that such phenomena are trivial, degrading, and unspiritual. If they are so, it shows that men of the highest education and greatest knowledge are attracted by these very qualities.

The Teaching and Philosophy of Spiritualism.—But whenever we pass beyond these phenomena, and carefully examine the teachings and the philosophy to be found in the deliverances of automatic writers and trance-speakers, as well as in the normal writings of those who have long accepted and thoroughly assimilated these teachings, we enter upon a phase of the subject which no unprejudiced person will pronounce to be either useless or commonplace. The universal teaching of modern spiritualism is that the world and the whole material universe exist for the purpose of developing spiritual beings—that death is simply a transition from material existence to the first grade of spirit-life—and that our happiness and the degree of our progress will be wholly dependent upon the use we have made of our faculties and opportunities here. It is urged that the present life will assume a new value and interest when men are brought up not merely in the vacillating and questionable belief, but in the settled, indubitable conviction, that our existence in this world is really but one of the stages in an endless career, and that the thoughts we think and the deeds we do here will certainly affect our condition and the very form and organic expression of our personality hereafter.

As an example of the teaching of modern spiritualism as actually given through one of the most intelligent spiritualists and most trustworthy mediums, the following short passages from *Spirit Teachings*, by M.A., Oxon., must here suffice: 'As the soul lives in the earth-life, so it goes to the spirit-life. Its tastes, its predilections, its habits, its antipathies, they are with it still. It is not changed save in the accident of being freed from the body. The soul that on earth has been low in taste and impure in habit does not change its nature by passing from the earth-sphere any more than the soul that has been truthful, pure, and progressive becomes base and bad by death. . . . The soul's character has been a daily, hourly growth. It has not been an overlaying of the soul with that which can be thrown off; rather it has been a weaving into the nature of the spirit that which becomes part of itself, identified with its nature, inseparable from its character. It is no more possible that that character should be undone, save by the slow process of obliteration, than that a woven fabric should be rudely cut and the threads remain intact. Nay more; the soul has cultivated habits that have become so engrained as to be essential parts of its individuality. The spirit that has yielded to the lusts of a sensual body becomes in the end their slave. It would not be happy in the midst of purity and refinement. It would sigh for its old haunts and habits. They are of its essence' (p. 13).

'Immutable laws govern the results of deeds. Deeds of good advance the spirit, whilst deeds of evil degrade and retard it. Happiness is found in progress, and in gradual assimilation to the God-like and perfect. The spirit of divine love animates the acts, and in mutual blessing the spirits find their happiness. For them there is no craving for sluggish idleness, no cessation of desire for progressive advancement in knowledge. Human passions and human needs and wishes are gone with the body, and the spirit lives a life of purity, progress, and love. Such is its heaven. We know of no hell save that within the soul: a hell which is fed by the flame of unpurified and untamed lust and passion, which is kept alive by remorse and agony of sorrow, which is fraught with the pangs that spring unbidden from the results of past misdeeds; and from which the only escape lies in retracing the steps and in cultivating the qualities which bear fruit in love and knowledge of God' (p. 77).

'We may sum up man's highest duty as a spiritual entity in the word Progress—in knowledge of himself, and of all that makes for spiritual development. The duty of man considered as an intellectual being, possessed of mind and intelligence, is summed up in the word Culture in all its infinite ramifications, not in one direction only, but in all; not for earthly aims alone, but for the grand purpose of developing the faculties which are to be perpetuated in endless development. Man's duty to himself as a spirit incarnated in a body of flesh is Purity in thought, word, and act. In these three words, Progress, Culture, Purity, we roughly sum up man's duty to himself as a spiritual, an intellectual, and a corporeal being' (p. 154).

The following works have been consulted in writing this article: *The History of the Supernatural*, by William Howitt (2 vols.); *Footfalls on the Boundary of Another World* and *The Debatable Land between this World and the Next*, by Robert Dale Owen; *Planchette, or the Despair of Science and The Proof Palpable of Immortality*, by Epes Sargent; *Report on Spiritualism of the Committee of the London Dialectical Society*; *Primitive Christianity and Modern Spiritualism*, by Eugene Crowell, M.D.; *Researches in the Phenomena of*

Spiritualism, by William Crookes, F.R.S.; *Miracles and Modern Spiritualism*, by the present writer; *Transcendental Physics*, by Professor Zöllner (trans. by C. C. Massey); *Spirit Teachings*, by M. A., Oxon.; *D. D. Home*, by Mme. Home. [On the other side see De Gasparin, *Des Tables Tournantes* (1854); trans. as *Science versus Spiritualism*; Myers, *Science and a Future Life* (1893); E. Hart, *Hypnotism, Mesmerism, and the New Magic* (1893); A. Lang, *Cock Lane and Common Sense* (1894).] AND ANIMAL MAGNETISM, HYPNOTISM, THEOSOPHY.—[Ed.]

Spitalfields, in north-east London, derives its name from the *hospital* of St Mary, founded (1197) by Walter Brune and his wife Rosa. Silk manufactures were established here by French *émigrés* after the revocation of the Edict of Nantes (1685).

Spithead, a celebrated roadstead on the south coast of England, and a favourite rendezvous of the British navy, is the eastern division—the Solent (q.v.) being the western—of the strait that separates the Isle of Wight from the mainland. It is protected from all winds, except those from the south-east, and its noted security warranted the name which has been applied to it by sailors of the 'king's bedchamber.' It receives its name from the 'Spit,' a sandbank stretching south from the Hampshire shore for 3 miles; and it is 14 miles long by about 4 miles in average breadth. Here in 1797 the sailors of the Channel Fleet mutinied for more liberal pay and allowances, which were granted to them. Spithead has been strongly defended since 1864 by fortifications completing those of Portsmouth (q.v.).

Spitz or **Pomeranian Dog**, the result of a cross from the Esquimaux dog, the native dog of the Arctic regions. The spitz is about the size of the spaniel, with a sharp-pointed face and an abundant white coat sometimes of great beauty. Other colours are known, including black. As the spitz is useful for no kind of work, and is generally bad-tempered, this breed is rarely seen in England. It is comparatively common in the United States, where it is a favourite dog with Germans especially, and where many of the deaths in the hot months from hydrophobia have been due to its bite.

Spitzbergen, a group of Arctic islands, lying 400 miles N. of Norway, and consisting of West Spitzbergen (15,260 sq. m.), North-east Land (4040 sq. m.), Stans Foreland (2210 sq. m.), the three islands called King Charles Land or Wiche Island (also identified with Gillis Land), Barents Land, Prince Charles Foreland, and several smaller islands and clusters of islets. The whole is ice-bound, and there are magnificent glaciers on the eastern shores, especially on North-east Land, where Dickson's glacier has a length of more than 150 miles. A thick ice-sheet covers the whole of the interior of the larger islands; but several sharp peaks—whence the name Spitz ('needle-like')-bergen ('mountains')—project above it. These peaks are generally close upon 2000 feet in altitude; but one at least, Hornsund Tind, at the southern extremity of West Spitzbergen, reaches 4560 feet, and on the small island of Prince Charles Foreland, lying to the west of West Spitzbergen, there are peaks nearly 5000 feet in height. The shores of West Spitzbergen, except on the east, are deeply indented with fjords; two, Ice Fjord, stretching north-east and north, and Wiide Bay, coming southwards, almost meet and cut the island in two. The north-west shores of North-east Land are also very much broken. The eastern shores generally are difficult of access, owing to their being swept by a cold Arctic current from the north. But the Gulf Stream sweeps up along the west side of the group, and very considerably modifies the climate. The mean yearly climate seems to vary from 10° to 16° F. in different years. The vegetation, which was wonderfully luxuriant

in the Miocene period, is now very scanty; except for the polar willow and a couple of berry-bushes, it consists principally of saxifrages and mosses. The reindeer were, from markings on their ears (said by Nordenskiöld to be due to the cold), believed to come hither for the summer only! The arctic fox and polar bear are the only other land animals that frequent the islands, though there are vast swarms of sea-fowl of various kinds (gulls, petrels, the eider-duck, wild geese, rotches, the snow-bunting, and others), several of which make these islands their breeding-quarters. The sea-waters round the coasts are exceptionally rich in marine fauna. During the 16th and 17th centuries large fleets of whalers from the North Sea countries and from Russia used to make these islands their headquarters during the summer. But the whales have been almost exterminated, and the seals are rapidly approaching the same condition owing to reckless slaughter. The only frequenters of the group now are Norwegian walrus hunters and Swedish scientific explorers, who since 1858 have been unwearied in their efforts to obtain full information about the islands of the archipelago. There are no permanent inhabitants; but at times hardy Russian and Norwegian hunters have stayed one and occasionally more winters on the group. The Spitzbergen islands were discovered by Barents in 1596, and have been made the starting-point of attempts to reach the North Pole. Here in 1861 and 1864 Nordenskiöld measured an arc of meridian. Sir M. Conway explored the main island in 1896.

See Lord Dufferin's *Letters from High Latitudes* (1857); Kropotkin's paper in *Encyc. Brit.*; and Sir W. M. Conway, *The First Crossing of Spitzbergen* (1897).

Splay. See CHAMFER.

Spleen. This organ, present in vertebrates from the fishes upwards, has no doubt very important functions to perform, but about these we know as yet very little indeed. It is of the size and shape of a rather long halfpenny bun, and is situated in the left hypochondriac region, clasping by its flat surface the cardiac portion of the stomach (see figure at article ABDOMEN). Unlike the liver and pancreas, it has no duct and manufactures no juice, being connected with the rest of the body by its blood-vessels, nerves, and lymphatics: these enter the organ at its hylus and ramify within it. The spleen is invested by a capsule consisting chiefly of muscular tissue, and from this capsule muscular processes called trabecule run into the interior of the organ supporting its delicate pulp. As one would expect from its structure, the organ can expand and contract, and this it does from a variety of causes—for instance, after a meal the organ expands, reaching its maximum in about five hours, then contracting again. In diseased conditions it may expand to several times its normal size, which would not be possible were its capsule of fibrous tissue like those of other glands. The blood-vessels enter the spleen, and the arteries become invested by curious masses of tissue called adenoid, and these little masses, the splenic corpuscles, are of about the size of millet seed, and quite visible to the naked eye on cutting open the organ.

If the spleen of a man or an ox be cut open it will appear of a soft pulpy consistence and deep crimson in colour, with little white patches, these splenic corpuscles, scattered through it. On putting the spleen under a running jet of water the soft spleen pulp infiltrated with blood will be washed away, leaving behind the tough capsule, the branching trabecule, and the blood-vessels with some of these splenic corpuscles attached to them. The blood-vessels end in the tissue of the spleen, and those that terminate within the splenic bodies

do so in the usual way, passing into true capillaries. Within the spleen pulp, however, which forms the chief part of the organ, the arteries open directly into the loose tissue forming the pulp, so that the blood percolates through this before leaving the organ by the veins. The blood thus becomes intimately associated with this pulpy tissue, and becomes modified by it, as we shall see. It is highly probable that the chief use of the spleen is to modify the blood passing through it, and hence it is spoken of as a blood-gland, in contradistinction to a digestive gland, which pours its secretion into the digestive tract, and aids the processes which go on there. It is very probable that the spleen has the power of arresting and destroying the old worn-out red blood-corpuscles as they pass through it, for within the spleen itself evidence of their destruction is found in the large quantity ever present of iron and other bodies, which would result from their dissolution. Moreover there is strong reason for supposing that the active agents in this destruction are the cells present in the spleen pulp, some of which are generally found with bits of the red blood-corpuscles, and pigmented masses derived from them, within their bodies. But the spleen not only destroys blood-corpuscles; it forms new ones, and these are poured out of the pulp into the splenic vein, and are carried off in the general circulation. Most of these new corpuscles appear to be of the white variety, for an abnormally large number of these are by some observers found in the splenic vein, these white corpuscles changing, aided by the spleen itself, into red ones.

There is little doubt that in a general way the spleen is a blood-modifying gland, and in diseases such as splenic leucocythemia it becomes enormously enlarged, and produces large numbers of white corpuscles. In intermittent fever it is also enormously enlarged, forming the ague-cake. It may, however, be excised, even in the case of man, without producing fatal consequences, the lymphatic glands enlarging and the bone marrow undergoing changes, probably to enable them to compensate for the loss of the other organ.

The spleen was long supposed to be the seat of some of the less amiable emotions—envy, malice, &c.

Spleenwort, any fern of the genus *Asplenium*. See FERNS, Vol. IV. p. 590.

Splenic Fever. See ANTHRAX.

Splining. See KNOTS.

Splint, or **SPLINT**, is a bony enlargement on the horse's leg, between the knee and fetlock, usually appearing on the inside of one or both fore-legs, frequently situated between the large and small canon bones, depending upon concussion, and most common in young horses that have been rattled rapidly along hard roads before their bones are consolidated. When of recent and rapid growth, the splint is hot and tender and causes lameness, especially noticeable when the horse is trotted along a hard road. A piece of spongiopiline saturated with cold water should be applied to the splint, kept in position with a light linen bandage, and wetted with cold water or a refrigerant mixture every hour. Perfect rest must be enjoined for ten days or a fortnight. When the limb is cool and free from tenderness, the swelling, which will still remain, may be greatly reduced by some stimulating applications, such as the ointment of the red iodide of mercury, the common fly-blisters, or the firing-iron. For the splint-bones, see HORSE, Vol. V. p. 790.

Splints, in Surgery, are certain mechanical contrivances for keeping a fractured limb in its proper position, and for preventing any motion of

the ends of the broken bone; they are also employed for securing perfect immobility of the parts to which they are applied in other cases, as in diseased joints, after resection of joints, &c.

Ordinary splints are composed of wood carved to the shape of the limb, and padded; the best pads being made out of old blankets, which should be cut into strips long and wide enough to line the splints, and laid in sufficient number upon one another to give the requisite softness. The splints should be firmly bound to the limb with pieces of bandage, or with straps and buckles; care being taken that they are put on sufficiently tight to keep the parts immovable, and to prevent muscular spasm, but not so tight as to induce discomfort. Gutta-percha, sole-leather, or pasteboard, after having been softened in boiling water, may in some cases advantageously take the place of wooden splints. They must be applied when soft to the part they are intended to support, so as to take a perfect mould, and then be dried, stiffened, and, if necessary, lined. Perforated tin or zinc is sometimes used to form splints. An account of the more complicated kinds of splint required in certain cases, as Macintyre's Splint, Liston's Splint, &c., may be seen in any illustrated catalogue of surgical instruments.

The ordinary splint is now to a great degree superseded by immovable bandages, which consist of the ordinary bandage saturated with a thick mucilage of starch, with glue, or with water-glass (a solution of silicate of soda). As, however, these bandages require some hours to dry and become rigid, means must be used to counteract any displacement of the limb in the interval. On this account many surgeons prefer the plaster of Paris or gypsum bandage, which is applied in the following manner: the limb being protected by a layer of cotton-wool, a bandage composed of coarse and open material, into which as much dry powdered gypsum as possible has been rubbed, must be immersed in water for about a minute, and then rolled around the limb in a spiral manner, just as an ordinary bandage; after every second or third turn of the bandage, the left hand of the surgeon should be plunged into water, and smeared over the part last applied. When the whole has been thus treated, the exterior of the bandage should be smeared over with a paste of gypsum and water until a smooth surface and complete rigidity have been attained—a process not occupying more than ten minutes or a quarter of an hour.

Splügen, an Alpine pass in the Grisons, Switzerland, situated at an altitude of 6946 feet. It connects the valley of the Farther Rhine with that of a tributary of the Adda, and has been used for crossing the Alps since the time of the Romans. The existing road, 24 miles long and 14½ feet wide throughout, was made by the Austrian government in 1812-22. It is protected against avalanches by several galleries and refuges.

Spohr, LUDWIG, composer and violinist, was born at Brunswick on 5th April 1784. His talent for music was shown early, and attracted the notice of the duke, who lent him valuable support in his studies. This patronage he justified by establishing a high reputation as a performer on the violin. In 1805 he was appointed music director at the court of Saxe-Gotha, but gave up that post in 1813 to become music director of the Theater an der Wien at Vienna. There, however, he stayed only two years, and afterwards spent a similar period (1817-19) in a similar position at Frankfort-on-the-Main. In 1820 he appeared in London, where he was received with great applause at the Philharmonic Society's concerts. On the recommendation of Weber, he was in January

1822 appointed Kapellmeister at the court of Hesse-Cassel, which post he continued to hold till 1857. He died on 22d October 1859. The best of his numerous musical compositions are the operas *Faust*, *Jessonda*, and *Zemira und Azor*; the oratorios *Die letzten Dinge*, *Des Heilands letzte Stunden*, and *Der Fall Babylons*; nine grand symphonies, the finest *Die Weihe der Töne*; fifteen very highly esteemed violin concertos; besides sonatas for violin and harp, fantasias, and rondos. *Die letzten Dinge*, or *Last Judgment*, is a very grand and attractive work; so also is *Der Fall Babylons*, first produced at a Norwich musical festival (1842). As a violinist Spohr deservedly ranks as one of the greatest amongst German masters of the instrument. His *Violinschule*, a manual for advanced violin-players, is almost indispensable for any student who aspires to mastery of technique as a performer.

See his Autobiography (Eng. trans. 1864), and biographies by Malibran (1860) and Schletterer (1881).

Spokane, the third city of Washington, the metropolis of the eastern portion of the state, on the Spokane River and on several railroads, by the Union Pacific 481 miles NE. of Portland, Oregon. It is largely engaged in the lumber trade. A fire in August 1889 destroyed some \$6,000,000 worth of property. But the city is chiefly remarkable for its rapid growth. Pop. (1880) 350; (1890) 19,922; (1900) 36,848.

Spoleto (Lat. *Spoletium*), an archiepiscopal city of ancient Umbria in the middle of Italy, is situated on a rocky hill, 75 miles by rail N. by E. of Rome. It is commanded by a citadel, which dates from the days of the Goths, and has a fine cathedral, built in the time of the Lombard dukes, and containing fine frescoes by Lippo Lippi. The churches of St Domenico, St Peter, St Gregory, and St Nicholas present interesting architectural features. Water is brought to the city by a 7th-century aqueduct, 270 feet high and 680 long. The ancient *Spoletium* had its origin in a Roman colony planted here about 240 B.C.; Hannibal (q.v.) was repulsed in an assault he made on the town (217 B.C.) after the battle of Lake Trasimene. Under the Lombards it became the capital of an independent duchy, and its dukes ruled over great part of Central Italy. Having been united to Tuscany, it was bequeathed by the Countess Matilda to the pope (1115). Spoleto has manufactures of woollens and hats. Pop. 7696.

Sponges (*Porifera*), a class of animals whose type of structure is simpler than that of all the other multicellular forms or Metazoa. For the body of a sponge is not differentiated into organs, and tissues are only, as it were, in the making. Almost all are marine, occurring from the shore to the great depths. Except as embryos, they are always fixed to rocks, or in the mud, or upon seaweeds, or on other animals. Their sedentary life, the usual absence of any marked contractility, their frequently herb-like growth, and other characters, led early naturalists to regard sponges as plants; but their animal nature is at once evident when we examine into their internal structure and activities, or when we trace their development. Yet they remained puzzles for centuries. Peyssonnel regarded them as worm-nests, for were not worms found inside of them? Lamarck thought they were colonies of polypes, but the polypes were not to be seen. In popular classification they were ranked with seaweeds. A great step was made when, about 1820-25, Robert Grant observed the water-currents which pass in by minute pores all over the surface and pass out by the larger apertures. Since then our knowledge of sponges has been rapidly progressive.

If we examine a very simple sponge, such as *Ascetta*, we see a small vase-shaped body, fixed at its base, open at the apex. Examined microscopically this vase shows an internal layer of ciliated cells, a very delicate external skin, and between these a middle stratum in which lie numerous needles of lime, which form the supporting skeleton of the sponge. Through the walls run numerous fine canals, and if we observe a larger sponge living in water with which a little powdered carmine has been mixed we can verify Grant's observation that water passes in by minute pores all over the surface and passes out by the larger apical apertures. On these currents of water, which continually



Fig. 1.—Section through wall of *Syccilla chrysalis*, showing various kinds of spicules, and pores in the wall.

feed and refresh the body, the life of the sponge depends. Every Metazoon organism is 'a city of cells'—a sponge is peculiarly Venice-like. The currents

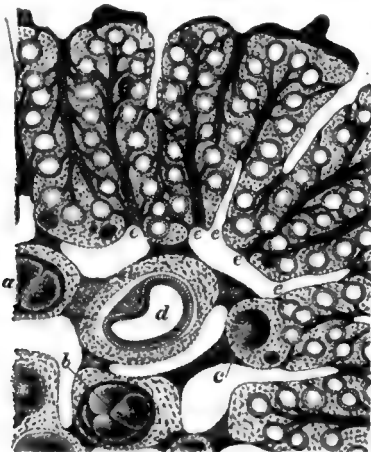

Fig. 2.—Section of part of a Sponge, *Oscarella lobularis* (after Schulze), showing afferent canals, ciliated chambers, efferent canals, internal cavities (e, e), segmenting ova (a, b, c, d).

are sustained by the activity of the internal ciliated cells, which by their ceaseless lashing draw the water inwards and drive it also outwards, and at the same time absorb food-particles which drift along in the current.

But few sponges are so simple as the vase-like *Ascetta*; we are familiar, for instance, with the complex 'horny' skeleton of the bath-sponge (*Euspongia*), or with the beautiful flinty framework of the Venus' Flower-basket (*Euplectella*); and an examination of the fresh-water sponge (*Spongilla*) of the lake or canal, or of the Mermaids' Gloves (*Chalina*) so often cast up half alive on the beach, convinces us that the structure of the soft parts is



Fig. 3.—Figure of *Leucandra saccharata*, showing mode of growth by budding.

also relatively complex. Yet with the simple primitive cups, the most complex forms are connected by a gradual series of steps, and simple cups they all are when very young. Let us consider briefly how the complication of structure is brought about.

(1) The vegetative character of sponges is shown by the prolific way in which buds grow out from the parent body. These buds may produce other buds, and the walls of neighbour-buds may fuse; in this way there arise from an original sac-like form complex structures puzzling to those who seek logical clearness as to the nature of animal individuality (see fig. 3).

(2) In the simple *Ascon* type the internal cavity is lined by the characteristic *Monad*-like, 'collared,' ciliated cells. If this layer grow more rapidly than the outer strata it will naturally become folded into a number of side-aisles, and this is seen in the *Sycon* type of calcareous sponges, in which the characteristic collared and ciliated cells are restricted to a series of radial chambers around the central cavity. If a similar process of folding occur in the radial chambers the characteristic collared and ciliated cells become restricted to little ciliated ampullæ or chambers, which afferent canals from the surface enter, and from which efferent canals lead to the central cavity and thence outwards. This is the state of affairs in the *Leucon* type of calcareous sponges, and, with further complications, in the great majority of forms.

(3) Another seat of complication is the middle stratum. This is called the *mesogloea* in order to emphasise the fact that in sponges, as also in *Cœlenterates*, it has not the same definiteness as the middle layer or *mesoderm* which occurs in the *Cœlomata*, that is, in all animals higher than *Cœlenterata*. In the simple sponges the middle stratum is very simple, and always it seems to owe its units to contributions from the inner layer or *endoderm*. In more complex forms, however, the *mesogloea* contains a great variety of cells: some skeleton-making, others contractile, others like simple connective tissue, others full of pigment, others forming reproductive elements, and so on. In sponges the outer layer or *ectoderm* is always unimportant, though it may line the outer portions of the inhalent canals; the *mesoderm* forms the skeleton and contains the reproductive elements; the inner layer or *endoderm* is very important, including, as it does, the collared ciliated cells which cause the water-currents and absorb the food, as well as other flattened and often ciliated cells which line the efferent channels.

Life of Sponges.—Although sponges do not move, there is great motor activity in the ciliated cells of the *endoderm*. Like many other passive organisms sponges are profoundly influenced by their surroundings, for their shapes vary according to the nature of their anchorage and the currents which play around them. Sensitiveness to stimulus is shown by the closure of the little superficial pores and sometimes even of the larger exhalent aperture or apertures. This closure is due to special contractile-cells in the *mesogloea*, and in some cases it seems that these are connected with sensitive and nervous cells on the surface. The food of sponges consists of microscopic organisms and particles of organic debris, which are borne by the water-currents, and caught by the ciliated cells which, like so many *Monads*, swallow first and digest intracellularly afterwards. From the cells which feed surplus nutritive material oozes to adjacent cells, or is passed to mobile amoeboid cells in the *mesogloea*. Useless debris is also got rid of by the collared cells. Respiration is of course effected by the currents of water which wash the cells, and some of the bright pigments, such as *floridine*, characteristic of many sponges, readily absorb

oxygen. The green pigment of *Spongilla* is at least closely analogous to chlorophyll.

Reproduction.—Sponges multiply, like many plants, by overgrowth and budding, but the buds remain continuous with the parent mass, though sometimes it happens that small portions are set adrift from a moribund body. As a sponge is but slightly differentiated, as a fragment is a fair sample of the whole body, we can understand the success with which the sponge-farmers bed out portions of sponge in suitable places, leaving them to grow to a size fit for use. But sexual reproduction also occurs in all sponges. The ova and spermatozoa are included in the mesogloea, originating from apparently similar cells. Both unisexual and bisexual forms occur, in rare cases within one species. The ova are fertilised by spermatozoa drawn in by the water-currents, and development proceeds through several stages before the embryo leaves the parent (see fig. 2).

The life-history of the fresh-water sponge, *Spongilla*, as told by Marshall, is one of interesting vicissitudes. In autumn the sponge begins to suffer from the cold and the scarcity of food, and dies away. But throughout the moribund parent clumps of cells combine into 'gemmules,' which are furnished with capstan-like spicules, and are able to survive the winter. In April or May they float away from the parental corpse, and form new sponges. Some of these are short-lived males, others are more stable females. The ova produced by the latter, and fertilised by the cells of the former, develop into another generation of sponges, which in turn die away in autumn, and give rise to gemmules. The life-history thus illustrates Alternation of Generations (q.v.).

Development.—The development of sponges varies considerably in the different types, but we may

sketch that of a calcareous sponge. The fertilised ovum divides completely, and forms a hollow sphere of in part ciliated cells, which escapes from the parent into the water. In the course of a short free-swimming life the ball of cells becomes invaginated, and forms a two-layered gastrula. This fixes itself, mouth downwards. But pores soon appear through the walls; the internal cells which had meanwhile lost their cilia regain them; an exhalant orifice is formed by rupture at the apex; a middle stratum is derived from the inner layer and begins to form spicules; the young sponge is made.

Classification.—One of the oldest and most convenient classifications of

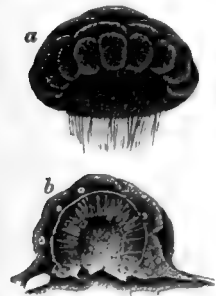

Fig. 4.—Two stages in the development of *Sycandra raphanus* (after Schulze):

a, gastrula, towards end of free-swimming stage; b, section of embryo after it has settled down, showing the two germinal layers and the central cavity.

sponges is that which distinguishes three main sets according to the nature of the skeleton:

- (1) **CALCISPONGIÆ:** with spicules of carbonate of lime, including *Ascon*, *Sycon*, and *Leucos* types. The purse-like *Sycandra* (or *Gracilia compressa*) is common on British shores.
- (2) **SILICISPONGIÆ:** with spicules and threads of silica—e.g. the Venus Flower-basket (*Euplectella*); the likewise deep-sea Glass-rose Sponge (*Hyalonema*); Mermaids' Gloves (*Chalina oculata*), with a fibrous as well as a flinty skeleton; the common Crumb-of-bread Sponge (*Haltichondria panicea*); Clione, which bores in oyster shells; *Suberites domuncula*, which grows round a whelk shell inhabited by a hermit-crab; and the fresh-water *Spongilla*.
- (3) **CERATOSPONGIÆ:** with a framework of spongin or sponge-stuff and no proper spicules—e.g. the Bath-sponge (*Euspongia*), which thrives on some of the Mediterranean coasts.

To these may be added a few, probably degenerate, forms which have no skeleton at all (Myxospongizæ)—e.g. *Oscarella* (or *Halisarca*) *lobularis*.

History.—Sponges, as we should expect, occur in very ancient strata; remains of a flinty form (Protospongia) have been found in Cambrian strata. In succeeding ages they are almost always represented. Remains of calcareous forms are almost confined to one peculiar set of large forms (Pharetrones) in Devonian and several succeeding epochs. Professor Franz Eilhard Schulze—the greatest authority on sponges—divides the sponge branch of the genealogical tree into three: the calcareous forms to one side, the siliceous Hexactinellida with triaxial spicules to the other, and between these the other flinty sponges whose spicules have four axes (Tetraxonia) or only one (Monaxonia), and the horny sponges without any spicules. It is generally allowed that the sponges are quite distinct from the Cœlenterates, and that they are somewhat degenerate and divergent descendants of the primitive Metazoa.

Relation to other Organisms.—'Sponges are living thickets in which many small animals play hide-and-seek.' Polypes, worms, and some other animals are often found associated with sponges, using them partly for shelter, partly as browsing-grounds. From the appetite of larger animals sponges are doubtless in great part saved by their spicules, and their frequently offensive taste and odour. Some sponges are borers, and others smother forms of life as passive as themselves. Several crabs are masked by growths of sponge, and within several sponges minute Alge live in constant partnership.

Several species of *Euspongia* are in use for economic purposes. Two species are brought from the Levant, and one (not much inferior) from the West Indies and coast of Florida. The trade in sponge is very considerable; it is carried on chiefly by Greeks, Sicilians, and Tunisians, and by the inhabitants of the Bahama Islands. The number of men employed in the Levantine sponge-fishery is between 4000 and 5000, forming the crews of about 600 boats. These boats find their chief employment on the coasts of Candia, Barbary, and Syria. The sponge is obtained by diving, the diver taking down with him a flat piece of stone of a triangular shape, with a hole drilled through one of its corners; to this a cord from the boat is attached, and the diver makes it serve to guide him to particular spots. When he reaches the growing sponges he tears them off the rocks, and places them under his arms; he then pulls at the rope, which gives the signal to his companions in the boat to haul him up. The value of sponges collected in Greece and Turkey is from £90,000 to £100,000 annually. The diving-bell and diving-dress are sometimes made use of. The Greeks of the Morea, instead of diving, obtain sponges by a pronged instrument; but the sponges thus collected are torn, and sell at a low price. The best sponges are obtained on detached heads of rock in eight or ten fathoms water.

The sponges of the Bahamas and other West Indian islands are of a larger size and coarser quality; the sponge-trade there employs 500 small vessels and 5000 to 6000 people; in 1890 the crop exceeded 900,000 lb., worth £61,400; and about 215,000 lb., worth £17,000, are sent annually to Great Britain. The sponges are torn from the rocks by a fork at the end of a long pole. To get rid of the animal matter they are buried for some days in the sand, and then soaked and washed.

The domestic uses of sponge are familiar to every one. It is also of great value to the surgeon, not only for removing blood in operations, but for checking hæmorrhage. Burnt sponge was once a

valued remedy for scrofulous diseases and goitre; but iodine and bromine, from which it derives all its value, are now administered in other forms.

See popular account of sponges by Sollas in Cassell's *Natural History*; E. Haeckel, *Die Kalkschwämme* (1872); *Challenger Reports on Sponges*, by Haeckel, Poléjaeff, Schulze, Sollas; Vosmaer, 'Die Poriferen,' in Bronn's *Thierreich*; Von Lendenfeld, 'A Monograph of Australian Sponges,' *Proc. Linn. Soc. N.S. Wales* (vol. ix. 1884).

Sponsor (Lat., 'promiser'). See GODFATHER.

Spontaneity. See NERVOUS SYSTEM, WILL.

Spontaneous Combustion is a phenomenon that occasionally manifests itself in mineral and organic substances. For some facts connected with the spontaneous ignition of mineral substances, see PYROPHORUS. Ordinary charcoal does not undergo combustion in air below a temperature of 1000°, but in some states, especially when impregnated with oil, it is liable spontaneously to acquire a temperature which may lead to unexpected combustion. There have been many instances of the spontaneous ignition of coals containing iron Pyrites (q.v.) when moistened with water. The pyrites which most readily give rise to spontaneous combustion are those in which the protosulphide is associated with the bisulphide of iron; and these occur among the Yorkshire coals and in some kinds of South Wales coal. Sulphur has no tendency to spontaneous combustion, but Dr Taylor refers to an instance that came to his own knowledge, in which there was reason to believe that the vapour of bisulphide of carbon in an india-rubber factory was ignited by solar heat traversing glass. Phosphorus, when in a dry state, has a great tendency to ignite spontaneously, and it has been observed to melt and take fire (when touched) in a room in which the temperature was under 70°. The ordinary lucifer-match composition is luminous in the dark in warm summer nights, which shows that oxidation, and therefore a process of heating, is going on. Hence large quantities of these matches kept in contact may produce a heat sufficient for their ignition. 'I have seen them ignite,' says Dr Taylor, 'as a result of exposure to the sun's rays for the purpose of drying.'

In organic substances, apart from the accidents that may result from the admixture of strong nitric or sulphuric acid with wool, straw, or certain essential oils, and which, if they occur, are immediate and obvious, there are many cases in which, 'without contact with any energetical chemical compounds, certain substances—such as hay, cotton and woody fibre generally, including tow, flax, hemp, jute, rags, leaves, spent tan, cocoa-nut fibre, straw in manure-heaps, &c.—when stacked in large quantities in a damp state, undergo a process of heating from simple oxidation (eremacausis) or fermentation, and after a time may pass into a state of spontaneous combustion' (Taylor). Cotton, woollen articles, hemp, tow, and flax impregnated with oil, when collected in large quantity, are specially liable to ignite spontaneously; and the accumulation of cotton-waste, used in wiping lamps and the oiled surfaces of machinery, has more than once given rise to accidents, and led to unfounded charges of incendiarism. Dr Taylor relates a case in which a fire took place in a shop 'by reason of a quantity of oil having been spilled on dry sawdust.' According to Chevallier, vegetables boiled in oil furnish a residue which is liable to spontaneous ignition. The great fire at London Bridge in 1861 was referred to the spontaneous combustion of jute in its ordinary state; but Dr Taylor remarks that this is wholly incredible, and from experiments which he made for the defendants in the case of *Hepburn v. Lordan* (1865), and on other

grounds, he holds that there is even no evidence of moist jute undergoing spontaneous combustion. Dry wood is supposed by Chevallier and some other chemists to have the property of igniting spontaneously. Deal which has been dried by contact or contiguity with flues or pipes conveying hot water or steam at 212° is supposed to be in a condition for bursting into flame when air gets access to it; and the destruction of the Houses of Parliament, and many other great fires, have been ascribed to this cause; but it appears that some amount of charring is necessary, and that on slight cooling a considerable quantity of oxygen is absorbed from the air, which induces a sufficient rise of temperature to set up spontaneous combustion. In a case recorded in the *Annales d'Hygiène* for 1841, MM. Chevallier, Ollivier, and Devergie drew the conclusion that a barn had caught fire from the spontaneous combustion of damp oats which were stored in it. No such cases are known to have occurred in Great Britain. See also FIRE, p. 634; and GUN-COTTON, p. 468.

Spontaneous combustion of the human body is supposed to have occurred in a number of recorded cases, of which one of the earliest was that of Mme. Millet at Rheims in 1725, and one of the most notable that of a man found burning in bed in 1847 (*Gazette Médicale*, 4th September 1847). Some of the alleged cases have been traced to wilful burning after murder; some are plainly incredible; the remainder, with the exception of the 1847 case, which remains unexplained, can all be traced to the destruction of the bodies of intoxicated brandy-drinkers, near an open fire in winter, with no one present and no evidence forthcoming as to the time occupied in the combustion, or as to the circumstances, other than intoxication, preceding the combustion. Liebig discusses the subject in his *Letters on Chemistry*, and concludes that, while a fat dead body charged with alcohol may perhaps burn, a living body, in which the blood is circulating, cannot take fire under any circumstances.

For further details the reader is referred to Graham's 'Report on the Cause of the Fire in the Amazon,' in the *Quarterly Journal of the Chemical Society*, vol. v. p. 34; to the article 'Combustion' in *Watts's Dictionary of Chemistry*, vol. i.; and to the elaborate chapter on this subject in Taylor's *Principles and Practice of Medical Jurisprudence*. For spontaneous combustion in the human body, see the article thereon in the *Medical Encyclopaedia*; the preface to *Dickens's Bleak House*; Liebig's *Letters on Chemistry*; Dupuytren's *Leçons Orales*; and Taylor's *Medical Jurisprudence*.

Spontaneous Generation is a term applied to the real or imaginary development of lowly organisms from non-living matter. The facts are that when organic substance is exposed to the air it putrefies, and at the same time living animals—maggots, infusoria, and others, according to the nature and conditions of the substance—appear in it. The question is, whence do the living animals come; from the organic stuff or from germs present in it or in the air? There is a further question—what is the cause of the putrefaction; is it an ordinary process of slow oxidation or is it caused by the living organisms? If the dead organic matter can give rise to life, then we know something of the mode of origin of life upon this planet, for we can make solutions of inorganic salts that will support life, and might therefore also give origin to it; if not, then we are entirely ignorant as to that origin. For many years no one has doubted but that, if one is careful to exclude all germs from the organic stuff, no life can proceed from non-living matter, even if it has once formed part of some living organism and is in the most complex state in which such matter is known to

us. The matter is therefore one of historic interest chiefly. As long ago as 1870 Huxley, in his presidential address to the British Association, was able to say that it appeared to him, within certain limitations, that the doctrine of Biogenesis, that life proceeds from life only, was victorious along the whole line. These limitations were, he said, that if he could have been a witness of the early stages of the earth's history, when the physical and chemical conditions were different from those that now hold, he would have expected to see the evolution of living protoplasm from non-living matter. As these limitations are still often thought inconsistent, and as by other people the denial of spontaneous generation seems inconsistent with a belief in evolution, it will be well to quote Herbert Spencer's reply to a critic who urged objections on this ground of inconsistency. In his *Principles of Biology* (vol. i., Appendix, 1868) he says, 'I do not believe in the "spontaneous generation" commonly alleged, and so little have I associated in thought this alleged "spontaneous generation," which I disbelieve, with the generation by evolution, which I do believe, that the repudiation of the one never occurred to me as liable to be mistaken for repudiation of the other. That creatures having quite specific structures are evolved in the course of a few hours, without antecedents calculated to determine their specific forms, is to me incredible. Not only the established truths of Biology, but the established truths of science in general, negative the supposition that organisms having structures definite enough to identify them as belonging to known genera and species can be produced in the absence of germs derived from antecedent organisms of the same genera and species. If there can suddenly be imposed upon simple protoplasm the organisation which constitutes it a Paramecium I see no reason why animals of greater complexity, or indeed of any complexity, may not be constituted in the same manner. In brief, I do not accept these alleged facts as exemplifying evolution, because they imply something immensely beyond that which evolution, as I understand it, can achieve. In the second place, my disbelief extends not only to the alleged cases of "spontaneous generation," but to every case akin to them. The very conception of spontaneity is wholly incongruous with the conception of evolution.' On the other hand he says, 'Granting that the formation of organic matter and the evolution of life in its lowest forms may go on under existing cosmical conditions, but believing it more likely that the formation of such matter and such forms took place at a time when the heat of the earth's surface was falling through ranges of temperature at which the higher organic compounds are unstable, I conceive that the moulding of such organic matter into the simplest types must have commenced with portions of protoplasm more minute, more indefinite, and more inconstant in their characters than the lowest Rhizopods—less distinguishable from a mere fragment of albumen than even the Protogenes of Professor Haeckel. The evolution of specific shapes must, like all other organic evolution, have resulted from the actions and reactions between such incipient types and the environment, and the continual survival of those which happened to have specialities best fitted to the specialities of their environments. To reach by this process the comparatively well-specialised forms of ordinary infusoria must, I conceive, have taken an enormous period of time.' Again, 'That organic matter was not produced all at once, but was reached through steps, we are well warranted in believing by the experience of chemists. Organic matters are produced in the laboratory by what we may literally call artificial evolution. Chemists

find themselves unable to form these complex combinations directly from their elements, but they succeed in forming them indirectly by successive modifications of simpler combinations.' We may say then that it is certain that living organisms, large enough to be visible with the help of a microscope and definite enough in form and structure to be classified with other known genera, do not grow at present from non-living matter. But it is not therefore certain that protoplasm of living matter may not be so formed in extremely small quantities, too small to be visible and of simple or no structure, but yet sufficiently complex in composition to serve as food for other and more highly developed animals. Whether this be so or not, Huxley and Spencer and nearly all biologists agree in believing that in past time molecules of simple matter by some series of reactions became aggregated until a matter, sufficiently complex and sufficiently unstable to be called living matter, was formed, whilst there is no evidence that any such generation is taking place at present.

We will now give a summary of the history of this inquiry, based upon Huxley's presidential address of 1870, and to a less extent upon Tyndall's article in the *Nineteenth Century*, January 1878. Expressions and phrases will be freely quoted from these authors.

History.—It must always have been a matter of common experience that many articles of food are apt to become mouldy and to putrefy if kept too long. Associated with mould and with putrefaction are various sorts of low forms of life. The ancient philosophers never doubted that these were generated in the matters in which they made their appearance. Indeed, all men believed this until past the middle of the 17th century. But in 1660 in Italy, in those days the home of learning, Francesco Redi published his *Esperienza intorno alla Generazione degl' Insetti*. He was no theorist, but a careful experimenter. Here, said he, is meat; if I expose it to the air in hot weather, in a few days it putrefies and swarms with maggots; but if I protect similar pieces of meat by covering them with fine gauze, then, though they still putrefy, not a maggot makes its appearance. From this experiment it becomes obvious that the maggots are not generated in the meat, but that the cause of their formation is something that is kept away by fine gauze. This something can be easily shown to be blowflies, for these, attracted by the meat, swarm near it and lay their eggs on the protecting gauze, eggs from which maggots are shortly hatched. Now this is the principle of the whole matter; keep away all living things which might come to the meat and the meat will not create any living things, will not even putrefy if one kills any living animals or germs of animals that may be in the meat. The protecting gauze must be fine enough, that is all. Redi of course was accused of controverting Scripture, because of the story of the bees which were said to be generated in the carcass of the lion. But his doctrine of Biogenesis flourished for a century. Indeed when, through the development of the microscope, the numerous provisions for the production of germs were made known, the hypothesis of Abiogenesis, that life could come from what was not living, appeared absurd. Leenwenhoek (q.v.), 1632-1723, is remarkable as being the first man to demonstrate existence of unicellular organisms. During the 18th century the microscope was greatly improved. The animalcules (infusoria) which in a few days will swarm in any infusion of organic matter became visible, and Needham, on theoretical grounds, doubted whether Redi's generalisation, 'no life without antecedent life,' held true for these lowly forms of life. He put his doubts to the

test. He argued that if the infusorial animalcules came from germs, then the germs must exist either in the substance infused or in the water used to make the infusion or in the air that touches both of them. The life of all germs is destroyed by heat. If, therefore, the infusion be boiled, any germs present will be killed; and then if the infusion be shut off from the air no more germs can get into it. Now, if after this treatment animalcules still appear in the infusion they will have been generated from the infused substance or from the water; but if they do not appear, then Redi's dogma will be true for infusoria. He therefore boiled and corked infusions of various substances, and in every case after a longer or shorter time animalcules appeared and flourished. Needham was associated in much of his work with Buffon. The French naturalist had a theory of life to which Needham's experiments lent support. Life, he thought, was the indestructible property of certain molecules, which he described as 'organic molecules.' All living organisms, he said, are built up of such molecules; death is nothing more than their dissociation. When they are thus set free they take the form of infusorial animalcules. It is necessary to distinguish this theory, which is so ingenious, from the theory of Abiogenesis, the antithesis to that of Biogenesis, which supposes that life may and does arise from non-living matter.

But the theory of Buffon, and especially the experiments of Needham, which lent it support, did not seem satisfactory to Spallanzani. He saw two sources of error—first, the germs present in the infusion might have escaped death through not having been boiled long enough; and secondly, the corks, perhaps, were not perfectly effective, and air containing germs might have got into the flask and infected the infusion. So he too prepared infusions; but he boiled them for three-quarters of an hour, and then fused the necks of the flasks. He found after this treatment that the infusions remained perfectly free from living organisms for as long as he chose to keep them. It might seem that this must be the end of the whole matter; but the event proved otherwise. This time it was the chemists who reopened the discussion. Oxygen was discovered, the theory of respiration was begun, and it was proved that a supply of free oxygen is one of the conditions of life and also of putrefaction. So it was possible that Spallanzani's infusions did not produce life either because the 'organic molecules' were altered in some way by being boiled, or because they were unable, owing to the absence of oxygen, to live. So the experiments had to be repeated in such a manner that the organic matter was not altered, and so that there was sufficient oxygen. Schulze and Schwann in 1836 took up the matter. They carefully boiled their infusions, and then supplied air; but they made it pass through red-hot tubes first, so that any germs present in it would be burned. In these conditions no animalcule appeared in the infusions; but if they were exposed to air which had not been heated then animalcules appeared in abundance. Therefore boiling does not injure the vitality of the 'organic molecules,' if there are such, and there is only one possible objection to the conclusions drawn from such experiments, if they be properly conducted, and that is that what the red-hot tubes destroy is not germs, but something else that may be non-living and yet essential to life. Now about this time Cagniard de la Tour discovered that fermentation, like putrefaction, is always accompanied by the presence of minute living creatures. Common yeast, for instance, is a mass of minute plants. When it was suggested that the living creatures not only accompanied but actually caused the processes of fer-

mentation and putrefaction, the chemists, led by Liebig and Berzelius, laughed the idea to scorn. But in 1843 Helmholtz ingeniously separated a putrescent from a putrescible fluid by a membrane, so that the products of putrefaction could mix with the putrescible matter; but that did not in consequence putrefy. Therefore it followed that the cause of putrefaction must be either a colloid—indiffusible stuff—or a solid. In 1854-59 Schroeder and Dusch cleared up this point by experiments which were simply refinements upon the original ones of Redi; instead of using a screen of gauze to keep off blowflies they used a screen of cotton-wool, a screen with meshes so fine that not even the tiny germs can pass through them. They boiled infusions, and while the steam was coming off freely they plugged the neck of the flask with cotton-wool. Now this plug did not keep away oxygen, nor did it in any way heat or alter the air that passed to the fluid, as the red-hot tubes of Schulze and Schwann had done, and yet no animalcules appeared in the boiled infusion screened by cotton-wool. It is therefore proved that the cause of putrefaction and fermentation and the origin of the living forms that accompany these processes must be small particles that exist in the air.

But in 1859 Pouchet published his *Hétérogénie*. He once more raised clouds of doubt. It seemed evident to him that spontaneous generation was one of the means that nature employed for the reproduction of living beings. If, he said, all putrefaction is the result of life present, as germs, in the air, then the air in which we live would have almost the density of iron! About this time Pasteur took the matter up, although advised by his friends, in view of the difficulty of the subject, not to do so; at least, said Dumas, do not spend too much time over it. But in 1862 he published a paper *On the Organised Particles existing in the Atmosphere*. He had collected the floating dust of the air and examined it with a microscope. He saw that much of it actually consisted of organised particles, and on his sowing these in suitable sterilised infusions there grew from them rich crops of animalculæ. He also showed that these germs of life were not universally diffused in the air. He opened his sealed flasks in the pure air of the Mer de Glace. Only one out of twenty such flasks thus opened became filled with life; while eight out of twenty opened in the air of the plains did so, and all of them did so if opened in the air of towns. These researches of Pasteur were necessary before Lister could have brought his system of antiseptic surgery to a successful issue; while he himself, as is well known, has done great work upon the relations of these forms of life to many industries and diseases. The germs of the air were then studied by Cohn, shown by him to be bacteria, and the basis of a sound knowledge of them was laid. In 1869 Tyndall hit upon a very precise method of determining the absence or presence of dust particles in the air, a method much more searching than that furnished by the most powerful microscope. He was experimenting in another direction, and had need of air free from dust. He noticed that such matter (dust) passed easily through liquids. A beam of light shows the presence of dust particles in the air by the reflection that occurs from the surfaces of such. Tyndall showed that whenever dust was present the putrefaction occurred sooner or later, when it was absent it did not. Tyndall's apparatus was a box with glass sides, into the bottom of which the mouths of flasks penetrated, the lower parts being outside the box, so that the contained infusions could be boiled. A beam of sunlight was allowed to pass through the box; it showed the presence of dust in the air

in a way with which every one is familiar. The inside of the box was then coated with glycerine, and the whole was kept as still as possible. After some time the dust particles sank to the floor of the box, and stuck to the glycerine, and a beam of sunlight passing through was quite invisible, there not being anything to reflect it. The infusions were then boiled for a long time, and then allowed to cool, after which they might be kept for months without putrefying or showing any signs of the presence of life. Here all the conditions of the infusions were natural, save that there was no dust in the air above them. In the dust of the air therefore are solid germs of life. The opponents of the doctrine of Biogenesis had long made objection to it, saying that 'if true then the air must be thick with germs; now this is absurd, therefore the doctrine is untrue.' An argument this that shows that a *reductio ad absurdum* is not always a proof.

The researches of Tyndall called forth the first utterances on the subject of Bastian, the latest, let us hope the last, obscurantist. Two years later, 1872, Bastian published his work, in two volumes, upon *The Beginnings of Life*. In the preface he states that the question of spontaneous generation turns wholly upon the probability of the *de novo* origin of bacteria, and further that evidence of the most convincing character shows that bacteria are killed by a temperature of 140° F., yet similar organisms will constantly appear in closed flasks containing organic fluids that have been exposed for some time to a temperature of 212° F. It is surprising that any man could at that late day have been found to urge such stale arguments after the repeated demonstration of the two sources of error in such experiments—(1) that fresh bacteria might get in after the original set were killed; (2) that though adult bacteria are killed by a temperature of 140° F., their germs are not always killed by a much higher temperature. Bastian's work has been quietly forgotten, and since then the progress of discovery as to the nature and mode of origin of bacteria and all other forms of life has progressed steadily.

See BACTERIA, BATHYBIUS, LIFE, PROTOPLASM, PUTREFACTION; and Haeckel's *Natural History of Creation*.

Spontini, GASPARGO LUIGI PACIFICO, Italian musical composer, was born at Majolati in the March of Ancona on 14th November 1774, and received his musical education at Naples. In 1803 he proceeded to Paris; but it was not until he produced (1804) the one-act opera of *Milton* that he attracted any notice. Encouraged by this, he composed the grand opera *La Vestale*; this on its production in December 1807 was greeted with enthusiastic acclaim, and was adjudged the prize of 10,000 francs instituted by Napoleon. An equally warm reception was accorded to *Ferdinand Cortez* in 1809. In the following year Spontini was appointed director of Italian opera at the Opéra. A third grand opera, *Olympia*, produced in 1819, did not prove so successful. In 1820 Frederick-William III. summoned Spontini to Berlin. There he remained more than twenty years, though during the greater part of the time it was only court influence that supported him against the enmity of the Berlin public and of the Prussian press. Spontini was jealous of Weber, and was by nature quarrelsome and vain; but as a musician he entertained the loftiest aims, possessed true artistic taste, was grandiose in his conceptions, and breathed the spirit of genuine melody into his compositions. In Berlin he wrote three other grand operas—*Nourmahal* (1822), *Alicidor* (1825), and *Agnes von Hohenstaufen* (1829), his greatest work. Spontini was dismissed by Frederick-William IV. in 1842, and he gradually withdrew into private life. He died at Majolati, his birthplace, on 14th January

1851. See monograph by Robert (Berlin, 1883); and Spitta in *Deutsche Rundschau* (March 1891).

Spoontoon, a kind of spear. See PIKE.

Spoonbill, a family of birds, Plataleidae, allied to the Ibiidae, and more distantly to the storks, and distinguished by the remarkable form of the bill, which is long, flat, broad throughout its whole length, and much dilated in a spoon-like form at the tip. The species are not numerous, but are widely distributed; the birds are, however, becoming scarce owing to the drainage of their native haunts. The only European species is the White



Spoonbill (*Platalea leucorodia*).

Spoonbill (*P. leucorodia*), at one time a resident in Britain, but now only a visitor. This bird was known as the Shovelard or Shovelar, while the bird now known as the Shoveler was then called the Spoonbill or Spoonbilled Duck. In northern Europe it is uncommon; it breeds in Holland, in the south of Spain, and the Black Sea district. Eastward in summer it ranges to India, Ceylon, and northern China; it is resident in North Africa. In South Africa it is represented by another species, *P. teneirostris* or *cristata*. It is gregarious, but its nesting habits vary in different countries; in Holland the nests are made of reeds, and placed on the mud among rushes; in Slavonia on the submerged branches of willows; and in India on trees. It is about 32 inches long. Its colour is white, slightly tinged with pink; the bill and legs are black. A curious convolution of the windpipe, in the form of a figure 8, is found on dissection in the adult spoonbill, but does not exist in the young. The flesh of the spoonbill is said to be tender and of good flavour. The spoonbill is easily tamed, is quiet and inoffensive, and feeds readily on any offal. The Roseate Spoonbill (*P. ajaja*) is an American species, and the only one; very abundant within the tropics, and found in the most southern parts of the United States. It is nearly equal in size to the White Spoonbill, which it resembles in its habits. It is a beautiful bird, with plumage of a fine rose-colour, of which the tint is deepest on the wings; the tail-coverts are crimson. Two species (*P. regia* or *melanorhynchus* and *P. flavipes*) are found in Australia.

Sporades. See ARCHIPELAGO.

Sporadic (Gr., 'scattered') is a term applied to any disease that is commonly epidemic or contagious, when it attacks only a few persons in a district and does not spread in its ordinary manner. The conditions which determine the occurrence of epidemic or contagious diseases in a sporadic form are unknown. Amongst the diseases which occur in this form may be especially mentioned cholera, dysentery, measles, scarlatina, and smallpox.

Spore. Plants reproduce themselves in two different ways, 'vegetatively' or 'truly.' The vegetative mode of reproduction is merely a continuous growth of parts already formed. It is quite common in nature. Sometimes entire buds separate from the parent plant and produce independent plants. This happens, for example, with some of the buds in the axils of the leaves of *Lilium bulbiferum*. Sometimes entire pieces of a creeping stem separate from the main stem and begin an independent life. This happens in the case of the strawberry plant. Artificially also a vegetative mode of reproduction is easily brought about. Every one knows how gardeners propagate many species of plants by means of cuttings. As a rule the more lowly the plant the more easy is it to make a successful cutting, and the smaller may the cutting be. Thus, a single leaf or even a small part of leaf of a moss plant will often, if cut off and placed in a suitable soil, grow into a complete moss plant. In the true mode of reproduction the growth is not continuous. Certain cells of a plant are set apart for this function. These cells are called *spores*. In plants higher than the Thallophytes such cells do not grow directly into a plant like that from which they have come, but they give rise to a plant which in its turn, when it reaches maturity, produces cells of two sorts, male and female, which unite with one another, and then from the new cell of dual origin there grows a plant like that from which the spore originally came. Thus, on the under surface of the fronds of ferns there may often be seen many small spore-cases. The spores fall to the ground, and produce a little green plant called the prothallium of the fern. The prothallium produces the sex-elements. These unite, and from their union grows a new 'fern.' This indirect mode of reproduction is spoken of as the Alternation of Generations (q.v.).

In the Thallophytes (Algæ, Fungi, &c.) the cells which function as spores receive a variety of names, such as teliospores, aedospores, sporidia, stylospores, tetraspores, zoospores (which are motile), conidia, &c. These names are meant to emphasise some point in their mode of origin and development. In the Bryophytes (liverworts and mosses) and in the Pteridophytes (ferns, horsetails, &c.) they are always called simply spores. But some of the Pteridophytes (Vascular Cryptogams), for instance *Salvinia* (q.v.), produce two kinds of spores, male and female, and hence they are called *heterosporous* ferns, horsetails, or lycopods as the case may be. In the Spermatophytes also (Seed-plants or Phanerogams) the spores are of two kinds. The pollen grains (see FLOWER) represent the male spores, microspores; and the female spores are contained within the Ovule (q.v.).

The sexual generation, the prothallium, which is formed from the spore, loses its character as an independent plant as we ascend the scale of plants from the Vascular Cryptogams to the Phanerogams. In homosporous ferns it lives for a long time; in the heterosporous ferns they, the male and female prothallia, never become entirely separate from the spores, although they burst through the spore-cases; in the Coniferæ they remain entirely within the spore-case. In the Phanerogams they are still further reduced; the Ovule (q.v.) is the macrosporangium. See for details the articles ALGÆ, FERNS, FUNGI, MOSSES, &c.

Sporozoa. See GREGARINIDA.

Sports. See ATHLETIC SPORTS, CRICKET, CURLING, CYCLING, FOOTBALL, FOX-HUNTING, GOLF, ROWING, TENNIS, &c., and the 'Badminton Series' (28 vols. 1885-96).

Sports, BOOK OF, the name popularly given to James I.'s Declaration in 1618, that on Sundays, after

divine service, 'no lawful recreation should be barred to his good people, which should not tend to the breach of the laws of his kingdom and the canons of his church.' The sports specified were dancing, archery, leaping, vaulting, May-games, Whitsun-ales, morris-dances, and the setting up of May-poles. The occasion of this proclamation was the conduct of some Puritan authorities in Lancashire, who, by illegally suppressing instead of regulating the customary recreations of the common people, had excited much discontent, and increased the influence of the Roman Catholics by giving a repulsive aspect to the Reformed religion. Although the Declaration was ordered to be read in the parish churches of the diocese of Chester, this order was not enforced, and the king's design was allowed to drop. Among the excepted unlawful sports were bear-baiting, bull-baiting, bowling, and interludes. Nonconformists and others not attending divine service at church were prohibited from joining in the sports, nor was any one allowed to go out of his own parish for that purpose, or to carry offensive weapons. By republishing this Declaration in 1633, and enforcing with great severity the reading of it by the clergy in their churches, Charles I. and Laud excited among the Puritans a degree of indignation which contributed not a little to the downfall of the monarchy and the church. In 1644 the Long Parliament ordered all copies of it to be called in and publicly burned. See L. A. Govett, *The King's Book of Sports* (1890).

Spottiswoode, JOHN, Archbishop of St Andrews, son of John Spottiswoode, Superintendent of Lothian, was born in 1565. He was educated at the university of Glasgow, and at eighteen succeeded his father as parson of Calder. In 1601 he attended the Duke of Lennox as chaplain on his embassy to France, and in 1603 King James to London. Soon after he succeeded James Beaton as Archbishop of Glasgow, but was only consecrated in London in 1610. As Moderator of the General Assembly at Glasgow in 1610 he laboured to confirm episcopal government, and he forced the Perth Assembly (1618) to sanction the five points of discipline known as the Perth (q.v.) Articles. He was translated to the see of St Andrews in 1615. He officiated at the coronation of Charles I. at Holyrood in 1633, and in 1635 became Chancellor of Scotland. He reluctantly entered into the king's unwise measures for the introduction of a liturgy into Scotland, and naturally became hateful to the Covenanters. The king compelled him to resign the chancellorship in 1638, and that same year the Glasgow General Assembly deposed and excommunicated him. Spottiswoode died at London, 26th November 1639, and was buried in Westminster. His chief work is the well-known *History of the Church of Scotland* (1655; 3 vols., ed., with a Life, by Bishop Russell for the Spottiswoode Society, 1849-51).

Spottiswoode, WILLIAM, mathematician, was born in London, January 11, 1825, and was educated at Harrow and Balliol College, Oxford. He took a first-class in mathematics in 1845, and later both the junior and senior university mathematical scholarships. For some time he lectured at Balliol, and in 1846 he succeeded his father as the head of the great printing-house of Eyre & Spottiswoode. Although throughout life an energetic man of business, he found time for much original work in abstract mathematics and experimental physics, as well as for travels in Eastern Russia (1856), Croatia and Hungary (1860), and for a large hospitality at his houses both in London and at Sevenoaks. His contributions to the *Proceedings of the Royal Society*, the *Philosophical Magazine*,

the London Mathematical Society *Proceedings*, and his admirable lectures on the *Polarisation of Light*, reprinted in the 'Nature' series (1874), are known to all students. Spottiswoode was treasurer of the British Association (1861-74), of the Royal Institution (1865-73), and of the Royal Society (1871-78); president of Section A (1865), and of the British Association itself (1878), of the London Mathematical Society (1870-72), and of the Royal Society from 1879 till his death, which took place at London, June 27, 1883. Further honours were the degrees of LL.D. from Cambridge, Dublin, and Edinburgh, and D.C.L. from Oxford. For a brief memoir and a list of his writings, see *Nature* for April 26, 1883.

Spottsylvania Courthouse, a small village of Virginia, 55 miles N. by W. of Richmond, the scene of one of the most desperate and sanguinary battles of the civil war. On 10th May 1864, during the Wilderness campaign, Grant attacked Lee in his earthworks, and was repulsed with dreadful slaughter; yet on the next day he wrote to the secretary of war, 'I propose to fight it out on this line, if it takes all summer,' and on the 12th repeated the assault, when Hancock's corps carried and held the 'bloody angle' (see HANCOCK). The next morning Lee, unable to bear his share of the heavy losses, withdrew within an inner line of entrenchments, and on the 20th Grant, having failed to dislodge him, moved round his flank towards Richmond.

Sprain, or **STRAIN**, is a term employed in Surgery to designate a violent stretching of tendinous or ligamentous parts with or without rupture of some of their fibres. Sprains are very frequent in all the joints of the upper limbs, especially in the wrist and the articulations of the thumb. In the lower extremity the ankle is the joint by far the most frequently affected; and this is accounted for anatomically by the small size of the articular surfaces, the great weight the astragalus (the bone presenting the lower articular surface) has to support, and the unyielding nature of the lateral ligaments. In slight sprains of this joint the ligaments are only stretched or slightly lacerated, but in more severe cases they may be completely torn through. Sprains of the ankle are sometimes mistaken for fractures, and *vice versa*; and the two injuries may co-exist. The pain and swelling sometimes make an accurate diagnosis difficult, especially if the patient is not seen for some time after the accident; and if any doubt exists the case should be treated as for the more severe injury, since it is better that the treatment should be prolonged than that the patient should be maimed; and fortunately that which is the proper treatment of a fracture will also suit a sprain well, at least till the swelling subsides, and the doubt can be resolved. Sprains of the knee are not uncommon, and are characterised by great swelling from effusion of fluid within the joint. Sprains of the back are not unfrequent accidents, and are the most serious of any, but in most cases it may be anticipated that after confinement in bed or on a sofa for two or three weeks, and with proper treatment, the patient will be able to walk, although he may feel stiffness and pain for several weeks longer.

The best treatment of a sprain depends chiefly upon the time that has elapsed since the injury. If the patient is seen before swelling has occurred the application of cold by means of ice-bags or running water, especially if a thin india-rubber bandage is previously applied, does much to control the swelling and the pain. At a later stage, if the pain be severe, warm applications (hot water, hot fomentations, or poultices) are generally very

soothing; or lead and opium lotion may be employed. Where the swelling is very great leeches are sometimes most useful. When the pain is not very intense the joint may be enveloped in a large quantity of cotton-wool, and gently but very firmly bandaged. It is important not to keep the injured joint too long at rest. As soon as the pain has subsided massage and gentle movements should be commenced; the patient should not be allowed to use the limb himself till these can be quite freely borne. In sprains of the back rest is the main requisite; but sometimes active antiphlogistic treatment is required; and a supporting jacket of gutta-percha or plaster of Paris may have to be worn for some time.

Amongst horses sprains or strains are very common, owing to the severe exertions required of them, often whilst they are young, and unprepared for such work. Various muscles, ligaments, and tendons are liable to strain, but none more frequently than the large tendons passing down the back of the legs. In slight cases cold water continuously applied for several hours gives relief; but in all serious cases diligent fomentation with water about the temperature of 100° is preferable; or the injured part may be swathed in a thick woollen rug, kept constantly moist and warm by frequent wetting with the hot water. Perfect rest is essential, and in order to ensure the relaxation of the large tendons of the horse's limbs he may in bad cases be kept slung for several days. Blisters, hot oils, firing, and all such irritants are on no account to be used until the inflammation abates and the part becomes cool and free from tenderness. Such remedies are then useful for causing the reabsorption of swelling, and perhaps also for invigorating the weakened part.

Sprat (*Clupea sprattus*), a fish of the family Clupeidæ, very abundant on many parts of the British coast, and elsewhere in the northern parts of the Atlantic. It is smaller than the herring, being only about five inches in length when full grown, but much resembles it. It is, however, easily distinguished by the serrated belly, and by the position of the fins, the ventral fins beginning immediately beneath the first ray of the dorsal fin, and not beneath the middle of it, as in the herring

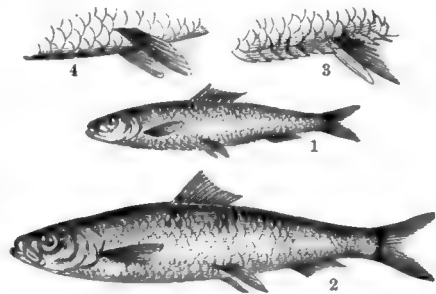

Sprat and Herring:

1, sprat; 2, herring; 3, belly of sprat; 4, belly of herring.

and pilchard. Another easily observed distinction is the want of axillary scales to the ventral fins, which both the herring and pilchard have. The dentition is also different, and on this account Valenciennes constituted for the sprat and a number of other species the new genus *Harengula*, characterised by having teeth on the jaws, tongue, palatines, and pterygoids, but no teeth on the vomer. The herring has teeth on the vomer. The sprat has only forty-seven to forty-nine vertebrae, whilst the herring has fifty-six to fifty-eight. The mode of reproduction of the sprat has only recently

been discovered. It was for a long time unknown, because the adult sprats taken in estuaries are scarcely ever in breeding condition. But it has now been proved by Victor Hensen of the German Fishery Commission, and by J. T. Cunningham of the Marine Biological Association, that the eggs of the sprat are pelagic, like those of the pilchard—i.e. that they float in the sea and are hatched in that condition. The eggs have been taken both in Germany and at Plymouth in England from the ripe female sprat, and proved to be identical in all respects with floating eggs previously obtained from the surface-waters of the sea. Perfectly ripe sprats are only found in the sea, to which they repair for the purpose of spawning, not, however, wandering very far from land. On the south coast of England at Plymouth the sprat spawns from December to May, but in the Firth of Forth and east coast of Scotland in May or June. The young sprats are found, together with young herrings, in estuaries, such as the Thames, Forth, Exe, Tamar, &c., and are taken in large numbers to be consumed as whitebait. Sprats abound especially on the coasts of Norfolk, Suffolk, Essex, and Kent in November and several following months. Drift-nets are used for the capture of sprats off the coast of Kent, but the usual instrument for the purpose is the stow-net worked from a moored boat in estuaries and tide-ways. The stow-net is a large bag-net suspended between two horizontal beams beneath the boat, and about a fathom from the bottom of the water; ropes from the ends of the upper beam enabling the fisherman in the boat to keep the mouth of the bag always open and against the tide. Vast quantities of sprats are taken in this way, so that they are used as manure by farmers, although London is also very largely supplied with them, and being sold at a very cheap rate they are a favourite article of food of the poorer classes. The Firth of Forth also produces sprats—in Scotland called *garvies*—so abundantly that they are sold both in Edinburgh and Glasgow by measure, and cheaper than any other kind of fish. But there are many parts of the British coast where the sprat is rare, some of these being parts where the herring is plentiful. Notwithstanding its cheapness the sprat is a very fine fish, of flavour quite equal to the herring, although decidedly different. Dried sprats are a very common article of provision, and sprats are also sometimes salted. The *kilbies* brought from Riga and other ports on the Baltic are sprats cured with spices, as also are the 'Norwegian Anchovies' sent in small wooden barrels from Norway to England. The value of the sprat does not seem to be as yet fully appreciated in Britain. Very closely allied to the sprat is another fish (*Clupea latula*), the *Blanquette* of the French, which is caught in great abundance on some parts of the west coast of France. Other allied species are found in other seas. One of them (*C. humeralis*), which abounds in the West Indies, and southwards as far as Rio Janeiro, is much esteemed, but becomes poisonous at certain seasons, from some unknown cause. The prepared sardine (q.v.) is frequently a sprat.

Spree, a river of Prussia, rises in the east of Saxony, on the borders of Bohemia, and after a winding course of 227 miles, but bearing generally north and north-west, falls into the Havel (q.v.) at Spandau. Area of drainage basin, 3655 sq. m. The principal towns on its banks are Bautzen, Kottbus, and Berlin. By the Frederick-William or Müllrose Canal it is connected with the Oder. A couple of short canals assist navigation near Berlin, and in 1890 it was proposed to spend close upon £1,000,000 in deepening the river and its approaches in that city so as to afford easy communication from the Oder to the Elbe. In the

Spree-wald, a district near Kottbus much cut up by the interlacing arms of the river, there still exists a colony of Wends.

Sprengel, KURT, physician and botanist, was born at Boldekow in Pomerania on 3d August 1766, and died at Halle on 15th March 1833. All his life was spent in quiet labour at Halle, from 1789 as professor of Medicine and from 1797 as professor of Botany. He won a reputation as a writer on the history of medicine and as a student of the anatomical structure and functions of plants. His principal books are *Pragmatische Geschichte der Arzneikunde* (5 vols. 1792-1803), *Geschichte der Botanik* (2 vols. 1817-18), and *Neue Entdeckungen im ganzen Umfang der Pflanzenkunde* (3 vols. 1819-22). Rosenbaum edited in 1844 Sprengel's *Opuscula Academica*, with a biography.

Sprenger, ALOYS, an orientalist, was born 3d September 1813 at Nasserreit in Tyrol, studied medicine, the natural sciences, and the oriental languages at Vienna, next at London assisted Count Münster, and in 1843 sailed to Calcutta. For many years he was incessantly active as teacher, interpreter, librarian, and translator, until in 1857 he was called to be professor of Oriental Languages at Bern. In 1881 he settled at Heidelberg. His rich collection of Arabic, Persian, Hindustani, and other MSS. and books are now in the Royal Library at Berlin. The most important of Sprenger's numerous works are *Leben und Lehre des Mohammed* (3 vols. 1861-65), *Die Alte Geographie Arabiens* (1875), and *Babylonien* (1886); besides editions of Arabic and Persian works, as Sadi's *Gulistan*, &c. Died Dec. 19, 1893.

Sprenger, JACOB, of the Order of Preachers, and professor of Theology in Cologne, and HENRICUS INSTITOR (Latinised form of Krämer), two names of enduring infamy as the authors of the famous *Malleus Maleficarum* or *Heckenhammer* (1489), which first formulated in detail the doctrine of witchcraft, and formed a text-book of procedure for witch-trials. They were appointed inquisitors under the bull 'Summis desiderantes affectibus' of Innocent VIII. in 1484, and their work is arranged in three parts—Things that pertain to Witchcraft; The Effects of Witchcraft; and The Remedies for Witchcraft. It discusses the question of the nature of demons; the causes why they seduce men, and particularly women; transformations into beasts, as wolves and cats; and the various charms and exorcisms to be employed against witches. The writers detail the extraordinary dangers to which they were exposed in their task, and how all the artillery of hell had been employed against themselves in vain, and they tell with complete composure of mind how in one place forty, in another fifty, persons were burned by their means. They admit bodily transmission of sorcerers through the air, and relate numerous cases of the devilish malice of witches upon horses and cattle as well as mankind; and in the latter part, consisting of thirty-five questions, give minute directions for the manner in which prisoners are to be treated, the means to be used to force them to a confession, and the degree of evidence required for a conviction of those who would not confess. The book contains no distinct allusion to the proceedings at the Witches' Sabbath any more than did the *Formicarium* (c. 1440) of John Nider, whose fifth book is devoted to the subject of sorcery.

Spring. See SEASONS.

Spring, a stream of water issuing from the earth. The source of springs is the rain and snow that falls from the clouds. Very little of the water precipitated in any district finds its way immediately by rivers to the sea; the great proportion either sinks into the earth or is evaporated

from the surface of the earth, and, reabsorbed by the atmosphere, is employed by plants and animals. All loose soils and gravels greedily absorb water, which descends until it meets with a stratum through which it cannot penetrate. A pit dug into the water-charged soil would speedily fill itself by draining the water from the soil. All rocks contain water; some retain it by capillary attraction, like a sponge, others hold it merely mechanically, and easily part with it. Chalk will absorb and retain one-third of its bulk of water; and sand, on the other hand, while it will absorb as much, will part with nearly the whole amount to a well dug in it. Argillaceous deposits and compact rocks are barriers to the passage of water, and cause the superincumbent pervious strata to become water-logged when there is no outlet. Sometimes the edges of the strata are exposed on the sides of a valley, and permit the free escape of the contained water, which pours from them over the neighbouring land. But rents and fissures, as well as inequalities on the surface of the impervious beds, give the water a circumscribed course, and cause it to issue in springs.

The water, as it percolates through the earth, always becomes more or less charged with foreign matter, owing to its solvent property. Carbonate, sulphate, and muriate of lime, muriate of soda, and iron are the most common impurities in spring-waters; magnesia and silica also frequently occur. These substances, from the evaporation of part of the water, or the escape of the carbonic acid gas, by which so large a quantity is often held in solution, are frequently deposited on the margins of the springs, or in the courses of the streams flowing from them. Such deposits are found in all so-called petrifying springs; and the hot wells of Iceland, the Yellowstone Park, and the Azores are surrounded with basins formed of siliceous sinter which has been derived from the water. When the foreign ingredients have medicinal qualities the springs are known as Mineral Waters (q. v.).

Springs are either associated with the superficial strata or rise from a considerable depth. Surface-springs occur where the absorbent surface-deposits rest on an impervious bed, which prevents the



Fig. 1.

further downward progress of the water, or where the beds through which the water flows are near the surface, as shown in fig. 1, where C and E are impervious clay-beds, and D is a bed of sand or gravel, which in the upper portion is exposed on the surface, or is only overlaid by loose soil, and after being covered for some distance by the clay-bed, C, makes its appearance again at B, where the valley cuts it through: here the water collected over the area, A, is discharged. Surface-springs, depending as they do so directly on the rain for supplies, are very variable in the amount of water they deliver. They frequently fail entirely in the summer, and always after great droughts. Their temperature varies with that of the district where they exist, being warm in summer and cold in winter, as they do not penetrate below that plane in the earth's crust which is affected by the seasonal changes in temperature.

When the bed which forms the reservoir for the spring is at such a distance from the surface as to

be beyond the zone of season changes, and yet within that which is influenced by the climate, the water has a temperature equal to the mean temperature of the locality where it springs. Such springs have generally a large area for the collection of the superficial water, and are consequently regular in the quantity of water they give out. They are brought to the surface by means of master-joints and dislocations. The celebrated Well of St Winifred at Holywell, in Flintshire, rises through a fault in the coal-measures. It formerly discharged about 4400 gallons per minute, and the water, in its short course of little more than a mile to the sea, was used to propel eleven mills; but the discharge has been much diminished, by drainage works.

Most deep wells have a lower origin than the zone of climate temperature, which in Britain is between 200 and 300 feet. It is well known that a regular increase in the temperature is observed after this zone is passed, equal to 1° of F. for every 54 feet. As wells have a temperature corresponding to that of the strata from which they spring, it follows that the deeper the spring the higher will be its temperature. Local conditions may affect the thermal state of springs, as in the case of the geysers in the active volcanic district in Iceland, and the warm springs near Naples; but where no such local influences exist the depth of the bed from which the water comes may be to some extent estimated by its temperature. Thermal springs occur in Britain at Matlock (66° F.) and Buxton (82°) in Derbyshire, at Bath (117°) in Somerset, and at Clifton (76°) in Gloucestershire. Artificial communications have been opened with deep-lying strata, by which the water they contain has been brought to the surface, and in these the temperature is found to increase in proportion to the depth of the bore (see ARTESIAN WELLS). The most remarkable thermal springs are the geysers of Iceland and the Yellowstone Park (see GEYSER, YELLOWSTONE PARK).

Intermittent springs are sometimes produced by the ebb and flow of the tide, as at Richmond, where the rise at high-water is seen in the wells which flow from the arenaceous strata on the banks of the Thames; and sometimes they depend on the supply of rain-water. But there is a kind of spring the intermittences of which are believed to be owing to the structure of the internal cavities from which the supply is obtained. This will be more easily understood by a reference to the accompanying diagram (fig. 2). The large reservoir, A, is fed by the rain percolating through the rock. It communicates with the surface by a siphon-shaped tube, BCD. As long as the water in the reservoir

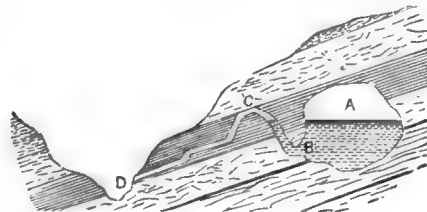

Fig. 2.

is at a lower level than the arch of the siphon at C no water can escape; but as soon as it reaches its level the whole of the water in the cavity will be drawn off, the spring will then cease, and will only make its appearance when sufficient water has accumulated to permit the siphon again to act.

Spring-balance. See BALANCE.

Springbok (*Gazella euchores*), an antelope, which like many others is getting scarcer; it is still, however, abundant a little south of the Zambesi. It is an extremely beautiful creature, of graceful form, and fine colours. It is larger than the roebuck, and its neck and limbs much longer and more delicate. The general colour is fulvous brown on the upper parts, pure white beneath, the colours separated on the flanks by a broad band of deep vinous red. The whole head is white, except a broad brown band on each side from the eye to the mouth, and a brown spot in the centre of the face. Two curious folds of skin ascend from the root of the tail, and terminate near the middle of the back; they are usually closed, but open out when the animal is bounding, and disclose a large triangular white space which is otherwise concealed. The springbok derives its name from the prodigious leaps which it takes either when alarmed or in play, often to the height of 7 feet, and sometimes



Springbok (*Gazella euchores*).

of 12 or 13 feet. Its ordinary residence is in the *karroos* or arid sandy plains; but when all pasture there is burned up immense herds congregate together, and migrate to more fertile regions, often devastating the fields of the colonist. Pringle speaks (1834) of seeing the country near the Little Fish River specked with them as far as the eye could reach, and estimates the number in sight at once as not less than 25,000 or 30,000. Cumming describes (1850) a still more extraordinary scene, a vast herd pouring through an opening among hills, in one living mass, half a mile in breadth, and so continuing for hours together. The strongest animals are generally foremost, but when satiated with food they fall behind, and others, hungry and active, take their place. When taken young the springbok is easily tamed, and becomes very familiar, troublesome, and tricky.

Springer. See SPANIEL.

Springfield, (1) the capital of Illinois, stands in a fertile prairie country rich in bituminous coal, 185 miles by rail SW. of Chicago, at the meeting-point of seven railway lines. It is regularly laid out with broad streets and gardens, possesses a handsome federal building, a state arsenal, two colleges, and one of the largest state capitols in the Union (of marble, 385 feet long by 296 wide; cost \$5,000,000). Its coal-mines have made it an active industrial centre: here are large iron-rolling mills and foundries, a watch-factory, and flour, woollen, paper, and planing mills. Springfield, which became the capital in 1837, was the home of Abraham Lincoln, who is buried in the beautiful Oak Ridge cemetery, in the crypt of the great national monument—a granite obelisk (1874), which cost \$264,000. Pop. (1890) 24,963; (1900) 34,159.—(2) A thriving city of Massachusetts, capital of Hampden county, on the left bank of

the Connecticut River, by rail 99 miles W. by S. of Boston and 25 N. of Hartford. The river is crossed by five bridges to West Springfield (pop. 5075), and four railways meet here. The city is stretching out over an elevated plain to the east; the older streets are broad, shaded avenues, and there is a large and beautiful park. The public buildings include a cathedral and numerous other churches, a brown-stone post-office, city hall, granite court-house, and a railway station which cost \$700,000. Springfield is noted for the great variety of its manufactures. Among its larger factories is the United States Armoury (since 1794), employing about 400 men, chiefly in the manufacture of rifles and carbines; the others embrace foundries, car-works, and manufactories of cottons and woollens, paper, machinery, furniture, trunks, buttons, needles, spectacles, locks, pistols, skates, picture-frames, organs, and jewellery. The town was settled in 1635. Pop. (1890) 44,179; (1900) 62,059.—(3) Capital of Greene county, Missouri, 232 miles by rail WSW. of St Louis, with machine-shops, car-works, and large cotton and woollen factories. Here is Drury College (Congregational; 1873). Near Springfield was fought the battle of Wilson's Creek, 16th August 1861. Pop. (1880) 6522; (1890) 21,850.—(4) Capital of Clark county, Ohio, on Lagonda Creek and Mad River, 80 miles by rail NE. of Cincinnati. Six railways meet here. The city contains the Wittenberg College (Lutheran; 1845), and handsome county and municipal buildings. It has numerous manufactures, especially farm machinery, bicycles, sewing-machines, iron fences, paper, &c. Pop. (1880) 20,730; (1890) 31,895; (1900) 38,253.

Spring-gun, a gun having wires connected with its trigger, and so fixed and planted that when wild animals, trespassers, &c. stumble against the wire the gun shall be discharged at them so as to wound them. Since 1827 it is illegal in Britain to set Man-traps (q.v.) or spring-guns save indoors as a defence against burglars.

Spring-tails (*Collembola*), an order of primitive wingless insects which, along with the somewhat similar *Thysanura*, are included in the small group *Apterygota*. The popular name refers to a peculiar springing fork which is usually present on the abdomen. It seems to result from a pair of abdominal appendages which are united at the base and bent forward when the animal is at rest. 'By a process analogous to that by which the common toy frogs are made to jump,' the spring-tails leap to a considerable height. The *Collembola* are all small, usually under a quarter of an inch in length; there are six or fewer abdominal segments; there are no compound eyes, nor hints of wings, nor metamorphosis. They usually live in damp and sheltered places—e.g. under bark or stones. Among the representative forms may be noted *Podura aquatica*, common on stagnant water in England; *Orchesella cincta*, among dead leaves and moss; *Desoria glacialis*, on the glaciers; *Smythurus*; *Isotoma*; *Macrotoma*. See Sir John Lubbock, *Monograph of the Collembola and Thysanura* (Ray Society, 1873).

Spruce. See FIR.

Spruce-beer. The essence of spruce is obtained by boiling the green tops of the Black Spruce (*Abies nigra*) in water, and then concentrating the decoction by another boiling without the spruce tops. The young shoots of this fir, like most others of its family, are coated with a resinous exudation, which is dissolved in the water. Spruce-beer is made by adding the essence of spruce to water in which sugar or treacle has been dissolved, in the proportion of about four ounces of essence of spruce to ten pounds of sugar, or three quarts of

treacle, and ten or eleven gallons of water, with about half a pint of yeast. Various spices are used for flavouring. A similar beverage is made largely in the north of Europe, from the buds of the Norway Spruce (*Abies excelsa*), and is known as Black Beer, that of Danzig being the most famous.

Spruner von Mertz, KARL, author of some useful historical atlases, was born at Stuttgart on 15th November 1803, joined the army of Bavaria, and taught geography in the Bavarian cadet college from 1855. His name is associated with a well-executed, and painstaking and accurate, *Historisch-geographische Handatlas*, in three parts (1853-64), embracing in all 139 maps; besides this he published historical atlases of Bavaria (1838), Austria (1860), and Germany (1866), and a few historical works dealing with Bavaria. He received the rank of General-lieutenant in 1869, and retired in 1886. He died at Munich, 24th August 1892.

Spur, an apparatus fastened to the heel of a horseman, for goading the horse. It is much less

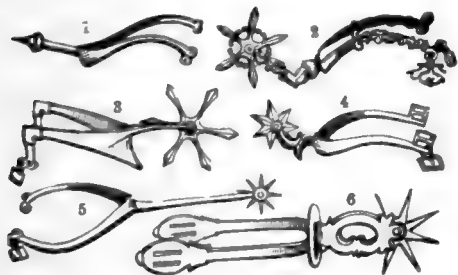

Various Kinds of Spurs

(From Antiquarian Museum, Edinburgh):

- 1, bronze prick spur found at Linlithgow Palace; 2, iron spur found near Bannockburn; 3, bronze spur found at Colchester; 4, brass spur found at Culloiden; 5, spur found at Halidon Hill; 6, spur found in making a drain in High Street, Edinburgh.

used than formerly, and the modern apparatus, having only minute serrations on its rim, does not possess the cruel effect of the formidable spiked spurs of old times here illustrated. All cavalry soldiers wear spurs, but their use, except in the heat of an actual charge, is discouraged as much as possible. In the age of chivalry spurs were an essential ensign of knighthood, the spurs of knights (*equites aurati*) being golden or gilt, while those of squires were of silver. In the degradation of a knight—a ceremony rarely performed, but revived in effigy in the case of Lord Dundonald (1814)—one part of the proceedings consisted in hacking the spurs from his heels. Till into the 19th century knights of the shire might enter the House of Commons wearing spurs.

Spurge (*Euphorbia*), a genus of plants of the natural order Euphorbiaceæ, having monocépous naked flowers, the male flowers membranous, and surrounding a tricocous stalked female flower, the whole placed within a cup-shaped involucre. The fruit has three valves and three cells, the cells one-seeded, and bursting elastically. The species are very numerous, natives of warm and temperate climates, mostly herbaceous, but some of them woody. About twelve species are natives of Britain. All contain a resinous milky juice, which in most is very acrid. Several tropical species are cultivated for their great beauty in hothouses.

Spurge Laurel. See DAPHNE.

Spurgeon, CHARLES HADDON, the greatest Nonconformist preacher of his day, the son of an Independent minister, was born at Kelvedon,

Essex, 19th June 1834. He was educated at Colchester and Maidstone, and in 1849 became usher in a school at Newmarket, where he studied French and Greek. He narrowly escaped receiving a college training a little later, but gradually grew into his great sphere of usefulness and influence without the help of the schools. His leisure time at Newmarket was spent in religious work, and he began to give addresses in the hall of the Independent chapel. In 1850 he removed to Cambridge, connected himself with the Baptist church there which had been presided over by Robert Hall, and was received as a member of the Lay Preachers' Association. His first sermon was preached in a cottage at Teversham, about 4 miles from Cambridge. In his eighteenth year he had a call to be pastor of the Baptist chapel, Waterbeach, and soon the small congregation was doubled. In 1853 he was invited to preach in New Park Street Chapel, London, and in 1854 he was unanimously called to become pastor of the church. His sermons, which were issued in weekly numbers from the beginning of 1855, have been translated into most European languages. Growing popularity rendered the enlargement of New Park Street Chapel a necessity in 1855, and again in 1856, services being conducted first in Exeter Hall, and then in the Surrey Music Hall in the interim. A panic occurred (19th October 1856) while Spurgeon was preaching in the latter place, and when 7000 persons were assembled; seven persons lost their lives, and many were injured. At a service in the Crystal Palace, on a day of national humiliation in connection with the Indian Mutiny, Spurgeon preached to an audience of about 24,000. The vast Metropolitan Tabernacle was erected (1859-61); it cost £31,000, and has accommodation for about 6000 persons. Strangers flocked thither from all parts of the world to hear the popular preacher. In 1879 he received a pastor's silver-wedding testimonial of over £6000; a further sum of about £5000 was presented to him on his attaining his fiftieth year, all of which he devoted to benevolent schemes. In his later years he was a martyr to gout and rheumatism, and repeated attacks of illness and prostration led to his wintering in the south of France. He died at Mentone, 31st January 1892. A musical voice, clearness, directness, independence, and simplicity of style, combined with humour, common sense, a rich store of anecdote and continuous hard work, aided in keeping him in the front rank. He has been described as a 'hard-headed Englishman, full of sense, at moments so brightly expressed that it had all the effect of wit,' and of deep and genuine piety, if of narrow theology. The religious world learned with a shock of surprise in October 1887 of Mr Spurgeon's withdrawal from the Baptist Union, because no action would be taken by its leaders against persons charged with fundamental errors, whom he thought on the 'down-grade' theologically and spiritually.

Preaching was only one form of Mr Spurgeon's many-sided activity; his pen was as active as his mind and tongue, and many benevolent and useful institutions have grown up around the Metropolitan Tabernacle. The most important of these are the Almshouses, Pastor's College (1856), Stockwell Orphanage (1867), and a system of colportage, and book fund for ministers. He proved an excellent administrator, and his orphanages were models of good management. A publishing firm has found its main employment in dispersing his publications.

Mr Spurgeon, besides his weekly sermons and a monthly magazine, *Sword and Trowel* (1865), gave to the world upwards of a hundred volumes. He always preached extemporaneously, and had his notes written

on a half sheet of note-paper. The text was noted on the top of the page; on the left-hand side were the subject divisions, on the right-hand side the subdivisions. His sermons, taken down in shorthand, were afterwards carefully revised by himself. The average weekly circulation of his sermons was 30,000; that on *Baptismal Regeneration* (1866) rose to 200,000. At the date of his death 2241 separate sermons and 37 volumes had been published, while there was material left to last at least twelve years longer. Besides he published *The Saint and his Saviour* (1867); the very popular *John Ploughman's Talk* (1868), which has been termed a cross between the Book of Proverbs and *Poor Richard*; *John Ploughman's Pictures*; *Treasury of David*, a commentary on the Psalms in 7 vols. (1865-80), a work upon which he was engaged for more than twenty years; *Interpreter* (1874); *Morning by Morning*; *Evening by Evening*; *Feathers for Arrows*; *Lectures to my Students*; *Commenting and Commentaries*; *My Sermon Notes*; *Salt Cellars* (Proverbs); *Flashes of Thought*; *Sermons in Candles* (1891); and *Messages to the Multitude* (1892). See *Metropolitan Tabernacle and its Work* (1876); *Twelve Realistic Sketches of Mr Spurgeon*; *Speeches at Home and Abroad*, edited by Pike (1878); *Fernandez' Nonconformity in Southwark* (1882); and *Lives by Dyer, Stevenson, Pike, Walters, Shindler* (1892), and the final one by his wife and Mr Harrald (1897-99).

Spurn Head, a promontory stretching 2½ miles into the mouth of the Humber (q.v.), and forming the south-eastern extremity of Yorkshire. Its presence is indicated by two lighthouses with fixed lights, elevated 93 and 54 feet respectively above the sea, and visible for 15 and 12 miles, and by a light-vessel, whose revolving light is visible for 10 miles. Between 1771, when Smeaton's small lighthouse was built, and 1863 the sea gained 280 yards here, but since the erection of groynes in 1864 the land has gained. See Boyle's *Lost Towns of the Humber* (1889).

Spurrey (*Spergula*), a genus of plants which has been variously ranked by botanists in the natural orders Caryophyllæ, Illecebracæ, and Crassulacæ. The species are annuals, dichotomously branched, or with whorled branches; their leaves linear-filiform, in clustered whorls, with membranaceous stipules; the flowers in terminal divaricating corymbs. The flowers have a calyx of five sepals, five white petals, five or ten stamens, and five styles; the capsule is five-valved, with numerous round seeds, surrounded with a membranous border. Common Spurrey, or Yarr (*S. arvensis*), is plentiful in cornfields, especially on light stony or sandy soils in Britain and most parts of Europe. In some parts of Europe a larger variety is frequently sown for fodder, and is much relished by cattle.

Spurs, BATTLE OF. See COURTRAI, GUINEGATE.

Spurzheim, JOHANN GASPAR, one of the founders of the so-called science of Phrenology (q.v.), was born at Longwich near Treves on 31st December 1776. Whilst studying medicine at Vienna he became acquainted with Gall (q.v.), and was made a proselyte to his doctrines. The two in 1805 started on a lecturing tour through the principal countries of central Europe, and in 1807 they settled in Paris. In 1813 the two friends, their teachings disagreeing in some particulars, separated; Spurzheim proceeded (1814) to England, and lectured and wrote and laboured in the principal cities of the United Kingdom for four years, gaining a powerful adherent in George Combe (q.v.). After renouncing at Paris from 1817 to 1825, Spurzheim again went back to England and renewed his propaganda, this time with much greater success. In 1832 he sailed to the United States, but died suddenly at Boston on 10th November that same year. Spurzheim advocated his doctrines with great eloquence and enthusiasm, and

popularised phrenology and won for it a good deal of the attention it attracted. He wrote numerous books, including *Phrenology* (1825), *Philosophical Principles of Phrenology* (1825), *Manuel de Phrénologie* (1832); and some others on more general topics—e.g. *Elementary Principles of Education* (1821) and *Essai sur la Nature Morale et Intellectuelle de l'Homme* (1820). See Carmichael's *Memoir of him* (Dublin, 1833).

Spy, in War, is a useful but not highly honoured auxiliary employed to collect information and ascertain the enemy's intended operations. Spies are always used in war, and their employment is quite recognised by the law of nations as interpreted by Grotius, Vattel, and Martens; nor is it held to be any dishonour to a general to avail himself of their services. On the other hand, the spy himself is looked upon as an outlaw, and when taken is put to death ignominiously and without mercy. A spy is well paid, lest he betray his employer. In the British army spies are employed by the Intelligence branch under the quartermaster-general. In minor expeditions they are generally friendly natives. Military law, though distinct enough in ordering his death, is not clear in defining what constitutes a spy. A man, not belonging to the army, found within the lines, either in uniform or civil dress, if unable to give a good account of himself would certainly be arrested as a spy, and if anything suspicious could be proved against him would probably be hanged or shot; but if found in one camp in the uniform of the opposite side, he may not be treated otherwise than as a prisoner of war, or else as a deserter from the enemy.

Both as regards honour and penalties, it would seem that spies ought in fairness to be divided into two classes—first, those who betray their own country to an enemy (either in time of war or peace, and including persons who give foreign powers plans of fortifications, betray the construction of new weapons, &c.); secondly, those who, being enemies, contrive surreptitiously to obtain information by penetrating into the lines of the opposing army. The first class are traitors of a deep dye, for whom no ignominious death is too bad; but the second class are brave men, who dare much in the service of their country. It is unfair to accord them the same treatment as the traitors. André (q.v.) was a spy; Benedict Arnold (q.v.) was a traitor.

Civil governments, even the freest and most constitutional, do not disdain to make use, on occasion, of political spies—the most respectable use for them being the ferreting out of conspiracies and conspirators. In the days of the Tudors the political spy was a frequent and almost recognised ally of great English ministers like Burghley; in Ireland, unhappily, government has not seldom had to employ the services of Approvers (q.v.), Informers (q.v.), and also of professional spies (see Fitzpatrick, *Secret Service under Pitt*, 1892). The Secret Service Moneys (q.v.) provide for the remuneration of such persons as Le Caron of the 'Parnellism and Crime' trial in 1889, who had entered the Fenian organisation, the United Brotherhood or Clan-na-Gael, &c., and kept the government informed of all that went on in these societies. Bismarck was believed to regularly employ sham revolutionists; the second French empire had an elaborately organised system of espionage. Austria had at one time the most active agents of any European country, especially in the parts of Italy under Austrian domination. And at the present day the Russian system is the most masterful, being almost untrammelled at home, and, in the less ignoble parts of the service, represented abroad by ladies and gentlemen of great culture

and high social standing. The political spy, acting in his own country, is hard to distinguish from the detective; it will often be difficult to draw a line between the spy abroad and the renegade or traitor on the one hand, and the political agent. See Caron, *Twenty-five Years in the Secret Service* (1892).

Squadron. See CAVALRY, REGIMENT, TROOP.

Squarcione, FRANCESCO (1394-1474), originally a tailor, but founder of the Paduan school of painters, best known as teacher of Mantegna (q.v.).

Square Root. See INVOLUTION.

Squares, METHOD OF LEAST, an arithmetical process of great importance for combining observations, or sets of observations, so as to obtain the most probable value of a quantity which depends on these observations. It is in fact the scientific method of taking certain averages, and it finds its most constant use in astronomy and other physical sciences. The necessity for applying the method arises from the fact that, when the greatest precision of measurement is sought, repeated measurements of the same quantity do not agree. Thus, the altitude of a star at culmination, if carefully measured night after night by the same observer through the same instrument, will in general come out a little different in the different observations. All the measurements will, however, lie within a certain range of variation; and if all are equally trustworthy, the arithmetical mean will give the most probable value of the real altitude. The differences between this mean and the individual measurements on which it is founded are called the residuals. The important mathematical property of these residuals is that the sum of their squares is less than the sum of the squares of the differences between the individual measurements and any other single quantity that might be taken. Now, this principle of 'Least Squares' holds not only for the simple case just described, but also for more complicated cases in which one observed quantity (y) is to be expressed as an algebraic function of another or of several independently observed quantities (x). Here the object is to find the most probable values of the assumed constants or parameters which enter into the formula. When these values are calculated we can calculate in terms of them and the observed x 's a value of y corresponding to each set of observations. Comparing the calculated y 's with the observed y 's, we get a set of residuals, the sum of whose squares is a minimum if the parameters have been calculated according to a particular process. It is this process which is described as the method of least squares. Its basis is found in the mathematical principles of Probability (q.v.). See Professor Merriman's *Textbook on the Method of Least Squares* (2d ed. 1885), or Chauvenet's smaller treatise (1879), and for elementary discussion any good treatise on practical astronomy and geodesy.

Squaring the Circle. See QUADRATURE.

Squash, a term loosely used, especially in the United States, for two or three kinds of Gourd (q.v.), including the pumpkin.

Squid. See CALAMARY.

Squier, EPHRAIM GEORGE, American author and archaeologist, was born at Bethlehem, New York, June 17, 1821. From 1841 to 1848 he was a newspaper editor, latterly in Ohio; and his attention being attracted to the antiquities of the Scioto Valley, he made an exploration of similar monuments through the Mississippi Valley, an account of which was published in vol. i. of the *Smithsonian Contributions to Knowledge* (1848). He made similar explorations in New York in 1848; and next year being appointed

chargé d'affaires to the states of Central America, he used his official position as a means of making extensive geographical and archeological explorations in those regions. For his researches he received the gold medal of the French Geographical Society. In 1853 he surveyed a railway route through Honduras, and extended his archæological inquiries. In 1863 he was appointed U.S. commissioner to Peru; and afterwards he edited Frank Leslie's publications. He died in Brooklyn, 17th April 1888. Among his works are *Nicaragua: its People, Scenery, and Ancient Monuments* (1852); *Serpent Symbols* (1852); *Notes on Central America* (1854); *Waikua, or Adventures on the Mosquito Shore* (1855); *Central America* (1857); and *Peru: Explorations in the Land of the Incas* (1877).

Squill (*Scilla*), a genus of bulbous-rooted plants of the natural order Liliaceæ, with radical leaves, and flowers in terminal racemes or loose corymbs. The species, which are numerous, are natives chiefly of the Mediterranean and Caucasian regions. Three are natives of Britain, *S. verna*, which is abundant on the east coast of Ireland, the west and north coasts of Scotland, more sparingly on the east coast of Scotland, and very locally in north-eastern England; *S. autumnalis*, which is confined to some of the southern counties of England; and *S. nutans*, the wood-hyacinth or blue-bell of England, which is very abundant in most parts of Great Britain and Ireland. These and many exotic species are frequently cultivated for the sake of their beauty in British gardens.

Very different in habit from these, and now separated from the genus, is the Official Squill (*Urginea Scilla*, or *maritima*; formerly called *Scilla maritima*), a native of the sandy shores of the Mediterranean, which has a scape from two to



A, *Scilla verna*; B, Official Squill (*Urginea Scilla*): a, plant with flowering scape in blossom; b, plant with full-grown leaves. (From Bentley and Trimen.)

four feet high, with a raceme of many whitish flowers and large leaves. The bulb is of the size of a man's fist, or sometimes as large as a child's head, and contains a viscid juice so acrid as to blister the fingers if much handled, whilst the vapour arising from it irritates the nose and eyes.

Squill was used in medicine by the ancients, and is still largely employed. The bulb is dug up in autumn, divided into four parts, the centre being cut out as being inert, and the remainder being cut into thin slices, which are quickly dried by a gentle heat. The dried slices are white or yellowish white, slightly translucent, odourless, disagreeably bitter, brittle, and easily pulverisable if very dry. The bulb contains a number of active principles, the chief of which is a glucoside, *scillain*, having much the same action as digitalis; other active ingredients have been described under the names *scillitoxin*, *scillin*, and *scillipicrin*. This medicine is prescribed as a diuretic and expectorant, and occasionally as an emetic; but it must be recollected that in moderately large doses it acts as a narcotico-irritant poison, twenty-four grains having proved fatal. When given as a diuretic it is usually prescribed in combination with digitalis and calomel, when it seldom fails to produce an increased secretion of urine, and thus promotes the absorption of the dropsical effusion which is generally present when diuretics are ordered. Its dose as a diuretic is from one to three grains of the powdered bulb, or about twenty minims of the tincture. As an expectorant it is much employed in the subacute stages and chronic forms of pulmonary affections, and is very serviceable in bronchitis and pneumonia of children. From its property of promoting the secretion of mucus, it gives relief by facilitating the expectoration in cases of asthma, &c., in which the sputa are viscid. In these cases it is usually prescribed with some of the more stimulating expectorants, as carbonate of ammonium. As an expectorant the dose of the powdered squill should not exceed one grain, repeated several times daily. For children the syrup, in doses of from ten to thirty minims, may be given. As its action as an emetic is uncertain and dangerous, it should not be prescribed with the view of inducing vomiting.

Squilla, a genus of Crustaceans, representative of the order Stomatopoda. The members are sometimes called *Mantis Crabs* or *Mantis Shrimps*, from the slight resemblance to the insects of the genus *Mantis* (q.v.). The body is slightly flattened; the carapace does not completely cover the thorax; the pincers of the large anterior forceps are formed by the last joint closing on the second last; the gills are borne by the first five pairs of abdominal appendages; the last pair of abdominal appendages form a broad tail fin. The species are numerous, especially in tropical seas. They are active, voracious crustaceans, fond of burrowing in the mud; they are often very brightly coloured; the young forms undergo a marked metamorphosis, which has not been completely followed.

Squint, or HAGIOSCOPE, a narrow aperture cut in the wall of a church (generally about two feet wide), to enable persons standing in the side-chapels, &c. to see the elevation of the Host at the high altar.

Squinting (technically, *Strabismus*) is a well-known and common deformity, which may be defined as a want of parallelism in the visual axes, when the patient endeavours to direct both eyes to an object at the same time. It may be due to loss of power (paralysis or paresis) of one or more of the eye muscles; and this may depend on a merely local affection, or may be a symptom of serious brain disease. But in the majority of instances, and in all ordinary cases of squint (to which this article will be confined), no such condition is present. The squint is said to be *convergent* when the squinting eye is directed towards the nose, and *divergent* when it is directed towards the temple; the convergent is much the more common. Mis-

direction of one eye upwards or downwards is of rare occurrence. Only one eye can squint at a time; but if sometimes one eye and sometimes the other is misdirected, the squint is said to be *alternating*; if always the same eye, *monocular*.

Convergent squint usually comes on during childhood, most often from the second to the seventh year. If present at birth it is caused by some serious defect in the muscles. It is sometimes due to defective sight in the squinting eye, from congenital abnormality, severe inflammation, or injury; but very often no such condition is present. In a large proportion of cases it is accompanied by *hypermetropia* (see EYE, p. 515), and is due to the increased effort of accommodation required to see near objects, being associated with an increased and disproportionate effort of convergence. In such cases, if suitable glasses can be worn as soon as the squint begins to show itself, it may be prevented from becoming permanent. It is but seldom, however, that the surgeon is consulted at a sufficiently early stage for this treatment to have a fair chance to succeed, and even at an early stage it is by no means certain to prevent the development of a squint. In other cases the presence of a squint may be traced to the presence of worms, the irritation of teething, &c.; and it disappears when the cause is removed.

Divergent squint is very rarely present without considerable defect in the sight of the squinting eye, except where it is the result of over-correction of a convergent squint by operation. It is often associated with myopia, as the other form is with hypermetropia. When the vision of one eye is damaged by disease or injury in the adult, and takes a faulty position in consequence, divergence is much more common than convergence; in children, as has been said, the latter is the usual result.

The surgical operation for the correction of a squint consists in the division of the muscle whose excessive activity leads to the faulty position—in convergent strabismus the internal rectus, in divergent the external. It is often necessary to operate on both eyes in the same manner, even where the squint is monocular. In some cases it is requisite in addition to shorten the opposing muscle (i.e. in divergent strabismus, where this procedure is most often resorted to, the internal rectus).

Squire, an abbreviated term for *Esquire* (q.v.). The same word is also popularly applied in England to country gentlemen; and in the United States to local judges, justices of the peace, or other dignitary of the place.

Squirrel, the vernacular name of the *Sciurus vulgaris*, and in a wider sense of all members of the sub-family Sciurinae. These are characterised by their slender body, cylindrical hairy tail, and large prominent eyes; the ears are of variable size—often tufted; anterior limbs shorter than posterior, the former have four fingers and a rudimentary thumb, the latter five complete toes. Their habits are for the most part arboreal; some few excavate subterranean retreats. Their distribution is cosmopolitan, excluding the Australian region. There are seven recent genera and several fossil ones. (1) *Sciurus*, in addition to the characters of the family above mentioned, has the tail long and bushy, ears pointed—often tufted, the digits with long, curved, sharp claws, skull delicate, with long post-orbital processes, penultimate upper premolar, when present, minute. *S. vulgaris*, the common squirrel, measures 18 inches long (including the tail, which is 8 inches), and weighs about half a pound; its colour in summer is brownish red above, mixed with gray on the side of the head, white below from the chin; in winter

the brownish red above becomes mixed with grayish hairs, whilst in Siberia and northern Europe generally the whole animal becomes whitish gray without a trace of red; black varieties occasionally appear. It occurs at the present day all over the palaearctic region, from Ireland to Japan and from North Italy to Lapland, whilst its remains occur as far back in the geological history as the 'Cromer Forest Bed.' In Scotland it bade fair to become extinct, but with the planting of new woods in the later half of the 18th century it has again spread rapidly, so much so as in places to become a great nuisance. Its favourite dwellings are dry and shady woods, especially of beech and oak, whose nuts furnish it with a winter food-supply. It is always in motion, and in fine weather may be seen skipping from tree to tree as if in pure enjoyment; on the ground its pace is so rapid that a dog can scarcely catch it, but it is still more at home



Common Squirrel (*Sciurus vulgaris*).

among the branches, where its sharp claws enable it to cling safely to the smoothest bark. When undisturbed it seems to be constantly on the lookout for food, which, if abundant, is stored up for future use; and, according to Radde, it is so altruistic as to impale fungi on the tips of branches so that any passing squirrel in need may share them. It eats berries, nuts, buds, occasionally a beetle or two, and is a greedy and successful plunderer of birds' nests; it does great mischief in the spring by nibbling the fir-buds and gnawing the bark, the rising sap being apparently specially palatable to it. Soft fruit does not seem to be much appreciated, the flesh of apples and pears being discarded in favour of the pips. The squirrel will use a bird's nest for a temporary lodging, but the home is always constructed afresh, though the materials collected by others may be utilised. The nest is usually situated in the fork of a branch near the stem, and has a roof to keep out rain, a main entrance opening downwards, and a smaller accessory opening near the stem. The squirrel lies curled up when asleep, is very sensitive to the weather, and even seems to be prescient of storms. It swims freely on occasion. Pairing takes place in March, when there are often savage fights between the males; four weeks later from three to seven young are born, which remain blind for about nine days; for five days or so after the young leave the nest the whole family sports together among the trees, and then breaks up; in June there is a second brood, which may occasionally be seen in company with the former one. In winter the squirrel hibernates, awaking from time to time to feed on its stores. Its chief enemy is the marten, which is much stronger and climbs equally well, though it cannot take such leaps

from tree to tree. The fur of the squirrel has a commercial value. On the Lena trapping it furnishes occupation for many hands, some hunters having as many as 1000 snares; Russia and Siberia yield six or seven million skins per annum, valued at £150,000, but the best Siberian skins fetch as much as 1s. 6d. The genus includes between seventy and eighty other species, some of those from the Oriental region being very highly coloured; in one of them (*S. caniceps*) the back becomes of a bright orange colour during the breeding season, a rare phenomenon among mammals. (2) *Pteromys* includes the Taguan or Flying Squirrel (*P. ptaurista*), the largest of the sub-family, being nearly as large as a cat; see FLYING ANIMALS. (3) *Rhithrosciurus* is a large squirrel from Borneo, with black and white striped sides and grooved incisor teeth. (4) *Tamias* is an American genus, though one species extends into Asia and even to eastern Europe. All the four species have cheek-pouches, and the back is ornamented with darker and lighter stripes; see CHIPMUNK. (5) *Xerus* includes the so-called 'Spiny Squirrels,' of which there are four species, all African; the fur is coarse, the claws straight, and the external ear small or absent. They inhabit the dry steppes, and dig holes in the roots of trees or among rocks. The Prairie Dog (q.v.) was sometimes called the 'Barking Squirrel.' See J. A. Harvie-Brown's *History of the Squirrel in Great Britain* (Edin. 1881).

Squitch. See COUCH-GRASS.

Srinagar, or CASHMERE, the capital of the native state of Cashmere in Northern India, stands in a lovely valley of the Himalayas (besung by Moore in his *Lalla Rookh*), on both sides of the Jehlam (Jhelum), at an elevation of 5276 feet. Its appearance and situation are described under CASHMERE. Pop. (1891) 120,340.

Srirangam. See SERINGHAM.

St. For places named after saints (St Albans, &c.), see at SAINT, pp. 80-101.

Staal, MARGUERITE JEANNE, BARONESS DE, usually distinguished from the greater Mme. de Staël-Holstein as Madame de Staël-Delaunay, was born at Paris, May 30, 1684, the daughter of a poor painter named Cordier, whose name she dropped for that of her mother, Delaunay. She had a sound education at the convent of Saint Louis at Rouen, and at twenty-seven was attached to the person of the imperious and intriguing Duchesse de Maine at the little court of Sceaux. Here she saw before her eyes all that comedy of life which she was later to describe with such penetrating insight. Her position was at first a servile one, and she must often have been sorely tried by the temper of her mistress, but in herself remained not one whit of what she calls the 'caractère indélébile de femme de chambre,' and all her life was ruled in harmony with her own words, that it is only our own actions which can degrade us. Her devotion to the interests of the Duchesse brought her two years in the Bastille, where she had a love affair with the Chevalier de Menil. In 1735 she married the Baron de Staal, an officer of the Guard. She died at Paris, 16th June 1750. Her *Mémoires* (4 vols. 1755; eds. by Barrière, 1846; Lescuré, 2 vols. 1878) show intellect and observation, as well as remarkable mastery of subtle irony, and are written in a style clear, firm, and individual. 'Je ne me suis peinte qu'en buste,' she says, by which must not be understood that this lofty soul and admirable writer was ever consciously or unconsciously untrue. For indeed sincerity is her first characteristic, and throughout she reflects things like a mirror, without addition, omission, or distortion. 'Le vrai est comme il peut, et n'a de mérite que d'être ce qu'il

est.' Her (*Euvres Complètes* appeared at Paris in 2 vols. in 1821. See the study by Fray (1863), and Sainte-Beuve, *Portraits Littéraires*, vol. iii.

Staaten Island. See STATEN ISLAND.

Stabat Mater, a celebrated Latin hymn on the seven dolours of the Blessed Virgin, whose authorship has been assigned to Jacopone da Todi, a Minorite who flourished in the 13th century. It has been set to music by many composers of eminence—e.g. Palestrina, Pergolesi, Astorga, Haydn, and Rossini. See Lisco's monograph (Berl. 1843).

Stability, the name given to the property possessed by all material systems whose configuration remains permanent or never departs far from a permanent average type. There are two kinds—static and kinetic. Of static stability, or stable equilibrium, we have numerous examples of a simple character. A pendulum or any body hanging under the influence of gravity by a point which is not its centre of mass; a ball resting inside a basin; any object resting on supports in such a way that a vertical line through its centre of mass falls well within the polygon formed by joining the points of support—all these are familiar instances. If any displacement (within certain limits) is given to the body, it will, when released, tend to recover its original condition. In dynamic language the forces brought into play by the displacement resist it. If, however, the ball is placed on the top of a convex surface, or if a chair, for example, is tilted until the vertical line through its centre of mass falls outside the original area of its base, then the configuration is no longer stable. Both bodies will fall away from these positions until a new configuration of stable equilibrium is reached. In general, stability is proved by a system recovering its configuration after a slight displacement. Instability is demonstrated when any slight displacement is followed by a complete change of configuration, forces being brought into existence which assist the displacement. When a displacement brings into play no forces, so that the system tends neither to recover nor to fall away from its original configuration, the equilibrium is said to be neutral or labile. A uniform sphere resting on a plane is a simple example of this kind of equilibrium.

In kinetic stability, or stability of steady motion, a new factor comes into play. Neither a spinning-top nor a bicycle can rest upright unless it is in more or less rapid motion. The moon would fall into the earth, and the earth into the sun, if it were not for the orbital velocity sustaining each in its path. The perturbations produced by the planets cause the earth to be constantly deviating from its mean orbit; yet in virtue of kinetic stability this deviation is never large, and takes place now in one direction, now in another. If no frictional effects existed in the solar system, all the planetary orbits would never vary beyond certain assignable limits.

Stables. See HORSE, Vol. V. p. 795.

Stachys, a genus of plants of the natural order Labiate, containing a great number of species, mostly European, having a ten-ribbed calyx, with five nearly equal teeth, the upper lip of the corolla entire, and the lower lip three-lobed. Several species are natives of Britain. *S. sylvatica* is very common in shady places, a coarse herbaceous plant, sometimes called *Hedge Nettle*, with stem two to three feet high, ovate heart-shaped leaves on long stalks, whorls of purple flowers, and unpleasant smell. *S. palustris* is another very common British species, growing in moist places, and sometimes proving a very troublesome weed in meadows. The plant was formerly used as a vulnerary, and has therefore the English name *Woundwort*. Several

species are not unfrequently to be seen in flower-gardens. To this genus some botanists refer the Common Betony or Wood Betony (*S. betonica*, or *Betonica officinalis*), plentiful in woods and thickets in the southern parts of Britain, a plant one or two feet high, with hairy stem, oblong heart-shaped leaves, whorls of purple or white flowers, and a fetid smell. It was formerly much used in medicine. The roots, in small doses, are emetic and aperient.

Stade, an ancient town of Hanover, near the mouth of the Schwinge, a tributary of the Elbe, 22 miles W. by N. of Hamburg. There are large brick-works. Pop. 9997. The *Stade Dues* were a toll charged by the Hanoverian government on all merchandise carried up the Elbe to Hamburg. First formally recognised in 1691, they gradually increased till they brought a revenue of £40,000 a year. They were abolished in 1861, Hanover receiving £428,600 as compensation, of which Britain and Hamburg contributed each £155,555.

Stadium, the course on and over which the foot-races were run at Olympia and other places in Greece. It was oblong in shape, and 631 feet long. Seats were provided overlooking the course for more than 40,000 spectators. Besides foot-races, leaping, discus-throwing, wrestling, and other sports were celebrated on the same racecourse. The stadium at Athens, levelled and laid out by the orator Lycurgus in the first half of the 4th century B.C., was 600 feet long by 130 wide, and its seats could accommodate as many onlookers as those at Olympia. The length of the Olympian stadium was adopted as the Greek standard measure of length or distance. Seven and a half stadia, or 4732 English feet, were reckoned as equivalent to a Roman mile, at least in the time of the empire.

Stadtholder, a barbarous English form of the Dutch *Stadhouder*, 'stead-holder,' of which the French *lieu-tenant* is a literal translation, *Statt-halter* being the corresponding German. The word, as usually written in English, suggests quite falsely that it is connected with the German word *Stadt*, 'a city.' The title of Stadhouder (i.e. royal lieutenant or viceroy) of the provinces Holland, Zealand, and Utrecht was in defiance of the rights of these provinces conferred in 1540 on a foreigner, René, Prince of Orange, at whose death (1544) it passed to his cousin, William the Silent. In 1559 there were in the Low Countries eight other Stadholders of provinces, or groups of provinces, besides the Prince of Orange; all were commanders-in-chief of their provinces, and all except Count Egmont were also supreme civil and criminal judges. In Brabant there was no Stadholder other than the Regent. After the United Provinces had thrown off the yoke of Spain (see HOLLAND, Vol. V. p. 742) this title, now grown dear, was retained (though a misnomer) for the head of the republic, and became hereditary in the House of Orange until superseded by the title of king.

Staël, MADAME DE, one of the most illustrious of Frenchwomen, was born at Paris, 22d April 1766. Her full name was Anne-Louise-Germaine Necker, and she was the only child of Necker and his irrefragable but colourless wife, who as Suzanne Curchod had loved the young historian Gibbon at Lausanne. Germaine was an extraordinarily precocious child, figured at receptions at eleven, and grew up in an atmosphere of admiration. She ever loved and respected her mother, but her father throughout life she loved on this side idolatry. Rousseau, Clariissa, and Werther were her first idols, she was steeped in the sensibility of the age, and already in her girlhood she wrote romantic comedies, tragedies, novels, essays, and one book which has lived, *Lettres sur Rousseau* (1789). She

was fifteen when her father was dismissed from office for publishing his famous *Compte Rendu*, and withdrew into retirement, carrying with him the admiration of the whole of France. A great marriage was desired for the young heiress, and it seems certain that William Pitt on his visit to the Continent in 1783 was a suitor for her hand, and one favoured especially by her mother, although displeasing to herself. At length after long negotiations she married on January 14, 1786, the Baron de Staël-Holstein, whom Gustavus III. of Sweden pledged himself to retain as his ambassador at Paris. He was drowned in debt, and seventeen years her senior, but proved an inoffensive and easy husband. She bore him two sons (1790 and 1792) and a daughter (1797), but to protect her fortune separated formally from him in 1798, although she hastened dutifully to his bedside when he died four years later. The deepest feeling of her heart was a woman's craving for love, and those who can read between the lines of *Delphine* (1802)—the real romance of her life—will understand how little she had realised her youthful dream in marriage. But hardly less deep within her heart was the desire to shine and to please, and this she gratified to the full as a society-queen in the brilliant world of the Paris of her day. She lacked the special charm of beauty, she was careless of dress, impulsive and abrupt in manners, but her vast capacity for enthusiasm and the passionate intensity of her affections gave force and colour to her rich and versatile character, and combined to form a personality whose influence was irresistible. Society and conversation were a necessity of her nature, and called forth from the depths of her heart that flowing impromptu eloquence that subdued all hearers into admiration. The simplicity and directness of her thought was no less remarkable than its impetuosity and force, and words and ideas flowed from her lips in a kind of glorified improvisation that suggested at once the exalted inspiration of the prophet, the refined sensibility of the woman, and the clear understanding of the thinker. 'Were I queen,' said Madame de Tessé, 'I would order Madame de Staël to talk to me for ever.'

She shone brilliant and solitary in Paris, but many envious enemies—her father's before her own—embittered her triumph. Meanwhile the dawn of revolution promised to open up new horizons for France, but events moved quickly to their inevitable end, and Necker's elevation and unregretted fall but hastened on the dénouement of the tragedy. She mistrusted Mirabeau, and saw with sinking heart the ruin of the monarchy, but only quitted Paris for Coppet at the last moment, in September 1792. Indeed she risked her own life with characteristic unselfishness to save some of her friends, and only fled when it was impossible longer to remain. From Coppet she went to England, where at Mickleham in Surrey she was surrounded by Narbonne, Talleyrand, Montmorency, Lally, and Malouet, and cast her unflinching spell over that warm-hearted little prude Fanny Burney. Even here, victim of the Revolution as she was, Necker's daughter was shunned by the royalist exiles; still with all her mortifications she acknowledged that she owed to England 'four months of happiness saved from the shipwreck of life.' She joined her husband at Coppet in May 1793, and launched into the world her *Réflexions sur le Procès de la Reine* in the vain hope to save the head of Marie Antoinette. The Terror literally crushed her sympathetic heart, and all work became for a time impossible. Her mother died in May 1794; in September of the same year she found some consolation in a new friendship with Benjamin Constant, which formed an epoch in the lives of both. In May 1795 she returned to Paris, where her husband had re-established him-

self as ambassador. She prepared for a political rôle by her *Réflexions sur la Paix intérieure* (1795), and published some of the novels of her youth, with an *Essai sur les Fictions*, but the Directory found her inconvenient as a citizen of Paris, and she was advised to return to Coppet in December. Her book *De l'Influence des Passions* appeared in the autumn of 1796; the chapters on ambition and suicide are forced and feeble; those on woman's love, unsatisfied, misunderstood, betray the living heart. She was allowed to return to Paris in April 1797. The young conqueror, Bonaparte, overawed her with a vague presentiment of fear. He disliked clever women, and received her friendly advances with such studied coldness that their mutual feelings soon turned to hatred. In April 1800 she published her famous book *De la Littérature considérée dans ses Rapports avec les Institutions sociales*—a thesis of 600 pages on that perfectibility of the human mind which finds its consecration in the liberty guaranteed by republican institutions.

She returned again to Paris in March 1802, when her salon was more brilliant than ever. Here the vulgarity and charlatanism of the Napoleonic régime were heartily laughed at, but at length the epigrams of Constant, her own friendship with disaffected men like Moreau and Bernadotte, and last of all the appearance of Necker's *Dernières Vues de Politique et de Finances* exhausted the patience of Napoleon. And now commenced that ten years' duel between Cæsar and a single woman of genius, which drew towards her the pity and admiration of the world. If she does pose somewhat too complacently throughout as the victim of a tragedy, and if there is still something of theatrical exaltation in her exile's despair, it cannot be denied that Napoleon belittled himself by his malignant and spiteful persecution. Already in 1802 her friends fell off from her under Napoleon's displeasure, and in the autumn of 1803 she received orders to keep forty leagues from Paris. Her husband had died in May 1802, and she was now free to marry Constant, but she determined not to convert a slave into a master, and in December 1803 set out with her children for Weimar. Schiller received her with warmth, but Goethe paid a more unwilling homage. She dazzled the whole court with the extraordinary volubility and force of her ideas, yet even the generous Schiller breathed a sigh of relief when she departed for Berlin. Here she made acquaintance with the erudite August Schlegel, afterwards to be added to the circle of intimates at Coppet to the displeasure of Sismondi, Bonstetten, and the rest. She next turned her steps towards Vienna, but on the way learned of her father's death, and at once returned to Coppet, her heart weighed down under the deepest grief of her life. She found relief during the spring in writing the sincere and touching eulogy, *Du Caractère de M. Necker et de sa Vie privée*. Then she set out for Italy accompanied by Schlegel, Wilhelm von Humboldt, and Bonstetten, and returned to Coppet in June 1805 to write *Corinne*, a romance unfolded in a journal of travel mingled with meditations on history, the heroine again herself, exalted indeed, but recognisable down to close personal traits. It at once brought her a European fame, and it revealed to Frenchmen all the mystery and charm of Italy.

She visited Germany again in the end of 1807, thought for a moment of travelling in America, and about this time began to turn for consolation to religion, or at least to what the Duc Victor de Broglie terms with a happy and pious vagueness, 'un latitudinariste piétisme.' Her famous book *De l'Allemagne* was finished in 1810, submitted to

the established censorship, and then entrusted to the same publisher who had printed *Corinne*. To see it through the press she established herself at Chaumont, and ten thousand copies had already been struck off when the whole was seized by Savary and destroyed, and herself ordered instantly to Coppet. It was the crowning act of Napoleon's malignity, but fortunately her son had preserved the manuscript, and at length the work was safely published by John Murray at London in 1813. But her exile had now become a bitter reality, and she found herself encompassed with spies, the post-masters between Coppet and Geneva forbidden to supply her with horses, and her faithful friends, Montmorency, Schlegel, Madame Récamier, and others exiled or imprisoned for visiting her. Overwhelmed with despair, she escaped secretly to Berne, and thence made her way through Innsbruck, Vienna, and Galicia to Russia, then to St Petersburg and Stockholm, and finally in June 1813 to London. The progress of the enemy of Napoleon through the northern capitals was a continuous triumph, and in England she found herself the object of an unbounded admiration that reached its climax in the enthusiasm which followed the publication of *De l'Allemagne*, the most finished of all her works. She made acquaintance with Lord Grey, Lord Lansdowne, Sir James Mackintosh, Lord Holland, Canning, Wilberforce, and Byron. The last, while acknowledging his admiration for the writer, has not spared some characteristic sneers against the woman. The autumn of 1814 found her again at Paris. She was received with the utmost cordiality by Louis XVIII., but it sickened her patriotic heart to see that French freedom was the work of strangers whose foreign uniforms darkened the streets of Paris. Her old friends flocked to her salon; Madame Récamier, Madame de Krüdener, and Benjamin Constant, already twice married, disillusioned, and forty-eight years old, but still in love with her, although her own feeling had long subsided into quiet affection; even the time-serving Talleyrand, who had so long forgotten his early friendship, was generously forgiven. She returned for the summer to Coppet, but spent the winter of 1814-15 again at Paris, where the two millions which Necker had left in the Treasury was honourably paid back to her. The escape of Napoleon from Elba drove her hurriedly from Paris, and after Waterloo she did not return to witness the humiliation of the second occupation. She spent the winter in Italy for the sake of the health of Albert de Rocca, whom she had met about the end of 1810 at Geneva, and married secretly, though twenty-one years his senior, in the beginning of 1811. Her daughter Albertine married the Duc Victor de Broglie in February 1816. Her own health now began to give way, but she forgot her sufferings in the devoted affection of her husband, himself in enfeebled health and destined for an early grave. She died without pain on the morning of 14th July 1817, and was buried at her father's feet at Coppet. Her surviving son and daughter made public the marriage with Rocca, and received as a brother the son she had borne him. They published with pious care in 1818 her unfinished *Considerations sur la Révolution Française*, which Saint-Beuve thought her finest work, and in 1821 the *Dix Années d'Exil*.

A complete edition of her works was issued by her son, the Baron Auguste de Staël (17 vols. 1820-21), with a Notice by her cousin, Madame Necker de Saussure.

Madame de Staël has not maintained the place unanimously given her by her contemporaries and her immediate posterity, but she still remains as a woman and a writer a unique phenomenon in the history of letters. She had little creative power, was careless of

style, and was steeped in a sensibility long since happily forgotten; but her remarkable personality can never lose its attraction, and her work remains entire in its influence on the one side on Royer-Collard, Guizot, and the Doctrinaires, and on the other on Lamartine and the whole Romantic movement in France. She has given an endless subject to the ablest critics of France from her own day down to Sainte-Beuve, who says in one of his latest writings (1862), 'she has been one of the idols of my youth, and that idolatry I have not abjured.'

See the elaborate Lives by Stevens (2 vols. Lond. 1880), Lady Blennerhassett (3 vols. Berl. 1887-89; Eng. trans. 3 vols. 1889), and the shorter studies by Bella Duffy (1887) and Albert Sorel (1890; Eng. trans. 1892). See also Gérando, *Lettres inédites et souvenirs biographiques de Mad. Récamier et de Mad. de Staël* (1868), and the Comte d'Haussonville's book, *Le Salon de Madame Necker* (2 vols. 1882; Eng. trans. 1882). Criticisms will be found in Sainte-Beuve's *Portraits de Femmes*, and in the collected studies of Caro, Scherer, Brunetière, &c. Her husband's *Correspondance diplomatique* was published at Paris in 1881.—The famous estate of Coppet, bequeathed by Necker to Madame de Staël, and lastly the property of her granddaughter, Madame d'Haussonville, sister of the Duc de Broglie, was sold by her in 1880.

Staff, in a Military sense, consists of a body of skilled officers, whose duty it is under orders from the commanding officers of various grades to arrange the movements and supply of the various bodies which go to make up an army. Regimental officers deal personally with the men under their command. Staff officers deal only with the commanders of the larger units into which the troops are grouped for tactical or administrative purposes. Thus, in arranging the march of an army corps, the officers of the *Army Corps Staff* would, amongst other things, allot the available roads to the three divisions and other troops, &c. The officers of each *Divisional Staff* would direct the order in which their brigades, &c. would move along those roads. The *Brigade Staffs* would give more detailed orders, perhaps telling off the battalions required to form the advanced guards; while the *Regimental Staffs* of these battalions would order the actual formation to be assumed by them under the command of their *Regimental Officers* (captains and lieutenants). Artillery and Engineer duties, Supply and Transport for each unit are managed in a similar way. On the staff of each army corps and division there is a representative of the Artillery, Engineers, Army Service Corps, Medical Staff, Ordnance Store Corps, Veterinary and Pay Departments, Chaplains, Post-office, and Military Police. A good staff is all-important to the success of a military enterprise.

The *General Staff* of an army comprises the general in actual command, with the subordinate generals commanding the several divisions and brigades; the assistants to these—viz. the officers of the adjutant-general's department—i.e. the adjutant-general, his deputy, assistants, and deputy-assistants; the officers of the quartermaster-general's department; the brigade-majors; the provost-marshal; and the judge-advocate—the functions of all of whom are described under their respective heads. The head of the general staff of the British army is the adjutant-general at the War Office. India forms a nearly independent command, under a commander-in-chief, whose headquarters are in Bengal. There are subordinate commanders-in-chief in Bombay and Madras; and in each presidency there are several military divisions. Every general in command of a district or body of troops has a staff consisting of representatives of the adjutant-general's department and of the other services. An officer before he can be appointed to the general staff must have passed the Staff College or become qualified for the staff by having been employed as a staff officer with a force on active service, except in India, in which case he must

belong to the Indian Staff Corps. Officers of the Army Service Corps also are now appointed to the general staff at home. The *Personal Staff* consists of the aides-de-camp and military secretaries to general officers. These officers are appointed, within certain limits, by the generals whom they serve. The *Regimental Staff* of a battalion of infantry or regiment of cavalry consists of the lieutenant-colonel commanding, the adjutant, quartermaster, surgeon, veterinary surgeon, and transport officer.

Staff Corps—During the wars of Wellington the generals and staff officers were aided by a staff corps composed of intelligent officers and men who performed engineering and siege duties, made reconnaissances, and executed other necessary labours for which regimental officers or soldiers were unsuited. This corps died out after the peace. British officers serving on the permanent Indian establishment join what is called the Indian Staff Corps, and are appointed from it to do duty with native regiments, or to fill other positions either military or civil. Their promotion goes on according to length of service.

In the British Navy the staff of a fleet consists of the Flag-officer (q.v.), the Flag-lieutenant (q.v.), and a Secretary of the Navy (q.v.); also of the inspector-general of hospitals (see ARMY, p. 438; NAVY, p. 422), and an inspector of machinery.

Staffa (Scand., 'pillar-island'), a celebrated islet on the west of Scotland, lies 4 miles SW. of Ulva, 6 N. by E. of Iona, and 54 W. of Oban. It forms an oval uneven tableland, rising at its highest to 144 feet above the water, $1\frac{1}{2}$ mile in circumference, and 71 acres in area. In the north-east, in the lee of the prevailing winds, is a tract of low shore, stretching out in beaches, and forming a landing-place; but elsewhere the coast is girt with

flashing and many-coloured lights against the pendent columns, whitened with calcareous stalagmite, that form the roof, and against the pillared walls of the cave. First described (in Pennant's *Tour*) by Sir Joseph Banks, after a visit in 1772, Staffa has since been frequently visited—among others by Wordsworth, Keats, Scott, Mendelssohn, Tennyson, and (1847) Queen Victoria.

Staff College. See MILITARY SCHOOLS.

Stafford, the county town of Staffordshire, on the left bank of the Sow, 3 miles above its junction with the Trent, and 25 miles SSE. of Crewe, 29 NNW. of Birmingham, and 133 NW. of London. St Mary's Church, formerly collegiate, is a good cruciform structure, with an octangular tower. Transition Norman to Decorated in style, it was restored by Scott in 1844-47 at a cost of £30,000, and in 1878 received a bust of Stafford's chief worthy, Izaak Walton, who was baptised in its font. St Chad's, Norman, was very thoroughly restored during 1855-85; and there are also King Edward's grammar-school (1550; rebuilt 1862), the town-hall (1798), a free library (1882), the William Salt Library (1874), the Clement Wragge Museum, the infirmary (1766), the county lunatic asylum (1818), &c. Stafford Castle, finely situated on an eminence outside the town, which commands a magnificent view, is an unfinished castellated pile. It was built by Sir G. Jerningham in 1810-15, successor to a Saxon fortress of the Princess Ethelfleda, and to a later Norman stronghold, which was finally taken by the parliamentarians in 1643, and demolished. Boot and shoe making is the staple industry, and Stafford is an important railway centre. Chartered by King John, it returned two members from Edward I's reign till 1885, when the representation was reduced to one and

the parliamentary boundary extended. Pop. (1851) 11,829; (1871) 14,437; (1891) 20,270. See works by J. Masfen (1852) and J. L. Cherry (1890).

Stafford, WILLIAM HOWARD, VISCOUNT (1614-80), a Roman Catholic nobleman, beheaded on Tower Hill as a victim of the perjuries of Titus Oates (q.v.).

Staffordshire, a west midland county of England, bounded by Cheshire, Derbyshire, Leicestershire, Warwickshire, Worcestershire, and Salop. Measuring 54 by 35 miles, it has an area of 1169 sq. m. or 748,433 acres. The only hilly district is in the north, where the wild 'Moorlands,' the southern extremity of the Pennine range, extend from north-

west to south-east in long ridges, separated by deeply-cut valleys, and subside as they near the valley of the Trent. Several points exceed 1500 feet above sea-level, but Axe Edge Hill (1756) falls just within Derbyshire. The rest of the county is gently undulating, with the low upland of Cannock Chase in the centre. The Trent, flowing first south-eastward through the interior, and then north-eastward along the Derbyshire border, is the chief river, and receives the Sow, Tame, Blythe, and Dove. New Red Sandstone occupies nearly three-fourths of the total area; and in the north and south are the Pottery and Dudley coalfields, which, besides containing



Fingal's Cave, Staffa.

cliffs from 84 to 112 feet high. Regarded in section, the rocks show themselves to be of three kinds—conglomerated tufa, forming the basement; columnar basalt, arranged in colonnades, which form the façades and the walls of the chief caves; and amorphous basalt, overlying the columnar basalt, but pierced here and there by the ends of columns and by angular blocks. The most remarkable feature of the island is Fingal's or the Great Cave, the entrance to which is formed by columnar ranges on each side, supporting a lofty arch. The entrance is 42 feet wide, and 66 feet high, and the length of the cave is 227 feet. The floor of this marvellous chamber is the sea, which throws up

nearly 600 collieries, yield also (especially the northern one) vast quantities of ironstone (see IRON, Vol. VI. p. 216). The climate is cold and humid, with a rainfall of 36 inches; and, though more than four-fifths of the area is arable, much of the soil is cold and clayey, and agriculture is in rather a backward condition. In the 'Potteries' of North Staffordshire, embracing Stoke-upon-Trent, Etruria, Hanley, Burslem, &c., most extensive manufactures of china and earthenware are carried on (see Vol. VIII. p. 367); and in the 'Black Country' in the south, with Wolverhampton and Walsall, iron is very largely manufactured in all its branches. The Burton breweries are world-famous. There is a perfect network of railways and canals. Staffordshire, which is mainly in the diocese of Lichfield, contains five hundreds and 247 parishes. There are 100 county councillors, and for parliamentary purposes the county has been divided since 1885 into seven divisions, each returning one member—Leek, Burton, West, North-west, Lichfield, Kingswinford, and Hands-worth. The thirteen municipal boroughs, with their population in 1891, are Burslem, 30,862; Burton-on-Trent, 46,047; Hanley, 54,846; Lichfield, 7864; Longton, 34,327; Newcastle-under-Lyme, 18,452; Stafford, 20,270; Stoke-upon-Trent, 24,027; Tamworth, 6614; Walsall, 71,791; Wednesbury, 25,342; West Bromwich, 59,489; and Wolverhampton, 82,620. Pop. of entire county (1801) 242,693; (1841) 509,472; (1881) 981,009; (1891) 1,083,408. Staffordshire has no great wealth of antiquities, and has been the scene of no battles more important than Blore Heath (1459) and Hopton Heath (1643). Among its natives have been Lord Anson, Ashmole, Dr Johnson, Thomas Newton, Cardinal Pole, Earl St Vincent, Izaak Walton, and Josiah Wedgwood.

See county histories by R. Plot (1686), S. Erdeswick (1717; 4th ed. 1844), S. Shaw (1798-1801), and R. Garner (1844-60); the *Proceedings of the William Salt Archaeological Society (1880 et seq.)*; *Collections for a History of Staffordshire* (vol. xiii. 1893); and works cited in Simms's *Bibliotheca Staffordiensis* (Lichfield, 1894).

Stag is the term for the male of the Red Deer (q.v.). In Scotland the pursuit of the stag is mainly by deer-stalking, a long and laborious approach on foot allowing at best a chance of a rifle shot at the deer from a place of concealment. In England wild red deer are still hunted on horseback on Exmoor. The hounds are like foxhounds (see BUCKHOUND), and a good run may extend to 20 or 30 miles. The hunting season is 12th August—8th October, and 25th March—10th May. Elsewhere deer-hunting is the hunting of carted deer (usually fallow-deer) let loose from a van, the hounds being set on a quarter of an hour later. See DEER FORESTS, EXMOOR FOREST (and works there cited); *Hunting*, in the 'Badminton Library' (1885); and Fortescue's *Records of Stag-hunting on Exmoor* (1887).

Stag-beetle (*Lucanus*), a genus of Lamellicorn beetles, nearly allied to the Scarabæes. The males are remarkable for the large size of their mandibles, the branching of which in *L. cervus* and *L. elaphus* has suggested stags' antlers. The common European Stag-beetle (*L. cervus*) is a large formidable looking insect, the males being fully 2 inches long, and able to give a sharp bite with their strong mandibles. It flies about in the evening in the middle of summer, chiefly frequenting oak-woods. The larva feeds on the wood of the oak and willow, and is injurious to the trunks of trees, into which it eats its way very rapidly. It is supposed by some to be the *Cossus* of the ancient Romans, much esteemed by them as a delicacy. It lives for several years before undergoing its

transformations (see BEETLE). In most species of *Lucanus*, and of the nearly related genus *Passalus*,

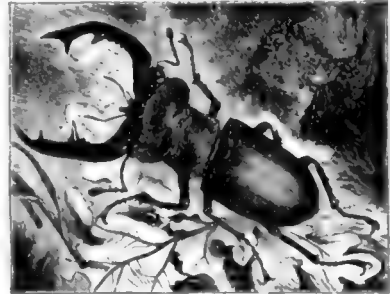

Stag-beetle (*Lucanus cervus*).

are some shade of brown, but the tropical forms are often brilliant.

Stage. See DRAMA, THEATRE.

Stage-coach. See COACHING.

Staggers is a popular term applied to several diseases of horses. Mad or Sleepy Staggers is inflammation of the brain, a rare but fatal complaint, marked by high fever, a staggering gait, violent convulsive struggling, usually terminating in stupor; it is treated by bleeding, full doses of physic, and cold applied to the head. Grass or Stomach Staggers is acute indigestion, usually occasioned by overloading the stomach and bowels with tough hard grass, vetches, or clover, a full meal of wheat, or other indigestible food. It is most common in summer and autumn, is indicated by impaired appetite, distended abdomen, dull aspect, unsteady gait, and is remedied by full doses of purgative medicine, such as six drachms of aloes and a drachm of calomel rubbed down together, and given in a quart of thin well-boiled gruel. Frequent clysters, with hand-rubbing and hot water to the belly, are likewise useful. Where the dullness increases, non-alcoholic stimulants should be given. See also HYDATID.

Staghound, a name applied both to the Buckhound (q.v.) and to the Scottish deerhound. The latter breed has been established in Scotland from



Deerhound, 'Rossie Ralph.'

time immemorial, and has probably sprung from the same source as the Irish wolfhound and the smooth greyhound. A contest between two deerhounds is vividly described in Ossian's poems. The breed seems to have been in danger of extinction about the beginning of the 19th century, when crosses of fresh blood were tried, and the breed successfully revived. Owing to the altered conditions of sport the staghound can only be

looked on now as an ornamental dog, as he is rarely used for pulling down the wounded deer, the purpose for which he was originally kept. The deerhound is an immense shaggy dog, standing nearly 30 inches high in some cases, and has a peculiar swing in his action suggestive of great speed, with a keen, determined expression. In conformation the deerhound is similar to the greyhound, but with more bone and power; the head is long, with powerful jaws. The body is covered with wiry hair about 3 inches long. The colour varies from dark gray to white. As an ornamental and graceful dog the deerhound is without an equal, and as a rule combines good temper with his other companionable qualities.

Stag'ira. See ARISTOTLE.

Stahl, FRIEDRICH JULIUS, writer on law and jurisprudence, was born of Jewish parents at Munich on 16th January 1802. He became a Protestant when seventeen, studied law at the universities of central Germany, and in 1830 published the first volume of his greatest book, *Die Philosophie des Rechts*, the second volume of which appeared three years later. In this work (of which the 3d improved edition in 1854-56 is the best) Stahl proclaimed the doctrine that belief in the revealed truths of the Christian religion is the only satisfactory basis of jurisprudence and politics. From 1832 to 1840 he taught alternately at Erlangen and Würzburg, and in 1840 was called to the chair of Philosophy of Law at Berlin. In the Prussian capital he acquired an influential position as a leader of the 'Junker' or reactionary party in the Chamber of Magnates (of which he was appointed a life-member) and as an uncompromising opponent of all political change, and the mouthpiece of a stern Lutheranism in the church assemblies. He died at Brückenau (north-west corner of Bavaria) on 10th August 1861, a determined opponent to the last of the various liberal parties in both civil and ecclesiastical politics. He wrote several other books, as *Der Christliche Staat* (1847), in which he advocated a sovereign despotism grounded on a doctrine very similar to the 'divine right of kings'; *Der Protestantismus als politisches Princip* (1853); *Was ist Revolution?* (1852); *Wider Bunsen* (1856); and *Siebenzehn parlamentarische Reden* (1862).

Stahl, GEORG ERNST, author of the Phlogiston (q.v.) theory in chemistry and of the theory of animism in medicine (see Vol. VII. p. 118), was born at Ansbach on 21st October 1660, and held successively the appointments of court-physician (from 1687) to the Duke of Saxe-Weimar, professor of Medicine (from 1694) in Halle, and body-physician (from 1714) to the king of Prussia. He died at Berlin on 14th May 1734. His chemical theory was expounded in *Experimenta et Observationes Chemicæ* (Berl. 1731), and his medical in *Theoria Medica Vera* (Halle, 1707).

Stained Glass. See GLASS (PAINTED).

Stainer, JAKOB, violin-maker, was born at Absam near Hall in Tyrol on 14th July 1621, and was apprenticed to a maker of stringed musical instruments at Innsbruck. There is a legend, devoid of foundation, however, that he worked under some of the Amati at Cremona. He did somehow learn the secret of the Italian method of constructing violins, and so won a reputation that passed beyond Germany, into Italy and England, and lasted for more than a century. At the present day his violins are valued as curiosities, but are not esteemed of use by practical musicians. Stainer died in 1683, insane, and, in spite of grand-ducal favour, in a state of poverty. There is a *Life by Ruf* (Innsbruck, 1872).

Stainer, SIR JOHN, organist and composer, was born in London, 4th June 1840, and became a chorister in St Paul's Cathedral. He was made organist of Magdalen College at Oxford in 1859, and there he successively took the degrees of Mus.Bac., B.A., Mus.Doc., and M.A. In 1872 he became organist of St Paul's Cathedral. He holds numerous other appointments, such as inspector of music to the Education Department, and professor of Music at Oxford (1889). In 1888 he was knighted. Among his works are the cantatas *The Daughter of Jarius* (1878) and *St Mary Magdalen* (1883), a *Treatise on Harmony* (5th ed. 1881), a *Dictionary of Musical Terms* (conjointly with W. A. Barrett, 3d ed. 1888), and several smaller primers and books on music.

Staines, a picturesque town of Middlesex, on the left bank of the Thames, 6 miles SE. of Windsor and 19 WSW. of London (35½ by river). It took its name from the 'London Stone' (1280), marking the county boundary; it has a granite bridge by Rennie (1832); and in the neighbourhood are Rannimede, Egham, and Cooper's Hill, all noticed separately. Pop. (1851) 2430; (1891) 5060.

Stair, a village in Ayrshire which gives the title of Earl to the ancient Scottish family of Dalrymple. A Dalrymple of Stair was among the Lollards of Kyle summoned before James IV.; his great-grandson was one of the earliest to make public profession of the Reformed doctrines.—James Dalrymple of Stair (1619-95) studied at Glasgow University, served in the army, and acted six years as Regent in Philosophy at Glasgow, next joined the bar (1648), and scarcely ten years after was recommended by Monk to Cromwell for the office of a lord of session, as 'a very honest man and a good lawyer.' He was confirmed in office, and created a Nova Scotia baronet in 1664. It was the death of his daughter Janet in 1669, within a month of her marriage to Dunbar of Baldoon, that gave Scott the tragic plot of *The Bride of Lammermoor*. His wife, who survived till 1692, was credited in Galloway with being a witch. About the close of 1670 Dalrymple was made president of the Court of Session and member of the Privy-council, and during the next ten years, if he distinguished himself by reforms in legal process, he must have winked hard at much wickedness and illegality in high places. The Duke of York took up the work of government at Edinburgh in 1679, and Dalrymple, who honestly hated Popery at least, soon found himself obliged to retire to the country. In his leisure he prepared his famous work, the *Institutes of the Law of Scotland*. His wife and his tenants were devoted to the Covenant, and accordingly he soon became involved in a fierce dispute with Claverhouse, who was ravaging Galloway with a military commission. In October 1682 he found it necessary to flee to Holland, returned with the Prince of Orange, and soon after was restored to the presidency in Lockhart's room. He was created Viscount of Stair, Lord Glenluce and Stranraer in 1690, was much molested by factious attacks during his last years, and died at Edinburgh, 25th November 1695. See J. G. Mackay's *Memoir* (Edin. 1873), and *The Stair Annals*, edited by J. Murray Graham (Edin. 1875).—His second son was Sir James Dalrymple (q.v.). Collaterally connected was the learned Lord Hailes (q.v.), whose own younger brother was the hydrographer Alexander Dalrymple (q.v.).

The eldest son, Sir John Dalrymple, first Earl of Stair, was born in 1648, and followed the hereditary profession of his family. He came into violent collision with Claverhouse in Galloway, and was flung into prison in Edinburgh and heavily fined, but early in 1687, by a remarkable turn in the

royal policy, 'the springs' of which Wodrow prudently leaves 'to the civil historian of the period,' he had all his charges remitted, and became king's advocate, Lord Justice-clerk the next year. He acquiesced easily in the accession of William, became Lord Advocate, and for some years as Secretary of State had the chief management of Scottish affairs. On his shoulders, therefore, with Breadalbane and the king, mainly rests the infamy of the massacre of Glencoe (q.v.). He was created Earl of Stair in April 1703. He took an active part in the debates and intrigues that preceded the carrying of the Treaty of Union, and indeed fell a victim to his zeal in its cause, dying suddenly the morning after a long and vehement debate, 8th January 1707. 'He was,' says Defoe, 'justly reputed the greatest man of counsel in the kingdom of Scotland.' See Omond's *Lord Advocates of Scotland* (vol. i.), and J. Murray Graham's *Stair Annals* (2 vols. 1875).—John Dalrymple, second Earl of Stair, was the second son of the second viscount and first earl, and was born at Edinburgh, 20th July 1673. At eight he shot his elder brother dead by accident at the family seat of Carsreugh Castle in Wigtownshire. He was brought up in Holland, studied at Leyden, and early attracted the notice of the Prince of Orange. He volunteered for service, was present at Steenkerk, and by 1701 was lieutenant-colonel in the Scots foot-guards, in 1706 colonel of the Cameronians. He was aide-de-camp to Marlborough in 1703, and showed conspicuous courage at Venlo. He commanded a brigade of infantry at Ramillies, and was rewarded with the colonelcy of the Scots Greys in August 1706. He distinguished himself greatly at Oudenarde (1708), was promoted major-general, and commanded his brigade at the siege of Lille and at Malplaquet. His rank of general he received in 1712, after which he retired to Edinburgh to intrigue for the Hanoverian succession. In 1714 he married the beautiful and strong-willed widow, Eleanor, Viscountess Primrose, forcing her consent for the sake of her reputation by the artifice of concealing himself in her house and showing himself at her bedroom window. This audacious ruse afforded a foundation for Scott's story, *My Aunt Margaret's Mirror*. On the accession of George I. Stair returned to favour, and soon after was appointed ambassador to Paris. He played a great rôle under the regent Orleans, lived with splendid magnificence, yet checkmated at every turn the Pretender and the vast schemes of Alberoni. Recalled in 1720 with fortunes sadly impaired, he mainly devoted himself thereafter to agricultural improvements, introducing turnips and cabbages, while his clever wife became a leader of society in Scotland, and helped to make Moffat the fashion. On Walpole's fall Stair was made field-marshal (1742), and appointed governor of Minorea, without residence. He took the command of the army which was to act in support of Maria Theresa in conjunction with a Dutch and Austrian force, but had already lost ground strategically in presence of Noailles, when George II. came to take command in person. Stair showed his usual courage at Dettingen, but after the victory was allowed to resign. He died at Queensberry House, Edinburgh, 9th May 1747. See the *Annals* by Graham.

Stalactites, STALAGMITES. See CAVE, p. 34.

Stall, the technical English name for the seats in churches reserved for the clergy and choir, and usually lining the choir or chancel on both sides, sometimes in two or more rows. In cathedrals and other large churches they are generally enclosed at the back with a high screen, and are often surmounted with pinnacled canopies of tabernacle work, the backs and arms being usually

carved in a more or less ornate manner. At the west end are often 'return' stalls, facing east; for the dean, warden, chancellor, or other dignitaries.

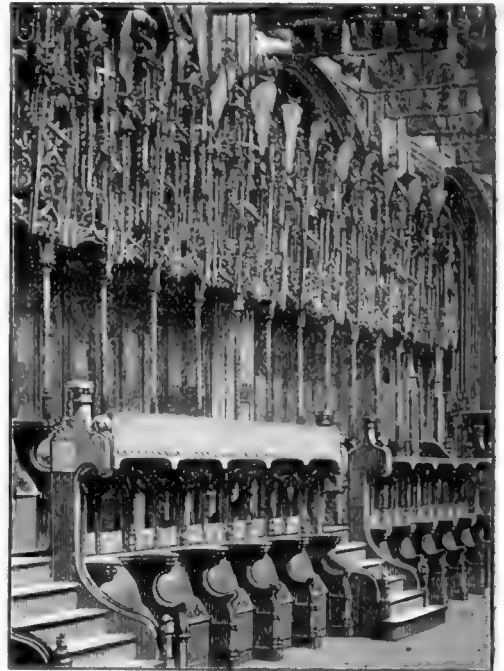

Stalls, Westminster Abbey.

In Henry VII.'s Chapel (1502-20), Westminster Abbey, the dark oak choir stalls, with their finely-carved Misereres (q.v.), are appropriated to the Knights of the Bath, and the lower seats to their squires; and each stall bears its occupant's armorial bearings in brass, with a sword and banner above. At Winchester, Chester, Windsor, and King's College, Cambridge, are also fine examples of stalls.

Stallbaum, GOTTFRIED (1793-1861), professor at Leipzig, edited Herodotus, Plato (12 vols. 1821-25), and other classics.

Stalybridge, a cotton town of Cheshire and Lancashire, with machine-shops, &c., $7\frac{1}{2}$ miles E. by N. of Manchester. It was made a municipal borough in 1857, a parliamentary borough in 1867. Pop. of the former (1851) 20,760; (1891) 26,783; of the latter (1891) 44,135.

Stamboul. See CONSTANTINOPLE.

Stambuloff, STEPHAN NIKOLOF, Bulgarian statesman, was born, the son of an innkeeper, in 1855, at Tirnova, studied there and at Odessa, and bore a part in the rising of 1875-76. He held office during the Russian occupation after the war of 1878, and, now an advocate in Tirnova, became conspicuous as a radical leader in the new National Assembly. He was the chief member of the regency after Prince Alexander's abdication (1886), and strenuously opposed all Russian partisans. After the election of Ferdinand he was premier 1887-94, and ruled with as little regard for the prince as for the Assembly. Forced then to retire, on 15th July 1895 he was attacked by assassins and savagely mutilated, and died on the 18th. See Life by A. Hulme Beaman (1895).

Stamens, forming the male part of the Flower (q.v.), comprise a filament and an anther, and are inside flower leaves, petals, and sepals, and outside

the fruit leaves, the carpels. But their position on the axis, whether below the carpels, as is most commonly the case, or on a level with them, or above them, varies, and is used as a means of classification. When they are inserted on the thalamus (flower receptacle) below the carpels the flower is said to be *hypogynous*; when, carried upwards by the continued growth of the outer part of the flower receptacle, they are inserted on the same level as the carpels then the flower is *perigynous*; when, carried up still farther, they are inserted above the carpels the flower is *epigynous*. If the stamens are adherent to the petals they are *epipetalous*, if adherent to the pistil (united carpels) they are *gynandrous*. If the filaments only are more or less coherent (Mallow) the stamens are *monadelphous*; if united into two bundles (pea) they are *diadelphous*; if only the anthers cohere then the stamen is *synantherous*. The stamens vary in number from a single one in a flower to as many as several hundreds. These variations also are used in classification. When the stamens are *definite*, few (five to ten) in number, the individuals are inserted one opposite each of the petals, or each of the sepals, or one opposite all of them. If they are less in number than the petals or sepals of the flower, then their position varies. When there is more than one whorl of stamens then the individuals of each whorl alternate with the individuals of the next whorl below it. Often the full number of stamens, that comparison with other flowers of the same order would lead us to expect, is not present; but usually aborted traces of them may be seen. Thus the Scrophulariæ are peculiar in having only four stamens, but the fifth is represented by a minute scale. Remnants of this description are called *staminodes*.

The stamens are commonly said to be metamorphosed leaves. But, since a leaf is defined as an appendage of the axis or stem, this statement is only an assertion of the general homology, or similarity of origin, of the two kinds of appendages. Often, too, stamens are said to be altered flower-leaves—i.e. petals. But this is a case of putting the cart before the horse. Stamens very commonly become petaloid, as for instance when a flower becomes 'double' under cultivation, and in a few cases in the natural state, the white water-lily for instance. In all such cases there may be seen in the same blossom a complete series of transition forms between stamens and petals. This indicates the homology of the two kinds of appendages, but of itself gives no evidence as to which form is the precursor of the other. But the fact that the Gymnosperms (q. v.), conifers, for example, which are older forms and are less highly developed than the true flowering plants, have stamens but not petals, shows that the petals of the Phanerogams are derived from stamens, and not the stamens from the petals. The further facts that the characteristic colour of stamens is yellow, and that the simplest, lowest flowering plants have yellow flowers, is another piece of evidence that leads to the same conclusion.

The anther which contains the fertilising pollen is the essential part of a stamen. The pollen is set free by the splitting—*dehiscence*—of the anthers. The mode of dehiscence is sometimes characteristic of the plant. Thus the anthers of the Rhododendra open and shed their pollen through a small circular pore at the upper end of each lobe; and in a few cases the dehiscence is transverse, or across the anther. But the most usual mode of dehiscence is by a longitudinal slit in each lobe, either on the inner or outer face of the anther.

The time at which the stamens dehisce relatively to the ripening of the stigma is important.

For if the anther dehisces when the stigma is ready to receive pollen then the flower may be self-fertilised; but if it does not open at that time then self-fertilisation will be impossible, or nearly so, and that flower must be cross-fertilised. Stamens present numerous modifications of form that are apparently adaptations to the process of fertilisation.

See Sir John Lubbock's *Flowers in their Relation to Insects* ('Nature' series, 1875); Kerner's *Pflanzenleben* (vol. ii. 1891).

Stamford, a municipal borough chiefly in Lincolnshire, but partly also in Northamptonshire, on the Welland, 12 miles WNW. of Peterborough. Hengist is said to have here defeated the Picts and Scots in 449, and Stamford thereafter is notable as one of the Danish 'five burghs,' as having been visited by at least thirteen sovereigns (from Edward the Elder in 922 to Queen Victoria in 1844), for the persecution of its Jews (1190), as having between 1266 and 1334 only missed becoming a rival to Oxford, for its colony of Flemish Protestants (1572), as the birthplace of the earliest provincial newspaper, the *Stamford Mercury* (1695), and for its famous bull-running on 13th November from King John's time until 1839. It has lost ten of its sixteen churches, an Eleanor Cross, two castles, six religious houses, and two hospitals. Existing edifices are St Mary's, with a fine spire, All Saints, with a fine tower and steeple, St Martin's with Lord Burghley's grave and, in the churchyard, Daniel Lambert's, a town-hall (1777), corn exchange (1859), literary institute (1842), bridge (1849), Browne's Hospital (15th century), and boys' and girls' high schools (1874-76). 'Burghley House, by Stamford town,' is a magnificent Renaissance pile, dating from 1575, with a noble park, carvings by Grinling Gibbons, and a great collection of pictures. The trade and industries are mainly agricultural. Chartered by Edgar in 972, and afterwards by Edward IV., Stamford was a parliamentary borough, but lost one of its two members in 1867 and the other in 1885. For good services rendered by the inhabitants at the battle of Loose-coat-field (in 1469) the town seal bears the royal arms. Pop. (1851) 8933; (1891) 8358.

See works by Butcher (1648), Howgrave (1726), Peck (1727; new ed. 1785), Drakard (1822), Sharp (1847), Walcott (1867), and Nevinson (1879).

Stamford, a town of Connecticut, on Long Island Sound, 33 miles by rail N.E. of New York. It has a handsome town-hall, and the hills around are embellished with the summer residences of well-to-do New Yorkers. Steamboats run daily to New York. There are iron and bronze foundries, and manufactories of hats, drugs, sashes and blinds, and Yale locks (see LOCK, p. 680). Stamford was settled in 1641. Pop. (1880) 11,297; (1890) 15,700.

Stamford Bridge, a small town in the East Riding of Yorkshire, on the river Derwent, 9½ miles N.E. of York by rail. It was the scene of the great victory of King Harold (q. v.) over the invading Norwegians under Harold Haarfager.

Stammering, or STUTTERING, is an infirmity of speech, the result of failure in co-ordinate action of certain muscles and their appropriate nerves. It is analogous to some kinds of lameness; to cramp or spasm, or partial paralysis of the arms, wrists, hands, and fingers, occasionally suffered by violinists, pianists, and swordsmen; to the scrivener's palsy, or writer's cramp, of men who write much. For speech—like writing, fencing, fingering a musical instrument, and walking—is a muscular act involving the co-ordinate action of many nerves and muscles.

The words stammering and stuttering practically denote the same infirmity. Any distinction that

may have come to be established in the usage of them respectively would seem to be that stuttering—an onomatopœic word—is now limited more or less to the futile repetition of sounds, while stammering (akin to 'stamp,' 'stump,' 'step,' 'stop') covers the whole defect, the hesitation, glide, stop, holding on to the sound as well as repeating it. With defective articulation due to malformation—cleft palate, high-roofed mouth, disproportionate tongue and tonsils; or due to affectation and bad habit—interjection of meaningless sounds, lisping, burring, and other such imperfections of speech, we have nothing further to do in this article, beyond remarking that a fault of habit may be entirely cured, a faulty formation can only be mended, its irksomeness alleviated.

Since speech at a high degree of excellence is a fruit of advanced civilisation, it is not startling to be told that stammering does not prevail among Negroes in Africa and North American Indians. But when it is proved to be pretty wide-spread in Prussia, Great Britain and its colonies, and the United States of America, and uncommon in Italy and Spain, the question suggests itself whether languages of Teutonic origin are not more apt to generate stammering than languages of Latin origin. A much larger proportion of males stammer than of females.

Stammering, the chief of the imperfections of speech, may be hereditary, and it may be acquired by imitation. Like yawning, it is infectious. It may be the abiding result of mental strain or shock. Fever may bring it on, epilepsy, hysteria, any nervous affection, temporary failure of health, any excitement, soreness of the mouth. It rarely shows itself earlier than at four or five years of age. It usually begins in youth, but may be produced at any later age. It used to be ascribed exclusively to the organ of articulation, the mouth; to faulty setting of the teeth or the jaws, to the largeness and thickness of the tongue, its weakness of movement, its excessive vigour. The cause indicates the cure. A wedge was cut out of the tongue, lengthways, to make a path for the current of air. The root of the tongue was cut to break its excessive vigour. The tongue was thought to lie too flat on the bottom of the mouth; a plug was inserted to raise it, Demosthenes and the pebbles being referred to. It was one of the secret cures to tell the stammerer to keep the tip of his tongue on the roof of his mouth. An improvement on this was to keep the whole breadth of the tongue lying on the palate. When, by-and-by, the breathing began to be taken into account, stammering was explained exclusively by reference to the organ of respiration, and the cure was breathing exercises which were kept secret. The latest step in the research for the cause and cure of stammering has been to take full account of the vocal chords or cushions and the vocal chink.

Stammering occurs in the mouth, the organ of articulation. Its proximate cause is always in the larynx, the organ of voice. Sometimes the lungs, the organ of breathing, complicate the uncertainty and unsteadiness of the vocal chords and the vocal chink in the larynx. A current of air, variously shaped by the mouth as a whole, is what we call a vowel. A stammer on a vowel can only take place in the vocal chink, *rima glottidis*. The sounds called consonants are produced by closures, more or less firm, of contents of the mouth. Thus, *b, p, m, w*, by the closure of the two lips; *f, v*, of the lower lip and upper teeth; *g* soft and *sh*, of the teeth; *l* and *th*, tongue and upper teeth; *t, d, n, z, z, y*, tip of the tongue and fore gum; *g* hard and *k*, back edges of the tongue and back gum. Stammering may occur at any of these six closures. It is, perhaps, most apt to occur at the labials *b, p*,

the dentals *d, t*, the gutturals *g* hard, *k*, because for these the closure is firmest. The stammerer has no difficulty in setting lips, teeth, tongue, and gums against each other as required. His difficulty is to relieve the closure, to get at the vowel which is to follow the consonant. The tongue, for example, will not part with the teeth, seems to cling spasmodically to them. Why? Because the current of air, the vowel, does not come at the proper instant through the vocal chink to relieve it. In this way the three observable modes of stammering are explained. If the vocal chink does not open soon enough there is a stop stammer; if it flutters, there is a stutter; if it opens too soon, there is a glide stammer. But, further, the lungs expand and contract by nervous and muscular energy; and, besides, the muscular and nervous machinery of the breastbone, ribs, midriff, and upper abdomen are all concerned in that expansion and contraction. These complicated and delicate bellows which supply air under pressure to the organ of voice may be defective, out of order, misused. Their working is to be closely observed in the case of each stammerer. Stammerers, as a rule, breathe badly. They constantly try to speak when their lungs are empty.

Stammering can be cured. It often disappears gradually without effort at cure. Improvement generally takes place as age advances. In some cases resolute endeavour is demanded. A waving motion of the arms, time kept to a baton, were favoured as cures at one time. They were on the lines of the musical methods of cure—intoning, chanting, singing—which were based on the fact that most stammerers can sing. The doctrine of this article suggests as instructions for cure: Regulate the breath. Work for an habitual use of the chest voice—i.e. for deeper, steadier vibration of the vocal chords—because people generally stammer in a head voice. Take exercise, in a chest voice, on the sounds (seldom vowels) at which a stumble is apt to be made.

Stamp Act, a measure which required all legal documents in the colonies to bear stamps, proposed by Grenville, then premier, and passed by parliament in 1765. The Americans denied the right to the English parliament, in which they were not represented, to impose taxes upon them, and offered violent opposition. Riots took place in many of the towns, the offices were seized, and the stamped paper destroyed; while a congress of delegates of nine of the states met at New York in October, and passed resolutions claiming for the provincial assemblies the exclusive right of taxation. In the January of 1766 the subject was brought before parliament. In the great debate that followed Burke made his maiden speech, and Pitt, who had been absent for a year, in one of his greatest speeches denied the absolute right of parliament to tax the colonies, as taxation and representation went hand in hand. After examining witnesses, chief among them Franklin, the ministry proposed the repeal of the Stamp Act, and carried it on February 21. Thus Pitt's wisdom staved off for a time the breach between England and her colonies.

Stamps, impressed and adhesive, are extensively used for making and verifying payments of money. Stamp-duties were first imposed in England in 1694; the basis of the existing law is the Stamp Act of 1870; see Griffith's *Digest of the Stamp Duties* (9th ed. 1888). For the protection of the public revenue penalties are imposed; thus any person receiving a premium of insurance without issuing a properly stamped policy is liable to a fine. Where the law requires a stamp, an unstamped document cannot be given in evidence in civil

proceedings unless the party producing it is willing to pay the duty and an additional penalty. Stamp-duties are a form of indirect taxation. It is admitted that they ought to be moderate in amount; excessive duties on negotiable instruments, transfers of property, or legal proceedings would operate to the discouragement of business. The amount of the stamp-duties received in the United Kingdom has risen from £6,726,817 in 1840 to £8,040,091 in 1859-60, £11,306,914 in 1879-80, and £13,460,000 in 1890-91. See Tilsley, *Stamp Laws*. During the American civil war (1861-65) stamp-taxes were laid on all manner of legal documents, bank drafts, cheques, and on the packages of various kinds of manufactured goods, but these were gradually withdrawn. The last stamp-taxes on matches, proprietary articles, playing cards, bank cheques and drafts were repealed in 1883; and the revenue from adhesive stamps, which was \$4,140,175 in 1863, rose to \$16,544,043 in 1870, and was \$7,053,053 in the last year, vanished from the internal revenue returns. Forgery (q.v.) of stamps is severely punished.

Stamps for postal purposes were used, or were proposed to be used, in Paris as far back as 1653. Stamped paper or covers, both with impressed and embossed stamps, were used for official correspondence in the kingdom of Sardinia in 1819-21, several values being provided for. Mr Charles Knight suggested stamped covers for the prepayment of newspaper postage in 1833-34. Stamps or labels, to be gummed or pasted on articles liable to duty, have been in use by the British Revenue authorities ever since 1802, though prior to 1840 they were not issued ready gummed. The use, for postal purposes, of a piece of paper just large enough to bear the stamp, with a glutinous wash on the back rendered adhesive by moisture, was recommended by Sir Rowland Hill (q.v.) as part of his scheme of uniform rates of postage, combined with prepayment, in his pamphlet on post-office reform in February 1837.

Not till after the death of Sir Rowland Hill in 1879 was it disputed that the credit of the adhesive postage-stamp was due to him; though in 1846 Mr James Chalmers, a bookseller of Dundee, received a testimonial from his fellow-citizens for the post-office reforms advocated by him, including the use of adhesive stamps; but from 1879 onwards till 1891 a pamphlet controversy was carried on by Mr Patrick Chalmers, insisting that the credit was wholly due to his father. The idea, it was affirmed, was fully developed as early as 1834. Specimen stamps were, it was said, made and exhibited in that or the next year on Mr Chalmers's premises, who submitted his plan to the Treasury in 1839, which was then, but not before, taken up by Sir Rowland Hill. This, however, was denied by Mr Pearson Hill (Sir Rowland's son). Mr Hill read an elaborate statement on the subject before the London Philatelic Society in November 1881, pointing out that while the use of adhesive stamps was proposed by Sir R. Hill in February 1837, Mr James Chalmers's own letters, still preserved, give November 1837 as the date at which he first put forward his scheme, and that when in 1840 Mr J. Chalmers's attention was called to Sir R. Hill's proposals of February 1837, he at once abandoned his claim to priority. The Philatelic Society decided that Mr P. Chalmers had failed to produce any evidence that Sir Rowland Hill had derived the idea from Mr James Chalmers. Both seem to have hit on the plan independently: but the use of adhesive postage-stamps without uniform postal rates, and at a time when the practice of sending letters unpaid was almost universal, would obviously have been impossible. Sir Rowland's reform of 1840 for the first time made the use of postage-stamps practicable. Mr Pearson Hill's case was

published as a pamphlet (*The Origin of Postage-Stamps*) in 1888. Mr Chalmers also issued pamphlets with testimonies from two or three old persons who, doubtless unaware of Mr James Chalmers's own written statements, professed to remember that his suggestion of adhesive stamps was made as early as 1834; but no contemporary documents to certify the early date were produced.

With the postal reform of 1840 the Franking (q.v.) of letters was abolished in the United Kingdom, and postage-stamps introduced. The first English postage-stamp (issued on 6th May 1840) was black. The famous 'Mulready envelope,' issued at the same time, and intended to be both cover and stamp, was not a practical success, and was withdrawn the same year. Since then upwards of 100 postage-stamps of various designs or values have been used in the United Kingdom: in the British empire (with colonies) upwards of 1600 different postage-stamps are or have been in use. The red penny stamp in use in Great Britain from 1841 to 1880 underwent some hundred and fifty minor modifications, of which in each sheet there would be 240 varieties, so that for stamp-collectors Britain itself presents a large field.

Stamp-collecting began to be a common and fashionable hobby about 1861, which spread from Britain to the Continent; and in 1890 there were three collections of postage-stamps of all kinds of which the aggregate value was estimated at more than £100,000. The stamp-collecting pursuit is called philately, timbrophily, and timbrology; and there are numerous philatelic societies at home and abroad which publish transactions or journals. Rare stamps bring high prices. The Mulready penny envelope unused is worth about 15s.; a stamp of the first Sandwich Islands issue of 1852 about £65; and two of Mauritius of 1847 have been sold for £680.

See works on stamps or stamp-collecting by Philbrick and Westoby (1881), Evans (1885), Ogilvy (1883), Booty, Hardy, and Bacon (1898). See also RECEIPT.

Standard. See FLAG, CURRENCY, MONEY, BIMETALLISM, WEIGHTS AND MEASURES, HALL-MARKS; for the Battle of the Standard, NORTH-ALLERTON.

Standing Orders is the name given to permanent regulations made by either House of Parliament for the conduct of its proceedings, and enduring from parliament to parliament unless rescinded. A standing order of the House of Lords when rescinded is said to be *vacated*; in the Commons the corresponding term is *repealed*. In the Lords a motion for making or dispensing with a standing order cannot be granted on the same day that the motion is made, or till the House has been summoned to consider it; and every standing order as soon as agreed to is added to the 'Roll of Standing Orders,' which is carefully preserved and published from time to time. In the House of Commons there was until 1854 no authorised collection of standing orders, except such as related to private bills. In that year a manual of rules, orders, and forms of proceeding relative to public business was drawn up and printed by order of the House. Standing orders are occasionally suspended when it is desirable that a bill should be passed with unusual expedition. See May, *Parliamentary Practice*.

Standing Stones, or monoliths of unhewn stone, erected singly or in groups, are met with almost everywhere. They are not in all cases necessarily of ancient origin, but the motive of their erection may be presumed to have been in general honorary or commemorative either of events or individuals. In certain cases, however, they

marked the boundaries of sanctuary or proprietary rights. Single stones, sometimes of great size, are often found standing in sites where no memory or tradition of their purpose exists. Occasionally accident or investigation discloses the fact that they mark the sites of prehistoric burials. They are sometimes arranged in groups of two or four, placed at short distances apart, as at Lundin Links, near Largo, in Fife, three of which are still standing (about 18 feet in height), as shown in the engraving. Such groups if composed of a large number of stones may be arranged in the form of circles, or avenues, or alignments, or groups of irregular lines converging slightly at one end. When arranged in the form of circles they are usually considered as belonging to a special class of prehistoric monuments or burial-places known as Stone Circles (q.v.). Other groups of standing stones arranged in lines like those of Carnac (q.v.) in Brittany, however, are as yet undetermined as to their purpose, though they are unhesitatingly assigned to the prehistoric period. Smaller groups than the famous ones of Brittany are found in the north of Scotland, and are sometimes associated with burial-cairns, presumably of the age of bronze.



Standing Stones, Lundin Links, Fifeshire.

Several of these have been described in Caithness, the largest consisting of about 450 stones disposed in twenty-two rows of about 150 feet in length. In Norway groups of standing stones arranged in triangular and rectangular forms occur, and are known by investigation to be burial-places of the iron age. Commemorative monuments of the early Christian time frequently consist of unhewn blocks of stone having short inscriptions cut on their smoother faces, or incised with crosses or symbols. See Ferguson's *Rude Stone Monuments* (1872), and other works cited at ARCHEOLOGY and SCULPTURED STONES.

Standish, MYLES, was born at Duxbury, Lancashire, about 1584, served in the Netherlands, and, though not a member of the Leyden congregation, sailed with the *Moytencer* colony to Massachusetts in 1620, and became the champion of the Pilgrims against the Indians. During the first winter his wife died, and the traditional account of his first effort to secure another partner has been made familiar by Longfellow. In 1622, warned of a plot to exterminate the English, he enticed three of the Indian leaders into a room at Weymouth, where his party, after a desperate fight, killed them, and a battle that followed ended in the flight of the natives. In 1632 he settled at Duxbury, Massachusetts, where he died, 3d October 1656. Standish was the military head of the colony, and

for long its treasurer. A monument, 100 feet high and surmounted by a statue, has been erected to him on Captain's Hill, at Duxbury. See De Costa's *Footprints of Miles Standish* (1864); Henry Johnson's *Exploits of Miles Standish* (1897).

Stanfield, CLARKSON, marine painter, was born of Irish Roman Catholic parents at Sunderland in 1794, his father being an actor and author. He became a sailor in 1808, was pressed into the navy in 1812, and served for a time in the ship in which Douglas Jerrold was a midshipman. He showed talent both in painting and drawing, and was taken note of by Captain Marryat. Stanfield left the navy in 1818, and thereafter took to scene-painting as a means of earning his bread—at first in the Old Royalty Theatre, and afterwards in Edinburgh and at Drury Lane. While painting for the theatres he had by no means neglected easel-painting. The first picture by him that attracted any considerable notice was 'Market-boats on the Scheldt,' exhibited at the British Institution in 1826. In 1830 Stanfield exhibited at the Academy his 'Mount St Michael, Cornwall,' which placed him at once in the foremost rank as a marine painter. In 1823 Stanfield, in conjunction with David Roberts and others, founded the Society of British Artists. Elected A.R.A. in 1832 and R.A. in 1835, he continued to send pictures to the Academy till his death at Hampstead, 18th May 1867. Among his best-known pictures, marked by truth, finish, and poetic feeling, were 'The Abandoned' and 'The Wreck of a Dutch East Indiaman.'

Stanford, CHARLES VILLIERS, musical composer, was born at Dublin on 30th September 1852. He entered at Queen's College, Cambridge, and in 1873 was appointed organist at Trinity College there. Except his operas, most of his works have been produced at one or other of the musical festivals in the provincial capitals of England—Gloucester, Birmingham, Leeds, Norwich, &c. His best and

most successful productions have been the choral settings of Tennyson's *Revenge* (1886) and the *Voyage of Maeldune* (1889); the oratorios *The Three Holy Children* (1885) and *Eden* (1891); the operas *The Veiled Prophet of Khorassan* (1881), *Savonarola* (1884), and *The Canterbury Pilgrims* (1884); an orchestral serenade; a couple of symphonies, particularly the *Elegiac* symphony (1882); and some pieces for the violin and pianoforte. In 1882 he was appointed professor of Composition and Orchestral Playing in the Royal College of Music, and in 1887 succeeded Sir G. A. Macfarren as professor of Music at Cambridge. The opera *Shamus O'Brien* was produced in 1886.

Stanford, LELAND, railway constructor, millionaire, and senator, was born at Watervliet, New York, 9th March 1824, and in 1856 settled in business in San Francisco. A strong supporter of the Pacific Railway scheme, he was made president of the Central Pacific Company, and superintended the construction of the line. Already governor of California, he was in 1885 elected a United States senator. Out of a fortune estimated at more than \$50,000,000 he gave to the state of California \$20,000,000 to found, in memory of his son, a university at Palo Alto (q.v.), where, over and above the usual academic studies, telegraphy, type-setting, farming, journalism, &c. should be taught. He died June 20, 1893.

Stanhope, a town in the county of Durham, on the Wear, 26 miles W. of Durham by rail. Its rectory, once known in the north country as the 'golden rectory,' was held by Bishop Butler (1725-40). The famous lead-mines are now much less profitable than of old. Pop. 1840.

Stanhope, LADY HESTER LUCY, the eldest daughter of Charles, third Earl Stanhope, and his wife Hester, daughter of the great Lord Chatham, was born at Chevening, Kent, on 12th March 1776. She grew up to be a woman of great personal charm and of unusual force and originality of character. In 1803 she went to reside with her uncle, William Pitt, and as mistress of his establishment and his most trusted confidant during his season of power and till his death she had full scope for the exercise of her imperious and queenly instincts. On Pitt's death in 1806 a pension of £1200 a year was assigned her by the king. Fox proposed to provide for her much more munificently, but she proudly declined his offers, as unwilling to accept benefit at the hands of the political enemy of her dead uncle. The change from the excitements of a public career, as it might almost be called, to the life of an ordinary woman of her rank with means somewhat insufficient was naturally irksome to her, and in 1808 she was tried still further by the death at Corunna of her favourite brother Major Stanhope, and of Sir John Moore, for whom she is known to have cherished an affection. Conceiving a disgust for society, she retired for a time into Wales, and in 1810 left England never to return. In mere restlessness of spirit she wandered on the eastern shores of the Mediterranean, and finally in 1814 settled herself among the half-savage tribes of Mount Lebanon. Here she led the strangest life, adopting in everything the Eastern manners, and by the force and fearlessness of her character obtaining a wonderful ascendancy over the rude races around her. She was regarded by them with superstitious reverence as a sort of prophetess, and gradually came so to consider herself. With the garb of a Mohammedan chieftain, she adopted something of the faith of one, and her religion, which seems to have been sincere and profound, was compounded in about equal proportions out of the Koran and the Bible. Her recklessly profuse liberalities involved her in constant straits for money; and her health also giving way, her last years were passed in wretchedness of various kinds, under which, however, her untamable spirit supported her bravely to the end. She died on 23d June 1839, with no European near her, and was buried in her own garden. The main sources of information about her are the notes of Lamartine, Kinglake, and other travellers who visited her in her strange seclusion, and the *Memoirs and Travels* derived from her own lips, and afterwards (6 vols. Lond. 1845-46) published by Dr Meryon, the physician who went abroad with her, and from time to time lived with her in her retirement.

Stanhope, PHILIP HENRY, EARL, historian and biographer, was sixth in descent from the first Earl of Chesterfield, and fourth from James, first Earl Stanhope (1675-1721), an eminent military commander, who effected the reduction of Port Mahon in Minorca, and was the favourite minister of George I. His grandson, Charles, third Earl (1753-1816), was an advanced Liberal, distinguished for his scientific researches, and the inventor of a printing-press which bears his name. The subject of this notice, only son of the fourth earl, was born at Walmer, 31st January 1805. He took his B.A. at Oxford in 1827, and seven years later was created D.C.L., having entered the House of Commons in 1830. He was greatly instrumental in 1842 in

securing the passing of the Copyright Act (q.v.), was Under-secretary for Foreign Affairs during the brief Peel administration (1834-35), and Secretary to the Indian Board of Control under the same minister (1845-46). He was a moderate Conservative in politics, and was warmly attached to Sir Robert Peel, who named him one of his literary executors, and whose Memoirs he edited in conjunction with Mr Cardwell. His contributions to history are numerous and valuable. Macaulay, in a review of his *War of the Succession in Spain* (1832), credits him with some of the most valuable qualities of a historian—viz. perspicuousness, conciseness, 'great diligence in examining authorities, great judgment in weighing testimony, and great impartiality in estimating characters. His most considerable work is *A History of England from the Peace of Utrecht to the Peace of Versailles, 1713-33* (7 vols. 1836-54); and his other works include *Lives of Belisarius, Condé* (originally in French), and *Pitt; a History of Spain under Charles II.*; an edition of *Lord Chesterfield's Letters; Historical and Critical Essays*; and *Miscellanies*. He was elected President of the Society of Antiquaries (1846), and Lord Rector of the university of Aberdeen (1858). He was known by the courtesy title of Viscount Mahon till 1855, when he succeeded his father in the earldom. He was mainly instrumental in procuring the appointment of the Historical Manuscripts Commission and the foundation of the National Portrait Gallery. In 1872 he was elected one of the six foreign members of the Academy of Moral and Political Sciences at Paris, and he died at Bournemouth, 22d December 1875.

Stanislaus. See POLAND, pp. 271-2.

Stanislawow, or STANISLAU, a town in the Austrian crown-land of Galicia, stands on the Bistritza, 87 miles by rail S.E. of Lemberg, has important railway workshops, brick-works, &c., and is the seat of a Greek-Catholic archbishop. Pop. (1890) 22,391, about one-half Jews.

Stanley. See DERBY (EARL OF).

Stanley, ARTHUR PENRHYN, born at the rectory, Alderley, 13th December 1815, the second son and third child of the Rev. Edward Stanley (1779-1849, second son of Sir John Thomas Stanley of Alderley, Bart.), for thirty-two years rector of Alderley, Cheshire, and for twelve bishop of Norwich. The bishop's elder brother was raised to the peerage, under the title of Baron Stanley of Alderley, in 1839. Arthur Stanley was educated at Rugby under Dr Arnold, and at Oxford, where he entered Balliol in 1834, and had Tait (afterwards Archbishop of Canterbury) for tutor. He took the Ireland scholarship and the Newdigate prize poem, and in 1837 a first-class degree. In 1839 he was elected a Fellow of University College and entered holy orders. In 1840 he travelled in the East, and from 1841 to 1851 lived at Oxford and did duty as tutor in his college; in 1845 was appointed select preacher; in 1851 canon of Canterbury; in 1856 professor of Ecclesiastical History, and canon of Christ Church, and in 1863 Dean of Westminster, in succession to Trench, promoted to the archbishopric of Dublin. In 1874 he was elected Lord Rector of the university of St Andrews. A voluminous writer in the periodical press, he was author of the *Life of Arnold* (1844), *Sermons and Essays on the Apostolic Age* (1847), *Memoir of Bishop Stanley* (1851), *Commentary on the Epistles to the Corinthians* (1855), *Memorials of Canterbury* (1855), *Sinai and Palestine* (1856), *Historical Memorials of Cambridge* (1857), *Lectures on the Eastern Church* (1861), *Sermons preached during a Tour in the East* (1863), *Lectures on the Jewish Church* (1863-65), *Memorials of Westminster*

Abbey (1866), *Essays on Church and State* (1870), *Lectures on the Scottish Church* (1872), *Addresses and Sermons delivered at St Andrews* (1877), *Sermons and Addresses* (1878), *Memorials of Edward and Catherine Stanley* (1879), and *Christian Institutions* (1881). The outstanding events in Stanley's personal history, after his public life had begun, were his travels in Egypt and Palestine in 1852-53, which suggested his *Sinai and Palestine*, and those in Russia in 1857, during which he collected the materials for the vivid pictures of the ecclesiastical life and history of Russia which occupy the last four lectures of his *Eastern Church*; his accompanying the Prince of Wales on his Eastern tour in 1862; his marriage in 1863 to Lady Augusta Bruce (1822-76), of the Elgin family; a second visit to Russia in 1874, when he celebrated the English marriage of the Duke and Duchess of Edinburgh; and his visit to America in 1878.

Stanley had a keen sense of humour; his talk was bright and abundant, passing easily from grave to gay, wholly free from affectation, gossip, or ill-natured or ill-informed chatter of any sort. Few men, if any, of his generation had a wider and more diversified circle of friends and acquaintances. His large tolerance, charity, and sympathy drew round him, by an irresistible attraction, all but the extreme bigots of ecclesiastical parties. To these he was the object of special aversion. High Church Anglicans in particular could never forgive him for championing Colenso, for preaching in Scottish Presbyterian pulpits, and for administering the holy sacrament in Henry VII.'s chapel to the revisers of the authorised version—one of them being a Unitarian, and several Presbyterians. This action, however, was in perfect accordance with the principle on which he governed the Abbey, recognising it as a great Valhalla, above all sectarian jealousies and divisions, to be used in the interests of religious concord and liberty. Among his last words were these: 'I am humbly trustful that I have sustained before the mind of the nation the extraordinary value of the Abbey, as a religious, national, and liberal institution.' It was his pride to add to its treasures, to enrich and multiply its services, and to throw it freely open to the people, multitudes of whom he, week after week, would conduct through it, explaining to them its history and contents. In his character as a churchman Stanley was pre-eminently representative of the highest culture and the broadest theology of the Church of England. He had inherited from his father the bishop, and had imbibed from Arnold his master, just and liberal ideas as to what a national church should be—comprehensive, intellectually free, charitable, and not aggressive in its relations to nonconformity. The Church of England, he maintained, 'by the very condition of its being, was not high or low, but broad.' Of this breadth he held the connection with the state to be the safeguard. The supremacy of the crown was simply the supremacy of the law, the removal of which would expose the just freedom of theological thought and of clerical action to the dominion of individuals or courts—none the less likely to be oppressive because they would claim to wield, by divine right, a purely spiritual power. In the current sense of the terms, Stanley was both Erastian and Latitudinarian; but only because of his love of liberty, which he felt endangered by the pretensions of sacerdotalism on the one hand and of orthodox dogmatism on the other. Christianity to him was sacred because of its moral and spiritual elements, and the divinely perfect life which embodied these; but for the systematic theology which had grown up around the evangelic records and the apostolic teaching he had little reverence; and he had none at all for

the pretensions and 'mysteries' of the priesthood. The controversies about attitudes, lights, vestments, and the like, which agitated the Anglican Church, could not be lifted, in his opinion, out of the region of 'the infinitely little,' even by the doctrinal relations which exalted them in the eyes of the ritualistic party. The relish with which he traced details of ecclesiastical dress and usage back to their—often homely and simple—historical origins was as exasperating to the ritualist as the energy with which he threw himself into the defence of the theological position of Maurice, of the writers of *Essays and Reviews*, and of Bishop Colenso was to the ordinary evangelical. While the evangelicals deplored his lack of the 'root of the matter,' the ritualists sneered at him as 'the honorary member of all religions,' and 'the chief Nonconformist in the Church of England.' But Stanley held on his way, urged not only by his love of freedom, but by an innate chivalry of spirit which responded to the appeal of every vilified name, or struggling cause, or forlorn hope, but which was repelled by the self-assertion of the prosperous, the arrogance of the powerful, and the dull self-satisfaction of the conservative traditionalist. Thus, while he refused to let the Pan-Anglican Synod shelter its congress under the great name of the Abbey, he asked Colenso to preach there while under the ban of Convocation; and when Père Hyacinthe broke with the Roman hierarchy, and encountered the ecclesiastical and social ostracism which visited his marriage, he found refuge and countenance for himself and his wife beneath Stanley's roof.

Naturally Stanley's literary work does not entitle him to rank among doctors of dogmatic theology. His one purely theological book was that on the Epistles to the Corinthians; but in it he led the way to that application of fresh and open criticism and of vivid historical illustration to the sacred text in which he has been followed by all the best English exegetes of the present day. He was most at home in historical delineation and exposition. Probably in all his works exact dogmatists might mark here and there a vagueness of definition, and keen critics detect a hasty induction or a historical inaccuracy; but no one could fail to admire the faculty of living reproduction of the past, of picturesquely apposite illustration, of adaptation of every collateral aid and association in producing the one perfect impression he wished to stamp on the memory; or to sympathise with the lofty ideal of human life—the firm faith in the divine righteousness, the scorn of baseness, the love of truth, that brightened every page.

As a preacher from the pulpit of the Abbey Stanley wielded a wide influence. His congregation there was the great multitude that thronged the church whenever it was known he was to preach; and his sermons always conveyed a message of high religious purpose, of peace and reconciliation, and at any public crisis, or after any national loss, enforced, with perfect grace and wise moderation, the proper lesson, or paid the fitting tribute, or pointed the essential moral. Availing himself of the independent position which was his as successor to the Abbots of Westminster, and which laid him under no episcopal jurisdiction, he used to invite friends from the ranks of English nonconformity and of the Scottish Church, and even such an illustrious layman as Max-Müller, to address the congregation that filled the nave at evening service; thus, and by every means in his power, seeking to show his catholicity and his desire to break down walls of separation.

Stanley's position in society was unique. His ancient lineage, his independent and exalted ecclesiastical office, his personal popularity, his alliance

with a lady of marked mental ability and social charm, who like himself was a *persona grata* at the Queen's court, all combined to invest the Deanery with a prestige and influence, as a centre of society, possessed, we may safely say, by no great contemporary house either of the English hierarchy or aristocracy. All that was really best in London society was to be met in Lady Augusta's *salon*; whatever was freshest and most genuine in literature, science, and art, most distinguished in character, most interesting in any department of life gravitated thither, and was received with warm and gracious welcome. With his wife's death a blight seemed to fall on the Deanery and its master; and during the few years that he survived her his life was obviously wounded too deeply to recover its elasticity, and too grievously stricken by the loss of 'the inseparable partner in every joy and struggle of twelve eventful years' to be able to withstand the attack of sharp disease such as seized him in the summer of 1881. He sank rapidly. Among his farewell words were: 'I always wished to die at Westminster;' and there he died, in the Deanery, before midnight on Monday, 18th July. He was buried by the Queen's commands beside his wife in Henry VII.'s chapel. He had left directions, which were duly obeyed, that among his pall-bearers there should be a minister of the Church of Scotland and an English Nonconformist, and that the Abbey on his funeral day should be freely open to the people. A recumbent marble effigy surmounts his tomb.

See the *Life and Correspondence*, by R. E. Prothero and Dean Bradley (2 vols. 1893); and the *Recollections of A. P. Stanley*, by Dean Bradley (1883).

Stanley, HENRY MORTON, the African explorer, although a citizen of the United States, was born near Denbigh in Wales about 1840. His parents were in humble circumstances, and at an early age John Rowlands, as his name then was, had to shift for himself. When still a lad of fourteen or fifteen he left England, and the story goes that he worked his way as a cabin-boy to New Orleans, where he was fortunate enough to obtain employment in the office of a merchant named Stanley. He assumed the name of his employer, who took a keen interest in the young Welshman; but on the death of the merchant intestate he was again thrown on his own resources. He served in the Confederate army, and appears to have become a contributor to several American journals. In 1867 he was acting as correspondent for the *New York Tribune* and the *Missouri Democrat* on a military expedition against the Indians, and towards the close of that year began his connection with the *New York Herald*. It was as its special correspondent that Stanley first entered Africa. He accompanied Lord Napier's Abyssinian expedition, and so ably did he make his dispositions that the first news of the fall of Magdala was conveyed to the British public—and also to the British government—by the *New York Herald*. Stanley next went to Spain for his paper, and while in Madrid received the famous telegram from Mr Gordon Bennett summoning him to Paris; he went at once, and received the laconic instructions to 'find Livingstone.' This was in October 1869, but Stanley did not at once proceed on his new mission; he visited Egypt for the opening of the Suez Canal, and travelled through Palestine, Turkey, southern Russia, and Persia, arriving in India in August 1870. In the following January he reached Zanzibar, and towards the end of March he set out on his first expedition into the heart of the dark continent. Two white men who accompanied him soon turned back; there was the usual trouble with the porters; but in those early days Stanley displayed the qualities of courage,

perseverance, and command over the native African which have won for him such a high position in the long roll of African explorers. The road to Tanganyika was not then what it is now; but all difficulties were overcome, and on November 10th Stanley had the satisfaction of greeting Livingstone. For four months they remained together, and there can be little doubt that the influence and example of Livingstone during these four months had a lasting effect on Stanley's character and career. Stanley met Livingstone a special correspondent; he parted from Livingstone with the fever of African exploration burning in his veins. The two men had together explored the north end of Lake Tanganyika, and conclusively settled that the lake had no connection with the Nile basin. On March 13, 1872, Stanley left Livingstone and set out on his return to the coast, having left large quantities of goods with the veteran, and given promises of further assistance. In less than two months he arrived at Zanzibar, and in August in England, where he was awarded the medal of the Royal Geographical Society, and fêted as the lion of the hour. His book, *How I Found Livingstone*, had an enormous sale. During the Ashanti campaign he followed the fortunes of Sir Garnet Wolesey's troops, for the *New York Herald*, and he returned to London only just in time to assist at the funeral of Livingstone in Westminster Abbey. The news of Livingstone's death kindled in Stanley a great resolution to complete the work in which his master had lost his life.

An expedition fitted out at the joint charge of the *New York Herald* and the *Daily Telegraph* was projected, with Stanley in supreme command. In August 1874 he left England to attempt the solution of some of the great problems of Central African geography. In November, with some 350 men of all descriptions, he quitted Bagamoyo, following the ordinary route to Ugogo, when, turning suddenly northwards, he made for the southern shore of the Victoria Nyanza. From Kagehi, on Speke Gulf, he circumnavigated the lake, and approximately fixed its general outline. In Uganda he formed a close friendship with King Mtesa, and on his return home his reports of the readiness of the king to receive instruction in the Christian religion led to a great outburst of missionary enthusiasm, and the establishment of mission stations in Uganda. At Bambiheh, an island off the south-west shore of the lake, he came into serious conflict with the natives, and the severe punishment he inflicted was subsequently made the subject of much hostile criticism in England. Passing through Karagwé, he reached Tanganyika, and set himself to determine its exact configuration. This accomplished, he made his way to Nyangwé on the Lualaba, where he first met Tippu Tib, the Arab chief; and from Tippu he learned that Cameron had not attempted the solution of the problem suggested by this great mass of water flowing northwards. It is of course impossible to give even in the barest outline the story of Stanley's ten months' journey from Nyangwé to the sea, by which he traced the course of the Congo and filled up an enormous blank in the map of Africa. When he arrived at Boma all his white companions were dead, hardly a third of his native followers had survived, and Stanley's black hair had turned white. It would be difficult to exaggerate the effect produced by this great journey. Politically it led directly to the founding of what is now the Congo Free State, and indirectly to that scramble for Africa among the European powers which has now left but an insignificant portion of the continent unpartitioned. Stanley returned to London in January

1878, published *Through the Dark Continent* and in 1879 again went out to Africa to found, under the auspices of the king of the Belgians the Congo Free State. Until 1884 this work engaged all his energies. He then returned to Europe, and in 1885 published *The Congo and the Founding of its Free State*. He took part in the Congo Congress at Berlin in 1884-85, and lectured widely, both in Britain and in America, on his African work.

Towards the end of 1886 Stanley was summoned from America to take command of the expedition for the relief of Emin Pasha (see SCHNITZER). On 22d February 1887 he arrived at Zanzibar; on the 25th he, his officers, and the Zanzibari porters, Somalis, and Soudanese soldiers sailed for the mouth of the Congo, where they landed on 18th March. On 15th June the expedition had reached the village of Yambuya, 1300 miles from the sea, on the left bank of the Aruwimi, 96 miles above its confluence with the Congo. Here Stanley divided his forces. He left at Yambuya camp a large number of loads, which were to be brought on as soon as porters were provided by Tippu Tib. The entire force which left Zanzibar numbered, all told, 706 men. Between Zanzibar and Yambuya it was reduced to 649. Of this number 389, including Stanley and five Europeans, made up the advance force, the garrison at Yambuya numbered 129, and a contingent 131 strong was shortly to join the Yambuya camp from Bolobo. Major Bartelot was left in command of the rear column, and on 28th June Stanley set out on his forced march through the forest. It is impossible to follow in detail the story of Stanley's indomitable struggle with almost insurmountable difficulties. Disaster overtook the rear column; its leader, Major Bartelot, was assassinated; Jameson, the next in command, died of fever, and Bonny alone remained at the camp. For many months no news of Stanley reached Europe; then came rumours of disaster; and finally the news that Emin and Stanley had joined hands on the shores of the Albert Nyanza. Into the history of their relations it is needless to enter, as there exists a small library of Emin literature dealing with the subject in all its aspects. The return journey was made by an overland route to the east coast, and Bagamoyo was reached on 4th December 1889. Apart from the main object of Stanley's journey, this expedition established the existence of a vast tropical forest to the west of the lake country, and occupying the northern portion of the Congo basin, as also of the vast snow-capped height of Ruwenzori (18,000 to 19,000 feet). In 1890 Stanley, after recruiting his health in Egypt and the south of France, returned to London, and met with a royal reception. He was everywhere feasted and feted; the Royal Geographical Society bestowed on him a special gold medal; and Oxford, Cambridge, Edinburgh, Durham, and Halle conferred on him honorary degrees. Having married Miss Dorothy Tennant (1890), he settled in England, stood unsuccessfully as a Unionist candidate for Lambeth in 1892, but was elected M.P. for that constituency in 1895.

His works include, besides those named above, *Cosmiasie and Magdala* (1874); *In Darkest Africa: or the Quest, Rescue, and Retreat of Emin* (1890); a novel, *My Kalulu* (1873); *My Dark Companions and their Strange Stories* (1893); and *My Early Travels in America and Asia* (1895). See also the article SCHNITZER, and books cited there, and CONGO.

Stanley, THOMAS, translator of *Æschylus* and historian of philosophy, was the son of Sir Thomas Stanley, and was born at his house of Comberlow in Hertfordshire in 1625. He had Fairfax, translator of Tasso, for private tutor, and studied at Cambridge, passing M.A. in 1641. He also had

the Oxford master's degree, though he does not seem to have studied there. He became a member of the Middle Temple, and practised law throughout life, though his best energies were given to literature. He published translations from the Greek, Latin, French, Spanish, and Italian poets; but his great works were the *History of Philosophy* (4 vols. 1655-62) and an edition of *Æschylus*, with Latin translation and commentary (1663-64). The former deals only with Greek philosophy, and is based on Diogenes Laertius; but it was long a standard work, having been translated into Latin by Leclerc and others. The *Æschylus* was generally considered to surpass its predecessors (though Stanley was blamed for 'plagiarism' from Casanbon, Scaliger, and others); the best edition was that edited by Butler in 1809-16. Stanley died in London, 12th April 1678. See the Life prefixed to Brydges' edition of his *Poems* (1814-15).

Stanley, VENETIA. See DIGBY (KENELM).

Stanley Pool, a lake-like expansion, in 16° E. long, and 4° S. lat., of the river Congo (q.v.), discovered by H. M. Stanley in 1877. It measures 25 miles in length by 16 in width, and lies 1142 feet above sea-level.

Stannaries (Lat. *stannum*, 'tin'), the mines from which tin is dug. The term is most generally used with reference to the peculiar laws and usages of the tin-mines in the counties of Cornwall and Devon. By an early usage peculiar to these counties, the prerogative of the crown, elsewhere reaching only to gold and silver mines, is extended to mines of tin, which are the property of the sovereign, whoever be the owner of the soil. A charter of King John to his tanners in Cornwall and Devonshire, of date 1201, authorised them to dig tin, and turf to melt the tin, anywhere in the moors, and in the fees of bishops, abbots, and earls, as they had been used and accustomed—a privilege afterwards confirmed by successive monarchs. When Edward III. created his son, the Black Prince, Duke of Cornwall, he at the same time conferred on him the Stannaries of Devon and Cornwall, which were incorporated in perpetuity with the duchy. Their administration is committed to an officer called the Lord Warden of the Stannaries, who has two substitutes or vice-wardens, one for Cornwall and one for Devon. In former times representative assemblies of the tanners (called parliaments) were summoned by the warden under a writ from the Duke of Cornwall, for the regulation of the stannaries and redress of grievances: the last of them was held in 1752. The Stannary Courts are courts of record held by the warden and vice-warden, of the same limited and exclusive character as the Courts-palatine, in which the tanners have the privilege of suing and being sued. They were remodelled and regulated by a series of acts of parliament. Appeals from these courts are now taken to the Court of Appeal, and there is a final appeal to the House of Lords. In Cornwall the right to dig tin in unenclosed or 'wastrel' lands within specified bounds may be acquired by one who is not the owner of the lands, on going through certain formalities, the party acquiring this right being bound to pay one-fiftieth to the owner of the lands. An ancient privilege, by which the Duke of Cornwall had the right of pre-emption of tin throughout that county, has long fallen into abeyance.

Stannic Acid. See TIN.

Stannotypes. See PHOTOGRAPHY.

Stanovoi Mountains. See SIBERIA, p. 426.

Stanton Drew, a small village of Somersetshire, 7 miles S. of Bristol, with great megalithic remains, especially stone circles.

Staple, the modern form of the Anglo-Saxon word *stapel*, meaning a heap, or regularly piled up accumulation, of goods; hence a place where goods are stored up for sale. In the middle ages, when the term was in common use, a staple meant both the trading-town for particular commodities and the commodities that were wont to be exposed for sale there. The kings of England from the beginning of the 14th century issued various regulations affecting the staple towns for the sale of England's principal commodity in those ages—wool. In 1313 Edward II. enjoined that all English merchants trading abroad, in Flanders, Brabant, and the adjacent countries, should carry all their wool to one staple town in Flanders; from 1343 Bruges was the town that enjoyed this privilege. But the men of Bruges greatly hampered the trade, and put vexatious hindrances in the way of the English merchants trading with the towns that lay farther inland; so that in 1353 Edward III. transferred the staple to England, and shared its privileges amongst half a score of coast towns from Newcastle to Bristol. At the same time all questions in dispute affecting mercantile transactions at these towns were put under the jurisdiction of an officer (one in each town) called the mayor of the staple, who decided all such differences by 'merchant law', with the assistance of foreign merchants as assessors. The change to England, however, which it was hoped would relieve the English merchant from the vexatious interference of foreign governments and advantage the island country by attracting foreign merchants, proved anything but satisfactory, and from about the year 1362 the staple for English wool was almost constantly fixed at Calais, and remained there down to the year 1558. The Scottish merchants had their staple at Campvere (q.v.) in Holland. But as commerce grew with the lapse of time, it gradually broke down the barriers imposed by the system of staples. This concentration of trade in particular commodities or of particular countries at certain cities and towns was owing to both economic and political reasons. It was a sort of established policy of the Plantagenet kings to regulate trade in the interests of the royal power. Important privileges were accorded to foreign merchants on condition of their agreeing to frequent certain towns for purposes of traffic. This, too, enabled the royal officers of the customs the more readily and easily to collect the revenues of the crown accruing from those sources. And this line of state policy was so far congruent with the requirements of international commerce that it was the means of bringing buyers and sellers together at the same time and in the same place, and that it enabled the merchants trading from or to one town or country, or association of trading-towns, to combine together for their mutual advantage and protection.

Star. See STARS, ORDERS OF KNIGHTHOOD.

Star Apple (*Chrysophyllum*), a genus of trees and shrubs of the natural order Sapotaceæ. The species are natives of tropical and subtropical countries. The Star Apple of the West Indies (*C. castilloi*) is a shrub about 8 or 10 feet high. The fruit is large, rose-coloured, mixed with green and yellow, and has a soft sweet pulp of an agreeable flavour. Other species produce edible fruit.

Staraya-Russa, a town of Russia, 62 miles S. of Novgorod by rail round Lake Ilmen, is remarkable for its salt springs, which attract large numbers of visitors in summer. Pop. 13,537.

Starboard. See STEERING.

Starbuck. See MANIHIKI ISLANDS.

Starch, $C_6H_{10}O_5$. It is one of the essential functions of the leaves of plants to decompose

carbonic acid, by the help of sunlight which shines through the chlorophyll, with evolution of oxygen and the formation of starch. The starch becomes converted by a diastatic ferment into sugar, which passes from the leaves to various parts of the plants, and being reconverted into starch, is stored. See CHLOROPHYLL, LEAF, and SEED. It is in this way that fruits and seeds, stems—e.g. that of the sago palm—tubers like the potato, tap-roots, bulbs, &c. become stored with starch. The granules of starch are usually of a rounded form, consisting of a nucleus surrounded by a number of envelopes or layers. Each species of plant has its own peculiar

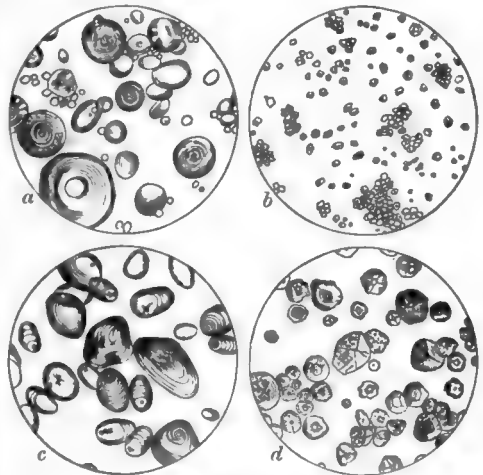

Starch Granules :

a, wheat; b, rice; c, potato; d, maize; all magnified 250 diameters. (From Dr Bell's *Chemistry of Foods*.)

shape of granule which can be recognised under the microscope, but in the same plant these granules differ in size. The smallest size of a granule of oat-starch is '0001, while the largest sized granule of *Tous-les-mois* starch is about '0015 of an inch. In a small book on the *Chemistry of Foods*, by Dr Bell of the Somerset House Laboratory, the reader will find a considerable number of illustrations of starches as seen under the microscope.

Starch has the same elementary composition as sugar, gum, and woody fibre (cellulose). These all belong to a class of substances called carbohydrates, because they could be represented as compounds of carbon and water, as shown by the formula given above, which corresponds to six atoms of carbon and five molecules of water, H_2O . Starch contains no nitrogen, and is thus distinguished from characteristic animal compounds. The peculiar structure of starch granules and the way in which they occur in the vegetable cell permit of their being readily separated from other matters occurring along with them in plants. As usually prepared, starch is either a white glistening powder or it is obtained in irregular prisms which arise from the cracking up of a cake of the dried material. When pressed between the fingers a slight but peculiar sound is produced. Its specific gravity varies from 1.55 to 1.60. Starch is soluble only to a very slight extent in cold water, but when heated in water to above 150° F. the granules burst, and a clear ropy solution is formed which, on cooling, becomes a translucent jelly called starch-paste. This paste gives a deep blue colour with iodine and an orange yellow with bromine, the former being a highly characteristic and delicate test for starch. If a salt of iodine, such as iodide of potassium, is used, the iodine must be liberated either

by a drop of strong nitric acid or preferably by a little chlorine water. By the gentle action of nitric acid on starch an explosive compound called *xylodine* is obtained. At a temperature of about 320° F. (160° C.) starch is converted into *dextrine* or *British gum*, and the same change is produced on starch by the action of dilute mineral acids. Dextrine is usually made on an industrial scale from potato-starch. It is this Dextrine (q.v.) which is the adhesive matter on postage-stamps, but it is otherwise largely used in the arts. By the further action of acids on starch *dextrose* or grape-sugar, and also the crystallisable sugar, *maltose*, are obtained. Maltose sugar is likewise produced during the operation of malting by the action of diastase on the starch of grain.

Starch is heard of in England as early as 1511, but was not much used till 1564, when, according to Planché, 'Mistress Binghein Vandh Plasse, a Fleming, came to London, and publicly taught the art of starching. . . . Stubbes falls foul of this "liquid matter which they call starch, wherein the devil hath learned them to wash and dive their ruffs, which being dry will then stand stiff and inflexible about their necks."'

Manufacture.—Starch is manufactured on a large scale in Europe from maize, wheat, rice, potatoes, and from sago-flour. *Maize-starch* is most largely made. The grain contains 65 per cent. of starch and about 14 of gluten and other nitrogenous matters. The Indian corn is first steeped for forty-eight hours in water at a temperature not exceeding 120° F. It is then ground with water by millstones into a milky state, after which it is sieved to keep back the husks. From the sieve the starchy liquid passes into 'runs' or channels made of wood, from 2½ to 4 feet broad and 9 inches deep, in which the starch deposits. It is then removed from the runs and put along with water into vats or tuns (10 feet in diameter and 4 feet 6 inches deep) provided with stirrers, some very weak soda-lye being added. After it is sufficiently stirred the liquid is allowed to settle, when the starch falls to the bottom. At this stage the vats contain a layer of starch, over this a layer of gluten, and above that again a stratum of yellowish water thick with gluten. The starch is again washed with water in the final settling vats, from which, after drawing off the water, it is removed and spread on clean cotton sheeting to be dried in stoves at a temperature between 120° and 130° F. A little chloride of lime is used to bleach maize and other kinds of starch.

Potato-starch.—In manufacturing starch from potatoes, the latter are first washed in machines of various kinds, but of which one of the simplest is a revolving cage-like cylinder with wooden bars. Then follows the grating of the washed potatoes by forcing them against the saw-like teeth of rasps, which, as sufficient water is fed to the machine, reduces them to a paste. In order to separate fibrous and albuminous matters and other impurities, the starch-paste with an addition of water is passed through fine sieves, and at the same time agitated by various arrangements. From the sieves it is received into settling tanks in which the deposit of starch is again washed in clean water. It then descends in a milky stream over an inclined plane, on which the starch is deposited, and afterwards once more washed. A little alum or sulphuric acid is used to assist in the removal of albuminous matters. The starch is dried either on porous bricks or on slabs of gypsum, and for some purposes it undergoes another drying in a hot chamber.

Wheat-starch.—Owing to the large amount of albuminous and other nitrogenous bodies (gluten or its equivalents) which wheat contains, amount-

ing sometimes to more than 15 per cent., the methods of making starch from this grain are a little more complicated than the processes employed to obtain it from other cereals or potatoes. Wheat-starch is made by the old plan of removing the gluten by fermentation, and also by Martin's method of kneading the flour into a stiff dough and washing out the starch with water on a sieve. Good English wheat contains about 69 per cent. of starch, but in this grain the proportion of both starch and gluten varies much.

Rice-starch is prepared by removing the gluten, which amounts to from 7 to 8 per cent. of the seed, by the action of soda in weak solution. The proportion of starch in rice is higher than it is in other cereals, varying from a little under to a little over 80 per cent. The *corn-flours* of commerce are prepared either from the purified starch of maize or from that of rice. These flours, being nearly pure starches, with the flesh and bone forming constituents extracted, are not flours of their respective seeds in the sense that wheat-flour is.

Sago-starch is obtained from the pith of the stems of sago palms (see PALM and SAGO). Most of the sago imported into England is in the form of sago-flour, which is used in the manufacture of household starch and glucose sugar. Besides its use in the laundry, starch is extensively employed in dressing textile fabrics and as a thickener for the colours used in printing calico; also for mounting photographic prints and dusting founders' moulds.

The principal starches prepared for food besides the 'corn-flours' are *Arrowroot* (q.v.), *Tapioca* (q.v.); and *Tous-les-mois*, from the rhizomes of a species of *Canna* cultivated in St Kitts, West Indies. *Curcuma Starch* is made to some extent in Southern India from the tuberous root of *Curcuma angustifolia*, and is sometimes called by Europeans East India arrowroot. In France starch is manufactured from horse-chestnuts. Paisley is the principal seat of the starch-manufacture in Great Britain, where it is chiefly made from maize. Rice-starch is made on a large scale at Norwich, and wheat-starch at Belfast.

In the United States, where maize-starch was first produced in 1842, the principal manufactories are at Oswego, New York, and at Glen Cove, on Long Island; indeed, these are the largest starch-works in the world. There are over 100 other factories in the Union, some producing potato-starch or wheat-starch, but the most maize-starch; and some 10,000,000 lb. of starch is now exported annually. Maize-starch is manufactured from a large porous-grained Indian corn.

Star-chamber, a tribunal which met in the old Council-chamber of the palace of Westminster, and is said to have got its name from the roof of that apartment being decorated with gilt stars, or because in it 'starres' or Jewish bonds had been kept. It is supposed to have originated in early times out of the exercise of jurisdiction by the king's council, whose powers in this respect had greatly declined when in 1487 Henry VII., anxious to repress the indolence and illegal exactions of powerful landowners, revived and remodelled them, or, according to some investigators, instituted what was practically an entirely new tribunal. The statute conferred on the Chancellor, the Treasurer, and the Keeper of the Privy Seal, with the assistance of a bishop and a temporal Lord of the Council, and Chief-justices, or two other justices in their absence, a jurisdiction to punish, without a jury, the misdemeanours of sheriffs and juries, as well as riots and unlawful assemblies. Henry VIII. added to the other members of the court the President of the Council, and ultimately all the privy-councillors

were members of it. The resulting tribunal was, during the Tudor age, of undoubted utility as a means of bringing to justice great and powerful offenders who would otherwise have had it in their power to set the law at defiance. It was independent of a jury, and at that time juries were too easily terrorised by the nobles. The civil jurisdiction of the Star-chamber comprised controversies between English and foreign merchants, testamentary causes, disputes between the heads and commonalty of corporations, lay and ecclesiastical, and claims to deadlands. As a criminal court it could inflict any punishment short of death, and had cognisance of forgery, perjury, riots, maintenance, fraud, libels, conspiracy, misconduct of judges and others connected with the administration of the law, and all offences against the state, in so far as they could be brought under the denomination of contempt of the king's authority. Even treason, murder, and felony could be brought under the jurisdiction of the Star-chamber, where the king chose to remit the capital sentence. The form of proceeding was by written information and interrogatories, except when the accused person confessed, in which case the information and proceedings were oral; and out of this exception grew one of the most flagrant abuses of this tribunal in the later period of its history. Regardless of the existing rule that the confession must be free and unconstrained, pressure of every kind, including torture, was used to procure acknowledgments of guilt; admissions of the most immaterial facts were construed into confessions; and fine, imprisonment, and mutilation inflicted on a mere oral proceeding, without hearing the accused, by a court consisting of the immediate representatives of prerogative. The proceedings of the Star-chamber had always been viewed with distrust by the commons; but during the reign of Charles I. its excesses reached a pitch that made it absolutely odious to the country at large; the punishments inflicted on Alexander Leighton, Prynne, Burton, and Bastwick brought matters to a height, and in 1641 a bill was carried in both Houses (16 Car. I. chap. 10) which decreed the abolition of the Star-chamber and the equally unpopular High Commission Court (q. v.). See CHARLES I., LAUD.

Starfishes (Asteroidea), a class of Echinoderms, nearly allied to the Brittle-stars (Ophiuroidea), an account of which is included in this article, and to the Sea-urchins (Echinoidea).

The Common Five-rayed Starfish (*Asterias* or *Asteracanthion rubens*) may be taken as type. It is sometimes seen in shore-pools about the low-water level, but its haunts are on the floor of the sea at depths of a few fathoms. It moves sluggishly by means of suctional tube-feet on the under surface of each arm. It often feeds on young oysters and other bivalves, but it may live on much smaller booty.

Haeckel compared such a starfish to a colony of five worms, and the comparison is useful. Each arm is anatomically complete in itself; there is a ventral nerve-cord ending in a terminal eye, and united with the nerves of the other four arms in a pentagon around the mouth; there is a blood-vessel above each radial nerve, and a vascular ring above the nerve-pentagon; there is a radial water-vessel in each arm, connected internally with little reservoirs or ampullae, externally with the suctional tube-feet, and centrally with a circum-oral watering, supplied by a vertical stone-canal which opens on the dorsal surface in a 'madreporic tubercle' between two of the arms; there are two digestive outgrowths or caeca of the gut in each arm; and there are also reproductive organs. Moreover, each arm has a certain independence of life, for a separated arm can grow the other four.

This theory gives us a vivid anatomical conception of the starfish, but the suggestion of the origin of a starfish from a colony of five worms is

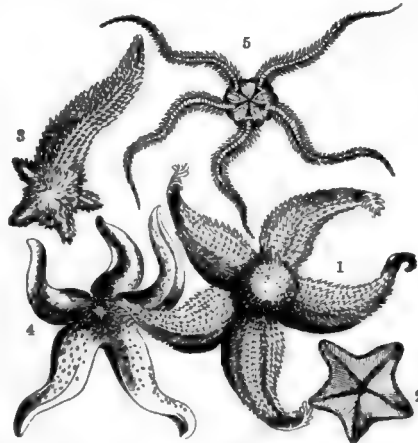

Fig. 1.—Starfishes and Brittle-stars :

1, Common Starfish (*Asterias rubens*); 2, Gibbous Starlet (*Asterina gibbosa*); 3, Common Starfish, reproducing rays; 4, Eyed Cribella (*Cribella oculata*); 5, Lesser Sand-star (*Ophiura albida*). (From Forbes's *British Starfishes*.)

not justified by the embryological facts. The interpretation which regards a five-armed starfish as a decentralisation of a flattened pentagonal sea-urchin, is more plausible than that which regards the Echinoid as a concentration of a bloated Asteroid.

Like most Echinoderms, the starfish is very calcareous. Forming the ventral groove of each arm there are important rafter-like plates called ambulacral ossicles; from the more external mesoderm are

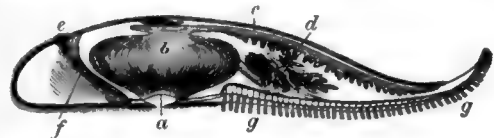

Fig. 2.—Longitudinal Section of an Arm :

Section through arm and disc of *Solaster*, showing (a) mouth, (b) stomach, (c) digestive caeca, (d) reproductive organs, (e) madreporic plate, (f) stone-canal, and (g) tube-feet.

developed smaller ossicles, superficial spines, and snapping scissor-like pedicellariæ. The starfish is not very muscular, but the arms can be bent in various ways, part of the stomach can be protruded, and there are contractile elements in connection with the water-vascular system. Besides the five radial nerves and the circum-oral pentagon, there is a diffuse nervous network beneath the ciliated ectoderm covering the body. Thus the skin is diffusely sensitive, and the little red 'eye' at the tip of each arm is certainly sensitive to light. The mouth is in the centre of the ventral surface; from the median stomach a pair of digestive caeca grow out into each arm; from the short tubular intestine between the stomach and the central dorsal anus, two little outgrowths arise, comparable, it is said, to the respiratory trees of Holothurians. There is a distinct, though not spacious, body-cavity, lined by ciliated epithelium, and containing a fluid with some amoeboid cells, the brownish pigment of which perhaps aids in respiration.

When we watch a starfish crawling up the side of a rock we see that scores of soft tube-feet are protruded from the ventral groove of each arm,

that these become long and tense, and that their sucker-like terminal discs are pressed against the hard surface. There they are fixed, and towards the attachment the starfish gently lifts itself. The protrusion is effected by the internal injection of fluid into the tube-feet; the fixing is due to the fact that the contained fluid, flowing back again from the tube-feet to the internal reservoirs, produces a vacuum between the ends of the tube-feet and the surface of the rock.

On the dorsal surface, between the bases of two of the arms, there is a complex calcareous sieve, somewhat suggestive of the rose of a watering-pan. Its pores converge into a 'stone-canal,' which, like a complex calcareous filter, extends vertically through the body, and leads into a ring around the mouth. This circum-oral ring gives off nine transparent vesicles and five radial tubes, one for each arm. Each radial vessel lies in the ventral groove of an arm, roofed by the rafter-like ossicles, and gives off internally reservoir-like bladders or ampullae, and externally the tube-feet. The fluid in the system seems to pass from the radial vessels into the tube-feet, and from the tube-feet back into the ampullae. It is evident that the water-vascular system is modified for locomotion, but it is likely that it also helps in respiration and perhaps also in excretion. At the end of each arm there is a long unpaired tube-foot which acts like a tactile tentacle. The blood-vascular system is well developed, and in its general course corresponds to the water-vascular system. Respiration is in great part discharged by numerous 'skin-gills,' contractile hollow outgrowths from the skin of the dorsal and lateral surfaces. Of excretion in the starfish we know almost nothing. The sexes are separate but quite like one another; the reproductive organs—branched like elongated bunches of grapes—lie in pairs in each arm; the genital ducts open dorsally between the bases of the arms.

The ova are fertilised in the water. It is said that they occasionally begin to develop without fertilisation. The segmentation is complete, a blastosphere is formed and a typical gastrula. The free-swimming larva, as in other Echinoderms, is remarkably specialised, with two ciliated bands and peculiar arm-like outgrowths. It is known as a Bipinnaria or as a Brachiolaria. The adult is a new formation within the larva, retaining the water-vascular system and mid-gut, but absorbing or rejecting

the provisional larval structures. There is also in this indirect development a remarkable change from bilateral to radial symmetry. Parental care occasionally occurs among Asteroids; thus a large *Asterias* has been seen sheltering its young within its arms, while in *Pteraster* and some others there is a dorsal brood-pouch. Many Asteroids break very readily, throwing off their arms when seized. The lost parts are slowly regenerated, and strange shapes, especially the 'comet-form,' often result in the course of regrowth. It is even possible that this 'autotomy' of members may sometimes be a means of multiplication.

The commonest European starfishes are species of *Asterias* or *Asteraanthion*, *Astropecten*, *Cribrella*, *Solaster*, *Goniaster*. In *Astropecten* and several related forms the food-canal ends blindly; in *Brisinga* the arms are very long and arise abruptly from a small central disc, as in Ophiuroids;

in *Luidia* the pedicellariæ are three-bladed instead of two-bladed; and there are many minor differences like the above. There are also considerable differences in external form, witness the many-rayed *Solaster*, the pincushion-like *Goniaster*, the flat pentagonal *Palimpsestus*. The largest forms are such as *Asterias gigantea*, from the Pacific coast of North America, which measures two feet in diameter, and

Pycnopodia helianthoides, which measures about a yard in diameter, and has over twenty arms. The majority live in comparatively shallow water, but the Ophiuroid-like *Brisinga*, the widely distributed *Hymenaster*, the blue *Porcellanaster ceruleus*, and many others are deep-sea forms. The earliest occurrence of Asteroids is in Silurian strata.

The *Brittle-stars* (Ophiuroidea) differ from Asteroids in the more centralised body, more sharply defined arms, and more active habit. Compared more fully with starfishes, the brittle-stars are more muscular and less limy; the arms do not contain digestive caeca from the gut nor reproductive organs, and are supported by an axis of limy 'vertebral ossicles'; the tube-feet are smaller, apparently tactile and respiratory, and locomotion is effected by the muscular wriggling of the arms; the groove so well seen on the ventral surface of the starfish arm is here closed in by limy plates; the alimentary canal ends blindly; the entrance to the water-vascular system (madreporic plate) is ventral; the larval form is known as a Pluteus. The popular name 'brittle-star' refers to the extreme ease with which the arms break; another common name, 'sand-stars,' refers less happily to their occasional occurrence on the shore; the technical title Ophiuroid describes the snake-like coils of their arms.

The brittle-stars creep about by wriggling their muscular arms. Some are found creeping on the



Fig. 4.—Process of budding from one of the arms of *Linckia multi-fora*. (After P. and F. Sarasin.)

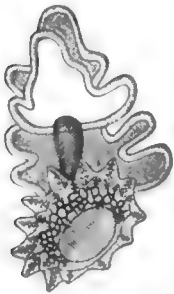

Fig. 3.—Bipinnaria with young Starfish developing within it.



Fig. 5.—The Shetland Argus (*Astrophyton scutum*). (From Forbes.)

shores at low-tide, but the majority keep to the floor of more or less deep water. On blocks of coral and the like they swarm in enormous numbers, twisting themselves most fantastically about the crevices. They are carnivorous animals, feeding on small molluscs, crustaceans, worms, and much simpler organisms like Foraminifera.

With few exceptions (e.g. *Amphiura squamata*), the brittle-stars are unisexual. In most the eggs are liberated as such, are fertilised externally, and develop in the water; but some species—e.g. *Ophiopholis bellis*, *Ophiocoma vivipara*—produce their young alive (viviparously), and in these cases the genital clefts are enlarged to form distinct brood-chambers. The openings of the clefts admit water, and thus aid in respiration. When the young are born viviparously they are more or less like the parent Ophiuroid, and have no free-swimming larval stage, but where the eggs develop freely in the water, the result is a strange swimming larval form utterly unlike a brittle-star. This so-called 'Pluteus' is fancifully compared to a many-legged painter's easel, the legs being rods of lime which project from the body of the larva. Similar forms are characteristic of sea-urchins (Echinoids). As in other Echinoderms, the development is indirect. It is well

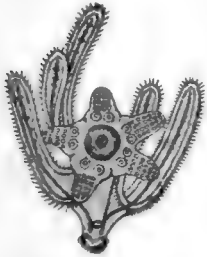

Fig. 6.—Pluteus larva with young Ophiuroid developing within it.

known that in the panic of capture the brittle-stars justify their name by giving off their arms with singular facility. This pathological process is doubtless advantageous, for, like other Echinoderms, the brittle-stars have great powers of regeneration. They can grow new arms or new points, and thus recuperate their injuries; and in some species of *Linckia* and *Ophidiaster* an isolated arm may produce other arms.

The brittle-stars are world-wide in their distribution, or occur at least in all seas yet dredged. The depth of their habitat varies greatly. 'More than two hundred species are restricted in their range to a zone of thirty fathoms,' but 'sixty-nine species descend below one thousand fathoms, and about eighteen below two thousand.' About fifty fossil species are known. Some are said to appear in the Silurian and Devonian, but about these very ancient forms not much is certainly known. In the higher Mesozoic strata, however, they become frequent, and are especially numerous in Jurassic beds.

The Ophiuroids form the most numerous class of Echinodermata, and may be divided into two distinct orders—(a) the Ophiurida, with unforked arms, which cannot be rolled up towards the mouth, and usually have distinct limy shields; (b) Euryalida, often with forked arms, which can be rolled up towards the mouth, and have not distinct limy shields.

Important Forms.—(1) *Ophiurida*.—Among the commonest British species are the Common Sand-star (*Ophiura texturata*), the Lesser Sand-star (*O. albida*), and the Common Brittle-star (*Ophiocoma rosula*). In North-European seas *Ophioglypha lacertosa* is very common. *Ophiopholis bellis* is viviparous. *Ophiactis virens* divides spontaneously. The very widely distributed *Amphiura squamata* is hermaphrodite, viviparous, and phosphorescent. *Ophiopsila aranea* is another luminous form. *Ophiothrix fragilis* is one of the most abundant species, and *Ophiothrix echinata* is common on Mediterranean shores. *Ophiomyxa* leads on to the Euryalida, which in its soft skin and general appearance it markedly resembles. (2) *Euryalida*.—The very curious Gorgonocephalus or medusa-headed brittle-star is one of the best-known genera in this division. The arms are repeatedly forked, and as they curl in towards the mouth become intertwined in a living knot of the most fantastic appearance.

Euryale is another important genus. One form has been occasionally caught on herring nets off British coasts. They are sometimes called Basketfish, Medusa-headed Starfish, or Argus Starfish.

See Forbes, *British Starfishes* (Lond. 1841); Hamann, *Beiträge zur Histologie der Echinodermen* (Jena, 1885); Ludwig, 'Echinodermata' in Bronn's *Thierreich* (in progress), and *Morphologische Studien an Echinodermen* (Leip. 1877-82); Lyman, *Challenger Report on Ophiuroidea* (Lond. 1882); Romanes, *Jelly-fish, Starfish, and Sea-urchins* (Inter. Sc. Series, Lond. 1885).

Stargard, the chief town of Further Pomerania, Prussia, on the Ilva, 22 miles by rail E. by S. of Stettin. Pop. 23,738.

Star Jelly. See NOSTOC.

Starling, a genus *Sturnus*, and family Sturnidae of Passerine birds. The family is a highly characteristic Old-World one, extending to every part of the Eastern continent and its islands, and even to Samoa and New Zealand, but wholly absent from the Australian mainland. The Common Starling (*S. vulgaris*) is a beautiful bird, rather

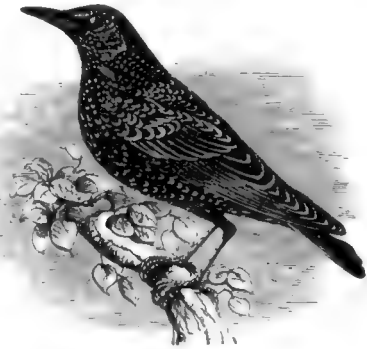

Starling (*Sturnus vulgaris*).

smaller than the song-thrush or mavis, brown, finely glossed with black, with rich metallic purple and green reflections, with a buff-coloured tip to each feather, giving the bird a fine speckled appearance, particularly on the breast and shoulders; in advanced age it is more uniform in colour. The female is less brilliant than the male, and has the terminal spots larger. Both sexes are more speckled in winter than in summer. The starling is abundant in most parts of Britain, and nowhere more so than in the Hebrides and Orkneys. It is very abundant in nearly every district of England, but is less common in Cornwall and in Wales. It is found in all parts of Europe, extending even to Iceland and Greenland. To the Mediterranean basin it is a cold weather visitor in enormous numbers; and it is also common in the north of Asia. Starlings make artless nests of slender twigs, roots, and dry grass (often in company with other birds), in hollow trees, in holes of cliffs, under eaves of houses, or, readily enough, in boxes, which are often placed for them in trees or elsewhere near houses. Year after year they return and build in the same spot if the nest has been removed. They lay from four to seven pale-blue eggs, and breed twice, sometimes thrice, in a season. In autumn the young birds join to form flocks, which become augmented by the older birds, until there is a whole cloud of starlings executing aerial evolutions night after night before roosting time. In winter they disperse in search of food. Their food consists of worms, slugs, beetles, fruit, especially elderberries, and in severe weather they eat hips and haws and sandworms and small molluscs. They

are often found following cattle for the insects attending them. The starling becomes very pert and familiar in confinement, displays great imitative powers, and learns to whistle tunes, and even to articulate words with great distinctness. Its natural song is soft and sweet. In Spain, Southern Italy, and Sicily the unspotted starling (*S. unicolor*) is found, and from Asia Minor to North-western India *S. purpurascens* and several other allied species are found. The Rose-coloured Starling (*Pastor roseus*), a crested bird with rose-pink back, shoulders, breast, and under parts, is an annual visitor to nearly every part of the British Islands, and an irregular migrant over the greater part of Europe. In 1875 many thousands visited Italy, following large flights of locusts, and bred in the province of Verona; and similar incursions have often been made into other places. To North Africa it is an occasional migrant. Eastward it extends through Turkestan to India. Its favourite food is locusts, and on this account it is protected in many districts; but in India, in the cold season, it destroys much grain.

Star-nosed Mole. See MOLE.

Starodoub, a town of the Ukraine, in Russia, 120 miles NE. of Tchernigoff. Pop. 24,388.

Star of Bethlehem (*Ornithogalum*), a genus of bulbous-rooted plants of the natural order Liliaceae, nearly allied to Squills and Hyacinths.



Star of Bethlehem (*Ornithogalum umbellatum*).

The species are pretty numerous, natives almost exclusively of the eastern hemisphere, many of them of the Cape of Good Hope, and some of the south of Europe. The Common Star of Bethlehem (*O. umbellatum*), a native of France, Switzerland, Germany, the Levant, &c., is very common in flower-gardens. Its flowers are large, six to nine, in a corymbose raceme, white and somewhat fragrant. *Gagea lutea*, formerly *O. luteum*, with yellow flowers, is found in some parts of Britain in woods and pastures.

Star of India. See INDIAN ORDERS.

Stars are in general distinguished from other celestial bodies by their fixity of position in the celestial sphere, by the scintillation of their light, and by the fact that they show no appreciable size even under the highest telescopic power. The first quality renders them of great use in that department of astronomy which relates to accurate time-keeping and to measures of latitude and longitude. They form fixed points of reference whose place from their minuteness can be very accurately determined; and as they are far removed

from terrestrial and even solar influence we can refer the motions of the earth and other members of the solar system to them as to unvarying landmarks. Themselves immovable, they determine for us our own movement. It is true that many possess minute motions of their own, but these, as we shall see, are so small as in most cases to affect but little in any moderate time the accuracy of such observations. This practical fixity of the stars enables us to determine two fixed points in the sky called the north and south poles of the heavens. Our Pole Star (q.v.) is not far removed from the first of these. Stars near these points are but little affected by the diurnal motion of the heavens, moving with it in *small* circles, while stars in the Equator (q.v.) move with great rapidity, requiring to complete the entire circuit of the heavens in the same time (twenty-four hours) as the others take to traverse their shorter paths. Thus the changing aspect of the heavens is confusing to an observer at first; but on attentive watching it is seen that all the various speeds and paths of the stars result from one simple motion—viz. the apparent revolution of the whole sky once in every twenty-four hours, as if it were a vast hollow ball hung on opposite points at the two poles. The observer looks as from the centre of this ball, and were it not for the earth intercepting his view would see stars on all sides, below as well as above him. At sea or in a sufficiently extensive plain he will see almost exactly one-half of this sphere, the earth hiding the other. A celestial globe represents this sphere, but is necessarily examined from *without*, while the sky is seen from *within*, which must be remembered in using such globes.

Owing to the sun's yearly motion the stars present different aspects at successive times. In June we see nearly one-half of the sky at midnight. By December the sun, pursuing his annual track, has gained a position among the stars we saw at June midnight. They are above the horizon when the sun is in the meridian at noon. At midnight in December we therefore see the stars in the other half of the heavens. At intermediate seasons the condition of things is of course intermediate also. Speaking generally, the starry sky at midnight on the first of any month is the same as that visible at ten o'clock in the evening of the first of the following month, while the ten o'clock aspect in the first case has of course moved to eight o'clock, and so on.

On the inner surface of the sky sphere the stars are irregularly scattered in groups called Constellations (q.v.). From these groups the stars are named by adding a letter or number to the name of the group. The Greek alphabet is used for the brighter stars— α denoting the brightest, β the next brightest, and so on. Roman letters are used when the Greek ones are exhausted, and afterwards numerals. Sometimes, however, the stars are named by their number from some catalogue, with the initial letter of the observer or of the name of catalogue, and the hour of right ascension (see Vol. I. p. 475) in which the star stands. So great a variety and confusion exists in this nomenclature as to be a serious trouble to beginners, and better arrangements in regard to it are much to be desired. In 1891 arrangements were nearly completed for the charting of the stars by a uniform series of telescopic photographs of the entire heavens. In this great work all civilised nations are uniting with an energy promising success. It is expected to contain when finished all stars down to the 14th magnitude.

The Scintillation (q.v.) or twinkling of the stars, by which they are easily distinguished from the planets, is due to disturbances in our atmosphere,

combined with the fact that the stars are to us mere luminous points. It is magnified by the telescope, and becomes often then sufficient to transform the star into something like a tangled mass of worsted. The various points on the surface of a planet, the sun, or the moon are similarly affected, causing an indistinctness of telescopic vision, which when the air is much disturbed renders accurate observation impossible. But the star, being one point of light, twinkles as a whole, while the planet, sun, or moon, being even in the smallest case many points, does not twinkle as a whole, and the average of its rays gives a steady impression to the eye. Scintillation is most observable on nights when the atmosphere is disturbed, and always greatest at the horizon, being least at the zenith and on quiet nights.

Stars are classed in *magnitudes* according to their brilliance. The 1st magnitude includes the brightest class, only some twenty-four in number, the 2d magnitude the next brightest class, and so on, descending in order of brightness to the 15th or even the 17th magnitude, where we encounter the present limit of telescopic vision. At first this classification was most arbitrary, astronomers differing as to the magnitude to which many stars should belong. Hence a decimal notation was introduced, and stars were classed as 1.5 magnitude, 2.3, 4.6, &c. This must not, however, be confounded with an obsolete notation found in some old books, in which 1.2 mag. meant a star between 1st mag. and 2d, but nearer 1st than 2d, and 2.1 meant the same, but nearer 2d than 1st. The regular instrumental measurement of star-magnitudes is an entirely modern work, proceeding rapidly still. Professor Pickering of Harvard has published (1891) two catalogues, together including more than 25,000 stars whose magnitudes are instrumentally determined, and other astronomers are at work in the same field. A rough guide to ordinary estimates is furnished by the fact that stars barely visible to a good eye are classed in mag. 6, while telescopic stars range from mag. 7 to mag. 15 or 16. Arcturus is nearly 1.0 mag. Pollux and Regulus are an average 2d mag. β Arietis is a shade above 3d mag.

Three explanations may be given for this great variety in brilliance among the stars: (1) that they are all at nearly the same distance from us, and are in themselves different in size or brightness; (2) that they are of nearly equal brightness, but ranged at very varied distances; (3) that they vary both in lustre and distance. The first view has long been obsolete, belonging to the infancy of astronomy; the second, though equally erroneous, is still to be found treated in many text-books as if it had some foundation, no doubt because it forms a theoretical basis for the *star-gauging* carried out by the Herschels (q.v.). The third view is unquestionably the correct one, as will more clearly appear when we examine the measured distances of the stars. There must also be considered the probability that space is not perfectly transparent, and may entirely absorb the light of a star, if its distance from the observer be great enough. If this were the case it would help to account for the observed variety in stellar light. It is at least remarkable that the number of faint stars is so much greater than of bright ones, the former exceeding the latter by millions.

Besides this variety between separate stars there are remarkable changes in the light of some stars from time to time. These are known as *Variables*. The number known is continually enlarged by fresh discoveries, and is now several hundreds. This variability is almost always *periodic*; but the length and form of the periods are strikingly different for different stars. α Ceti, or *Mira*, as it

is called, requires 331 days 8 hours to accomplish its changes. For about a fortnight it is nearly mag. 2, decreasing for three months it becomes invisible, remains so for five months, and then gradually increases for the rest of its period. Algol, or β Persei, has a period of 2 d. 20 h. 49 m.; but its actual change from mag. 2 to 4 is accomplished in $3\frac{1}{2}$ h. γ Argus, again, varies from mag. 1 to 6 in seventy years. The so-called 'new' stars appearing from time to time are possibly only extreme instances of this variability. A noted example is the 'Nova' (or new star) of 1572, which reached such brightness as to be visible at mid-day in November of that year, but immediately began to diminish, entirely disappearing by March 1574. It is probably not identical with the temporary stars of 945 and 1264 A.D. Several similar appearances are known. In August 1885 a 'Nova' appeared in the nucleus of the great Andromeda nebula. About the 6th mag. when first seen, it steadily faded, until by February 7, 1886, it was only of mag. 16. On February 1, 1892, another *nova* of mag. 6 was pointed out in Auriga by Mr T. D. Anderson of Edinburgh. Its place is R.A. 5 h. 25 m. 3 s., dec. + 30° 21'. Within two months it had grown very faint, decreasing since March 9 by half a mag. per day. Its spectrum shows many bright lines, including those of hydrogen and sodium. As to the cause of these outbursts and the other minor fluctuations of the variables there has been much speculation. The passage of attendant meteor-swarms in front of the star, the changes in its atmosphere, positive collision of stars or meteor-swarms, passage of the star behind the edge of a nebula owing to its parallax—these and other explanations have all been advanced; but as yet no satisfactory theory has been given. The spectroscope has revealed in some 'Novas' outbursts of glowing gas; but the cause of such outbursts remains as yet unrevealed. The analogy of the solar spot period (see SUN) would seem to show that solar physics holds the key to this strange problem, our sun being really a slightly variable star.

Variety in *colour* is as great among the stars as variety in light. Comparing Sirius with Betelgeuse this is easily seen. The investigation into this subject is as yet in its infancy, and we may here only note that *very red stars* are never bright, and that the two constituents of a binary star usually are of different colours. Blue or green stars of *marked colour* are also never found alone, but always as members of a close double star.

The measurement of the *distance* of the stars, one of the most difficult problems presented to the human mind, has been also one of its greatest triumphs. It was one of the strongest objections to the Copernican system that if the earth moved as Copernicus said, then the stars would appear to move also, as trees and houses appear to move when seen from a train in motion, *unless indeed the stars were at an inconceivable and impossible distance*. The evidences for the motion of the earth were too strong to be long disputed, and the alternative of the inconceivable distance of the stars had to be admitted. Thus men became familiarised with the *thought* of immense distances, and soon began efforts to *measure* them. The movement of the earth transfers it every six months from one extremity to the other of a line 180,000,000 miles in length. So enormous is the distance of the stars that this change of place in our observatories has hardly any effect on the direction in which we view them. If a star is directly overhead on the meridian when we are at one end of this immense *base-line* it is still overhead when we have arrived at the other end. *Some* minute change, however, there must

be, and to measure this astronomers set themselves. In 1805 Piazzi published some results, only to be disproved. Pond and Brinkley in England disputed concerning each other's results, coming to no definite conclusion. Their work, combined with that of Struve at Dorpat in 1820, showed that the change of place looked for—called Parallax (q.v.)—was even smaller than had been supposed, in fact inappreciable to the instruments of that day.

Finally Bessel of Königsberg, furnished with a fine *heliometer* by Fraunhofer, found in 1840 that the star 61 Cygni showed a *parallax* of $0''.3483$, since raised by modern observation to $0''.475$. This placed 61 Cygni at a distance = 600,000 times that of the sun from the earth. Struve found about the same time a parallax of $0''.26$ for the star Vega, a value since slightly diminished. Henderson also found for α Centauri, a bright southern star, a parallax of about $1''\cdot0$, since corrected to $0''.75$, a distance equal to $4\frac{1}{2}$ years' journey of light. The year's journey of Light (q.v.) is now used as the unit in which to express star distance. The distance expressed thus is easily found from the parallax by the following equation: $\frac{3\cdot202}{p} = d$, where p is the parallax, as usually given, in seconds of arc, and d = the distance required. The number 3.202 is a constant depending on the velocity of light. Succeeding these early observers, Auwers and Brunnow in Europe, and C. A. F. Peters in the United States, continued this great work, and in our own day Professor A. Hall, of Washington, and Drs Ball, Gill, and Elkin, in Britain and at the Cape of Good Hope, have wrought diligently in the same field. We give below a table of a few of the more interesting stars, with their parallaxes and distances:

Star.	Parallax.	Distance in Light-units.	Observers.
α Centauri.....	$0''.75$	4.2	Gill and Elkin.
61 Cygni.....	$0''.47$	6.80	Ball.
Arcturus.....	$0''.127$	25.41	C. A. F. Peters.
Vega.....	$0''.18$	17.78	A. Hall.
Polaris.....	$0''.076$	42.45	C. A. F. Peters.
Aldebaran.....	$0''.516$	6.20	O. Struve.

Since 1889 Professor Pritchard of Oxford has employed photography in determining stellar parallax with considerable success. But very much yet remains to be done in this field of research.

From what is said above it is evident that the stars are distributed through all space, as far as we know it. To a cursory glance they appear to be capriciously scattered, but more minute observation shows traces of arrangement, though we are not yet able to state distinctly the law governing it. The Galaxy (q.v.) or Milky Way forms a ring in the heavens, entirely consisting of minute stars, and as we pass away from this ring the stars become much less abundant. The Herschels laid the foundation for this important discovery by their *star-gauges*. A telescope of 18 inches aperture, 20 feet focus, and a magnifying power of 180, giving a field of view $15'$ in diameter, was used in all these. The process consisted in directing this instrument to a part of the sky and counting the stars in its field. This repeated hundreds of times gave a fair idea of the average number of stars in a circle of $15'$ diameter at all parts of the sky. It was found that at 90° from the ring of the Galaxy this number was $4\cdot15$, at 45° from it $10\cdot36$, at 15° $30\cdot30$, and in the ring $122\cdot00$. Sir W. Herschel considered this to indicate that our sun was one of the stars of the Galaxy, which extended on all sides of us as a flat disc of stars. This view, however, presupposes that the stars in this disc-like cluster are somewhat uniformly distributed, a supposition which has little to support it. The Galaxy may better be considered as what it appears, a ring of small stars relatively near one another and vastly

distant from us. The whole question remains still unsettled, awaiting more numerous measures of stellar *absolute* parallax than we yet possess.

In particular parts of the sky stars gather in clusters. The Pleiades, Hyades, and Præsepe are examples of loose clusters of comparatively bright stars. Telescopes reveal marvellous groups, such as that in Hercules, which contains in very small space *thousands* of stars, spreading at the edge of the mass into curious curved *sprays*, an arrangement seen also in less closely packed groups. These clusters are quite distinct from Nebulæ (q.v.), and form still a puzzle to the astronomer. The nebulae form a very curious instance of a clustering *mixture* of nebulae and stars. In the case of all these clusters, and even of groups less closely compacted, it is probable that a physical connection binds the various members together. The five intermediate stars of the 'Plough' are known to be moving together, in the same direction and with sensibly equal speed. And this grouping is evident in many other cases. But the laws governing and producing it remain yet unknown.

We have alluded here to star motion, called by astronomers *Proper Motion*. This, although hardly affecting the places of the stars in the sky as marks of reference, is distinct and even measured in the case of very many stars. An annual motion of this kind amounting to $6''$ of a great circle of the heavens is accounted large, only some three or four stars exceeding this speed, which would require more than 300 years to transfer the star a distance in the sky equal to the moon's diameter. Although so minute in *apparent* amount, these motions are in reality of a speed inconceivable by us. The star Groombridge 1830 has a real velocity of more than 200 miles per *second*, although annually shifting its place in the sky by only $7''\cdot03$; 61 Cygni has a proper motion of $5''\cdot12$; a small star 1584, xxiii.^b Cordoba Catalogue, has recently been shown to have a proper motion of $6''\cdot205$, while many others have motions of much less amount. Part of these motions is due to the solar movement in space (see SUN), which has been calculated from them.

Double and binary stars were first discovered by Sir William Herschel, and the known number is noted now in thousands, and is continually increasing. There are stars so close as to appear single to the eye, or even, in many cases, to considerable telescopic power, but which, when sufficiently magnified, are seen to consist of two or more separate stars. In some cases no known telescopic power suffices to show the double separate, but the periodical *doubling* of certain lines in its spectrum alone reveals its duplicity. In other cases a single star may show such irregularities in its proper motion as to lead to the suspicion that it is attended by a *dark* companion, whose presence is only indirectly revealed to us by the effect it has in disturbing its luminous neighbour. This is the case with Sirius (q.v.) and Procyon, the companion of the former having been actually discovered as an orb of feeble light, after Bessel had pointed out the probability of its existence. Other stars are also surmised to have companions of this kind. Some of the double stars appear to have no physical connection between their components. Others undoubtedly form *systems*, of two or more suns revolving in periods round their common centre of gravity. These periods vary from 1159 years in the case of 61 Cygni to $10\cdot8$ years in that of δ Equulei. When the distance from us and period of such a 'double' are known, together with the dimensions of its orbit, its mass can be calculated, on the supposition that it is controlled by the force of gravitation.

In studying the *physical nature* of the stars, modern, unlike ancient and mediæval, science, assuming that the universe is *continuous*, has considered the laws governing terrestrial matter to obtain throughout the visible universe. It was therefore easy, once the question of stellar distance was partly answered, to reach the conclusion that the stars are really *sun*s. For they have that in common with our sun, and even with our candles, that they emit *light*, and their light, when analysed, exhibits all the qualities of that emitted by luminous bodies in our laboratories. When their masses are calculated they are found to form bodies of the same order of magnitude as our sun. α Centauri (a 'double') has a mass twice that of the sun. 61 Cygni only equals $\frac{1}{4}$ the solar mass. Judging not by direct measurement of mass, but by distance and relative *brightness*, the star Arcturus is 10,000 times more luminous than our sun, and may have a volume equal to 1,000,000 suns. Other stars, either very brilliant or very distant, range in the same order of magnitude, though too much reliance should not be placed on these calculations, which are liable to large errors and discordances.

These investigations prepare us to expect that the stars are similar in materials and in history to our own sun. When the spectroscope (see SPECTRUM) is applied to examine their light this expectation is confirmed. The star Aldebaran shows the spectral lines of hydrogen, sodium, magnesium, iron, tellurium, antimony, calcium, bismuth, and mercury, indicating that these elements exist in its atmosphere in the vaporous state. The examination of numbers of stars confirms this, so that we know the stars to be of material similar to that composing our earth. The problem before astronomers is therefore now to determine the physical state of the matter composing the stars, and the history of their construction. Through Kant and Laplace the idea had become familiar that nebulae and stars represent different stages of star history, and that different stars correspond to different steps in the process of star *life*, if we may use the expression. Though certainly not yet *proved*, much of modern discovery confirms this view. There is no distinct line between stars and nebulae. From the cloudy mist of the Orion nebulae to the sparkling point of Vega or Sirius a gradation of forms may be traced with no sensible break.

Rutherford of New York, in 1863, first classified the stars according to their spectra into three groups: (1) Red and golden stars; (2) white stars with lines in their spectra; (3) white stars (as he supposed) without lines. In 1865 Secchi commenced also to classify, ultimately adopting a division into four types, which, though altered by Vogel in name, remains the standard classification of the stars. It is as follows:

- I. Continuous spectrum, with four heavy hydrogen lines. White stars, as Sirius and Vega.
- II. Closely resembling solar spectrum. Yellow stars. Aldebaran and our Sun.
- III. Red stars. Fluted bands, fainter towards the violet end.
- IV. Faint, deep red stars. Fluted bands wider than in III., and fading towards the red.

Two prominent explanations are given of these types. The first is that they represent the various stages of star history in order, Class I. containing stars newly formed and excessively hot and brilliant, while Class IV. contains stars cooled down nearly to extinction. The other explanation, due to Lockyer, is that Class III. represents an earlier stage in star history than either I. or II., showing, in fact, the fainter beginning of stellar luminosity; while Class IV. represents the closing period of the star's life as it approaches extinction. Lockyer has on these lines attempted a full classi-

fication of the nebulae and stars, considering all to have their origin in swarms of meteorites (see METEORS), with which he supposes space to be everywhere peopled, and whose collisions, abrasions, and condensations give us ultimately all celestial bodies. This theory has grave objections, and is certainly not established as fact, but it has the merit of being an attempt to unite a vast variety of stellar phenomena under one intelligible principle. We therefore give Lockyer's development of Secchi's classes, with his explanations.

- I. Radiation lines and flutings chiefly. Nebulae and stars with bright line spectra.
- II. Mixed radiation and absorption chiefly. Red stars. Bright flutings—i.e. bands fading—towards the violet.
- III. Line absorption chiefly.
- IV. Few strong lines. Hottest stars. Central point of star life.
- V. Resembling group III.; but stars cooling.
- VI. Carbon absorption chiefly. Stars cooling to extinction.

New stars, on Lockyer's theory, are produced by the sudden collision of swarms of meteors, variable stars by the revolution of two or more swarms, which periodically mingle and collide; and in other ingenious ways various stellar features are accounted for. Time and future observations must be waited for before these explanations are either wholly accepted or rejected. Other eminent scientists strongly object to Lockyer's conclusions. In particular, Croll contended that all evidence goes to show that the physical universe had a beginning not as scattered meteorites, but as immense solid masses moving with a finite velocity, whose collisions formed the first step in the evolution of the various heavenly bodies. Caution in accepting any such theories is, however, very desirable.

For further information readers may consult G. F. Chambers's *Descriptive Astronomy* (4th ed. 1889-90, 3 vols.); Herschel's *Outlines of Astronomy*; Miss A. Clerke's *History of Astronomy in the 19th Century*, and *The System of the Stars* (1890); *Proceedings Royal Society*, vol. xlv., No. 266, being the Bakerian Lecture, 1885, by Lockyer; and Croll's *Stellar Evolution*. See also the articles ASTROLOGY, ASTRONOMY, ZODIAC, &c.

Stars and Stripes. See FLAG, p. 665.

Star-stone, a kind of Sapphire (q. v.).

Start Point, a projection of the coast of Devon, 8 miles S. of Dartmouth, forming the south-eastern extremity of the county. It is crowned by a lighthouse (92 feet), whose light, 204 feet above high-water, is visible for 20 miles.

Starvation. See FAST, Vol. IV. p. 559.

Starwort, or STITCHWORT (*Stellaria*), a genus



Greater Stitchwort (*Stellaria Holostea*).

of plants of the natural order Caryophyllæ, having

a calyx of five leaves, five deeply-cloven petals, ten stamens, three styles, and a many-seeded capsule opening with six teeth. The species are numerous, and several are very common in Britain, annual and perennial plants, with weak stems and white flowers, which in some are minute and in others are large enough to be very ornamental to woods and hedge-banks, as in the Wood Starwort (*S. nemorum*) and the Greater Starwort (*S. Holostea*). To this genus the common Chickweed (q.v.) is now generally referred.

Staten Island. (1) A beautiful and picturesque island, 5 miles SW. of New York, washed by both the Upper and Lower Bay, and separated from Long Island by the Narrows and from New Jersey by the Kill van Kull and Staten Island Sound. Area, 55 sq. m.; pop. (1880) 38,991; (1890) 51,693. Its shores are dotted with villages, and its heights crowned with villas. At its eastern point Forts Richmond and Wadsworth guard the entrance to the Narrows. The island constitutes one of the boroughs of New York City (q.v.), and on the north shore possesses a home for old sailors.—(2) An Argentinian island separated from the south-east point of Tierra del Fuego by Le Maire Strait (40 miles). It is long (45 miles) and narrow in shape, with steep coasts penetrated by deep fiords, and rises to nearly 3000 feet. Snow covers it almost all the year. The island received its name in 1616 from Cornelius Schouten in honour of the 'Staaten' or States-general of Holland.

State Papers. See RECORDS.

State Religion. A state religion and a national religion are two different things. A nation may, with more or less of universal concurrence, accept a certain type of religion—as the people of the United States for the most part accept Christianity—yet they may not commit to their government the task either of representing officially or of maintaining financially their religion. In that case it is a national but not a state religion. Wherever, on the other hand, we witness either establishment or endowment committed to the government—even if, as in Ireland till 1869, the religion thus favoured is very far from being national—there we have the spectacle of a state religion. Now such a spectacle almost invariably presents itself to our view on the first emergence of any people from tribal confusion into national order. The previous multiplicity of local gods and diversity of religious ideas became fused together into a conglomerate state religion, and then were compacted by time and by priestly labour into a sort of incoherent unity. As to any rights of the individual conscience to worship according to its own private judgment, such a notion had not so much as dawned upon men's imagination. It thus becomes interesting in studying this subject to watch the first emergence of the chief historical nations of the ancient world into organised states; and the earliest naturally to reach this high degree of development were the crowded populations whom abundance of food and water drew together in the great river-basins of the East. China, India, Mesopotamia, Egypt accordingly present us with the first 'states' about which anything is known; and in each case we are confronted with a state religion either patronising or patronised by the civil power. In ancient China, for instance, public worship was regulated down to its minutest details by six ministers of state, who were responsible even for the sacred music and religious dancing. The emperor alone might offer sacrifice to the supreme spirit; the nobility might do homage to the various subordinate spirits of the earth; the high officials to the spirits of house and home, and so on, in ever-descending order. Even the soothsayers,

magicians, and spirit-charmers were reckoned among public functionaries of the state. Nor did the reforms effected by Confucius (500 B.C.), nor yet the uprising of two sects, the Taoists and the Buddhists, alter in any way this Erastian character of the Chinese system. It was therefore, and is still, a state religion in close combination with, and subordination to, the civil power.

A similar phenomenon appears among the crowded races which inhabited ancient Mesopotamia. There, too, the supreme head of the state religion was the king; and to such an extent was he predominant that he alone could penetrate into the innermost sanctuary, he alone could offer sacrifice for the whole people; and his palace stood pre-eminent and alone and solid, as if built for eternity, on the sacred platform whence rose towards heaven the terraced tower of Bel. It is therefore from the ruins of the palaces at Nineveh and Babylon, and not from those of the temples, that the records have been recovered which unfold to us the sacred history of this remarkable form of state religion; displaying to us the gradual amalgamation of a hundred tribal beliefs, the ultimate emergence of a Sennacherib or a Nebuchadnezzar to rule, like some incarnation of divine despotism, over all the prostrate nations, and the absolute predominance of the civil over the ecclesiastical power.

Singularly enough, both in India and in Egypt we have the exact contrary of all this. We find there two forms of state religion, in each of which a priestly caste has gained the supremacy over the regal power. In India (as is well known) a religion which began with the lay poets who composed the Vedas emerged from an obscure period at last completely organised on a caste system; and this system assigned irrevocably the first place to the priesthood and the second place to the secular authorities. In ancient Egypt the same relation between the two powers may be observed. There, too, the priesthood is predominant, and kings hold the secondary place. It is the temples which seem built for eternity. The royal palaces have disappeared; or if anything of royalty has remained it is in their tombs—those palaces of the buried kings which the state religion has consecrated with its symbols and covered thickly over with its rubrics from the 'Book of the Dead.' Here, indeed, as in ancient Mesopotamia, the local gods long held sway, and suffered at last agglomeration into the state religion. But the greater state deities were immensely more powerful. They were endowed with vast estates; they employed thousands of labourers, agents, scribes, overseers; they even maintained armies and flotillas of their own; and should any luckless sceptic too openly express his views he was dragged before the pitiless idol in some dark judgment-hall, and expiated his offence in the flames. Thus the Egyptian state religion dominated the entire life of the people, and for long centuries reigned in uncontested supremacy.

When we cross the sea, however, and disembark in imagination among the bright and mobile populations of southern Europe, we soon find that these vast sullen state religions of the eastern river-basins have been left behind. The gods of ancient Greece were as Bohemian and passionate as their worshippers, and no crushing priestly tyranny could find a footing among its small and quarrelsome communities. Yet even there, as childish fancies about Olympus and its happy denizens hardened into dogma, and nursery legends became endeared to the people and fixed in beautiful forms of epic, dramatic, and statuary art, then here, too, a state religion came into being. To ridicule the gods became perilous, even to an Aristophanes; to mutilate their images became an unpardonable crime; and to replace them by other and worthier

conceptions of divine things was a treason which even a Socrates must expiate by his death. In more grim and serious Italy the mingled native and Greek theology became characteristically transmuted into downright law. Offences against the state religion were supposed to bring down on army and navy, on agriculture and commerce, the anger of a justly indignant heaven. And as for any such unheard-of novelty as a catholic or world-wide religion, unacknowledged as its own even by any subject state—still more, for any preposterous claim to worship according to each man's private conscience—away with people possessed of such ideas 'to the lions!' For Christians, therefore, and all state heretics of that sort there was but one answer to be made, *non licet esse vos*, you have no right to exist, you have placed yourselves outside the protection of the Roman empire.

With the conversion of Constantine (313 A.D.), of course, all this was entirely changed; but it was only changed by the parts being reversed. The state religion had now become Christian; and paganism was ere long held to have no right to exist. It is true that with Christianity a new and gentler spirit had found entrance, and that a day might certainly be foreseen when men would cease to persecute and to be persecuted for religion; but that day did not, in fact, come for more than a thousand years. Under the imperial legislation of Justinian the orthodox alone possessed the full privileges of citizenship. And even when the Roman empire was broken up at all points by the irruption of the barbarians, and everything else became changed, still the old-world system of state religions remained unchanged. The Mohammedans, who broke in from the south-east, have always regarded intolerance as a sacred duty; and the Teutonic tribes, who broke in from the north-east, accepted as a matter of course, along with Christianity, its traditional outward forms. Thus, Clovis (500) established the new religion in his Frankish kingdom; Charlemagne (800) even drove the Saxons to conversion at the point of the sword, and with his 'missi,' or royal commissioners, inspected and managed church affairs throughout his wide dominions; and the English Heptarchy, gradually blended into unity, combined in intimate connection the authorities of church and state, without any suspicion that they might one day turn against each other.

But the dangers of such a feeble patchwork of state religions, covering the face of Europe, were obvious and manifold. There was first the insidious danger of 'Simony'—i.e. of a corrupt use of patronage by the laity. Then there was the danger of violent destruction of small state-churches in detail by the fierce and greedy barons of the neighbourhood; and lastly, there was the yet larger peril looming in the future, that each kingdom might finally set up a state religion for itself, and thus hopelessly break up the unity of Christendom. To meet and cope with all these dangers some powerful churchman of large ideas was urgently required, and such a man providentially appeared (1050) in Hildebrand (Pope Gregory VII.). Under his vigorous rule all the existing state religions of Europe were crushed and cramped together into a sort of imperial religion; and for two centuries (till 1300) it seemed as though one all-embracing empire religion were destined to swallow up and destroy all the minor state religions of the world. But when the vast war waged by the papacy in the Crusades had ended in ignominious failure, and when the insensate ambition of men like Innocent III. and Boniface VIII. had roused both France and England to resistance, that great movement of return to state religions

(in the proper sense) began which culminated at last in the Reformation. And then the effect of prolonged and obstinate resistance to all change, and of desperate recourse to fire and sword and fraud and treachery, in maintenance of a despotic system in the church which the free strong nations of the north would not endure, was seen in a general break-up of Christendom.

The first thought naturally was to revert to the previous long-tried system of state religion. But when that seemed reduced to an absurdity in the Augsburg settlement (1555) of *cujus regio ejus religio*—making the church an aristocracy instead of a despotism, and every petty duke and count a pope in his own dominions—the tormented nations had recourse to the sword. Germany was torn to pieces and ruined for two hundred years, France was steeped to the lips in blood, Spain and Austria were silenced, the Netherlands thrown into revolt, and England plunged into her great rebellion, till out of the seething strife between papal religion and state religion there gradually emerged a third form—democratic religion. It began, naturally enough, in Switzerland—at Zurich and Geneva. It permeated and honeycombed, to their ultimate downfall, the despotisms in church and state which 'concordats' had conspired to establish; till at last the various acts of toleration in England, the secular 'Constitution' of the United States, and the French revolutionary enactments of 1789 and 1830 completed the transformation of every state religion throughout Europe into a congeries of virtually free churches—sometimes with, sometimes without, a survival from the past in the shape of a central establishment fully tolerating all its neighbours. Thus, at the present moment, England and Scotland retain, along with absolute toleration for every other form of religion, modified state churches; while Ireland—like the United States—has none. France accepts, as a religion recognised and maintained by the state, every communion which numbers 100,000 adherents—those at present receiving state-payment being Roman Catholics, Protestants, Jews, and (in Algeria) Mohammedans. In Belgium the state does not interfere with the internal affairs of any religious body, but it subsidises the Roman Catholics, the Protestants, and the Jews. In the German empire there is universal toleration, but the various states subsidise their religious communities in various ways. In Denmark there is full toleration for all, but the state religion is Lutheranism; and the same arrangement prevails in Sweden and Norway.

The most prominent example of a surviving state religion, with intolerance for all other forms of faith, is to be found in Russia, where the orthodox Greek Church reigns supreme and dissent is severely persecuted. In Austria-Hungary there is liberty for all, but the recognised religions are those of the Roman Catholics (the dominant church), the Greeks, the Protestants, the Armenians, and the Jews. Even in Greece there is full toleration, though the state religion is that of the Greek Church. In Italy, 'by the fundamental law of the kingdom' in 1870, the state religion is Roman Catholic, but there is now complete toleration for other forms of faith. In Spain and Portugal the state religion is also Roman Catholic, and toleration is very limited. In Holland Protestants, Roman Catholics, and Jews are subsidised by the state, but there is toleration for all. In Turkey the state religion is Mohammedanism. In Switzerland there is absolute freedom for every form of faith. On the whole it would seem that the system of state religion is, by the advancing tide of democracy, threatened with extinction; but that some countries retain it, as an axis round which

other communions may crystallise, or at least as a security against Atheism, Ultramontaniam, and other dangers which the future may have in store for democratic states.

The special relation of the church and state in the Jewish theocracy will be gathered from the articles BIBLE (Vol. II. p. 118), JEWS. The growth of non-conformity in England led to keen controversy between the defenders and the opponents of church establishments; and, especially since the foundation of the 'Society for the Liberation of Religion from State Patronage and Control' in 1844, there has been an increasingly outspoken demand for the disestablishment, with or without the disendowment of the Church of England, especially in Wales. For the 'Erastian Controversy,' see ERASTUS; for the 'Bangorian Controversy,' see HOADLY; for the rivalry between the church and dissent in the schools, see EDUCATION. The great Scottish 'Voluntary Controversy' (see UNITED PRESBYTERIAN CHURCH) between the defenders of the church and dissenters was at its height in 1829-34; the Free Church (q.v.) long insisted on the establishment doctrine in a modified form. The disestablishment of the Irish Church (1869) rendered the controversies as to the established churches in the other parts of the United Kingdom more acute. For other controversies bearing more or less directly on the question, see CATHOLIC EMANCIPATION, JEWS (for the removal of Jewish disabilities), CHURCHYARDS, HOOKER, NEWMAN, OATH, PERSECUTION, TEST ACTS, TITHES, TOLERATION; and the articles on Independents, Friends, and other Nonconformists, as well as that on the Church of England. Of the British colonies, it may be generally said that those which have representative government have no state church, though provision has long been guaranteed for Catholic education in Quebec province. And in most of the Crown colonies also the disestablishment of the Church of England, and the withdrawal of state aid where there was concurrent endowment, has been carried out, especially since 1868. In India there is a small Anglican establishment for the army and other English residents. In the articles on the several countries notes will usually be found as to whether there is an established church or not. And for the view that the church should finally be merged in the regenerated state, see ROTHE (RICHARD). Of the copious literature, see, of works favourable to establishments, Selden, *On Tithes* (1618); Coleridge, *Church and State* (1830); Stanley, *Church and State* (1870); the present writer's *Dissent in relation to the Church of England* (1871); Warburton, *Alliance of Church and State*; Maitland, *The Voluntary System* (1837); Moore, *Englishman's Brief for his National Church* (1880); Selborne, *Defence against Disestablishment* (1886); Hughes, *The Old Church and the New* (1891); Story, *The Church of Scotland, Past and Present* (1891). Unfavourable: Locke, *Letters on Toleration* (1689); Wardlaw, *National Establishments* (1839); Baptist Noel, *Church and State* (1849); Vaughan, *English Nonconformity* (1862); Miall, *The Voluntary Principle* (2d ed. 1850); Skeats, *Free Churches* (1869); *Religious Republics* (1869); *The Case for Disestablishment* (1884). Of books on the general subject of church and state, the following may be consulted: De Marca, *De Concordantia Sacerdotii et Imperii* (fol. 1641); Franck, *Philosophie du Droit Ecclesiastique* (1864); Zeller, *Staat und Kirche* (1873); Geffken, *Church and State* (Eng. trans. 2 vols. 1877); A. Taylor Innes, *Church and State* (1890). On details: Tiele, *History of Ancient Religions* (Eng. trans. 1877); Speir, *Life in Ancient India* (1856); Reville, *Religions des Peuples non-civilisés* (1883); Sayce, *Ancient Babylonian Religion* (1887); Maspero, *Life in Ancient Egypt* (trans. 1892).

States-general (Fr. *états généraux*), the name given to the representative body of the three orders (nobility, clergy, burghers) of the French kingdom. In the time of Charlemagne and for seventy years after his death there were assemblies of clergy and nobles held twice a year to deliberate on matters of public importance. There is no trace of any national assembly in France properly so called earlier than 1302, when the States-general or representatives of the three orders were convened by Philip the Handsome in his quarrel with Pope Boniface VIII. The States-general, how-

ever, though their consent seems in strictness to have been considered requisite for any measure imposing a general taxation, had no right of redressing abuses except by petition, and no legislative power. Under Charles VI. and Charles VII. they were rarely convened. Louis XIII. convoked them, after a long interval, in 1614, but dismissed them for looking too closely into the finances; and from that time down to the Revolution (1789) they were never once summoned to meet. As soon as they did assemble—the clergy, 291; noblesse, 270; *tiers état*, 557 (nearly half lawyers)—the Third Estate, after inviting the noblesse and clergy to sit with them, on the advice of Sieyès, constituted themselves a National Assembly (17th June). About 150 of the clergy joined them (22d June), and nearly 50 of the nobles, with Philip of Orleans, on 25th June; the rest followed by the king's command two days later.

The title States-general was likewise borne by the representatives chosen by the provinces of the old republic of the Netherlands to exercise sovereign power. They met at the Hague (1593-1795), and voted by provinces. The name is retained for the existing legislative body or parliament of the kingdom of the Netherlands. See also ESTATES.

States of the Church. See CHURCH (STATES OF THE).

States' Rights, in the history of the United States, refers to a construction of the Constitution and to a doctrine based on that construction, to the effect that the several states of the Union were and are independent sovereigns, federate to attain and maintain certain common interests by means definite and limited, and that to them alone allegiance is due by their citizens; that the general government is not raised by the Constitution to the position of a national sovereign, but is merely a diplomatic agency whose acts must be ratified by the independent states from whom its authority is derived; and that these are each entitled to judge of any infractions of the Constitution, and to nullify any acts of congress which they may hold to be in excess of its authority, or even to secede from the Union. It will be evident that this position rests on a false assumption, for not one of the thirteen colonies which first formed the United States ever possessed an independent sovereignty, nor could sovereignty have been attained by them otherwise than by united action; so that in 1776 it was a single possessor of the entire sum of sovereign powers that came into being in the person of thirteen states manifesting the will and force to hold such power as one national state within all the territory known as the United States; nay, each several state jurisdiction is actually dependent on that federal will and force, and the sovereign powers exercised in the government of each state, as well as those exercised in and for the whole country by congress, are derived from the will and force of all the states, existing as one integral sovereignty. See Dr J. C. Hurd's *Union-State* (New York, 1890).

Invalid as the doctrine appears, however, it has played a prominent part in the country's history, and brought on finally the war of secession. Its earliest appearance was during the troublous years that followed the French Revolution, when the unsettled condition of affairs in that country alarmed congress and led it to pass certain Alien and Sedition laws, authorising the president to remove from the United States aliens whose presence might seem to him of public danger, and to punish seditious and seditious publications. This action of congress appeared to some to overstep its powers, and in 1798 the legislatures of Kentucky and Virginia protested vigorously on States' Right grounds; but the other states dissented from the position thus for the first time formally assumed. In 1811

and again in 1819, the question was raised in connection with the United States Bank Charter, Henry Clay, and afterwards the state of Maryland, maintaining that congress had no power to incorporate companies or to create a bank. So far the advocates of States' Rights had spoken only; in 1832, in South Carolina, they made the first attempt to carry the principle into action (see NULLIFICATION); in 1860-61 (South Carolina again the first), and in the years which followed, the seceding states carried out that principle, of which they assumed the truth, to the full. The war of secession was the logical outcome of the disputes and agitation of sixty years; with its failure it may be presumed that the doctrine which inspired it, at least in its extreme form and as a factor in practical politics, fell too.

Statice. See PLUMBAGINEÆ.

Statics, the branch of dynamics which treats of equilibrium. The ordinary Balance (q.v.) is one of the most important of statical instruments. With it we balance the weight of a body of unknown mass against the combined weights of a number of standard masses, and so determine the unknown mass in terms of recognised units. The general principle of statics is that which describes the condition of equilibrium amongst a number of given forces. The condition is that the vector sum of the moments of the forces about any and every point vanishes. It is more usual in text-books to break this statement up into two, which admit of ready application. The first is that the sum of the components of the forces along each of three non-coplanar directions vanishes; and the second that the sum of the moments of the forces about each of these three directions also vanishes (see MOMENT). These two rules give six conditions for the equilibrium of a rigid body, three for translation, and three for rotation. Used in combination with other roots, the word statics always implies equilibrium or relative rest. Thus we have Hydrostatics (q.v.) dealing with the equilibrium of fluids, and Electrostatics (see ELECTRICITY) treating of the equilibrium of electrified bodies. See also DYNAMICS and KINETICS. Minchin's *Statics* (4th ed. 1890-91) is the best English treatise on the subject. See also GRAPHIC STATICS.

Stationers' Hall, the hall of the 'Master and Keepers or Wardens and Commonalty of the Mystery or Art of the Stationers of the City of London.' The Company was incorporated in 1557, and had until the passing of the Copyright Act in 1842 an absolute monopoly, as all printers were obliged to serve an apprenticeship to a member of the Company, and every publication, from a Bible to a ballad, was required to be 'Entered at Stationers' Hall.' This registration is no longer compulsory, but the practice of registering is still useful in making good claims of Copyright (q.v.). The series of registers of books entered for publication, commencing in 1554, is of enormous value in the history of English literature. A transcript of these from 1554 to 1640 has been published by Professor Arber, in 5 vols.

Stationery Office, an office in London established by the Lords of the Treasury in 1786, for the purpose of providing for the supply of books, stationery, &c. for the government offices at home and abroad. Its main function, however, is in making contracts for the printing of all reports and other matters laid before the House of Commons. The duties are performed by a controller and assistant-controller, a storekeeper, and about thirty clerks or other subordinate officers. There is a branch establishment in Dublin. The Lords of the Treasury make the principal appointments, but clerkships are open to competitive examination.

Stations (Lat. *statio*), a name applied in the Roman Catholic Church to certain places reputed of special sanctity, which are appointed to be visited as places of prayer. The name is particularly applied in this sense to certain churches in the city of Rome, which, from an early period, have been appointed as churches which the faithful are particularly invited to visit on stated days. The names of these churches are found on the several days in the Roman missal prefixed to the liturgy peculiar to the day. The word, however, is employed in a still more remarkable manner in reference to a very popular and widely-received devotional practice of the Roman Catholic Church, known as that of 'The Stations of the Cross.' This devotion prevails in all Catholic countries; and the traveller often recognises it even at a distance by the emblems which are employed in directing its observance—the lofty 'Calvary' crowning some distant eminence, with a series of fresco-pictures or bas-reliefs arranged at intervals along the line of approach. But the same series of images or pictures is ranged round most Roman Catholic churches, usually starting from one side of the high altar and ending at the other. These representations, the subjects of which are supplied by scenes from the several stages of the Passion of our Lord, are called Stations of the Cross, and the whole series is popularly known as the *Via Calvarii*, or Way of Calvary. The origin of this devotional exercise, like that of local pilgrimages, is traceable to the difficulty of access to the Holy Places of Palestine, consequent on the Moslem occupation of Jerusalem and the Holy Land; these representations being designed to serve as some analogous incentive to the piety and faith of the Christian worshipper of our Lord in His Passion. The number of the so-called 'stations' is properly fourteen, although in some places fifteen, and in others, as Vienna, only eleven; but, whatever may be their number, the subject of all is a sort of pictorial narrative of the Passion. The devotional exercise itself is performed by kneeling at the several stations in succession, and reciting certain prayers at each. Forms of prayer are prescribed to those who can read. The poor and ignorant recite the Lord's Prayer and Hail, Mary! all being directed to fix their thoughts in grateful memory upon 'the sufferings which each representation describes our Lord as having undergone, in atonement for the sins of mankind.' Many 'indulgences' are granted to those who, having duly repented of their sins, shall piously perform this exercise. One Anglican church at least, that of Frome in Somerset, has sculptured Stations of the Cross.

Statistics, that branch of Political Science which has for its object the collecting and arranging of facts bearing on the condition, social, moral, and material, of a people. The collecting of such facts, and the taking of censuses for military purposes, have been in use since the earliest times: King David numbered his people, and Egyptians and Romans had censuses. But the treatment of the statistics of all nations as a branch of study dates from the time of Conring (1606-81), in Germany, to whose distinguished successor Achenwall of Göttingen (1719-72) the name of the study (Ger. *Die Statistik*) seems to be due. As distinguished from the early and simple 'descriptive statistics,' in which the figures were but illustrations to the text, a more scientific arithmetical or mathematical method may be credited to Sussmilch (1707-67), whose work had been simplified by the working out of probabilities and averages in connection with mortality tables and otherwise, by Petty and Halley in England, and others. But most of all to Quételet (q.v.), the great Belgian statistician, is the science indebted for its present standing. The

principle lying at the foundation of the science as ultimately developed is that the laws which govern nature, and more especially those which govern the moral and physical condition of mankind, are constant, and are to be discovered by the investigation and comparison of phenomena extending over a very large number of instances. Accidental diversities tend to neutralise each other, their influence diminishing as the area of investigation increases; and if that area be sufficiently extended, they so nearly disappear that we are entitled to disregard them altogether. While the length of a single life cannot be counted on, an average of 1000 or 10,000 lives gives us a constant quantity, sufficiently near the truth to answer the purposes of insurance companies. Even the acts which are the most purely voluntary as regards individual men have been found to be subject to laws which, in respect of the masses which make up society, are invariable in like circumstances, and discoverable.

The science of statistics has a twofold relation to political and social economy. The facts collected by the statist are the bases on which political economy rests; their application to social and economical problems is an appeal from imagination to fact. But the statist must be guided by the political economist in what direction to extend his investigations: without political economy we should have had no statistics. There have been keen and useless controversies as to whether statistics is an adjunct to other sciences, and a mere method, or an independent science; and as to whether it should limit its scope to national and social phenomena (in which acceptance the word 'demography' has been proposed as a descriptive name), or should be extended into meteorology and other natural sciences. It is impossible to give any convenient and comprehensive classification of the multifarious topics that fall within the sphere of the statistician—population, trade inland and foreign, wealth, currency, prices, banks, social conditions, the people, &c.

There was a kind of statistical bureau in France in Sully's days; such an institution was permanently set agoing in 1800. But the perfecting of statistical methods owes more to the foundation of the Belgian statistical bureau under Quételet in 1831. Since then most civilised lands have devoted much time, labour, and money to collecting and tabulating their statistics—France, Italy, and Germany, and the United States being perhaps remarkable for the fullness and systematic organisation of their statistical returns. What is done in England is not managed by any one central bureau or board, and is less systematic, though very varied and valuable (see BLUE-BOOKS).

There was a statistical section added to the British Association in 1833, and the Statistical Society of London was established in 1834. Under Quételet's influence a great statistical congress was brought together at Brussels in 1853, and like congresses have been held since, usually at intervals of three years, in one of the chief European towns. The *Journal of the Statistical Society* and the *Journal de la Société de Statistique de Paris* appear regularly; and in 1885 an 'International Institute of Statistics' was founded, which publishes a *Bulletin de l'Institut Internationale de Statistique*.

See the articles in this work on CENSUS, MORTALITY (BILLS OF), INSURANCE, GRAPHIC METHODS, AVERAGE, PROBABILITIES, VITAL STATISTICS; the relevant sections in the articles on Great Britain and the several countries, as also such articles as COTTON, RAILWAYS; annuals like the *Almanac de Gotha*, *Statesman's Year-Book*, and such almanacs as Whitaker's; *Mullhall's Dictionary of Statistics* (1883; new ed. 1891-92); *Kolb's Condition of Nations*

(Eng. trans. 1880); *Hübner's Statistische Tafel* (annual); *Webster's Trade of the World* (1880); *Block's Traité Théorique et Pratique de Statistique* (1878); and other works and articles about statistics by modern statisticians like Bodio, Haushofer, Kries, Gabaglio, Farr, Giffen, and Sir Rawson Rawson.

Statius, PUBLIUS PAPINIUS, Roman poet, was born at Naples 40 to 45 A.D., son of a poet and schoolmaster at Naples and at Rome. From early youth addicted to poetry, he gained prizes in the contests at Naples, won the Alban olive-wreath three times, and flourished as a court poet in the favour of Domitian, whom he flattered almost as shamelessly as his rival Martial himself. He lost the wreath of oak-leaves at the Capitoline competition in 94, and thereafter retired to Naples with his wife Claudia, where he died about 96. His chief work is the *Thebais*, an epic in twelve books on the famous theme of the struggle between the brothers Eteocles and Polynices of Thebes. The poem took twelve years to write, yet its construction is slovenly enough—one episode alone occupying one-sixth of the whole poem. It is tedious as a whole, and marred by over alliteration and allusiveness, but is redeemed by passages of exquisite art. Of another epic, the *Achilleis*, only a fragment consisting of one book and part of another remains. His *Silvae*, or occasional verses, apparently half improvisations, are thirty-two in number, extending to nearly 4000 lines, mostly in hexameters. They have the freshness and vigour, together with the artistic imperfections, of unpremeditated effort, but, putting aside the flatteries to the emperor, they show not seldom a spark of the right Promethean fire. The quick touches of pathos, on separation and death, and on the sweet charm of childhood, would alone preserve some of these slight poems from oblivion.

The *editio princeps* of the epics appeared in 1470, of the *Silvae* in 1472. Throughout the middle ages the fame of Statius was great, as readers of Dante (*Purg.* xxi.) will remember. The best editions of the *Thebais* are by O. Müller (books i.-vi. only, 1870) and Ph. Kohlmann (1844); of the *Achilleis*, by Kohlmann; of the *Silvae*, by Jeremiah Markland (1728) and by Baehrens (1876).

Statuary. See SCULPTURE.

Statute of Frauds. See FRAUD.

Statutes. A statute expresses the will of the legislature. It takes effect from the first moment of the day of its passing. Except in Scotland, it remains in force though obsolete; and when repealed it is not revived by the repeal of the repealing act. It is always to be construed 'according to the intent of them that made it.' Primarily, technical words are understood in their technical, other words in their popular sense. When precise and free from ambiguity, they receive their literal meaning and grammatical construction, whatever may be thought of the wisdom or policy of the enactment. But language is so imperfect, and general words are so elastic and open to such varieties of meaning and force, that the literal construction often does not express the real intention. Where such a doubt arises it is necessary to consider what was the earlier law, what its defect, and what the proposed remedy and its object; in other words, to examine the history of the act and the context. The whole act is read, every part in the sense best harmonising with the rest. The preamble is especially invoked to explain what is doubtful. Earlier acts, though expired or repealed, and even later ones on the same or analogous subject, are resorted to, also, for light. The title, marginal notes, and punctuation are disregarded, and so are all statements of members of the Houses and draftsmen as to what was intended.

The scope and object of the act being thus

ascertained, it generally receives a beneficial construction which best 'suppresses the mischief and advances the remedy.' Sometimes words receive an unusual stretch of meaning; for instance, a married woman living apart from her husband would be included in the expression a 'single woman,' where the object of the act was to give the mother of an illegitimate child a claim on the father for its support. So a generic term usually includes species which did not exist when the act was passed. Thus, an act of George II. against copying copyright engravings includes photographic copies, and one of William IV. against 'furious driving' applies to bicycles, though photography and bicycles were not then known. In the same spirit all devices resorted to for evading a law, or misusing powers which it conferred, are defeated by including such attempts within it.

To give effect to the intention expressions are sometimes strained; for instance, 'beyond the seas' is read in an old act as equivalent to 'out of the British dominions.' Sometimes the collocation of the words is altered, or they are rejected altogether, or even words are interpolated. But such modifications are made only when obviously necessary in correction of a careless text which did not make sense or was incomplete as it stood.

Beneficial construction is applied less freely to penal acts. There is a reluctance to supply in them the defects of language, or to eke out their meaning by doubtful inferences. Where a word or phrase is open to reasonable doubt, the benefit of the doubt is given to the subject. An omission, also, would probably not be supplied; but the extreme strictness of construction of former times has now materially given way to the paramount rule that a statute is to be expounded according to the real intention. Acts which impose on the subject burdens or formalities, or otherwise restrict natural liberty, or create monopolies, or confer privileges are construed in the same spirit as penal acts. The language of local and personal acts, which invest persons or bodies with rights and privileges for their own profit or interfere with the rights of others, is regarded as rather that of its promoters than of the legislature, and is consequently construed most strongly against them.

Certain constructions are always rejected, if the language can admit it. Any which would lead to inconvenience and injustice or absurdity would be avoided as probably foreign to the real intention. For this reason a construction which made an act operate retrospectively on vested rights would be avoided; and so would any which conflicted with international law—a construction, for instance, which extended a criminal statute to a foreigner for an offence committed abroad. Again, an act would not be read as affecting the prerogative rights or property of the crown, unless the intention was plainly expressed or irresistibly inferable. A like reluctance is felt to attribute an intention to oust the jurisdiction of the superior courts, or to extend that of new or inferior tribunals and authorities.

If two statutes, or two passages in one, are contradictory, the earlier is abrogated by implication. But, as self-contradiction was probably not intended, such a construction is rejected unless inevitable, or unless there be inconvenience or incongruity in both enactments being in force, or the later would be inoperative if the earlier was not repealed. Special and local acts are unaffected by general acts inconsistent with them, being regarded as not in the contemplation of the legislature when making the general act.

Another and most important axiom is that no change of the law is intended beyond the specific

object immediately in view. Words and phrases, therefore, however comprehensive literally, are so restricted as not to affect any general principles of law. An act, for example, which empowered 'any' justice to try a case would not include a justice who was incapacitated by interest or otherwise from trying it. To confine an act to its immediate object, it is often construed as operative only between certain persons, or under certain circumstances, or for certain purposes only. Thus, an act which made a bill for money lost at play 'void to all intents and purposes' would not affect the validity of the bill in the hands of an innocent indorsee for value, but would apply to it only when in the hands of the drawer or of others with no better title.

It follows that incidents are sometimes found imported into an act which give it an operation different from its strictly grammatical meaning. Thus, where a power is conferred, everything in the way both of right and obligation which is indispensable to its due exercise is tacitly included by law. When, therefore, a statute enacts that a public officer 'may' do some act of a judicial or public nature, it also by implication directs that he 'must' exercise the power whenever the occasion arises; and if its exercise may prejudice a person, it involves the further duty of first giving the latter an opportunity of being heard against it.

When a statute grants a right subject to certain formalities, compliance with such prescriptions is essential on pain of invalidation. But when the prescriptions relate to a public duty, and invalidation for neglect would be unjust to persons who have no control over the defaulting official, without promoting the object of the act, non-compliance does not invalidate. In the former case the act is imperative, in the latter directory only. A penalty for doing something implies a prohibition; this makes the prohibited act unlawful; and all contracts connected with illegal acts are void.

There are some minor rules of interpretation which hardly call for notice here. Some will be found in the Act 52 and 53 Vict. chap. 63. But it may be mentioned, in conclusion, that usage, or a long and general public or professional practice, sometimes impresses on an enactment a meaning not in accord with the natural sense of the words, but which is nevertheless accepted as conclusive.

Staubbach, FALL OF. See LAUTERBRUNNEN.

Staunton, capital of Augusta county, Virginia, in the Shenandoah valley, 136 miles by rail WNW. of Richmond. It is the site of the state lunatic and deaf and dumb and blind asylums, and contains several women's schools, large ironworks, and flour and planing mills. Pop. (1890) 6975.

Staunton, HOWARD, chess-player and Shakespearean scholar, was born in 1810, studied at Oxford, early settled down to journalism in London, and died June 22, 1874. His victory in 1843 over M. St Amand made him the champion chess-player of his day. To this subject he contributed the following works: *The Chess-player's Handbook* (1847), *Chess-player's Companion* (1849), *Chess-tournament* (1851), *Chess Praxis* (1860). His edition of Shakespeare appeared in six volumes (1858-60), with a number of textual emendations so excellent as to give him rank among the best contemporary critics. Another edition (3 vols. 1858-60) was enriched by 824 illustrations by Sir John Gilbert. Staunton also published in 1866 a careful photolithographic fac-simile of the first folio text of Shakespeare. Another useful work was *The Great Schools of England* (1865).

Staurolite (Gr. *stauros*, 'a cross'; *lithos*, 'a stone'), a silicate of alumina with ferrous oxide, magnesia, and water, crystallises in trimetric forms,

and often occurs as twinned cruciform crystals in certain slates and schists. It is reddish, yellowish brown, or brownish black.

Stavanger, the most important town in the south-west of Norway, stands on the southern side of Bukken Fjord, 100 miles S. of Bergen. It has two harbours, entered annually by about 490 vessels of 180,000 tons burden, and derives its importance from its connection with the fisheries of the adjacent coast. The town dates back to the 9th century at least, but has been frequently destroyed by fire, and is now quite a modern place. The cathedral, a Gothic structure, was founded by an English bishop (Reinald) in the 11th century, but was restored in 1866. Of late years it has become a favourite rendezvous of tourists to Norway, 3500 stopping here in 1890. Pop. (1891) 23,930.

Stavesacre (*Delphinium staphisagria*), a species of Larkspur (q.v.), a native of the south of Europe. The seeds have been used in medicine from ancient times; they contain the alkaloids delphinine, delphinoidine, and delphisine, and a considerable quantity of a fixed oil. The seeds are poisonous, causing great depression of the nervous and circulatory systems, with vomiting and purging. They are officinal in the British pharmacopœia, and from them an ointment is made which is used to kill lice, this being its sole therapeutical application at the present time.

Stavropol, a town laid out in 1776 on the northern slopes of the Caucasus and on the principal highway between Russia and Persia. It has broad streets and good stone houses, is the seat of a Greek-Catholic bishop, has railway connections with Rostoff near the mouth of the Don, and is a rapidly growing place, with active industries and a brisk trade in cattle, corn, tallow, hides. Pop. 36,561.—The government of Stavropol has an area of 26,492 sq. m. and a pop. of 657,554.

Stays. See TIGHT LACING.

Stealing. See THEFT.

Steam. Steam is the vapour of water. When dry it is invisible and transparent like air, and not to be confused with the semi-liquid cloud which comes from the chimney of a locomotive. When superheated (see below) it changes the characteristics of a vapour for those belonging to what is known as a 'perfect gas' (see GAS). The development of steam is naturally enough connected popularly with a high temperature, but the two things do not necessarily go together. Water (or snow, or ice) gives off vapour or steam at every temperature—a low temperature not preventing the formation of steam, but only decreasing its density. The only limit to this evaporation is when the air surrounding the water (or snow, &c.) is already saturated with vapour of the maximum density which the water can give off at the existing temperature. Thus, water at 32° F. will give off vapour of a pressure equal to 0.085 lb. per square inch; but if the air above it is already saturated with vapour of that density the tendency of the particles of water to fly apart is exactly balanced by the pressure of the vapour on its surface, and no more evaporation takes place. While no atmospheric pressure can prevent the water or ice passing into vapour, the previous presence in the air of vapour of the required density (even when so small as in the instance just given) entirely stops it.

Suppose *a* to be a cylinder, and *pp* a piston moving steam-tight within it; and suppose also that the end of the cylinder above *p* is open to the atmosphere, and that below *p* there is in the cylinder a perfect vacuum. There is then a downward pressure upon the piston equal to the whole force of the atmosphere, or about 14.7 lb. per

square inch. If now a little water could be introduced into the bottom of the cylinder without admitting any air, a quantity of vapour would rise from it, and press with more or less force on the lower side of the piston so as to sustain a portion of the weight of the atmosphere. How much vapour would rise, and how much elastic force or pressure it would exert, would depend upon the temperature of the water and cylinder.

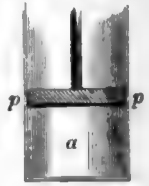

At 32° F., as we have already said, the vapour in the space *a* would exert a pressure equal only to 0.085 lb. per square inch. If the temperature were raised to 80° more vapour would rise until its pressure became about 0.5 lb. per square inch; at 102° the pressure would be 1 lb.; at 162°, 5 lb.; at 193°, 10 lb.; and so on, until at 212° F. the pressure would be 14.7 lb., or exactly equal to that of the atmosphere. When this point has been reached it is evident that the piston will be in *equilibrium*, the pressure beneath it being exactly equal to that above. At each intermediate point the downward pressure on *pp* is equal to the pressure of the atmosphere *minus* the pressure of the steam below the piston. So far as the piston is concerned the conditions are therefore the same as if the vacuum had been impaired by the introduction of a certain quantity of air below *pp*; but there is this difference between the two cases—if the space *a* had been occupied by rarefied air, then, by forcing the piston down and compressing it into less space, its density would increase until its pressure became equal to or greater than that of the external air. With steam, however, if the piston were depressed, and if the temperature of the steam were preserved the same, instead of its pressure being increased, a portion of it would be liquefied, and the remainder would have the same pressure as before.

It is at 212° F. that water in an open vessel begins to boil—i.e. the vapour rises rapidly and in volumes, being able to displace the atmosphere (see BOILING). In this state it is usually called *steam*; but there is no essential difference between steam at 212° and steam at 60°. The steam rising from boiling water in an open vessel is of the same temperature as the water—viz. 212°; but, notwithstanding this, it contains a great deal more *heat*. This heat is employed in (to use popular language) forcing asunder the molecules of the steam, and thus causing it to occupy so much greater a bulk as steam than as water. It does not make itself known by the thermometer (for which reason it is called *latent heat*), but its existence and amount are known by other means (see HEAT). In speaking of the pressure of steam we have given it in pounds per square inch above a perfect vacuum, or as what is called an *absolute* pressure. This must be carefully distinguished from pressures (as often given) in pounds *above atmospheric pressure*. According to the method we adopt, which is the more scientific one, steam of 14.7 lb., or one atmosphere, exactly balances the pressure of the air, and can therefore do no work against it; while, if the other nomenclature had been adopted, steam of 14.7 lb. *above* atmospheric pressure would have been really steam of *two* atmospheres pressure.

When a cubic inch of water is converted into steam at the ordinary pressure of the atmosphere its volume is increased to 1645 cubic inches—i.e. a cubic inch of water becomes nearly a cubic foot of steam of one atmosphere. If the steam is produced at any greater pressure, its volume will be very nearly inversely as that pressure; at two atmospheres it would occupy about 855 cubic inches; at four atmospheres, about 457 cubic inches.

When water is boiled in an open vessel neither the temperature of the water nor that of the steam rising from it ever rises higher than 212°, however hot the fire; the heat as it enters is carried off in a latent state in the steam. But under pressure the temperature of both can be raised to any degree. If, when the water and steam in *a* (above) came to 212°, the application of heat were still continued, more steam would continue to rise, and, the pressure on the under side of the piston being now greater than that of the air above it, the piston would begin to ascend; but suppose it held in the same position by force, the upward pressure of the steam would be found rapidly to increase until it would soon require a weight of 14.7 lb. per square inch to keep it down, showing that the pressure of the steam was now equal to twice that of the atmosphere, or to 29.4 lb. per square inch. If at this point the temperature of the water and steam were examined, it would be found to be very nearly 250° F. When the absolute pressure of the steam reached 50 lb. its temperature would be 281°; at 100 lb., 328°; at 150 lb., 360°, and so on.

From the numerous experiments made on this subject some very important general conclusions may be drawn. Of these one—which will be evident from the figures just given—is that the pressure of steam increases at a far higher rate than the temperature (doubling the temperature increases the pressure nearly 23 times), which shows the extreme danger of continuing to apply heat to a vessel from which the steam is not allowed to escape. The bursting force would soon become such as no vessel could resist. Another important conclusion is that for every temperature there is a corresponding density of steam produced. This steam contains a definite amount of latent heat, and exerts a certain uniform pressure on every side of any vessel in which it may be contained. The following table shows the relation between these values for steam of several different temperatures:

T.	p.	H.	V.	σ.
32°	0.065	1091.8	3390.0	211,536
104°	1.06	1113.7	812.8	19,519
158°	4.51	1130.1	80.02	4,993
212°	14.7	1146.6	26.36	1,645
248°	28.83	1157.5	14.0	874
298°	60.4	1171.3	6.992	436
356°	145.8	1190.4	3.057	191
401°	250.3	1204.1	1.388	115

T, Temperature in degrees Fahrenheit; p, absolute pressure in pounds per square inch of the steam at that temperature. H, Total heat of the vapour above 32° F. at that temperature (according to Regnault's experiments in thermal units. A thermal unit (772 foot-pounds) is the quantity of heat which will raise 1 lb. of water 1° F. at or near its temperature of greatest density, 39.1° F. The specific heat of water increases slowly as the temperature rises, so that 1 thermal unit will not raise 1 lb. of water quite so much as 1° at high temperatures. V, Volume in cubic feet occupied by 1 lb. of steam; σ, number of times which volume of steam exceeds that of same weight of water.

The relations between temperature and pressure in the foregoing table apply only so long as the steam is in contact with the water from which it is generated. Once away from the water its temperature may be raised without altering its pressure. Steam which has received additional heat in this way is called *superheated steam*. It approximates to the condition of a perfect gas, and therefore follows nearly what is known as Boyle's or Mariotte's Law, its volume varying always inversely as its pressure. By this law steam which occupied 1 cubic foot at 20 lb. absolute pressure would occupy 4 cubic feet at 5 lb., and half a cubic foot at 40 lb. absolute pressure. But steam, as commonly used in the steam-engine, is not superheated, but used under the conditions given in the table. It is then called *saturated steam*, and differs sensibly from the condition of a perfect gas. If the pressure (*p*) be given in pounds per square inch, and the pro-

duct (*pv*) of pressure and volume in foot-pounds, then the formula, $\log. (pv) = 4.675 + .061 \log. p$, gives results accurate enough at all ordinary pressures, and can be very easily applied. The volume, instead of increasing inversely as the pressure, increases less rapidly; the difference, though not very great, is so large that it has to be taken into account in all calculations as to the efficiency and behaviour of steam in a steam-engine.

It might naturally be expected that it would take much more heat or fuel to convert a pound of water into steam at a higher than at a lower temperature and pressure. In reality, however, the difference is very slight. Referring back to the table it will be seen that it requires 1146.6 units of heat to raise a pound of water from 32° to 212°, and evaporate it at that temperature; of these 180 are expended in raising the temperature, while 1146.6 - 180, or 966.6 units, become latent in the steam. It only requires 1171.2 units, however (261 sensible and 910.2 latent), to raise the water to 293°, and evaporate it at that temperature; for the latent heat falls nearly as fast as the sensible heat rises. The additional heat required is thus only a little over 2 per cent., while the pressure—which is, *ceteris paribus*, a measure of the work the steam will do—is more than quadrupled. In this way a large increase of power in any engine may be obtained by a small additional expenditure of fuel, and consequently steam of a high pressure is now being used for all purposes, its economy and advantages being fully recognised by engineers. It was thought for a long time that the *total heat* of steam—i.e. the sum of the sensible and latent heats—was constant at all temperatures; but this is not strictly the case, although the table shows that the difference for ordinary ranges of pressure is but trifling. See HEAT, and GAS.

Steam-carriage. See TRACTION-ENGINE.

Steam-crane. See CRANE.

Steam-digger. The successful application of steam to the 'digging' of the soil can hardly be said to date further back than 1880. In that year at the Royal English Show at Carlisle Messrs McLaren of Leeds exhibited the Darby Digger, for which they received the society's special silver medal. This digger was the invention of Mr T. C. Darby of Pleshey Lodge, Chelmsford, a gentleman-farmer, who expended large sums of money and much anxious labour upon the perfecting of this most useful implement. The problem of steam-digging was now successfully solved, and it is surprising that the system has not been more largely adopted. The action of the digger in the soil is quite different from that of the plough. It is much more beneficial to the soil from almost all points of view. Not only is there a saving in power, but the quality of the work done is far superior to that accomplished by the plough. The steam-digger indeed imitates closely digging by hand, and hand-digging is the most perfect of all methods of tillage. By the process of digging the soil is much more thoroughly pulverised than by ploughing. The digging-forks of the steam-digger tear up the soil and toss it over in forkfuls in a manner which leaves both the subsoil and surface-soil more open than is the case in ploughing. The action of the plough in cutting the furrow from the subsoil tends to the formation of a 'pan' on the top of the subsoil. The digger 'tears' instead of 'cuts' the surface-soil from the subsoil, and this tearing action tends to loosen the latter. Most farmers who have tried both steam-ploughing and steam-digging much prefer the latter, not only because they believe that from digging the crops are better and the weeds fewer, but also because the digging appliances are much more simple, and involve less

cost for tear and wear, and for attention in working, than the steam-ploughing gear. The curious circumstance that fewer weeds grow up on land turned over by the steam-digger than on ploughed land is attributed to the fact that, while the digging-forks tear deep-rooted weeds out of the subsoil and toss them on the surface, where they are killed by exposure, the plough merely cuts the long roots in two, leaving one portion to send forth a new crop of weeds. The Darby digger consists of a steam-engine with working parts similar to those of an ordinary traction-engine fixed on the top of a double locomotive boiler. The power is communicated by steel spur gearing to a long horizontal shaft running parallel with the centre line of the boiler. Thence it is transmitted to the digging-cranks by wheels and pinions of cast steel. There are six digging forks, each about 42 inches wide, so that the digger turns over a breadth of about 21 feet at a time. The digging-forks can be set to work at various depths, down to about 14 inches. Whilst digging the digger travels sideways, and has thus been designated the 'broad-side' digger. For travelling on the road the travelling wheels can be turned so that it moves like an ordinary traction-engine. When digging it travels at the rate of about half a mile per hour, and allowing for turning and stoppages digs over an acre per hour. The cost of this digger with an 8 horse-power engine is £1200, and its inventor claims that it will dig ten acres per day at a net cost of nine shillings per acre, including men's wages, coal, interest on capital and depreciation. The digger invented by Mr Frank Proctor, of Stevenage, consists of an ordinary traction-engine geared into a crank shaft, which works three forks in the rear, so that as the engine travels forward in the usual manner the ground is left dug up behind. These forks can be thrown out of gear or hinged up to permit of the engine being used for threshing or other purposes. This system is comparatively cheap, simple, and effective. An 8 horse-power digger costs £800, and in a day of ten hours should dig ten acres, consuming about 11 cwt. of coal, and requiring the attendance of two men.

Steam-engine. Steam-engines in their infancy were known as 'fire' (i.e. *heat*) engines; and in point of fact the older term is the more correct, because the water or steam is only used as a convenient medium through which the form of energy which we call heat is made to perform the required mechanical operations. In modern engines sufficient heat is added to the steam to raise it to a very high pressure, and the excess of this pressure over the pressure opposed to it (either atmospheric pressure or the still lower pressure in a condenser) is both the cause and measure of the work done by the engine. In earlier machines, however, the steam was raised only to atmospheric pressure, and admitted into the engine only to be at once condensed by a jet of cold water. The excess of the atmospheric pressure above the pressure in the partial vacuum caused by the condensation was then the direct cause of work. Engines of this kind were called *atmospheric engines*.

The invention of steam as a moving power is claimed by various nations; but the first extensive employment of it, and most of the improvements made upon the steam-engine, the world indisputably owes to Britain and the United States.

Among the first notices we have in England of the idea of employing steam as a propelling force, is in *The Art of Gunnery* (1647), by Nat. Nye, mathematician; in which he proposes to 'charge a piece of ordnance without gunpowder,' by putting water instead of powder, ramming down an air-tight plug of wood, and then the shot, and applying a fire to the breach 'till it burst out suddenly.' But

the first successful effort was that of the Marquis of Worcester. In his *Century of Inventions*, the manuscript of which dates from 1655, he describes a steam-apparatus by which he raised a column of water to the height of 40 feet. This, under the name of 'Fire-waterwork,' appears actually to have been at work at Vauxhall in 1663-70. Sir Samuel Morland in 1683 submitted to Louis XIV. a project for raising water by means of steam, accompanying it with ingenious calculations and tables. The first patent for the application of steam-power to various kinds of machines was taken out in 1698 by Captain Savery. In 1699 he exhibited before the Royal Society a working model of his invention. His engines were the first used to any extent in industrial operations; they seem to have been employed for some years in the drainage of mines in Cornwall and Devonshire. The essential improvement in them over the older ones was the use of a boiler separate from the vessel in which the steam did its work; one vessel in all former engines had served both purposes. He made use of the condensation of steam in a close vessel to produce a vacuum, and thus raise the water to a certain height, after which the elasticity of steam pressing upon its surface was made to raise it still further in a second vessel.

In all the attempts at pumping-engines hitherto made, including Savery's, the steam acted directly upon the water to be moved without any intervening part. To Denis Papin (q.v.), a French physicist, is due the idea of the *piston*. It was first used by him in a model constructed in 1690, where the cylinder was still made to do duty also as a boiler; but in an improved steam-pump invented about 1700 he used it as a diaphragm floating on the top of the water in a separate vessel, or cylinder, and the steam, by pressing on the top of it, forced the water out of the cylinder at the other end.

The next great step in advance was made about 1705 in the 'atmospheric' engine, conjointly invented by Newcomen (q.v.), Cawley, and Savery. This machine (fig. 1) held its own for nearly

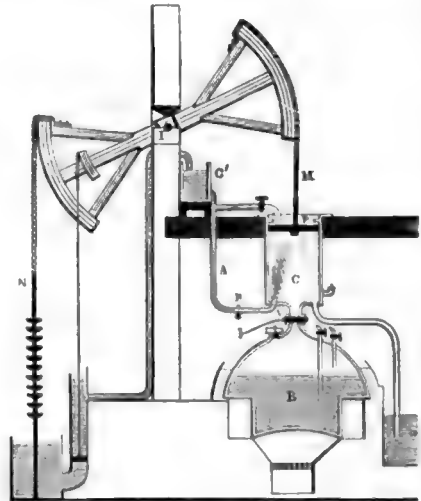

Fig. 1.

seventy years, and was very largely applied to mines. In it the previous inventions of the separate boiler and of the cylinder with its movable steam-piston are utilised, although in a new form. The 'beam,' which has ever since been used in pumping-engines, was used for the first time, and

for the first time also the condensation of the steam was made an instantaneous process, instead of a slow and gradual one. Newcomen's engine was chiefly used, like all former steam-engines, in raising water. To one end of a beam moving on an axis, I, was attached the rod, N, of the pump to be worked; to the other the rod, M, of a piston, P, moving in a cylinder, C, below. The cylinder was placed over a boiler, B, and was connected with it by a pipe provided with a stopcock, V, to cut off or admit the steam. Suppose the pump-rod depressed, and the piston raised to the top of the cylinder—which was effected by weights suspended at the pump-end of the beam—the steam-cock was then turned to cut off the steam, and a dash of cold water was thrown into the cylinder by turning a cock, R, on a water-pipe, A, connected with a cistern, C'. This condensed the steam in the cylinder, and caused a vacuum below the piston, which was then forced down by the pressure of the atmosphere, bringing with it the end of the beam to which it was attached, and raising the other along with the pump-rod. The cock was then turned to admit fresh steam below the piston, which was raised by the counterpoise; and thus the motion began anew. The opening and shutting of the cocks was at first performed by an attendant, but subsequently a boy named Humphrey Potter (to save, it is said, the trouble of personal superintendance) devised a system of strings and levers by which the engine was made to work its own valves. In 1717 Henry Beighton, an F.R.S., invented a simpler and more scientific system of 'hand-gear,' which rendered the engine completely *self-acting*. During the latter part of the time that elapsed before Watt's discoveries changed everything Smeaton brought Newcomen's engine to a very high degree of perfection. As the result of study and experiment he made many improvements in it, in the form of the boiler, the proportions of the cylinder, &c. It was he, too, who invented the *cataract*, a very ingenious self-acting valve arrangement, which is still used in Cornish engines. In 1725 Leupold invented an engine in which steam of a higher pressure than that of the atmosphere was employed in the cylinder, but his engine possessed defects that prevented its practical use.

The next essential improvements on the steam-engine were those of Watt, which began a new era in the history of steam-power. The first and most important improvement made by Watt was the separate condenser, patented in 1769. He had observed that the jet of cold water thrown into the cylinder to condense the steam necessarily reduced the temperature of the cylinder so much that a great deal of the steam flowing in at each upward stroke of the piston was condensed before the cylinder got back the heat abstracted from it by the spurt of cold water used for condensing the steam in the cylinder. The loss of steam arising from this was so great that only about one-fourth of what was admitted into the cylinder was actually available as motive-power. Watt therefore provided a separate vessel in which to condense the steam, and which could be kept constantly in a state of vacuum, without the loss which arose when the cylinder itself was used as a condenser. This device, which now looks simple enough, was the greatest of Watt's inventions, and forms the foundation of his fame. His genius was such that in a few years he changed the steam-engine from a clumsy, wasteful, almost impracticable machine into a machine practically the same as that which we now have. The principal improvements since his time have been either in matters relating to the boiler; in details of construction consequent on our increased facilities, improving machinery, and greater knowledge of the strength of materials;

in the enlarged application of his principle of expansive working; or in the application of the steam-engine to the propulsion of carriages and vessels. His principal inventions were: (1) The condensation of steam in a vessel separate from the cylinder, so as to avoid the cooling of the latter; (2) the use of a pump, called an 'air-pump,' to withdraw the condensed water and mixed steam and air from the condenser; (3) the surrounding of the cylinder with a steam-jacket, in order to prevent loss of heat from condensation (these three, with others, were included in the specification of 1769); (4) the use of the steam expansively in the way explained further on in this article (this was invented before 1769, but not published till 1782); and (5) the now universally used double-acting engine, and the conversion of the reciprocating motion of the beam into a rotary motion by means of a crank (both these were invented before 1778, the engine being patented in 1782, but the crank having before that date been pirated and patented by another). In 1784 Watt also patented and published his parallel motion, throttle-valve, governor, and indicator; all four of which are in substance still used.

The common mode of employing steam in an engine is by causing it to press alternately on the two surfaces of a movable diaphragm or piston enclosed in a fixed, steam-tight, cylindrical box. In fig. 2 A is the piston and B a section of the box. The piston, by means of a rod, E, passing through the end of the box, is made to communicate motion to the rest of the machinery. The steam is first admitted to one end of the cylinder through an opening or 'port,' D, and forces the piston along to the other

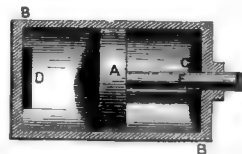

Fig. 2

end. The current of steam from the boiler is then allowed to pass into the other end of the cylinder through the opening C, and forces the piston back again to its original position, and so on. But it is obvious that while this return-motion is going on the steam previously admitted at D must be allowed some exit, or the piston could not be forced back. The manner of this exit constitutes the difference between the two principal classes of engines, according as the steam is allowed simply to rush out into the atmosphere or is conducted into a separate vessel, and there 'condensed.'

The simplest way in which steam can be used in a cylinder is at the same time the most wasteful. It consists in filling each end of the cylinder alternately full of steam direct from the boiler, and having the full boiler pressure, and thus forcing the piston along in exactly the same way as that in which it would have to be forced were water the fluid used instead of steam. If we imagine the cylinder to have a capacity of 7 cubic feet, then, if it be filled entirely with steam from the boiler at 60 lb. absolute pressure, it will contain (about) one pound-weight of steam. The total heat in this pound of steam (above 32° F.), as given in the table, is equivalent to 1171 thermal units in excess of that possessed by a pound of water at 32° F. When the piston, A, has reached the end of its stroke, the steam contained in the cylinder is thus in itself a great storehouse of work, for each of these thermal units is equivalent to 772 'foot-pounds' of mechanical energy, so that the total represents about 904,000 foot-pounds, of which we shall see later on only about $\frac{1}{20}$ has been utilised during the stroke, leaving $\frac{19}{20}$ untouched. Instead of making any attempt to utilise this huge balance, at the moment when the cylinder is full of steam

the opening C is put into communication with the boiler, the opening D with the atmosphere, and the steam immediately rushes out of the cylinder, and dissipates its contained energy through the air. Although the steam, when allowed to go into the atmosphere, is immediately reduced to the pressure corresponding to the temperature of the air (which in ordinary cases would be only a fraction of a pound per square inch), still the full pressure of the atmosphere itself will always be acting on the back of the piston during its stroke, and therefore, to find the force with which the piston is being pushed along, we must subtract that pressure from the steam-pressure. On the one side of the piston will be the atmosphere with its uniform pressure of nearly 15 lb. per square inch, and on the other side the steam-pressure of 60 lb. The effective pressure thus will be 60 - 15, or 45 lb. per square inch only.

Let us now consider the somewhat more economical case of an engine in which the steam is first used as described above, but afterwards, instead of being allowed to pass into the atmosphere, is conducted through a pipe into a closed vessel and there condensed. Condensation consists in the subtraction from steam of a portion of its sensible heat. This reduction of temperature has a double effect on the steam: (1) the cooling and liquefaction of a part of it; and (2) the reduction of the rest to the pressure corresponding to the reduced temperature. It is not possible to do one of these things without the other. What is commonly called 'vacuum' simply means pressure less than the atmospheric pressure; and, in the case of steam-engines, a vacuum generally implies a pressure of between 2 and 3 lb. per square inch—i.e. from a seventh to a fifth of the ordinary pressure of the air. The most common way of condensing steam is by bringing it into contact either with a jet of cold water or with surfaces kept continually cool by a current of water. In either case, directly the steam is brought into contact with the water or cooling surface, it transfers to it the larger portion of its sensible heat. During this process the greater part of the steam is liquefied, and the remainder retains only such a pressure as corresponds to its greatly reduced temperature.

The advantages possessed by a condensing over a non-condensing engine will now be obvious. When the piston is being forced from C to D by steam entering through C, the force on the back of the piston resisting its motion in that direction, instead of being equal to the pressure of the atmosphere, is only the pressure of the steam in the condenser, or about 2 lb. per square inch. The net effective force is therefore 60 - 2 or 58 lb. instead of 60 - 15 or 45 lb.

We have supposed that our cylinder when full of steam contained just one pound-weight at 60 lb. pressure. Let us now find out how much useful work this pound of steam has done for us, and we will then show how the same weight may be made to do a great deal more, by utilising more of its great store of heat. Let us suppose that the area of the cylinder is 2 square feet, while its length (the stroke of the piston) is $3\frac{1}{2}$ feet. It will thus have a capacity of 7 cubic feet, as before assumed. In the first case described we should have a pressure of 45 lb. per square inch exerted on an area of 288 square inches through a distance of $3\frac{1}{2}$ feet. This is equal to 45,360 foot-pounds of work. In the second case we have a pressure of 58 lb. per square inch on the same area and through the same distance. This is equal to 58,464 foot-pounds of work, or about $\frac{1}{5}$ of the total heat supplied by the fuel. (For simplicity's sake we have here

assumed that the water in the boiler has to be raised from 32° to 292°, and evaporated at that temperature. If the water were supplied at 212°, then the work done would be about $\frac{1}{5}$ instead of $\frac{1}{15}$ of the total heat.) We may now proceed to examine the way in which the same weight of steam, generated by the consumption of an identical weight of fuel, may be made to perform many times more work by 'working expansively.'

One of the properties possessed by steam, in common with all other gases, is a tendency to expand indefinitely; its pressure varies nearly inversely as its volume. For simplicity's sake we shall here assume that steam is a perfect gas, and follows Boyle's law, the pressure varying *exactly* inversely as the volume. If then we have a cylinder of the same area as before, but of twice the length, but only intend to admit 1 lb. of steam into it at a time, it will be necessary, when the piston has travelled $3\frac{1}{2}$ feet of its stroke, to shut the entrance valve, so as to prevent more steam entering; this is called 'cutting off' the steam. The piston, however, still continues its motion in the same direction as before, propelled by the internal separative energy among the particles of steam. But as it is pressed forward the space occupied by the steam is always increasing, and its pressure always decreasing in proportion, until at length, when the piston has reached the end of its stroke, the steam occupies exactly double its original volume—viz. 14 cubic feet, and is reduced in pressure to half its original pressure—viz. to 30 lb. per square inch. We have thus during the first half of the stroke a constant pressure on the piston of 60 lb. per square inch, and during the second half a pressure gradually decreasing from 60 to 30 lb. The *mean* pressure during this second half of the stroke will be found on calculation to be almost exactly 40 lb. Let us now, in the same way as before, see what work we have been able to get out of our pound of steam by expanding it in this way. In the first half of the stroke we have 58,464 foot-pounds of work exactly as before, and then we have in addition a mean pressure of 40 - 2, or 38 lb. per square inch, exerted over 288 square inches for a distance of $3\frac{1}{2}$ feet. This equals 38,304 foot-pounds, making a total of 96,768 foot-pounds of work obtained from the steam which only gave us 58,464 before. The economy of working expansively, however, goes much further than this. If the cylinder had been four times its original length, and the steam had been cut off at the same point as before (which would then be quarter instead of half stroke), we should have obtained from the 1 lb. of steam about 144,000 foot-pounds of work. If we had gone still further and expanded the pound of steam into eight times its original volume, we should have obtained about 180,000 foot-pounds of work, which is more than three times as much as at first. (In actual working, owing to various causes—such as imperfect action of the valves, radiation from the cylinder, bad vacuum, &c.—the work obtained from the steam is not more than '65 to '75 of that given in this paragraph.) All modern engines are worked more or less on this principle of expansion, and the general tendency seems to be every year to adopt higher initial pressures and (within certain limits) larger ratios of expansion.

Fig. 3 represents Watt's 'double-acting' condensing engine. By 'double-acting engine' we mean an engine such as was sketched in fig. 2, in which the steam acts on both sides of the piston instead of only on one, as in Newcomen's engine. Watt's engine, though not of the form now generally used, contains all the parts now considered essential. The steam from the boiler passes direct to the valve-chest, *v*, which is simply a long box

attached to the cylinder, *a*. In this chest are placed valves, which are so regulated as to open communication between the boiler, cylinder, and condenser, in such a way that when the top of the cylinder is open to the boiler the bottom communicates with the condenser, and *vice versa*. When the steam has done its work it passes out through

closed in another cylinder, and the annular space or 'jacket' between them filled with steam from the boiler, principally with the object of preventing liquefaction in the cylinder, which is fatal to economical working. The openings for the entrance and discharge of the steam (shown at C and D in fig. 2) are both called *ports*.

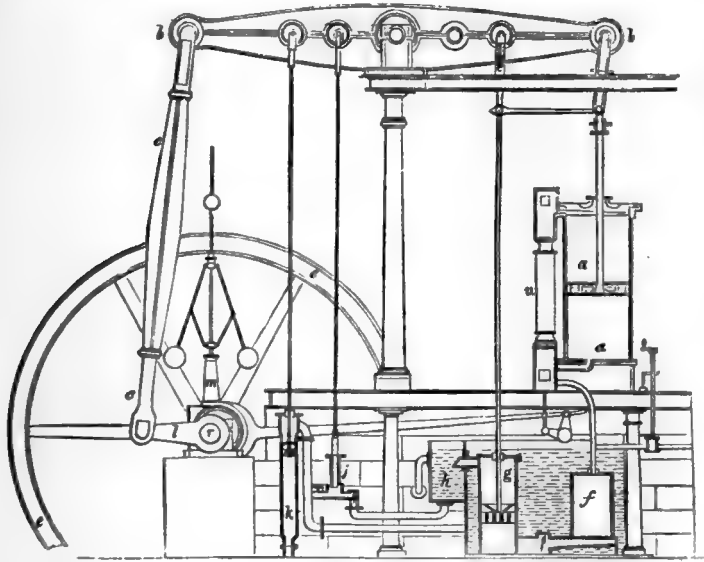

Fig. 3.

the bent pipe into the condenser, *f*, where it is met by a jet of water (not shown in the engraving), and condensed, as before explained; *g* is a pump called the air-pump, which continually draws away the contents of the condenser, and discharges them into a cistern, *h*, called the hot well. A small force-pump, *j*, draws part of the water from this cistern, and sends it back again to the boiler, there to be reconverted into steam, while the rest of the water is allowed to run to waste. A suction-pump, *k*, supplies water to the large tank round the condenser, and also for the condensing jet. Inside the cylinder are the piston and the rod (called the piston-rod) connecting it with the beam, *bb*. In Newcomen's engine the rod had only to pull the beam down, and not to push it up; it could, therefore, be connected to it by a chain, as shown in fig. 1. In the double-acting engine the piston-rod is required both to pull and to push the beam, so that the chain is no longer admissible. It is obvious that as the head of the rod must move in a straight line, while every point in the beam describes an arc of a circle, the two cannot be rigidly connected. Watt invented the arrangement of rods shown in fig. 3, by which the piston-rod head is always guided in a straight line, while the end of the beam is left free to pursue its own course. This is called a 'parallel motion.' The end of the beam farthest from the cylinder is connected by a rod, *cc*, called a connecting-rod, to the crank, *l*, which is firmly fixed on the shaft; and by this means the reciprocating motion of the beam is converted into the rotary motion of the 'crank-shaft,' *r*. The governor, *m*, and the flywheel, *ee*, will be explained further on.

The cylinder and its piston are both made of cast-iron. The former is very accurately bored in a special machine, and ought always to be covered outside with non-conducting material to prevent radiation of heat. It is frequently en-

closed in another cylinder, and the annular space or 'jacket' between them filled with steam from the boiler, principally with the object of preventing liquefaction in the cylinder, which is fatal to economical working. The openings for the entrance and discharge of the steam (shown at C and D in fig. 2) are both called *ports*.

out by *c* under the valve, and through *b* into the condenser. By the time the piston has reached the same position, going in the opposite direction, the valve is in the position shown in the right-hand sketch, and the motion of the steam is exactly reversed. The valve in fig. 4 opens one port at the same moment as it closes the other. This corresponds to entirely non-expansion working. In order to 'cut off' the steam before the end of the stroke the breadth of the ends of the valve must be increased. This is called giving 'tap' to the valve. When it is desired to 'cut off' the steam earlier than half-stroke, a separate valve, called an *expansion valve* (of which there are innumerable varieties), is generally used. The rod to which the piston is attached is called the *piston-rod*, and the rod which actually drives the crank the *connecting-rod*. In

Watt's engine and similar machines these are connected to opposite ends of a *beam*, but in the common type of engine shown in fig. 6 (below) the two rods are directly attached. The *flywheel* is a large wheel fixed on the crank-shaft, and having a very heavy rim. As it revolves this contains, stored up in itself, a great quantity of energy, and so equalises the motion of the shaft, and by restoring some of the energy enables the engine to pass the 'dead-points,' or points at which the connecting-rod and crank are in a line. The *condenser* is simply a cast-iron box of any convenient shape.

The *valve* or valves which regulate the admission of steam to the cylinder vary very much in construction and design. In ordinary engines one valve, called a *slide-valve*, does the whole work for each cylinder in a way which we shall explain by the aid of fig. 4. This figure shows the valve in two positions—viz. those corresponding to the times when the piston is at the middle of its stroke, going in the two different directions; *c* and *d* are the ports, the ends of which are denoted by the same letters in fig. 2; *b* is the 'exhaust port,' or opening through which the steam passes to the condenser; and *a* is the slide-valve working inside the steam-chest (the latter not shown). The sketch to the left shows the position of the valve when the piston is moving upwards. The steam enters the cylinder through *d*, as shown by the arrows, while the steam in the other end is free to rush

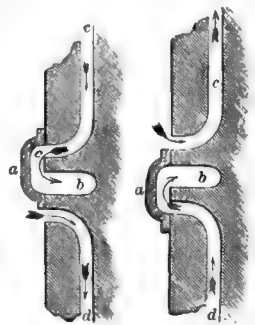

Fig. 4.

The water for condensing the steam is introduced into it in a jet in such a way that its particles mix with the steam at once on entering, and condense it almost instantaneously.

The governor, shown in fig. 5, is an ingenious application by Watt of mechanism long used in water-mills. Its object is to make the engine to

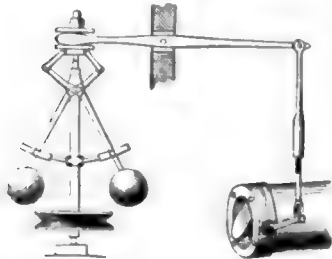

Fig. 5.

a great extent regulate its own speed, so that it shall neither be pulled up altogether by a sudden increase of load, nor 'race' when any part of its load is suddenly removed. It consists essentially of a spindle or upright rod, with a pulley by which it is caused to revolve fixed on it. Two levers are pivoted on a pin near the top of the spindle, and at the lower end of each is fixed a heavy cast-iron ball. When the engine is running at its proper speed the balls revolve with the spindle in the position shown; but if that speed be increased the centrifugal force causes them to fly outward, and consequently upward; and conversely, if it be decreased they fall downward towards the centre. At the upper end of the spindle is a system of levers, by which it will be seen that the raising of the balls tends to close, and their lowering to open, the *throttle-valve* at the right of the engraving. The valve in the figure is simply a disc of metal placed in the steam-pipe near the cylinder, but a great many other types of valve—more expensive but more efficient—are now used for the same purpose. The further this valve is opened the greater the amount of steam admitted to the cylinder, and *vice versa*, and so the tendency of the engine to alter its speed arising from causes extraneous to itself is just balanced by the alteration made in the amount of steam admitted through the throttle-valve. In order that economy as well as regularity of working may be attained, it is in many cases necessary that the governor should be so arranged as to control the 'cut-off' instead of throttling the steam as in the figure.

The 'Cornish' engine, so called from the fact that it is principally used in the Cornish mines, resembles Watt's engine in general appearance. Like Newcomen's engine it is used exclusively for pumping and has no rotary motion, and it is virtually single-acting; but, unlike his, the steam-pressure and not that of the atmosphere actually does the work. Cornish engines are fairly economical of steam, but are very costly and extremely heavy and unwieldy.

Engines in which the piston-rod and connecting-rod are directly attached are called *direct-acting engines*, of which the horizontal engine shown in fig. 6 is the most common type. For all ordinary purposes direct-acting engines are rapidly superseding every other form. They possess the merit of having great simplicity and few working parts, and of all these parts being easily accessible to the engine-driver; and at the same time any required degree of economical working can be obtained in them as well as in any other form. They were at first only used as non-condensing (or so-called 'high-pressure') engines, but are now as frequently made with a condenser attached.

Two other forms of direct-acting engines have been much used in their day, but are now being

rapidly abandoned except under special circumstances; these are called respectively the 'oscillating' and the 'trunk' engine. In the former (which has rarely been used except for marine engines) the crank-shaft is above the cylinder, the piston-rod head is attached to the crank-pin, and the connecting-rod is dispensed with by allowing the cylinder to oscillate on large hollow centres called *trunnions*, and so to adapt itself to the various positions of the crank-pin. In the 'trunk' engine the piston-rod becomes a hollow cylinder or *trunk*, large enough to allow the connecting-rod to vibrate inside it. The latter is then attached at one end to the crank-pin as usual, and at the other to a pin fixed in the piston.

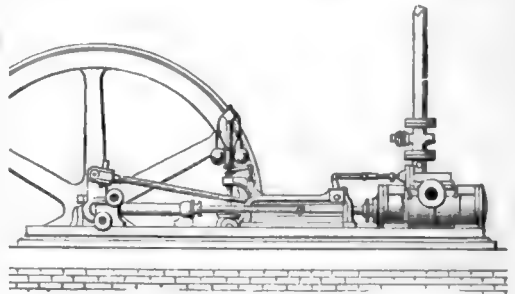

Fig. 6.

Direct-acting engines are now made to run at extremely high speeds, for driving dynamos, &c. direct. For this purpose they are made single-acting only, so that the steam-pressure tends always to keep the working surfaces pressed together, and there is none of the shock and noise found in ordinary engines where the direction of pressure is reversed at each stroke. The first successful machine of this type was Mr Brotherhood's 'three-cylinder' engine, of which an immense number are in use. Of late years Mr Willans, in his 'central valve' engine, has added an exceptional degree of economy in steam to the other advantages of the single-acting type. Willans' engines are now very commonly used in the more important electric lighting stations in Britain for the direct driving of dynamos, and have given most satisfactory results. An immense amount of ingenuity has been expended in devising engines in which the rotary motion of the shaft is obtained *directly* from the piston without the intervention of reciprocating parts. These machines are called *rotary engines*; they have never come into general use, and most of them have been defective in construction as well as founded on a dynamical misconception.

In *locomotive engines* it is necessary that the whole machinery should be compressed into the smallest possible bulk, and this necessity is the cause of their principal peculiarities. The engine itself is much the same as an ordinary horizontal engine, and has two cylinders placed side by side near the front of the locomotive. These cylinders are sometimes placed inside the main framing, which runs the whole length of the engine, and sometimes outside it, each plan having certain advantages. Fig. 7 is an outline section of an 'inside cylinder' goods-locomotive belonging to the Midland Railway Company. At the back of the locomotive is the firebox, *a*, the bottom of which is formed by the grate, *b*. Fuel is introduced by the door, *c*. The firebox is enclosed in a casing, *d*, and the space between is filled with water. This space communicates freely with the barrel, *e, e*, of the boiler, a long wrought-iron or steel

cylinder. From the back of the firebox numerous small tubes traverse the boiler (through the water) to the smoke-box, *f*, and conduct the products of combustion to the chimney, *g*. The steam-pipe, *k*, is led away from near the top of the dome, *h*, and fitted with a regulator valve, *l*. At *m* are a pair of

spring safety-valves. Both cylinders discharge their steam through the vertical blast-pipe, *p*, and by this means a sufficient draught is caused, notwithstanding the small height of the chimney. The cylinders, *r*, are placed in the bottom of the smoke-box, and partly enclosed in it.

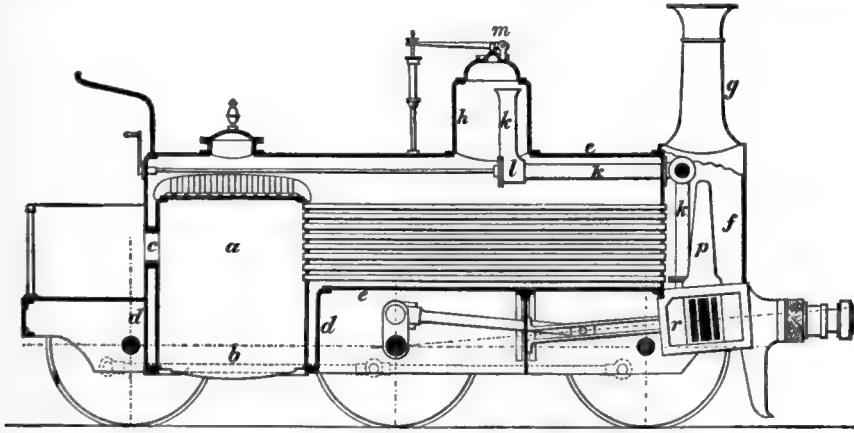

Fig. 7.

In all *marine engines*, except the very smallest, two cylinders are used, working cranks at right angles to each other, so as to equalise the motion as far as possible, it being almost impossible to use a flywheel of sufficient weight for that purpose on board ship. The form originally known as the 'steam-hammer' engine (from the resemblance of early models to Nasmyth's steam-hammer), or some modification of it, is now almost universally adopted. They are direct acting, but the cylinders are inverted, and placed right above the propeller shaft. Two of the greatest improvements in the modern steam-engine—the *surface-condenser* and the *compound engine*—have been brought to perfection chiefly in connection with marine engines here. In the surface-condenser the steam is condensed by contact with the exterior surface of a great number of small tubes, through the interior of which a current of cold sea-water is kept constantly flowing. By this means the condensing water and the condensed steam are kept separate, the former being returned to the sea, and the latter only sent into the hot well. The boiler, therefore, is continually fed with distilled water, and the wasteful process of 'blowing off,' to get rid of the unvaporisable matter which would otherwise be deposited in the boiler, is rendered unnecessary.

In 'compound' engines the two cylinders are of unequal size—the larger, called the low-pressure cylinder, having from three to four times the capacity of the smaller or high-pressure cylinder. The steam from the boiler is admitted into the latter in the usual way, and cut off generally at from $\frac{1}{2}$ to $\frac{3}{4}$ of the stroke; and after doing its work there, it is conducted to the large cylinder, where its reduced pressure, by acting on an increased area, does as much work as in the other cylinder, and thence to the condenser. This system of engine has several notable advantages—among which are that the driving pressures are more uniform than in ordinary engines; that leakage past the piston becomes of less importance; that for any given *large* measure of expansion the mechanism of the engine is much more simple than for the same degree of expansion carried out independently in two cylinders; and that the losses due to condensation of steam in the cylinders

(which are now known to be among the most serious of all causes of waste) are much reduced.

In modern marine engines, and to some extent also in mill engines, the compound principle is now carried further, and 'triple expansion' engines (which are simply compound engines with three cylinders used consecutively instead of two) are very widely employed, with very economical results. In these engines steam is not uncommonly used at a pressure as great as 150 lb. per square inch, or six times as much as was usual about 1860. Quadruple engines are also used.

The *Work done by Steam-engines* is estimated in two ways—as *horse-power* and as *duty*, and the first expression includes two things—nominal and indicated horse-power. Thirty-three thousand foot-pounds of work done per minute is called one horse-power, this being considered by Watt as the maximum rate at which a strong horse can work. The *nominal* horse-power of an engine has long ceased to be any expression of the actual power it exerts; it is only used as a kind of commercial standard (a very deficient one) for the sale and purchase of engines, and is generally made to depend entirely on the diameter of the cylinder. The *indicated* horse-power is the most useful measure we have of the work done by an engine. It expresses, however, not the work itself, but the rate at which that work is being done in the cylinder. It has to be remembered also that it does not show at all what proportion of that work has to be expended in overcoming the friction of the engine itself. It is ascertained by the use of a little machine called an 'indicator,' devised by Watt, and since his time greatly improved, especially by Richards and by the Crosby Company. By taking the *mean* pressure per square inch on the piston throughout the stroke (measured from the indicator diagram), and multiplying it by the area of the piston and by the number of feet passed through by it in a minute, we can find the number of foot-pounds of work done by the engine per minute; and this, divided by 33,000, gives the indicated horse-power.

'Duty' is an expression used only for pumping-engines, and differs from horse-power in being entirely independent of time—i.e. it is a measure

of work done, and not of the rate at which it is done. It is the number of foot-pounds of nett work resulting from the consumption of a given quantity of coal, usually either a bushel of 94 lb. or a cwt. At the beginning of the 19th century the maximum duty that had been attained by any Cornish engine was 20 millions of foot-pounds per cwt. of coal, but six times that duty has since been occasionally obtained. In these engines it is the actual nett work done which is taken into account; the duty would be 20 or 25 per cent. greater if the total load on the steam-piston had been considered instead.

For engines whose power can only be measured by the indicator the standard of economy is the number of pounds of steam used per hour per indicated horse-power. A first-class non-condensing engine, working with steam of about 100 lb. pressure, uses about 22 lb. of steam per i. h. p. per hour, which is reduced to 17 or 18 lb. by the employment of condensation. Occasionally better results than these are obtained, but in ordinary good work the figures are at least 25 per cent. greater, and they are often more than double as great. In any case economy is only to be obtained if the engines are worked at or near their full power, and with the full steam-pressure for which they are intended. It is very common to speak of the amount of coal burned per i. h. p. per hour, and this is a very important quantity. It is, however, a measure of the combined economy of a boiler and engine, and not of the economy of an engine alone. A pound of Welsh coal can be made to evaporate 10 to 11 lb. of water under special conditions. In ordinary circumstances and over long periods the evaporation is more like $7\frac{1}{2}$ to 9 lb. of water per lb. coal. Inferior fuels, or even good fuel badly burned, give, of course, very much lower results.

For other points, see articles STEAM, ENERGY, THERMODYNAMICS, GAS, FUEL, SAFETY-VALVE, HORSE-POWER, INDICATOR-DIAGRAM, INJECTOR, AIR-ENGINE, GAS-ENGINE, RAILWAYS, SHIPBUILDING, &c. See also for theory, *Cotterell's Steam Engine as a Heat Engine*, Rankine's *Steam Engine*, and Northcott's *Steam Engine*; Seaton's *Marine Engine*; Galloway's *The Steam Engine and its Inventors* (1881); Thurston's *History of the Steam Engine* (N. Y. 1878); Hughes's *Modern Locomotive* (1894); Ewing's *Steam Engine and other Heat Engines* (1894).

Steam-hammer, a contrivance which has done more perhaps than any other mechanical invention of modern times to develop the wonderful resources of the iron trade. The first idea of a steam-hammer appears to have been due to James Watt, the great father of engineers, and was patented by him in 1784. In 1806 William Deverell, 'an engineer of Surrey,' also took out a patent for one; but in neither case does it appear that steam-hammers were actually constructed, though in both specifications a direct-acting steam-hammer is, so to speak, sketched in words. From this time till 1839 the idea seems to have been entirely lost sight of. It was then again taken up by Mr James Nasmyth, of the Bridgewater Foundry near Manchester. Mr Humphries, engineer to the Great Western Steamship Co., who had been unable to induce any forge-master to undertake the heavy forgings required for the intermediate paddle-shafts of the *Great Britain* steamship, then in course of construction, applied to his friend Nasmyth for suggestions as to how this difficulty might be overcome. Nasmyth made a sketch of a hammer operated by steam-power, and sent his sketch to Humphries, who, along with Brunel and others, heartily approved of the scheme; but in consequence of a change of design, and the substitution of a screw for paddles, the proposed heavy shafts were not required, and the hammer was not then constructed. The scheme was then

offered to many forge-masters and engineers; but they failed to duly appreciate its value and importance, and the hammer remained a mere sketch in Nasmyth's 'scheme-book' till 1842. In the spring of that year Nasmyth, much to his surprise, saw at Creusot in France a steam-hammer at work, which had been built in accordance with a copy of his own rough 'scheme-book' sketch, made by two French engineers during a business visit to the Bridgewater works. Nasmyth had been previously urged by his friends to protect his invention by a patent, and immediately on his return to England secured one in June 1842. It is interesting to note that this patent mentions the use of steam above the piston to increase the intensity of the blow, and also a self-acting arrangement. The first English steam-hammer under this patent was made at the Bridgewater Foundry early in 1843; but, although considered an improvement upon the old 'helves' hitherto used for forging purposes (see HAMMER), it was far from being a perfect tool. The principle on which the hammer worked was as follows: two vertical columns or frames supported an inverted vertical steam-cylinder; the hammerhead or tup was attached to the rod of the piston working in this, while vertically beneath, supported on the floor, was the anvil; steam admitted beneath the piston raised it, and with it the hammerhead, at some chosen point the supply was cut off and the steam beneath the piston allowed to escape into the atmosphere, the piston and tup at once fell and gave a blow to anything placed on the anvil; the force of this blow simply depended on the weight of the tup and the height to which it was raised before being allowed to fall. The admission and exhaust of the steam was controlled by means of an ordinary slide-valve worked by a long lever, requiring great labour and constant attention in order to give the blow required; some automatic contrivance was considered necessary to secure complete command over the power of the blow, and to insure that the instant the blow was struck the block should immediately rise again, thus preventing the heat in the mass of iron on the anvil being reduced by the cold face of the block. The peculiar difficulty of securing a true automatic arrangement will be seen, when it is considered that the time of descent of the hammer must vary with almost every blow that is struck; for the piece on the anvil becomes thinner and thinner by each succeeding blow, and with flat bars a blow is first given on the flat side and then on the edge, the difference in the fall of the hammer in the two cases being often many inches; furthermore the hammer must be under perfect control at all times.

It is stated that Nasmyth failed to devise a satisfactory automatic arrangement, but Mr Robert Wilson, then engineering manager of the works, afterwards managing director and successor to Nasmyth on his retirement, who was assisting to work out the details, after a week's scheming solved the difficult problem. His automatic device was first tried on a small 5-cwt. hammer, the second one made, and as it at once proved successful was immediately fitted to several 5-ton hammers then under order; the first one actually made for sale was delivered to the Low Moor Ironworks on August 18, 1843, and answered every expectation. This improvement was covered by a patent taken out by Nasmyth in July 1843. The time of releasing steam from under the piston, and therefore the height of fall, was regulated by a tappet-lever carried by two vertical screws. The tup in its upward movement struck this lever, thereby moving the valve, cutting off the steam, and also releasing it so as to allow the hammerhead to fall. The attendant turning these screws by a small

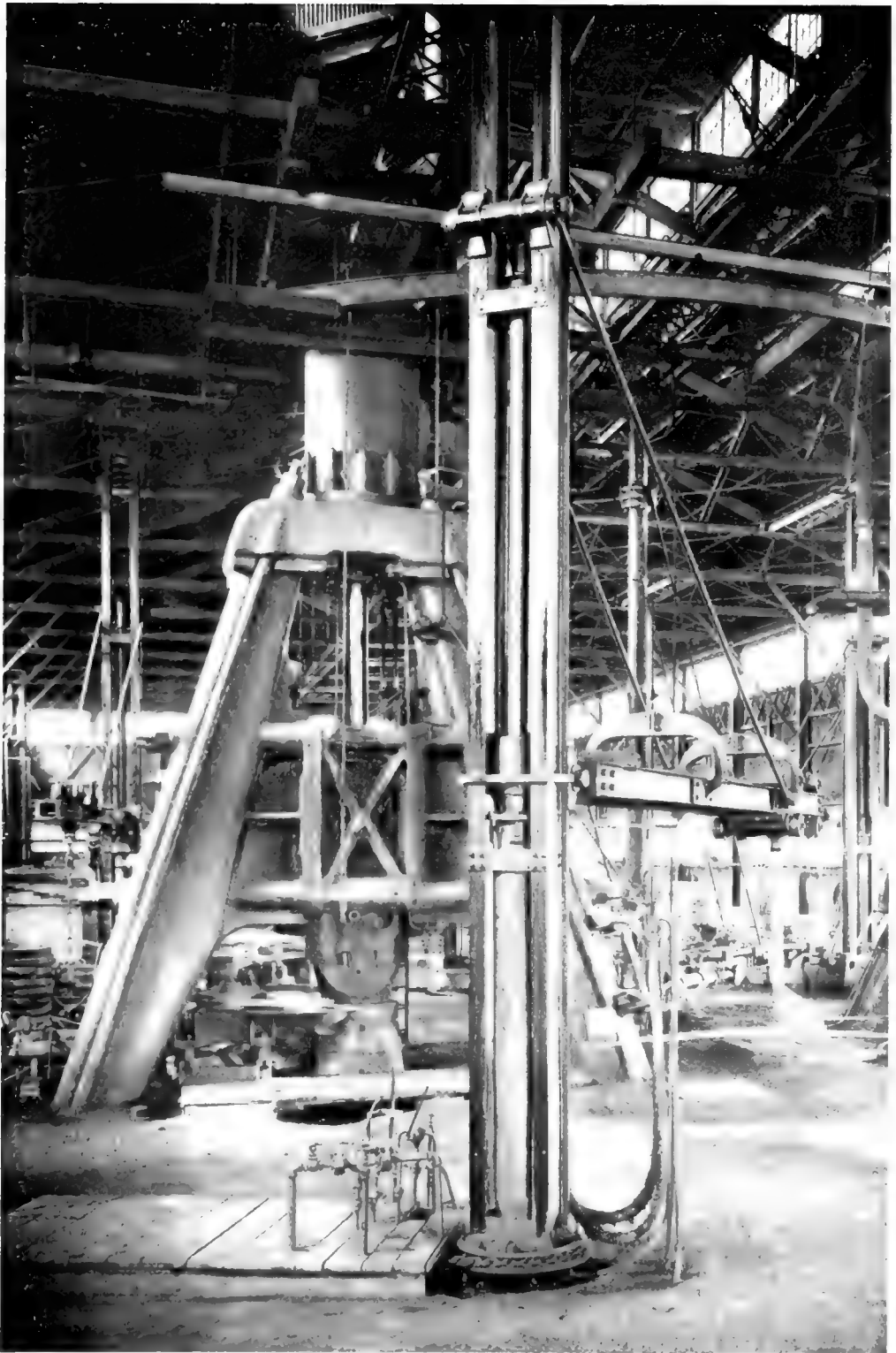

STEAM-HAMMER.

hand-wheel was able to rapidly alter the vertical height of the tappet-lever, and therefore the length of fall. The second point—i.e. the instant rise of the tup after the blow—was obtained in a very ingenious fashion by taking advantage of the inertia of a rocking lever carried on the tup. When the hammerhead struck the metal on the anvil, this lever, by virtue of its momentum, continued to move down against the resistance of a light spring, and in doing so set in motion a system of levers which at once opened the valve, admitted steam under the piston, and again raised the tup. The system of levers could also be operated by hand; thus steam could be admitted under the piston, and the hammer checked and stopped at any point of its descent. This gearing reduced enormously the labour of operating the hammer, increased greatly the number of blows which could be given in any time, and brought it so completely under control that while at one instant the tup could be brought down so gently that it failed to crack an egg on the anvil, the next blow could be made to shake the very ground on which the hammer stood with the violence of the shock. Such satisfaction was given by this remarkable tool that orders began at once to flow in from all parts of the country. The hammer remained in this condition, with slight improvements in details, till 1853, when Wilson devised and applied to steam-hammers what is known as the 'circular balanced valve,' in substitution for the flat slide-valve hitherto used. The steam-pressure on the back of the old flat valve was so great that the friction during any movement of the valve was excessive. This made the expenditure of power in opening and closing the valve very heavy and wasteful, and was one of the chief reasons for introducing the automatic device. By the use of the balanced circular valve the movements of opening and closing became so easy that they could be readily and rapidly made by hand-power, and as a result the somewhat complex automatic gear was abandoned, the mechanism being entirely operated by hand-gearing only. A patent was taken out for this in 1856.

The next improvement, made with the object of greatly increasing the power of the hammer without increasing the weight of the tup, was introduced in 1861 by Wilson. It is known as the *double-acting hand-gear motion*. In this arrangement steam is admitted under the piston as before to raise it; then just at the instant when the fall is about to take place, by slightly increasing the travel of the hand-lever, steam is admitted into the cylinder above the piston. The effect of this steam-pressure on the top of the piston is to enormously increase the intensity of the blow, and hence the capacity of the hammer, since the hammerhead will descend with much greater velocity, and therefore possess much more energy when it strikes. For example, a double-acting 5-ton hammer may become equal in power to a single-acting 10- or 15-ton one. It should be stated that steam-hammers are commercially rated by the weight of the falling tup, piston, and rod, even when they are fitted to be used as double-acting; so that the power of the blow is not known unless the range of fall is also stated, and whether it is single or double acting.

The figure shows the form of the modern simplified steam-hammer. They are often of great size; 80-ton ones have been made, double-acting, possessing therefore enormous power, as at Essen in Germany and Creusot in France, as well as in the United Kingdom; one in Pennsylvania, the largest made up till 1891, of 125 tons. Of recent years powerful hydraulic presses have been substituted for these big hammers for heavy forging work, but many engineers still prefer the hammering action.

In Condie's hammers, a patent for which was taken out in 1846, the piston is stationary, while the cylinder with the tup attached to it is the moving piece. Since the expiration of Nasmyth's patent great numbers of different types of hammers have been put on the market, but they differ from one another principally only in details, the general arrangement being the same. The modern

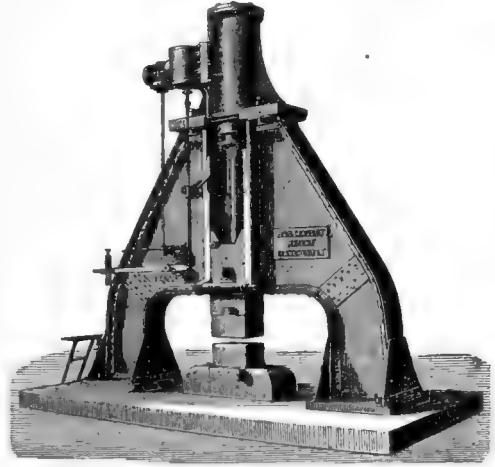

Steam-hammer, with Wrought-iron Framing.

double-acting hammer can usually be worked in four ways: (a) as a single-acting one, no steam being admitted above the piston, the falling weight therefore alone acting, and again the blow may be made a dead one or a cushioned and elastic one, the latter effect being obtained by admitting steam under the piston before the blow is finished to cushion the piston and cause the tup to rebound the instant it has struck; (b) as a double-acting hammer, by using steam-pressure above the piston during the fall, giving also either dead or elastic blows.

Steam-navigation. See SHIPBUILDING.

Steam-navy. See EXCAVATORS.

Steam-plough. See PLOUGH.

Stearin, $C_{18}H_{35}(O \cdot C_{18}H_{35}O)_2$, is one of the fats occurring in animals and plants. Like the other fats it may be regarded as an ether of the triatomic alcohol glycerine, all three hydroxyl molecules being replaced by radicles of the fatty acid—stearic acid, $C_{18}H_{35}O \cdot OH$.



It is the chief constituent of the more solid fats, such as mutton suet, and is characterised by its high melting-point—from 53° to 66° C.—by its slight solubility in alcohol as compared with palmitin and olein, and by its crystallising from its alcoholic solution in the form of brilliant quadrangular plates. Like the other fats it may be readily split into glycerine and a fatty acid, and if an alkali be present the acid combines with this to form a soap. Stearoptene is the crystalline solid substance which separates from volatile Oils (q.v.) on long standing or at low temperatures. For Physiology of Fats, see FATS. See also CANDLES.

Steatite, or SOAPSTONE, a compact or massive variety of Tale (q.v.), is a hydrous silicate of magnesia. It is found massive, or sometimes assuming the forms of the crystals of other minerals which it has replaced. It is plentiful in many parts of the

world, and is found in various parts of Britain. It is generally white, reddish white, or yellow. It is soft and greasy to the touch, easily cut, but broken with difficulty. It is used in the manufacture of porcelain. It writes readily on glass, and is used by glaziers for marking plates of glass before they are cut with the diamond. Tailors use it for marking cloth before they cut it. It is also used by shoemakers to give unctuousness to the heels of stockings that new boots may more easily be tried on. It is sold for such purposes under the names of Briançon Chalk, French Chalk, and Venice Tale. It readily absorbs oil or grease, and is used in powder for extracting spots of them from silken and woollen stuffs. It is the basis of Rouge (q.v.). It is used for imitating engraved stones, being easily cut, and afterwards hardened by heat; after which it may be coloured by metallic solutions. It also forms a polishing material for serpentine, alabaster, and glass. The so-called Agalmatolite or Pagodite of China, which is carved into images, miniature pagodas, &c., is usually not steatite but a variety of the mineral called Pinite. In other cases it is a compact variety of Pyrophyllite. Now and again it is steatite.

Steatornis. See GUACHARO.

Stedman, EDMUND CLARENCE, American poet and critic, was born at Hartford, Connecticut, 8th October 1833. He studied at Yale and early took to journalism, was war-correspondent of the *New York World* during the war, but ultimately became a stockbroker at New York. He contributed actively to the more important magazines, and published his first volume of verse in 1860. His critical work *Victorian Poets* appeared in 1875, and has gone through many editions. The *Poets of America* appeared in 1886, but naturally proved less interesting. The *Library of American Literature*, in 11 volumes, edited in conjunction with Ellen M. Hutchinson, was completed in 1890, and in 1895 was published *A Victorian Anthology*.

Steel. The discovery of a material which is capable of cutting and otherwise shaping nearly every other substance known to man, and which can be so modified in hardness as to be able also to easily cut and otherwise shape itself, was of sufficient importance to make a distinct epoch in the progress of the human race. Such a material is steel, which may be made nearly as hard as the diamond, or so soft that it can be cut, bent, or hammered into any shape, rolled into sheets, or drawn into wire even of hair-like thinness. It is composed of iron and carbon, but is not a true chemical compound of these substances. True chemical compounds have fixed and definite proportions of the elements composing them, but steel varies in all proportions from $\frac{1}{2}$ per cent. of carbon to $2\frac{1}{2}$ per cent. The more carbon the greater becomes the hardness of the steel, until a limit is reached owing to the brittleness which accompanies the hardness. The fusibility of steel increases with the amount of carbon. Ordinary steel contains a little silicon, manganese, sulphur, phosphorus, &c., but these are merely impurities. The removal of these, or their reduction to the smallest possible quantity, is very desirable, as upon such removal the quality of steel mainly depends. These impurities are derived partly from the iron ores and partly from the fuel used in smelting them. When a pure ore, such as the magnetic oxide of iron, and a nearly pure carbon, such as wood-charcoal, are used, the manufacture of steel of fine quality is very simple and easy. With such materials steel is made quite as easily as iron, the carbon of the fuel readily combining with the iron as it becomes reduced from the ore. The ancient iron-makers obtained their

steel in this way, and the ironmasters of the East, who still work in the primitive manner with small furnaces and much labour, do the same, but they are not able to accurately regulate the quantity of carbon in the steel and its consequent hardness.

Owing to the scarcity of these pure iron ores and the high cost of charcoal, they are but little used by the modern steel-maker, who adopts a very roundabout process, the true reasons for which have been much misunderstood. He first makes an impure steel (pig-iron or cast-iron) containing 3 or 4 per cent. of carbon, then he reduces this quantity to about $\frac{1}{10}$ per cent. or less in making malleable or wrought iron by puddling (see IRON), and afterwards by another expensive process restores about half as much carbon as he has taken away. Steel has been defined by high scientific authority as 'iron carbonised in degrees intermediate between malleable and cast iron,' a description that has led to a multitude of futile and costly attempts to produce steel by mixing cast and wrought iron together, and other similar devices for simply diminishing the proportion of carbon. Such devices would be successful if cast-iron were a compound or mixture of iron and carbon only; but ordinary cast-iron contains silicon, sulphur, and phosphorus in quantities that are ruinous to steel.

The modern maker of the best steel therefore uses the best puddled iron, preferably Swedish charcoal iron. He has it rolled into bars, usually 3 inches wide and $\frac{3}{4}$ inch thick, and 10 to 15 feet long, and submits these to a process which has received the name of cementing. The cementing-furnace is a circular brick structure terminating upwards in a wide truncated conical chimney of somewhat dome-like appearance, a familiar feature in the gloomy landscape of Sheffield. Fig. 1

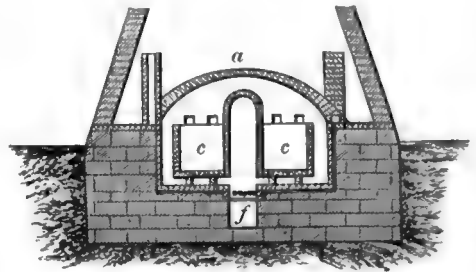

Fig. 1.

shows it in section with the upper part of the chimney cut off: *f* is the ashpit with the bars of the fireplace seen endwise above; *c, c* are two 'chests,' or converting pots, shown in section. These are made of firebrick or firestone, and supported over the fire, with flues so arranged that the flame and smoke shall pass up the arched space between them, and below and around their outer sides, so as to heat them all round as equally as possible. The smoke and lurid smoky flame after traversing these flues rise into the arch, *a*, which is thus heated and consequently radiates downwards to the upper side of the chests.

The chests, 15 to 18 feet long and $2\frac{1}{2}$ to 3 feet deep and same width, are charged by first spreading over the bottom a layer of coarsely-ground charcoal (from hard wood preferred) about 2 inches deep. Upon this is placed a layer of bars with a space of $\frac{1}{2}$ to $\frac{3}{4}$ inch between each. Over these bars and into the spaces between them is sifted another layer of charcoal to about an inch deep above the bars; then another layer of bars, and another of

charcoal, and so on, up to within 6 inches from the top. Then old 'cement powder'—i.e. charcoal already used, and grinders' waste—is moistened and plastered over this, and the whole covered with clay or moistened sand to exclude the air. All is now closed in excepting the ends of some extra long 'tasting bars,' which are allowed to protrude from the 'tasting' or testing holes. A glowing red heat is maintained for eight or ten days, when a tasting-bar is withdrawn to ascertain whether the carbon has penetrated sufficiently. When this is the case the furnace is allowed to cool slowly during another week or thereabouts. When the bars are withdrawn they are found to be coated with a sort of dark skin which is raised in blisters over a large part of their surface. It is by the appearance of these and by fracture that the quantity of carbon taken in and the depth of its penetration is ascertained. This transfusion or penetration of solid carbon into solid iron is a mystery, the theory of which has been much discussed, too much so for exposition here. An important practical fact is, however, connected with it—viz. that the distribution of the carbon is very unequal. Its quantity is greatest on the surface, and gradually decreases towards the interior. Therefore the steel in this state, 'blister steel,' is of little value on account of its irregularity of composition and consequent irregularity of hardness, &c. To remedy this the outsides and insides of the bars have to be stirred up and mixed together so as to give uniformity of composition to the whole.

The most obvious mode of doing this is to melt the whole and stir the fluid. This is done in making the very best quality of steel—'cast-steel' or 'pot-steel,' as it is called in Sheffield. The bars are cut into small pieces, melted in crucibles, and then poured from these into ingot moulds. Oxide of manganese and ferrocyanide of potassium are added in small quantities to the melted metal in the crucibles. The theory of the action of these additions has been much debated, and its discussion would occupy too much space for this article. The consumption of fuel, the labour, and the destruction of crucibles renders this melting an expensive process and the result correspondingly dear. A cheaper mode of mixing is adopted in the production of what is called 'shear-steel.' The blistered bars are cut or 'sheared' into short lengths; these are bound together into bundles or 'faggots,' raised to a welding heat—i.e. heated until they become sufficiently soft to be plastic, then placed under a

then rolled out into a long bar which is resheared into small pieces to form another faggot to be similarly treated. The reshearing, &c., may be repeated as often as demanded, and thus we have 'single shear,' 'double shear,' &c. None of these are so homogeneous as crucible steel, and they are therefore inferior in this respect.

A very important development of the manufacture of steel has followed the introduction of the 'Bessemer process,' by means of which a low carbon or mild cast-steel of inferior quality can be produced at about one-tenth of the cost of crucible steel. It is used for rails, for the tires of the wheels of railway carriages, for ship-plates, boiler-plates, for shafting, and a multitude of constructional and other purposes to which only wrought-iron was formerly applied, besides many for which no metal at all was used.

This process was originally based on the theory—then generally accepted—that steel is 'iron carbonised in degrees intermediate between malleable and cast iron;' and, as carbon is readily oxidised at a high temperature and thus converted into gaseous compounds, nothing further was supposed to be necessary for the conversion of cast-iron into steel than to blow through the melted cast or pig iron a sufficient quantity of air to burn out the redundant carbon and leave behind the proportion required for the production of steel. A large number of patents were secured, including various devices for doing this, and all failed. A sort of steel was produced, but it was unworkable. When hammered, either hot or cold, it either crumbled to pieces or split at its edges when flattened down. The sources of failure were twofold. The first was that ordinary pig or cast iron contains other impurities than carbon, notably silicon, sulphur, and phosphorus. The carbon was readily removed by oxidation, and gradually, as demanded by the theory; the silicon was also oxidised even more readily than the carbon, but the sulphur and phosphorus remained obstinately, even after nearly all the carbon was oxidised and the iron itself began to burn. The other difficulty was that of regulating the quantity of carbon, by stopping when the required quantity was removed by oxidation. This difficulty was overcome by Mr Robert Mushet, who used a compound of iron and much carbon of known composition (spiegeleisen), and added this in the quantity necessary to give to the whole the proportion of carbon required. Thus, if the spiegeleisen contained 5 per cent. of carbon, and 1 per cent. was required in the steel to be produced, spiegeleisen was added to the decarburated iron in the proportion of 1 to 4.

After considerable struggles the first difficulty was partially overcome by using only special kinds of pig-iron, those made from hæmatite ores which contain very little phosphorus. Mr Mushet's 'triple compound,' the spiegeleisen, also assisted here, as it contains a considerable amount of manganese, which exerts a purifying influence on steel. The rationale of this purification has been much debated; the experiments of the writer indicate that manganese acts by removing the last vestiges of silicon and particles of oxide of iron in the Bessemer converter. Its practical usefulness, however, is unquestionable. But the Bessemer steel even thus produced is far inferior to the crucible steel or shear-steel. There is still sufficient phosphorus in it to render it unfit for making tools with acute edges, or for files, saws, &c. If highly carburated its hardness is accompanied with brittleness that causes cutting-tools to notch, and toothed-tools, like saws and files, to strip. Phosphorus gives hardness of a glassy character.

The Bessemer 'Converter' is shown diagrammatically in section in fig. 3. It is a strong iron vessel lined with refractory material. The bottom,

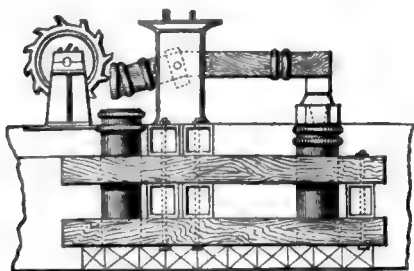

Fig. 2.

'tilt hammer,' shown in fig. 2. The tail of this hammer is struck by the cams of the revolving wheel, whereby the head is lifted, and falls again before the next cam comes into action. In this manner the faggot receives 300 to 400 heavy blows per minute, the rapidity of percussion fully maintaining the heat of the faggot, while its constituent pieces are welded into one coherent mass. This is

which is removable for renewal, is fitted with fire-cylinders, *cd, cd, cd, cd*, and each cylinder is perforated with several holes $\frac{1}{4}$ to $\frac{3}{8}$ inch in diameter. It is thus riddled with sixty to a hundred holes, according to its size. These perforations

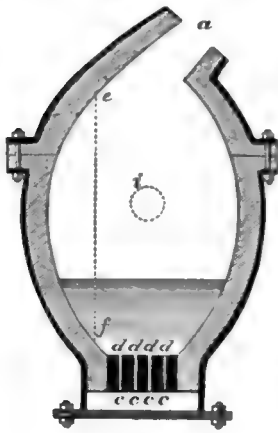

Fig. 3.

communicate by means of an air-chamber, *c, c, c, c*, with a powerful blowing-machine. The whole converter is mounted on an axis, *i*, and may be thereby turned as required. The lining is first made red-hot by burning coal within. When thus prepared ready for charging, the converter is turned on the axis, *i*, so that the line, *ef*, shall be horizontal. Molten pig-iron is then poured in at the mouth, *a*, and thus it forms a pool lying in the belly of the converter below the line, *ef*. The blast is now turned on, and the converter turned over to the position shown in the diagram, the melted metal standing over the hundred open holes. It cannot, however, run down these, as the blast of air rushes upwards with much greater force than that of the downward gravitation of the metal. The streams of air tear through the molten metal, and a huge flame roars furiously from the mouth of the converter. With this flame brilliant cascades of coruscating sparks are belched forth at irregular intervals, and the dazzling spray as it dashes against the wall of the flame-shaft rebounds with redoubled splendour. The blast still roars on monotonously, and the flame steadily increases in size and brilliancy, attaining its maximum at about the end of ten minutes. It continues thus for five or ten minutes longer, then the flame contracts. This indicates that the carbon is becoming exhausted, and that the iron, no longer protected by it, is beginning to burn. The converter is now turned to the position in which it was charged, and then the melted spiegeleisen is poured into it. A violent ebullition occurs immediately this mixes with the metal that has been blown, and a great waving blue flame of burning carbonic oxide silently pours out of the mouth of the converter.

Why this violent agitation, and whence comes this great outpouring of gas? The writer studied these questions experimentally when the Bessemer process was young, and found that the carbon is not all burned out, as was then supposed. There remained from $\frac{1}{4}$ per cent. to $\frac{1}{10}$ per cent. according to the prolongation of the blowing, and besides this there was a considerable quantity of black particles of oxide of iron in the blown metal before the spiegeleisen was added, but after this addition they disappeared. These facts answer the questions. The carbon of the spiegeleisen reduces the black oxide by combining with its oxygen, and this combination with oxygen produces the carbonic oxide. The manganese assists, for much of it disappears from the metallic product, and is found in the liquid cinder (or 'slag') combined with oxygen and silica. The blown metal, before the addition of the spiegeleisen, is 'rotten'; it breaks under the hammer whether hot or cold. If overblown it crumbles like sandstone.

One of the most remarkable phenomena of the Bessemer process is the intense heat to which the metal is subjected. It far exceeds that obtained in any other melting furnace. At first glance this may appear strange, as nothing but cold air is applied to the melted metal. But this metal is pig-iron containing silicon and carbon. Both of these are effective fuels when heated and supplied with oxygen. The manganese adds a little. In an ordinary charge of six tons of average material these fuel substances amount to about 8 cwt. They are all burned in the course of about twenty minutes, not outside a melting-pot, but within or amidst the melted metal itself; and thus the heat of this extraordinary amount of combustion in so small a space is rendered exceptionally effective. After the spiegeleisen is all added and well admixed by the agitation it produces, the liquid steel is poured into ingot moulds of suitable sizes according to its purpose, and these are wrought by hammering, rolling, &c. as required.

Owing to the phosphorus contained in ordinary Bessemer steel, it will rarely bear as much as 1 per cent. of carbon without becoming worthless brittle, and therefore only mild or low carbon steel is made from it for purposes already stated. Messrs Thomas and Gilchrist have succeeded in removing the most of this residual phosphorus by lining the converter with a basic material, a refractory substance in which lime and magnesia preponderate. These bases eagerly combine with phosphoric acid at high temperatures, and by their predisposing affinities assist the phosphorus in combining with the oxygen of the blast to become the phosphoric acid which they demand. The phosphates of lime and magnesia thus obtained are valuable manures. The practical value of the basic process depends mainly on its rendering impure pig-iron available.

The 'Siemens-Martin process' is now competing very effectively with the Bessemer process. It consists essentially in first obtaining a bath of melted pig-iron of high quality, and then adding to this pieces of wrought-iron scrap or Bessemer scrap, such as crop ends of rails, shearings of plates, &c. These, though practically infusible in large quantities by themselves, become dissolved or fused in such a bath if added gradually. To the bath of molten metal thus obtained spiegeleisen or ferromanganese is added to supply the required carbon and to otherwise act as already described in the Bessemer converter. The result is tested by small ladle samples, and when it is of the desired quality a portion is run off, leaving sufficient bath for the continuation of the process.

It is evident that here a high degree of purity is attainable by selection of the scrap, which may be of high quality wrought-iron from which the impurities have been removed by puddling. Very fine samples of 'homogeneous metal' have thus been obtained, resembling wrought-iron in softness and toughness, with some degree of the high tenacity of cast-steel. Where qualities like those of ordinary Bessemer metal are required, this process supplies an economical method of melting up and utilising such materials as old Bessemer rails, &c.

Tempering.—The special property upon which the great value of steel depends is that of being capable of acquiring various degrees of hardness. These are obtained by what is commonly called 'tempering,' which really includes two processes—(1) hardening and (2) tempering properly so called. If a piece of steel containing $\frac{1}{2}$ per cent. of carbon and upwards is made red-hot and then suddenly plunged into cold water, or otherwise rapidly cooled, it becomes hardened in proportion to the quantity of carbon it contains. In this condition it is of very little use, as it becomes brittle in proportion to its hardness; but

this brittleness and extreme hardness may be tempered by reheating in various degrees according to the degree of hardness required. This is the tempering process properly so called.

The workman has discovered a simple and elegant means of determining the temperature attained in this reheating. A film of oxide is formed, and as this thickens its colour changes as shown in the table below. Another method of fixing the temperature is by immersing the tool in a bath of fusible metal or alloy just at its melting-point, which melting-point varies with the composition of the alloy. A third is to smear the surface with tallow and watch the result. The following table shows these results, the temperature at which they occur, and the alloys that may be used.

Colour.	Temperature.	Alloy.	Effect on Tallow.
1. Pale straw... .420° F.	7	lead 4 tin	Vaporises.
2. Straw.....450°	8	" 4 "	Smokes.
3. Straw yellow...480°	8½	" 4 "	More smoke.
4. Nut brown...500°	14	" 4 "	Dense smoke.
5. Purple.....530°	19	" 4 "	Black smoke.
6. Bright blue...580°	48	" 4 "	Flashes if light is applied.
7. Deep blue...590°	50	" 2 "	Continuous burning.
8. Blackish blue.640°		{ All lead or boiling lin- seed-oil. }	All burns away.

Long exposure to the temperatures named has an effect similar to that of a higher temperature. The usual practice is to plunge the article into cold water immediately the required temperature is reached, and the above table is based on this practice. Varying temperatures, or degrees of softening or 'letting down,' are demanded according to the purposes for which the tool is used. No. 1—pale straw—is the temper for tools used in cutting iron and steel, for lancets and some other surgical instruments. Nos. 2 and 3 for tools used in cutting brass. No. 3 for penknives and tools of this class. No. 4 for scissors, stone-masons' chisels, and the strongest tools used for cutting hard wood. No. 5 for table-knives, clasp-knives, and ordinary edged tools for cutting soft wood. No. 6 for swords, bayonets, axes, &c. No. 7 for watch-springs, needles, fine saws, and other tools where elasticity is demanded. This is called 'spring-temper.' No. 8 for common wood-saws, and other tools used for soft material. Steel is softened by heating to redness and cooling very slowly (see ANNEALING). See *The Chemistry of Iron and Steel Making*, by the present writer (1890).

Steelbow (a word of doubtful origin), in Scots law, means goods, such as corn, cattle, straw, and implements of husbandry, delivered by the landlord to his tenant, by means of which the latter is enabled to stock and labour the farm, and in consideration of which he becomes bound to return articles equal in quantity and quality at the expiration of the lease.

Steele, SIR RICHARD, the father of the Queen Anne essay, was born in Dublin in March 1672 (n.s.), and was there baptised at St Bridget's Church. His father, Richard Steele of Mountain (Monkstown), was an attorney; his mother had been a widow named Elinor Symes. His father died when he was a child (*Tatler*, No. 181). Mrs Steele did not long survive her husband, and the boy fell to the charge of an uncle, Henry Gascoigne, secretary to the first Duke of Ormond. Through Ormond's influence, in November 1684 Steele was placed upon the foundation at the Charterhouse, where he had Addison, his junior by six weeks, for contemporary. In December 1689 he entered Christ Church College, Oxford, and in March 1690 he matriculated. He tried hard for a Christ Church studentship, but eventually (in 1691) gained a post-mastership at Merton. At the university he was popular and respected, but in 1694 he suddenly

enlisted as a cadet in the second troop of Horse Guards, then commanded by the second Duke of Ormond, thereby surrendering, according to his own account, some rather vaguely described expectations as a Wexford landowner. Already at college a dabbler in verse, in 1695 he made his appearance as a printed poet by *The Procession*, a conventional effusion on the funeral of Queen Mary, which he dedicated to John, Lord Cutts, who forthwith made him his secretary, and finally gave him a standard in his own regiment of Coldstream Guards. In June 1700 he became involved in a duel with an Irishman named Kelly, whom he had the misfortune to wound severely. One outcome of this occurrence was the production of the devotional manual known as *The Christian Hero*, which was written at the Tower Guard, and published in April 1701. With the public it was popular, but, as might be anticipated, it was regarded by Steele's military comrades as incompatible with his calling as a 'gentleman of the army.' 'From being thought no undelightful companion,' he 'was soon reckoned a disagreeable fellow;' and the necessity to 'enliven his character' drove him to the odd expedient of writing a play. This, *The Funeral; or, Grief à la Mode*, was acted at Drury Lane in December 1701. It was followed in 1703 by *The Lying Lover*, and in 1705 by *The Tender Husband*. About this time, it is supposed, being now a captain in Lord Lucas' Regiment of Foot, he engaged in certain researches for the 'philosopher's stone,' the details of which rest mainly upon the authority of that 'cornucopia of scandal,' the *New Atalantis* of Mrs De la Rivière Manley, although the fact of the researches is not denied. Their failure is practically synchronous with his marriage to a widow named Margaret Stretch (with estates in Barbadoes). The marriage took place in 1705, and the lady died two years later. In August 1706 Steele was appointed gentleman-waiter to Queen Anne's consort, Prince George of Denmark; and a few weeks after his wife's death, upon the recommendation of Arthur Mainwaring (who, like Steele, was a member of the Kit Cat Club), he was appointed by Harley, then a Secretary of State, to the post of Gazetteer, the annual salary of which was increased to £300. By this time, it is presumed, he had quitted the army; but he continued to be spoken of as 'Captain' Steele. The next notable occurrence in his life was his second marriage, in September 1707, to the beautiful Miss Mary Scurlock, the daughter of Jonathan Scurlock, deceased, of Llangunnor in Carmarthen, and the 'Prue' of her husband's correspondence. Shortly afterwards, by the death of Prince George, he lost his court appointment. Then, without much warning, appeared on the 12th April 1709, the first number of the famous tri-weekly paper known as the *Tatler*, the putative author of which was one 'Isaac Bickerstaff,' a pseudonym borrowed from Swift. In January 1710, during the course of the *Tatler*, Steele was made a commissioner of stamps, and for some obscure reason was deprived of his gazetteership. The *Tatler* came to an end on 2d January 1711, to be succeeded in March by the more famous *Spectator*, which ceased 6th December 1712. To the *Spectator*, in March 1713, followed the *Guardian*. In all these enterprises Steele enjoyed the aid, as a contributor, of his friend and schoolfellow Addison—an aid the incalculable value of which he acknowledged with loyal cordiality. 'I fared (he said) like a distressed prince, who calls in a powerful neighbour to his aid; I was undone by my auxiliary; when I had once called him in, I could not subsist without dependence on him' (Preface to *Tatler*, vol. iv.).

In beginning the *Guardian* Steele had made prudent profession of abstinence from political

questions. But the moment was not favourable to restraint, even for less earnest men. From his youth he had been an ardent adherent of the Revolution, and now, as it was thought, the Hanoverian succession was in jeopardy. Before April 1713 he was involved in a bitter quarrel with Swift. Then the disquieting rumours that the demolition of the Dunkirk fortifications, which was provided for by the treaty of Utrecht, would not be insisted on drew from him an indignant pamphlet entitled *The Importance of Dunkirk consider'd*, to which Swift, on the other side, grimly retorted with *The Importance of the 'Guardian' consider'd*. Steele in the meantime had resigned his commissionship of stamps, and entered parliament as member for Stockbridge, concurrently dropping the *Guardian* for the professedly political *Englishman*. Shortly afterwards he published *The Crisis* (1714), a pamphlet on the Hanoverian succession, to which Swift replied with matchless irony by *The Publick Spirit of the Whigs*. When Steele actually entered upon his duties in the House he found he was a marked man. He was promptly impeached for seditious utterances in *The Crisis*, and, although he made a capable defence, was expelled. But with Anne's death, a few months subsequently, his party came into power and his troubles ended. In his best pamphlet, *Mr Steele's Apology for Himself and his Writings* (1714), he has given his own account of this part of his career.

That career, as far as literature is concerned, practically closed at this point. He again became a member of parliament, being returned for Boroughbridge; and a little later, upon presentation of an address to King George I., was knighted. He continued to produce periodicals and pamphlets, none of which are of great importance, though one of them, *The Plebeian*, had the effect of involving him in a painful controversy with his friend Addison. He was made a patentee of Drury Lane Theatre, where in 1722 he produced *The Conscious Lovers*, his best comedy. He also established the *Censorium*, a sort of æsthetic music-hall; and he devised an impracticable 'fish-pool' or well-boat for bringing salmon alive from Ireland. In December 1718 he lost his wife. He survived her for nearly eleven years, dying ultimately, 1st September 1729, at Carmarthen, where he was buried in St Peter's Church. Of his four children only two were living at his death. His daughter Mary soon followed her father; and the remaining and eldest child, Elizabeth, married a Welsh judge, afterwards the third Lord Trevor of Bromham.

Steele's character has suffered from various causes, among which may be reckoned the animosity aroused by his political writings, the careless candour of his own admissions of frailty, and the habitual comparison of his weaknesses with the colder and more equable goodness of Addison. He has been specially branded as intemperate, but there is no sufficient evidence why in this respect he should be singled out from his contemporaries. That he was incurably sanguine, and that he constantly mistook his expectations for his means, is manifest from his lifelong embarrassments. But these were the result of an improvident temperament and an uncertain income rather than of a vicious habit of mind; and he made a noble and successful attempt to pay his debts before he died. Upon the whole he was a warm-hearted and benevolent man, a devoted husband (some of his letters to his wife are among the most unfeigned in the language), a loving father, and a loyal friend.

As a literary man he may be more exactly estimated. Though he wrote verse, he has no claims as a poet. His plays are commendable efforts in the direction of the stage-purification advocated by Jeremy Collier; but their feeling for humorous

character is more notable than their stage-craft, and they have never kept the boards. His political pamphlets were honest and straightforward, but not effectively polemical; and he had a terrible enemy in Swift, who as a former friend had learned his adversary's weakest side. His fame rests almost wholly upon his performances as an essayist. And here he was by no means the colourless colleague of Addison that is sometimes supposed. On the contrary, he was nearly always the fore-running and projecting spirit, and his ready sympathies and quick enthusiasm occasionally carried him to an altitude which Addison never attained. If he wanted Addison's restraint, his distinction, his exquisite art, he nevertheless rallied folly with admirable good-humour, rebuked vice with unvarying courage and dignity, and earned for himself the lasting gratitude of the 'beautiful sex,' as he called them, by the chivalry, the manliness, and the genuine respect with which, almost alone in his age, he spoke of women.

Steele has been written of by Macaulay (*Edinburgh Review*, 1843) and Thackeray (*English Humourists*, 1858), but most sympathetically by John Forster (*Quarterly Review*, 1855). In 1886 a Memoir of him, containing some new facts, was issued by the present writer in the 'English Worthies' series; and in 1889 followed a detailed Biography by Mr G. A. Aitken, embodying the results of prolonged and minute researches. A selection from Steele's Essays, with notes, was issued in 1885 by the Clarendon Press.

Steele, SIR JOHN, R.S.A., sculptor, was born at Aberdeen in 1804, the son of a carver and gilder. He received his education as an artist at the Edinburgh Academy, and afterwards at Rome. In 1832 he modelled 'Alexander and Bucephalus,' which, however, was not cast in bronze until 1883, being erected in Edinburgh the year after. The promise of this early work he subsequently fulfilled. Most of his chief works are in Edinburgh: the colossal figure of the Queen crowning the front of the Royal Institution, which procured him the honorary appointment of Sculptor to Her Majesty in Scotland; the statue of Scott in the Scott Monument; the equestrian statue of the Duke of Wellington (1852); statues of Professor Wilson, Allan Ramsay (1865), and Dr Chalmers (1878); and the equestrian statue of Prince Albert, at the inauguration of which in 1876 Steele was knighted. Other works, in bronze or marble, are statues of Admiral Saumarez in Greenwich Hospital; of the Marquis of Dalhousie at Calcutta; of Sir Walter Scott (1872) at New York; and of Burns at New York (1873), Dundee, and London. He died 15th September 1891.

Steeltown, a borough of Pennsylvania, on the Susquehanna River, 4 miles by rail SE. of Harrisburg, with large Bessemer steel-works. Pop. (1880) 2447; (1890) 9250.

Steelyard. See BALANCE.

Steen, JAN, Dutch painter, the son of a Leyden brewer, was born in that city in 1626, went (it is believed) to Haarlem about 1644 and studied under Adrian van Ostade, joined the Leyden guild of painters in 1648, for some time carried on the trade of a brewer at Delft, and died in his native city in 1679. Steen was a painter of the same stamp as Rembrandt. A sympathetic observer of human life, he painted genre-pictures from every plane of life, the lowest as well as the highest. Although there is a decided ethic leaven in his work, it is softened by the spirit of sympathetic toleration and lightened by the play of comedy. The grave humour of his style is best seen in such pictures as the 'Doctor Visiting his Patient,' a 'Cavalier giving Lessons on the Guitar to a Lady,' 'Domestic Life,' 'Tavern Company,' 'The Oyster Girl,' 'Work and Idleness,' 'Bad Company,' 'Old

Age,' and particularly the pieces of childhood (e.g. the pictures called 'St Nicholas' and 'Twelfth Night'). See F. Wedmore in *Temple Bar*, vol. li.

Steenstrup, JOHANNES IAPETUS SMITH, zoologist, was born at Vang in Norway on 8th March 1813, taught on mineralogical subjects at Sorö in Denmark, and from 1845 to 1885 was professor of Zoology at Copenhagen and director of the zoological museum. His books treat principally of hermaphroditism in nature, alternation of generations, flounders' eyes, and Cephalopods. He also took a keen interest in exploring turf-moors and kitchen-middens. He died 20th June 1897.—His son, JOHANNES STEENSTRUP (b. 1844), professor of Northern Antiquities at Copenhagen, has written on Viking life and times, *Normannerne* (1876-82), and other works on Danish archaeology and ancient literature.

Steeplechase, a horserace run not on a course of smooth, flat turf, but across the open country, over hedges, ditches, walls, and whatever other obstacles lie in the way. This variety of sport seems to have had its origin (traditionally) in the frolic of a merry party of foxhunters, who agreed to race in a straight line towards a steeple visible in the distance, an event which is recorded to have happened in Ireland in 1803; further particulars of it, however, are not known. Nevertheless this was not the earliest race of the kind. One took place in Ireland in 1752 from the church of Buttevant (Cork county) to the church of St Leger, a distance of 4½ miles. In the year 1816 a ride in England of 20 miles across country against time (under one hour and nine minutes) was regarded as something extraordinary, although about that time steeplechase matches were coming into fashion with the young foxhunters of the day. The sport began to assume its existing shape about the year 1831. In 1866 the Grand National Hunt Committee was formed for the purpose of laying down rules and regulations for the proper conducting of steeplechase meetings. The principal race in this class of sport in the United Kingdom is the Grand National, which was instituted at Liverpool, the headquarters of steeplechasing, in 1839; it is now run on different courses in different years. Among the more important steeplechase meetings are those of Liverpool, Newport Pagnell, St Albans, Aylesbury, Lincoln, Brocksby, and Leamington. Steeplechase races have always been greatly in favour in Ireland. See A. Coventry and A. E. T. Wilson in the volume on *Horsereading and Steeplechasing* (1889) in the 'Badminton' series.

Steeple-Jack is the popular name for a stonemason or plumber who makes it his business to repair steeples and chimney-stalks. See article in *Chambers's Journal*, 1890.

Steering is the act of maintaining or altering the direction in which a vessel is proceeding. This control of a vessel's direction is usually effected by a stern rudder, which, as ordinarily fitted, swings on the vessel's stern-post, and can be set at any required angle with the vessel's fore and aft line. The rudder is turned by what is in effect a lever called the *tiller*, or *helm*, which is secured to the rudder-head, and either projects forward from the rudder-head (as is often the case in boats and small vessels) or projects aft from the rudder-head (as in most large vessels). The tiller may in some cases be grasped and turned by hand; but in general a wheel with axle and wheel chains is used to turn the tiller. Where steam-steering gear is fitted it is controlled by a small steering-wheel. When on board a vessel and looking forward—i.e. towards the bow—the right-hand side of the vessel is called the *starboard* side, and the left hand the *port* side. The port side was formerly called the *larboard*

side. The order 'port the helm' demands that the after part of the stern rudder should be swung round towards the *starboard* side of the vessel. Where there is a free tiller projecting forward from the rudder-head this is, of course, accomplished by moving the free end of the tiller towards the *port* side of the vessel, and this gave rise to the terms of the order. Where a wheel is used the intermediate gearing is usually so fitted that to 'port the helm' the top spoke of the wheel must be pulled down towards the *starboard* side of the ship. The effect produced in the way of turning the vessel where 'the helm is ported' is as follows: in the case of a sailing-vessel or of other vessels whose propellers are not placed at or near the stern, the hull is turned so that the head of the vessel appears to turn towards its own starboard side when the hull is moving ahead, and towards its own port side when the hull is moving astern; but in the case of vessels whose propelling apparatus works in the water at or near the stern, the first turning effect named is produced when the propeller (and not necessarily the hull) is going ahead, and the second turning effect is produced when the propeller (and not necessarily the hull) is going astern. The effect of the order to 'starboard the helm' is precisely the opposite of all this. The sailors of some foreign nations obey these orders by putting the wheel the opposite way to the above (the British) usage.

The kind of rudder called the 'balanced rudder' has about one-third of its area before the axis about which the rudder rotates. *Bow rudders*, as well as stern rudders, have been fitted to river-boats, telegraph-laying vessels, ferry-boats, &c., where such vessels are required to run with either end first. In this case one rudder is locked while the other is in use. *Two rudders astern* have also been recently tried with good effect. In regard to the effect produced upon the steering by the propeller or propellers, the adoption of twin screw-propellers, one on each side of the mid-ship line, has enormously increased the rapidity of steering by working one propeller only, or by simultaneously working one ahead and the other astern. A single screw-propeller has of itself a twisting action on the hull, more especially when the propeller is going astern, the effect being in the latter case to apparently turn the ship's head towards her own starboard side with a right-hand propeller, and towards her own port side with a left-hand propeller. In all these cases, while it is usual to speak of the rudder, propeller, &c. turning the ship's head, it is probable that most of the turning effect is the result of the ship's stern turning the opposite way from the apparent direction in which the ship's head turns. For steering racing and other boats, see ROWING, p. 10. See also BOAT, YACHT, RULE OF THE ROAD.

Stevens, GEORGE, Shakespearian commentator, was born at Stepney in 1736, the son of an East India Company director, and became a foundation at Eton and scholar of King's College, Cambridge. He was kept in hot water all his days through his meddlesome and sarcastic temper and his dishonourable habit of making bitter attacks on his friends from behind the anonymity of newspapers like the *St James's Chronicle* and the *Critical Review*. Johnson's judgment was almost too lenient when once, in reply to Beauclerk's assertion 'He is very malignant,' he said, 'No sir, he is not malignant. He is mischievous, if you will. He would do no man an essential injury; he may indeed love to make sport of people by vexing their vanity.' At another time Johnson hit him off in the phrase, 'He lives like an outlaw.' Another favourite trick of Stevens was to set up mock commentators, as Anner and Collins, on

whom to father dirty annotations he did not wish to own. Steevens died at Hampstead, 22d January 1800, and was buried at Poplar under one of Flaxman's monuments. He began his literary life in 1766 with a reprint from the original quartos of *Twenty of the Plays of Shakespeare* (4 vols.). This work caused him to be employed as collaborator with Johnson in his edition (1773). Of this latter work a second edition appeared in 1778, to which Malone had contributed, and the latter printed in 1780 by way of supplement the doubtful plays and the poems, an act of independence which the jealous Steevens could not endure. Steevens now set to work, with the help of Isaac Reed, upon a completely new edition of Shakespeare (1793; 1803), in which 'instead of a timid and servile adherence to ancient copies,' is adopted the 'expulsion of useless and superfluous syllables, and an occasional supply of such as might fortuitously have been omitted.' This doctored text held its authority till the publication of Malone's posthumous edition, the famous *Variorum Shakespeare* (ed. by Boswell, 21 vols. 1821). In his great edition Steevens did not print the poems of Shakespeare, 'because the strongest act of parliament that could be framed would fail to compel readers into their service.'

Stein, CHARLOTTE VON, the intimate friend of Goethe (q.v.), was born at Weimar on Christmas Day 1742, and married in 1764 to the Duke's Master of the Horse. Her friendship with Goethe was broken suddenly after the poet's return from Italy (1788). They were, however, in some measure reconciled before Frau von Stein died, at Weimar, on 6th January 1827. Goethe's Letters to her were first published in 1848-51, and again, with additions, in 1883-85; and another final collection was issued by the German Goethe Society in 1886. The lady's letters to Goethe were destroyed by her shortly before her death.

See Höfer, *Goethe und C. von Stein* (1878), and Düntzer's defence of her, *C. von Stein* (1874).

Stein, HEINRICH FRIEDRICH CARL, BARON VOM, Prussian statesman, was born at Nassau on 26th October 1757. He prepared himself for public life at Göttingen (1773-77), and entered the service of Prussia in 1780. In four years he had risen to be the administrative head of the mines in Westphalia, and in 1796 was appointed president of the Westphalian chambers. In 1804 he was summoned to take charge of the department that had the control of the excise, customs, manufactures, and trade; but though he succeeded in getting the restrictions on internal commerce abolished, and effected some minor improvements, he was unable to modify the traditional and favourite methods of governing current in Prussia. At length the king and his minister could no longer work together, and Stein tendered his resignation (January 1807). Whilst living in retirement at Nassau he wrote an essay on administrative reform, in which he outlined the measures which he subsequently carried into effect. After Frederick-William III. had drunk the bitter dregs of his policy in the treaty of Tilsit, he saw no other alternative except to recall the man whom he had so despitely used, especially as this step was recommended to him by his conqueror Napoleon. Accordingly Stein resumed office before the year ran out. He at once set to work with the swiftest energy, and in little more than a twelvemonth wrought such changes as laid the foundations of Prussia's subsequent greatness. His aim was to root the sovereign power in the hearts and wills of the people, and to make them free and responsible political actors. To this end he promulgated measures which abolished the last relics of serfdom, did away with the privileges of caste, freed the

sale and purchase of land from the rusty shackles of feudalism, created on the lands of the crown a class of peasant proprietors, and abolished all monopolies and other hindrances to free trade. At the same time he framed a scheme of municipal government which liberated the citizens from the military bureaucracies, and he warmly supported Scharnhorst (q.v.) in his schemes of army reform, which converted the Prussian troops into a disciplined body of citizen-soldiers. Other wide-reaching reforms he was unable to carry out himself, because Napoleon, at length realising the character of the man he had recommended, insisted upon his dismissal, and even confiscated his family estates in Westphalia. Stein quitted (November 1808) his post and withdrew to Austria, but not before issuing his *Political Testament*, a forecast of the changes Prussia needed to undergo. Not feeling himself quite secure in Austria, he accepted an invitation to St Petersburg (1812), and, although he refused to enter the czar's service, he was actively instrumental in cementing the coalition against Napoleon, and in animating the Germans in their final uprising. From the momentous battle of Leipzig to the Congress of Vienna he was the ruling spirit of the opposition against Napoleon. After the congress closed, Stein, who was dissatisfied with its conclusions, gradually withdrew into private life; a period of tranquillity and especially of reaction, like that which soon set in in Prussia, was not suited to a man of his strong and downright character. The principal fruit of his leisure was the establishment (1819) and organisation of the society that has printed the great collection of historical documents known as *Monumenta Germaniae Historica*. Stein died at his country-seat of Kappenberg in Westphalia on 29th June 1831, the last male of his race, as he left only daughters by his wife, a granddaughter of George II. of England.

See Pertz, *Leben des Ministers Freiherrn vom Stein* (6 vols. 1849-55); Professor Seeley's *Life and Times of Stein* (3 vols. Camb. 1878); and the *Erinnerungen of General von Boyen* (1891).

Steinbock. See GOAT, ANTELOPES.

Steinkerck, or STEENKERKE, a village in the Belgian province of Hainault, 5 miles N. of Soignies, was the scene of William III.'s defeat by the French under Marshal Luxembourg, on 3d August 1692. Pop. 860.

Steinmetz, CARL FRIEDRICH VON, Prussian general, born at Eisenach on 27th December 1796, fought through the campaign of 1813-14, winning the iron cross for valour, and in the war of 1866 routed three successive Austrian corps (June 27-29). On the outbreak of the Franco-German war of 1870 he was put in command of the right wing of the German advance; but he proved unequal to the task committed to him, especially at Gravelotte, and after that battle was nominated governor-general of Posen and Silesia. He died at Bad Landeck on 4th August 1877.

Steintal, HEYMANN, was born at Gröbzig in Anhalt, 16th May 1823, studied philology and philosophy at Berlin, and from 1850 became a lecturer in the science of Language and Mythology. The years 1852-55 he gave to the study of Chinese at Paris, and in 1863 became an extra-ordinary professor of the science of Language at Berlin, from 1872 also lecturing at the Jewish High School on Old Testament criticism, ethics, and the philosophy and history of religion. His writings bear the stamp of a powerful intellect and of learning remarkable at once for profundity and width of range. His method shows the influence of W. von Humboldt, whose philological works he edited (1884). He died 14th March 1899.

Among his works are *Der Ursprung der Sprache* (1851); *Klassifikation der Sprachen* (1850), worked up later into the important book, *Charakteristik der hauptsächlichsten Typen des Sprachbaues* (1860); *Die Entwicklung der Sprache* (1852); *Grammatik, Logik, Psychologie* (1855); *Geschichte der Sprachwissenschaft bei den Griechen u. Römern* (1863); *Die Manden-Negersprachen* (1867); *Allgemeine Ethik* (1885), &c. With Lazarus he edited from its foundation in 1860 the *Zeitschrift für Völkerpsychologie und Sprachwissenschaft*.

Stella. See SIDNEY (PHILIP), and SWIFT.

Stellaland, a short-lived South African republic, formed in 1882 by the Boer adventurers who supported Massouw, a chief of the Batlapins, against his rival Mankoroane, who relied upon the British. In 1884 the British government assumed the administration of the country, and in the following year annexed it and incorporated it in the new colony of Bechuanaland (q. v.). The chief town is Vryburg, which is connected by rail with Kimberley.

Stellenbosch, a South African town (pop. 4000), in a fertile vine-clad valley, 25 miles E. of Cape Town by rail, with an important college affiliated to Cape Town University.

Stellerine. See RHYTINA.

Stelvio Pass (Ger. *Stilfserjoch*), the highest carriage-road across the Alps (9042 feet), leads from Bormio in the Valtelline for over 30 miles to the Vintehgau in Tyrol. It was completed by the Austrian government in 1825.

Stem, the ascending axis of a plant, which usually bears leaves and flowers, and maintains communication between the roots and the leaves. In the *Thallophytes*—seaweeds, liverworts, &c.—no stem is differentiated; it begins among the mosses, grows stronger in the ferns, horsetails, and club-mosses, and attains its highest development in such trees as pine, palm, and oak. In these trees and in all other *Phanerogams* the stem results from the growth of the embryonic plumule.

Stems vary greatly in general habit; they may be upright and unbranched as in palms, or upright and much branched as in the oak; they may be scramblers as in the bramble, or twiners as in the hop, or climbers as in the ivy and Virginian creeper; they may be prostrate as in the strawberry, or underground root-like 'rhizomes' as in the Iris. Their usual function of lifting the leaves and flowers off the ground into the fresh air and sunlight may thus be lost, or subordinated to some other function, such as storage of nutritive material, as in the 'corns' of the crocus and 'tubers' of the potato, or storage of water, as in some succulents. When the rind is green it may assimilate as leaves do, and this is very important in such stems as those of cactuses, whose leaves are reduced to spines. It may also happen that branches of the stem are modified into flattened, leaf-like phyllodes as in *Ruscus*, into thorns as in the hawthorn, into tendrils as in the vine.

The stem is in many ways markedly contrasted with the descending axis or root, but few of the distinctions are rigid. Thus, most stems have some chlorophyll, which is absent from roots except perhaps in the case of one or two of aerial habit. Stems usually bear leaves, which roots never do. The tip of a stem is almost invariably a naked-growing point, while that of a root is usually protected by a root-cap. The branches of a stem arise as superficial outgrowths (exogenous buds), while rootlets arise endogenously from rudiments which develop in an internal layer known as the pericycle. The stem has a persistent tendency to grow upwards, while the root seeks the centre of the earth, and in regard to other forces than that of gravity, stem and root usually behave in opposite ways (see PLANTS, MOVEMENTS OF).

In describing aerial stems we distinguish the nodes from which the leaves arise from the intervening internodes, the buds which appear in the axils of leaves from that which forms the apex, or from those which appear arbitrarily or adventitiously, the leaf-bearing branches from the flower-stalks, and so on. The branching of the stem is usually lateral, but there are divergent forms, such as false dichotomy in the mistletoe, false axis in the vine, or true dichotomy in some Lycopods (see BRANCH).

In order to present a clear picture of the internal structure of a stem, it will be convenient to restrict our attention in the first place to the young twigs of some Dicotyledonous tree, such as the oak.

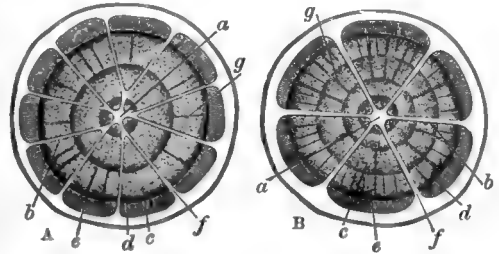

Fig. 1.—Diagrammatic cross sections of a young Dicotyledonous Stem:

A, a two-year old stem; B, a three-year old stem; a, pith; b, primary medullary rays; c, wood, in two layers in A, in three layers in B; d, cambium ring; e, bast; f, cambium (interfascicular) between the bundles; g, secondary medullary rays.

Every one knows that it is easy to peel off the 'bark' and to leave the white wood bare. This is possible because the region known as the bark is separated from the internal wood by a cylinder of delicate, readily ruptured, actively dividing cells—the 'cambium.' When a ring of bark is cut off a tree, the leaves do not wither; therefore we conclude that the water which ascends from the roots passes up by the wood. But if in the 'ringing' the young wood be also cut, the leaves wither rapidly; therefore it is by the young wood that the water ascends—a conclusion corroborated by the fact that a tree may flourish well although its heart-wood has rotted away. But the wood includes many different kinds of elements—long vessels, tracheide cells, wood-parenchyma, and wood-fibres. It is certain that the younger tracheides and vessels are the paths for the ascent of the water. Again, if we tie a string very tightly around a stem so as to compress the bark, the stem sometimes swells just above the stricture; and if there be a fruit growing from the stem on that region, it will increase greatly in weight. This suggests that the nutritive materials elaborated in the leaves pass down outside the wood. But the tissue outside the wood and the cambium cylinder includes many different kinds of elements—an external epidermis, perhaps some cork, some softer rind or cortex, a set of hard bast-fibres, and, most internally, what is called soft-bast, including long 'sieve-tubes' and also 'cambium-form-cells.' It is certain that this soft-bast is very important in the downward passage of elaborated sap.

If we examine—by means of thin sections—the delicate growing point of the stem, we find that it consists of an external epidermis and of an almost homogeneous 'fundamental tissue.' As we pass in our examination from the tip downwards—that is, to slightly older parts—we notice that within the fundamental tissue there gradually appear certain firm strands. These differentiations of the fundamental tissue are known as fibro-vascular bundles. Thus in the stem we distinguish

the epidermis, the fibro-vascular bundles, and what remains of the fundamental tissue, in the form of central pith and superficial cortex, and radiating plates or medullary rays extending between these. In Dicotyledons the fibro-vascular bundles are radially arranged, and each consists of an internal wood or xylem part, an external bast or phloem part, and between these a persistent young layer of cambium, which, by the division of its cells, adds internally to the wood, externally to the bast, and enables the stem to grow in girth. These fibro-vascular bundles are continued out into the leaves, or, to state the fact in another way, each leaf contributes to the stem a 'leaf-trace' of fibro-vascular bundles which extend vertically down the stem, and eventually unite in a connected system. In the lower or older parts of the twig or stem there are necessarily very many fibro-vascular bundles, and these are intimately fused with one another. Thus we have from without inwards,

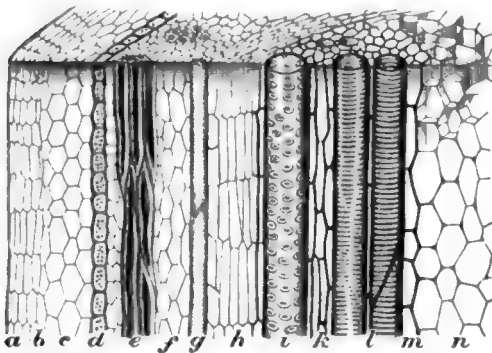

Fig. 2.—Longitudinal section of a portion of a woody Stem (after Kerner).

a, epidermis; b, cork; c, cortical parenchyma; d, bundle-sheath; e, hard-bast; f, bast-parenchyma; g, sieve-tubes; h, cambium; i, vessel with bordered pits; k, wood-parenchyma; l, vessels; m, medullary sheath; n, pith.

beneath the cortex, a sheath of bast, a cylinder of cambium, and the central wood. The fundamental tissue remains undifferentiated in the cambium, and slightly modified in the central pith (if that be present), in the radial medullary plates which traverse the wood and bast, and in the superficial cortex.

The fibro-vascular bundles in the stem of Dicotyledons have a radial arrangement; in their vertical course they run parallel to one another, and are united into a connected system. Almost always they are 'collateral'—i.e. the bast lies in the same radius as the wood—and they are 'indefinite,' for the cambium persists. In Monocotyledons the fibro-vascular bundles which enter from the leaves pursue a curved course—first inwards and then outwards again—in the stem. In cross sections they therefore appear scattered in the fundamental tissue; they are also collateral but 'definite,' for the cambium is at an early stage used up. This last peculiarity explains the generally uniform thickness of a Monocotyledonous stem and the fact that the bark is not usually separable. In Ferns the bast surrounds the wood in each strand, forming 'concentric' bundles. So too there are structural peculiarities in the stems of Lycopods and Horsetails, while those of Mosses are, as we would expect, almost wholly cellular without differentiated bundles.

It is not easy to form an accurate conception of the internal structure of stems, but we must bear in mind the following physiological considerations. (1) As the stem is a supporting axis, often bearing

heavy weights and resisting great strains, there is usually much *skeletal tissue*—e.g. the bast-fibres, the wood-fibres, and the hard wood which forms the heart of most trees. Schwendener and others have shown that the fibro-vascular bundles are always disposed to mechanical advantage. (2) As the outside of the stem is exposed to the weather and is often subjected to considerable strains, there is usually more or less *protective tissue*—e.g. the tough skin and a layer of cork. (3) As the stem mediates physiologically between the roots and the leaves, it contains *conducting tissue*—(a) the young tracheides and wood-vessels by which water and dissolved salts ascend; and (b) the sieve-tubes, cambiform cells, and conducting parenchyma by which elaborated materials descend. In the pith, medullary rays, &c. these materials are often stored.

The most practically important stems are those of timber-trees, but their uses are manifold. Thus, the bark of oaks (containing tannin) is used in tanning, and several kinds of bark are used in medicine; the bast-fibres of jute, hemp, &c. are used in making textile fabrics, ropes, and the like; the farinaceous pith of one of the palms is well known as sago, and many other kinds of pith are nutritious; the juices of some stems furnish india-rubber, oil, wine, &c.; the potato is the most important of the edible stem-tubers.

See BUD, BRANCH, LEAF, ROOT, VEGETABLE PHYSIOLOGY; H. Marshall Ward, *The Oak* ('Modern Science' series, Lond. 1892), for best English account of internal structure of stem, and *Timber and its Diseases* ('Nature' series, Lond. 1889), for theories of ascent of sap; Kerner's *Pflanzenleben* (vol. i., Leip. and Wien, 1889), for adaptations of stems; also text-books of Sachs, Van Tieghem, Asa Gray, Wiesner, and others.

Stencilling, a method of printing letters or designs. The process consists in cutting out the pattern in a thin plate, usually of metal; this is then laid on the surface intended to receive it, and the colour is rubbed into the cut space with a brush, the plate preventing the contact of the colour, except on the space cut out. It is much used for wall and other surface-decoration, as it is a rapid and cheap process.

Stendal, a town of Prussian Saxony, 36 miles by rail N. by E. of Magdeburg, was the former capital of the Altmark, and has a Gothic cathedral (1420-24), a Roland pillar, two old gateways, and a statue of Winckelmann, a native of the place. There are here large railway workshops and some textile industries. Pop. 16,184.

Stendhal. See BEYLE; and add two recent French works on him by E. Rod (1891) and (on his diplomatic career) L. Farges (1892).

Stennis. See STONE CIRCLES.

Steno, NICHOLAS, anatomist and geologist, was born at Copenhagen in 1638. He was brought up a strict Lutheran, and was trained to medicine, winning great fame as an inquirer into the anatomy of the glands, the heart, and the brain. For many years he led a wandering life in Holland, France, Austria, Hungary, Italy, but in 1667 settled in Florence, and was converted to the Roman Catholic faith through the eloquence and earnestness of Bossuet. About this same period he turned his attention to geology. He was the first to point out the true origin of fossil animals; he treated of the structure of the earth's crust, clearly portraying the prevalent stratification of rocks, and discriminating between their volcanic, chemical, and mechanical modes of origination. Soon after settling in Florence he was appointed physician to the Grand-duke Ferdinand II., and later added thereto the office of tutor to the son of Grand-duke Cosimo III. But his conversion gradu-

ally drew away his mind from natural science; he became a man of marked piety, was made a bishop, and in 1677 was despatched by the pope to the north of Germany to act as vicar-apostolic of those regions. He died at Schwerin on 25th November 1687. See Professor Hughes in *Nature* for 1882.

Stenography. See SHORTHAND.

Stentor, one of the Greeks before Troy, whose voice was as loud as that of fifty men together.

Stephanite. See SILVER, p. 461.

Stephanotis. See ASCLEPIADACEÆ.

Stephen, saint and protomartyr; see DEACON. His festival falls on December 26.

Stephen, the name of ten popes of the Roman Catholic Church. STEPHEN I. was the successor of Lucius III., and his pontificate (254-257) is memorable only for his hotly maintaining against Cyprian that heretics baptised by heretics need not be rebaptised on admission into the orthodox church. A martyr according to tradition, he was canonised, his day falling on August 2.—STEPHEN II. died two days after his election (March 27, 752), hence he is often omitted from the list of popes.—His successor, STEPHEN III., was a native of Rome. When Astolphus, king of the Lombards, threatened Rome, and the Byzantine emperor, Constantine Copronymos, left unheeded his appeals for succour, Stephen turned to Pepin, king of the Franks, who forced Astolphus to withdraw, and gave the pope the exarchate of Ravenna, the real foundation of the temporal power of the papacy. Stephen died in 757.—STEPHEN VII., elected in 896, is infamous from his disinterring the corpse of his penultimate predecessor, Formosus, and throwing it into the Tiber. The year after he himself was strangled in prison.—STEPHEN X. was elected in 1057, under the influence of the celebrated Hildebrand, but died after eight months' rule.

Stephen, king of England (1135-54), was the third son of Stephen, Count of Blois, by Adela, daughter of William the Conqueror, and was therefore nephew of Henry I. and cousin of Matilda, daughter of Henry. He was born in 1105, came over to England at an early age, and became a favourite with his uncle, who gave him the countship of Mortain in Normandy, while he gained that of Boulogne by marriage with its heiress, a niece of the famous Godfrey of Bouillon, and granddaughter of Malcolm and Margaret of Scotland. When his uncle Henry I. resolved to settle the crown on his daughter Matilda, whose first husband was Henry V., emperor of Germany—whence she is often styled the 'Empress Maud'—he held a council in London early in 1127, where Stephen with the rest took the oath of fealty to Maud. A few months later the widowed empress married Geoffrey Plantagenet. On the death of Henry I. (December 1, 1135) Stephen hurried over to England from Normandy, was hailed with enthusiasm by the Londoners and the citizens of Winchester, and was crowned on the 22d of the same month. He promised many reforms, but though really a merciful and generous man he never received, or deserved to receive, confidence from his people. He attempted to strengthen his position by the unpopular policy of bringing into England bands of Fleming mercenaries, and he made enemies as fast as friends by the lavish favours he heaped upon certain of the great lords. King David of Scotland invaded the North on Maud's behalf, but suffered a severe defeat near Northallerton (1138), yet Stephen was not strong enough to do more than compromise with him by way of peace, David's son Henry being allowed to hold all Northumberland save Bamborough and Newcastle as a fief, while David kept

Cumberland without homage. The first powerful enemy that the king made within England was Robert, Earl of Gloucester, an illegitimate son of Henry I., who held the strong fortress of Bristol; and next he arrayed against himself the whole power of the clergy by his quarrel with the Justiciar, Roger, bishop of Salisbury, his nephews the bishops of Ely and Lincoln, and his illegitimate son Roger the Chancellor. The realm now fell into sheer anarchy; the barons plundered and burned at their pleasure; 'men said openly that Christ and His saints were asleep.' In 1139 Matilda arrived in England, and in 1141 took Stephen prisoner at Lincoln. Matilda was now acknowledged as queen, but her harshness and greed soon disgusted Englishmen. The men of London rose, and she fled to Winchester before them. On the 1st November 1141 Stephen obtained his liberty in exchange for the Earl of Gloucester, who had fallen into the hands of his friends at Winchester, and the year 1142 saw him again in the ascendant. Earl Robert died in 1147, and the year after Matilda finally left England. Her son Henry was given the duchy of Normandy in 1149, and next year he became on his father Geoffrey's death Count of Anjou also. He married Eleanor the Duchess of Aquitaine in 1152, and now crossed over to England to pursue his ambition further. The death of his son Eustace took from Stephen all heart for prolonging the struggle, and by the peace of Wallingford and Westminster he agreed to acknowledge Henry as his successor, his continental property being secured to his remaining children, and all the 'adulterine' or unlicensed castles that had sprung up during the civil war, to the number of 1115, to be destroyed. Stephen died at Dover in October 1154.

Stephen, KING. See HUNGARY, Vol. VI. p. 5; POLAND, Vol. VIII. p. 271.

Stephen, JAMES, born at Poole, in Dorsetshire, of an Aberdonian stock, in 1758, was educated at Winchester, and became successively a parliamentary reporter, an official in St Kitts, an advocate in prize cases before the Privy-council, member for Tralee, under-secretary for the colonies, and a master of the Court of Chancery. He died at Bath, 10th October 1832. He was an abolitionist, and author of an able and exhaustive work on *The Slavery of the British West Indies* (1824-30).

HENRY JOHN STEPHEN (1787-1864), his son, was a serjeant-at-law, the author of a *Summary of the Criminal Law* (1834), *New Commentaries on the Laws of England* (1841), &c.—The third son, SIR JAMES STEPHEN (1789-1859), from Trinity Hall, Cambridge, passed in 1813 to Lincoln's Inn, and became counsel to the Colonial Office and Board of Trade, then under-secretary of state for the colonies from 1834 to 1847, when he was knighted. From 1849 he was regius professor of Modern History at Cambridge. See the Memoir prefixed to the 4th edition of his *Essays in Ecclesiastical History* (1849), another well-known work by him being *Lectures on the History of France* (1851).—The youngest son, SIR GEORGE STEPHEN (1794-1879), was successively a solicitor and barrister, was knighted in 1837 for his services in the reform of the poor-laws, imprisonment for debt, and the police force; in 1855 emigrated to Victoria; and like his father wrote on the slavery question.

SIR JAMES FITZJAMES STEPHEN, son of Sir James Stephen, was born at Kensington, 3d March 1829, and educated at Eton, King's College, London, and Trinity College, Cambridge. Taking his B.A. (1852), and called to the bar at the Inner Temple (1854), he travelled the Midland Circuit, and became recorder of Newark-on-Trent (1859-69), a Q.C. (1868), legal member of the Viceroy

of India's Council (1869-72), professor of Common Law at the Inns of Court (1875-79), a K.C.S.I. (1877), and judge of the High Court of Justice (1879-91), on his retirement being created a baronet. The Indian Evidence Act was due to him; and among his works are a *General View of the Criminal Law of England* (1863); *Liberty, Equality, and Fraternity* (1873); *Digest of the Law of Evidence* (1876); *Digest of the Criminal Law* (1877); *History of the Criminal Law of England* (1883); *Story of Nuncomar* (1885); and *Horæ Sabbaticæ* (*Saturday Review* articles, 1892). He unsuccessfully contested Harwich (1865) and Dundee (1873) as a moderate Liberal. He died 12th March 1894.—His younger brother, LESLIE STEPHEN, born at Kensington, 28th November 1832, was educated at Eton, King's College, London, and Trinity Hall, Cambridge, where, having graduated in 1854, he was for a time a fellow and tutor. Then relinquishing his orders and removing to London, he became editor of the *Cornhill* (1871-82), and of the first twenty-six volumes of the great *Dictionary of National Biography* (1885-91, from 1890 conjointly with Mr Sidney Lee, his successor). His works include *The Playground of Europe* (1871); he was president for a while of the Alpine Club; the delightful *Hours in a Library* (3 vols. 1874-79); *History of English Thought in the Eighteenth Century* (1876); *Johnson* (1878), *Pope* (1880), and *Swift* (1882) in the 'Men of Letters' series; *Science of Ethics* (1882); lives of Mr Fawcett (1885) and his brother (1895); *An Agnostic's Apology* (1893); *Social Rights and Duties* (1896); and he has written largely for the magazines. He is LL.D. of Cambridge.

Stephens, English for ESTIENNE or ÉTIENNE, famous French printers and publishers. The first to embark in this business was HENRY STEPHENS (c. 1460-1520), who settled in Paris about 1500. His business was taken up in 1526 by his second son ROBERT (b. 1503), having in the interval been managed by his step-father. Robert specially distinguished himself by the excellence of his workmanship, and was in 1539 and 1540 appointed printer to the king in Latin, Greek, and Hebrew. Early in life he became a convert to the doctrines of the Reformation; and on more than one occasion he got into difficulties with the theological authorities of the university of Paris for introducing editorial changes in the text of the Bibles and Testaments he printed. In 1550 indeed he found it prudent to retire to Geneva. There he remained until his death, on 7th September 1559, and published several of Calvin's works. Robert Stephens was a scholar as well as a printer; he published and printed in 1532 a Latin dictionary (*Thesaurus Lingue Latine*) which remained a standard work down to the middle of the 18th century. Amongst his editions of the Holy Scriptures the Latin New Testament of 1523, the Latin Bible (folio) of 1528, and the Greek New Testament (folio; see BIBLE, Vol. II. p. 126) of 1550 deserve special mention. Being a lover of the New Learning he also printed several of the classic authors, numerous Latin grammars, and similar books. Robert's brother CHARLES (1504-64), who graduated in medicine and practised in Paris, took charge of his brother's business when he withdrew to Geneva, and wrote and printed himself an encyclopaedic work (*Dictionary Historicum ac Poeticum*, 1553), a collection of ancient treatises on agriculture (*Prædium Rusticum*, 1554), and other books. Robert's eldest son HENRY (born at Paris in 1528) worthily sustained the reputation of the family. He received an excellent education, and became celebrated for his knowledge of Greek. Both before and after he settled down at Geneva (in 1551) he travelled in Italy, England, and the Netherlands, collating MSS. (mostly Greek), and consorting with scholars. In 1556 he set up a press

of his own in Geneva, and issued from it a great number of the ancient Greek authors, including some twenty 'first editions.' His greatest achievement as a scholar was a Greek dictionary entitled *Thesaurus Græcæ Linguae* (5 vols. folio, 1572), on which he spent nearly all his fortune. In his editions of classic authors he indulged in many textual emendations, most of them based on MS. authority, but some purely conjectural. From about the year 1578 he led a very restless and wandering life, and his business was greatly neglected, till at length he died at Lyons early in 1598. He also wrote his mother-tongue with force and elegance, his most remarkable production in it being the semi-satirical *Apologie pour Hérodote* (1566). The traditions of the family were kept up by PAUL (1566-1627), the son of Henry (II.) Stephens, who printed valuable editions of Euripides (1602) and Sophocles (1603); and by Paul's son ANTOINE (1592-1674), who became king's printer at Paris, and amongst other books printed the Septuagint.

See Greswell's *View of the Early Parisian Greek Press* (1833); French works by Renouard (2d ed. 1843) and Bernard (1856); and Mark Pattison's posthumous *Essays* (1889).

Stephens, ALEXANDER HAMILTON, an American statesman, was born in Georgia in 1812, admitted to the bar in 1834, and elected by the Whigs in 1843 to congress, where he sat till 1859. He advocated the annexation of Texas as early as 1838, and in 1854 defended the Kansas-Nebraska act. He at first opposed secession, but in 1861 became vice-president of the Confederacy, and in 1865 was imprisoned for five months. He sat in congress again from 1874 to 1882, was elected governor of Georgia in 1882, and died 4th March 1883. His *War between the States* appeared in 1867-70.

Stephens, GEORGE, archaeologist, was born in Liverpool, December 13, 1813, and was educated in University College, London. He settled early at Stockholm, and was appointed in 1851 lecturer, later professor, of English in the university of Copenhagen. His works are numerous and learned, the most important his magnificent *Old Northern Runic Monuments of Scandinavia and England* (3 vols. 1866-68-84), and its abridgment, containing, however, all the engravings and translations (1884). Other works are on the Ruthwell Cross (1868), on Bugge's Studies in Northern Mythology (1883), and his early translation into English of Tegner's *Frithiof* (Stockholm, 1841). He died 13th August 1895.

Stephens, JAMES, Fenian, was born at Kilkenny in 1824, son of an auctioneer's clerk with more of Saxon than of Celtic blood. He had a good education, took early to mathematics, and at twenty obtained an appointment during the making of the Limerick and Waterford Railway. He next went to Dublin, and soon became one of the most active agents of the Young Ireland party. He was slightly wounded at the miserable scuffle of Ballingary (29th June 1848), skulked for three months thereafter among the mountains from Tipperary to Kerry, and then sailed from Cork to France disguised as a lady's servant. For some years he lived mainly at Paris, where he obtained an insight into the working of continental secret societies, and in 1853 journeyed over Ireland making himself acquainted with its condition and preparing the soil for the Fenian conspiracy. As its 'Head Centre' he exercised an enormous and despotic influence, and throughout showed remarkable dexterity in the disguises and characters he assumed on his visits to all parts of Ireland. He visited America early in 1864 to attempt to overthrow the rival schemes formed there by patriots, and was

arrested in Dublin on the 10th November of the same year. Fourteen days later he made his escape from Richmond Bridewell in a manner so suspicious that many have looked for the explanation rather to government connivance than to the treachery of officials. He found his way to New York, where he was formally deposed by the Fenians. He sank into obscurity, and returned to Ireland in 1891. See O'Leary's *Recollections of Fenianism* (1896).

Stephenson, GEORGE, the father of the locomotive, was the son of Robert Stephenson, who again was the son of a Border shepherd in Oxnam parish, Roxburghshire, and had crossed the Cheviots in search of work at the Northumbrian coal-mines. He was born at Wylam, 8 miles from Newcastle, on the 9th of June 1781, in circumstances of great poverty, his father having to maintain a family of six children on twelve shillings a week, earned by tending a colliery-engine. George's first employment was herding cows at twopence a day, from which he was promoted to hoeing turnips at fourpence; subsequently he was appointed fireman at Midmill Colliery, and at fifteen we find him at Throckley Bridge, rejoicing in a salary of twelve shillings a week. The early life of Stephenson presents a record of determined purpose, industry, and sagacity. Out of his humble gains he contrived to pay fourpence a week for lessons in reading, writing, and arithmetic, which were conned over at night, and mastered by the light of his engine-fire. As fireman he applied himself to diligent study of the steam-engine, taking his machine to pieces during his leisure hours, and thus gaining a thorough practical knowledge of it. At Black Callerton Colliery in 1801, by dint of mending shoes and cleaning watches, in addition to his regular employment, Stephenson contrived to save his first guinea. At twenty-one he had saved enough to furnish a cottage in a humble way, and on 28th November 1802, he was married to Fanny Henderson, who died in 1806, while her husband was brakesman at Killingworth Colliery. In 1815 the invention of a colliery safety-lamp, the 'Geordie,' brought his name before the public, and led to a long controversy with the supporters of Davy's Safety-lamp (q.v.). He received a public testimonial of £1000 for his discovery. In 1812 he became engine-wright at Killingworth Colliery, and it was here, by Lord Ravensworth's permission (1814), that he constructed his first locomotive, 'My Lord,' for the colliery tram-roads. At first it was not very efficient; but subsequently the grand improvement of the 'steam-blast' carried his experiment to a triumphant issue (see RAILWAYS). Further improvements followed, and in 1821 Stephenson was appointed engineer for the construction of the Stockton and Darlington Railway. In 1820 Stephenson married his second wife, Elizabeth Hindmarsh, the daughter of a farmer.

The rapid growth of the trade of South Lancashire, together with the unpopular management of the Bridgewater Canal, gave rise in 1821 to the project of a railway between Liverpool and Manchester. When the bill ultimately passed, on 16th March 1826, Stephenson was appointed principal engineer, with a salary of £1000 a year. After inconceivable difficulties the line was completed in 1829. There then ensued the memorable competition of engines, resulting in the complete triumph of Stephenson's 'Rocket' (see fig. in Vol. VIII. p. 554), which, to the astonishment of every one except himself, was found capable of travelling at the till then undreamt-of rate of 35 miles an hour. 'Now,' exclaimed one of the directors, 'has George Stephenson at last delivered himself.' While occupied in carrying out the vast system of railway which soon overspread the country Stephenson's home was at Alton Grange, near Leicester;

but of it he saw little, as he was often travelling on business for weeks at a time. During the three years ending 1837 he was principal engineer on the North Midland, York and North Midland, Manchester and Leeds, Birmingham and Derby, and Sheffield and Rotherham Railways; in 1836 alone 214 miles of railway were put under his direction, involving a capital of five millions; and he would sometimes dictate reports and letters for twelve continuous hours. But in the midst of his immense business his heart remained as youthful as ever. In spring he would snatch a day for bird's-nesting or gardening, in autumn nutting was still a favourite recreation; and we find him writing to his son a touching account of a pair of robins. Strong as he had shown himself when the world was all against him, he was not less so in the midst of his success. During the railway mania his offices in London were crowded every day with men of every rank and condition, eager to strengthen their prospectuses by the weight of his name. Where he was disappointed—and at this time he almost always did disapprove—he invariably declined, though by acceding he might have made enormous gain; but to make money without labour or honour had no charm for Stephenson. In the autumn of 1845 he visited Belgium and Spain. On his way home he was seized with pleurisy, from which attack he seems never to have thoroughly recovered. He occupied his later years in the quiet pursuits of a country gentleman, growing fruit and indulging his love of nature. He died at his country-seat of Tapton, near Chesterfield, on 12th August 1848. In his prime Stephenson was strong and full of elastic muscular vigour, and fond of feats of strength. He read little, as his youth and manhood had been spent in hard work; and most of his letters were dictated. But he enjoyed conversation, from which most of his imparted information was derived. The leading feature of his mind was honesty of purpose, and determination in carrying it out. 'I have fought for the locomotive single-handed for nearly twenty years,' he says; 'I put up with every rebuff, determined not to be put down.' Towards trickery and affectation he never concealed his contempt, while honest merit never appealed to his liberality in vain.

See Smiles's *Story of the Life of George Stephenson* (1857; new ed. 1873); and vol. v. of his *Lives of Engineers* (George and Robert Stephenson; new ed. 1874).

Stephenson, ROBERT, only son of George Stephenson, by his first wife, was born at Willington Quay on 16th October 1803. When a boy he attended a school in Newcastle; in 1819 he was apprenticed to a coalviewer at Killingworth. In 1822 his father's improving circumstances enabled him to send Robert to the university of Edinburgh, where he remained six months, and made excellent use of his time. In 1823 we find him assisting his father in the survey for the Stockton and Darlington Railway. Subsequently he took an active part in the locomotive engine-works started by his father at Newcastle. In June 1824 he went to Colombia, in South America, on an engineering appointment, but returned at the end of three years. He then assumed the management of the Newcastle business. During the discussion as to the power to be employed on the Liverpool and Manchester line, he was in constant communication with his father, to whom his quick perception and rapid judgment were of great assistance. The result was the successful construction of the 'Rocket.' Shortly after the completion of this line he was appointed engineer of the Leicester and Swannington Railway. Subsequently he was appointed joint-engineer, along with his father, of the London

and Birmingham line, the execution of which immense work was ultimately almost wholly entrusted to him. In 1829 he married Frances, daughter of John Sanderson, merchant in London. She died in 1842 without issue. The London and Birmingham line was completed in such a manner as to raise Stephenson to the very highest rank in his profession. Amongst his great achievements were the Britannia and Conway Tubular Bridges, the Victoria Bridge across the St Lawrence at Montreal, the two bridges across the Nile at Damietta, the Royal Border Bridge, Berwick, and the High Level Bridge, Newcastle, several of which are described at BRIDGE, Vol. II. pp. 440-1. In 1847 he was returned to the House of Commons as member for Whitley. He was the recipient of many honours from abroad, and was much consulted about foreign railways. He died on 12th October 1859, and was buried in Westminster Abbey. Robert Stephenson inherited the kindly spirit and benevolent disposition of his father, to whom he was ever ready to attribute the chief merit of his own achievements. 'It was his thorough training,' he once said, 'his example, and his character which made me the man I am.'

See Smiles's *Story of the Life of George Stephenson* (1857) and *Lives of the Engineers*, vol. v., and J. C. Jeaffreson's *Life of Robert Stephenson* (2 vols. 1864).

Stepney. See LONDON, Vol. VI. p. 703.

Stepniak ('Son of the Steppe'), the *nom de guerre* of an exiled leader of the Russian revolutionary party, was born in 1852 of an old Little Russian family called Kravchinsky. Sergius Mikhailovitch studied at Kieff, held a commission in the artillery, and in 1870-73 was a professor at Kieff; but having become obnoxious to the government, and believed to have been the assassin of General Mesentseff, head of the Russian police, he left Russia and settled (1876) in Geneva, and subsequently (1885) in London. He published in Russian many articles and works on the ethnography, history, folk-lore, and literature of Little Russia, and lectured and wrote for the magazines in England and America, but was best known as author of *La Russia Sotteranea* (Milan, 1881; Eng. trans. *Underground Russia*, 1883), sketches of the Nihilist movement and its leaders; of *Russia under the Tsars* (Eng. trans. 1885), a terrible indictment; and of *The Career of a Nihilist*, a novel (1889); *Russian Wit and Humour* (1894); *Nihilism as it is* (1894); *King Stork and King Log* (1895). With Kropotkine (q.v.) and Lavroff, he was one of the heads of the Nihilist party. See NIHILISM. He was run over by a train near London, 23d Dec. 1895.

Steppes, the broad plains of southern Russia and western Siberia. See DESERT.

Sterculiaceæ, with the closely allied Malvaceæ and Byttneriaceæ and the Tiliaceæ form the natural order of Columnifereæ. The family consists of 130 species of large trees and shrubs, natives of warm climates. Many species, particularly of the sub-order Bombaceæ, are trees of gigantic size, amongst which is the Baobab (q.v.) or *Adansonia digitata*. The bark of some species is very fibrous, so that it is made into ropes and coarse cloth. The light wood of *Ochroma lagopus* is used in the West Indies instead of cork. *Sterculia fetida*, an Indian tree, with excessively fetid flowers, has pale wood, which is very durable, and susceptible of a high polish. Spars of this wood are called *Poon Spars*. The seeds of some species, as of the Silk-cotton (q.v.) trees, are surrounded with silky hairs. The seeds of all the species are oleaginous; those of some are eatable, as those of the Chicha (*Sterculia chicha* and *S. lasiantha*) of Brazil, which are about the size of a pigeon's egg, and have a pleasant flavour. They are roasted before being

eaten. The Kola Nut (q.v.) of Africa is the seed of a *Sterculia*. The whole order agrees with Malvaceæ in possessing mucilaginous and demulcent properties. The Gum Tragacanth (see GUM) of Senegal and Sierra Leone is produced by *Sterculia tragacantha*. The Durian (q.v.) is the fruit of a tree of this order.

Stere (Gr. *stereos*, 'solid'), the name given to the unit of cubic measure in the French metrical system. It is a cubic *Mètre* (q.v.), and equivalent to 35'3156 English cubic feet. The *decastère* is equal to 10 steres, and the *decistère* to the tenth part of a stere. This measure is much used for wood, especially firewood.

Stereoscope (Gr. *stereos*, 'solid,' and *skopein*, 'to see'). Each eye of an observer forms its own retinal image of visible objects. These two images, being taken from slightly different points of view, are slightly different from one another, as may be seen by looking at near objects with each eye alternately; and they are the more so the nearer or the narrower the objects are. These two retinal images are blended by a process of interpretation of sensation, which interpretation is based on experience, into a mental image of the object seen as a solid object possessing three dimensions. Professor (afterwards Sir Charles) Wheatstone first pointed this out in 1838, and set himself the question, 'What would be the visual effect of simultaneously presenting to each eye instead of the object itself its projection on a plane surface as it appears to that eye?' He tried the experiment with drawings of cubes, &c., and found that when one eye was made to look at each drawing the two images blended into one which appeared to stand out in relief. Photography supplies more accurate representations of views from two points of view than the artist's eye and hand can supply; and if a view be taken by two lenses upon different parts of a single sensitive plate the print from the negative must be divided into two and the two pictures transposed and mounted. If this transposition be neglected the effect is *pseudoscopic*—i.e. instead of objects standing out in relief they stand back as if their more prominent surfaces were the walls of cavities. The stereoscope is essentially an instrument in which each picture is examined by a separate lens, and the two lenses are inclined so as to shift the images towards one another and thus to ensure or to facilitate the blending of the two images into one, besides which the lenses act as magnifying glasses. The two lenses must be equal. This may be ensured by using instead of whole lenses two halves of a single lens, the straight edges of which halves must be fixed parallel to one another.

Stereotyping (Gr. *stereos*, 'solid') is the art of fabricating solid casts in type-metal from pages of movable types. Unless when the number required of any printed matter is very small, the actual printing is very seldom executed directly from the types (see PRINTING). When the pages are all corrected and ready for the press casts are taken from them either in type-metal (stereotypes) or in copper (electrotypes). The latter method, being sharper and much more durable, is generally used when large numbers are to be printed, and will be found described in the article ELECTRO-METALLURGY.

Stereotyping being much cheaper, and quite suitable where moderately large numbers are required, has also, in the papier-maché process, the advantage that it can be executed in a very short time—an important matter in connection with newspapers. It was invented by William Ged (q.v.), a goldsmith in Edinburgh, about the year 1725. His process is as follows: after slightly oiling the

surface of the types with a soft brush, stucco mixed to the consistency of thick cream is poured over them and allowed to 'set;' the stucco, when taken off and baked in an oven till quite hard, forms a perfect matrix from which a cast in type-metal (see TYPE) is taken by means of a hollow casting-box which dips the mould into the molten metal. The cast, which should be a perfect fac-simile of the types, is finally trimmed, planed on the back down to the required thickness (about $\frac{1}{4}$ inch), and carefully sized to fit the blocks on which it is to be printed. This process was universally employed for all purposes till it began to be superseded by the *papier-maché* process, invented by Genoux (1829), and introduced into England from the Continent. Its advantages, in cheapness and rapidity, were at once apparent, and now Ged's process is nearly if not quite extinct. The process is as follows: several plies of soft thin paper, very carefully pasted together, are placed in a wet state on the face of the types, beaten in with a hard brush, and impressed as deeply as possible into all the interstices. The hollows on the outside of the paper are filled up with pipeclay or similar material to give solidity to the mould, and a strong piece of brown paper pasted over all. It is then dried on a hot plate till hard enough to be lifted off the types. It is next put into a flat casting-box, the sides of which are, when closed, just far enough apart to allow the cast to be of the required thickness. The metal must be poured in hot enough to run properly, but not hot enough to burn the paper. The cast is then trimmed and made ready for the printing-machine as in Ged's process. Any accidentally bad letters can be replaced by cutting a hole in the plate, and inserting and soldering in a type. Whole lines or sentences can also be altered, the required new pieces being cast separately and soldered into the plate. The *papier-maché* mould is not destroyed by the casting like the stucco matrix, but can be kept, and, if carefully used, almost any number of casts may be made from it.

It is a modification of this process which has made the printing of newspapers on the rotary printing-machine successful (see PRINTING). In this process, where the stereotype plates are required to be fitted round a cylinder, and great rapidity is necessary, the following changes are made on the method already described. The paper, instead of being bent into the type with a brush, is pressed in with a soft roller, and is then rapidly dried by means of hot blankets in a hot press. When ready the mould is bent inside a cylindrical casting-box, the core of which is exactly of the same diameter as the printing cylinder. The cast when taken out consequently fits the machine exactly. So complete are the stereotyping arrangements in the larger newspaper offices that duplicate casts of a page of the paper can be prepared in ten or twelve minutes. See F. J. F. Wilson, *Stereotyping and Electrotyping* (3d ed. 1887).

Sterility, barrenness in regard to reproduction of the species, is a term applied both to plants and animals, and may be due to external conditions, functional disorder, organic defects, or, in human beings, the results of surgical treatment. See FLOWERS (FERTILISATION OF), REPRODUCTION, EMBRYOLOGY, SEX, HYBRID, PUBERTY, &c. Impotency renders a marriage void; sterility in no way invalidates the marriage tie. As is well known, it frequently happens that children are born to parents who have been childless for many years. See works cited at OBSTETRICS and MEDICAL JURISPRUDENCE; Dr S. W. Gross, *On Impotence and Sterility of Males* (1881); Dr Matthews Duncan, *On Sterility in Women* (1884).

Sterlet. See STURGEON.

Sterling, originally a substantive, 'a coin of true weight,' as applied at first to the English penny, then to all current coin. Skeat accepts the old and often doubted etymology that the name is derived from the Hanse merchants or *Easterlings* (i.e. 'men from the east'), who had many privileges in England in the 13th century, including probably that of coining money (see Vol. V. p. 541). The adjective is now used of all the money of the United Kingdom, and has long been a synonym for pure and genuine.

Sterling, a city of Illinois, on Rock River (here crossed by two bridges, one of iron, 1100 feet long), 109 miles W. of Chicago by rail. A large dam supplies water-power to most of the fifty factories, which produce farming implements, barbed wire, pumps, windmills, wagons, paper, flour, &c.; and there are five foundries. Pop. (1890) 5824.

Sterling, JOHN, was born at Kames Castle in Bute, 20th July 1806, where his father, Captain Edward Sterling (1773-1847), was then making trial of farming. Ill-success drove him to Llanbethian, near Cowbridge, Glamorganshire, in 1809, thence to Paris, and finally to London, where he became one of the chief oracles of the *Times*. Of his seven children, John and an elder brother alone lived to grow up. John was educated at private schools, at sixteen went to Glasgow University, and at nineteen entered Trinity College, Cambridge, where he had Julius Hare as his tutor. Impulsive, quick-witted, 'able to argue with four or five at once,' he was recognised as the most brilliant member of the famous debating society—the Union—members of which were Maurice, John Kemble, Spedding, Venables, Charles Buller, and Richard M. Milnes. After a year Sterling followed Maurice to Trinity Hall, but left Cambridge without a degree in 1827. He first thought of law, but soon became busy on the *Athenæum*, which had not yet begun to flourish. A Liberal in thought and in politics, he came under the influence of Coleridge, and formed a fast friendship with General Torrijos, chief of a group of Spanish exiles. Indeed his own uncertain health and his becoming at the hour of parting engaged to Miss Barton alone prevented his sailing on that crazy expedition which came to its inevitable close in the execution of Torrijos and Sterling's cousin Boyd at Malaga—a tragedy which haunted Sterling with a lasting horror. He married in November 1830, but soon after fell dangerously ill, and spent fifteen months in the island of St Vincent, returning in August 1832. In June of next year he met Hare at Bonn, and partly through his influence took orders, and served with characteristic zeal as Hare's curate at Hurstmonceaux for eight months. His health again giving way, he resigned, and though he sometimes for some time after, as Carlyle tells us, took duty for a friend in London, he never advanced to priest's orders; indeed, the divergence between his opinions and the church's soon widened beyond even the Coleridgean capability of accommodation. Carlyle first met him in February 1835, and his friendship with Maurice was knit still faster by the latter's marriage to Sterling's sister-in-law. He wrote for *Blackwood* and Mill's review—the *Westminster*, busied himself with projects for tragedies, one of which, *Strafford*, saw the light for a little in 1843, and wrote poems, one of which, *The Election*, was published in 1841. In August 1838 he formed the club first called the Anonymous, then the Sterling Club, among whose members were Carlyle, Allan Cunningham, G. C. Lewis, Malden, Mill, Milnes, Spedding, Tennyson, Thirlwall, W. H. Thompson, and Venables. His winters were spent abroad at Bordeaux, Madeira, or in Italy, in the

vain hope of staving off his inevitable doom. In England he lived in turn at Clifton, Falmouth, and Ventnor, and here he died, 18th September 1843.

Julius Hare edited Sterling's *Essays and Tales* (2 vols. 1848) with a memoir, which seemed to Carlyle so incomplete, as dwelling too exclusively on his ecclesiastical side—a brief accident in his career—that he himself determined to write his life, to give a faithful picture of his friend. The result was a masterpiece of biography which will keep the name of John Sterling from ever being forgotten.

Stern, DANIEL. See AGOULT.

Sternberg, a town of Austria, 12 miles by rail N. of Olmütz, with cotton and linen manufactures. Pop. (1890) 15,395.

Sterne, LAURENCE, one of the greatest of English humorists, was born at Clonmel in Ireland, on the 24th of December 1713. His father, Roger Sterne, at that time an ensign in the 34th or Chudleigh's regiment of foot, was the grandson of an archbishop of York who had played an active part as a Cavalier ecclesiastic in the troubles of the previous century. Of his mother we know only that she was the daughter of a 'noted sutler' of the name of Nuttle, and the widow of a soldier, probably a comrade of her second husband. To Roger Sterne she bore seven children, of whom, however, but three survived the period of infancy. The family, continually recruited by births and reduced by deaths, accompanied their parents in the ceaseless wanderings necessitated by the father's military duties; and it was not till Laurence was eleven years old that it was found possible, or at least convenient, to give him any systematic education. He was then sent to Halifax grammar-school, where he remained for over seven years, and whence he was by the assistance of his kinsman, Simon Sterne of Elvington, sent to Jesus College, Cambridge. Here he obtained a sizarship, and in 1736, after taking his B.A. degree, he quitted Cambridge for York, where his father's brother, Dr Jacques Sterne, held, together with a goodly number of ecclesiastical offices, the archdeaconry of the diocese. Through this uncle's influence Laurence, who had been ordained three months after taking his degree, and who took priest's orders in 1738, was presented to the living of Sutton-in-the-Forest, and then or immediately afterwards appointed a prebendary of York.

Three years later, in 1741, he married Miss Elizabeth Lumley, by whom he had one daughter, Lydia, born in 1745, to whom he was all his life tenderly attached, and who published an edition of his Letters after his death. Of his life in his Yorkshire parish during the next nineteen years little or nothing is known, except that at some time, probably near the end of this period, a quarrel took place between him and his uncle, because (to quote the former's account of it) 'I would not write party-paragraphs in the newspapers; though he was a party man I was not, and detested such dirty work, thinking it beneath me.' In 1759 he wrote the first two volumes of the work which was destined to make him famous, *The Life and Opinions of Tristram Shandy*, and which, after being first published at York in the autumn of that year by a local bookseller, was brought to London by its author in 1760, and there published anew. Its success was immediate and signal, and Sterne at once became a 'lion' of the fashionable world. The first edition of the book was exhausted in three months. In April Dodsley brought out a second, and this was shortly afterwards followed somewhat incongruously by a volume of the *Sermons* of the 'Rev. Mr Yorick.' By the end of the year vols. iii. and iv. of *Tristram Shandy*, for which Dodsley had given £380 in advance, were already in the press,

and in January 1761 they made their appearance to receive from the town as heartily amused a welcome as their two predecessors.

Meanwhile Sterne, who had in the previous year been presented by one of his new friends of rank, Lord Falconberg, to the living of Coxwold, had transferred his residence to the parsonage of that place, which was thenceforth to be his home; and throughout the greater part of 1761 he was busy there upon the fifth and sixth volumes of his novel. They were published in December, and three weeks later Sterne, whose health, never robust, was already beginning to fail, left England for France, where he was received with high honours by the literary society of the time, and where he prolonged his stay until the summer of 1764. In January 1765 vols. vii. and viii. of *Tristram Shandy* were given to the world, and met with a more favourable reception than the two preceding volumes, the public interest in which had slightly flagged. They were followed by the publication of a second series of *Sermons* of a far more unclerical character than their predecessors, and, indeed, abounding in quaint touches of their author's peculiar humour. The autumn and winter of 1765 were spent in a tour through France and Italy, which supplied the material of the work to which, in the former of those countries, he still owes his fame. The summer of the following year saw him at work again at Coxwold on the ninth and last volume of *Tristram Shandy*, which appeared in January 1767. The rest of that year was occupied in the preparation of the first two volumes of *The Sentimental Journey through France and Italy*, and in the last days of February 1768 they were published. Their author's health, however, was now completely wrecked; the pulmonary malady from which he had long suffered advanced with rapid strides; and, attacked by pleurisy in the early days of March, he breathed his last in his London lodgings on the 18th of that month. His funeral, which was attended by only two mourners, one of whom was his publisher, took place four days after, at the Bayswater burying-ground of the parish of St George's, Hanover Square. A grim legend later obtained currency to the effect that two days after their interment Sterne's remains were stolen by body-snatchers and disposed of to the professor of Anatomy at Cambridge, by whom, a friend of the deceased, they were actually recognised on the dissecting-table. There seems, however, to be no other warrant for this ghastly story than is to be found in the fact, attested by the records of contemporary journals, that similar desecrations of this particular graveyard had about that time been common. The truth, however, as to the exact spot of Sterne's sepulture cannot now be ascertained. A stone erected many years later with an inscription recording (inaccurately) the date of his death, declares his body to be lying 'near to this place,' but that is all.

His position in English literature is almost in like case; for there is much the same difficulty in assigning their true place to his literary remains. It is, on the one hand, undeniable that there have been few writers of any age or country who have displayed such mastery over every form of humour, from the lowest to the highest, as was exercised from his very first entrance into the field of authorship by this Yorkshire clergyman who never published a line till he was close upon fifty, and who had somehow qualified himself for immediate and enthusiastic reception in the world of letters by a twenty-years' sojourn in a country parsonage. Yet, on the other hand, the imperfections of his art, and that in point not only of execution, but also of artistic conception and spirit, it is impossible to overlook. The wild eccentricity of his manner and arrangement, though it is of course a deliberate

and, as a rule, it must be admitted, a highly successful bid for the laughter of the reader, was also to some extent the convenient cloak of a singularly slipshod literary style. His indecencies, if less gross than those of Swift or Rabelais, are by reason of their pruriency far more offensive. His passages of pathos, sometimes genuine and deeply moving, too often take the form of an artificial and overstrained sentimentalism, and degenerate from the affecting into the affected. His literary conscience had more than the laxity of his time, and, as a later critic of much learning and acumen, Dr Ferriar, showed, he was unscrupulous in his unacknowledged borrowings from the writings of other men. Nevertheless he is, and deserves to be, a classic of English prose fiction. The extravagant Rabelaisian drollery that revels through the pages of *Tristram Shandy*, the marvellous keenness of eye, the inimitable delicacy of touch to which we owe the exquisite vignettes of the *Sentimental Journey*, might not of themselves have secured that place for Sterne; but it is for ever secured to him in right of that combination of subjective and personal with objective and dramatic humour in which perhaps he has never been excelled by any one save the creator of Falstaff. In Mr Shandy and his wife, in Corporal Trim, in Yorick, and above all in that masterpiece of truthful, subtle, tenderly humorous portraiture, 'My Uncle Toby,' Sterne has created imperishable types of character, and made their immortality his own.

See John Ferriar, *Illustrations of Sterne* (2 vols. 1812); *Life*, by Percy Fitzgerald (2 vols. 1864; re-written, 1896); the present writer's *Sterne*, in the 'English Men of Letters' series (1882); *Autobiographical Fragment* (quoted in Scott's and other memoirs).

Sternhold, THOMAS, one of the authors of the English version of psalms formerly attached to the Book of Common Prayer, was born about 1500 near Blakeney in Gloucestershire, according to Fuller and Wood, in Hampshire. He was Groom of the Robes to Henry VIII. and Edward VI., and died in August 1549. The first edition (undated) contains only nineteen psalms; the second (1549), thirty-seven. A third edition, by Whitechurch (1551), contains seven more by J. H. [John Hopkins], probably a native of Awre in Gloucestershire, who died as rector of Great Walsingham, Suffolk, in 1570; and the complete psalms appeared in 1562, and for nearly two centuries after formed almost the whole hymnody of the Church of England. When the rival version of Tate and Brady appeared (1696) it came to be known distinctively as the 'Old Version.' Of the complete psalter of 1562, forty psalms bear the name of Sternhold, and sixty that of Hopkins. The rest were the work of William Whittingham (d. 1579), husband of Calvin's sister and Dean of Durham; Thomas Norton; William Kethe, most probably author of Psalm c. (not, however, printed here till 1565, though already in Daye's Psalter, 1560-61, and the Anglo-Genevan, 1561); J. Pullain; J. Marekant; and Archdeacon Wisdome of Ely (d. 1568). Sternhold and Hopkins' psalms are very faithful, but somewhat coarse and homely in phraseology. As Fuller well said, its authors' 'piety was better than their poetry, and they had drunk more of Jordan than of Helicon.' See J. Julian's magistral *Dict. of Hymnology* (1892).

Sternum. See SKELETON, RIBS, BIRD.

Sternutatories. See SNEEZING.

Stesichorus, greatest of the old Dorian lyricists, and as such called the 'lyric Homer,' was born at Himera in Sicily about 630 B.C., and died in Catania in 556. He dealt largely with epic subjects in his lyrical measures, such as the sieges of Troy and of Thebes, and was said to have been struck

blind for slandering Helen. Only some thirty short fragments of his works remain, to be found in Schneidewin's *Delectus* and Bergk's *Poetæ Lyrici*.

Stethoscope (Gr. *stethos*, 'the chest,' and *skopeō*, 'I look into'), an instrument invented by Laennec (q.v.) for examining the sounds of the chest. Its simplest form will be best understood by the figure, which represents the section reduced to half the natural diameter, or one-eighth of the actual size. The upper part is the chest end, the lower the ear-piece. The latter is often made in a separate piece, for the sake of greater portability. The main object of the stethoscope being to circumscribe and localise the sounds which it transmits, the chest end should be small, in order to determine the exact seat of the greatest intensity of sound. To ascertain this, the instrument should be moved right and left, up and down, till its end is on the exact spot from which the abnormal sound for which we are searching—or, it may be, the absence of sound—proceeds. It may be made of wood, metal, or celluloid; it is usually made hollow as represented in the figure, but this is not necessary, as the sound is well conducted by the stem itself. But besides these rigid instruments flexible ones are largely used, particularly the *binaural* stethoscopes, which have an ear-piece for each of the examiner's ears. In these the ear-pieces and chest-piece are united by hollow tubes of india-rubber, felt, &c., whose mobility permits of much more ready adaptation to different parts and different positions of the patient's chest. The various sounds heard through the stethoscope are very important in the recognition of many diseases of the heart and lungs.

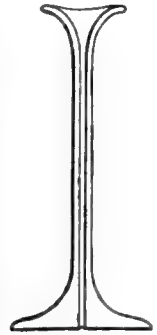

Stethoscope.

Stettin, the capital of the Prussian province of Pomerania, and one of the busiest ports on the southern side of the Baltic, stands on both banks of the Oder, 30 miles from the Baltic and 60 miles by rail (120 by river and canal) N.E. of Berlin. The more important of the public buildings are the Gothic church of St Peter (founded 1124), the large church of St James (14th century), the royal palace (1575), two ornamental arches, a hospital, town-house, theatre, &c. The strong fortifications were only removed in 1874; since then the ground on which they stood has been rapidly built over, so that Stettin now forms virtually one large town with Bredow (pop. 13,713), Grabow (15,644), and Züllchow (6711). Excluding these places, Stettin has a pop. of (1871) 76,154; (1890) 116,139. It is the seat of considerable industrial activity, chiefly in connection with shipbuilding, cement, sugar, paper, spirits, soap and candles, matches, clothing, oil-refining, chicory, chemicals, flour, sewing-machines, bricks, machinery. The river has a depth of 17 to 21 feet opposite the wharves. The port is entered by an average of 3640 vessels of 1,257,600 tons a year (466 vessels of 356,800 tons British), importing principally petroleum and other oils (annual value £1,100,000), rye, coffee, herrings, chemicals, groceries, cotton, seeds, iron, cement, timber, coal, oats, spirits, wool, hides, to the total value of £7,615,000 annually. The exports reach an average of £7,432,700, and embrace sugar (£1,298,000), metals (£936,000), cereals, spirits, seeds, timber, cement, and herrings. Great Britain supplies from two to three millions sterling of the imports, and takes about two millions of the exports. Stettin was the seat of a princely dynasty, 1107 to 1637; was occupied by Sweden, 1648-1720; by the French,

1806-13. See works by Berghaus (1876), Th. Schmidt (1875), and W. H. Meyer (1887).

Steben, FREDERIC WILLIAM AUGUSTUS, BARON, a general of the American revolutionary army, was born at Magdeburg, November 15, 1730, and at fourteen served as a volunteer under his father at the siege of Prague. By 1754 he had risen to the rank of adjutant-general, and in 1762 he was attached to the staff of Frederick the Great. While on a visit to Paris in 1777 he was induced by Count St Germain to go to America. He arrived at Portsmouth, New Hampshire, in February 1778, and offered his services to congress and to General Washington, by whom they were joyfully accepted; and he joined the army, then in the most deplorable condition, at Valley Forge. He was appointed inspector-general, prepared a manual of tactics for the army, remodelled its organisation, and improved its discipline. He sat on the court-martial on Major André. In 1780 he received a command in Virginia, and he took part, as major-general, in the siege of Yorktown. As generous in character as he was capable as an officer, he spent his whole fortune in clothing his men, and gave his last dollar to his soldiers. Congress made tardy reparation, and in 1790 voted him an annuity of 2400 dollars, and a township of land near Utica, New York. There he died in his log-cottage, November 28, 1794. See Sparks's *American Biography*, and a Life by Friedrich Kapp (New York, 1860).

Stebenville, capital of Jefferson county, Ohio, on the Ohio River, 68 miles below Pittsburgh (by railway 43), with blast-furnaces, rolling-mills, machine and railway shops, and manufactories of white-lead, paper, glass, woollens, flour, beer, &c. There are bituminous coal-mines near by, and natural gas is plentiful. Fort Steuben was built here in 1787. Pop. (1890) 13,394.

Stevenage, a town of Hertfordshire, 4 miles SE. of Hitchin by rail, with an old parish church and a grammar-school (1558). Straw-plait is manufactured. Pop. (1851) 2118; (1891) 3309.

Stevens, ALFRED, decorative artist and sculptor, was born at Blandford in Dorset, the son of a country painter, in January (baptised on 28th) 1818. When he was helping his father his talent attracted the attention of certain gentlemen, who in 1833 sent him to Italy. There he remained nearly nine years studying painting, though part of the time he assisted Thorwaldsen, the sculptor, in his studio. Three years after his return home Stevens was appointed (1845) teacher of architectural drawing in the School of Design, Somerset House, London; but he held the position only three years. During the next ten years or so from that date he was busily engaged in designing and decorating, in which he displayed the highest genius and taste. He designed in all sorts of materials and for many different purposes—in silver, bronze, iron, marble, and for furniture, churches, porcelain, mantelpieces. From 1856 he laboured at the great achievement of his life, and one of the finest pieces of modelling in England in the 19th century, the monument of Wellington for St Paul's Cathedral; but owing to the greatness of his conception and plan, the inadequacy of means, and other difficulties, it was not completed at his death, which took place at Haverstock Hill, London, on 1st May 1875. It was not till 1892 that steps were taken to remove this magnificent monument from the side chapel, where it was half-hidden, to the place for which it was originally intended. See SCULPTURE, p. 267; and H. Stannus, *Alfred Stevens and his Work* (1891).

Stevens, THADDEUS, an American statesman, was born in Vermont in 1792, graduated at Dart-

mouth in 1814, was admitted to the Maryland bar, and in 1816 settled as a lawyer in Pennsylvania, where he sat in the legislature for some years. He was a Whig member of congress from 1849 to 1853, and a leader of the Republicans in the House from 1859 till his death, 11th August 1868. He was foremost in all measures for emancipating the negroes, and was chairman of the committee on reconstruction whose bill divided the southern states for a time into five military districts. In February 1868 he proposed the impeachment of President Johnson, was one of the committee which drew up the articles, and chairman of the board of managers appointed to conduct the trial.

Stevenson, ROBERT, a Scottish engineer, was born at Glasgow, 8th June 1772. His father died during his infancy; and his mother having (1786) married Thomas Smith, the first engineer of the Lighthouse Board, young Stevenson was led to devote himself to the study of engineering, in which his progress was so rapid that in 1791 he was entrusted by Smith with the erection of a lighthouse on Little Cumbrae. In 1796 he succeeded his step-father as engineer and inspector of lighthouses; and during his forty-seven years' tenure of that office he planned and constructed no fewer than twenty-three lighthouses round the Scottish coasts, employing the catoptric system of illumination, and his valuable invention of 'intermittent' and 'flashing' lights. The most remarkable of these erections was that on the Bell Rock (q.v.). In 1814 Stevenson was accompanied in his tour of inspection by Sir Walter Scott. Stevenson was also in great request as a consulting engineer in the matter of roads, bridges, harbours, canals, and railways, introduced many improvements in their construction, and occasionally co-operated with Rennie, Telford, and others. He died in Edinburgh, July 12, 1850. Stevenson left four volumes of professional printed reports, a large work on the Bell Rock Lighthouse, some articles in the *Encyclopædia Britannica* and in the *Edinburgh Encyclopædia*. See the Life (Edin. 1878) by his son, David Stevenson, C.E. (1815-86).

Stevenson, ROBERT LOUIS BALFOUR, as novelist, essayist, and miscellaneous writer master of a perfect English style, was born at Edinburgh, Nov. 13, 1850. His father and grandfather (Robert Stevenson, q.v.) were famous lighthouse engineers, and he was at first intended for the family profession. But he soon gave up the idea and turned to law, and, after the qualifying course of study at Edinburgh University, was duly called to the Scottish bar. Soon, however, he found his true calling in the craft of letters, and quickly forced his way into the front rank of contemporary writers by the sheer excellence of his style. Some experiences which supplied impulse and material were leisurely journeys through north-eastern France by canoe and on foot, a voyage across the Atlantic in the steerage of an emigrant ship, and the after-journey across the continent in an emigrant train, and, lastly, a lengthened residence in Samoa, where he settled for health's sake in 1889. From his childhood he had written without ceasing, and drunk deep at the richest wells of English undefiled, and from the first his articles in the *Cornhill* and elsewhere showed a distinct individuality and a style perfect if not plus-quam-perfect. His earliest books were *An Inland Voyage* (1878); *Edinburgh: Picturesque Notes* (1878); *Travels with a Donkey in the Cévennes* (1879); *Virginibus Puerisque, and other Papers* (1881); and *Familiar Studies of Men and Books* (1882). The last two contain his best essays, the latter volume those on Charles of Orleans, Pepys, Burns, Villon, &c. In his *New Arabian*

Nights (2 vols. 1882)—a collection of grotesque romances—he opened a new shaft into his wealth of imaginativeness. More important was its next successor, *Treasure Island* (1883), a complete success in a literary kind the secret of which seemed to have been lost. Hardly less excellent was *Kidnapped* (1886); but *The Master of Ballantrae* (1889), *The Black Arrow* (1888), and *The Wrecker* (Scribner, 1891–92) fall into lower rank. In 1885 appeared Mr Stevenson's delightful collection, *A Child's Garden of Verse*, which stands almost by itself as an imaginative realisation of the make-believe and dramatising imagination habitual to childhood. Later volumes of verse were the less notable *Underwoods* (1887) and *Ballads* (1891), which, always clever, usually fall short of the one thing needful in poetry. *The Silverado Squatters* dates from 1884, *Across the Plains* from 1892. The rococo *Prince Otto* (1885) has been pronounced the crux for testing the true Stevensonian; the *Strange Case of Dr Jekyll and Mr Hyde* (1886) compelled the most exacting critics to commend its ingenuity and exquisite art. *The Merry Men* (1887) is a collection which contains some of his most delicate work; in *Memories and Portraits* the interest was largely autobiographical. The *Island Nights' Entertainments* and *Catriona* (a continuation of *Kidnapped*) mark the year 1893, *The Suicide Club* 1894. With his wife he wrote *The Dynamiter* (1885), and with his step-son Lloyd Osbourne he wrote *The Wrong Box* (1889), *The Wrecker* (1892), and *The Ebb Tide* (1894). He defended Father Damien in 1890, and showed his versatility by a memoir of Professor Fleeming Jenkin (1887), his *Footnote to History* (on Samoan politics, 1892), and his sketches of his father and of his forbears. His health had long been shattered, and he died suddenly on 3d December 1894, and was buried by his own desire on the top of a mountain behind his Samoan home of Vailima. The *Vailima Letters* thence (1895) were addressed to Mr Sidney Colvin. At his death he was the most conspicuous personality in English letters, and he had secured from all classes of readers an exceptional wealth of personal affection. *Weir of Hermiston*, an unfinished story, appeared in *Cosmopolis* in 1895; *St Ives* was published in the *Pall Mall Magazine* 1897. The 'Edinburgh Edition' of his works (1894–98) extends to 27 volumes. See the Life by his literary executor, Mr Sidney Colvin (1899).

See W. Archer in *Time* for November 1885, Henry James in *Partial Portraits* (1888), and Andrew Lang in *Essays in Little* (1890).

Stevens Point, capital of Portage county, Wisconsin, on the Wisconsin River, 161 miles NW. of Milwaukee. Pop. (1890) 7896.

Stevenston, an Ayrshire town, $\frac{3}{4}$ mile inland, and 28 miles SW. of Glasgow. Near it are collieries, ironworks, chemical-works, and Nobel's explosives factory. Pop. (1871) 3475; (1891) 4263.

Stevinus, SIMON, mathematician and physicist, was born at Bruges in 1548, held offices under Prince Maurice of Orange, and died in 1620.

Steward, LORD HIGH, anciently the first officer of the crown in England (Lat. *dapifer, senescallus*), whose important functions were soon conferred on the Justiciar. The dignity, thenceforward honorary, was long hereditary in the successive houses of Leicester, but was finally absorbed into the royal dignity by Henry IV. Since that time there has been no permanent Lord Steward, but the office is temporarily revived when occasion requires, a Lord Steward being appointed under the Great Seal *pro hac vice* at a coronation or the trial of a peer. When the proceedings are at an end the Lord Steward terminates his commission by breaking his wand of office.

The Steward or High Steward of Scotland was not only chief of the household, but collected and managed the crown revenues, and took the first place in the army next to the king in battle. The office was conferred by David I. on Walter Fitzalan, the founder of the royal house of Stewart (q.v.). The accession of Robert, the seventh High Steward, to the throne as Robert II. merged the seneschalship in the crown; but the estates of the stewards afterwards became the appanage of the king's eldest son, and by act of the Scottish parliament of 1469 the titles of Prince and High Steward of Scotland, Duke of Rothesay, Earl of Carrick, Baron of Renfrew, and Lord of the Isles were vested in the eldest son and heir-apparent of the crown of Scotland for ever. 'Great Steward of Scotland' has thus become one of the titles of the Prince of Wales.

The *Lord Steward of the Household*, in England, was originally designated the Lord Great Master of the Household. He is the head of the ancient court called the *Board of Green Cloth* (q.v.), and as such has the control and selection of all the officers and servants of the household, except those belonging to the Chapel, the Chamber, and the Stable, and also appoints the royal tradesmen. He is always sworn a member of the Privy-council, and has precedence of all peers of his own degree. He has no formal grant of office, but receives his charge from the sovereign in person. He holds his appointment during pleasure, and his tenure depends upon the political party to which he belongs; the salary of the office is £2000.

Stewart, HOUSE OF. The Norman Alan Fitzalaud (died c. 1114) got from Henry I. the lands and castle of Oswestry in Shropshire. His elder son, William Fitzalan (c. 1105–60), remaining in England, became the ancestor of the Earls of Arundel, from whom, through an heiress (1556), that earldom has passed to the Dukes of Norfolk. The second son, Walter (died 1177), coming to Scotland in the service of David I., had large possessions conferred on him in Renfrewshire, Teviotdale, Lauderdale, &c., along with the dignity of Steward of Scotland, which became hereditary in his family, and gave his descendants the surname of Stewart, by some branches modified to Steuart or the French form Stuart. The Fess Checquy (q.v.), adopted as the arms of the Stewarts, is emblematical of the chequer of the Steward's board. The connection between the Stewarts and the Fitzalans was shown by Chalmers to have been well known and acknowledged so late as 1336, when Richard Fitzalan, Earl of Arundel, for 1000 merks surrendered to Edward III. his 'hereditary right' to the Stewardship of Scotland, which was supposed to have reverted to him through the forfeiture of the Scottish line.

For seven generations the Stewardship descended without a break from father to son. Walter, the grandson of the first Steward, held in addition the office of Justiciary of Scotland, and was one of the ambassadors sent in 1239 to fetch Marie de Couci, second wife of Alexander II. His third son, Walter, called Balloch, by his marriage with the daughter of Maurice, Earl of Menteith, got that earldom, which, by his great-granddaughter, Margaret, was conveyed to Robert Stewart, Duke of Albany, son of Robert II. Alexander, fourth Steward (1214–83), was regent of Scotland in Alexander III.'s minority; he commanded at the battle of Largs (q.v.) in 1263, and, invading the Isle of Man, annexed it to the Scottish crown. From his second son's marriage with the heiress of Bonkyl sprang the Stewarts of Darnley, Lenox, and Aubigné. James, the fifth Steward (1243–1309), was one of the six regents of Scotland after the death of Alexander III. Walter, the sixth Steward

(1293-1326), occupies a conspicuous place among Bruce's companions-in-arms. He did good service at Bannockburn, and four years later successfully defended Berwick against Edward II. in person. His marriage in 1315 with Marjory, Bruce's daughter, eventually brought the crown of Scotland to his family—'It came with ane lass,' in James V.'s well-known words. His son by Marjory, Robert, seventh Steward (1316-90), on the death of David II. in 1371 ascended the throne as Robert II. He was twice married; first, in 1349, to Elizabeth, daughter of Sir Adam Mure of Rowallan, and secondly, in 1355, to Euphemia, Countess of Moray, daughter of Hugh, Earl of Ross. Elizabeth Mure was related to him within the prohibited degrees, so in 1347 he had obtained a papal dispensation (only discovered in the Vatican in 1789) for the marriage, legitimising those children who had already been born. Hence, in later times, the descendants of this first marriage came to be branded with the suspicion of illegitimacy, while those of the second union would boast their preferable claim to the throne. His third son, Robert (c. 1349-1420), was in 1398 created Duke of Albany; the fourth, Alexander, who in 1374 got the earldom of Buchan on the forfeiture of the Comyns, is infamous in history as the 'Wolf of Badenoch.'

Between 1371 and 1714 (343 years) fourteen Stewarts sat upon the Scottish, and six of these also on the English, throne. A race unhappy as few, they were Robert II. (1316-90); Robert III. (c. 1340-1406), who died of grief, his elder son murdered, his second an English captive; James I. (1394-1437), for eighteen years a prisoner, afterwards murdered; James II. (1430-60), killed at the siege of Roxburgh; James III. (1451-88), murdered, with his son in rebellion against him; James IV. (1473-1513), slain at Flodden—his much-loved mistress, Margaret Drummond, was poisoned; James V. (1512-42), who died broken-hearted by the rout of Solway Moss; Mary (1542-87), beheaded at Fotheringhay, thrice a widow, and for twenty years a captive; James VI. and I. (1566-1625); Charles I. (1600-49), beheaded; Charles II. (1630-85), for fourteen years an exile; James VII. and II. (1633-1701), for twelve years of his youth an exile, and again for the last twelve of his old age; and Mary (1662-94) and Anne (1665-1714), his daughters, who supplanted him, and both died childless. Thus five of the fourteen met with a violent death; two died of grief; and eight succeeded as minors. All the above receive separate articles; but here may be noticed the son and the grandsons of James VII. and II.

By his second queen, Mary of Modena, James had one son, JAMES FRANCIS EDWARD, born at St James's Palace on 10th June 1688. Forty-two privy-councillors, ladies of rank, &c. (more than half of them Protestants) were present in the bed-chamber; but the warming-pan fiction fastened on him the nickname of Pretender. Six months later he was conveyed by his fugitive mother to St Germain, where his boyhood was passed, and where, on his father's death in 1701, he was proclaimed his successor. In an attempt, in March 1707, to make a descent upon Scotland, the young 'Chevalier de St George,' as he was styled by his adherents, showed some gallantry, but was not suffered to land; and after his return he served with the French in the Low Countries, at Malplaquet charging twelve times, and in the last charge receiving a sword-thrust in the arm. But in Mar's ill-conducted rebellion (see JACOBITES) he showed himself heavy, spiritless, even tearful, when, too late in the day, he landed at Peterhead (22d December 1715), and sneaked away six weeks

afterwards from Montrose. France was now closed to him by the treaty of Utrecht, and almost all the rest of his faint, dissolute, prayerful life was passed at Rome, where he died on 1st January 1766. In 1719 he had married the beautiful and high-spirited Princess Clementina Sobieski (1702-65). She bore him two sons, but in 1725 was so disgusted by his preference for the titular Countess of Inverness as to retire for a while to a nunnery. He is buried in St Peter's.

His elder son, CHARLES EDWARD LOUIS PHILIP CASIMIR, known variously as the 'Young Pretender,' the 'Young Chevalier,' and 'Bonny Prince Charlie,' was born at Rome on 31st December 1720. His education was irregular, but from childhood he raised the hopes of the Jacobites by the promise of a bright and chivalrous nature. He first saw service at the siege of Gaeta (1734); fought bravely at Dettingen (1743); and next year repaired to France, to head Marshal Saxe's projected invasion of England. But the squadron which was to have convoyed the transports with 15,000 troops to Kent fled before the British fleet; the transports themselves were scattered by a tempest; and for a year and a half Charles was kept hanging on in France, until at last, sailing from Nantes, he landed with seven followers at Eriska in the Hebrides on 2d August 1745, and on the 19th raised his father's standard in Glenfinnan. The clansmen flocked in; on 17th September Edinburgh surrendered, though the castle still held out; and Charles held court at Holyrood, the palace of his ancestors. There followed the victory over Sir John Cope at Prestonpans (q.v.), the march upon London with 6500 men, the fatal turning at Derby (6th December), the victory over Hawley at Falkirk (17th January 1746), the crushing defeat by the Duke of Cumberland at Culloden (16th April), and Charles's five months' hidings and wanderings, with £30,000 set on his head, in the Hebrides and the western mainland, till on 20th September he got shipping from Moldart to Brittany. The peace of Aix-la-Chapelle (1748) caused his forcible expulsion from France, and thereafter he lived successively at Avignon, Liège, Basel, Florence, and Rome. He seems to have paid two or three secret visits to London between 1750 and 1760; in 1766 succeeded to his father's empty titles; in 1772 married the ill-fated Countess of Albany (q.v.); and for forty years a miserable drunkard, died at Rome, 31st January 1788. By his Scottish mistress, Clementina Walkenshaw, he left a natural daughter, Caroline (1753-89), whom he had created Duchess of Albany. He was buried at Frascati, but translated to St Peter's.

See also COPE (SIR JOHN), CULLODEN, and MACDONALD (FLORA); Ewald's *Life of Prince Charles Edward* (1875); and A. Lang's *Pickle the Spy* (1897).

His brother, HENRY BENEDICT MARIA CLEMENT, Duke of York, Cardinal, and Bishop of Frascati, was born at Rome, 5th March 1725. After the failure of the '45, when he had hastened to Dunkirk to support Prince Charles Edward, he resolved to take orders, and in 1747 received a cardinal's hat from Benedict XIV. Clement XIII. consecrated him Bishop of Corinth *in partibus*, and subsequently appointed him to the suburban see of Frascati, where he took up his residence. He enjoyed, through the favour of the French court, the revenues of two rich abbeys, as well as a Spanish pension; and the liberal charity with which he dispensed his income endeared him to his flock. On his brother's death in 1788 he caused a medal to be struck, bearing the Latin legend, 'Henry IX., king of England, by the grace of God, but not by the will of men.' The French Revolution stripped him of his fortune, but in 1796 he sold his family jewels to relieve the necessities of Pius VI. In 1798 the French plundered his villa,

and he had to flee for his life to Venice. He returned in 1801 on the restoration of the papal authority, George III. having meanwhile in 1800 granted him a pension of £4000. This last, perhaps best, of the Stuarts died at the age of eighty-two on 13th July 1807. The crown-jewels, carried off from England by James II. 119 years before, were bequeathed by him to George IV., then Prince of Wales, who in 1819 caused Canova to erect a monument in St Peter's that bears the names of 'James III., Charles III., and Henry IX.'

Next to the exiled Stuarts in representation of the royal house as heir-of-line came the descendants of Henrietta (q.v.), Charles I.'s youngest daughter, who in 1661 was married to Philip, Duke of Orleans. From this marriage sprang Anne-Mary (1669-1728), who married Victor Amadeus, Duke of Savoy (q.v.) and king of Sardinia; their son, Charles Emmanuel III. (1701-73), king of Sardinia; his son, Victor Amadeus III. (1726-96), king of Sardinia; his son, Victor Emmanuel I. (1759-1824), king of Sardinia; his daughter, Mary (1792-1840), who married Francis, Duke of Modena; their son, Ferdinand (1821-49), who married Elizabeth of Austria; and their daughter, Maria Teresa (born 1849), who in 1868 married Prince Louis of Bavaria, and whom, as 'Mary III. and IV.,' the 'Legitimist Jacobites' of 1891 put forward as the 'representative of the Royal House of these realms.' Rupert, her son, was born at Munich on 18th May 1869, and is ninth in descent from Charles I.

The branch of the family which the Act of Settlement (1701) called to the throne on the death of Queen Anne were the descendants of the Electress Sophia of Hanover, granddaughter of James VI. and I. by her mother, the Princess Elizabeth (q.v.), Electress Palatine and Queen of Bohemia. By that act not only were the above-mentioned descendants of Charles I.'s daughter, Henrietta of Orleans, excluded, but also the Roman Catholic descendants of the Princess Elizabeth's sons. Her Majesty Queen Victoria is twenty-second in descent from Walter Fitzalan, sixteenth from Robert II., and eighth from James VI. and I.

Before proceeding to glance at the cadets of the House of Stewart we may notice here ARABELLA STUART, who, born in 1575, was the daughter of the Earl of Lenox, Darnley's younger brother, so a great-great-granddaughter of Henry VII., a third cousin to Queen Elizabeth, and a first cousin to James VI. and I. She lost her father at two, her mother at six, and was brought up by her maternal grandmother, the imperious Bess of Hardwick. At the age of twenty-seven, shortly before Elizabeth's death, she was suspected of having a lover in the boy William Seymour, who had Tudor blood in his veins; but on James's accession she was restored to favour, only, however, to contract a secret marriage in 1610 with him. Both were imprisoned, and both escaped—Seymour successfully to Ostend, she unsuccessfully in man's attire, for she was retaken in the Straits of Dover. She died, insane, in the Tower of London, 25th September 1615.

See the Life of her by Elizabeth Cooper (2 vols. 1866) and that by Mary E. Bradley (2 vols. 1889).

The cadets of the house may be divided into four classes: (1) descendants of Robert II.; (2) descendants of natural sons of his descendants; (3) descendants of natural sons of Stewart kings; and (4) legitimate branches of the Stuarts before their accession to the throne. To the first belong the Stuarts of Castle-Stewart, descended from Robert, Duke of Albany, Robert II.'s third son, through the Lords Avondale and Ochiltree. They received the titles of Lord Stuart of Castle-Stewart in the peerage of Ireland (1619), Viscount Castle-

Stewart (1793), and Earl (1809). To the second class belong the Stuart Earls of Traquair (1633-1861), descended from a natural son of James Stewart, Earl of Buchan. To the third class belong the Regent Moray (q.v.), the Marquis of Bute, and the Shaw-Stewarts; and to the fourth belong the Earls of Galloway (from a brother of the fifth High Stewart), the Lords Blantyre, the Stuarts of Fort-Stewart, and the Stuarts of Grandtully (from the fourth High Stewart; the last baronet died in 1890).

See, besides works cited at JACOBITES, under the different Stewart sovereigns, and in Marshall's *Genealogist's Guide* (2d ed. 1885), Stewart genealogies, &c. by Symson (1712), Hay of Drumboote (1722), Duncan Stewart (1739), Noble (1795), Andrew Stewart of Castle-milk (1798), A. G. Stuart (for Castle-Stewart branch, 1854), Sir W. Fraser (for Grandtully branch, 1868), W. A. Lindsay (1888); William Townend, *History of the Descendants of the Stuarts* (1858); the Marchesa Campana de Cavelli, *Les Derniers Stuarts à Saint-Germain en Laye* (2 vols. 1871); Percy M. Thornton, *The Stuart Dynasty* (1890); Gibb and Skelton, *The Royal House of Stuart* (1890), with fine illustrations of relics shown at the Stuart exhibition of 1888-89; and Hewison, *Bute in the Olden Time* (2 vols. 1896).

Stewart, ALEXANDER TURNEY, millionaire, was born of Scottish stock at Lisburn, near Belfast, in 1803, emigrated to New York in 1823, and two years later opened his first dry-goods store in Broadway, with a rent of \$250; his retail store built in 1862 cost nearly \$2,750,000. His charities were numerous and bountiful; yet at his death, 10th April 1876, he left some \$40,000,000, which there were no blood relatives to share. See RESURRECTIONISTS, and GARDEN CITY.

Stewart, BALFOUR, LL.D., F.R.S., physicist, was born at Edinburgh, November 1, 1828. He studied at both St Andrews and Edinburgh universities, but in 1846 entered on a commercial career. Seven years later he forsook business, returned from Australia to Edinburgh, and became assistant to Professor Forbes. In 1859 he was appointed director of the Kew Observatory, and in 1870 professor of Physics at Owens College, Manchester. He died, December 19, 1887, near Drogheda, Ireland. He made his first reputation by his work on Radiant Heat (1858), by which he established the equality of the emissive and absorptive powers of bodies. He is rightly regarded as one of the founders of the method of spectrum-analysis, of which the complete theory was given by Kirchhoff a little later (see HEAT and SPECTRUM). In connection with his work on radiant heat the experiments (in conjunction with Professor Tait) on the heating of a rotating disc in vacuo (1865-78) should be mentioned, as should also his remarks on the effect of relative motion on radiation. His other labours were chiefly meteorological, his name being specially associated with such subjects as the relation between sun-spots and temperature and magnetic changes, terrestrial magnetism, and the daily ranges of the meteorological elements. Particularly valuable are his numerous papers on terrestrial magnetism. As a writer of text-books on physics he earned a high reputation, the *Treatise on Heat* (1866; 5th ed. 1888), the *Elements of Physics* (1870; 4th ed. 1891), and the *Conservation of Energy* (1873; 7th ed. 1887) being all excellent works, especially the first. Very concise in statement and suggestive in treatment is his contribution on terrestrial magnetism to the *Encyclopædia Britannica* (article 'Meteorology'). With Professor Tait he published in 1875 *The Unseen Universe, or Physical Speculations on a Future State*, a book which had a phenomenal reception and passed rapidly through several editions (17th ed. 1890).

Stewart, SIR CHARLES. See CASTLEREAGH.

Stewart, DUGALD, philosopher, was born in Edinburgh on the 22d November 1753, and was the son of Matthew Stewart (q.v.). He entered the High School in his eighth year, and remained till his thirteenth. His subsequent course at the university extended from 1765 to 1769. In the departments of study where his own career afterwards lay he was fortunate to find professors of ability and distinction, the moral philosophy chair being occupied by Adam Ferguson. While Stewart gave his highest promise in these subjects he also made great attainments in mathematics and natural philosophy, and likewise in classics. In 1771 he went to study at Glasgow, partly with a view to one of the Snell scholarships at Balliol College, Oxford, and partly to attend the lectures of Dr Reid. It was while there that he wrote an essay on Dreaming, which was his first effort in mental philosophy, and contained the germs of many of his subsequent speculations. He lived in the same house with Archibald Alison, the author of the *Essay on Taste*, and the two became intimate friends through life. He was at Glasgow only one session. In 1772, in his nineteenth year, he was called upon by his father, whose health was failing, to teach the mathematical classes in the university of Edinburgh; in 1775 he was elected joint-professor, and acted in that capacity till 1785. In 1778 Adam Ferguson was absent from his post on a political mission to America, and Stewart taught the moral philosophy class in addition to his mathematical classes. The lectures that he gave on this occasion were wholly his own, and were delivered from notes, as was his practice in after years. On the resignation of Ferguson in 1785 he was appointed professor of moral philosophy, and continued in the active duties of the class for twenty-five years. His lectures were greatly admired and numerously attended. He went over a wide compass of subjects: psychology, or the science of mind proper, metaphysics, logic, ethics, natural theology, the principles of taste, politics, and last of all, political economy, which, from the year 1800, he treated in a separate course. In 1792 appeared his first volume of the *Elements of the Philosophy of the Human Mind*, and in 1793 he published his *Outlines of Moral Philosophy*. He read before the Royal Society of Edinburgh in 1793 his *Account of the Life and Writings of Adam Smith*; in 1796 the *Account of the Life and Writings of Principal Robertson*; and in 1802 the *Account of the Life and Writings of Dr Reid*. In 1805 he took a prominent part in the 'Leslie controversy,' and wrote a pamphlet maintaining Sir John Leslie's claims to the chair of mathematics and defending him from theological aspersions. In 1806, on the accession of the Whig party to power, he received a sinecure office worth £300 a year. The death of his second son in 1809 gave a blow to his health, otherwise indifferent, and he was unable to lecture during part of the following session; Dr Thomas Brown, at his request, acting as his substitute. The following year Brown was appointed conjoint professor, and taught the class till his death in 1820. From 1809 Stewart lived at Kinneil House, near Bonness, which the Duke of Hamilton had placed at his service. In 1810 he published his *Philosophical Essays*; in 1814 the second volume of the *Elements*; in 1815 the first part, and in 1821 the second part, of the *Dissertation on the History of Ethical Philosophy*; in 1827 the third volume of the *Elements*; and in 1828, a few weeks before his death, the *Philosophy of the Active and Moral Powers*. On the death of Brown Stewart exerted himself to secure the appointment of Sir William Hamilton to the chair, but the influence used with the town-council in

behalf of John Wilson ('Christopher North') was overpowering. Stewart resigned his conjoint professorship on the 20th June 1820; he died 11th June 1828.

The philosophy of Stewart was the following up of the reaction commenced by Reid against the sceptical results that Berkeley and Hume drew from the principles of Locke (see SCOTTISH SCHOOL). Hence arose the principles of common sense of Reid, in which Stewart for the most part acquiesced. Stewart also followed and improved upon Reid in the systematic exposition of all the powers of the mind which rendered mental philosophy for the first time a subject of study, independent of metaphysical, logical, and ethical applications; although he also followed it out in all these directions with his usual perspicacity and felicity of exposition. His contributions to the philosophy of taste, in the *Philosophical Essays*, are among the best parts of his writings. Although Stewart was not one of the most original thinkers in his department, yet, by the force of his teaching and the compass of his writings, he did much to diffuse an interest in the speculations connected with the human mind. Amongst notable men who studied under Stewart were Lords Jeffrey and Cockburn, Sir Walter Scott, Lord Brougham, Francis Horner, Sir James Mackintosh, James Mill, Lord Palmerston, and Earl Russell.

His works (11 vols. 1854-58) were edited by Sir W. Hamilton, whose work was completed and the biography added by Professor Veitch.

Stewart, MATTHEW, was born in 1717 at Rothesay in Bute. He studied first at the university of Glasgow, where he was a favourite pupil of Robert Simson, and in 1742-43, when he was a student of divinity in the university of Edinburgh, attended Maclaurin's lectures on fluxions. For a short period he was minister of Roseneath, and in 1747 was elected Maclaurin's successor. He had in the previous year published his *General Theorems of considerable use in the higher parts of Mathematics*. In 1761 he published *Tracts Physical and Mathematical*, and in 1763 his *Propositiones Geometricæ more veterum demonstratæ*. In 1772 he ceased to lecture in the university, and he died on 23d January 1785. The lifelong friendship which existed between him and Simson was unusually cordial, and it is highly probable that the bent of Stewart's mind towards the ancient geometry and his comparative indifference to the modern analysis were due to the example of his master. A biographical account of Stewart by Professor John Playfair will be found in the first vol. of the *Transactions of the Roy. Soc. of Edinburgh* (1788).

Stewarton, a town of Ayrshire, on Annick Water, 5½ miles N. by W. of Kilmarnock. Its speciality is the Scotch bonnet manufactures; but it also carries on carpet-weaving, spindle-making, &c. Pop. (1851) 3164; (1891) 2687.

Stewartry, the name which was given in Scotland to a district governed by a steward, an officer appointed by the king with jurisdiction over crown-lands, and powers similar to those of a lord of regality. While the civil jurisdiction of a steward was equivalent to that of a sheriff, his criminal jurisdiction was much more extensive. The only remaining trace of this jurisdiction exists in the term Stewartry, which in place of county is applied to the district of Kirkcudbright (q.v.; and see GALLOWAY).

Stewing, in Cookery, a very economical way of preparing meat and fruits for food. It differs from boiling in this respect, that only a small quantity of water is used, and the heat applied is so gentle as only to *simmer* it. The more slowly the ebullition is carried on the better. As the small quantity

of water is retained as gravy, nothing is lost. Meat prepared in this way is tender and savoury, but, owing partly to the richness of the gravy, is not very digestible. See COOKERY, DIGESTION.

Steyer, a town of Upper Austria, at the confluence of the Steyer and Enns, 36 miles by rail S. by E. of Linz, is the chief seat of the iron and steel manufactures of Austria, turning out firearms, cutlery, files, nails, chains, &c., and also manufacturing paper, leather, beer. Pop. (1890) 21,499.

Steyning, a town of Sussex, 1 mile W. of the river Adur and $4\frac{1}{2}$ miles N. of Shoreham. Till 1832 it returned two members. Pop. 1670.

Sticking-plaster. See PLASTERS.

Stickleback (*Gasterosteus*), a genus of Acanthopteropterous fishes having the dorsal fin replaced by strong spines which vary in number in the different species. The sticklebacks are small, and the male is brightly coloured, the brightness increasing at sexual maturity. They are widely distributed throughout northern and temperate regions. One of the European species, the Fifteen-spined Stickleback (*G. spinachia*), is marine; the other two—the Ten-spined Stickleback (*G. pungitius*) and the Three-spined Stickleback (*G. aculeatus*)—occur in fresh or brackish water, the latter being so abundant in some parts of England that it is used for manure.

Much interest attaches to the sticklebacks on account of the high degree of parental care exhibited by the male. At the spawning season he constructs a nest of grass and stems of plants firmly cemented together by mucous threads secreted from the kidneys. The nest is barrel-shaped, and has two apertures, thus admitting not only of easy ingress and egress, but also of the constant current of water necessary to the development of the ova. The work of building ended, the eager male, now resplendent in his wedding-ropes, sets forth in search of a mate, whom he coaxes to his nest. After she has quitted it, he enters, fertilises the eggs, and immediately resumes his quest, bringing home another and another mate until the nest is filled with eggs. These eggs he guards with jealous vigilance, freeing them from parasites, and attacking every enemy that comes within reach, even though it be a fish many times larger than himself. With the hatching of the ova his labours become for a time more arduous than ever, for the tiny, active sticklebacks must all be kept safe within the shelter of the nest until they are big enough and strong enough to fend for themselves.

Stieler, ADOLF, editor of the well-known *Atlas* (75 plates; Gotha, 1817-23; new ed. 90 plates, 1898 *et seq.*), was born at Gotha on 26th February 1775, and died at the same place on 13th March 1836, having spent his life in the public service of the grand-duchy. A *School Atlas* and a *Map of Germany* (in 25 sheets) by him were also very popular.

Stier, RUDOLF EWALD, German theologian, was born at Fraustadt, March 17, 1800, studied at Jena, Halle, and Berlin, and had already laboured

as pastor at Frankleben near Merseburg and Wichlinghausen in the Wupperthal when he was appointed in 1850 superintendent at Schkeuditz, and in 1859 at Eisleben, where he died, December 16, 1862. Stier was a man of fervent and somewhat mystical piety, and as an exegete he shows absolute faith in the inspiration and infallibility of his text; but he has no other dogmatisms, and his books are full of observations always ingenious and edifying, if sometimes prolix and far-fetched.

Among his works the most popular have been *The Words of the Lord Jesus* (Eng. trans. 8 vols. 1855-58), *Words of a Risen Saviour* (trans. 1859), *Words of the Angels* (1862), and *Words of the Apostles* (trans. 1869). See the Life by his sons (Wittenberg, 1868).

Stiff Neck. See NECK.

Stigand, Archbishop of Canterbury, enjoyed great favour with Edward the Confessor, who made him his chaplain, then (1044) Bishop of Elmham or of the East Angles. Eight years later the bishop mediated successfully in the interests of peace between the king and Earl Godwin, and was rewarded with the archbishopric of Canterbury, which had been abandoned by Archbishop Robert. But his appointment was generally looked upon as uncanonical, and was still so regarded even after Stigand received the pallium from Pope Benedict X., Benedict's own election being held to be illegal. On the death of Harold, Stigand gave his vote for Edgar Atheling to be king, and for this reason, and because he was a firm friend of the House of Godwin, William the Conqueror distrusted him, and induced the pope to send a commission of cardinals, who deprived him of his dignities and sentenced him to perpetual imprisonment. But Stigand died shortly afterwards at Winchester; it is said he was starved to death, though whether voluntarily or under compulsion is uncertain.

Stigma. See FLOWER.

Stigmara, the root of *Sigillaria* (q.v.) and other trees.

Stigmatisation (Lat. *stigmatizatio*, 'a puncturing', from Gr. *stigma*, 'a puncture'), the name applied by Roman Catholic writers to the supposed miraculous impression on certain individuals of the 'stigmata,' or marks of the wounds which our Lord suffered during the course of His Passion. St Paul says of himself, 'I bear in my body the marks of the Lord Jesus' (Gal. vi. 15), but his bold metaphor is most likely taken from the notion of soldiers branding on their bodies their general's name. In the early days many Christians branded the name of Christ on their foreheads, and various voluntary mutilations for Christ's sake were practised by enthusiasts. The stigmata comprise not only the wounds of the hands and feet, and that of the side, received in the crucifixion, but also those impressed by the crown of thorns and by the scourging. The impression of the stigmata is by those who believe in its reality regarded as a mark of the signal favour of our Lord, manifested to believers specially devoted to the contemplation of His Passion. The most remarkable example of stigmatisation is that said to have occurred in 1224 to Francis of Assisi, on the mountain of Alverno. Being absorbed in rapturous contemplation of the Passion of Christ, he saw a seraph with six shining wings, blazing with fire, and having between his wings the figure of a man crucified, descend from heaven and approach him, so as to be almost in contact. After a time the vision disappeared, leaving the soul of Francis filled with reverence and awe. And now he became aware that in hands, feet, and side he had received externally the marks of crucifixion. These mysterious marks continued during the two years

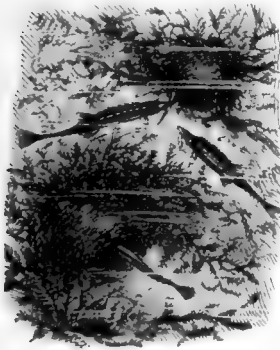

Sticklebacks and Nests.

until his death, and are claimed to have been seen by many eye-witnesses, including Pope Alexander IV.

The Dominicans openly disputed the fact, but at length made the same claim for Catharine of Sienna, whose stigmata were explained as at her own request made invisible to others. The Franciscans appealed to Sixtus IV., and that pope, himself a Franciscan, forbade representations of St Catharine to be made with the stigmata. Still the fact is recorded in the breviary office, and Benedict XIII. granted the Dominicans a special feast in commemoration of it. Many others, especially women, are claimed to have received all or some of the stigmata. The last to be canonised (1831) for this reason was Veronica Giuliani, who is said to have received in 1694 first the marks of the crown of thorns, and afterwards those of the crucifixion. More recent cases are those of Anna Katherina Emmerich (1774-1824), who became a nun at Agnetenberg; 'L'Ecstatica' Maria von Mörl of Caldaro (1839); Louise Lateau (1850-83, in 1868), whose stigmata were stated to bleed every Friday; and Mrs Girling (1827-86, about Christmas 1864), of the New Forest Shaker community. Dr Imbert Gourbeyre, in his work *Les Stigmatisées* (1873), enumerates 145 persons, of whom but 20 were men, as having received the stigmata, and of these 80 lived before the 17th century. Apart altogether from the question of the value of the evidence offered, we may reasonably conclude that some kind of stigmatisation is a pathological condition of occasional occurrence, but from this to the assertion that it is a special sign of divine favour is a wide and an unwarrantable leap.

Stilbite. See ZEOLITE.

Stilicho, a famous Roman general, the mainstay of the western empire after the death of Theodosius the Great, is said to have been a Vandal, and was born about 359. Through his courage and ability he rose rapidly in rank, was sent as ambassador to Persia in 384, and soon after his return rewarded with the hand of Serena, niece of Theodosius. His rise caused a jealousy that soon grew to rankling hatred in the heart of Rufinus, the ambitious minister of Theodosius. In 394 Stilicho departed for Rome in charge of the youthful Honorius, who had been committed to his care, placed him on the throne of the western empire, and administered in his name the affairs of state. On the death of Theodosius (end of 394) Rufinus, the guardian of Arcadius, instigated Alaric to invade Greece while Stilicho was engaged in chastising the invaders of the Roman territories on the Rhine and in Gaul. Returning, he at once set out for Constantinople and destroyed Rufinus, then marched against Alaric, blocked him up in the Peloponnesus, but through over-confidence permitted him to escape across the isthmus with his captives and booty. In 398 his daughter Maria became the wife of Honorius. His old opponent, Alaric, after several inroads upon the eastern provinces of the western empire, now invaded Northern Italy, but was signally defeated at Pollentia (403) and Verona by Stilicho, who had hurriedly called in the Roman legions from Rhetia, Gaul, Germany, and even Britain. Stilicho's ambition now led him to attempt the introduction of his own family to the imperial succession—a statement disbelieved by Gibbon, who considers it merely as an invention of the crafty Olympius—by the marriage of his son with the heir-presumptive Placidia, the daughter of Theodosius, and to attain this end he made overtures of alliance to Alaric, which were gladly accepted. But the dreadful inroad of Radagaisus (406) at the head of more than 200,000 (some say 400,000) barbarians,

who ravaged the whole country as far as Florence, compelled the great general of the West to shelve for a time his ambitious schemes. With a small but chosen army of veterans, aided by a body of Huns under Uldin (father of Attila), and of Visigoths under Sarus, he so harassed the invaders that they were forced to give him battle. They were soon completely routed; Radagaisus was put to death, and his followers sold as slaves. Stilicho now returned to his own ambitious schemes, established enmity between Rome and Byzantium by seizing on eastern Illyricum and inducing Alaric to transfer his allegiance to Honorius. But Honorius, who had been prejudiced against Stilicho by one of his officers, Olympius, refused to take eastern Illyricum from the Byzantine empire; and subsequently by an artful harangue he so influenced the soldiers of the army of Gaul that they rose *en masse* against the partisans of Stilicho. Stilicho himself was at Bologna; and on the news of the revolt, his most zealous friends urged immediate action against Olympius and the Pavian rebels; but for the first time in his life vacillation seized the soldier. He was soon forced to flee to Ravenna, where he was murdered, 23d August 408. Thus perished the last of the series of distinguished aliens, who, as emperors, warriors, or politicians, had propped up the Roman empire for 150 years, with a stern and resolute zeal equal to that of the early Romans themselves. Three months after his death Alaric and his Visigoths were at the gates of Rome.

Still is an apparatus for Distillation (q.v.). It consists essentially of a vessel in which the liquid to be distilled is placed, the vapour being conducted by means of a *head* or *neck* to the condenser or worm, where it is cooled by water or other means, and again forms liquid. The still itself varies greatly according to the purpose for which it is used. It is made of copper, iron, earthenware, or glass, and is heated by naked flame or steam-heat. The steam may either be applied on the outside by means of a *jacket* or inside by the use of a *coil*. A *vacuum still* is one in which a partial vacuum is constantly maintained by means of an air-pump, distillation under such circumstances being more rapid and at a lower temperature. See also RETORT.

Stillborn. See OBSTETRICS, ABORTION, and FŒTUS.

Stillicidium. See EAVESDRIIP, SERVITUDE.

Stillingfleet, EDWARD, a learned English divine, was born at Cranborne in Dorsetshire on 17th April 1635. There and at Ringwood he received his early education, at thirteen entered St John's College, Cambridge, where he took his degree in 1652, and the year after obtained a fellowship. For some years after leaving college he was occupied as a private family tutor; and in 1657 he was presented to the rectory of Sutton in Bedfordshire. In 1659 appeared his *Irenicum*, or *the Divine Right of Particular Forms of Church Government examined*, a noble catholic-spirited attempt to find a mean as a basis of union for the divided church. His views savoured somewhat more of latitudinarianism than could be pleasant to the High Church party, and indeed Stillingfleet himself afterwards thought fit to modify them. His *Origines Sacrae*, or *the Truth and Divine Authority of the Scriptures* (1662), a creditable contribution to the Apologetics of the day, was followed by his *Rational Account of the Grounds of the Protestant Religion* (1664), a defence of the Church of England from the charge of schism in its separation from that of Rome. These works were received with great favour, and quickly led to rich preferment. In 1665 the Earl of Southampton

presented him to the rectory of St Andrews, Holborn; he was also appointed preacher at the Rolls Chapel, and shortly after lecturer at the Temple, and Chaplain in Ordinary to Charles II. In 1670 he became Canon Residentiary, in 1678 Dean, of St Paul's. In the Court of Ecclesiastical Commission instituted by James II. Stillingfleet declined to act; and after the Revolution of 1688 he was raised to the bishopric of Worcester. He died at Westminster on 27th March 1699, and was buried in Worcester Cathedral. So handsome in person as to have been popularly called 'the beauty of holiness,' he had, Burnet tells us, a reserved and haughty temper. But he was courteous and temperate in debate, and he had the rare merit for a theologian of being capable of appreciating the courtesy of an opponent. Thus, in the controversy that grew out of his *Mischiefs of Separation* (1680), he candidly confessed himself overcome by the answer of John Howe, who, he said, wrote 'more like a gentleman than a divine, without any mixture of rancour.' Other works were his *Origines Britannicæ, or Antiquities of the British Churches* (1685), and a defence of the doctrine of the Trinity (1697). His collected works, with Life by Dr Timothy Godwin, were published in 1710 (6 vols. folio); a supplementary volume of Miscellanies, edited by his son, in 1735. See Tulloch's *Rational Theology in the Seventeenth Century* (vol. ii. 1872).

Stillwater, capital of Washington county, Minnesota, on the navigable St Croix River (which here expands into a narrow lake), 18 miles by rail NE. of St Paul. It has a large lumber trade, and contains sawmills, a foundry, and flour-mills. Pop. (1870) 4124; (1890) 11,260.

Stilt (*Himantopus*), a widely distributed genus of wading-birds belonging to the Snipe family (Scolopacidae). They have long slender bills and very long wings and legs, the length of the legs being almost equal to that of the body. The Black-winged Stilt (*H. candidus*) has been occasionally met with in Britain, but is only a rare summer visitor, though it breeds in Holland and southern Europe. The prevailing colours of plumage among the stilts are black and white, but a pure black species inhabits New Zealand.

Stilton, a village of 650 inhabitants in the north of Huntingdonshire, 6 miles SW. of Peterborough. It gives name to the well-known Cheese (q.v., p. 142), most of which now is of course manufactured elsewhere.

Stilts, poles with steps or supports at a sufficient distance from the lower end to allow a man standing on the steps to walk clear of the ground and with longer strides. Useful in all marshy lands, they were in old days specially serviceable in the French Landes (q.v.), where the shepherds practically spent the whole day on stilts. Elsewhere they serve for crossing streams (as the upper Tweed and Clyde), for a (somewhat dangerous) pastime for boys, and for displays of acrobatic skill. At Namur one of the diversions of the carnival was a tournament between bodies of men mounted on stilts.

Stimulants are agents which increase the activity of the vital functions generally, or of one system or organ. Their action is usually understood as being transient and rapid, but need not necessarily be so. They are most commonly employed to act on the central nervous and circulatory systems, but hepatic, renal, and gastric stimulants are also common terms in medicine. Popularly only those which act on the nervous and circulatory systems are well known, and include alcohol in the form of wines and spirits, sal-volatile, smelling-salts and other preparations of ammonia, besides ether, camphor, various preparations of lavender,

peppermint and other essential oils, ginger, &c. Cold and electricity also act as stimulants. They are useful in fainting, nervousness, shock, hysteria, and similar conditions. See the articles on ALCOHOL, ELECTRICITY (MEDICAL), &c.

Sting-fish. See WEEVER.

Stinging-animals. In many different ways animals have the power of stinging. To begin with the minutest, it is likely that the trichocysts of the slipper-animalcule (Paramœcium) have some such power. Almost all the Cœlenterates, such as jellyfish and Portuguese-man-of-war, have Stinging-cells (q.v.), and in a few Turbellarians the same recur, while the dorsal papillæ of some Nudibranch Gasteropods seem to sting the mouths of animals which try to eat them. The stings of ants, bees, and wasps and some other Hymenoptera are abdominal structures, perhaps vestiges of appendages, and they are associated with a poison-secreting gland. The poison of spiders is lodged in the chelicerae or first pair of oral appendages. The sting of the scorpion consists of a double poison-gland lodged in the sharply pointed segment or 'telson' which lies behind the anus at the end of the tail. The sting-rays (Trygonidæ) and the sting-fish or weevers (Trachinus) have no special poison-glands, but it is likely that the slime which enters into the ugly wounds caused by their sharp spines is in part the cause of the inflammation which follows. Among the Scorpenidæ the genus *Synanceia* has a poison-bag in each of the dorsal spines. Finally, the stinging powers of the venomous snakes are due to the modification of one of the salivary glands on each side as a poison-gland and to the adaptation of the teeth as fangs. In the poisonous Mexican lizard *Heloderma* an approach to a similar specialisation occurs. See also POISON.

Stinging-cells, or CNIDOBLASTS or NEMATOCYSTS, are characteristic of all Cœlenterata except Ctenophores. To them the jelly-fish, Portuguese-man-of-war, sea-anemones, and the like owe their power of stinging. They protect their possessors against some of their enemies and they serve to benumb or kill the small animals on which most of the Cœlenterates feed. Each stinging-cell contains a long coiled lasso or cnidocil bathed in poisonous fluid; at the base of the cavity in which the lasso lies there is a little living matter and a nucleus; projecting from the surface there is often a small trigger-like peak. When the cell is stimulated, in some cases at least by nervous impulse from adjacent nerve-cells, the lasso, which is many times the length of the cell, is rapidly everted. After this has taken place the cell dies. Often the cnidoblasts are grouped in little 'batteries' especially abundant on the tentacles or similar structures. They are usually situated on the external ectoderm, but are sometimes endodermic. Similar cells occur in some Turbellarian Worms. See CELENTERATA, HYDRA.



Sting-ray (*Trygon pastinaca*).

Sting-ray (*Trygon*), a genus of cartilaginous fishes, of the order of Rays (q.v.) and family Trygonidæ. The long

tail bears dorsally a long bi-serrated spine, which represents the dorsal fin, and is sometimes about eight inches in length. This is used as a defensive weapon, and gives an ugly wound, often followed by great inflammation, perhaps due to the mucous secretion of the fish, for there is no poison in the strict sense. Some members of the family, e.g. *Urogyrnus*, are without this weapon. The sting-rays are for the most part tropical fishes, and some, e.g. *T. sephen* and *T. uarnak*, attain a large size. Only one species occurs in the British seas (*T. pastinaca*), popularly known as the Fire-flaire. The spine of the sting-ray is used by the savages of the South Sea Islands as a point to their spears.

Stinkpot. See ASPHYXIANTS.

Stinkstone, or SWINESTONE, a kind of marble or limestone remarkable for the fetid urinous odour which it emits when rubbed. It contains a little sulphur.

Stink-trap. See SEWAGE.

Stink-wood (*Oreodaphne fatida*), a tree of the natural order Lauraceæ, a native of the Cape of Good Hope, remarkable for the strong disagreeable smell of its wood, which, however, is hard, very durable, takes an excellent polish, and resembles walnut. It has been used in shipbuilding.

Stint. See SANDPIPER.

Stipa. See FEATHER-GRASS.

Stipend. The stipend is the provision made for the support of the parochial ministers of the Church of Scotland. It consists of payments in money or grain, or both, made out of the tithes or teinds of the parishes (see TEINDS). Accordingly it varies in amount with the extent of the parish and the state of the free teinds, or of any other fund specially set apart for the purpose. By the Act 1617, chap. 3, power was given to commissioners named under the act to modify, at their discretion, a perpetual local stipend to the ministers of all parish churches from the parochial teinds. The maximum stipend to be given by the commissioners was 10 chalders victual, or 1000 merks (£55, 11s. 1½d.) per annum, or proportionally money and victual, with a manse and glebe. Commissioners with more liberal powers were appointed in 1621, and again in 1627 and 1633 and subsequent years. Shortly after the Union the powers vested in the commissioners under the then extant commissions were transferred to the Lords of Council and Session, sitting as a Court of Commission of Teinds; and the exclusive powers of the Court of Session in assigning, modifying, and 'localling' stipends were left intact by the Judicature Act. When the existing stipend of a minister is deemed insufficient, the Court, provided there remains any surplus or free teind in the parish, may award out of it such augmentation of stipend as is considered suitable. But no augmentation can be applied for within twenty years after the last augmentation. By statute 50 Geo. III. chap. 84, all stipends which come short of £150 per annum are made up to that amount from government funds—a sum of £10,000 annually being set apart from the revenue for that purpose. By 5 Geo. IV. chap. 72, a parish minister who has neither manse nor glebe, and whose income is under £200 per annum, is entitled to an allowance making up his stipend to a sum not exceeding that amount; if there is a manse but no glebe, or a glebe but no manse, the minister's income may be supplemented so as to ensure him £180 per annum. Ministers under these acts are also entitled to an allowance of £8, 6s. 8d. for communion elements. By 7 and 8 Vict. chap. 44, the stipend of *quoad sacra* parishes is fixed where there is a manse at not less than £100 per annum,

and where there is no manse at not less than £120 per annum. These stipends are voluntary, being provided through the endowment schemes of the Church, and the Acts 50 Geo. III. chap. 84, and 5 Geo. IV. chap. 72, have no application to the ministers of such *quoad sacra* parishes.

The terms at which stipend is payable are Whitsunday and Michaelmas. The reason why Michaelmas (29th September) is taken in preference to Martinmas is that the stipend is held to come in place of the tithes, which were due at the separation of the crop from the ground. Where the incumbent is admitted before Whitsunday he is entitled to the whole year's stipend, because his entry is considered as prior to the sowing of the corn; and, for the same reason, if his interest has ceased before that term, he has no right to any part of the fruits of that year. If he has been admitted after Whitsunday, and before Michaelmas, he is entitled to the half of that year's stipend; and in the same way the incumbent whose interest ceases between Whitsunday and Michaelmas has a right to the half-year's stipend, and if his interest does not cease till after Michaelmas he gets the stipend of the whole year. The stipend accruing during a vacancy was formerly at the disposal of the patron of the parish for pious uses; but by statute 54 Geo. III. chap. 169, it was given to the Ministers' Widows Fund. On the decease of a minister a sum equal to a half-year's stipend is payable to his family or nearest of kin (see ANNATES).

Stipendiary Magistrates. See BOROUGH.

Stirling, the county town of Stirlingshire, stands on the south bank of the winding Forth, 36 miles NW. of Edinburgh and 29 NNE. of Glasgow. Like Edinburgh, to which in its main features it bears a striking resemblance, it no doubt owes its origin to the strong natural fortress of its Castle Hill, which rises gradually from the east to a height of 420 feet above the sea or 340 above the plain, and fronts the west with a steep precipitous wall of basaltic rock. The Castle, which commands magnificent views of the Grampians, the Ochils, and the 'Links of Forth,' dates from immemorial antiquity, though few, if any, of the existing buildings are earlier than the days of the Stewart sovereigns, who often kept court here. These include the Douglas room (where the Earl of Douglas was stabbed by James II., 1462), James III.'s parliament-hall (now a barrack-room), James V.'s palace, and James VI.'s chapel (now a store-room). Stirling has many other objects of interest, as Argyll's Lodging (1630, since 1799 a military hospital); ruined Mar's Work (c. 1570); Greyfriars Church, so called, but properly the church of the Holy Cross, or Holy Rood, the parish church of Stirling (in 1656 divided into two); the colossal statue of Bruce (1877); the new cemetery, with half-a-dozen statues of Reformers and Covenanters and a marble group of the Wigtown martyrs; Cowane's Hospital or the Guildhall (1637); the King's Knot and King's Park; the Mote or Heading Hill; the old four-arch bridge (c. 1400—the 'key of the Highlands'); Robert Stevenson's new bridge (1832); and the Smith Institute (1874), with picture-gallery, reading-room, library, and museum, where now is preserved the 'Stirling Jug' (1497), the standard of the old Scots pint. Other modern edifices are the County Buildings (1875), the public hall (1883), and the High School (1855-89). In the neighbourhood are Bannockburn (q.v.); the ruins of Cambuskenneth Abbey, founded by David I. in 1147 for Augustinian monks, and the burial-place of James III.; and the Abbey Craig (362 feet), crowned by the Wallace Monument (1861-69), a tower 220 feet

high. Stirling has manufactures of tartans, tweeds, carpets, agricultural implements, &c. A royal burgh as early as 1119, it unites with Dunfermline, Culross, Inverkeithing, and Queensferry to return one member to parliament. Pop. (1851) 12,837; (1881) 16,013; (1891) 16,781. Stirling (formerly *Strivelyne* or *Estrivelin*, and also *Snowdown*) has a wealth of historic memories—the death of Alexander I. and William the Lion; Wallace's victory of Stirling Bridge (1297); the great siege of the castle by Edward I. (1304); the birth of James III.; the coronation of Queen Mary; the baptism and coronation of James VI.; the slaughter of the Regent Lennox (1571); the birth of Prince Henry (1594); the capture of the castle by Monk (1651); and its unsuccessful siege by the Jacobites (1746).

See *History of the Chapel Royal of Stirling* (Grampian Club, 1882), and *Charters of Stirling* (Glasgow, 1884).

Stirling, JAMES HUTCHISON, the most eminent of later Scottish philosophers, was born at Glasgow, June 22, 1820, took the course in both arts and medicine at Glasgow University, and practised a short time as a physician in South Wales. He next went to Germany, and gave himself devotedly for some years to the study of philosophy. The publication of his masterly and epoch-making work, *The Secret of Hegel: being the Hegelian System in Origin, Principle, Form, and Matter* (2 vols. 1865), opened up an unknown world to English readers, and gave a powerful impulse to the study of philosophy generally. It would be difficult, perhaps impossible, to find in the entire range of the literature of philosophy a higher masterpiece of exposition than this combination of erudition, analytic genius, and perspicuity. To this work, as full of individuality as learning, there followed in 1881 a complete *Text-book to Kant*, comprising a translation and reproduction of the *Critique of Pure Reason*, with a commentary and biographical sketch. These two works stand together in the most intimate relation, for, according to Stirling, from Kant's antecedent system Hegel's philosophy itself was but 'a development into full and final shape.' At the same time Dr Stirling brought Kantian speculation into line with English thought by demonstrating that the central problem of the critical philosophy was a question that had been already propounded, if not answered, by Hume. Stirling received the degree of LL.D. from Edinburgh in 1867, and was elected a foreign member of the Philosophical Society of Berlin in 1871. He delivered the first course of Gifford Lectures at Edinburgh, and these were published in 1890, the whole forming a vigorous if somewhat discursive work, in which natural theology is considered in its relation to the history of philosophy, and investigated mainly from the point of view of reason and the principles involved in the Theistic inference. Of the famous three proofs—the Teleological, the Cosmological, and the Ontological—he deals mainly with the first. 'Begin with which we may, and let them be separated from each other as they may be in time, the three, after all, do constitute together but the three undulations of a single wave, which wave is but a natural rise and ascent to God, on the part of man's own thought, with man's own experience and consciousness as the object before him.' Other works of Dr Stirling's are *Sir William Hamilton: being the Philosophy of Perception* (1865), an assault on Hamilton's doctrine of perception more serious still than Mill's; an excellent translation of Schwegler's *History of Philosophy* (1867; 11th ed. 1891); *Jerrold, Tennyson, and Macaulay, &c.* (1868); *As Regards Protoplasm* (1869; complete ed. 1872), a convincing answer to Huxley's *Essay on the Physical Basis of Life*; *Lectures on the Philosophy of Law* (1873), together with an incisive

attack on Whewell and Robertson Smith for their statements anent Hegel's relations to Newton and the calculus; *Burns in Drama* (1878); *Darwinianism: Workmen and Work* (a criticism of the three Darwins, 1894); besides weighty lectures on such subjects as Materialism, Philosophy in the Poets, the Community of Property, Nationalisation of Land, &c. He contributed the article on Kant to the present work.

Stirling, WILLIAM ALEXANDER, EARL OF, minor Scottish poet, a contemporary and dear friend of Drummond of Hawthornden, was born at Menstrie House near Alloa, most probably about 1567—hardly so late as 1580, the usual date formerly given. He studied at Glasgow and Leyden, travelled through France, Spain, and Italy with Archibald, seventh earl of Argyll, and began his career as a poet by publishing at Edinburgh, in 1603, his tragedy of *Darius*, quickly followed by *Aurora*, a collection of sonnets (Lond. 1604), *Crasus* (together with *Darius*, 1604), the *Alexandrian Tragedy* (1605), and *Julius Cæsar* (1607). These were collected as *The Monarchicke Tragedies* in 1607. He was knighted by 1609; in July 1613 was attached to the household of Prince Charles, as before he had been to Prince Henry's; in 1614 was made Master of Requests for Scotland, publishing the same year the first part of his great poem of *Doomedday* (second part, 1637), which extends to 11,000 verses, and which himself even allows in the dedication to be of 'too melancholic a nature for young minds.' He received in 1621 the grant of 'Nova Scotia'—a vast tract of Canada and the northern part of the modern United States—his charter being renewed in 1625; and in 1631 he received the patent of sole printer for thirty-one years of King James's version of the Psalms, a work to which he had contributed greatly, but which proved an utter failure. In 1628 he was made Secretary of State for Scotland, which office he held till his death, despite his unpopularity. Baillie writes of him as 'extremely hated of all the country, for his alleged bribery, urging of his psalms, and the books for them.' In 1627 he was made Keeper of the Signet, a Commissioner of Exchequer in 1628, and one of the Extraordinary Judges of the Court of Session in 1631. The French pushed their conquests in America, and Alexander's grant of lands thereby became useless. He was promised £10,000 compensation, but the money was never paid. In 1630 he was created Lord Alexander of Tullibody and Viscount Stirling. In 1633, at the crowning of Charles in Holyrood, he was made Earl of Stirling and Viscount Canada, in 1639 also Earl of Dovan, but he sank into insolvency, and died in London, 12th September 1640. His body was embalmed and buried at Stirling a few months later. The title died out with the fifth earl in 1739. His tragedies are not dramatic, but their quatrains are gracefully written, albeit the quantities are monstrous—witness *Ixion*, *Nicænor*, *Orion*, and *Eumènes*. The *Parænesis* to Prince Henry is perhaps his finest work; the songs, sonnets, elegies, and madrigals forming the *Aurora* are sadly marred by conceits, yet show rich fancy and ingenuity, though scarce even a Scotchman can claim for them that they sparkle still the right Promethean fire. These amatory poems the author did not include in his collected *Recreations with the Muses* (folio, 1637). A complete edition of his poems appeared at Glasgow, in 3 vols., in 1870.

See the Rev. Charles Rogers, *Memorials of the Earl of Stirling and the House of Alexander* (2 vols. 1877).

Stirling-Maxwell. See MAXWELL.

Stirlingshire, a midland county of Scotland, forming the border-land between Highlands and

Lowlands, is bounded by Perth, Clackmannan, Linlithgow, Lanark, and Dumbarton shires. With a maximum length and breadth of 46 and 22 miles, it has an area of 467 sq. m., or 298,579 acres, of which 3294 are foreshore and 8946 water. The Forth traces much of the northern and all the north-eastern boundary; on the western lies Loch Lomond; and other lakes and streams belonging partly or wholly to Stirlingshire are Lochs Katrine and Arklet, and the Avon, Carron, Bannock, Endrick, and Blane. Ben Lomond, in the north-west, attains 3192 feet; and lesser elevations are the Gargunock Hills (1591 feet), Kilsyth Hills (1393), Campsie Fells (1894), and Fintry Hills (1676). A considerable part of Stirlingshire is occupied by the carse of Stirling and Falkirk, which were formerly covered for the most part with unproductive moss. On the removal of the moss-soil, part of which was floated off into the Forth by the agency of running water, a rich clay soil, of various depths, from a plough furrow to 20 or even 30 feet, was reached, and now is cultivated with the most marked success. About 40 per cent. of the whole area of the county is in cultivation; woods cover 14,241 acres. Coal and ironstone are largely mined; and there are the great ironworks of Carron and Falkirk, besides manufactures of woollens, cotton, chemicals, &c. The chief towns are Stirling, Falkirk, Kilsyth, Denny, and Grange-mouth. The county returns one member to parliament. Pop. (1801) 50,825; (1841) 82,057; (1881) 112,443; (1891) 125,608. Antoninus' Wall is the principal antiquity; and no fewer than six battles have been fought within Stirlingshire—Stirling Bridge, 1297; Falkirk, 1298; Bannockburn, 1314; Sauchieburn, 1488; Kilsyth, 1645; and Falkirk, 1746.

See the articles on the above battles, towns, &c.; and Nimmo's *History of Stirlingshire* (1777; 3d ed. 1880).

Stitch in the side is the popular and expressive name applied to sharp pains felt in various parts of the side. It seems that these may be due to various causes; thus, they may be associated with pleurisy where there is no effusion, or with a stretching of the not uncommon adhesions between two pleural surfaces, or simply with local spasms of the respiratory muscles, as when a person takes violent exercise after a full meal, or perhaps even with a slight twisting of part of the intestine. When the stitch is but slight it is often removed by stooping, hence the popular remedy is to make a cross upon the foot.

Stitchwort. See STARWORT.

Stiver (Dutch *stuiver*), a coin of Holland, equivalent to a penny sterling, being the $\frac{1}{20}$ th of a guilder or gulden. See FLORIN.

Stoat. See ERMINE.

Stobæus, JOANNES, a native of Stobi in Macedonia, who compiled for his son Septimus, about 500 A.D., an anthology in four books from as many as 500 Greek poets and prose-writers. It has preserved for us fragments from many works now lost, and is especially rich in quotations from the Greek dramatists. Originally forming one whole, the work in course of time became divided into two divisions, each of two books: *Eclogæ Physicæ et Ethicæ* (ed. Gaisford, 1850; Meineke, 1860-64), and *Anthologion or Florilegium* (Wachsmuth, 1884), containing the precepts on political and ethical subjects (ed. Gaisford, 1822-25; Meineke, 1856-57).

Stock, or STOCK GILLYFLOWER (*Matthiola*), a genus of plants of the natural order Cruciferae, having cylindrical or compressed pods, and a stigma consisting of two upright appressed plates, the outer side of which often rises into a knob or horn. The

species are herbaceous, annual or perennial, or half-shrubby, natives of the countries around the Mediterranean Sea, most of them thickly clothed with white or grayish stellate hairs; the flowers in racemes, and generally beautiful and fragrant. Some of the species have long been much cultivated, and many fine varieties have been produced by cultivation. *M. incana*, a very rare and even doubtful native of England, is probably the parent of the greater number of the cultivated kinds with hoary leaves, known as Brompton Stock, &c.; whilst those with smooth leaves, called Ten-week Stock, German Stock, &c., are referred to *M. annua*, *M. glabra*, and *M. fenestralis*, which, perhaps, are mere varieties of one species. The sandy shores of Wales and of Cornwall produce a species, *M. sinuata*, the large purple flowers of which are fragrant only at night—a characteristic also of several other species. Stocks are always raised by gardeners from seed, which even the double kinds often produce, a multiplication of the petals having taken place without loss of the parts of fructification. Of the seedlings, however, some produce double and others single flowers, so that only some gratify the cultivator. The hoary-leaved stocks are generally treated as biennials, although, in reality, they may almost be reckoned perennial; and it is not desirable that they should flower in the first year, as the plants become stronger when they remain without flowering till the second year, and produce richer racemes of flowers. The smooth-leaved stocks are treated as annuals. The beautiful little annual called Virginian Stock does not belong to this genus, although it is of the same natural order. Its habit is indeed very different. It is *Malcolmia maritima*, and, notwithstanding its popular name, is a native of the shores of the Mediterranean. It has become one of the most favourite British flowers, almost rivalling mignonette, and is all the more esteemed because it grows well in the little garden-plots which are exposed to the smoke of towns.

Stockbridge, a little market-town of Hampshire, on the Anton or Test, 8 miles W. by S. of Andover. Till 1832 it returned two members to parliament; Steele at one time was its representative. It has a well-known racecourse and training stables. Pop. 873.

Stock-exchange. The London Stock-exchange as a corporate body only dates from the commencement of the 19th century. Prior to the establishment of the Stock-exchange in 1801 transactions in the funds were conducted in a very slipshod manner by groups of individuals, who till about 1698 used the old Royal Exchange in London as a meeting-place, and then for a century made one of the network of alleys in Cornhill their headquarters, congregating in Change Alley both in the open air and in the Jonathan and Garraway coffee-houses. Dealings in government funds were also conducted in the Rotunda Room in the Bank of England. The founders of the Stock-exchange acquired premises in Capel Court, facing the eastern side of the Bank of England. The original capital subscribed for providing the accommodation was 400 shares of £50 paid. Nothing further was required for upwards of half a century in the way of capital, though very considerable expenditure, especially since 1870, has raised the total outlay for the old building and extensions to over half a million sterling. In the early days of stock-dealing transactions were almost entirely in the different forms of British government funds, lottery bonds, and floating debt; but Change Alley, just as Capel Court in the 19th century, had wild fits of gambling in company schemes, of which the most memorable, the South Sea Scheme (q.v.), culminated in 1720.

At the time the first stone of the Stock-exchange building was laid in 1801 the total national debt of Great Britain was some £550,000,000, and the Stock-exchange list, published bi-weekly, comprised only six securities, chiefly British government stocks. Foreign governments first came to the English market as borrowers in 1820 to 1825, and the bonds of various European and American states, Russian, Portuguese, Neapolitan, Danish, Greek, Colombian, Mexican, Buenos Ayres, Chilean, Peruvian, &c., came to be dealt in. There were also transactions in a few canal, insurance, and industrial companies. Numerous banking corporations were established immediately after 1833. The introduction of railways in the United Kingdom and on the Continent in the period from 1840 to 1846 added largely to the business of the Stock-exchange. The gold-discoveries of 1848-50 brought about the formation of a crowd of mining schemes. The introduction of joint-stock companies after the Act of 1862, the growth of foreign government debts, and the introduction of Indian and colonial borrowings, municipal loans, gas, water, shipping, telegraph, tramway, &c. undertakings, as well as United States, Indian, and South American railroad securities, have so added to the official list of the London Stock-exchange that the nominal amount of stock and securities quoted in the list that appears daily under the authority of the committee was at 31st December 1891 to the amount of £6,347,000,000, or, deducting foreign loans with coupons payable abroad, £4,562,000,000; and this is exclusive of an enormous amount of capital of miscellaneous company issues, which individually have not been of sufficient importance to obtain a quotation in the official list. These latter though not quoted are dealt in.

As regards the United Kingdom, beyond the London Stock-exchange there are various provincial establishments for conducting business in public securities. Manchester, Liverpool, Leeds, Birmingham, Bristol, Glasgow, Edinburgh, Dublin, Belfast, and other important centres of the United Kingdom have their stock-exchanges administered by committees, and having rules and regulations much on the same lines as those of the great London establishment. On the Continent, too, every important city has its stock-exchange or *Bourse*. New York (about 1100 members in 1891), Philadelphia, Baltimore, Chicago, San Francisco, and some other important American cities have their stock-exchanges; and there are also similar establishments termed *Bolsas* in leading cities of South American states. Transactions in public funds and securities of joint-stock companies, &c. are also conducted in leading Indian and colonial cities.

At the time when the London Stock-exchange was opened in 1802 there were 551 members and 99 clerks, and in March 1891 the roll of members included upwards of 3000 names, besides an army of clerks having admission. In 1821 each member was required to provide two sureties for the sum of £250 each, who also had to be members, and were held liable in their suretyship for two years. Various alterations have since been made, and the suretyship for new members is now three members responsible for the sum of £500 each for four years. Those persons who have served as clerks for a period of four years are, however, only called upon to provide two sureties of £300 each for four years. Members have to pay an entrance-fee of 500 guineas and an annual subscription of 30 guineas. The entrance-fee for members who have acted as clerks is 150 guineas.

Although the London Stock-exchange is not, as generally is the case on the Continent, in any way

controlled by the government, and has not a monopoly, it practically secures the whole of the *bona-fide* business of buying or selling British government securities. Its members voluntarily place themselves under most stringent rules and regulations, and the slightest irregularity is visited with prompt pains and penalties. The committee is entrusted with the power of investigating complaints between members, or between the public and members, and any departure from orthodox procedure can be visited with penalty of suspension or expulsion. One of the regulations is that no member is allowed to advertise for business. Thirty members are annually balloted for to serve as a committee, and there is no appeal from judicial decisions that may be made by that body.

Members act as brokers and jobbers. The *broker* transacts business as between members of the Stock-exchange and the public, obtaining his commission from the clients who employ him. He deals in all securities. The *jobber* or dealer confines his attention to some special group of securities, and generally offers to buy at one price or sell at a higher any of the group stocks or shares he specially may interest himself in. The margin between the buying and selling price he may quote to any broker varies according to the nature of the security, the extent of competition, the state of the market, &c. In some active stocks the margin may be as little as $\frac{1}{2}$ of 1 per cent.; or if the stock is one that is rarely dealt in the jobber may quote a difference of 5 or even 10, and also say he is a buyer or seller only at a price, and refuse to deal unless what he is prepared to offer is acceptable to the broker.

On some of the continental bourses the conditions of membership are much more stringent than in England. On the Paris Bourse, for instance, there are sixty-five officially recognised *agents de change*, whose appointment rests with the government. As a body these sixty-five are termed the *Parquet*. Each member of the Parquet has to deposit on appointment cash or securities to the value of £10,000, and the Parquet as a body guarantees transactions from the fund, to which is added accumulating interest and a payment to the fund by each member of 15 centimes on each bargain. Intermediaries between the Parquet and the public are numerous. Reputable firms also have a guarantee fund of their own. These brokers, as they would be termed in England, are known as the *Coulisse*.

An enormous amount of business is transacted between international exchanges by means of telegraphic communication. If, for instance, an event occurs that causes sharp changes in prices, it may happen that the price of some special security of an international character is appreciably different on one exchange from what it is on another. Italian government funds may be quoted in Paris at a much higher price than in London, after making allowance for exchange rate, &c. Certain dealers who closely watch the margins in price between markets instantly send telegrams from different markets in which Italian *rente* is dealt in, say from Paris to buy in London, or from London to sell in Paris. This *arbitrage* business is conducted between the exchanges of all the world. There is much intricacy in calculations as to what is parity, as, for instance, in London or in Paris the quotation of a security includes the interest or dividend accrued since the last payment, while on the German bourses securities are bought at a price for the principal, and the amount of accrued interest or dividend has to be paid beyond the principal sum. There is only one notable exception on the London Stock-exchange to the price being inclusive of principal and accrued interest. This

exception is India rupee paper, where the purchaser buys at the quotation for the principal and pays the vendor of the security the amount of accrued interest.

Stock-exchange securities are of two characters, inscribed or registered, and to bearer. In home government funds and several colonial and municipal 'inscribed' issues the names of stockholders are registered (*inscribed*) in books kept at the Bank of England, or other banking agents of the government or corporation. When such stock is sold the vendor or his attorney must attend the bank and sign the transfer in the books. Where stock in a railroad or other company that registers the name of the stockholder is sold by the *registered* proprietor a deed of transfer, subject to stamp-duty, has to be executed, and this deed, with the stock or share certificate, is passed to the purchaser, who directly or through his agent lodges them with the company for registration into his own name. Securities to bearer are those the title to which passes by mere delivery, and the interest or dividends are paid periodically by means of coupons.

Almost all stock-exchange transactions in Great Britain are purchases or sales for what is termed the *settlement*. There are cash transactions for immediate payment or delivery, but except for consols bargains for cash are exceptional. The settlements are periodical—monthly in the case of home government funds and bi-monthly in other securities. The *Consols settlements* fall due about the first or second day of the month, sometimes a day or two later. *Settlements* in foreign and colonial government bonds, railway, and other industrial and miscellaneous securities are fixed to fall in the middle and at the end of each month. In dealing in registered securities it is necessary for the purchaser or seller to furnish the broker entrusted with the business with full particulars. A purchaser should give his full name, address, and occupation. A seller is required to forward to the broker the certificate of title. Where the transaction is in securities to bearer the vendor simply has to hand the securities to his broker, and the transaction is in all respects similar to the exchange of a bank-note for cash.

On the Paris Bourse settlements are arranged each fortnight in foreign government and miscellaneous securities, and monthly in French rentes, City of Paris bonds, Bank of France shares, Credit Foncier securities, and French railway stocks. The 'settlement' (*liquidation*) occupies five or six days, and except for intervening holidays or Sundays the procedure is as below :

Monthly Liquidation : options declared last day of month.	Fortnightly Liquidation : 15th of month, also carrying over.
Rente continued	1st next month
Other securities continued	2d " 16th of month.
Accounts made up	3d " 17th "
Clients pay brokers and deliver securities	4th " 18th "
Brokers pay clients	5th " 19th "
Brokers deliver securities	6th " 20th "

In Berlin the last day of the month is 'pay' day, and five days before is option day. In New York transactions are for cash, with daily settlements.

A very large proportion of the business done in the stock-markets is speculation done in *time bargains*. A purchaser who imagines that some special security is likely to rise in price buys for the settlement, in the hope of being able to sell at a profit before the date for payment falls due. If a change in price the way he expects is delayed, he renews the transaction from settlement to settlement. It may be the case that a fall in price is expected, and an operator sells in the hope of being able to buy back at a lower price. The purchaser for a higher quotation is in stock-exchange parlance called a *bull*. The seller who anticipates a fall in

prices is termed a *bear*. If there is a preponderance of bull speculation high terms are asked for the loan of money on the security of stock, termed a rate of *contango*, which may be expressed as so much per share or per cent. on the nominal hundred pounds of capital, or it may be a rate per cent. upon the actual amount of money to be borrowed. If many persons have formed an adverse opinion as to the course of the market, and there is what is termed an oversold state of the account, it frequently happens that those *bears* who have sold what they do not possess are called upon by real owners of stock, shares, or bonds to provide a bonus, termed *backwardation*, to pay the holder of the security for the trouble and risk attendant on lending it to the seller. Sometimes a long-continued speculation for the fall is attended with very high backwardation charges, and not infrequently violent fluctuations in the price of the security. Combinations to resist the adverse effect of sales by speculators for the fall are sometimes entered into in face of really adverse circumstances. A powerful group with command of money finding that 'bear' operations in a security of which the amount is small have been entered into to an excessively imprudent extent, buy all the stock that is offered, and call upon those who have sold what they do not possess to deliver it. This results in what is called a *corner*, and the operators who have sold have to pay whatever price the operators who have bought like to ask. An instance in point may be quoted. A South American government some years ago came upon the market as a borrower of a million pounds. The government was not one in good credit, and heavy speculative sales of the bonds were made on the expectation that there would be a fall in price of the bonds; but parties interested in bringing out the loan bought more of it than there was in existence, being enabled to do so through the sales of persons who sold what they did not own, and called upon those who had sold bonds to deliver them. For some months they continued raising the price against those who had sold, and at each fortnightly settlement exacted rates of backwardation sometimes as high as the equivalent of about 100 per cent. per annum. The loan was issued to the public at the price of 80 per cent., and was raised to very near £100 in cash for the £100 bond. The purchasers forced those who had sold to buy back, and after the successful coup the views taken by the adverse party were found to be perfectly correct, for eventually the price receded to about £4 for the £100 bond. *Corners* have been very frequent on the New York and Chicago Stock-exchanges.

A large amount of speculation in stock-exchange securities is conducted on what is known as *option* business. Options can be of threefold character—the payment of a sum for the right to purchase or to sell at a future date at an agreed price, or the right to sell only, or again the right to buy only. These options are termed respectively (1) the *put and call*, (2) the *put*, (3) the *call*. In America the double option of *put and call* is termed a *straddle*. This option business enables any operator to enter into speculative engagements with a known maximum of loss.

See Francis, *Chronicles of the Stock Exchange* (1849); G. R. Gibson, *The Stock Exchanges of London and New York* (1889); Burdett's *Official Intelligence*, issued under the sanction of the London Stock-exchange Committee; the *Stock Exchange Year-book*, by T. Skinner; besides works on the fluctuations of stocks by Crump (1875), Giffen (1879), Ellis (1879); on the law and usages of the Stock-exchange, works by Paterson, Royle, Melsheimer, Lawrence, Stutfield (1891); Bagehot's *Lombard Street* (10th ed. 1892); and American works by Lewis, Biddle, Dos Passos, and Cook; also the article *BROKER*.

Stock-fish, a commercial name of salted and dried cod and other fish of the same family, particularly the Ling, Hake, and Torsk.

Stockholm, the capital of the kingdom of Sweden, stands on several islands and the adjacent mainland, between a bay of the Baltic and Lake Mälär, in a situation that is accounted one of the most picturesque in Europe. The nucleus of Stockholm is an island in mid-channel called 'the Town'; on it stand the imposing royal palace (1697-1754); the principal church (St Nicholas), in which the kings are crowned; the House of the Nobles (1648-70), in which that class hold their periodical meetings; the town-house; the ministries of the kingdom; and the principal wharf, a magnificent granite quay, fronting east. Immediately west of the central island lies the Knights' Island (*Riddarholm*); it is almost entirely occupied with public buildings, as the Houses of Parliament; the old Franciscan church, in which all the later sovereigns of Sweden have been buried; the royal archives; and the chief law-courts of the kingdom. To the north of these two islands lie the handsomely built districts of Norrmalm, separated from them by a narrow channel, in which is an islet covered with the royal stables. The principal buildings and institutions in Norrmalm are the National Museum (1850-65), with extremely valuable collections of prehistoric antiquities, coins, paintings, sculptures; the principal theatres; the Academy of the Fine Arts (1735); the barracks; the Hop Garden, with the Royal Library (1870-76), 250,000 vols. and 8000 MS., and with the statue (1885) of Linnæus; the Academy of Sciences (1739), with natural history collections; the Museum of Northern Antiquities (1873); the Observatory; and technological, medical, *slöjd*, and other schools. Ship Island (*Skeppsholm*), immediately east of 'the Town' island, is the headquarters of the Swedish navy, and is built over with marine workshops, shipbuilding-yards, &c., and is connected with a smaller island on the south-east, that is crowned with a citadel. Beyond these again, and farther to the east, lies the beautiful island of the Zoological Gardens (*Djurgård*). Immediately south of 'the Town' island is the extensive district of Södermalm, the houses of which climb up the steep slopes that rise from the water's edge. Handsome bridges connect the central islands with the northern and southern districts; besides busses and tramways, the principal means of communication are quick little steamboats, some of which extend their journeys to the beautiful islands in Lake Mälär on the west, and eastward towards the Baltic Sea (40 miles distant). Besides the institutions already mentioned Stockholm is the home of the Swedish Academy (1786), Academies of Agriculture (1811), Music (1771), and the Military Sciences (1771), a naval school, a school of navigation, of pharmacy, &c. There is considerable industry in the making of sugar, tobacco, silks and ribbons, candles, linen, cotton, and leather, and there are large iron-foundries and machine-shops. The water approaches to the city are in general rendered inaccessible by ice during three or four months every winter; but to remedy this defect it is proposed to build a new harbour at Nynäs on the Baltic shore, 30 miles to the south. In spite of the winter drawback Stockholm is the seat of a trade sufficient to bring an average of 1760 vessels of 635,000 tons into the port every year, carrying principally grain (wheat and rye), rice, flour, herrings, oils and oilcake, cork-wood, groceries, metals, and wine and spirits (imports). The commodities exported consist chiefly of iron and steel, oats, and tar. Although Stockholm was founded by Birger Jarl in 1255, it was not made the capital of Sweden until com-

paratively modern times. Since then, however, it has grown rapidly: pop. (1800) 75,500; (1850) 93,000; (1870) 136,000; (1890) 246,151. The principal events in the history of the city have been the sieges by Queen Margaret of Denmark (1389), the battles in the vicinity against the Danes towards the end of the 15th century, the capture of the place by Christian II. of Denmark in 1520, and the Blood Bath he executed amongst the principal men of the country in what was then the Great Market.

Stockings. See HOSIERY.

Stockmar, CHRISTIAN FRIEDRICH, BARON, diplomatist, was born of Swedish descent at Coburg, 22d August 1787, studied medicine, and after some service with the army was appointed physician to Prince Leopold of Coburg, ere long to become his secretary and most influential adviser on all questions personal and political. As such he came to England with Leopold when he became the husband of the Princess Charlotte; and he gave Leopold valuable support in the negotiations that issued in making him king of Belgium. He had been ennobled in 1821, and was made a baron in 1831. Leaving Leopold's service in 1834, he became the mentor of Prince Albert of Coburg, and was the trusted friend of the young queen of England and her husband, living sometimes in England and sometimes in Coburg. As representative of Coburg in 1848 at the Diet, he supported Prussia's claim to the headship of the German nation. He died at Coburg, 9th July 1863.

See his *Denkwürdigkeiten*, edited by his son (Eng. trans. *Notabilia*, 2 vols. 1872); Juste, *Le Baron Stockmar* (Brussels, 1873); Sir Theodore Martin's *Life of the Prince Consort*; the *Greville Memoirs*; and for a less favourable view, the *Memoirs of King Leopold'smorganatic wife*, Caroline von Bauer (Eng. trans. 1884).

Stockport, a parliamentary, municipal, and county borough of East Cheshire, 6 miles SSE. of Manchester and 37 E. of Liverpool. It is built on the slopes of a narrow gorge, where the Tame and the Goyt unite to form the Mersey, which is spanned by the viaduct (1840) of the London and North-Western Railway, 111 feet high and 625 yards long, as well as by several bridges. St Mary's Church was rebuilt in 1817, with the exception of its 14th-century chancel; and Stockport has also a market-hall (1851-61), mechanics' institute (1862), free library (1875), fine technical school (1890), huge Union Sunday school (1806), grammar-school (1487; rebuilt 1832), infirmary (1832), the Vernon Park (1858), containing a museum, and, in St Peter's Square, a statue (1886) of Richard Cobden, who represented the borough from 1841 to 1847. Stockport was the site of a Roman station, and afterwards of a Norman castle, held till 1327 by the Earls of Chester, and taken by Prince Rupert in 1644, soon after which it was demolished by the parliament. In 1745 Prince Charles Edward passed through Stockport, which Bishop Pococke six years later describes as having 'a little manufacture of the Manchester linen, some woollen and ribands, and two silk-mills like those of Derby.' Since then it has grown to be a most important seat of the cotton industry, in spite of the machinery disturbances (1810-20), the strike of 1828-29, when the military were called out, and many persons wounded, the 'Plug Riots' (1840), and the cotton-famine (1861-64). Felt hats are also manufactured, and there are iron and brass foundries, engine and machine shops, breweries, &c. Stockport was constituted a parliamentary borough (returning two members) in 1832, a municipal borough in 1835, and a county borough in 1888. Pop. (1851) 53,835; (1881) 59,553; (1891) 70,263.

See works by Butterworth (1827-28), Earwaker (*East Cheshire*, 1877), and Heginbotham (1877-78).

Stocks, an apparatus of wood much used in former times in England for the punishment of petty offenders. The culprit was placed on a bench, with his ankles fastened in holes under a movable board, and allowed to remain there for an hour or two. The period of their first introduction is uncertain, but in the second Statute of Labourers, 25 Edw. III., 1350, provision is made for applying the stocks to unruly artificers; and in 1376 the Commons prayed Edward III. that stocks should be established in every village. Each parish had in later times its stocks, often close to the churchyard; and, though the last in London (St Clement Danes, Strand) were removed in 1826, many may still be seen in the country. Indeed the punishment was used so late as 1858 at Colchester, 1863 at Tavistock, and 1865 at Rugby. Combined with the stocks was often a whipping-post for the flagellation of vagrants.

Stocks. See NATIONAL DEBT, and STOCK-EXCHANGE.

Stockton, capital of San Joaquin county, California, on a navigable creek connected with the San Joaquin River, 103 miles by railway E. by N. of San Francisco. It contains a convent and the state lunatic asylum, and manufactures ironware, paper, woolsens, flour, soap, carriages, farm implements, &c. Pop. (1860) 3679; (1890) 14,424.

Stockton, FRANCIS RICHARD, an American author, was born at Philadelphia, 5th April 1834, was engraver and journalist, and became assistant-editor of *St Nicholas*. He first attracted notice by his fantastic stories for children, which fill several volumes; but he is best known as author of *Rudder Grange* (1879). Later works are *The Late Mrs Null*, *The Casting Away of Mrs Lecks and Mrs Aleshine*, and *The Dusantes, The Hundredth Man, The Schooner Merry Chanter* (1890), *The Squirrel Inn* (1891), *Pomona's Travels* (1894), *A Story-Teller's Pack* (1897), *The Buccaneers and Pirates of Our Coasts* (1898), *The Associate Hermits* (1898).

Stockton-on-Tees, a borough and seaport of Durham, on the north side of the Tees, 4 miles from its mouth and 11 ENE. of Darlington, 4 WSW. of Middlesborough, and 236 NNW. of London. A new town, South Stockton, incorporated in 1892 as Thornaby-on-Tees (pop. in 1891 15,637), has sprung up in Yorkshire south of the river, the two being connected by an iron bridge of three arches (1887), which superseded a five-arch stone bridge of 1771, and cost over £80,000. The town has six churches, a Roman Catholic chapel (1842-70) by the elder Pugin, a town-hall, borough-hall (1852), an exchange, a theatre, large recreation grounds, and an extensive park presented by Major Ropner. The Stockton Races, of some mark in the sporting world, are held here annually in August. Shipbuilding, chiefly in iron and steel, is carried on to a great extent; and blast-furnaces, foundries, engine-works, and extensive potteries and ironworks are in operation. Sailcloth, ropes, linen, and diapers were at one time the staple industry of the town; but their manufacture has been discontinued; and there are breweries, corn-mills, and spinning-mills. The exports are chiefly iron and earthenware; the imports corn, timber in deals, spars, &c., and bark. The Stockton and Darlington Railway, the first to commence passenger traffic, was opened for the double purpose of the conveyance of passengers and goods, September 27, 1825. At Stockton the Tees is navigable for vessels of large tonnage; the navigation of the river has been much improved, and great facilities for an extensive trade provided. Pop. (1831) 7763; (1861) 16,483; (1881), 55,457; (1891) 68,895, of whom 49,731 were within the municipal boundary. Stockton suffered severely from the incursions of

the Scots in the early part of the 14th century, but even at that time it enjoyed considerable trade. Its moated castle was taken for the Parliament in 1644, and 'sighted and dismantled' in 1652, almost the last vestige being removed in 1865. At the Restoration it had only 120 houses, mostly built of clay. Since 1867 it sends one member to parliament. Ritson was a native.

See works by J. Brewster (1829), H. Heavisides (1865), and T. Richmond (1868).

Stoddard, RICHARD HENRY, American poet, was born at Hingham, Massachusetts, in July 1825, attended schools in New York, and then worked in an iron-foundry for some years, meanwhile reading widely, especially in poetry. In 1849 he produced a small volume of poems, only to suppress it afterwards; but 1852 saw the birth of a sturdier collection. From 1853 to 1870 he served in the New York custom-house, in 1870-73 was clerk to General McClellan, and for a year city librarian. His poems include *Songs in Summer* (1857), *The King's Bell* (1862), *The Book of the East* (1867), and *Lion's Cub* (1891); his essays, *Under the Evening Lamp* (1892).

Stoicism, a school of ancient philosophy, strongly opposed to Epicureanism in its views of human life and duty. The Stoical system dates from the end of the 4th century B.C.; though commonly said to have been derived from the system of the Cynics, it is noteworthy that few of its founders or early apostles were born in Greece; it is the joint produce of Hellas and the Orient, and it was in Rome rather than in Greece that it most profoundly influenced civilisation.

The founder of the system was Zeno, from Citium in Cyprus (340-260 B.C.), who derived his first impulse from Crates the Cynic. He opened his school in a colonnade called the *Stoa Poikilē* ('Painted Porch') at Athens, which was adorned with pictures of the Trojan war, Marathon, and the Amazons by Polygnotus; hence the name of the sect. Zeno had for his disciple Cleanthes, from Assos in the Troad (300-220), whose *Hymn to Jupiter* is the only fragment of any length that has come down to us from the early Stoics—a poem setting forth the unity of God, his omnipotence, and his moral government. Chrysippus, from Soli in Cilicia (280-207), followed Cleanthes, and in his voluminous writings both defended and modified the Stoical creed. Antiquity gave by far the most important position to Chrysippus: 'Without Chrysippus there had been no Porch'; recent German criticism has done much to discover how much of the system is due to each. And Pearson sums up his elaborate investigation as follows: 'The result of our investigation has been to show conclusively that all those doctrines which are most characteristic of the true essence of Stoicism were contributed by Zeno and Cleanthes. To Zeno belong the establishment of the logical criterion, the adaptation of Heraclitean physics, and the introduction of all the leading ethical tenets. Cleanthes revolutionised the study of physics by the theory of tension and the development of pantheism, and by applying his materialistic views to logic and ethics brought into strong light the mutual interdependence of the three branches. The task of Chrysippus was to preserve rather than to originate, to reconcile inconsistencies, to remove superfluous outgrowths, and to maintain an unbroken line of defence against his adversaries.' These three represent the first period of the system. The second period (200-50) embraces its general promulgation, and its introduction to the Romans. Chrysippus was succeeded by Zeno of Sidon, and Diogenes of Babylon; then followed Antipater of Tarsus, who taught Panætius

of Rhodes, who, again, taught Posidonius of Apamea, in Syria. Posidonius was acquainted with Marius and Pompey, and taught Cicero; but the moral treatise of Cicero, *De Officiis*, is derived from a work of Panætius. The third period of Stoicism is Roman. In this period we have Cato the Younger, who invited to his house the philosopher Athenodorus; and, under the Empire, the three Stoic philosophers whose writings have come down to us—Seneca, Epictetus, and the Emperor Marcus Aurelius. Stoicism prevailed widely in the Roman world, although not to the exclusion of Epicurean views.

The leading Stoical doctrines are given in certain phrases or expressions, as 'life according to nature,' the ideal 'wise man,' 'apathy,' or equanimity of mind, the power of the 'will,' the worship of 'duty,' the constant 'advance' in virtue, &c. But the system will be best considered under four heads—the Theology; the Psychology; the theory of the Good; and the scheme of Virtue.

(1) The Stoics held that the universe is governed by one good and wise God. According to Epictetus, God is the father of men; Marcus Aurelius exults in the beautiful arrangement of all things. They did not admit that the Deity intermeddled in the smaller details of life; they allowed that omens and oracles might be accepted as signs of the foreordained arrangement of God. They held this foreordination even to the length of fatalism, and made the same replies as have been given in modern times to the difficulty of reconciling it with Free-will. God is the author of all things except wickedness; the very nature of good supposes its contrast evil, and the two are inseparable, like light and dark; in the enormous extent of the universe some things must be neglected; when evil happens to the good, it is not as a punishment, but as connected with a different dispensation; parts of the world may be presided over by evil demons; what we call evil may not be evil. Like most other ancient schools, the Stoics held God to be corporeal like man; body is the only substance; nothing incorporeal could act on what is corporeal; the first cause of all, God or Zeus, is the primeval fire, emanating from which is the soul of man in the form of a warm ether. Their theory of the universe may in fact be described as a materialistic pantheism. It is for human beings to recognise the universe as governed by universal law, and not only to raise their minds to the comprehension of it, but to enter into the views of the Creator, who must regard all interests equally; man should be, as it were, in league with Him, merge self in the universal order, think only of that and its welfare. By this elevation of view we are necessarily raised far above the consideration of the petty events befalling ourselves. The grand effort of human reason is thus to rise to the abstraction or totality of entire nature. The Stoics held the theory of the *absorption* of the individual soul at death into the divine essence; but, on the other hand, their doctrine of advance and aspiration is what has in all times been the main natural argument for the immortality of the soul. For the most part they kept themselves undecided as to immortality, giving it as an alternative, but reasoning as to our conduct on either supposition, and submitting to the pleasure of God in this as in all other things. In arguing for the existence of divine power and government they employed what has been called the argument from design.

(2) As to the constitution of the mind, they held that men have bodies like animals, but reason or intelligence like the gods. Animals have instinctive principles of action; man alone has a rational, intelligent soul. According to Marcus Aurelius, we come into contact with Deity by our intellectual part, and our highest life is thus the divine life.

But the most important Stoical doctrine respecting the nature of man is the recognition of reason as a superior power or faculty that subordinates all the rest—the governing intelligence. This, however, is not a mere intellectual principle, but an active force, uniting intellect and will. The bodily sensibilities are opposed to this higher reason and will, which, however, is strong enough to control them. Another way of expressing the same view was the power of the mind over the body, which was dwelt upon by Epictetus in the most exaggerated form. (The assertion of a doctrine so obviously contrary to the fact as that sickness may affect the body without enfeebling the mind could only end in practical failure, or else in contradiction.) In Seneca we find something very closely approaching to the Christian doctrine of the corruption of human nature. The littleness of humanity was a favourite theme of Marcus Aurelius, and naturally followed from the Stoical mode of contemplating the universe at large. The doctrine called the freedom of will may be said to have originated with the Stoics, although with them it was chiefly a rhetorical mode of expressing the dignity of the wise man, and his power of rising superior to circumstances. To prepare the way for the Stoical precepts Epictetus distinguished between things in our power and things not in our power. The things in our power are our opinions and notions about objects, and all our affections, desires, and aversions; the things not in our power are our bodies, wealth, honour, rank, authority, &c. Wealth and high rank may not be in our power, but we have the power to form an *idea* of these—viz. that they are unimportant, whence the want of them will not grieve us. A still more pointed application is to death, whose force is entirely in the idea.

(3) The Good was not by the Stoics identified with happiness. Happiness is not necessary, and may be dispensed with, and pain is no evil. Pains are in a sense an evil, but, by a proper discipline, may be triumphed over. They disallowed the direct and ostensible pursuit of pleasure as an end (the point of view of Epicurus), but allured their followers partly by promising them the victory over pain, and partly by the lofty enjoyments that grew out of their plan of life. Pain of every kind, whether from the casualties of existence or from the severity of the Stoical virtues, was to be met by a discipline of endurance. Great stress was laid on the instability of pleasure, and the constant liability to accidents; whence we should always be anticipating and adapting ourselves to the worst that could happen, so as never to be in a state where anything could ruffle the mind. Much might still be made of the worst circumstances—poverty, banishment, public odium, sickness, old age. Such a discipline was peculiarly suited to the unsettled condition of the world at the time, when any man, besides the ordinary evils of life, might in a moment be sent into exile, or sold into slavery. Moreover, it is a discipline adapted to a certain class of dispositions existing in all ages—men who prefer above all things 'equanimity' of mind, and would rather dispense with great occasional pleasures than risk their state of habitual composure. Next to the discipline of endurance we must rank the complacent sentiment of pride, which the Stoic might justly feel in his conquest of himself. It was usual to bestow the most extravagant laudation on the 'wise man,' and every Stoic could take this home to the extent that he considered himself as approaching that great ideal. The last and most elevated form of Stoical happiness was the satisfaction of contemplating the universe and God. The work of Marcus Aurelius is full of studies of

nature in the devout spirit of 'passing from nature to nature's God;' he is never weary of expressing his thorough contentment with the course of natural events, and his sense of the beauties and fitness of everything. Old age has its grace, and death is the becoming termination. This high strain of exulting contemplation reconciled him to that complete submission to whatever might befall which was the essential feature of the 'life according to nature.'

(4) The Stoical theory of virtue is implicated in their ideas of the good. The fountain of all virtue is manifestly the life according to nature, as being the life of subordination of self to more general interests—to family, country, mankind, the whole universe. The Stoics were the first to preach what is called 'Cosmopolitanism;' for although, in their reference to the good of the whole, they confounded together sentient life and inanimate objects—rocks, plants, &c., solicitude for which was misspent labour—yet they were thus enabled to reach the conception of the universal brotherhood of mankind, and could not but include in their regards the brute creation. They said, 'There is no difference between Greeks and Barbarians; the world is our city.' Seneca urges kindness to slaves, for 'are they not men like ourselves, breathing the same air, living and dying like ourselves?' The Epicureans declined, as much as possible, interference in public affairs, but the Stoical philosophers all urged men to the duties of active citizenship. Although there had been many good and noble men among the pagans, yet positive beneficence had not been preached as a virtue before the Stoics. They adopted the four cardinal virtues (wisdom, or the knowledge of good and evil; justice; fortitude; temperance) as part of their plan of the virtuous life. Justice, as the social virtue, was placed above all the rest; but most interesting to us are the indications of the idea of beneficence. Epictetus is earnest in his exhortations to forgiveness of injuries. Marcus Aurelius often enforces the same virtue; he contends as strongly as Butler and Hume for the existence of a principle of pure—that is, unselfish—benevolence in the mind. There is also in the Stoical system a recognition of duties to God, and of morality as based on piety. Not only are we all brethren, but also the 'children of one Father.'

The extraordinary stress put upon human nature by the full Stoic ideal of submerging self in the larger interests of being led to various compromises. The rigid following out of the ideal issued in a series of the Paradoxes—viz. that all the actions of the wise man are equally perfect, and that, short of the standard of perfection, all faults and vices are equal; that, for example, the man that killed a cock without good reason was as guilty as he that killed his father. The idea of duty was of Stoical origin, fostered and developed by the Roman spirit and legislation. The early Stoic had two different words for the 'suitable' (*kathêkon*) and the 'right' (*katorthôma*). It was a great point with the Stoic to be conscious of 'advance,' or improvement. By self-examination he kept himself constantly acquainted with his moral state, and it was both his duty and his satisfaction to be approaching to the ideal of the perfect man. The Stoical system has largely tinctured modern ages, in spite of its severity. It has always had a charm as an ideal, even when men were conscious of not realising it. The limitation of wants, the practice of contentment, the striving after equanimity, the hardening of one's self against the blows of fortune are all fundamental maxims with the moralists of later ages; and a qualified form of the subordination of self to the

general welfare is an essential part of most modern theories of virtue.

The chief ancient authorities on the Stoics are the writings of Epictetus, Marcus Aurelius, and Seneca, themselves Stoic philosophers, together with notices occurring in Cicero, Plutarch, Sextus Empiricus, Diogenes Laertius, and Stobæus. The completest modern account of the system occurs in Zeller's *Stoics, Epicureans, and Sceptics* (Eng. trans. 1870). See also Sir Alexander Grant in the *Oxford Essays* for 1858; Farrar's *Seekers after God* (1868; 3d ed. 1891); Rev. W. W. Capes, *Stoicism* (1880); J. Jordan, *Stoic Moralists* (1880); Ogereau, *Le Système des Stoiciens* (1885); A. C. Pearson, *The Fragments of Zeno and Cleanthes* (1891); and work cited at AURELIUS, EPICTETUS, SENECA.

Stoke-Poges, a village of Buckinghamshire, 9 miles N. of Slough station. Gray's mother settled here in 1742; and the beautiful churchyard is the scene of his *Elegy*, and in that churchyard he is buried. Pop. of parish, 2150.

Stokes, SIR GEORGE GABRIEL, mathematician and natural philosopher, was born August 13, 1819, in Skreen, County Sligo. He entered Pembroke College, Cambridge, in 1837, graduated in 1841 as senior wrangler and first Smith's prizeman, and in 1849 was appointed Lucasian professor of Mathematics. In 1852, the year after his election as a Fellow of the Royal Society, he was awarded the Rumford medal; in 1854 he became secretary, a position which he held till 1885, when he was made president for the succeeding quinquennial period. From 1886 he represented Cambridge in parliament, and in 1889 was created a baronet. His papers deal with some of the most abstruse problems of mathematical physics, and are characterised by a remarkable lucidity of treatment and an unerring sagacity of attack. In several of these he has, by opening new ground, given direction to later investigations by others. Two subjects have mainly engaged his attention. The one is Hydrodynamics, of which he wrote a valuable Report for the British Association in 1846, and in which his own contributions rank amongst the most important of the day. Specially may be noted his investigations on waves and on the effect of fluid friction on solids moving through fluids. Then to the theory of light he has made contributions of great value, his profound paper on the dynamical theory of diffraction (1849) being amongst the most important. He first gave a satisfactory theory of fluorescence and phosphorescence, and as early as 1852 he pointed out clearly the physical basis of Spectrum-analysis (q.v.). In 1884-86 he delivered in Aberdeen the Burnett Lectures on 'Light' (3 vols. 1887), an admirable elementary treatise for non-mathematical readers. His influence in the development of the Cambridge school of mathematical physics can hardly be overestimated. The leaders of the British school of natural philosophy all look to Stokes as their master and model.

See his reprint of *Mathematical and Physical Papers* (vol. i. 1880; vol. ii. 1883). He was Gifford Lecturer on Natural Theology at Edinburgh in 1891-92.

Stokes, WILLIAM (1804-77), physician, studied at Edinburgh, and in 1845 became regius professor of Medicine in Dublin University. He wrote lectures on the *Theory and Practice of Medicine* (1837), and works on the diseases of the chest and of the heart and on continued fevers.—His eldest son, WHITLEY STOKES, born at Dublin in 1830, studied law at Trinity College, went to India in 1863, and after holding a series of important legal appointments was in 1877-82 president of the Indian law-commission and draughtsman of the present civil and criminal codes. He has written many legal works, including *The Anglo-Indian Codes* (1887-91), and edited a large number of Irish and other Celtic texts. He is LL.D., D.C.L., C.S.I., C.I.E.

Stoke-upon-Trent, a manufacturing town of Staffordshire, the capital of the 'Potteries,' on the Trent and the Trent and Mersey Canal, 15 miles SE. of Crewe, 2 E. of Newcastle-under-Lyme, and 16 N. of Stafford. It is a modern place, dating only from the last quarter of the 18th century, and has a parish church with Wedgwood's grave, a town-hall (1835), a market-hall (1883), a free library (1878), the Minton memorial building (1858), the Hartshill Infirmary (1868), public baths, and statues of Wedgwood, Minton, and Colin Minton Campbell. Its factories of porcelain, earthenware, encaustic tiles, and tessellated pavements are among the largest in the world; and the industries also include coal-mining, brickmaking, and the manufacture of iron, engines, machinery, &c. Mrs Craik was a native. The parliamentary borough, constituted in 1832, was much curtailed in 1885 and lost one of its two members; the municipal borough was incorporated in 1874. Pop. (1871) 15,144; (1881) 19,261; (1891) 24,027; of parliamentary borough (1891) 75,352. See John Ward's *Borough of Stoke-upon-Trent* (1843).

Stolberg, CHRISTIAN, COUNT OF, a poetic writer, was born at Hamburg, October 15, 1748. Whilst a student at Göttingen he identified himself with the Göttingen poetic school (*Dichterbund*), a literary circle embracing also Bürger and Voss. After twenty three years' public service in the duchy of Holstein he retired, and died at his seat of Windebye, near Eckernförde in Sleswick, on January 18, 1821. As a poet he was inferior in genius to his brother Friedrich Leopold, in whose books his own work was generally included. His principal productions are *Gedichte* (1779), *Gedichte aus dem Griechischen* (1782), *Schauspiele mit Chören* (1787), *Vaterländische Gedichte* (1810), and a metrical translation of Sophocles (1787).

Stolberg, FRIEDRICH LEOPOLD, COUNT OF, younger brother of the preceding, was born at Bramstedt in Holstein on November 7, 1750. Like his brother he was one of the *Dichterbund* fraternity at Göttingen. Most of his active life was spent in the public service of Denmark. Although possessed of some degree of poetic fancy, he was on the whole a somewhat colourless writer in the style of Klopstock. Shortly after the outbreak of the French Revolution he went over to the Roman Catholic Church, and from that time a very pronounced religious and ascetic temper made itself prominent in his writings, of which the principal was *Geschichte der Religion Jesu Christi* (15 vols. 1807-18). He died on his estate of Sondermühlen, near Osnabrück, 5th December 1819. Besides the volumes of *Gedichte*, *Schauspiele*, *Vaterländische Gedichte*, issued along with his brother's works, F. L. Stolberg published translations from Æschylus, Plato, and the *Iliad*, an idyllic romance *Die Insel* (1788), and other books. See works by Menge (1863), Hennes (1876), and Janssen (3d ed. 1882).

Stole (Gr. *stolē*, Lat. *stola*, 'a robe'), a narrow vestment, of the same stuff as the chasuble, worn by bishops and priests in the Latin Church during mass, in the administration of sacraments, and in certain blessings, and by deacons when they have to move the blessed sacrament. In some places it is worn while preaching. Bishops wear it over both shoulders: so also do priests, but crossed over the breast; deacons wear it over the left shoulder. It is also used in some cases as a symbol of jurisdiction, in which sense it is constantly worn by the pope, even when not officiating. In the Anglican Church the stole is worn with the same difference by priests (but not crossed) and deacons. It is usually of black silk, fringed at the ends, with sometimes crosses embroidered; but coloured stoles, according to the season, are also worn in some

churches. In the Greek Church the stole proper is peculiar to deacons; among Syrian Christians it is worn by clerics of all (even minor) orders. The stole originated in the *orarium* or handkerchief, which was sometimes worn as a scarf, and which in the 6th and 7th centuries came to be recognised as a sacred vestment in the Western Church. The name stole began to be substituted by the 9th, and was the common word before the 12th century. See illustrations at CHASUBLE and COPE. *Stole-fees* are the same as surplice-fees (see SURPLICE). The broad scarf is worn by chaplains to any member of the royal family, or to any peer or peeress, doctors in divinity, and capitular members of a collegiate church.

Stolen Goods are thus treated by English law: a *bonâ-fide* purchaser of such goods, who has not bought them in market overt, is bound to restore them to the true owner; but if the goods are sold in market overt, the purchaser is entitled to keep them unless the owner has duly prosecuted and convicted the thief. Market overt means the open market in towns and places where a legal market is held. In the City of London every shop is held to be a market overt, but this only applies to the City proper (see SALE). The above rule as to stolen goods does not apply to valuable securities which are stolen, if the security has been paid or discharged *bonâ fide* by the person liable, or if the security is a negotiable instrument, and it has passed to a 'holder in due course' (Bills of Exchange Act, 1882, sect. 29). It is a punishable offence to offer or take rewards for the recovery of stolen property. See also THEFT. The Scots law does not recognise the doctrine of market overt.

Stolp, a town in the Prussian province of Pomerania, stands on the river Stolp, 85 miles W. by N. of Danzig, and has a castle, some old churches (the castle chapel dating from the 13th century), iron-foundries, machinery, and amber manufactures, and an active trade in agricultural products, timber, fish, &c. Pop. 23,837.

Stomach. The Anatomy and Physiology of this organ are treated of in the article DIGESTION (q.v.). See also ABDOMEN, ARTIODACTYLA, BIRD, FISHES, &c.; and INDIGESTION, VOMITING.

DISEASES OF THE STOMACH.—Acute *gastritis*, or inflammation of the mucous membrane of the stomach, is a very rare disease, except as a result of the administration of an irritant poison; during six years' experience at La Charité (one of the leading Parisian hospitals) Dr Louis made notes of 6000 cases of disease, but did not meet with a single case of fatal idiopathic or spontaneous gastritis. The symptoms which indicate that an irritant poison has been received into the stomach are a gradually increasing sensation of uneasiness or heat, which shortly assumes an acute burning character in the epigastric region. This pain is accompanied with vomiting, which becomes increasingly frequent as the pain augments, and often with hiccup. There is usually extreme tenderness on pressure, and the patient bends his body forward to relax the muscular tension. During the accession of these symptoms there is a marked degree of excitement, as indicated by the acceleration of the pulse and breathing and the heat of the skin. This condition is, however, soon exchanged for one of prostration. The skin becomes cold and clammy, the pulse thready and feeble, and the breathing catching and intermittent; until finally, after a variable period of exhaustion, the patient sinks, usually retaining his mental faculties to the last. Although the above-described symptoms are always more or less present, each irritant poison occasions some special symptom and some characteristic lesion; and the

period at which death ensues varies for different poisons.

Sub-acute gastritis, or *gastric catarrh*, is by no means a rare affection, and it occurs in two distinct forms—'one in which the malady is caused by a constitutional state, the effects of which are shown in a variety of other organs as well as in the stomach; another in which it is due to causes connected chiefly or exclusively with this organ, which is submitted to an irritative process somewhat analogous to that typified by the gastritis of irritant poisoning' (Brinton, *On Diseases of the Stomach*). The first of these forms is well illustrated in such diseases as smallpox, scarlatina, pneumonia, &c., in which the digestive process is much interfered with, and after death distinct marks of inflammation are seen in the stomach. The other variety, which is often of a chronic form, is well seen in cases of delirium tremens, the affection being sub-acute or chronic, according as it has been produced by a single prolonged debauch, or by a protracted habit of drinking spirits, and the patient's final malady being induced by a deficiency of food or some injury or acute disease. Purely chronic inflammation may be induced by various causes, of which the most common are the abuse of alcoholic drinks, habitual excess in eating, the eating of indigestible food, and the excessive use of irritating medicines. The symptoms are like those of indigestion in a severer form; in fact it is impossible to draw a sharp line of distinction between the two affections.

The treatment of gastritis varies much with each individual case, but the first point is the removal of the cause—to be attempted in cases of irritant poisoning either by the removal of the poison (by the stomach-pump or emetics, as, for example, sulphate of zinc) or by its neutralisation by means of an antidote. In very severe cases leeches may be applied to the epigastrium; but counter-irritants, such as turpentine on a hot moist flannel, or mustard-poultices, are generally of more service. Continuous fomentation with water, as hot as can be borne, often gives great relief, while at the same time iced water, or small lumps of ice swallowed whole, usually relieve the thirst and mitigate the pain. Enemata of purgative materials, if the bowels are constipated, or of a soothing character (as thirty drops of laudanum in a little starch or gruel), if the bowels are irritable, may be prescribed with advantage. When the stomach begins to be able to retain food, it must be given in the form of a bland liquid, in small doses, at distant intervals. Chronic gastritis must be treated in much the same manner as Indigestion (q.v.). The most essential point of treatment is the due regulation of the diet.

Ulcer of the stomach is the most important of the idiopathic diseases of that organ, both from its frequency, from the facility with which it may in some cases be detected during life, from the fact that at any period of its protracted course it may prove suddenly fatal, and from its being usually curable. The first and most characteristic symptom of this disease is pain, which comes on very soon after the ingestion of food, and lasts for an hour or two; vomiting often ensues, with such relief that the sufferer sometimes gets into the habit of inducing it himself. The place of most common appearance and greatest intensity of the pain is the centre of the epigastric region, but it is sometimes higher, lower, or to one side, and occasionally in the back. The pain in both the epigastric and the dorsal region is almost always much increased by pressure; also by food and drink, especially by the ingestion of hard and indigestible substances. The pain, vomiting, and want of nourishment lead of course to much

enfeeblement. The disease is sometimes terminated by the occurrence of perforation, ending in rapidly fatal peritonitis; and if this accident does not occur, the dyspeptic symptoms may become complicated by hæmorrhage from the stomach, sometimes so rapid that it distends the stomach and adjacent small intestine with a single gush, and causes fainting and almost immediate death, but more commonly occurring as a slow and intermittent drain of blood, giving rise to anæmia. In some cases, however, symptoms are either absent altogether or so slight that no attention is paid to them, till the presence of the ulcer is revealed by one of these accidents. If death from the above causes (inanition, perforation, or hæmorrhage) does not terminate the disease, the symptoms frequently subside in something like the inverse order in which they occurred, and recovery, often after many years' suffering, ensues. Brinton states that this lesion may be detected in (on an average) 5 per cent. of persons dying from all causes; that it occurs twice as frequently in females as in males, and that it is specially a disease of middle and advancing life—twenty-seven being the average age in females and forty-two in males. Nothing is known with certainty regarding the causes of this disease, except that advancing age, privation, mental anxiety, and intemperance so frequently coincide with it that they may be regarded in some degree as producing it. But it is particularly frequent as a complication of Chlorosis (q.v.). In relation to treatment strict attention to diet is of the first importance. When the symptoms are urgent the patient should maintain the recumbent position, and should be fed on cold or lukewarm milk thickened with biscuit-powder, given in doses of one or at most two tablespoonfuls at regular intervals of from ten minutes to an hour. The pain is often relieved by the application of a mustard-poultice or blister to the painful spot; and benefit is frequently derived from the internal administration of bismuth (in doses of ten grains), either given alone or combined with the compound kino powder (in five-grain doses). When there is hæmorrhage small lumps of ice may be swallowed; and if all food is rejected by vomiting, nutrient injections must be thrown into the lower bowel. Aperients are sometimes required, but they must be given with caution; and if castor-oil can be taken without increasing the pain or vomiting, it is the most harmless remedy of its class.

Cancer of the stomach is obscure in its symptoms, frequent in its occurrence, and always fatal in its termination. The typical course of this disease is thus sketched by Brinton: 'An elderly person perhaps hitherto free from dyspepsia begins to suffer from a capricious, and soon a diminished appetite, which is by-and-by associated with occasional nausea, or even vomiting, and with a sense of uneasiness or distention of the stomach. His complexion, already pale and unwholesome, next acquires a muddy, yellowish, or faint greenish hue. His gastric symptoms now increase; often by a sudden and marked augmentation, which corresponds to what is in other cases their first appearance. Vomiting, if already present, becomes more frequent and urgent; local uneasiness deepens into pain; and both these symptoms are excited or increased by taking food. At a somewhat later period hæmorrhage generally occurs, usually but scanty in amount, and therefore depending to a great extent on casual circumstances for its detection. About this time a tumour often becomes perceptible near the middle of the epigastric region of the belly. As the local symptoms increase the cachexia of the patient also augments, and is evidenced not only by the colour already mentioned,

but also by debility and emaciation, and at last by prostration, which ends in anasarca, delirium, and death.' But any or all the distinctive symptoms may be absent. 'There are indeed some cases in which the most acute observer cannot do more than suspect the presence of the disease.' In the treatment of this formidable disease more good is done by careful attention to the diet than by any medicine. Good milk or strong beef-tea thickened with biscuit-powder may be given in the same manner as recommended in ulcer; and milk mixed with a little old Jamaica rum will sometimes stay on the stomach when everything else is vomited. If there be pain, opiates must be administered, either in the ordinary way, as enemata, or hypodermically, the latter having the advantage of having less tendency to induce constipation.

Hæmatemesis, or Vomiting of Blood, is a serious and important symptom of disease affecting the stomach. It may occur by the ulcerative destruction of the walls of a comparatively large blood-vessel in gastric ulcer and in cancer; but it generally is of the kind termed capillary, and happens under various circumstances, of which the following are the principal. It may take the place of some habitual hæmorrhage, or, in other words, be vicarious. Thus, it may possibly take the place of the menstrual discharge. It is often caused by disease or injury of the stomach; for example, it frequently occurs after the ingestion of strongly irritant poisons, or even an immoderate dose of alcohol into the stomach. It may be a consequence of disease in adjacent viscera, occasioning an overloading of the veins of the stomach—e.g. enlargement of the spleen, obstruction of the portal circulation depending on disease of the liver, enlargement of the uterus in the advanced periods of pregnancy. It may result from changes in the composition of the blood, such as occur in scurvy, purpura, and yellow fever. The treatment must be directed against the disease on which the hæmorrhage depends rather than against the mere symptom; but from whatever cause it arises, if it is proceeding to a dangerous extent the patient should be kept perfectly quiet in bed, and should swallow small pieces of ice. Hot applications may also be applied to the extremities with the view of directing the blood to those parts. The medicines most likely to be of service are acetate of lead, gallic acid, dilute sulphuric acid, and oil of turpentine; but they should only be given on medical authority.

Stomata, minute openings in the epidermis of leaves and tender green stems of plants, and subserve the purpose of respiration (see VEGETABLE PHYSIOLOGY). They are found in parts exposed to sun and light, and hence are most numerous on the upper surface in most leaves, on the under side of floating leaves, but in some monocotyledons equally distributed. See illustration at LEAF; and for the complex stomata of *Marchantia*, see LIVERWORTS.

Stone, a market-town of Staffordshire, on the left bank of the Trent, 7 miles NNW. of Stafford and 7 S. of Stoke-upon-Trent. It has a town-hall (1869), a market-hall (1868), Alleyne's grammar-school (1558), remains of an Augustinian monastery, two modern convents, and manufactures of earthenware, boots and shoes, beer, leather, &c. Pop. (1851) 3443; (1891) 5754.

Stone, a weight formerly in use throughout the northern countries of Europe, but varying in different countries, and now mostly obsolete. The British imperial stone, the only legal one, is 14 lb.; but in various parts of the country stones of other values are or have been in use, as a stone of 24 lb. for wool, 8 lb. for butcher-meat, 22 lb. for hay, 7 lb. for oatmeal in Scotland, 16 lb. for cheese, 32 lb. for hemp, and 5 lb. for glass.

Stone. See CALCULUS, and LITHOTOMY.

Stone. Under the head BUILDING STONE (see also ROADS) the more important kinds of stone used for architectural purposes are noticed, and some of these, such as limestone, marble, sandstone, flagstone, flint, slate, granite, basalt (greenstone), serpentine, and porphyry, are again referred to under their respective names. See under MILL, OVEN, and WHETSTONES for millstones, firestone (leckstone), and hones. Purely ornamental stones other than gems are noticed under ALABASTER, FLUOR SPAR, JADE, JASPER, LABRADORITE, LAPIS LAZULI, MALACHITE, and other heads. The beautiful material called Mexican onyx marble (stalagmitic aragonite) has only been known for a few years. Algerian onyx marble, also a handsome stone, wants the bright-coloured veins of the Mexican. The most recent addition to these ornamental stones is the jasperised wood of Arizona, many pieces of which are of striking beauty. In recent years some beautiful porphyries and granites from Norway and other countries have been cut and polished for decorative purposes at some of the Aberdeen granite-works. Besides its well-known granites Scotland possesses quite a number of handsome siliceous stones suitable for architectural decoration, hitherto not utilised.

Stone-dressing.—Ashlar stones (see MASONRY), whether of limestone or sandstone, after being chiselled on the face, generally get the tool-marks removed by smoothing them with a bit of soft sandstone and water. In England a stone so finished is technically said to be *rubbed*; in Scotland, *polished*. It has recently become the custom in Scotland, where sandstone is the only freestone, to dispense with the 'polishing' and leave irregular chisel-marks visible. In former years there were in use various effective ways of dressing stones for the fronts of buildings. One of these was *tooling* or *drawing*—i.e. covering the face with small flutings by means of a broad chisel; another was *broaching* or incising the face with narrow parallel grooves by the use of a pointed tool. Many buildings of a by no means unpretentious kind recently erected in Scotland and elsewhere have their ashlar stones dressed only on their beds and joints, their faces being merely 'pinched' from the edges, leaving the exposed part of the stones rough and hackly. When the face of granite is not polished it is generally dressed with a nidging hammer, which gives it a chiselled appearance.

Preservation of Stone.—The preservation of stone can be effected to a great extent by coating the surface with boiled linseed-oil, or with oil-paint; but these methods are not much in favour, as they destroy the crystalline appearance which constitutes the beauty of most natural stones. There is, however, no other efficient way known of preserving a sandstone with a tendency to decay. More hope may be entertained that certain chemical solutions will prevent the wasting of oolitic and magnesian limestones so much used as building stones in London and southern England generally. The coating of these with an alkaline silicate and the subsequent application of calcium chloride, as proposed by Ransome, has not had the beneficial result which was expected from this treatment. Quite recently the owners of the Bath stone (oolitic) quarries have recommended a preserving solution under the name of 'Fluate.' The exact nature of this material does not appear to have been disclosed, but in October 1890 *The Builder* published analyses of the stone before and after being fluated. It may be inferred from these analyses that its durability is increased by the application of this fluid to its surface, but there can be no certainty till the treatment is tested by

time. The preservation from decay of a porous substance like freestone (whether sandstone or limestone) in a climate like that of northern Europe is a problem of the greatest difficulty. One precaution ought never to be neglected, and that is to see that a 'damp-proof course' is put through the walls of a building just above the ground, to prevent the ascent of moisture from the soil. See BUILDING.

Artificial Stone.—Burnt clay in the form of bricks or terra-cotta blocks of larger size, though not usually classed as artificial stone, is by far the best substitute for real stone. Portland Cement, (q.v.) mixed either with sand alone or with sand and broken stones, forms one kind of artificial stone (see CONCRETE). In the north of Italy paving tiles with beautiful patterns are made by inlaying Portland cement with small pieces of marble, serpentine, and other ornamental stones. This kind of work is obviously suited for external wall decoration of a very effective kind, provided that even the best Portland cement has the durability which some of its advocates claim for it. Scagliola (q.v.) is a polished plaster for internal decoration, somewhat similarly ornamented. Von Fuchs of Munich, Kuhlmann of Lille, and Ransome of Ipswich have successively done material service in enabling an artificial stone to be made of the silicate of soda or potash (soluble glass) and sand (see GLASS, Vol. V. p. 245). Ransome's artificial stone is a hard substance formed by mixing sand with a solution of this alkaline silicate, then pressing it into moulds, and when partially dry soaking it in a bath of chloride of calcium, which to some extent penetrates the 'stone,' forming the insoluble silicate of lime (calcium silicate). Chimney-pieces, vases, and architectural ornaments of various kinds have been made of this material. Ransome's 'patent concrete stone' is made in the same way, with broken pieces of stone added.

Stone Age, or AGE OF STONE, is a term used in archaeology to denote the condition of a people using stone as the material for the cutting tools and weapons which, in a higher condition of culture, were made of metals. The expression 'age,' when used in this connection, is not therefore significant of a fixed period in chronology, but implies merely the time, longer or shorter, earlier or later, during which the condition subsisted. The duration of such a condition must necessarily have varied from various causes in different areas, and chiefly in consequence of contact with higher degrees of culture. Populations placed in remote situations, and on that account remaining uninfluenced by such contact—like the islanders of the South Pacific and the Eskimos of the extreme north for instance—have remained in their stone age to the 19th century. On the other hand, the populations of the European area, in portions of which there were successive centres of high culture and civilisation from a very early period, had all emerged from their stone age, through the use of bronze, many centuries before the Christian era. The progress of early culture in Europe seems to have been from the south and east, northward and westward, so that the emergence of the different populations from their age of stone was accomplished much earlier in southern and eastern Europe than in its northern and western parts. But while the stone age of different areas is thus not necessarily synchronous, it seems to be true of all European areas that this is the earliest condition in which man has appeared upon them. Our knowledge of the details of the archaeology of Asia, Africa, and America is still too limited for general conclusions to be drawn with certainty, but the existence of similar prehistoric conditions, as re-

gards the use of stone prior to the introduction of metals in Asia Minor, India, China, Japan, the northern parts of Africa, and many parts of North and South America, has been fully established. There are no data by which the period of the early stone-using populations of Europe can be defined, even approximately. But in England, Belgium, and France, and across the Continent to the shores of the Mediterranean, they were contemporary with animals which are now either wholly or locally extinct, such as the mammoth, woolly rhinoceros, cave-lion, cave-bear, and hyæna, the reindeer, musk-ox, and urus. It is an open question to what extent this change of fauna implies a change of climate, but from the geological conditions in which the flint implements of the earliest types are found it is evident that, though extensive changes must have taken place since they were deposited in the river-basins, they belong exclusively to the later deposits of the Quaternary period.

The stone-age implements of Europe have been divided into two classes—the *palæolithic* or older stone implements and the *neolithic* or newer stone implements. This is equivalent to dividing the stone age of Europe into two periods, earlier and later, as the palæolithic implements are found associated with the extinct and locally extinct fauna, while the neolithic implements are found associated with the existing fauna. The palæolithic stone implements are distinguished as a class from the neolithic by their greater rudeness of form, and by the facts that they are exclusively of flint and have been manufactured by chipping only. The neolithic stone implements on the other hand are of finer forms, often highly polished, and made of many varieties of stone besides flint (see fig. 4). But the mere fact of an implement having been fashioned by chipping alone is not decisive of its palæolithic character, because certain varieties of implements of neolithic time still continued to be made by chipping only. The distinguishing differences are the typical forms and the circumstances of association in which the implements are found.

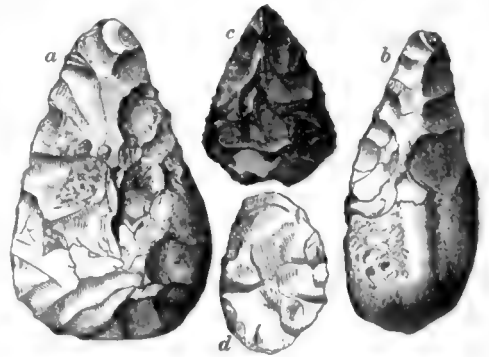

Fig. 1.

a, round-pointed, tongue-shaped implement, Bliddenham, near Bedford; b, acutely-pointed implement made from rounded nodule of flint, St Acheul, near Amiens; c, from Bemerton, Wilts; d, irregularly-ovate, sharp-rimmed instrument, Moulou Quignon, Abbeville. (From Evans's *Ancient Stone Implements of Great Britain*.)

Palæolithic stone implements are found *in situ* in river-gravels, in caves, and in association with bones of the extinct animals before mentioned. Neolithic stone implements are found in the surface-soil, in refuse-heaps of ancient habitations, and in chambered tombs. Implements of bone or deer-horn of both periods are similarly distinguished by their typical forms and their circumstances of association. The palæolithic implements of flint

are mostly so rude in form and finish that it is impossible to apply to them names indicative of specific use (see fig. 1). They are roughly chipped and destitute of that secondary working of finer character along the sides and edges which gives finish to the forms of the neolithic types. They present, however, a considerable number of well-marked typical forms. Those from the river-gravels are chiefly flakes, trimmed and untrimmed, for cutting and scraping; pointed implements, some almond-shaped or tongue-shaped; and more obtusely pointed implements, with rounded and often undressed butts. There is also a series of scraper-like implements, and another of oval sharp-rimmed implements, which are more carefully finished than most of the other varieties. The flint implements from the caves present a greater variety of form. They are generally characterised by secondary



Fig. 2.—Carved Reindeer-horn, Laugeriebasse, Dordogne. (From Cartailhac's *La France Préhistorique*)

working, and are therefore much more carefully finished, often in many respects approaching closely to neolithic types. From the caves also come a series of implements of bone and of carvings on bone which have excited much astonishment on account of the extraordinary contrast between their artistic character and the extreme rudeness of many of the implements of stone with which they are associated (see fig. 2). These bone implements consist of well-made needles, borers, javelin or harpoon points barbed on one or both sides, and implements of reindeer-horn of unknown use (called by the French archaeologists *batons de commandement*), which are usually carved in relief or ornamented with incised representations of animals, and occasionally of human figures. The animals, as for instance a group of reindeer from the cave of La Madelaine, Dordogne, are drawn with wonderful faithfulness, freedom, and spirit. In another instance, engraved on a flat piece of mammoth-tusk is an outline representation of that animal showing its characteristic elephantine form and the covering of hair peculiar to the species. The neolithic stone implements consist of axes and axe-hammers,



Fig. 3.—Lozenge-shaped (a), leaf-shaped (b), and barbed (c) arrow-heads of Flint.

knives, daggers, spear and arrow heads (fig. 3), saws, chisels, borers, and scrapers. The axes and axe-hammers are made of many varieties of stone besides flint. Some of the finer polished axes are of jade and fibrolite. The jade axes were once thought to have been importations from eastern Asia (see JADE), but the chippings of their manufac-

ture have been found in the lake-dwelling sites of the Lake of Constance, and jade itself was discovered about 1887 *in situ* at Jordansmuhl near Breslau in Silesia. The axes are mostly imperforate. They are simple wedges, the butt end of which was inserted in the shaft, or in a socket of stag's-horn with a tenon on the upper end mortised into the shaft,

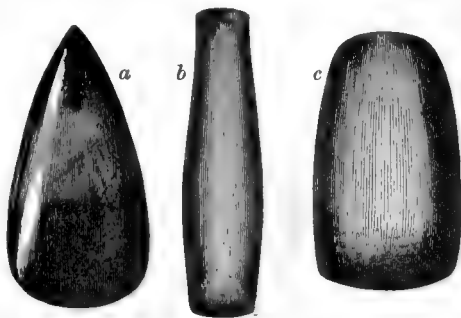

Fig. 4.—Polished Stone Axes or Celts: a, 6½ inches; b, 13 inches; c, 5 inches long.

though the shaft was sometimes put through a hole in the stag's-horn socket. The perforate stone axes, or axe-hammers, which belong to the close of the stone age, had the hole for the shaft bored through them by a cylinder of wood or bone, working with sharp sand and water. Most of the other implements were made only of flint, and generally finished by chipping, without being ground or polished. Some of the long Danish knives and daggers (fig. 5) are marvels of dexterous workmanship, on account of the thinness of the blade, and the straightness and keenness of the edge, produced by the mere process of chipping or removing successive flakes from the surface.

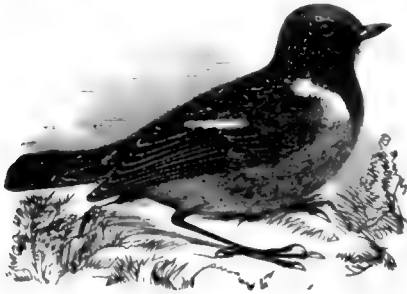

Fig. 5. Danish accompanied by sepulchral pottery. Flint-dagger.

The burial customs of the stone age included both inhumation and cremation, the former being, however, the earlier method. No burials of the river-drift period have yet been discovered. The cave-dwellers of the stone age buried their dead in cavities of the rocks like that of Cro-Magnon in Dordogne, in which four or five skeletons were found huddled together, without being enclosed in cists or accompanied by sepulchral pottery. From a comparison of the remains from such cave-cemeteries in different localities it has been concluded that even at this early period Europe was already occupied by more than one race of men. The populations of the neolithic time deposited their dead, with or without previous cremation, in or on the floors of the chambers of dolmens, or great chambered cairns. The sepulchral pottery accompanying these burials, in Britain at least, is generally of a hard-baked dark-coloured paste, the form of the vessels mostly basin-shaped and round-bottomed, and the ornamentation entirely composed of straight lines placed at various angles to each other. The implements found with these internments are mostly of the commoner kind, such as flint knives, scrapers, or strike-lights (used with a nodule of pyrites of iron), arrow-heads, and more rarely axes and axe-hammers of flint or polished stone. The neolithic inhabitants of northern and central Europe were not merely nomadic tribes subsisting on the products of the chase; they practised agriculture, and possessed the common

domestic animals we now possess. The presence in the refuse-heaps of their seacoast settlements of the remains of deep-sea fishes shows that they must have possessed boats and fishing-lines, as was also the case with the stone-age inhabitants of the Lake-dwellings (q.v.). The estimates that have been made of the antiquity of the stone age in Europe are necessarily very various and all equally conjectural, but it has been considered that the close of the neolithic period or the time when the use of stone began to be superseded by that of bronze in northern Europe cannot have been much later than from 1000 to 1500 B.C. See works cited at ARCHÆOLOGY.

Stone-chat (*Pratincola rubicola*; see CHAT), one of the most common of the British Turdidæ, a pretty little bird, rather smaller than the red-



Stone-chat (*Pratincola rubicola*).

breast, black on the upper parts and throat in summer; the breast of a dark reddish colour; some white on the sides of the neck, the wings, and the tail. It makes its nest of dry grass and moss lined with bents, hair, and feathers on the ground or at the foot of a low bush. It is resident in the British Isles, but a few may migrate southwards in cold winters, when there is also an influx of others from the colder continental regions. It is somewhat local and erratic in its distribution, frequenting a place for a few seasons and then suddenly abandoning it. It feeds on insects, grubs, worms, beetles, and seeds. The Wheat-ear (q.v.) is, however, the true Stone-chat.

Stone Circles, or Circles of Standing Stones (q.v.), popularly, but erroneously, called Druidical Circles in Britain, Dom-rings or Thing-steads in Scandinavia, and known as Cromlechs in France, consist of unhewn stones set up at intervals round the circumference of a circular area usually of level ground, though they are sometimes found on the slightly sloping side of a hill. The area thus marked off from the surrounding ground varies in size from less than 20 to more than 100 feet in diameter. The number of stones composing the circle also varies greatly, but as most stone circles exist now in a condition of greater or less dilapidation it is often impossible to ascertain with certainty what the original number may have been. Sometimes they are mere boulders rolled into position, at other times they are pillar-stones, evidently chosen for their length, and wedged upright by smaller stones inserted round their bases in the cavity in the subsoil prepared for their reception. Sometimes there is a single circle only, at other times one or two smaller circles are contained con-

centrically within the interior circle. Occasionally the area on which the circle stands is further marked off from the surrounding ground by a trench, or by a trench and rampart of earth surrounding the whole, except where a narrow pathway gives access to the interior on the original level. In the district of Scotland between the Dee and the Spey there are numerous examples of a special variety of stone circle distinguished by the presence of a great flat block placed on edge so as to fill one of the intervals between two of the upright pillars, usually on the south-west side of the circle. Circles of small boulder stones placed close together and scarcely showing above the turf are also found in many parts of Europe, indicating that the space thus enclosed has been reserved for burial deposits in prehistoric times. But the circles composed of large stones set at considerable intervals apart are linked with the burial customs of the builders of the chambered cairns of the stone age. A great circle of standing stones encircled the gigantic chambered cairn of New Grange in Ireland, and the smaller cairns of Clava in Strathnairn near Inverness are similarly encircled by pillar-stones. As a rule the cairns which covered the cremation interments of the bronze age are smaller than those of the preceding period, and the custom of placing the burnt bones in a cavity in the soil, covered only by an inverted urn of clay, dispensed with the cairn altogether, while it retained the circle of standing stones as a visible mark or fence of the grave-ground. In about twenty instances in which there has been systematic excavation of stone circles in Scotland the examination of the interior space has disclosed burials of the bronze age, mostly after cremation, but occasionally unburnt. The cremated remains were deposited with cinerary urns placed either in an inverted position over the burnt bones or upright and containing the burnt bones, at the bottom of a shallow pit excavated in the subsoil. These cinerary urns exhibit the forms and ornamentation characteristic of the age of bronze. Sometimes the burials have been placed in cists of unhewn slabs of stone, covered by small cairns of loose stones, underneath the surface level; at other times the burnt bones of many burials have been found placed in shallow cavities excavated in the soil of the interior area of the circle, near the bases of the upright stones. From these circumstances



Stone Circle, Stennis, Orkney.

it is conclusively demonstrated that the common varieties of stone circles in Scotland are circular cemeteries of bronze-age burials. It may be that the greater circles, like those of Stennis, Avebury, and Stonehenge, may have had a different origin and purpose, but there is no evidence more conclu-

sive than mere conjecture for the assumption of a different purpose for the larger circles, and the great size of the circle surrounding the immense chambered cairn of New Grange shows that a great circle was associated with sepulture.

The largest of the Scottish stone circles is that of Stennis in Orkney, standing on the slope of the hill overlooking the loch of that name about 4 miles NE. of Stromness. It is surrounded by a trench 30 feet wide and about 6 feet in depth, enclosing a total area of about $2\frac{1}{2}$ acres. The trench is crossed by two accesses to the enclosed area on opposite sides of the circle, each 17 feet wide. The circle of pillar-stones stands 13 feet within the trench on a circumference of 340 feet in diameter. The original number of pillar-stones was probably sixty, of which only thirteen are now standing; ten are prostrate, and the stumps or fragments of thirteen more are still recognisable. The highest stone standing is 14 feet in height, and several of those now prostrate exceed 12 feet in length. The average distance between the stones is about 17 feet. A smaller circle, which seems, however, to have been composed of larger stones, stood about a mile to the south. Its whole interior area is raised about 3 feet above the surrounding level, and has had a circumscribing ditch, with a rampart on the inner side. Only two stones remain standing, and a somewhat larger one, now prostrate, is 19 feet long and 5 feet broad. It was near this circle that the perforated stone stood, through the aperture of which it was the custom in the 18th century for young men and women of the district to plight their troth by joining hands, a promise of marriage thus made being regarded with superstitious reverence as specially binding. The largest stone circle in England is that of Avebury (q.v.) in Wiltshire. This monument is apparently alluded to in a charter of King Athelstan, dated 939 A.D., where one of the boundaries is said to run 'from the road to Hackpen northward, up along the Stone Row, thence to the burying-places. Stonehenge (q.v.), the most famous of British stone circles, stands within a ditch and embankment enclosing an area of about 360 feet in diameter. It differs from other stone circles not only in its ground-plan, but in the pillar-stones of the exterior circle and the larger ellipse surmounted by imposts, mortised on tenons in the tops of the uprights, and also by the larger stones being thus at least partially tool-dressed. In Norway and Sweden the few stone circles systematically explored have been found to be burial-places of the iron age. They are usually simple circles composed of eight to thirteen stones; occasionally there are two concentric circles, one within the other, the inner circle being sometimes composed of small stones set close together in a ring. Sometimes there is a single pillar-stone in the centre of the circle. As a rule they are not remarkable either for the size of the circles themselves or for the massiveness of the stones of which they are composed. Circles of standing stones are rare to the south of the Baltic. In France they are comparatively few in number, and scarcely anything is yet known of their contents. In Algeria megalithic circular burial-places are not uncommon, but they do not correspond in general with those of northern Europe, being rarely composed of pillar-stones. Circles of pillar-stones, apparently of comparatively recent origin, have been found in northern India, and megalithic circles are stated to have been occasionally met with east of the Jordan, and in northern Arabia.

See Ferguson's *Rude Stone Monuments* (Lond. 1872); Anderson's *Scotland in Pagan Times* (Edin. 1886); *Plans and Photographs of Stonehenge*, by Sir Henry James (Southampton, 1867).

Stone-coal. See ANTHRACITE.

Stone-crop. See SEDUM.

Stonfield, an industrial town of Lanarkshire, $2\frac{1}{2}$ miles NW. of Hamilton and 8 SE. of Glasgow. It was the scene of riots in February 1887. Pop. (1871) 395; (1891) 5581.

Stone-fly (*Perla*), a genus of insects typical of the order Plecoptera. The hind-wings are broader than the fore-wings, and folded at the inner edge. The body is elongated, narrow, and flattened; the wings fold close to the body, which generally bears two terminal bristles. The larvæ are aquatic, and much resemble the perfect insect, except in the absence of wings. A number of species—e.g. *P. bicaudata*—are common in Britain, and are well known to anglers as an attractive lure for fishes.

Stone-fruit. See FRUIT, Vol. V. p. 20.

Stoneham, a town of Massachusetts, 9 miles N. of Boston, with which it is connected by rail and tram. It has large boot and shoe factories. Pop. (1890) 6140.

Stonehaven (locally *Stanehive*), a seaport and (since 1607) the county town of Kincardineshire, 16 miles SSW. of Aberdeen, is situated on a rocky bay at the mouth of Carron Water, which divides it into an Old and New Town. The harbour, formed since 1826, can admit only small vessels; but Stonehaven has very considerable herring and haddock fisheries. It was constituted a police-burgh in 1889. Pop. (1841) 3012; (1891) 4497. See DUNNOTAR CASTLE.

Stonehenge (Saxon *Stanhengist*, 'the hanging stones'), a circular group of gigantic standing stones on Salisbury Plain, about 2 miles from Amesbury in Wiltshire, situated in the midst of an extensive group of prehistoric barrows of the bronze age. The circle of stones, which is about 100 feet in diameter, occupies the central portion of an area of about 360 feet in diameter, enclosed within an earthen rampart and ditch. It consists of two concentric circles enclosing two ellipses, both open at the north-east end. The exterior circle, which is composed of pillar-stones of Tertiary sandstone, locally called 'sarsens,' set up at pretty regular intervals of about 4 feet apart, has been surmounted by a continuous line of imposts closely fitted to each other at the extremities, and having mortise-holes in their under sides, which receive tenons on the tops of the pillar-stones. The pillar-stones show generally about 13 feet of height above the ground, and the imposts are about 10 feet long, $3\frac{1}{2}$ feet wide, and 2 feet 8 inches deep. Of this circle seventeen pillar-stones and six imposts retain their original position. About 9 feet within the exterior circle are the remains of a second circle of smaller undressed blocks or boulders of primitive rock, locally known as 'blue stones.' They are irregular in shape and height, and do not seem to have supported imposts, but few now remain standing, and their number and respective positions cannot be accurately determined. Within this inner circle, and separated from it by about the same distance, is an incomplete ellipse, nearly of horse-shoe form, with the open end facing the north-east, formed of five trilithons or groups of two immense pillar-stones supporting an impost. The central trilithon facing the open end of the ellipse is the largest, the pillar-stones being about 23 feet in height above ground, and the added height of the impost making the whole height of the trilithon nearly 28 feet. The dimensions of this trilithon given by Sir Henry James are: height of uprights out of ground, 22 feet 5 inches; breadth, 7 feet 6 inches; thickness, 4 feet: length of impost, 15 feet; breadth, 4 feet 6 inches; thickness, 3 feet 6 inches. The other four, which stood facing each other, two

and two on opposite sides of the ellipse, are somewhat smaller. Only two are now perfect; the central one wants the impost, which fell in 1620, one of the pillars lies broken on the great stone, popularly called 'the altar stone,' and the other leans over, supported by one of the smaller stones in front of it. Of the two trilithons on the west side of the ellipse, the one next the open end has only one pillar-stone standing, the other has fallen inwards with the impost, and both are broken; the other trilithon fell outwards in 1797, but the three stones, though prostrate, are still entire.



Stonehenge.

The trilithons of the ellipse are of the same Tertiary sandstone as the pillar-stones and imposts of the exterior circle, and like them are partially tool-dressed. Within this ellipse is a smaller ellipse of the same form, but composed, like the second circle, of irregularly-shaped 'blue stones' without imposts, varying from 6 to 8 feet in height, and set at intervals of about 5 to 6 feet.

Though not mentioned by any Roman writer, or noticed by Gildas, Nennius, or Bede, Stonehenge comes into the cycle of British history in the 12th century, when it is chronicled by Henry of Huntingdon as one of the four wonders of England, the other three being merely natural phenomena. In the same century Geoffrey of Monmouth, in his *Historia Britonum*, attributes its erection to Aurelius Ambrosius, in commemoration of the British nobles treacherously slain by Hengist, and mentions that Aurelius himself was buried in it. Again, in recording the death of Constantine about the middle of the 6th century, he states that he was buried 'close by Uther Pendragon, within the structure of stones which was set up with wonderful art not far from Salisbury, and called in the English tongue Stonehenge.' Though Geoffrey's narrative is in the main mythical, it may be accepted as the earliest record of what was believed to be the purpose of Stonehenge. His story is repeated with little variation by all the medieval writers to the time of Camden. He copied a drawing of it, signed 'R F 1575,' which (making every allowance for bad drawing) shows its outer circle much more complete than at present. Inigo Jones, in 1620, laments the disappearance of stones that were standing when he measured it. Stukely deplors the loss of the fallen stones carried away to make bridges, mill-dams, and the like. Aubrey mentions a large stone carried away within his remembrance to make a bridge. Though the area within the circle has never been systematically explored, flint flakes, fragments of rude pottery similar to the urns found in the neighbouring barrows, bones of oxen, and portions of stags' horns, have been found

at various times in desultory excavations made in the hope of discovering some clue to the unknown purpose or uses of the structure. The theories propounded in modern times on these points have been many and various. It has been attributed to the Phœnicians, the Belgæ, the Druids, the Saxons, and the Danes. It has been called a temple of the sun, and of serpent-worship, a shrine of Buddha, a planetarium, a gigantic gallows on which defeated British leaders were solemnly hung in honour of Woden, a Gilgal where the national army met and leaders were buried, and a calendar in stone for measurement of the solar year.

The opinion of Sir John Lubbock, expressed in his *Prehistoric Times*, is that there are satisfactory reasons for assigning it to the bronze age, though apparently it was not all erected at one time, the inner circle of small unwrought 'blue stones' being probably older than the rest. By most archaeologists it seems to be accepted as an exceptional development from the ordinary type of Stone Circles (q. v.), used as burial-places by the bronze-age people of Britain, though some regard its exceptional development as due rather to a religious influence than to the mere idea of the common commemoration of simple burial. Whatever its origin, it is the grandest megalithic monument in Britain. See books by

Long (1876), Gidley (1877), and E. Barclay (1895).

Stonehenge, the pseudonym of JOHN HENRY WALSH (1810-88), a native of Hackney, a surgeon at Worcester, and from 1857 editor of *The Field*, author and editor of works on dogs and sport.

Stonehouse. See DEVONPORT.

Stone River. See MURFREESBOROUGH.

Stones, PRECIOUS. In this category are included numerous mineral substances, and one or two products of organic origin, used in jewellery and for other ornamental purposes on account of their rarity and beauty. The list of stones which may be regarded as precious cannot be definitely limited, as certain substances appear and disappear with the fluctuations of fashion. Some confusion also arises from the commercial application of the same name to several substances which may have a superficial similarity, although they really belong to distinct mineral species. Further, in point of beauty and rarity, the mineral substances used for ornament so merge into the common and abundant that there is no possible dividing line between precious and common stones. Among the substances used ornamentally, however, there are a few which from all times have occupied a foremost place and have been universally prized as precious stones. In such a rank and position may be placed the diamond, the ruby, the sapphire, the oriental amethyst, and the emerald. These, on account of their rare properties—their lustre, their play of light, their brilliance of colour, their great hardness and consequent durability, and especially because of their extreme rarity, have always been the most esteemed of jewel stones. In the second rank, as well-established precious stones of minor value, may be included the spinel or balas ruby, the Brazilian topaz (the oriental topaz is a yellow sapphire), the varieties of garnet, the turquoise, the tourmaline, the aquamarine or pale emerald, the chrysoberyl or cat's eye, the zircon or jargon, the opal, and the varieties of quartz, such as rock-crystal, agate, amethyst, cairngorm or Scotch

topaz, chalcedony, jasper, onyx, sardonyx, &c. Among other beautiful and valuable stones much appreciated for ornamental purposes, but scarcely to be classed as precious stones, there may be included lapis lazuli, crocidolite, labradorite, moonstone, aventurine, and malachite. To the list of precious stones there should be added two substances of animal origin—pearls and red coral—and perhaps also amber, a comparatively rare and valuable fossil resin. The various substances here enumerated are dealt with, for the most part, under their own proper names.

For the development of the sparkle, lustre, and glow of colour of most precious stones it is essential that they should undergo the process of cutting and polishing. When lustre and sparkle are the principal qualities to be revealed, as in the case of the diamond, the surface is most favourably cut into numerous plane facets as either brilliant or rose cut stones (see DIAMOND, figs. 1 and 3). When colour is the more important quality of the stone it may, if plane surfaces are wanted, be step or table cut (*a* in fig.). Such stones also, and translucent and opaque stones, may be cut *en cabochon*—i.e. with curved or rounded surfaces.

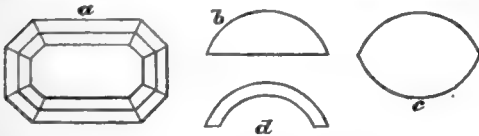

The varieties of cabochon cutting are single cabochon (*b*), or high plano-convex double cabochon (*c*), and double convex and hollow cabochon (*d*), the latter being much used for large garnets, which so cut are called carbuncles.

One of the most important qualities of a precious stone is its hardness, as upon that property depends its power of resisting wear and of keeping the brilliance of its polished surface. It is a property of great constancy, moreover, and in many cases affords a ready means of determining the nature of a stone under examination. Of all known substances diamond is the hardest, and representing it, according to Mohs's scale, by 10, the following is the relative hardness of several of the more important of the precious stones: Diamond, 10·0; sapphire, 9·0; ruby, 8·8; chrysoberyl, 8·5; spinel, 8·0; topaz, 8·0; aquamarine, 8·0; emerald, 7·8; zircon, 7·8; tourmaline, 7·5; amethyst, 7·0; moonstone, 6·3; turquoise, 6·0; opal, 6·0.

Artificial Precious Stones.—Numerous attempts have been made by eminent investigators to produce artificial precious stones by means of intense heat and pressure and by electrical action; but hitherto these efforts have failed of practical success. In an important memoir published by Sainte Claire Deville and Caron in 1858 (*Comptes Rendus*, vol. xvi.) they describe various processes by which they obtained small crystals of corundum, ruby, sapphire, &c. By the action of the vapours of fluoride of aluminium and boracic acid on one another, they obtained crystals which, in hardness and in optical properties, resembled natural corundum. When a little fluoride of chromium was added a similar process yielded violet-red rubies; with rather more fluoride of chromium blue sapphires were yielded; and with still more green corundum was obtained. A mixture of equal equivalents of the fluorides of aluminium and glucinum, when similarly acted on by boracic acid, yielded minute crystals of chrysoberyl. The action of fluoride of silicon on zirconia yields small crystals of zircon, and by the action of silica on a mixture of the fluorides of aluminium and glucinum hexagonal plates of

extreme hardness were obtained, which in some respects resembled emerald.

In subsequent researches Becquerel (*Comptes Rendus*, vol. lviii.), by the use of electric currents of high tension, succeeded in obtaining opals, &c. from solutions of silicates. Among the most successful of experimenters in this direction was the late Ch. Feil of Paris, who successfully crystallised alumina, and by the introduction of colouring matter produced sapphires and rubies identical in hardness and composition, but not in brilliance, with the natural stones. M. Feil also succeeded in preparing true crystals of spinel, and a blue lime spinel of great hardness, but which were glassy rather than crystalline in structure.

Imitations of precious stones consist of a soft, heavy flint-glass called Strass (q.v.) or paste, appropriately coloured, and they may readily be distinguished, among other peculiarities, by their great softness. Fraudulent combinations are made by cementing thin plates of precious materials over, and sometimes also under, a body of valueless glass, and thus the exposed surface or surfaces when tested are real stones, and the veneered mass passes as a genuine large and consequently valuable possession.

See works by H. Emanuel (1865), W. Jones (1879), A. Delmar (1880), Professor A. H. Church (1883), E. W. Streeter (5th ed. 1892), M. D. Rothschild (New York, 1889), and G. F. Kunz (New York, 1890).

Stone-worship. See FETICHISM, IDOLATRY.

Stonington, a town and port of Connecticut, on the Atlantic, 14 miles by rail E. of New London, and at the junction of one of the railway and steamer routes between New York and Boston. It has a capacious harbour, a foundry, and tin-factories. Pop. (1890) 7184.

Stonyhurst, a great Roman Catholic college in north-east Lancashire, 4 miles SW. of Clitheroe, traces its origin to the seminary at St Omer (q.v.) in France, which was founded in 1592 by Father Parsons (q.v.). The seminary ere long had 200 students, but after many vicissitudes was suppressed by the tyranny of the Bourbons in 1762. After a short sojourn at Bruges till 1772, and at Liège till 1794 (when the French revolutionary armies were closing round it), the eighteen Jesuit fathers were offered a resting-place at Stonyhurst by Mr Weld of Lulworth, an old alumnus, to whose family the old home of the Shireburnes had in 1754 passed by marriage. The fine house, begun about 1594, was beginning to fall into ruin, and even when restored provided but scant accommodation for the 200 students who soon flocked to it. Extensions were made in 1810-78, the chapel being built in 1835, and other additions have been lately completed. The numbers have gone on increasing with some fluctuations, and are now about 300. The teaching staff numbers over thirty masters; and there is a preparatory school at Hodder, a mile distant. The department for higher education prepares young men for the London University degree and competitive examinations, and puts them through a course of philosophy. In 1840 Stonyhurst was affiliated to the University of London, and it has a long list of successes in the various examinations, especially classics. Between 1840 and 1890 about 400 passed the matriculation examination, of whom ninety took honours. The B.A. degree was taken by 120, half of these securing places on the classical honours list, and ten took M.A. in classics and mathematics. The course is mainly classical, but mathematics receives a large share of attention; and French, science, and other branches are essential parts of the course. Games are much encouraged, and special forms of football and handball seem to have been brought from St Omer.

The college eleven is well known. There is a covered playground, swimming bath, gymnasium, and workshop; and the debating club and college magazine are prosperous institutions. The library of some 40,000 volumes has many valuable MSS. and early printed books; and the college possesses a collection of pictures, a museum of antiquities, scientific collections, and fine specimens of embroidery and church-plate in the sacristy (many of these treasures having been preserved from St Omer days). The college observatory rose into note under Father Perry, F.R.S. Many of the institutions—the names of classes, exercises, holidays—date from the residence abroad.

See Hewitson, *Stonyhurst College* (Preston, 1870; 2d ed. 1878); *Memorials of Stonyhurst College* (1881); Rimmer, *Stonyhurst Illustrated* (1884); J. B. Halt, *Stonyhurst Lists, 1794-1886* (1886); Shawcross, *Stonyhurst* (1894); Father Gerard, *Stonyhurst College* (4to, 1894); P. Fitzgerald, *Stonyhurst Memories* (1895).

Stony Stratford, a market-town of Bucks, on Watling Street and the Ouse, 8 miles N.E. of Buckingham. It had an Eleanor cross till 1646, and suffered from fire in 1742. Pop. 2019.

Stool of Repentance, one of several names for an engine of ecclesiastical discipline in Scotland, also known as the 'pillory' or 'pillar,' the 'high place,' the 'public spectacle,' and in familiar reference the 'cutty-stool'—a term ordinarily in use for a domestic wooden stool with short legs. The place of repentance was sometimes a stool or bench, sometimes a pew or part of the gallery, sometimes a special erection as high as the gallery, containing several seats or stances, and ascended by stairs. Whatever it was and whatever called, it was about the most conspicuous thing in the church; and here persons who had become subject to ecclesiastical discipline for immoral conduct were required by the kirk-session to stand during public worship in profession of their penitence. The penitent was usually bare-headed and bare-footed, clothed in sackcloth or a linen sheet (kept for the purpose by the kirk-session); the ceremony might or might not be concluded by a public rebuke from the minister. For minor offences one appearance in the place of penitence might suffice; for the sin of fornication three several Sundays' penitence were usually inflicted; a much larger number of days was not at all unusual; and some offences (such as incest) might imply fifty-two Sabbaths in the place of penance unless the culprit were condemned by the civil courts to capital punishment. The stool of repentance was steadily maintained during great part of the 18th century, but gradually fell into desuetude, its place being taken by public rebuke before the congregation (still enforced in some places to near the middle of the 19th century), and afterwards by rebuke administered in presence of the session only. See Dr Edgar on 'Discipline' in *The Church of Scotland*, vol. v. (1891).

Storax, a resin resembling benzoin, was in high esteem from the time of Pliny to the end of the 18th century. It was obtained from the stem of *Styrax officinalis*, a native of Greece and the Levant, but owing to the destruction of the trees it has now disappeared from commerce. It was used as a stimulating expectorant. LIQUID STORAX, a soft viscid resin, opaque and gray brown, heavier than water, is obtained from the *Liquidambar orientale*, a tree 40 feet high, forming forests in the south-west of Asia Minor. It has a balsamic odour and a pungent burning aromatic taste. It contains from 6 to 20 per cent. of cinnamic acid, besides a hydrocarbon, *Styrol*, a volatile oil, and various fragrant ethers. It is used but seldom in medicine, but has a reputation in chronic

bronchial affections. Externally it has been employed in scabies.

Stork, a group of birds characterised by having the bill larger than the head, very stout at base, not grooved, tapering to the straight recurved or decurved tip; nostrils pierced directly in the horny substance, without nasal scale or membrane, high up in the bill, close to its base; legs long, and with reticulate scaling; three toes, with sometimes a rudimentary fourth, the claws not acute. The storks are usually divided into the True Storks and the American 'Wood Ibises' (*Tantalus*). There are several genera of storks, including about a dozen species. They belong chiefly to the Old World. The most familiar representative of the family is the Common Stork or White Stork (*Ciconia alba*), a native of the greater part of the Old World, a migratory bird, its range extending even to the northern parts of Scandinavia. It is common in many parts of continental Europe (though not in France, Italy, or Russia), but is especially familiar in Holland and North Germany, the storks arriving annually in February and March, and in autumn returning to Africa in large flocks, flying mostly by night. It is about three feet and a half in length. The head, neck, and whole body are pure white; the wings partly black; the bill and legs red. The neck is long, and generally carried in an arched form; the feathers of the breast are long and pendulous, and the bird often has its bill half hidden among them. The flight is very powerful and high in the air; the gait slow and measured. In flight the head is thrown back and the legs extended. The stork sleeps standing on one leg, with the neck folded, and the head turned backward on the shoulder. It frequents marshy places, feeding on eels and other fishes, frogs, lizards, snakes, slugs, young birds, small mammals, and insects. It makes a rude nest of sticks, reeds, &c. on the tops of tall trees, or of ruins, spires, or houses. There are four or five eggs, white tinged with buff; and the old nest is re-occupied next



Common Stork (*Ciconia alba*).

year. In many parts of Europe, especially in Holland, it is a very common practice to place boxes for storks, and it is considered a fortunate thing for a household that the box on the roof is occupied: children are told it is the storks that bring the babies out of the well. Storks are protected by law in some countries, on account of their good services not only in destroying reptiles and other troublesome animals, but

in the removal of offal from the streets of towns, in which they stalk about with perfect confidence, even in the midst of throngs of people. They have been celebrated from ancient times for the affection which they display towards their young, and have also had the reputation—not so well founded—of showing great regard to their aged parents. Before they take their departure from their summer haunts they congregate in large flocks, which make a great noise by the clattering of their mandibles, and are popularly regarded as holding consultation. The stork has no voice. It is a very rare bird in Britain, and was so even when the fens of England were undrained. Bower says that in 1416 storks came and built their nests on the roof of St Giles' Church in Edinburgh; there they remained a year and departed to return no more; 'and whither they flew,' adds the chronicler, 'no man knoweth.' The flesh of the stork is rank and not fit for food. The Umbrette (*Scopus umbretta*), an African and Madagascar bird, remarkable for the enormous domed nest which it builds, is nearly allied to the storks and seems to be a link connecting them with the herons. The Balæniceps (q. v.) or Shoe-bill is also a stork.

Storm, THEODOR WOLDSSEN, German poet and writer of short stories; a native of Sleswick, he was born at Husum on 14th September 1817. He spent most of his life (1842-80) as magistrate and judge in the service of Sleswick-Holstein and Prussia, and died at Hademarschen in Holstein on 3d July 1888. His poetic reputation rests upon his *Gedichte* (1852; 8th ed. 1890). Of his stories, mostly short, the best are *Immensee* (1852; 33d ed. 1890), a poetic idyll in prose; *Zerstreute Kapitel* (1873); *Aquis Submersus* (1877); *Psyche* (1877); *Carsten Curator* (1878); *Hans und Heinz Kirsch* (1883); *John Riew* (1886); and *Der Schimmelreiter* (1888). The charm of these little tales lies in the poetic and idyllic atmosphere in which the action is placed, the unobtrusive skill with which they are told, and their deep feeling. See *Lives of Storm* by Schütze (1887) and Wehl (1888).

Stormontfield. See PISCICULTURE.

Storms are violent commotions of the atmosphere occurring in all climates, particularly in the tropics, and differing from other atmospheric disturbances in the extent over which they spread and the sudden changes which take place in the direction of the wind over wide areas. There is, perhaps, no question in science in which there was long so large an admixture of speculation with fact as in the attempts made to reduce the phenomena of storms under general laws; the reason being that meteorological observatories were too few in number and too wide apart to represent the barometer pressure, the general course of the winds, and the rainfall, without drawing largely on conjecture. Since about 1860, however, sufficient data have been available for a fuller and more satisfactory statement of the facts.

Form and Extent of Storm Areas.—The circular isobaric lines on the charts represent very fairly the form storms usually assume in Europe, where the area of almost every storm is either circular or elliptical, the major axis of the ellipse being generally less than twice the minor axis. Rarely in Europe, but in America less rarely, is the form of storms much more elongated. The outline is occasionally very irregular, but in such cases the storm will be found to have parted into two or more distinct storms, or it comprises within the low-pressure area several satellite storms. The approximate circular form of storms is their general characteristic. This is a most important feature, whether as determining the practical rules for the

guidance of sailors in storms, or for the forecasting of storms at particular seaports, in respect of the direction from which they may be expected to come, and the veerings of the winds during their continuance. The extent over which storms spread is very variable, being seldom less than 600 miles in diameter, but often two or three times greater, and more rarely even five times that amount. More than the whole of Europe is sometimes overspread by a single storm at one time. The prime difference between storms or *cyclones* and *tornados* is that the breadth of the space traversed by the latter is, as compared with that of storms, always quite insignificant. The area of storms is not constant from day to day, but varies in size, sometimes expanding and sometimes contracting; and it is worthy of remark that when a storm contracts in area the central depression gives signs of filling up, and the storm of dying out. On the other hand, when it increases in extent the central depression becomes deeper, the storm increases in violence, and occasionally is broken up into two or even more depressions, which become separate storms, with the wind circling round each. This occurs frequently with summer thunderstorms.

We subjoin two charts of Europe showing from observations made at upwards of 100 stations scattered over the continent the barometric pressure, and direction and force of the wind, at 8 A.M. of the 1st (A) and 2d (B) of November 1863, during part of the course of two storms which passed over Europe. The isobaric lines, or lines showing where, at the above hour, the barometer was the same, are given for every two-tenths of an inch in the difference of the pressure. Hence, where these lines crowd together, the difference of pressure, or the atmospheric disturbance, was the greatest, and the least where they are most apart—a distinction of the utmost importance in determining where the wind raged in greatest fury. The arrows show the direction of the wind, being represented flying with it. The force of the wind is shown (1) by plain arrows, \rightarrow , which represent light and moderate winds; (2) by arrows feathered on one side only, \rightsquigarrow , which represent high winds; (3) by arrows feathered on both sides, \rightsquigarrow , which represent strong gales, storms, or hurricanes.

Direction in which Storms advance.—The direction in which their progressive motion takes place differs in different parts of the world—being perhaps determined by the prevailing winds (see WIND). Thus, about half of the storms of middle and northern Europe travel from the south-west toward the north-east, and about nineteen out of every twenty travel toward some point in the quadrant lying between the north-east and the south-east. Storms rarely travel towards a westerly point; in some of the instances which have been noted the western course has been arrested at Norway, Denmark, the North Sea, or the British Islands, but such westerly course is temporary, the easterly course being afterwards resumed. Some of the most violent easterly storms fall under this head. Storms do not always proceed in the same uniform direction from day to day, and, though the change which occurs in the direction of their progressive motion is generally small, yet occasionally it is very great. Thus, of the many interesting features peculiar to the storm which passed over Europe in the beginning of December 1863 none were more remarkable than the sudden changes of its progressive motion. It was first observed on the west of Ireland, from which it advanced east to Liverpool, then turned south through Worcester and Oxford to Cherbourg in France; it thence retreated north through Oxford to Shields, from which it

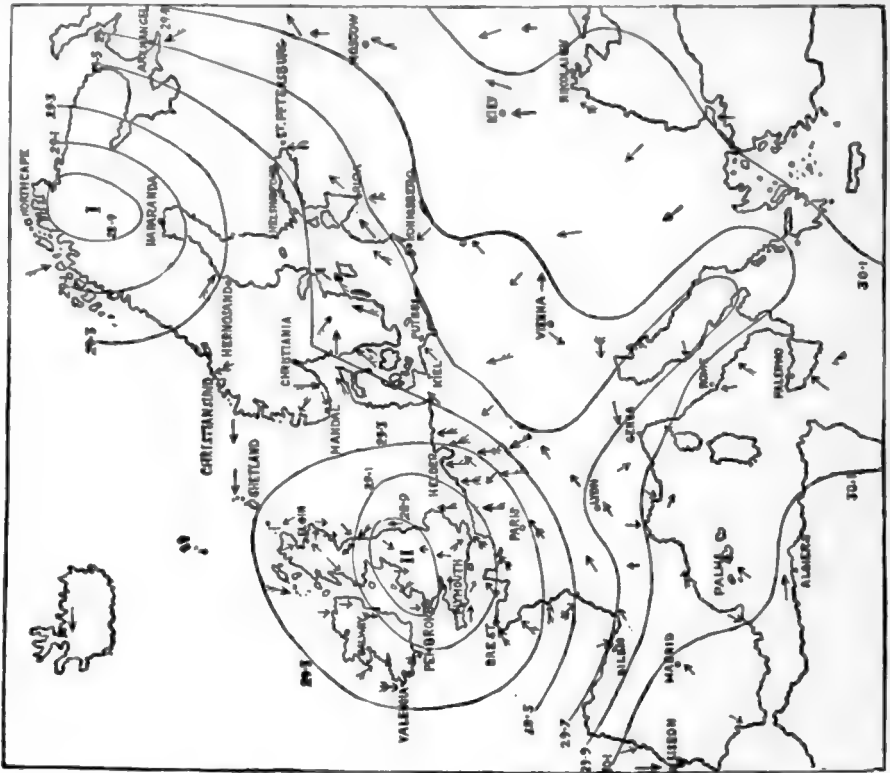

Storm Chart B.

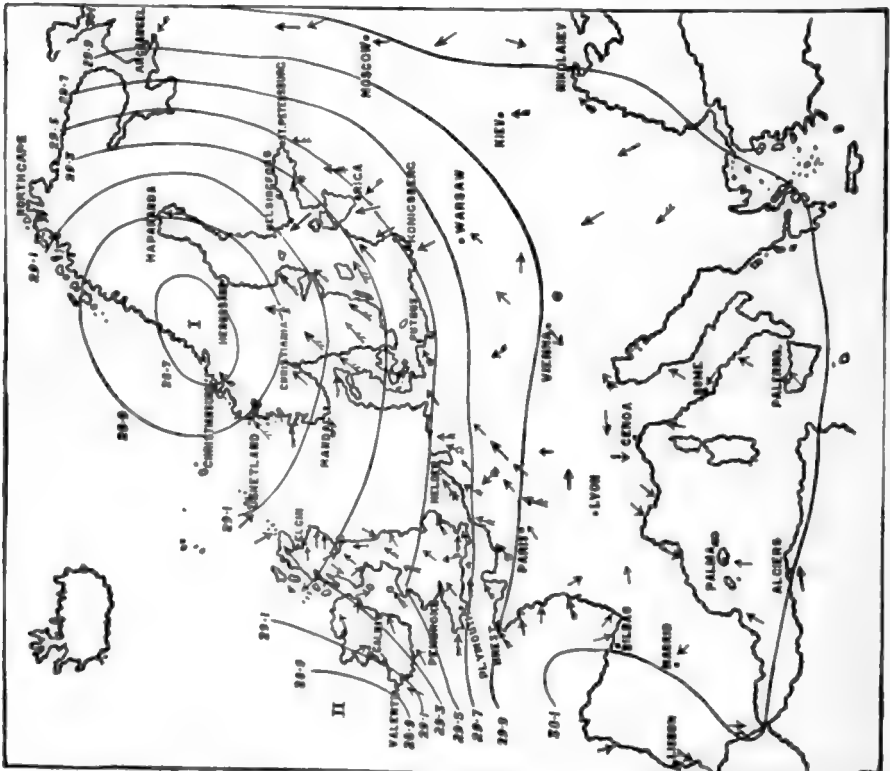

Storm Chart A.

proceeded east to Copenhagen. By the time it arrived at Copenhagen its extent was only a fourth of what it had been the previous day, and the central depression half an inch less. Twelve hours later the atmospheric equilibrium was restored, the storm having died out on reaching the Baltic Sea. The storms of the Mediterranean follow a different course. While a number take the general easterly course of European storms, a larger number originate in the gulfs of Lyons and Genoa, and pursue devious courses over this northern extension of the Mediterranean, till they die out; several advance from Turkey and Greece towards the Alps; and others, comparatively few, advance in an easterly course towards the Levant. A marked feature of these Mediterranean storms, including those of the Adriatic, is their slow, frequently retrograde, and erratic courses, and the small space traversed by them; and while they last the mistral, with dry cutting wind, sweeps down from the Alps on the health-resorts of southern France. By far the greater number of the storms of North America take their rise in the vast plain which lies to the east of the Rocky Mountains, and thence advance in an eastern direction over the United States, their course being largely determined by the great lakes; some of them cross the Atlantic, and burst on the western shores of Europe. But the connection of the American with the European storms is not even yet well established. The storms of the West Indies generally take their rise somewhere north of the region of calms, and, tracing out a parabolic course, proceed first towards the west-north-west, and then turn to the north-east about 30° N. lat., not a few traversing the east coasts of North America as far as Nova Scotia. South of the equator they follow an opposite course. Thus, in the Indian Ocean they first proceed toward the south-west, and then gradually curve round to the south-east. The hurricanes of India usually pursue a parabolic path, first traversing the eastern coast towards Calcutta, and then turning to the north-west up the valley of the Ganges. The typhoons of the Chinese Seas resemble, in the course they take, the hurricanes of the West Indies.

Probably the course tracked out by storms is determined by the general system of winds which prevail, modified by the unequal distribution of land and water on the surface of the globe, the diffusion of the aqueous vapour, and its concentration over the regions traversed by the storms. Facts seem at present to point to the general conclusion that storms follow the course of the atmospheric current in which the condensation of the vapour into the rain which accompanies them takes place.

Rate at which Storms travel.—If the position of the centre of storm I. in chart B be compared with its position on the 1st on the charts, it will be found to have travelled 420 miles in 24 hours, or at the rate of 17½ miles an hour. Similarly storm II. will be found to have travelled in the same time 400 miles, or at the rate of 16½ miles an hour. This is not far from the average rate of the progressive movement of European storms. From an examination of extensive series of storms Professor Loomis has shown that the average rates of progress of storm centres are in miles per hour 28 for the United States, 18 for the middle latitudes of the Atlantic Ocean, 17 for Europe, 15 for the West Indies, and 9 for the Bay of Bengal and China Sea. On January 7-8th 1877 a storm travelled in 24 hours from Indianola (Texas) to Eastport (Maine)—1872 miles, or 78 miles an hour. On the other hand, the rate of progress is, particularly in the tropics, sometimes so slow as to be virtually stationary; and, as already stated, they occasionally recurve on their paths.

Relations of Temperature, Rain, and Cloud to Storms.—Temperature increases at places toward which and over which the front part of the storm is advancing, and falls at those places over which the front part of the storm has already passed. In other words, the temperature rises as the barometer falls, and falls as the barometer rises. When the barometer has been falling for some time clouds begin to overspread the sky, and rain to fall at intervals; as the central depression approaches the rain becomes more general, heavy, and continuous. After the centre of the storm approaches, or shortly before the barometer begins to rise, the rain becomes less heavy, falling more in showers than continuously; the clouds break up when the centre has passed, and fine weather, ushered in with cold breezes, ultimately prevails. If the temperature begins to rise soon and markedly after the storm has passed, a second storm may be shortly expected.

Direction of the Wind.—If the winds in storm II. in chart B be examined, they will be observed whirling round the area of low barometer in a circular manner, and in a direction contrary to the motion of the hands of a watch, with a constant tendency to turn inwards towards the centre of lowest pressure (i.e. in the manner formulated in Buys-Ballot's law). The wind in storms neither blows round the centre of lowest pressure in circles, nor does it blow directly towards that centre, but takes a direction nearly intermediate, approaching, however, nearer to the direction and course of the circular curves than of the radii to the centre. In the front of the storm the winds blow more towards the centre, but in the rear they blow more closely approximate to the circular isobaric lines. Where the direction of the wind differs to any material degree from the above it is light, and consequently more under local influences, which turn it from its true course. Thus, the centre of the storm being near Liverpool, the direction of the wind is south-west at Paris, south at Yarmouth, north-east at Silloth, north at Dublin, and north-west at Cork—instead of south at Paris, south-east at Yarmouth, north at Silloth, north-west at Dublin, and west at Cork, if it had blown directly to the area of lowest pressure, and west at Paris, south-west at Yarmouth, east at Silloth, north-east at Dublin, and north at Cork, if it had circulated in the direction of the isobaric curves. Hence in this storm the winds circulate round the centre of least pressure, or, to speak more accurately, the whole atmospheric system flows in upon the centre in a vorticose manner. This peculiarity is common to all storms in the northern hemisphere that have yet been examined. In the southern hemisphere a rotatory motion is also observed round the centre of storms, but it takes place in a contrary direction, or in the direction of the motion of the hands of a watch, instead of contrary to that direction, as obtains north of the equator.

Professor Taylor first applied Dove's law of rotation to explain the direction of the rotation of storms round their centre. This may be explained by referring to storm II. in chart B. On that morning the pressure over England being much less than in surrounding countries, if the earth had been at rest air-currents would have flowed from all directions to England, to fill up the deficiency, in straight lines. The earth, however, is not at rest, but revolves from west to east; and, as the velocity of rotation diminishes as the latitude increases, it is evident that the current, which set out say from Lyons to the north, would, on account of its greater initial velocity when it arrived at Paris, blow no longer directly to the north, but to a point a little to the east of north; in other words it would no longer be a south, but

a south-west wind. Again, since the current from the north of Scotland had a less velocity than those parts of the earth's surface on which it advanced, it lagged behind, and consequently by the time it arrived at Sillloth in the north of England had changed from a north to a north-east wind. Similarly the north-west current changed to a north, the south-west to a west, &c. The west and east currents, since they continued in the same latitude, would have blown in the same direction, if they had not been disturbed by contiguous currents. Hence in a storm the whole system of winds appears to rotate round the centre. As a further confirmation of this theory, it is observed that when a high pressure covers a limited space the wind is always observed gently *whirling out of this area of high barometer*, but in exactly opposite directions in both hemispheres from those assumed when it blows round and in upon an area of low pressure. It follows in the northern hemisphere that as storms advance the general veering of the wind at places lying north of the path of their centre is from north-east by north to west, and at places south of their centre from north-east by east and south to north-west, and conversely in the southern hemisphere.

Force of the Wind.—The rule is simple, and without exception—viz. the wind blows from a high to a low barometer with a force proportioned to the barometric gradient or to the difference of the barometric pressures reduced to sea-level. Hence where the isobaric lines crowd together the violence of the storm is most felt, and where they are far asunder the winds are moderate, light, or *nil*. We thus see the importance of observations from a distance in forecasting the weather. To take an illustration: the importance of observations from Norway and Sweden to all seaports on the east coast of Britain cannot be overestimated, for if the pressure be high in Norway and low in the North Sea or in the south of Great Britain violent easterly gales will sweep down on Scotland, and, unless foreseen and provided against, strew the coast with wrecks; whereas if the pressures be nearly equal little danger need be apprehended, even though the barometer be low in Britain. As the wind nears the centre of the storm it gradually abates, till on reaching the centre a lull or calm takes place—a peculiarity more uniformly noted as regards tropical storms. Calms and light winds also prevail along the ridge of highest barometer, or the region where the pressure is greatest, and on receding from which the pressure diminishes on each side. This arrangement of the pressure is accompanied with fine weather and the 'pet' days of winter. It may not inaptly be compared to the watershed in physical geography, since from it the wind flows away on either hand towards the places where pressure is less.

The *progressive motion* of storms, which may vary from zero to 78 miles an hour, measures the time taken in passing from one place to another, but it gives no indication of the violence of the storm. This is determined by the velocity of the wind round and inwards upon the centre of the storm, which in Europe and America frequently amounts to 60 or 80 miles an hour continuously for some time. In intermittent gusts a speed of 120 miles an hour has been several times observed in Britain—a velocity which is perhaps sometimes surpassed by storms within the tropics. On the top of Ben Nevis higher velocities, rising to upwards of 150 miles, are of not infrequent occurrence.

Causæ of Cyclones.—Dove, who did so much in this department of meteorology, held the view that cyclones are formed when two great atmospheric currents, called polar and equatorial, flow side by

side, storms being the eddies, as it were, formed along the line of junction. It is to be kept in mind that the qualities of the atmosphere in the front portion of a cyclone are quite different from those in the rear—the former being warm and moist, while the latter are cold and dry. The conclusion is inevitable that the apparent rotation of winds in storms is simply a circulatory movement maintained between two currents, and that no mass of the same air makes the complete circuit of the cyclone. This feature of storms will, if rightly apprehended, play an important rôle in the development of the theory of the law of storms which lies yet in the future. The height to which storms extend in the atmosphere, as has been shown from the Ben Nevis observations, is greatly less than had been supposed.

Forecasting.—Valuable aid in forecasting storms and weather is derived from two important deductions from past observations: I. A cyclone tends towards a path near to the anticyclone which lies immediately to the right of the progressive motion of the storm at the time. II. When the rates of fall of the barometer at stations in the west of Europe are noted, it is found that the path taken by the coming storm is indicated by those stations at which the rates of fall of the barometer are greatest.

Relation of Storms to the Character of the Season.—This is vital and all-important. Thus, as regards the British Islands, when the general path pursued by storms in their easterly course over Europe lies to the southward the winter is severe, inasmuch as the British Islands are then on the north side of the centre of low pressure, and consequently in the stream of the northerly and easterly winds which there prevail. On the other hand, when the paths of storms lie to the northward the British Islands are on the south side of the low pressure, and therefore in the stream of the warm, moist, southerly and south-westerly winds which there prevail. The weather of December 1890 and that of February 1891 illustrate these two distinct types of weather. In December 1890 the weather was colder in the southern counties of England than it had been during the present century. At Oxford the temperature was 10° under the average, and in the south-western provinces of Russia the mean temperature was fully 14° below the average. On the other hand, to the north of a line drawn from Wilna to Bergen temperature was above the average, the excess above the mean increasing on advancing northward till in the north of Norway it was 10° , and at the entrance of the White Sea 13° . In the same month in the Eastern States and Canada temperature was under the average, the deficiency being 11.5° at Montreal; whereas over the rest of the United States temperature was high, the excess increasing on proceeding northward till, in Assiniboia, it was from 14° to 17° above the average. The explanation is at once afforded by the distribution of atmospheric pressure at the time. In Europe pressure was unusually high from the north of Scotland to St Petersburg. But, what is of more importance, it diminished steadily southward over the continent and into the north of Africa, and, on the other hand, also diminished steadily over the north of Europe, being 0.350 inch lower at the North Cape than at Bergen. Consequently the whole of the southern half of Europe was swept by northerly and easterly winds, bitterly cold and dry, and temperature fell unprecedentedly low; but in the north southerly and south-westerly winds inevitably prevailed, beating to the northern climes the warmth of lower latitudes. In America atmospheric pressure was above the average over a broad area extending from New Orleans to Lake

Huron, while on the one hand over the Eastern States and Canada it fell below the average, and on the other also below the average over Assiniboia. From this distribution of pressure it inevitably resulted that Canada and the Eastern States were swept by cold, dry, north-westerly winds of unusual strength and prevalence, while Assiniboia enjoyed southerly breezes from, as the isobars and winds show, the low latitudes of the Gulf of Mexico.

It is plain that the character of the weather of any particular day or season is wholly determined by the way in which areas of high and of low atmospheric pressure are distributed over the region during that day or season. Further, the weather of the coming season could certainly be predicted for say the British Islands, if only the general path was known which the centres of the Atlantic cyclones will take in their easterly course over Europe; for if the paths of the winter storms be to the north of Great Britain the winter will be an open one, but if to the south a severe winter is the certain result. Towards the solution of this highly practical problem we look to seamen to put us in possession of a fuller and, above all, an earlier knowledge of the fluctuations of the surface temperature of the Atlantic, and to high-level observatories for the data required in obtaining a clearer insight into the history and theory of storms.

See METEOROLOGY, SIGNALLING, HAILSTORM, ANEMOMETER, WIND, &c.; Redfield, *On the Law of Storms* (1840); Espy, *The Philosophy of Storms* (1841); Peddington, *Application of the Law of Storms to Navigation* (1844); Sir W. Reid, *Progress of the Development of the Law of Storms* (1849); Dove, *On the Law of Storms* (Eng. trans. 1862); Meldrum, *Law of Storms and Navigation* (1873); Ferrel, *Storms, Tornados, and Waterspouts* (1878); Loomis, *Contributions to Meteorology* (3 parts, 1885-89); H. G. Hazen, *The Tornado* (New York, 1890); and the daily weather charts and relative memoirs published in Great Britain, United States, Canada, Australia, France, Holland, Germany, Austria, Denmark, Sweden, Russia, India, China, Japan, &c.

Stornoway, a seaport and important fishery-station in Lewis, the chief town of the Outer Hebrides, near the head of a spacious sea-loch, 59 miles N. by W. of Portree in Skye and 180 of Oban. The principal feature is Stornoway Castle, completed in 1870 by Sir James Matheson (1796-1878), at a cost, with the grounds, of £89,000. Pop. (1841) 1354; (1891) 3387.

Storthing (from *stor*, 'great,' and *thing*, 'court'), the legislative assembly of Norway. See Vol. VII. p. 532.

Story, JOSEPH, an American jurist, was born at Marblehead, Massachusetts, September 18, 1779, graduated at Harvard in 1798, and was admitted to the bar in 1801. He was elected to the state legislature in 1805, and there became a leader of the Republican (Democratic) party. In 1808 he was returned to congress, and in 1811 he was appointed by Madison associate justice of the Supreme Court of the United States, a place he filled with great credit for thirty-four years. In 1829 he became law professor at Harvard, and quickly raised the school to fame and prosperity. Of his many works the most valuable are his *Commentaries on the Constitution of the United States* (1833), on *The Conflict of Laws* (1834), and on *Equity Jurisprudence* (1835-36), which have passed through many editions. His legal writings and decisions are among those oftenest quoted in the higher courts of law. He died September 10, 1845. See the Life by his son (1851), who also prepared an enlarged edition of his *Miscellaneous Writings* (1851).—The son, WILLIAM WETMORE STORY, was born at Salem 12th February 1819,

graduated at Harvard in 1838, studied law under his father, and was admitted to the bar. He even entered with spirit on his profession; but soon (1848) the bias towards poetry and art, which had been checked in the father after one luckless venture, drew him to Italy and made him a sculptor. His productions in this field are of high excellence; and his writings include *Poems* (1847-56-86), *Roba di Roma* (1862), the *Tragedy of Nero* (1875), *Castle St Angelo* (1877), *He and She* (1883), *Fiammetta* (1885), *Excursions in Art and Letters* (1891), *A Poet's Portfolio* (1894), &c. Mr Story received honorary doctorates from both Oxford and Bologna, and was decorated by the French and Italian governments. Died October 7, 1895.

Stothard, THOMAS, designer and painter, was the son of a London innkeeper, who kept the *Black Horse* in Long Acre, and was born there, 17th August 1755. He received a respectable education in different boarding-schools, and on his father's death, having shown a predilection for the use of the pencil, was bound apprentice to a pattern-drawer in the city, but was released from his engagement before the term of expiry, and betook himself to more artistic work. His first notable effort was a series of designs for the *Town and Country Magazine*, which was followed by his imaginative compositions for Bell's *British Poets* and the *Novelist's Magazine*. The popularity of these was so great that for many years his services were constantly in request by the leading publishers in London. His earliest pictures exhibited at the Royal Academy were 'The Holy Family' and 'Ajax defending the Body of Patroclus.' In 1791 he was chosen an associate, in 1794 a member, and in 1813 librarian of the Academy. He died 27th April 1834. Stothard was a most graceful and facile illustrator. Not less than 3000 of his designs have been engraved, including those to Boydell's *Shakespeare*, *The Pilgrim's Progress*, *Robinson Crusoe*, and Rogers' *Italy and Poems*. His paintings, although skilfully 'composed' and finely coloured, are destitute of the originality and force that come from a study of nature. Perhaps the best known is his 'Canterbury Pilgrims,' engraved in 1817. See the Life (1851) by Mrs Bray (q.v.), the widow of his son, CHARLES ALFRED STOTHARD (1786-1821), who acquired a great reputation as an antiquarian draftsman.

Stoughton, JOHN, a learned English divine, was born in Norwich, 18th November 1807, and educated at Highbury College, Islington, and University College, London. Appointed Congregationalist minister at Windsor in 1832, he removed to Kensington in 1843, and here laboured till his retirement in 1875, when the congregation presented him with £3000. From 1872 till 1884 he acted as professor of Historical Theology and Homiletics in New College, St John's Wood. He was Congregational lecturer in 1855, chairman of the Congregational Union in 1856, received the D.D. degree from Edinburgh in 1869, took part in the Evangelical Alliance Conferences at New York (1873) and Basel (1879). He died 24th October 1897. See *Life* by his daughter (1899).

He edited for many years *The Evangelical Magazine*, and has written many books marked by profound learning, the most important *Church and State Two Hundred Years Ago* (1862); *Ecclesiastical History of England* (5 vols. 1867-74), supplemented by two volumes on the Reign of Anne and the Georges (1878), and two on the period of 1800-50 (1884); *Homes and Havens of Luther* (1875); *Footsteps of the Italian Reformers* (1881); *Spanish Reformers* (1883); studies of Wilberforce, Penn, Howard; and *Recollections of a Long Life* (1894).

Stour, a river 47 miles long, flowing eastward along the Suffolk and Essex boundary to the sea at Harwich.

Stourbridge, a market-town of Worcestershire, on the Stour, at the border of Staffordshire and the Black Country, 4½ miles S. by W. of Dudley and 12 W. by S. of Birmingham. The famous Fireclay (q.v.) is said to have been discovered about 1555 by wandering glassmakers from Lorraine; and Stourbridge now has glass, earthenware, and firebrick works, besides manufactures of iron, nails, chains, leather, &c. The grammar-school (1552), at which Samuel Johnson passed a twelvemonth, was rebuilt in 1862; and there are also a corn exchange (1854), county court (1864), and mechanics' institute. Pop. (1851) 7847; (1881) 9737; (1891) 9386.

Stourbridge Fair, Cambridge. See FAIRS.

Stourport, a town of Worcestershire, at the Stour's influx to the Severn, and the terminus of the Staffordshire and Worcestershire Canal, 14 miles by rail N. by W. of Worcester and 4 SSW. of Kidderminster. Dating from 1770, it is a clean, neat place, with manufactures of carpets, iron, glass, &c. Pop. (1851) 2923; (1891) 3504.

Stouthrieff, in the law of Scotland, means robbery committed in a dwelling-house.

Stove. See WARMING.

Stove-plants is another name for hothouse plants—plants which require artificial heat to make them grow and keep healthy in the colder temperate climes. They may be practically classified according to the kind and degree of heat required—from those suitable to the dry hothouse to those fitted to thrive in a cool greenhouse; from tropical orchids to hardy heaths. See PLANT-HOUSES, and the articles on the several species of plants.

Stow, JOHN, one of the earliest and most diligent collectors of English antiquities, was born in London in the year 1525. He was brought up to his father's trade of a tailor in Cornhill, but about his fortieth year abandoned it for antiquarian pursuits with a noble devotion which ought to have ensured him an old age of ease and honour, but which brought him instead only want and beggary. In his eightieth year he was rewarded with letters-patent from James I. authorising him to become a mendicant, or, as it is expressed, 'to collect amongst our loving subjects their voluntary contributions and kind gratuities.' He died 5th April 1605, and was buried in the parish church of St Andrew Undershaft, where his monument of terra-cotta, erected at the expense of his widow, may still be seen. Stow's reverence for the institutions of the past caused him to be suspected of a secret leaning toward popery. The principal works of Stow are his *Summary of English Chronicles*, first published in 1561, and subsequently reprinted every two or three years, with a continuation to the date of each new publication; *Annals, or a General Chronicle of England* (1580); and, most important of all, the invaluable *Survey of London and Westminster* (1598), an account of the history and antiquities of the two cities for six centuries, together with their municipal institutions and forms of government. Besides these original works Stow assisted in the continuation of Holinshed's Chronicle, Speght's edition of Chaucer, &c. His invaluable *Memoranda to Three Fifteenth Century Chronicles* was printed with the text of these by James Gairdner for the Camden Society in 1881. There is a memoir prefixed to the compendious edition of the *Survey* (1842) by W. J. Thoms.

Stowe, HARRIET BEECHER. See BEECHER.

Stowell, WILLIAM SCOTT, LORD, the eldest brother of Lord Eldon (q.v.), was born at Heworth, Durham, 17th October 1745. He was educated at Newcastle, went to Oxford in 1761, and became

a college tutor. In 1779 he took the degree of D.C.L., removed to London, and was called to the bar in 1780. Dr Johnson introduced him to the Literary Club. As a barrister at Doctors' Commons he obtained a large practice, and his promotion was rapid. In 1788 he was appointed judge in the Consistory Court, knighted, and nominated a privy-councillor. In 1798 he became judge of the Court of Admiralty. Both as an ecclesiastical and admiralty judge he won high distinction. He wrote no systematic treatise or text-book, but his judgments were admirably reported, and supply the best evidence of his extensive legal learning, his sagacity, and his great literary ability. He was long the highest English authority on the law of nations. He represented Oxford in the House of Commons for twenty years, but he took no part in the business of parliament, although, like his brother, he was a zealous supporter of the Conservative party and the established church. At the coronation of George IV. he was raised to the peerage under the title of Baron Stowell of Stowell Park. In 1828 he retired from the bench, and on the 28th January 1836 he died. See the lives of the two brothers by Surtees cited at ELDON.

Stowmarket, a market-town of Suffolk, on the Gipping, 12 miles NW. of Ipswich. Pop. (1801) 1761; (1891) 5304. Its fine flint-work church (chiefly Decorated) is surmounted by a tower and spire 120 feet high, and the interior contains some interesting monuments, amongst them one to Dr Young—Milton's tutor, and a former vicar. An iron-foundry, chemical and gun-cotton works—the last the scene in August 1871 of a disastrous explosion by which twenty-three persons lost their lives—are in operation, whilst malting and stay-making are also carried on. Burkitt (the commentator) and the poet Crabbe were educated in the town, which, too, was the scene of Godwin's ministry (1778-87). See Hollingsworth, *History of Stowmarket* (1844).

Strabane, a market-town of County Tyrone, Ireland, on the Mourne, 14 miles by rail S. by W. of Londonderry. Its flax and grain markets are celebrated; and it has fine Catholic, Episcopalian, and Presbyterian churches, and a convent on the hill above the town. Pop. 4196.

Strabismus. See SQUINTING.

Strabo, an ancient geographer, born at Amasia in Pontus, probably about 64 B.C., although some authorities make it ten years later. By the mother's side he was of Greek descent, and also closely connected with the Mithridatidæ; of his father's family nothing is known. How the name Strabo ('squint-eyed') must have originated is obvious, but whether any of the family were so called before him is uncertain. Strabo studied under the grammarian Tyrannio at Rome, under Aristodemus at Nysa in Caria, and under the philosopher Xenarchus either at Rome or at Alexandria. He does not appear to have followed any calling, but to have spent his life in travel and study, from which it may safely be inferred that he was well off. He was at Corinth in 29 B.C., ascended the Nile with Ælius Gallus in 24, and seems to have been settled at Rome after 14 A.D., but all we know of the date of his death is that it was after 21 A.D. Of Strabo's great historical work in forty-seven books—from the fifth a continuation to his own time of Polybius—we have only a few fragments; but his *Geographica* in seventeen books has come down to us almost complete. It is a work of great value in those parts especially which record the results of his own extensive observation. 'Westwards,' he says in a passage in the second book, 'I have travelled from Armenia to the parts

of Tyrrhenia adjacent to Sardinia; towards the south, from the Euxine to the borders of Ethiopia. And perhaps there is not one among those who have written geographies who has visited more places than I have between these limits.' Yet it must not be supposed that he describes with equal accuracy or fullness all the countries of whose geography he treats. Some he seems to have visited hurriedly, or in passing elsewhere; others he knows like a native. For example, his accounts of Greece, particularly the Peloponnesus, are meagre in the extreme, and of many of the obscure regions he writes chiefly from hearsay. He makes copious use of his predecessors Eratosthenes, Artemidorus, Polybius, Posidonius, Aristotle, Theopompus, Thucydides, Aristobulus, and many other writers now lost to us, but he strangely depreciates the authority of Herodotus, and quotes few Roman writers except Fabius Pictor and Julius Cæsar. Of the seventeen books of the *Geography* books i.-ii. contain a criticism of former geographers, and the mathematical part of physical geography—the poorest portion of the work; book iii. is devoted to Spain; iv. to Gaul, Britain, and Ireland; v. and vi. to Italy; vii. to the north and east of Europe as far as the Danube; viii.-x. to Greece; xi.-xvi. to Asia; xvii. to Africa. The style is pure and simple. The *editio princeps* of Strabo appeared at Venice in 1516. Good editions are those by Müller and Dübner (1852-56) and Meineke (1852-53). See Marcel Dubois, *Examen de la Géographie de Strabo* (1891).

Stradella, ALESSANDRO, a singer and musical composer, famous both in respect of his music and of his own tragical history. His works, which consist of airs, duets, cantatas, madrigals, sonatas, and the oratorio *San Giovanni Battista* (his most important production), contributed to form the taste of such composers as Purcell and Scarlatti. The dates of his life are altogether uncertain; it can only be affirmed that he lived during the second half of the 17th century. But the facts or events of his life are better ascertained. Stradella, who was renowned for his exquisite voice and polished manner, was engaged by a wealthy Venetian to instruct his mistress in singing. But master and pupil became infatuated with one another and fled to Rome. They were traced thither by two bravos despatched by the Venetian; but both assassins, it is said, were so captivated with the music of Stradella's oratorio, which they heard him conducting whilst lying in wait for him, that they abandoned their object, after betraying to him the plot. Stradella and the lady then fled to Turin. They were found there, and the musician was attacked and left grievously wounded. He recovered and married the lady, and then proceeded to Genoa (1678). The day after his arrival both he and his wife were mortally stabbed in their bedchamber by the emissaries of their unrelenting persecutor.

Stradivari, ANTONIO, the famed violin-maker of Cremona, lived 1649-1737. He was the pupil of Nicholas Amati, and carried the Cremona type of violin to its highest perfection. See VIOLIN.

Strafford, THOMAS WENTWORTH, EARL OF, English statesman, was born on Good Friday, 13th April 1593, in Chancery Lane, London, at the house of his mother's father, Robert Atkinson, a bencher of Lincoln's Inn. The eldest of the twelve children of Sir William Wentworth, he represented a great Yorkshire family, which from before the Conquest had been seated at Wentworth-Woodhouse near Rotherham, and was allied to royalty itself. He grew up a keen sportsman, an apt and diligent scholar, and was sent at an early age to St John's College, Cambridge. In 1611 he was

knighted and married; and having thereafter travelled for fourteen months in France and Italy, in 1614 he was returned to parliament for the county of York, and succeeded his father in the baronetcy and an estate of £6000 a year. In 1615 he became *custos rotulorum* for the West Riding—a post from which Buckingham sought two years later to oust him; else we know little about him during James I.'s reign save as a generally silent member in three brief parliaments, a strenuous student, and a frequent attendant at the Court of Star-chamber. His first wife, Lady Margaret Clifford, eldest daughter of the Earl of Cumberland, died childless in 1622, and in 1625 he married Lady Arabella Holles, the younger daughter of Lord Clare.

Conscious of his own splendid abilities, and with no great belief in parliamentary wisdom, loyal in his devotion to crown and church, an eager advocate of domestic reforms, and therefore opposed to all wars of aggression, Wentworth in Charles's first parliament (1625) acted with, yet was not of, the opposition; from the second he was purposely excluded by his appointment to be sheriff of Yorkshire. In the July of that same year (1626), after a vain application to Buckingham for the presidency of the Council of the North, he was curtly dismissed from the keepership of the rolls, and for refusing to pay the forced loan he was committed first to the Marshalsea and then to an easy captivity at Dartford. So in the famous third parliament (1628) he impetuously headed the onslaught, not on the king, but on his evil ministers, and pledged himself 'to vindicate—what? New things? No! our ancient, sober, and vital liberties! by reinforcing of the ancient laws made by our ancestors; by setting such a stamp upon them as no licentious spirit shall dare hereafter to enter upon them.' From its meeting on 17th March until 5th May he was the leader of the Lower House; on 7th July the Petition of Right (q.v.), superseding a similar measure of his own, became law; and on the 22d he was created Baron Wentworth, on 10th December Viscount Wentworth, and on the 15th President of the North. As such at York he set himself to govern, to strengthen government with an efficient militia and ample revenue, and to 'comply with that public and common protection which good kings afford their good people.' Towards these ends he used on occasion high-handed methods, which embroiled him, however, chiefly with the gentry. His second wife died in October 1631, leaving a son William, second Earl of Strafford (1626-95, died *s.p.*), and two daughters; and within a twelvemonth he married privately Elizabeth, daughter of Sir George Rhodes, knight.

In January 1632 he was appointed Lord Deputy of Ireland, but it was not till the July of the following year that he landed at Dublin. His plans had, however, been meanwhile carefully matured; and with the subtlety of a Machiavel and the strength of an Englishman he straightway proceeded to coerce Ireland into a state of obedience and well-being unknown alike before and afterwards. He raised the revenue from an annual deficit of £14,000 to a surplus of £60,000, and the customs from £12,000 to £40,000; transformed the army from a rabble of 1300 to an orderly force of 8000; swept the seas of the corsairs infesting them; introduced the cultivation of flax, still Ireland's one flourishing industry; called into existence a docile parliament; did his utmost to cleanse the Augean stable of the Protestant Church; and, whilst seeking 'to draw Ireland into conformity of religion with England,' could yet boast truly that since he had 'the honour to be employed there, no hair of any man's head was touched for the free exercise of his conscience.' The aim of his policy

(he and Laud called it 'Thorough') was to make his master 'the most absolute prince in Christendom;' and 'the choice for Ireland in the 17th century did not lie between absolutism and parliamentary control, but between absolutism and anarchy.' The words are Professor Gardiner's, and he adds that 'if Wentworth be taken at his worst, it is hardly possible to doubt that Ireland would have been better off if his sway had been prolonged for twenty years longer than it was.' Wentworth taken at his worst should be Macaulay's Wentworth—the killer of his first wife, the debaucher of women, the 'wicked earl,' the 'first Englishman to whom a peerage was a sacrament of infamy,' the 'lost Archangel, the Satan of the apostasy,' who from the time of that apostasy received, like fallen Lucifer, a fresh name, Strafford. By this last amazing blunder—the schoolboy might detect it, and yet it has lived for upwards of sixty years—Macaulay's ignorance may be fairly gauged, the falsity of his first two charges estimated. None the less, by Macaulay's verdict has Wentworth been widely condemned. One turns from it to Wentworth's own correspondence, and there stand revealed his tenderness for his family, his love of harmless amusements, his hatred of gaming and drunkenness, his contempt of courtiers, and the maladies which constantly beset him—fever, ague, gout, and the stone—and to which his choleric temper is largely ascribable. He was not otherwise faultless, though many of his errors—e.g. in the matter of monopolies and of the proposed plantation of Connaught—were errors of the age. He was too masterful and self-reliant, too heedless of the means towards his end, intolerant of opposition to his will. One instance of his methods must suffice. Lord Mountnorris, vice-treasurer of Ireland, was for words rashly spoken court-martialed, and sentenced to death. The sentence was never meant to be carried out; in fact, Wentworth added, 'I would rather lose my hand than you should lose your head,' and Mountnorris was simply stripped of his offices. He deserved to be stripped of them; still, this was not the way to get rid of an opponent.

Till February 1637 Charles seems never to have applied to Wentworth on questions of general policy, and then, when he sought his approval of a foreign war, he was met with dissuasion. Nor till September 1639 did Wentworth become the king's principal adviser, the mark of the royal favour being his elevation to the earldom of Strafford and the dignity of Lord-lieutenant of Ireland (January 1640). It was all too late then. The rebellion, provoked in Scotland by Charles's unwisdom, was spreading to England; and Pym and his fellows judged rightly that Strafford was the one obstacle to their triumph. His Irish parliament was all subterfuge, but he a week after the meeting of the Long Parliament in November was impeached of high-treason and lodged in the Tower. In the great trial by his peers, which opened in Westminster Hall on 22d March 1641, Strafford, broken though he was by sickness, defended himself with a fortitude, patience, and ability that moved even his accusers, whilst alarming them. The twenty-eight charges, covering 200 folios, at most amounted to 'cumulative treason;' the gravest of them, his having counselled the king that 'he had an army in Ireland which he could employ to reduce *this kingdom*' (query England or Scotland), was supported by only one witness, his personal enemy, Vane. Four others who should have heard the words declared that they had not heard them. To the Lords the question was his guilt or innocence, to the Commons his condemnation; their spirit was shown in St John's declaration the 'we give law to hares

and deer, as beasts of chase, but knock foxes and wolves on the head as they can be found, because they be beasts of prey.' Accordingly, on 10th April the 'inflexibles'—Pym and Hampden were not of their number—dropped the impeachment for a bill of attainder, declaring that treason which could not be proved to be treason. The bill passed a third reading by 204 votes to 59 in the Lower House, by 26 to 19 in the Upper ('Stone dead hath no fellow,' said Essex); and on 10th May it received the royal assent. Strafford had written to Charles releasing him from his reiterated pledge that he should not suffer in life or honour or fortune; and Charles at last accepted the release. 'Put not your trust in princes'—the cry was wrung from Strafford; then he prepared himself quietly for death. They would not let him see his old friend Laud; but he knelt for his blessing under the prison window as he passed to the scaffold. The lieutenant of the Tower would have had him take coach lest the mob should tear him to pieces, but 'No,' was his answer, 'I dare look death in the face, and I hope the people too.' And so he died valiantly, Christianly, on Tower Hill, 12th May 1641, and was buried at Wentworth-Woodhouse. His death was followed by the abolition of Episcopacy, monarchy, parliament itself.

We know Strafford better now than his contemporaries could possibly know him, through his *Letters and Correspondence*, edited by Knowler (2 vols. 1739), and *Whitaker's Life and Correspondence of Sir George Radcliffe* (1810). Radcliffe (1593-1657) for years was Strafford's confidant; and his brief 'Essay towards the Life of my Lord Strafforde,' appended to Knowler's work, is one of our chief authorities. Modern Lives are by John Forster (*Emin. Brit. Statesmen*, vol. ii. 1836: Dr Furnivall in *Berdoe's Browning Cycl.* asserted that this was completed 'on his own lines' by Robert Browning, and as Browning's it was edited for the Browning Soc. by Mr C. H. Firth in 1892), J. B. Mozley (*Essays Hist. and Theological*, 2d ed. 1884), Elizabeth Cooper (2 vols. 1874), and H. D. Traill (1889). See also the articles CHARLES I. and LAUD, with works there cited; Browning's strangely unhistorical *Strafford: a Tragedy* (1837); ed. by Miss Hickey and Prof. S. R. Gardiner, 1884); and John Smith's *Catalogue Raisonné of the Works of Dutch Painters* (vol. iii. 1831) for a list of the half-dozen portraits by Van Dyck, in which the 'lion-faced' earl still lives for us. Strafford's eldest daughter Anne married Edward Watson, second Baron Rockingham and first Earl of Rockingham, the ancestor of Earl Fitzwilliam; his second daughter Arabella married the Hon. Justin M'Carthy, the Earl of Clancarty's third son, whom James II. created Viscount Mountcashell. A son and a daughter by his third wife both died unmarried.

Strain and Stress. A strain is any change of form or bulk of a portion of matter either solid or fluid. The system of forces which sustains the strain is called the stress. When a body is so strained that parallel lines remain parallel lines and parallel planes remain parallel planes, the strain is said to be homogeneous. Any cubical portion becomes a parallelepiped with angles, in general, other than right angles; and any spherical portion becomes an ellipsoid. The principal axes of this ellipsoid were originally mutually perpendicular diameters of the sphere. Clearly one of them must be the direction of greatest elongation (or least contraction), and another must be the direction of least elongation (or greatest contraction). These directions are the principal axes of the strain. A special case of the homogeneous strain is the isotropic strain, in which all lines suffer equal elongations—i.e. unit-length in any direction changes by the same amount. Here there is simple change of volume without any distortion; and the associated stress is of the type of a hydrostatic pressure. Now the most general homogeneous strain involves distortion as well as change of volume. If the strain is small we may

decompose the complete strain into these two types of strain, which, as explained under Elasticity (q.v.), have to do with two quite distinct coefficients—viz. the Rigidity (q.v.) and the bulk modulus (see COMPRESSIBILITY). A distortion is a strain which involves no change of volume; and any distortion can always be decomposed into a number of shears or simple distortions. The simplest representation of a shear is given by the slight deformation of a circle into an ellipse of the same area. The major and minor axes of the ellipse are the principle axes of the shear, which is completely determined when its plane, axes, and elongations or contractions along these axes are given. A shear may also be represented by the sliding action of layer over layer which transforms a square into a parallelogram of the same area. Corresponding to a shear is the shearing stress, whose ratio to the shear is called the rigidity. It is obvious that in bending a bow or twisting a rod (see TORSION) we are producing strains which are not homogeneous; but by considering very small portions we are able to discuss the relations holding between the strains and corresponding stresses as if the strains were homogeneous.

When a body is perfectly elastic the relation between stress and strain is unchanging; in other words, to sustain the strain the same stress must be constantly applied. All solids, however, may be strained to such a degree that the strain may be supported by a weaker stress than that which produced the strain at first. Or, when a given stress is kept applied, the body may gradually alter its condition of strain as time goes on. Solids, in short, are found to possess Viscosity (q.v.), in virtue of which they yield slowly to a steady stress. Thus Tresca has caused metals to flow through ducts by application of great pressure. See STRENGTH OF MATERIALS.

Bodies may be strained by the action of other agents than mechanical forces. The most familiar example of this is the change of bulk which accompanies change of Temperature (q.v.). Electrification also produces changes of volume. Again, the magnetic metals, iron, nickel, and cobalt, undergo very complicated strains when magnetised in various ways. In all these instances there is always a reciprocal effect, a particular straining producing thermal, electric, or magnetic changes.

Straits Settlements, a British colony in the East Indies, consists (since 1867) of settlements on the Straits of Malacca, or rather on the Malay Peninsula—viz. Singapore, Malacca, Penang, Keeling Islands (since 1836), and Christmas Island (since 1889). For particulars of these, see the respective articles. The total area is 1542 sq. m. and the total pop. (1881) 423,384; (1891) 506,577. About 150,000 of these are Chinese, and a large number natives of India; of these last there arrive about 18,000 every year, though nearly as many leave again. The principal productions of the colony are tin, gambier, tapioca, rice, sugar, pepper, and other spices. The trade is largely a transit one; and the exports reach approximately an annual value of £30,000,000, the imports of £40,000,000; but both are increasing at a rapid rate. There are a number of native dependent states, the salient particulars regarding which are given here, while the more important states are treated in separate articles.

State.	Made a British Protectorate in	Area, sq. m.	Pop. (1891).	Annual value of Imports.	Annual value of Exports.
Perak.....	1874	7,950	212,997	£1,101,000	£808,000
Selangor.....	1874	5,000	81,421	1,098,000	436,700
Sungei Ujong.....	1838	600	23,602	88,800	64,000
Negri Sembilan.....	1889	2,000	41,617	16,000	22,000
Pahang.....	1888	15,000	52,908
Total.....		30,610	412,440	£2,303,800	£1,130,700

The more notable productions of these states are tin, rice, coffee, sugar, tea, cinchona. Tin is chiefly mined in Perak by Chinese, and worked at the mines, and at Singapore and Penang. The climate of all these states and districts is pretty uniform, though high, the mean being 82.5° F. The rainfall is distributed with tolerable regularity over the whole twelve months, in which period it ranges from 84 to 110 inches. See the map in Vol. II. p. 562.

Stralsund, a seaport of Prussia, is situated on a narrow strait called the Strela Sound, which divides the mainland from the island of Rügen, and 67 miles by rail NW. from Stettin. It forms an island, connected with the mainland by bridges. Down to 1873 the place was a fortress of the first class. Many of the houses are finely gabled, which gives the town a quaint and ancient look. The most interesting building is the town-house (1306), with a museum of antiquities from the island of Rügen. Stralsund carries on a large export trade in malt, corn, fish, wool, coal, groceries, &c., and manufactures leather, sugar, starch, oil, and cards. Pop. (1890) 27,820. Stralsund was founded in 1209, and became one of the most important members of the Hansa. During the Thirty Years' War it successfully withstood a terrible siege (1628) by Wallenstein; but in 1678 it capitulated to the Great Elector after a furious bombardment. It again opened its gates to Prussia and her allies in 1715, to the French in 1807, and to the Danes and others in 1809. The town was held by the Swedes from 1628 to 1814; in the year following (1815) Denmark gave it up to Prussia.

Stramonium. See THORN-APPLE.

Strange, SIR ROBERT, engraver, was born at Kirkwall, in Orkney, on 14th July 1721. He had tried sailing and a law-clerkship with an elder half-brother in Edinburgh, when in 1735 he was apprenticed for six years to an English engraver there, Richard Cooper. His apprenticeship ended, he fell in love with a young Jacobite lady, Isabella Lumisden, and for her sake in 1745 espoused the cause of Prince Charles Edward, engraving not only his portrait but his bank-notes, and enlisting, as a private in the prince's life-guards. He fought at Culloden, escaped his pursuers by hiding beneath his sweetheart's ample-hooped gown, in 1747 married her, and next year repaired to Rouen and thence to Paris, and studied under Des-camps and Lebas. In 1750 he returned to Britain, and settling in London soon attained the very highest rank in his profession. On a second visit to the Continent (1760-65), to execute engravings after the old masters, his eminence was recognised by the academies of Paris, Rome, Florence, Bologna, and Parma, which all conferred on him the honour of membership; and subsequently, in 1787, he was knighted, having made peace with the reigning house by engraving West's picture of the apotheosis of George III.'s children, Octavius and Alfred. He died a wealthy man on 5th July 1792, his wife surviving him by fourteen years.

See Dennistoun's *Memoirs of Sir Robert Strange* (2 vols. 1855); the *Life* by the Rev. F. Woodward prefixed to *Twenty Masterpieces of Strange* (1874); and also the Introduction to Marshal Keith's *Memoir* (Spalding Club, 1843).

Strangford, VISCOUNT. Percy-Clinton-Sydney Smythe was born 31st August 1780, studied at Trinity College, Dublin, and entered the diplomatic service. He succeeded to the title as sixth viscount in 1801, was secretary of legation at Lisbon, and later ambassador successively to Portugal, Sweden, Turkey, and Russia. He was raised to the English peerage as Baron Penschurst

in 1825, and died 29th May 1855. His translation of the *Rimas* of Camoens he published in 1803.—His youngest son, PERCY ELLEN-FREDERICK-WILLIAM SMYTHE, was born at St Petersburg, 26th November 1825, and had his education at Harrow and Merton College, Oxford. He entered the diplomatic service, early acquired an unexampled command of languages, and served as Oriental secretary during the Crimean war. In 1857 he returned home to succeed as eighth and last viscount, thereafter lived mostly in London, immersed in philological studies ranging from Turkish, Persian, Arabic, and Afghan to Basque, Celtic, and Lithuanian, and died there, 9th January 1869. In spite of his phenomenal acquirements, he wrote little more than a few *Saturday*, *Pall Mall*, and *Quarterly* articles. His *Selected Writings: Political, Geographical, and Social*, was edited by his widow (2 vols. 1869), who also published his *Letters and Papers upon Philological and Kindred Subjects* (1878). See Fonblanque's *Lives of the Lords Strangford* (1878).

Strangles is a contagious eruptive disorder peculiar to young horses. It is ushered in by sore throat and cough, a muco-purulent nasal discharge, and the eruption of a swelling in the space between the branches of the lower jaw. In a few days this swelling comes to a head, bursts, and in favourable cases the patient is soon well again. From exposure to cold, poverty, or other causes, the swelling, however, occasionally appears in less favourable situations, as about the glands lying within the shoulder, in those of the groin, or even in those of the mesentery. Such irregular cases are apt to be protracted, accompanied by much weakness, and sometimes prove fatal. Bleeding, physic, and irritant dressings are injurious. Good food and nursing, with fomentations to the throat and steaming of the head, favour the healthier maturation of the swelling. When there is debility, coax the animal to eat by offering him at short intervals small quantities of scalded oats, malt, bran, or green food, and allow him several times daily a pint of sound ale if he will drink it, but do not force it upon him, as the throat is often irritable and the animal might be choked.

Strangulation may be defined as an act of violence in which constriction is applied directly to the neck, either around it or in the forepart, in such a way as to destroy life. This definition obviously includes hanging, which differs from other forms of strangulation only in that the body is suspended. The direct cause of death in the great majority of cases is arrest of the respiration owing to pressure on the windpipe—i.e. asphyxia. If much violence is used, it may be produced by direct injury to the upper part of the spinal cord from fracture or dislocation of the cervical vertebrae (as is now the rule in execution by hanging), or by syncope from shock, and in such cases must be almost instantaneous. On the other hand, if the constriction is so applied as to compress the great vessels in the neck and not the windpipe, as may happen in 'garotting,' it is due to coma, and is somewhat slower than in cases of asphyxia. Or if both vessels and windpipe are compressed, coma and asphyxia may both contribute to cause death.

The internal appearances of the body after death are those of Asphyxia (q.v.), with specially marked congestion of the brain; the most constant external appearances are congestion of the face, with prominence of the eyes and protrusion of the tongue, and marks on the neck corresponding to the cord or other constricting agent. The latter are most evident and the injuries to the neck most severe in homicidal cases. Death by hanging (excepting judicial executions) is almost always

suicidal; by other forms of strangulation it also is frequently suicidal, but often homicidal. Accidental strangulation in any form is rare.

When suspension of the body has not continued for much more than five minutes, and the parts about the neck have not suffered violence, there is a probability that resuscitation may be established; although many cases are recorded when after only a few minutes' suspension it has been found impossible to restore life. Moreover, if a person who has hanged himself has been cut down sufficiently soon to allow of the respiratory process being restored, he is by no means safe: death often taking place from secondary effects at various periods after the accident. It is believed that unconsciousness comes on very rapidly, and death takes place without causing any suffering; the violent convulsions that are so often observed being similar to those which occur in epilepsy. In homicidal cases, however, the appearance of the face sometimes indicates much distress. A man named Hornshaw, who was on three occasions resuscitated from hanging—a feat which he performed in London for the amusement of the public—stated that he lost his senses almost at once; and other persons who have been restored state that the only symptoms of which they were conscious were a ringing in the ears, a flash of light before the eyes, then darkness and oblivion. The treatment to be adopted after the patient has been cut down may be briefly summed up as follows: Exposure to a free current of air, cold affusion if the skin is warm, the application of ammonia to the nostrils, of mustard poultices to the chest and legs, and of hot water to the feet, and the subsequent abstraction of blood if there should be much cerebral congestion; above all, artificial respiration should be used if natural breathing do not at once commence. From the post-mortem appearances, together with circumstantial evidence, the medical practitioner is not unfrequently called upon to decide such questions as these: Was death caused by hanging, or was the body suspended after death? Was the strangulation the result of accident, homicide, or suicide? In case of strangulation from other causes than that of hanging the post-mortem symptoms are similar, but the injury done to the parts about the neck is commonly greater. In manual strangulation the external marks of injury will be in front of the neck, about and below the larynx; and if death has been caused by a ligature the mark round the neck will be circular, whereas in hanging it is usually oblique. The internal appearances are much the same as in the case of hanging. See Taylor's or other text-book of Medical Jurisprudence.

Strangury. See URINE.

Stranraer, a royal burgh and seaport of western Wigtonshire, beautifully situated at the head of Loch Ryan, 73 miles WSW. of Dumfries by rail. The buildings are a 16th-century castle in which the bloody Claverhouse lived as sheriff, the new town-hall and court-house (1872-73), and several handsome churches. There are no manufactures, but considerable trade in farm-produce. Loch Ryan affords fair fishing, but not now in oysters. There is a small but constant shipping-trade in bottoms belonging to the town, and a commodious mail-steamer plies daily between Stranraer and Larne in Ireland, the 'short-sea passage' merely taking about 2½ hours, only half being in open channel. Pop. of royal burgh (1871) 5977; (1881) 6415; (1891) 6193. Till 1885 Stranraer returned one member with Wigton (q.v.).

Straparola, GIOVAN FRANCESCO, was born near the end of the 15th century at Caravaggio, about half-way between Milan and Cremona. In

1550 he published at Venice *Tredici piacevoli notti*, the second part at the same place in 1554. This famous work was a collection of stories in the style of the *Decameron*, grouped round an imaginary incident. Francesca Gonzaga, daughter of Ottaviano Sforza, Duke of Milan, on account of commotions in that city, retires to the island of Murano, near Venice, where, surrounded by a group of brilliant ladies and gentlemen, she passes the time listening to stories related by the company. Thirteen nights are thus spent, and seventy-four stories told, each followed by an enigma, when the approach of Lent brings an interruption. These stories are derived from the most various sources; twenty-four are borrowed from Jerome Morlini, fifteen from Boccaccio, Sachetti, Brevio, Ser Giovanni, the *Fabliaux*, the *Golden Legend*, and the *Romance of Merlin*. Six are of plain oriental origin, and may be found in the *Panchatantra*, *Forty Viziers*, *Siddhi Kâr*, and *Thousand and One Nights*. Twenty-nine stories remain, and of these twenty-two are genuine folk-tales. Two of Straparola's stories found a wider immortality in Perrault's 'Peau d'Ane' and 'Le Chat Botté'; and many of Madam d'Aulnoy's fairy-tales, as well as others in the *Cabinet des Fées*, are mere translations. Straparola's book passed through sixteen editions in twenty years; a French translation of the first book by Jean Louveau appeared in 1560, reprinted in 1573, along with the second book as translated by Pierre de Larivey (*Les Facétieuses Nuits de Straparole* in P. Jannet's 'Bibliothèque Elzevirienne,' 2 vols. 1857; new ed. of Jouaust, with preface by Gustave Brunet, 1882). Many of Straparola's stories are *facetious* in its narrowest sense; but at least they are no worse than their contemporaries. The work was prohibited by the church in 1605; yet another reprint appeared at Venice so soon after as 1608.

See F. W. V. Schmidt's German translation of eighteen tales, with valuable notes (Berlin, 1817); the Dissertation by F. W. J. Brakelmann (Göttingen, 1867); Liebrecht's translation of Dunlop's *History of Fiction* (1851); and the translation of the *Nights* by W. G. Waters (2 vols. 1894).

Strasbourg (Ger. *Strassburg*, Fr. *Strasbourg*), formerly the capital of the French department of Bas-Rhin, but since 1871 capital of the German imperial territory of Alsace-Lorraine, stands on the river Ill and the canals connecting the Rhine with the Rhone and the Marne, 2 miles from the left bank of the Rhine, and 300 miles E. of Paris. The citadel, originally built by Vauban (1682-84), was demolished by the Germans during the bombardment of 1870, but since then they have rebuilt it and strengthened the fortifications with some fourteen detached forts on the adjacent heights, so that Strasbourg now ranks as a first-class fortress of great strength. Its position near the borders of France, Germany, and Switzerland is favourable to its commerce, and gives it great strategic importance. The most celebrated building in the city is the cathedral or minster, founded in 1015 or in 1179, but principally built between 1277 and 1439; some of the oldest parts are Romanesque (portions of choir and transept), but the church as a whole is one of the sublimest specimens of Gothic architecture in existence. The principal architect (to whom most of the glorious western façade is due) was Erwin von Steinbach (fl. 1318). Only one of the two towers was completed, with a spire of open stone-work (1439); it is 466 feet high. The minster has a remarkable astronomical clock dating from 1838-42; in it are portions of an older one made in 1571, but there was a remarkable clock here in the 14th century. In the present one are, besides a complete planetarium and perpetual calendar, many automaton figures—angels which strike the quarters, twelve apostles which come

forth at noon and pass in procession before a figure of Christ, and a cock which crows at stated times. In the church are also a magnificent rose-window (42 feet across), a fine pulpit, and grand stained glass. The damage done to the structure during the siege of 1870 was carefully repaired. Other notable buildings are the Protestant church of St Thomas, with the tomb of Marshal Saxe, the imperial palace, the library (formerly the castle, and then the episcopal palace), the new university, the public buildings of the province, and the arsenal. The university of Strasbourg was the only French university besides Paris with the full complement of faculties. Founded in 1621, on the basis of the academy of Johannes Sturm (q.v.), it became specially famous in the branches of medicine and philology, but was broken up during the Revolution. In 1803 a Protestant academy was established with ten chairs; and five years later Napoleon founded an imperial academy with faculties of law, medicine, physical science, and philosophy; in 1819 a partial fusion of these academies took place. The university was reorganised as a German institution in 1872, is equipped with new university buildings (1884), magnificent laboratories, &c., and has more than 100 teachers and 900 students. The famous library, with nearly 200,000 volumes and precious *Incunabula* (q.v.), was entirely destroyed by fire during the bombardment in 1870, but was replaced by a new collection that has now swelled to 600,000 volumes. The trade of Strasbourg, especially its transit trade, is very extensive, and it has a great variety of manufactures—beer, patés de foie gras, leather, cutlery, engines, musical instruments, jewellery, tobacco, furniture, chemicals, fancy articles, &c. Pop. (1880) 104,471; (1890) 123,566—one-half Catholics.

Strasbourg, the *Argentoratium* of the Romans, was colonised by them during the reign of Augustus. Here Julian won a great victory over the Allemanni in 357 A.D. The name *Stratisburgum* first appears in the 6th century. It became a free town of the German empire in the 13th century, and both then and in the early part of the 15th century occupied a prominent position in respect of culture and enlightenment. In 1681 it was seized by Louvois, at the command of Louis XIV., in a time of profound peace, and was confined to him by the treaty of Ryswick, but retained the quaint appearance of a German imperial city. On September 28, 1870, after a siege of seven weeks, Strasbourg surrendered to the Germans.

See Seinguerlet, *Strasbourg pendant la Revolution*; German works by Apell (Berl. 1884) and Krieger (Strasb. 1885); for the siege, Wagner (3 vols. Berl. 1874-77); also the article ALSACE-LORRAINE.

Strata Florida (Latinised from Ystrad Fflûr, 'Plain of the Fflûr'), the ruins of a Cistercian abbey founded in 1164, 17 miles SE. of Aberystwith. Little of the building but a Norman archway and part of a wall are now standing; but excavations in 1857-88 laid bare the foundations and some fine tiled pavements. See the monograph by S. W. Williams (1889).

Strategy has been defined by military writers as the 'science of generals,' 'the art of making war on the map,' or 'the art of rightly directing masses of troops towards the object of the campaign;' it is dependent upon the due consideration of everything that can possibly influence the campaign. Roughly speaking, strategy directs the movements of troops until contact with the enemy is imminent. From that moment all combinations and manœuvres are classed as *Tactics* (q.v.), until perhaps the opposing armies become again sufficiently separated for strategy to be employed. The object of strategy is to bring an

adversary into such a position that the chances of victory will be against him, and defeat will entail disasters beyond the loss of the battle. Strategy will be offensive or defensive according to political or geographical considerations and the relative strength or mobility of the belligerents. The former will give all the advantages of the initiative to the commander who can adopt it. He will by invading the enemy's country consume his supplies, and spare his own the horrors of war. He will be able to make and carry out his plans unimpeded by his opponent, who will be ignorant where the mass of his troops are concentrated, and so must await the attack in a more or less scattered and therefore dangerous condition. Defensive strategy, on the other hand, has advantages in facility of supply and transport, freedom of movement, and power to utilise obstacles. Also a defender becomes stronger as he retires, whilst his assailant grows weaker as he advances, and must leave troops behind him or bring fresh forces into the theatre of war in order to guard his *base of operations*, where his supplies collect, and the *lines of communication* by which they reach him.

The assailant will endeavour to reach his *objective point*—i.e. some place, generally the capital city, the capture of which will end the campaign or enable him to make a further advance. His troops must be so disposed as to be able to concentrate on important points in numbers superior to the enemy. The latter, on the other hand, will endeavour to do the same, and also to operate against his adversary's communications without exposing his own. As he probably can shift his base and lines of communication more easily than the invader, some advantage will here accrue to him. Also, his troops being generally more concentrated, he can probably act on *interior lines*—e.g. if of four equidistant armies three were on the circumference of a semicircle and the fourth at the centre, it is evident that the latter might defeat any one of the former before it could be reinforced by either of the others.

Perhaps the most brilliant example of this was shown by Napoleon I. in the first part of the campaign of 1814. Towards the end of January of that year he with 70,000 young conscripts was at Châlons; to the south 160,000 Austrians and Russians under Schwarzenberg were advancing from Basel along the valley of the Seine, and to the north 60,000 Prussians under Blücher along the Marne from Mannheim, the objective of both being Paris. Napoleon after the indecisive battle of Brienne was defeated by Schwarzenberg at La Rothière. The latter moved slowly, and Blücher, thinking to gain Paris first, moved his corps by several roads. Napoleon leaving 20,000 men under Oudinot and Victor to hold the passages over the rivers, and to delay Schwarzenberg still further, carried the remainder rapidly against the scattered Prussians, defeating them in detail at Champaubert, Montmirail, and Château-Thierry, obliging Blücher to retire to Châlons. He then turned upon Schwarzenberg, beat him, and had driven him back to Troyes by the end of February. The allies were so dispirited that they asked for an armistice. See Lieut. J. Bigelow, U.S. cavalry, *The Principles of Strategy* (1891), with other works cited at TACTICS.

Stratford, a thriving town of Essex, on the Lea, 4 miles ENE. of London. It had a Cistercian abbey (1134) and the Empress Matilda's three-arched, bow-shaped bridge (removed in 1839); now it has a handsome town-hall (1869), and is the seat of various and extensive manufactures. Pop. (1851) 10,586; (1871) 23,286; (1881) 38,606; (1891) 42,982. On the opposite side of the Lea is the parish of Bow, or Stratford-le-Bow. Pop. (1851) 4026; (1871) 26,055; (1891) 40,378.

Stratford, a port of entry and capital of Perth county, Ontario, on the Avon, 88 miles by rail W. of Toronto, with railway-shops, woollen-mills, and manufactories of machinery, farming implements, boots and shoes, &c. Pop. (1891) 9501.

Stratford de Redcliffe, SIR STRATFORD CANNING, K.G., G.C.B., first Viscount, the famous ambassador, known as 'the Great Elchi,' was descended from the Cannynghes of Bristol, but was born in London, 4th November 1786, the fifth and youngest child of Stratford Canning, a merchant, and was first cousin to George Canning the statesman. He was educated at Eton, and proceeded in due course as scholar to King's College, Cambridge, where, however, his terms were interrupted by diplomatic appointments, and he did not take his degree till 1812, when it was granted by royal mandamus. In 1807 he acted as *précis*-writer to his cousin at the Foreign Office, and in the same year went as second secretary with Merry's mission to Copenhagen. In 1808 he was appointed first secretary to Sir Robert Adair's embassy to Constantinople, and succeeded him as minister-pleni-potentiary in 1810. His duty was to counteract the influence of France at the Porte, and he succeeded on his own initiative and without the smallest countenance from his government or the Foreign Office in negotiating the important treaty of Bucharest in 1812 between Russia and Turkey, who were then at war, just in time to release the Russian army of the Danube and enable it to fall upon Napoleon on his retreat from Moscow. This signal service was recognised by Lord Castlereagh's government, who appointed him minister in Switzerland, 1814; there he assisted in framing the Swiss constitution, and visited Vienna as commissioner during the famous Congress of 1815. He resigned the mission in 1819, and was immediately appointed minister to the United States, and remained at Washington till 1823. In the following year he was sent on a special mission to Vienna and St Petersburg, connected with the Greek question, and in 1825 went to Constantinople as full ambassador. Here he witnessed the massacre of the Janizaries, and exerted himself on behalf of the insurgent Greeks. After the battle of Navarino the embassy was necessarily withdrawn, and, in consequence of serious differences with Lord Aberdeen on the policy to be adopted towards Greece, Canning resigned his post in 1828, but his services were recognised by the decoration of the Grand Cross of the Bath. In 1831 he was again sent to Constantinople on a special mission, to draw the boundaries of the new kingdom of Greece, and on his return was gazetted ambassador to St Petersburg; but the czar, without alleging a reason, declined to receive him—probably because he dreaded so keen an eye at close quarters. In 1833 Sir Stratford went to Madrid on a special mission relating to the Portuguese succession, but his efforts were, as it was foreseen they must be, fruitless. During the intervals in his diplomatic career he sat in the House of Commons as a moderate Tory, or 'Stanleyite,' for Old Sarum, 1828-30; Stockbridge, 1831-32; and King's Lynn, 1834-42; but failed to make his mark as an orator or a debater. From 1842 to 1858 he was again ambassador at Constantinople, and built up that extraordinary influence so eloquently described by Kinglake, which gained him the name of the 'Great Elchi.' He induced the sultan to inaugurate a series of reforms, and to authorise numerous improvements in the condition of the Christian rayas, culminating in the celebrated Hatti-Humayun of 1856, which may be termed the Magna Charta of the Christian subjects of the Porte. His diplomatic skill and his unbounded influence over the Turks were never seen to greater advantage than

in 1853, in his negotiations with Prince Menschikoff, the Russian special ambassador, concerning the dispute about the Holy Places and the Russian claim for predominating influence on behalf of the Christians of Turkey. His strenuous and unflinching exertions to preserve peace were, however, defeated by the obstinacy of the Czar Nicholas and the vacillating weakness of Lord Aberdeen's government; the war which ensued between Russia and Turkey involved England and France; and the result was the expedition to the Crimea, and the siege of Sebastopol. At the close of the war, after obtaining the proclamation of the Charter of Reform, Lord Stratford, who had been created a viscount in 1852, resigned his embassy in 1858, at the age of seventy-one, and a diplomatic career of unexampled distinction, lasting over half a century, came to an end. Stratford de Redcliffe was the last of the old style of semi-royal and half-independent ambassadors: the telegraph-wire has made ministers of his mettle and character impossible if not superfluous. After his retirement he occasionally took part in the debates on foreign policy in the House of Lords, and devoted part of his leisure to the writing of poetry, which had been a favourite occupation with him since he wrote a fine poem on *Buonaparte*, which attracted the admiration of Byron, in 1814. Some articles on the *Eastern Question* were collected after his death and edited by Dean Stanley. He was created a Knight of the Garter in 1869 at Mr Gladstone's recommendation, and died in the full enjoyment of his mental powers though at the great age of almost ninety-four, 14th August 1880. His statue was erected in Westminster Abbey in 1884.

See *Life of Stratford Canning, Viscount Stratford de Redcliffe*, by the present writer (2 vols. 1888; 1 vol. 1890).

Stratford-on-Avon, Shakespeare's birthplace, is a pleasant town of Warwickshire, 8 miles SW. of Warwick, 22 SSE. of Birmingham, and 110 NW. of London. It stands on the right bank of the quiet Avon, which here is spanned by the 'great and sumptuous bridge' of fourteen pointed arches, 376 yards long, that was built by the Lord Mayor of London, Sir Hugh Clopton, who died in 1496. 'Shakespeare's House,' where the poet was born on 23d April 1564, in Henley Street, is national property, having been bought for £3000 in 1847, and restored in 1858-59; here are a Shakespeare museum, the 'Stratford portrait,' and the signatures of Byron, Scott, Tennyson, Thackeray, Dickens, &c. King Edward VI.'s grammar-school, where Shakespeare was educated, was founded by Thomas Jolyffe in the reign of Edward IV.; it occupies the upper story of the old guildhall, and was restored in 1892. The 'New Place,' built by Sir Hugh Clopton in the reign of Henry VII., was purchased by Shakespeare in 1597, and here he died on 23d April 1616; here, too, Queen Henrietta Maria stayed in 1643. It (or rather its successor, 1703) was wantonly razed in 1759 by a vicar of Stratford, who also felled the poet's mulberry, beneath which Garrick was regaled in 1742; but its site has also become national property since 1861. And lastly, uprearing its spire above the lime-trees, there is the beautiful cruciform church, Early English to Perpendicular in style, having been gradually rebuilt between 1332 and 1500 by Archbishop John de Stratford, Dr Thomas Balsall, and Ralph Collingwood. In the chancel, whose two years' restoration was completed in 1892, is Shakespeare's grave, with the portrait bust (1616) by Gerard Janssen or Johnson, Anne Hathaway's grave, and the American stained-glass window of the 'Seven Ages.'

The Shakespeare Fountain (1887) was also erected by an American, Mr George W. Childs

(q.v.); the red-brick Shakespeare Memorial Theatre, seating 800 spectators, was built in 1877-79 at a cost of £30,000. In the neighbourhood are Shuttery, with Anne Hathaway's cottage (purchased for the nation in 1892 for £3000); Luddington, where tradition says she was married; Charlecote, the seat of the Lucys; Clopton, with memories of the Gunpowder Plot; and Welcombe Hill, crowned by an obelisk (1876), 124 feet high, to a Manchester M.P. In Stratford itself still remain to be noticed the chapel of the Guild of the Holy Cross (13th century; the chancel rebuilt about 1450, and the rest by Sir Hugh Clopton); the half-timbered house of the Harvards (1596); the town-hall (1633; rebuilt 1768-1863), with Gainsborough's portrait of Garrick; and the corn exchange (1850); the market-house (1821); the College school (1872); a Roman Catholic church by Pugin (1866); and a hospital (1884). Before 691 a Saxon monastery stood at Stratford-on-Avon, which was incorporated in 1553. It is an important agricultural centre; still, its chief prosperity depends on the 30,000 or so pilgrims who visit it yearly. Pop. (1851) 3372; (1891) 8318, an increase largely due to the extension of the borough boundary in 1879.

See the 'Shakespeare's Birthplace, &c. Trust Act, 1891' (incorporating the Trustees and Guardians of Shakespeare's House, the New Place, &c.), Washington Irving's *Sketch Book* (1821), Hawthorne's *Our Old Home* (1863), Wheeler's *History and Antiquities of Stratford-on-Avon* (1806), nine works by J. O. Halliwell-Phillips (1863-85), S. L. Lee's *Stratford-on-Avon from the Earliest Times to Shakespeare* (1884), and other books cited at AVON and SHAKESPEARE.

Strathaven, a town of Lanarkshire, 1 mile W. of Avon Water, and 16 miles SSE. of Glasgow. On the north side is the picturesque ruin of Avondale Castle, and 5 to 7 miles south-west are the battlefields of Drumlog and Loudoun Hill. Pop. (1851) 4274; (1891) 3478. See Gebbie's *Sketches of Avondale* (1880).

Strathclyde. In the 8th century the ancient confederacy of the Britons was broken up into the separate divisions of Wales and English and Scottish Cumbria. Scottish Cumbria, otherwise called Strathclyde, thenceforth formed a little kingdom, comprising the country between Clyde and Solway, governed by princes of its own, and having the fortress-town of Alclyde or Dumbarton for its capital. Becoming dependent on Scotland (see BRETT'S AND SCOTS), it was annexed to the Scottish crown at the death of Malcolm I., on failure of the line of native sovereigns. Edgar bequeathed Strathclyde to his youngest brother David, again separating it from the crown of Scotland, which went to his intermediate brother, Alexander I. David held it throughout Alexander's reign in spite of that king's opposition, and on Alexander's death without issue in 1124, it was permanently reunited to the Scottish kingdom under David I.

Strathfieldsaye, a Hampshire estate, with a Queen Anne mansion, overlooking the Loddon, 7 miles NNE. of Basingstoke. Associated ere that with the name of Pitt, it was purchased by parliament in 1817 of Lord Rivers for £263,000, and presented to the Duke of Wellington. A conspicuous monument, crowned by a bronze statue of the Duke by Marochetti, was erected in 1866; and his charger, 'Copenhagen,' is buried in the grounds. See SILCHESTER, and the Rev. Charles H. Griffith's *History of Strathfieldsaye* (1892).

Strathmore (Gael. 'Great Valley'), the most extensive plain in Scotland, is a low-lying tract extending north-eastward across the country from Dumbartonshire to Stonehaven in Kincardineshire, and bounded on the north by the great mountain-rampart of the Highlands, and on the south by the Lennox, Ochil, and Sidlaw Hills. It is 100 miles

long and from 5 to 10 miles broad; but Strathmore proper extends only from Perth to near Brechin (about 40 miles).

Strathnairn, LORD, commander-in-chief in India. Hugh Rose, son of Sir George Rose, was born 1803, and entered the army in 1820. He was military attaché to the Turkish army in the war with Mehemet Ali in 1840, was consul-general for Syria, and as secretary to Lord Stratford de Redcliffe was *chargé d'affaires* at Constantinople in 1853-54. He was commissioner at the French headquarters during the Crimean war, and, now K.C.B., was sent to India in 1857 to command the Central Indian army. In command of this force he virtually reconquered Central India; and, though his campaign was overshadowed by those of Sir Colin Campbell, it is generally admitted that the operations of Sir Hugh Rose were more brilliant and skillful than those of his chief. On the death of Lord Clyde Sir Hugh Rose became commander-in-chief in India; in 1865-70 he held the same post in Ireland. Raised to the peerage in 1866, and made field-marshal in 1877, he died 16th October 1885. See Sir O. T. Burne, *Clyde and Strathnairn* (1891).

Strathpeffer, a fashionable Scottish watering-place in the county of Ross and Cromarty, to the south of Ben Wyvis (3429 feet), and 5 miles W. of Dingwall by rail, 215 NNW. of Edinburgh. Its sulphur and chalybeate springs are highly efficacious in digestive and rheumatic disorders; and it has a pump-room with baths and three large hotels. See Dr Fortescue Fox's *Strathpeffer Spa* (1889).

Strathspey, a Scotch dance, allied to and danced alternately with the Reel (q.v.). The name is derived from the strath or valley of the Spey, where it seems to have originated; but it does not occur before the middle of the 18th century, and was at first applied indiscriminately to music now known as reels. It differs from the latter in being slower, and abounding in the jerky motion of dotted notes and semiquavers (when the latter precede the former it constitutes the *Scotch Snap*), while the reel is almost entirely in smooth, equal, gliding motion. Many of Burns's songs were written to the music of strathspeys.

Stratiotes. See WATER-SOLDIER.

Stratum (Lat., 'spread out'), equivalent in Geology to the term *bed* or *layer*, but implying that the beds or layers of rock have been spread out over the surface. Rocks so arranged are said to be stratified. The stratified rocks include all those that are of derivative origin, such as conglomerate, sandstone, shale, &c. Many igneous rocks, however, are also arranged in layers or beds, as in the case of the basalt plateaus of Antrim, the Inner Hebrides, the Faroe Islands, Iceland, &c. In these regions we encounter a great succession of sheets of basalt with interbedded layers of fragmental materials (tuff, &c.). Such consecutive series of igneous rocks are truly stratified. But when a geologist speaks of 'the stratified rocks' he is understood to refer more particularly to the derivative or aqueous rocks, the most important characteristic of which is their bedded or stratified arrangement. In a series of stratified rocks each individual layer of sandstone, shale, limestone, &c. is a stratum, which may or may not be homogeneous in structure. For while some beds consist of a series of thinner layers or laminae, others show no such subordinate divisions. Thus, the particular variety of sandstone which is called *freestone* is not laminated, but of homogeneous structure, while a stratum of shale is composed of numerous thin laminae. Such laminae have a more or less close cohesion, which is sometimes so great that it is almost as easy to break the rock against as with the grain.

Individual strata are more readily separated from overlying and underlying beds. The degree of cohesion between laminae probably depends upon the rate at which sedimentation took place. If deposition was comparatively rapid the successive laminae would tend to cohere more readily than would be the case where each individual layer had had time to become more or less solidified before the deposition of the succeeding laminae. But in very many cases the cohesion of laminae has been effected by subsequent pressure, and sometimes by infiltration of cementing material. The planes of stratification are always more strongly pronounced than those of lamination, and generally point to some lapse of time (longer or shorter as the case may be)—to a pause in the deposition of sedimentary matter. For further remarks, see GEOLOGY.

Straubing, an old town of Lower Bavaria, on the right bank of the Danube, 25 miles by rail SE. of Ratisbon, makes large quantities of bricks, lime, cement, and leather. Fraunhofer was a native. In a little chapel here there is a monument to Agnes Bernauer (q.v.). Pop. (1890) 13,865.

Strauss, DAVID FRIEDRICH, author of the famous *Leben Jesu*, was born on the 27th January 1808, at Ludwigsburg in Würtemberg. His education was begun in his native town, and completed in the theological seminaries of Blanbœuren and Tübingen. In 1830, his head filled with Hegel's philosophy and Schleiermacher's theology, he entered on the simple life of a country pastor; but already in the following year he was in Maulbronn acting as professor in the seminary, and went thence to Berlin for six months to continue his Hegelian studies, and hear the lectures of Schleiermacher. Returning to Tübingen in 1832, he became *repentent* in the theological seminary, and in the next years held also philosophical lectures in the university as a disciple of Hegel. Known as yet only to a narrow circle, he became all at once a man of mark by the publication, in 1835, of his *Life of Jesus critically treated* (2 vols. Tüb.; 4th ed. 1840; Eng. trans. by George Eliot, 1846). In this work he applied to the New Testament the method which had already worked havoc with the old legends of Greece and Rome, and which De Wette had to some extent applied to the Old Testament. Strauss attempted to prove the received gospel history to be a collection of myths gradually formed in the early Christian communities, and sought by an analytical dissection of each separate narrative to detect, where it existed, a nucleus of historical truth free from every trace of supernaturalism. The facts of the gospels were mere myths like those of the early Roman historians; no miracle, prophecy, or incarnation was left; the Christ of faith was a mere idea or group of ideas (see MIRACLE). The book made a real epoch in theological literature, and produced a violent excitement in and out of Germany, calling forth numberless replies from opponents, frightening many by its bold disregard of consequences back into the ranks of orthodoxy, and stirring up others to similar investigations. The first consequence to the author was his dismissal from his academical position in Tübingen, and transference to the Lyceum of Ludwigsburg. He resigned the new post, however, very soon in 1836, and retired into private life at Stuttgart, to leave leisure to defend himself. In 1837 he published his *Streitschriften* against his opponents; and in 1838 *Zwei friedliche Blätter*, a more conciliatory exposition of his views. Early in 1839 he was called by the Board of Education in Zurich to be professor of Dogmatics and Church History in the university; but the step raised such a storm of opposition amongst the public that the proposition had to be dropped (he receiving a

pension of 1000 francs), and even the cantonal government had to resign in the same year.

Thrown back on literary labour, Strauss, who had published during the year his *Charakteristiken und Kritiken*, sent forth shortly afterwards his second great work, *Die Christliche Glaubenslehre*, a review of Christian dogma 'in its historical development and its struggle with modern science' (1840-41). This formed a natural sequel to the purely critical investigation of the origins of Christianity in the first work. When Strauss, after a long period of silence, next appeared on the literary field it was no longer as a professed theologian. In 1847 he drew attention by a work entitled *Der Romantiker auf dem Throne der Cäsaren*, in which a parallel was drawn between the orthodox William IV. of Prussia and Julian the Apostate, as having both attempted to restore dead religions. His fellow-townsmen put him forward as a candidate for the German revolutionary parliament of 1848, but he was unable to stand against the clerical influence brought to bear upon the country-people of the district. His speeches on this occasion were published under the title of *Six Theologico-political Popular Addresses*, and his native place compensated the defeat by sending him as its representative to the Württemberg Diet. From this position, however, when he unexpectedly displayed conservative leanings, and incurred a vote of censure from his constituents, he retired before the end of the year. In this period he also issued lives of the Swabian poet Schubart (1849) and of his college-friend Christian Märklin (1851); and a work on the old Swabian humanist Frischlin (1855). His third period of activity was opened in 1858 by a remarkable life of Ulrich von Hutten (Eng. trans. 1874), followed up by the publication of Hutten's *Dialogues* in 1860, a work on Reimarus (1862), and a series of brilliant lectures on Voltaire (1870). A new *Life of Jesus*, composed for the *German People*, appeared in 1864 (Eng. trans. 1865), in which the mythical theory was retained, but prefaced by a critical examination of the gospels (some historical value being allowed to Matthew), and an attempt made to reconstruct a positive life of Christ. *Der Christus des Glaubens* (1865) is a criticism of the lectures of Schleiermacher on the life of Jesus, and *Die Halben und die Ganzen* a brochure directed against Schenkel and Hengstenberg. In 1872 he published his last work, *Der alte und der neue Glaube*, in which he endeavours to prove that Christianity as a system of religious belief is practically dead, that there is no conscious or personal God, and that a new faith must be built up out of art and the scientific knowledge of nature. Strauss died at Ludwigsburg, 8th February 1874. In 1841 he had married the opera-singer, Agnese Schebest (1813-70), but some years after they separated. The literary, critical, and polemical powers of Strauss were unquestionably of a very high order; no more effective German prose than his has been written since Lessing.

A collected edition of Strauss's works was published in 12 vols. (including one of poems), edited by Zeller, in 1876-78. The *Life* by Zeller (1874) was translated the same year: and there are works by Hausrath (2 vols. 1876-78) and Schlottmann (1878).

Strauss, JOHANN, musical composer, best known for his waltz-music, was born in Vienna on 25th October 1825, the son of a Johann Strauss (1804-49) who also was renowned as a composer of dance-music. On his father's death he took the direction of his orchestra, and for many years travelled with it, at the same time producing melodious and catching waltzes (*Die schöne blaue Donau, Künstlerleben*, &c.), as also composed some very popular operettas—*Die Fledermaus* (1874), *La Traviata* (1877), *Der Zigeunerbaron* (1885), &c.

Straw, MANUFACTURES OF. Apart from the importance of the straw of various cereal plants as a feeding and bedding material in agriculture, such substances also possess no inconsiderable value for packing merchandise, for thatching, for making mattresses, and for door-mats. Straw is also a paper-making material of some importance, and split, flattened, and coloured it is employed for making a mosaic-like veneer on fancy boxes. But it is in the form of plaits that straw finds its most outstanding industrial application, these being used to an enormous extent for making hats and bonnets and for small baskets, &c. Wheat straw is the principal material used in the plait trade, the present great centres of which are Bedfordshire in England, Tuscany in Italy, and Canton in China. At first the plait was what is called *whole straw*; that is, the straw was cut into suitable lengths without knots, and merely pressed flat during the operation of plaiting; and so it continued until the reign of George I., when it was in great demand for ladies' hats, and some plait was made of split straw. Since that time split straw has been chiefly used.

The instrument employed for splitting (fig. 1) consists of a number of little square steel blades radiating from a stem which terminates in the point *a*, and at the other end is bent and fixed into the handle *b*. The point *a*, being inserted into the hollow of the straw, is pressed forward, and cuts it into as many strips as there are blades in the cutting-tool. The English straw used in plaiting is obtained principally from the varieties of wheat known as the White Chittim and the Red Lammas, which succeed best on the light rich soils of Bedfordshire and the neighbouring counties. Only bright, clear, and perfect pipes can be employed, and to obtain the straw in good condition great care has to be exercised. The crop is not mowed, but pulled up, and the ears are cut off by the hand for thrashing. The straws are then cut into lengths, cleared of their outer sheath, and assorted into sizes in a kind of sieve apparatus like fig. 2. The apertures

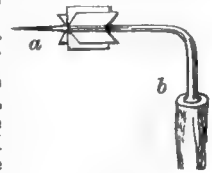

Fig. 1.

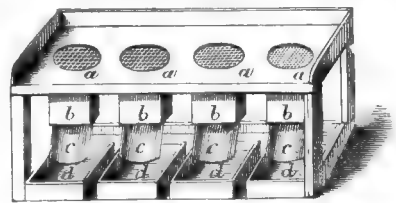

Fig. 2.

in each successive perforated top are increasingly wider, so that fine straws only pass through *a* by the shoot *b*, *c*, into the box *d* at the one end, and thicker pipes in each succeeding box. The plaits, made principally by women and children, vary greatly in pattern, quality, and cost. They are sold by the *score* of 20 yards, chiefly in Luton, where spacious plait halls have been provided for the accommodation of buyers and sellers. The finest and most costly plaits anywhere made—the Tuscan or Leghorn plaits—are made in Tuscan villages around Florence, and are not split. The straw there used—very fine in the pipe and bright in colour—is produced from a variety of wheat thickly sown and grown in a light thin soil. The crop is pulled and prepared as in the English trade, and the plaits are worked by all classes and ages of the rural populace. The finer qualities of

Tuscan plaits are worked with exceeding delicacy and elaboration, the task so straining the eyesight of the plaiters that they can give not more than two hours daily to the work.

Within recent years an enormous amount of straw-plait, of a common but useful quality, has been sent into the European market from China, the port of shipment being Canton. It can be sold in British markets at a price which excludes the possibility of competition by English plaiters, and the consequence is that the Bedfordshire trade in lower-class plaits is practically extinct. At the same time the supply of cheap Canton plaits has greatly benefited the hat and bonnet sewing industry of Luton and other Bedfordshire towns. In the year 1890 there were imported into the United Kingdom 8,558,542 lb. of straw-plaits, valued at £659,892, of which 7,306,100 lb., of a value of £476,210, came from Canton. Of this amount there was re-exported, principally to France, Germany, and the United States, 4,900,924 lb., valued at £328,177. Of hats and bonnets made from straw-plaits there were exported in the same year 653,104 dozen, valued at £371,262, the principal buyers being the Australian colonies.

Strawboard is a kind of Millboard (q.v.), or thick cardboard, made of straw after it has been boiled with lime or soda to soften it. The cheap kinds of strawboards are used for making common boxes of various kinds, and for protecting articles sent by post or railway. Good qualities of board suitable for binding books and other purposes are made of straw mixed with flax and jute waste from spinning-mills.

Strawberry. The Strawberry (Lat. *fragum*, whence the name of the genus *Fragaria*) belongs to the order Rosaceæ. Probably our name is descriptive of the habit of the fruiting plant, when the berries are strewn or strawn upon the ground—*humi nascentia fraga*—by their weight on the flexible footstalk. It is hard to believe, on the best authority, that the plant waited for its name till straw was laid beneath it. The calyx is ten-cleft, the petals five, and the seeds are imbedded in a fleshy receptacle, which is the delicious and fragrant fruit. The plant is a dwarf perennial, of stocky habit, and with handsome foliage, each leaf consisting of three leaflets, boldly toothed, and deeply ribbed; the stalk is generally long, and more or less hirsute, according to variety. The principal species are *F. vesca*, including the alpine and wood varieties; *F. elatior*, the hautbois; *F. viridis*, a rather scarce European plant; *F. virginiana*, a scarlet fruit; *F. grandiflora*, the pine strawberry; and *F. chilensis*, the Chilean. The hautbois, which is now believed to be a cultivated form of *F. vesca*, was probably our earliest garden strawberry, and the name is still used by the London street-vendors—'fine hoboy, ripe hoboy!'—for strawberries of all descriptions. The true hautbois is cultivated still for its rich and musky flavour, but larger and more fruitful kinds have generally superseded it. The magnificent fruit we now possess is chiefly the result of judicious crossings betwixt and among *virginiana*, *grandiflora*, and *chilensis*. The first great improvement appears to have been the introduction of the scarlet kind from Virginia in the beginning of the 17th century; and the old scarlet, though too acid for dessert, is still the very best for preserving. *F. grandiflora*, the old pine, has larger fruit of higher flavour, and darker and more substantial leaves. It is believed to have come from Carolina, and under that name was regarded for some years as the best and finest of strawberries. Even now there is none to surpass it in flavour, or equal it perhaps in texture; but larger and more productive

kinds have ousted it from popularity. The garden strawberries of the present time have been obtained by repeated crossings; and it is impossible now to give their pedigree; but many of them show by hispid stalk and foliage a trace of Chilean lineage, for the Chilean is a very hairy plant and of vigorous growth, but tender. Our *British Queen*, perhaps the best known of all strawberries, is clearly of Chilean descent, and so are *Dr Hogg*, *Sir Charles Napier*, and others of fine character. Many favourite fruits show larger proportions of the *grandiflora* strain, such as *Keens' Seedling*, *Sir Joseph Paxton*, *Sir Harry*, and other dark varieties. Every year adds to our choice of sorts and helps to extend the season; and very early kinds are much in vogue, such as *Laxton's Noble* and *Captain*, which like all precocious fruit are of little other virtue. Besides the above, the following kinds are largely grown around London—*Vicomtesse Héricart* (or *Garibaldi*), *President*, *James Veitch*, *La Grosse Sucrée*, *Princess of Wales*, *Lucas*, *Elton Pine*, *Eleanor*, &c. Also from France, in the 'berry-season,' come tons and tons of coarser fruit which even uncruised would be unknown to any good pomologist.

Planting strawberries for ourselves, we may rely upon a fine sweet crop if we show a little sense and take due care. First of all seek out the proper kinds for soil and climate, dividing (as may be fairly done, at least for practical purposes) all strawberries into three classes—(1) those of Chilean interbreed, which must have heavy soil even if poor, and weather not too barbarous, such as *British Queen* and congeners; (2) those of more glabrous and substantial leaf, being closely allied to the pine race, which care more for the quality than the substance of the soil, such as *Keens' Seedling*, &c.; (3) those of a strain so mixed that they must be studied individually, and sometimes flourish most upon a mixture. But however widely strawberries vary, almost all rejoice in having the earth well hardened around them, and the grower will marvel after all his labours to find the most vigorous and buxom of his plants established in the gravel-walk outside his higher culture. The strawberry is propagated in three manners—by seed, by side-shoots from the stool, and by runners. The last is the general course; and the runners or filiform stems (which issue generally at or soon after the fruiting season) should be pegged or fixed till the young plant is rooted. As early in the autumn as the young plants are strong enough, they are set out in the new beds in rows from 2 to 3 feet asunder, according to the vigour of the sort, and at intervals in the row of 15 or 18 inches. If the soil is light it should be rolled or heavily trodden before the planting time, and every young plant should have the earth rammed round it. Whenever a scarcity of runners or the weather has forbidden early planting it is better to wait till the spring than attempt to overtake the lateness lamely; and many kinds do best after wintering with their parents. The duration of a strawberry-bed depends very much upon the variety. Some of the small and early kinds are worn out by the second year of fruiting; while others of more robust habit do well for five or six years, or even more, if frequently cleared and kept in order and good heart. But none of these things has a hard and fast law. The forcing of strawberries is a special subject upon which we cannot enter. Brief as its season is of appearance in the market—from the first week of June to the last of July may be taken as the period of outdoor fruit in the neighbourhood of London—the strawberry has long won the affection of the people (at least for immediate despatch) more entirely than any or all other fruit whatsoever. At the height of the

'berry-time' it is amazing to see the fruit pouring into Covent Garden, from ship and from train, and by the English grower's van from all the nearer counties. The imported fruit is coarse, insipid, and generally in bad condition, but it serves to keep the prices low.

For further instructions, see works cited in our article upon *Gardening*; also Professor Decaisne's *Jardin Fruitier du Musée*; the *Illustrated Dictionary of Gardening*, by George Nicholson; and the *Strawberry and how to grow it*, by E. W. Harrison. For 'strawberry leaves,' see CORONET.

Strawberry Hill. See TWICKENHAM.

Streatham, a suburban parish in Surrey, 6½ miles SSW. of St Paul's. The Thrales's house, visited by Dr Johnson, is gone; but the church, though rebuilt in 1831, retains some interesting monuments. Pop. (1881) 25,553; (1891) 48,742. See F. Arnold's *History of Streatham* (1886).

Streator, a mining-town of Illinois, on the Vermilion River, and on five railways, 94 miles SW. of Chicago. Pop. (1880) 5157; (1890) 11,414.

Street, GEORGE EDMUND, architect, born at Woodford in Essex, 20th June 1824, was educated at Camberwell and Crediton, and studied for five years with Gilbert Scott. Starting in practice for himself in 1849, he designed many churches throughout the country, and restored more—the chief restoration being Christ Church Cathedral in Dublin. Cuddesden College and Uppingham School are by him; but his most famous work is the new Law Courts in London, the subject of so much controversy (see Vol. VI. p. 703). Street became an A.R.A. in 1866, an R.A. in 1871, and P.R.I.B.A. in 1881. He died in London, 18th December 1881, and was buried in Westminster Abbey. He published *The Architecture of North Italy in the Middle Ages* (1855) and *Gothic Architecture in Spain* (1865). See Memoir by his son (1888).

Streltzi, or STRYELTSY. See RUSSIA, p. 46.

Strength of Materials is the heading under which it is usual to discuss the elastic or resisting properties of the materials used in engineering or building operations (see ELASTICITY, also STRAIN AND STRESS). When a structure is being designed the engineer must know first of all the amount and character of the stresses (loads, wind-pressures, &c.) that will act upon the structure. He must then decide as to the size and shape of the pieces that are to compose the structure, so that they may easily stand these stresses. For this purpose he must know beforehand what 'strength of material' is possessed by the steel, iron, or wood that is to be used.

When any substance is strained beyond a certain limit it will break, and the greatest stress which the substance can bear without being torn asunder is called its ultimate strength. The value of this for any given piece of material will depend upon the kind of strain to which it is being subjected. But whatever this strain be, whether extension, compression, flexure, or twisting, there are two, or at most three, distinct kinds of ultimate strength which practically fall to be considered. The one is the ultimate tension or pressure applied in one direction, usually longitudinally; and the other is the ultimate shearing stress, such as comes into play in simple torsion. In certain cases, such as in steel, wrought-iron, and ductile metals generally, the strength under tension and that under longitudinal pressure—in other words, the tenacity and the resistance to crushing—are practically the same. In other cases, however, of which cast-iron is the most interesting instance, the resistance to crushing is much greater than the tenacity. The ultimate strength under shearing is generally less than that under tension or compression. For

example, the ultimate tensile strength of steel varies from 30 to 45 tons' weight per square inch of section, while the ultimate shearing strength varies from 22 to 35. Cast-iron, again, which has a tensile strength of 7½ tons' weight per square inch, has a strength under crushing of 45 and a shearing strength of 12.

It is out of the question to make a structure in which the pieces are strained up to their ultimate limits. For, even though the limit is not exceeded and the material not torn asunder, the excessive straining to near the limit will produce a permanent deterioration in strength. In other words, the 'working strength' is much smaller than the ultimate strength, being obtained from it by dividing by a number known as the 'factor of safety.' In the case of steel this factor is about 6; so that in no structure should a hard steel rod be subjected to a greater tension than 7½ tons' weight per square inch. Experience is the sole guide as to the value of this factor, which must be taken large enough to provide a margin of strength for all possible contingencies. Now, in the first place, the ultimate strength of a material that is to be used in a bridge or roof is somewhat uncertain. It is obtained by testing a sample. But no two samples of the same material have ever quite the same strength. Again, although theoretically a long column should have the same tensile strength as a short one of the same material and section, practically it is not so. There is greater chance of there being weak places in the longer column, and at the weakest place the material will begin to yield. Thus a greater factor of safety must be used in estimating the working strength of the longer rod. Then, in the second place, the character of the stress to which the material is to be subjected must be considered. If it is to be a fluctuating and not a steady stress the factor of safety must be increased, and similarly a wider margin of strength must be provided if the material is to be subjected to sudden shocks or impacts. For example, a bridge which is strong enough to allow a train to rest on it or to crawl over it, may be unable to support the train dashing at full speed. In fact, under a stress which fluctuates between wide limits the ultimate strength is diminished; hence if the ultimate strength has been measured by testing a sample under a steady stress, and if the substance is to be subjected to a sudden shock, the factor of safety is doubled.

A very important part of the subject is the consideration of the form best suited to resist certain strains. A glance at any fine modern structure, such as the Forth Bridge, will show how the form is varied, according as the member is in compression or in extension. Here the question of flexibility enters in. For although the strengths under extension and compression may be the same, yet if a rod is taken too thin and subjected to a longitudinal pressure, it will bend long before the true compression limits are reached. This bending or buckling must be prevented, and the only way of doing so is to increase the section. Thus hollow tubes resist buckling better than rods of the same length and mass. Herein also lies the great virtue of the I-shaped rod, which if laid horizontally and supported by its ends bends under its own weight very slightly as compared with the bending of a solid cylindrical rod of the same length and mass.

See Todhunter and Pearson, *A History of the Elasticity and Strength of Materials* (1886-94); H. T. Bovey, *Theory of Structures and Strength of Materials* (New York and London, 1893); Barlow's *Strength of Materials* (6th ed. 1867); Fairbairn's *Mechanical Properties of Steel* (Brit. Assoc. Reports, 1867); Burr's *Elasticity and Resistance of the Materials of Engineering* (New York, 1883; new ed. 1889); and W. G. Kirkcaldy's *Strength and Properties of Materials* (New York, 1891).

Strepsiptera, peculiar insects referred by some to a special order, ranked by others among the Coleoptera. The females are blind and worm-like parasites, living inside various bees and wasps, but the adult males are free, with small twisted fore-wings and longitudinally-folded hind-wings. The larvæ, hatched within the adult bee or wasp, emerge and infest the grubs.

Streptococcus. See BACTERIA.

Stress. See STRAIN.

Stretton, HESBA, the pen-name of Sarah Smith, novelist and popular writer for the young, who was born at Wellington, Shropshire, where her father was a bookseller. Her first manuscript was accepted by Charles Dickens, and published in *Household Words*, to which she continued to contribute, as also to *All the Year Round*, until the death of its founder, whom she had found the most generous and sympathetic of editors. *Jessica's First Prayer*, published by the London Tract Society in 1867, and followed by a long series of semi-religious stories, interesting and pathetic, made her name a household word. She has published over forty juvenile stories and novels.

Strickland, AGNES, historian, was born at Reydon Hall near Southwold, Suffolk, August 19, 1806. She had begun verse-making ere her twelfth year, and had issued several volumes of poetry when the idea occurred to her of writing historical biographies of the queens of England. The suggestion came from some interesting biographies of female sovereigns written for a periodical by her sister Elizabeth (1794-1875). A start was made, and the first two volumes were published by Colburn and had a rapid sale; a misunderstanding between author and publisher was healed by Colburn's offer of £150 per volume until the work was completed (12 vols. 1840-48; new ed. 6 vols. 1864-65; abridged ed. 1867). In the production of this work she was assisted by her sister Elizabeth, though only the name of Agnes appears on the title-page. The work was dedicated to Queen Victoria, and as each volume appeared its picturesque style and anecdotal character made it a general favourite, though the *Quarterly Review* complained of a poverty of style and an equally pervading feebleness of thought, while the *Times* said it possessed 'the fascination of a romance united to the integrity of a history.' Miss Strickland, whose volumes give vivid pictures of the court and domestic life of the various periods, had strong opinions as to ecclesiastical government and royal prerogative, and was a partisan of the Stuarts. A civil list pension was conferred upon her in 1870. She died 8th July 1874. Agnes Strickland also wrote several novels and juvenile tales. Other works, written jointly with her sister Elizabeth, were *Lives of the Queens of Scotland* (1850-59), *Lives of the Seven Bishops* (1866), *Lives of the Tudor Princesses* (1868). The remaining works from the pen of Agnes were *Victoria from Birth to Bridal* (1840); *Letters of Mary Queen of Scots*, in whose innocence she believed (1842-43; new ed. 1864); *Bachelor Kings of England* (1861); *Lives of the Last Four Stuart Princesses* (1872). Her *Life of Mary Queen of Scots* (2 vols. 1873) was a redaction from the volumes in the *Queens of Scotland*. See Life, by her sister Jane (1887).

Stricture is a term employed in Surgery to denote an unnatural contraction, either congenital or acquired, of a mucous canal, such as the urethra, œsophagus, or intestine. When, however, the affected part is not mentioned, and a person is stated to suffer from stricture, it is always the urethral canal that is referred to. Contraction of this canal may be either permanent or transitory; the former is due to a thickening of the walls of

the urethra in consequence of organic deposit, and is hence termed organic stricture; while the latter may be due either to local inflammation or congestion, or to abnormal muscular action: the first of these varieties may be termed inflammatory or congestive stricture, and the second spasmodic stricture. The last-named form seldom exists except as a complication of the other kinds of stricture. There are two principal causes of organic stricture—the first being inflammation of the canal, and the second injury by violence. Inflammation is by far the most common cause, and gonorrhœa is the common agent by which it is excited. Not unfrequently stimulating injections thrown into the urethra with the view of checking the gonorrhœal discharge excite an inflammatory action which gives rise to stricture. Fortunately it is only in exceptional cases that a stricture results from inflammation of the urethra, the inflammation, in the great majority of cases, terminating by resolution, and leaving the canal as healthy as before the attack. It is when the complaint assumes a chronic character that it most commonly lays the foundation of stricture. Stricture from the second cause arises from such causes as falling across spurs, scaffolding, ladders, &c., or from some sharp object which punctures the perinæum—e.g. earthenware vessels which break under the sitter.

The earlier symptoms of stricture are a slight urethral discharge and pain in the canal behind the seat of the stricture at the time of micturition. The stream of urine does not pass in its ordinary form, but is flattened or twisted; and as the disease advances it becomes smaller, and ultimately the fluid may only be discharged in drops. The straining efforts to discharge the urine often induce Tenesmus (q.v.).

As the case advances the urine becomes alkaline and ropy, and deposits a precipitate when allowed to stand; and attacks of complete retention of urine occur with increasing frequency. But these symptoms are not in themselves sufficient to establish the presence of stricture. It is necessary to examine the urethral canal with a Catheter (q.v.) or Bougie (q.v.) to ascertain whether an organic obstruction exists, whether one or more strictures are present (as many as eight have been recorded, although four are rare, and one is the most common number), and their calibre. The treatment of organic stricture is too purely surgical to be discussed in these pages. It is sufficient to state that its object is twofold—viz. first, to restore the natural calibre of the canal so far as this can be safely effected; and secondly, to maintain this patency after it has been established.

Spasmodic stricture usually occurs as a complication of organic stricture or of inflammation of the mucous membrane, but may arise from an acrid condition of the urine, from the administration of cantharides, turpentine, &c., and from the voluntary retention of urine for too long a time. The treatment consists in the removal of the causes as far as possible and the hot bath. The inhalation of chloroform sometimes gives immediate relief; and several cases are recorded in which when the spasm occurred periodically it was cured by quinine. Inflammatory or congestive stricture commonly arises when a recent purulent discharge from the urethra has been checked by external cold or wet. The patient complains of heat, fullness, and soreness in the perinæum; the passage of the urine is extremely painful, the stream being small and ceasing before the bladder empties. The treatment is much the same as that for retention of Urine (q.v.).

Strigau, a town of Prussian Silesia, 25 miles SE. of Liegnitz, with granite-quarries, and manufacture of brushes, whips, sugar, &c. Pop. 11,784.

Strike, a term borrowed by geologists from the German *streichen*, 'to extend,' and adopted with the technical meaning it has in that language. It is applied to the direction of the outcrop of a *stratum*—the line which it makes when it appears at the surface of the earth. This line is always at right angles to the dip of the bed. The angle of dip and the direction of strike are determined by a clinometer and compass. A perfectly horizontal *stratum* can have neither dip nor strike.

Strikes. See COMBINATION, TRADE-UNIONS.

Strindberg, AUGUST, the most prominent figure in modern Swedish literature, was born at Stockholm on 22d January 1849, and became successively 'schoolmaster, actor, physician, telegraph employé, civil servant, painter, preacher, private tutor, and librarian of the state,' all to get his experience at first hand. The first book of his that made its mark was *The Red Room* (1879), a bitter satire upon conventional (Swedish) society. This made its author enemies, and to their attacks he replied in another stinging satire, *The New Kingdom* (1882); but after its publication he had to go into voluntary banishment, and has ever since lived abroad. Two years later he published a collection of short stories (*Married Life*), in which he describes all sorts and conditions of nuptial alliances with cynical frankness. Accused of outraging Christianity in this book, Strindberg repaired to Stockholm, stood his trial, and after making an eloquent defence was acquitted. His next important work was a plea for the socialistic conception of society in *Utopias in the Real World* (1885). Two books descriptive of the life and manners of the inhabitants of the Stockholm skerries—*The People of Hemsö* (1887) and *Life of the Skerry-Men* (1888)—are probably the best things he has written; though the play *The Father* (1887), one of four dramatic works in which he attacks the female sex, also deserves to rank high in Swedish literature. Two other novels, *Tschandala* (1889) and *On the Open Sea* (1890), turn upon the superiority of the aristocrat of brain over every other class of human being. Besides the books mentioned, Strindberg has produced—for he is a most prolific worker—a host of others, and in nearly all departments of literature. Unfortunately his artistic and poetic tendencies are in almost permanent conflict with his tendencies as thinker, reformer, and scientific observer; and this inherent dualism of his nature prevents his otherwise clever books from attaining the harmony, repose, and unity so essential to good literature. See Ola Hansson, *Das junge Skandinavien* (Dresden, 1891).

Stringhalt is a peculiar catching up of the horse's limbs, usually of one or both hind-limbs. It is most noticeable when the animal is first brought out of the stable, when he is excited, or made to turn suddenly round; it is a variety of chorea or St Vitus's dance. Although it does not interfere with usefulness, it is a serious eyesore, and quite incurable, and considerably depreciates the value of the horse.

Stromboli, one of the Lipari Islands (q.v.), with a volcano almost constantly active.

Strombus, a genus of marine Gasteropods, typical of the family Strombidae. Their shells, often called conch-shells, are well known, being often used as decorative objects and in the manufacture of cameos (see Vol. II. p. 675). Large numbers are exported from the West Indies and other tropical regions, and it is recorded that 300,000 fountain-shells (*Strombus gigas*) were brought to Liverpool in 1850. This species is the largest Gasteropod, the shell sometimes weighing 4 or 5 lb. The stromb-shell has a short conical spire and a much expanded outer lip, to which the popular

name 'wing-shell' refers. The animals are allied to the cowries and whelks (*Buccinum*), and are

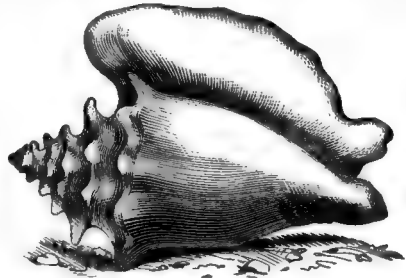

Fountain-shell (*Strombus gigas*).

very active, moving by short jumps. They feed on dead and decaying animal matter.

Stromness, a seaport in Pomona, Orkney, on a beautiful bay, 15 miles W. by S. of Kirkwall. Gow, Scott's 'Pirate,' was born here. Pop. 1693.

Strongbow, the surname of Richard de Clare, Earl of Pembroke, who went to Ireland to push his fortune in 1170 by permission of Henry II. (q.v.). He married the daughter of Dermot, king of Leinster, became governor of Ireland in 1173, and died at Dublin in 1176.

Stronsay, one of the Orkney Islands (q.v.).

Strontium (sym. Sr, dyad, atomic weight, 87.5—O = 16—sp. gr. 2.542) is a ductile and malleable metal, somewhat harder than lead, and of a pale yellow colour. When heated in the air it burns with a crimson flame, and becomes converted into its oxide, strontia, SrO. It is unaffected by the action of dry air, but it decomposes water at an ordinary temperature, hydrogen being explosively developed; and it burns in chlorine gas, and in the vapour of iodine, bromine, and sulphur. It dissolves in dilute nitric acid, but the strong acid has scarcely any effect on it. This metal does not occur in the native state, but exists as a carbonate in the mineral *Strontianite* (so called from its being first found in 1790 near Strontian, a village of Ardnamurchan parish, Argyllshire, 24 miles SW. of Fort-William), and as a sulphate in the mineral known as *Celestine*. It is obtained by the voltaic decomposition of the chloride of strontium. This metal bears to barium the same close relation that sodium bears to potassium; and the compounds of strontium resemble those of barium not only in their composition but in their properties. The oxide of strontium, commonly known as Strontia, is obtained in the same way as the corresponding oxide of barium, which it resembles in almost all respects, except that it is inert when taken into the system, while baryta is poisonous. When a small quantity of water is poured upon it it slakes, giving out heat.

The salts of strontia resemble those of baryta in their general characters, and in their being precipitated from their solutions by sulphuric acid and the soluble sulphates; but they differ from them in not being thrown down by silico-fluoric acid or hyposulphite of soda, and in their communicating to the flame of the spirit-lamp and to burning substances generally a brilliant purple-red colour. The salts of strontia occur only in the mineral kingdom, and are never found as normal ingredients of organic bodies. *Carbonate of Strontia*, SrCO₃, occurs native both in a massive and crystalline form, and may be obtained artificially as a white powder by precipitating a soluble salt of strontia with carbonate of soda. *Sulphate of Strontia* occurs native in *Celestine*, a mineral which

is found in beautiful rhombic prisms in Sicily. *Nitrate of Strontia*, $\text{Sr}(\text{NO}_3)_2$, separates from a hot concentrated solution in large colourless transparent anhydrous octahedral crystals, which dissolve freely in water. By the addition of nitric acid it is precipitated from its aqueous solution. This salt is insoluble in alcohol, but when finely powdered and mixed with it it communicates to the alcoholic flame a beautiful red or crimson colour. In consequence of this property it is employed by the makers of fireworks, especially for Bengal lights (see PYROTECHNY); but the mixture made for this purpose is highly dangerous, and has caused bad accidents by igniting spontaneously. The most important of the haloid salts of strontia is the *Chloride*, SrCl_2 , which may be obtained in crystals containing six equivalents of water. The water is expelled at a moderate heat, leaving the chloride anhydrous. The chloride is the only salt from which the metal has hitherto been obtained.

Strontia was discovered as an independent substance almost simultaneously by Hope and Klaproth in 1793. In 1807 Davy obtained barium and strontium from their oxides, but not in a pure state; and it was not till 1855 that Bunsen and Matthiessen succeeded in procuring perfectly pure specimens of the metal.

Strophanthus, a genus of plants belonging to the natural order Apocynaceæ, and natives of tropical Africa and Asia. The flowers are in terminal heads; the corolla is funnel-shaped, with its limb divided into five long cord-like segments (hence the name, Gr. *strophos*, 'a twisted cord,' *anthos*, 'a flower'); the style is thread-like, surmounted by a cylindrical stigma; and the fruit is a double follicle. Each follicle contains a large number of seeds having beautiful comose awns. There are several species, but the best known is the *S. hispidus*, var. *Kombé*, the seeds of which are now largely used in medicine. This species is widely distributed in tropical Africa, and climbs up the highest trees, hanging from one to the other in festoons. It has follicles 8 to 12 inches long, containing from about 100 to 200 seeds, each of which weighs about half a grain. An extract of the seeds is used as an arrow-poison (*Kombé* or *inee*) in districts widely apart, as at *Kombé*, in the Manganja country, in the Zambesi district, in the Somali country, in the Gaboon district, in Guinea, and in Senegambia. Dr Livingstone described it as used for killing animals only. The wounded animal is followed until the poison begins to take effect, it is then watched until it drops, the portion of meat round the wound is cut away and all the rest eaten.

In the British Pharmacopœia *Strophanthus* is defined as the mature ripe seeds of *S. hispidus*, var. *Kombé*, freed from the awns. Each seed is about $\frac{1}{2}$ inch long, $\frac{1}{4}$ inch broad, oval in shape, and flattened at the sides. The seed-coat is of a fawn colour, and covered with silky hairs. The kernel is white and oily, with a very bitter taste. The seeds contain an active principle, *strophanthin*, which is extremely poisonous, the medicinal dose of it being $\gamma\frac{1}{2}$ to $\gamma\frac{1}{10}$ grain. The drug is usually administered in the form of the officinal tincture of *strophanthus* made from the seed, of which the dose is 2 to 10 minims. Its action and uses are very similar to those of *Digitalis* (q. v.).

Stroud, a manufacturing and market town of Gloucestershire, 10 miles SSE. of Gloucester, on an eminence in a valley sheltered by the Cotswolds, where the Frome and Slade rivulets unite to form the Stroud Water or Frome. The water of this stream being peculiarly adapted for use in dyeing scarlet and other grain colours, cloth-

factories and dyeworks have been built along its banks for 20 miles; and Stroud itself is the centre of the woollen manufactures of Gloucestershire, and contains a number of cloth-mills. The parish church, St Lawrence, was rebuilt, with exception of the tower and spire, in 1866-68; the town-hall, incorporating an Elizabethan façade, in 1865; and there are also the Subscription-rooms (1830), the Lansdown Hall (1879), a hospital (1876), &c. From 1832 to 1885 Stroud, with twelve other parishes, formed a parliamentary borough, returning two members. Pop. (1881) 9535; (1891) 9818.

Struensee, JOHANN FRIEDRICH, COUNT, was the son of a German pastor of Halle, where he was born 5th August 1737. He studied medicine, and was appointed (1759) town physician in Altona. But in 1768 he accepted the post of private physician to Christian VII. of Denmark (1749-1808). He soon gained the complete confidence not only of the weak young king, but also of his consort, Caroline (1751-75), sister of George III. of England, who had a most unhappy lot as the wife of Christian. Struensee and the queen speedily possessed themselves of all power in the kingdom, dismissing the former ministers, forcing the king to abstain from all interference with government, and endeavouring to free Denmark from Russian influence, and to find a natural ally in Sweden. The changes which Struensee undertook in internal affairs were directed to the advancement of the prosperity of the country, of civil liberty, and enlightenment. He put the finances in order, reduced the expenditure, loosened the fetters in which industry and trade had been bound, encouraged education, mitigated the penal laws, and brought order into the administration. An act passed in 1771 to a certain extent abolished serfdom. But by all these measures he offended and outraged the nobility and the clergy, and by the haste and want of statesmanlike tact and skill with which they were carried out he appeared to the peasantry as little different from a despotic tyrant. The disaffected nobles and deposed ministers found a supporter in Christian's step-mother, and procured from the king an order for the arrest (16th January 1772) of the queen and Struensee. From both a confession of criminal intimacy was extorted; the queen was confined in the prison-fortress of Kronborg, while Struensee was cast in chains into the citadel of Copenhagen. Various charges of abusing the royal authority, attempting to force the king to abdicate, besides that of adultery with the queen, were laid to the charge of the favourite, and on 28th April 1772 he was beheaded. Queen Caroline's marriage was dissolved, and, parted from her only little daughter, she was conveyed by a British frigate to Hanover, where she died at Celle in 1775.

See a very full account in the *Memoirs and Correspondence* (1849) of Sir Robert Murray Keith, who was British envoy to Copenhagen at the time, and saved the queen from the fury of the populace; *Wraxall's Life and Times of Queen Caroline Matilda* (3 vols. 1864); and the article by Professor Ward on *Caroline Matilda* in the *Dict. Nat. Biog.* (vol. ix. 1887).

Struma, a term equivalent to *Scrofula* (q. v.).

Strutt, JOSEPH, antiquary, was born at Springfield in Essex, October 27, 1742, at fourteen was apprenticed to an engraver, studied art in the Royal Academy, and early gave himself to exceptionally laborious studies at the British Museum. He died in London, October 16, 1802, after a life spent, spite of poverty and sickness, in devotion to learning. His most important book was his last, the invaluable *Sports and Pastimes of the People of England* (1801). His first book was *The Royal and Ecclesiastical Antiquities of England* (1773); among its successors were his *Horæ Angel-Cynnan*,

or a complete view of the Manners, Customs, Arms, Habits, &c. of the Inhabitants of England (1774-75-76); *Chronicle of England*, down to the Norman Conquest (1777-78); a *Biographical Dictionary of Engravers* (1785-86); and *Complete View of the Dress and Habits of the People of England* (1796-99).

Struve, FRIEDRICH GEORG WILHELM, German astronomer, was born at Altona, April 15, 1793, educated at the university of Dorpat (Russia), and appointed to a post in the observatory of that place in 1813. He became director of the Dorpat Observatory in 1817, and in 1839 was placed at the head of the new observatory of Pulkova near St Petersburg. He retired in 1861, and died at St Petersburg on 23d November 1864. He directed his attention principally to the observation of double stars, and collected materials for three important works (1827, 1837, 1852) dealing with this branch of astronomy. He also carried out a number of important geodetic operations, such as the triangulation of Livonia (in 1816-19) and the measurement of an arc of the meridian in the Baltic Provinces (in 1822-27), which was subsequently (1828-56) extended by him, in conjunction with Hansteen (q.v.) and Selander, to the North Cape, and by General Tenner southwards to Ismail in Turkey. For this last gigantic undertaking, see Struve's *Arc du Méridien entre le Danube et la Mer Glaciale* (St Petersburg, 1857-60).—His son, OTTO WILHELM STRUVE, also an astronomer, was born at Dorpat, May 7, 1819, was educated under his father's direction, became his chief assistant at Pulkova, and the director of the same observatory after his retirement. He has made numerous astronomical discoveries, among which are more than 500 new double stars and (1847) a satellite of Uranus, and has written numerous papers, the most noticeable of which set forth his researches on the rings of Saturn and on the periodic motions of double stars.

Stry, or STRYI, a town of Austrian Galicia, on a tributary of the Dniester, 45 miles by rail S. of Lemberg, with sawmills and tanneries. Pop. 12,625, nearly one-half Jews. The town was almost wholly burned down in April 1886.

Strychnine, a poisonous drug, is named from a genus of tropical trees and shrubs of the order Loganiaceæ. The most notable species is the *Strychnos Nux Vomica*, so called from the name *Nux Vomica* given to its seeds, the source of strychnine. The tree and its seeds are described at NUX VOMICA. From various species of *Strychnos* are obtained the Clearing Nut (q.v.), the Curari (q.v.) poison, and Ignatius' Beans (q.v.); while one kind of *Upas* poison (*Upas tieute*) is made from a species of *Strychnos*.

Strychnine, $C_{21}H_{33}N_3O_2$, is an alkaloid occurring in crystals, has an intensely bitter taste, is colourless and inodorous, scarcely soluble in water, but easily soluble in boiling rectified spirit, in ether, and in chloroform. Pure sulphuric acid forms with it a colourless solution, which, on the addition of bichromate of potash, acquires an intensely violet hue, speedily passing through red to yellow. In nitric acid it ought, if pure, to form a colourless solution; if the solution is reddish it is a sign that brucine is also present. Strychnine combines with numerous acids, and forms well-marked salts, which give the same reactions as the base itself. *Nux vomica* seeds contain about .2 to .5 per cent. of it.—*Brucine* is the subject of a separate article.

Strychnine and brucine occur not only in *nux vomica*, but in the seeds of *Strychnos amara* (St Ignatius' beans) and in the seeds and other parts of several plants of the genus *Strychnos*. *Nux vomica* and its alkaloids are very poisonous to all

kinds of animals. It is believed, however, that the bird called *Buceros rhinoceros* eats the nuts with impunity; and a peculiar kind of *Acarus* lives and thrives in the extract of the nuts. In small doses ($\frac{1}{32}$ th to $\frac{1}{12}$ th grain) it is largely used in medicine as a stimulant, as a tonic, and as a bitter. The official preparations are made from *nux vomica* and from strychnine. In poisoning with strychnine the symptoms depend on excessive stimulation of the spinal cord, and when fully developed consist in rigid tetanic convulsions. These are preceded by muscular twitchings, cramps, and jerking movements. Each spasm lasts one or two minutes, and is followed by a short remission, during which the person lies completely exhausted, but able to converse and swallow. The slightest touch, a noise, or even a draught of air will bring on a spasm. The mind generally remains quite clear. Death takes place within two hours from exhaustion, or from suffocation produced by the impossibility of breathing during the spasms. Death may occur in a few minutes, however; a quarter of a grain is the smallest fatal dose of strychnine recorded, but patients have survived much larger amounts.

The treatment, after emptying the stomach, consists in keeping the patient as quiet as possible, and in administering substances which will depress the spinal cord, and thereby allay the tetanic spasms. Chloral hydrate and bromide of potassium by the mouth or rectum have been found useful in this respect. But putting the patient deeply under the influence of chloroform is probably the most efficacious mode of treatment.

Strype, JOHN, a voluminous ecclesiastical historian, was born in London, November 1, 1643, the same year as Burnet. He was educated at St Paul's School, whence he passed first to Jesus College, then to Catharine Hall, Cambridge. He was presented in 1669 to the perpetual curacy of Theydon-Bois in Essex, which he resigned a little later to become minister of Low Leyton in the same county. Later he received the sinecure of Tarring in Sussex and the lectureship of Hackney, which he resigned in 1724. He died at Hackney, December 11, 1737, aged ninety-four. His works fill thirteen folio volumes (27 vols., Clar. Press ed., 1821-43). The most important are *Memorials of Archbishop Cranmer* (1694); *Life of Sir Thomas Smith, Secretary of State to Edward VI. and Elizabeth* (1698); *Lives of Bishop Aylmer* (1701), *Sir John Cheke* (1705), *Archbishop Grindal* (1710), *Archbishop Parker* (1711), and *Archbishop Whitgift* (1718); *Annals of the Reformation* (vol. i. 1709, vol. ii. 1723, vol. iii. 1728, and vol. iv. 1731); *Ecclesiastical Memorials*, relating to religion and the Church of England under Henry VIII., Edward VI., and Queen Mary (3 vols. 1721). This last is his best work, forming, with Burnet's more readable *History of the Reformation*, a consecutive and full account of the reformed Anglican Church. Strype also published an enlarged edition of Stow's *Survey of London* (2 vols. 1720), with several sermons and pamphlets. As a writer he is heavy and unskilful in arrangement, but laborious and honest, and his transcriptions of the ancient papers he published may be trusted. A simple-minded but sincere man, he has left to posterity a series of works of the very greatest value despite their prolixity, irrelevant details, and tiresome repetitions.

Stuart. See STEWART.

Stuart, GILBERT CHARLES, American painter, was born at Narragansett, Rhode Island, in 1756. In his boyhood he went to Edinburgh with a Scotch painter named Alexander, with whom he studied his art; but his master dying, he worked his passage home, and began to paint portraits

at Newport. In 1775 he made his way to London, where he led for two years a Bohemian life; but his talent was recognised by his countryman, Benjamin West, who took him into his family, and soon he became a fashionable portrait-painter. In 1792, in the fullness of his powers and fame, he returned to America, and painted portraits of Washington, Jefferson, Madison, John Adams, and many of the distinguished men of the period, and was at work on a portrait of John Quincy Adams (afterwards finished by Sully) when he died at Boston, 27th July 1828. See a *Life* by G. C. Mason (New York, 1879).

Stuart, JOHN, LL.D. (1813-77), a Scottish antiquary, for twenty-four years attached to the Register House. His principal works were *The Sculptured Stones of Scotland* (2 vols. 1856-67) and *The Book of Deer* (see DEER). He contributed largely to the *Proceedings of the Scottish Society of Antiquaries*, of which he was secretary.

Stuart, MOSES, American divine and author, was born at Wilton, Connecticut, in 1780, and educated at Yale, where he remained for some time as a tutor. He began the study of law, but abandoned it for theology, was ordained as pastor of a Congregational church at New Haven in 1806, and in 1810 was appointed professor of Sacred Literature at Andover, a position he filled till 1848. During this period he published Hebrew grammars without (1813) and with points (1821), a translation of Winer's Greek grammar, commentaries on Hebrews, Romans, the Apocalypse, Daniel, Ecclesiastes, and Proverbs; *Hebrew Chrestomathy* (1829-30); *Essays on Future Punishment* (1830) and on *Christian Baptism* (1833); *Hints on the Interpretation of Prophecy* (1842); *Conscience and the Constitution* (1850); and numerous translations and letters. He died January 4, 1852.

Stubbes, JOHN, was born about 1541, had his education at Corpus Christi College, Cambridge, and Lincoln's Inn, and died about 1600. He wrote an answer to Cardinal Allen's *Defence of the English Catholics*, but is known by *The Discoverie of a Gaping Gulf, wherein England is like to be swallowed up by another French Marriage* (1579), against the marriage of Elizabeth with the Duke of Anjou. For his patriotism both himself and Page his printer had their right hands struck off.—**PHILIP STUBBES**, his near kinsman, was author of *The Anatomie of Abuses* (1583): conteyning a Discoverie or Briefe Summarie of such Notable Vices and Imperfections as now raigne in many Christian countreyes of the World: but especialie in a very famous Ilnde called Ailgna: Together with most fearful Examples of God's Judgements executed upon the wicked for the same as well in Ailgna of late, as in other places elsewhere. Wood tells us that he was 'a most rigid Calvinist, a bitter enemy to popery, and a great corrector of the vices and abuses of his time; and though not in sacred orders, yet the books he wrote related to divinity and morality.' A second part of his book appeared the same year (1583). In form it is a dialogue between Philoponus and Spudeus; the substance is a vehement denunciation of the luxury of the times, valuable in the highest degree to us for the light it throws on the dress and habits of the age of Shakespeare. Stubbes is, himself, really a bigoted and splenetic old fool, and he inveighs with curious passion against all extravagances of dress—the great ruffs, puffed out doublets of the men; the curling, frizzling, and crisping of the hair of the women; their great ruffs and neckerchers of holland, lawne, cameriok, and such cloth, lest they should fall down, smeared and smirched in the devil's liquor—starch.' In his blindness he saps the very foundations of morality by pouring out

his wrath alike on the mere extravagances of fashion and upon breaches of the weightier matters of the law. The work was reprinted by W. B. D. Turnbull in 1836, and by F. J. Furnivall in the *New Shakespeare Society's issues* (1879, 1882).

Stubbs, WILLIAM, historian, was born at Knaresborough, 21st June 1825, and was educated at Ripon grammar-school and Christ Church, Oxford, graduating with a classical first-class in 1848. He was at once elected to a fellowship at Trinity College, took orders, and became vicar of Navestock, Essex, in 1850. He acted as diocesan inspector of schools from 1860 till 1866, when he was appointed regius professor of Modern History at Oxford, with the year following a fellowship at Oriel. He was appointed librarian to Archbishop Longley at Lambeth in 1862, a curator of the Bodleian in 1868, rector of Cholderton, Wiltshire, in 1875, and canon residentiary of St Paul's in 1879. He was consecrated Bishop of Chester in 1884, and translated to the see of Oxford in 1889. Bishop Stubbs's historical work is marked by vast learning and rare impartiality and sagacity. The reader may follow him with complete confidence, and the only thing left to desiderate is a more supple and expressive style. Of his many works the chief are *Registrum Sacrum Anglicanum*: an attempt to exhibit the course of Episcopal succession in England (1858); Mosheim's *Institutes of Ecclesiastical History*, thoroughly revised and brought down to the present time (3 vols. 1863); *Select Charters and other Illustrations of English Constitutional History*, from the earliest period to the reign of Edward I. (1870); the altogether invaluable *Constitutional History of England in its Origin and Development* down to the accession of the House of Tudor (3 vols. 1874-78); *The Early Plantagenets in 'Epochs of Modern History'* (1876); and *Seventeen Lectures on the Study of Mediæval and Modern History* (1886).

Besides these he has edited, in the *Records publications*, of the reign of Richard I., the *Itinerarium and Epistola Cantuariensis* (2 vols. 1864-65); Benedict of Peterborough's *Gesta of Henry II.* and Richard I. (2 vols. 1867); Roger de Hovedon's *Chronicle* (4 vols. 1868-71); *The Historical Collections of Walter of Coventry* (2 vols. 1872-73); *Memorials of Saint Dunstan* (1874); the *Historical Works of Master Ralph de Diceto* (2 vols. 1876); the *Historical Works of Gervase of Canterbury*, covering the reigns of Stephen, Henry II., and Richard I. (2 vols. 1879-80); *Chronicles of the Reigns of Edward I. and Edward II.* (2 vols. 1882-83); *The Five Books of William of Malmesbury De Rebus Gestis Anglorum*, and the *Three Books of his Historica Novella* (2 vols. 1887-89). Bishop Stubbs received honorary degrees from Cambridge, Edinburgh, and Dublin, and is a corresponding member of the Institute of France, and other learned societies of Massachusetts, Denmark, Göttingen, Kieff, &c. He began with the Rev. A. W. Haddon the publication of a collection of *Councils and Ecclesiastical Documents relating to Great Britain and Ireland*, based on the *Concilia of Spelman and Wilkins* (3 vols. 1869-78).

Stucco, a term applied to work in plaster of Paris (sometimes mixed with other ingredients) used for coating walls or making casts of figures. See GYPSUM, PLASTERING, CAST.

Stud-book, a book containing the pedigrees of famous animals, especially horses. That for race-horses, edited by the officials of the Jockey Club, dates from 1808. There are stud-books for Clydesdale horses, cattle, &c., and even separate ones for collies, fox-terriers, St Bernard dogs, &c.

Stuffing. See TAXIDERMRY.

Stuhlweissenburg (Hung. *Szekes Fehérvár*, Lat. *Alba Regia*), a royal free town of Hungary, and seat of a bishop, lies in a swampy plain, 39 miles SW. of Budapest. Here from 1027 to 1527 the

kings of Hungary were crowned and buried. The town was in the possession of the Turks almost continuously from 1543 to 1688. It is now greatly decayed, but has celebrated horse-fairs. Pop. (1890) 27,548.

Stukeley, WILLIAM, antiquary, was born at Holbeach, Lincolnshire, 7th November 1687, and from the grammar-school there passed in 1703 to Corpus Christi College, Cambridge. Having taken his M.B. (1709) and studied at St Thomas' Hospital, he practised successively at Boston, London, and Grantham, meanwhile proceeding M.D., and being admitted an F.R.C.P. But in 1729 he took orders, and, after holding two Lincolnshire livings, in 1747 was presented to the rectory of St George the Martyr in Queen Square, London, where he died, 3d March 1765. His twenty works, published between 1720 and 1726, and dealing with Stonehenge, Avebury, and antiquities generally, enshrine a good deal that is curious, and have preserved much that might else have perished, but they are marred by a credulity and fancifulness which won for him the title of the 'Arch-Druid.' See his *Family Memoirs*, edited for the Surtees Society (3 vols. 1884-87).

Stundists. See RUSSIA, p. 36.

Sturdy, or the GID, affects young sheep, and sometimes young cattle, and is due to the presence within the brain of a Hydatid or bladder-worm, the *Cœnurus cerebralis*, which is the embryonic or cystic stage of the tapeworm—the *Tœnia cœnurus*, mostly found in dogs. The bladder or cyst, sometimes the size of a hen's egg, consists of an enveloping membrane, formed by the membranes of the brain, and contains a watery fluid. Upon its surface the membrane is covered with white dots in groups, and if these are closely examined with a slightly magnifying glass they will be found to be the heads of the *Tœnia* in various stages of development. This hydatid, when given to dogs, is known to produce tapeworms, and conversely itself originates from the ova of the tapeworm ejected on the pastures with the fœces of dogs. In the state of ova, or in some of its earlier minuter transitional forms, the hydatid embryo is picked up along with the grass, passes into the blood, and is thence laid down in the soft loose textures of the brain. It is but rarely seen where no dogs are kept, or perhaps where no foxes abound, and amongst sheep from six to twenty months old. The animal cannot properly seek its food, loses condition, staggers when moved, turns stupidly round almost in one spot, and usually towards the side on which the hydatid lies. The parasite and its sac may generally be removed by placing the sheep, with its feet tied, on a table or bench, searching for the softened portion of the skull, which generally overlies the hydatid, laying back a flap of skin, and introducing the trochar and canula, and, when the sac is deep-seated, cautiously withdrawing it with the help of a small syringe. Protected by a leather cap and simple water-dressings, the wound may heal and the sheep recover.

Sture, a noble family of Sweden, which furnished three successive regents to that country during the period (1470 to 1520) it was nominally united with Denmark. The first of these was STEN STURE THE ELDER (died 1503), an enlightened and far-seeing statesman, who, relying upon the peasantry, combated the pretensions of both clergy and nobility, successfully withstood the Danes, and encouraged learning by founding the university of Upsala, introducing printing into Sweden, and inviting thither learned men. He was succeeded by his nephew, SVANTE NILSSON STURE (died 1512), who also fought bravely against the Danes; and the third regent of the family was STEN STURE THE

YOUNGER (died 1520), who was mortally wounded in battle against the Danes.

Sturgeon (*Acipenser*), a genus of Ganoid fishes of the family Acipenseridae, order Chondrostei. The Chondrostei are Ganoids without ganoid scales, the skin being either naked or with bony plates, as in the sturgeon. The skull is cartilaginous, but covered externally with bony plates belonging to the skin. The tail is asymmetrical or heterocercal, and the gelatinous notochord persists in the centre of the vertebral column throughout life. Spiracles like those of sharks and skates are present in some genera. The distinguishing features of *Acipenser* are these: the body is long and narrow, and the skin is provided with five longitudinal rows of bony shields, each bearing a projecting keel. One row of these bony plates is along each side of the body, one along the back, and one on each side of the ventral surface. The skin between these rows of plates is naked, but contains minute scales which give it a rough surface. The head projects into a flat, pointed snout, provided with fleshy tentacles or barbels; and on the under surface of this snout, some distance behind its extremity, is the mouth, which is without teeth, and capable of protrusion. The gill-opening is wide. There are two pairs of fins, the pelvic being situated a long way back, close to the anus. There are two median fins, one dorsal and one ventral, both near the tail. The fin-rays are jointed and flexible. Spiracles are present behind the eyes. The air-bladder communicates with the gullet. There are many species of sturgeon, all confined to the northern hemisphere. They live in the sea and great lakes, and ascend the great rivers. All are of considerable size, and supply valuable commodities, for which they are regularly captured on a large scale. These commodities are their flesh, which is palatable and wholesome, their roe (*Caviare*, q.v.), and their air-bladders, from which isinglass is made. The eggs are small and numerous, like those of bony fishes; there is no copulation, the ova being laid and fertilised on the bottom of the upper parts of rivers, like those of the salmon. The food of sturgeons consists of worms, crustacea, and molluscs, which they seek by routing in the sea-bottom with their snouts.

The Common Sturgeon (*A. sturio*) is the only species which occurs in British seas and rivers.

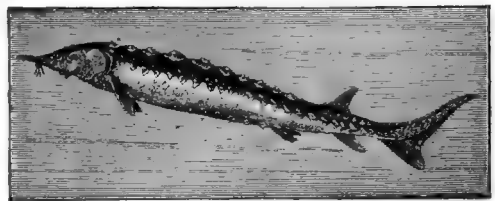

Sturgeon (*Acipenser sturio*).

The specific characters distinguishing the species are minute, consisting in the number of the bony scales, position of the fins, length of the snout, &c. *A. sturio* is sometimes taken by trawlers at sea, more often in salmon stake-nets, and in estuaries, especially in the Severn. It enters the rivers in the early part of the year for the purpose of breeding. When adult it is from 6 to 10 feet long. It occurs in the Mediterranean, western and northern Europe, and on the Atlantic coast of America, but is absent from the Black Sea and Danube, and from the Caspian Sea. In England, as early as Edward II.'s reign, the sturgeon was a royal fish, belonging to the king when captured. The Sterlet (*A. ruthenus*) is a much smaller species, which is common in the Black and Caspian Seas, and ascends the Danube as far as Vienna. It is one of the

principal objects of the sturgeon-fishery on the Volga. *A. huso* is the largest species, reaching 25 feet in length, and also belongs to the Black and Caspian Seas. *A. stellatus* is another species of these seas; it reaches 5 feet in length. Other species occur on the Atlantic and Arctic coasts of North America, in the great lakes of the St Lawrence system, in California, and on the west coasts of the North Pacific, in China, and eastern Siberia. *A. brevirostris* belongs to the southern Atlantic coasts of the United States. The species of the great lakes of the St Lawrence is *A. rubicundus*. The species of California and the Pacific coast is *A. transmontanus*.

The most important sturgeon-fishery in Europe is that of the Volga and the Caspian Sea. The flesh of the fish is salted, and caviare and isinglass made on a large scale from the roes and air-bladder. In America sturgeon flesh is eaten fresh, and caviare is made both in Georgia and in San Francisco; but there is no great fishery in any particular district, and the manufacture of Isinglass (q.v.) does not receive much attention.

Sturlason. See SNORRI STURLASON.

Sturm, JOHANNES, well known as an educational reformer, was born at Sleiden, in the duchy of Luxemburg, 1st October 1507. In his fifteenth year he was sent to Liège, where he attended a school of the Brothers of the Common Life—a school so admirably organised that in his own subsequent reform of the schools at Strasburg Sturm largely followed its model. Three years later Sturm continued his studies at Louvain, then the most enlightened centre of the higher studies north of the Alps, where shortly before there had been founded a college for the teaching of Latin, Greek, and Hebrew. Besides his zeal as an educational reformer Sturm all through life had the ambition to write a Latin style framed on the best models of antiquity. It was at this time, therefore, that he began the assiduous study of Cicero, whom to the end he never ceased to read with unabated zeal. He remained some five years in Louvain.

In 1529 he went to Paris, and at first gave himself to medicine, with a view to securing a settled competence. But his natural instinct again declared itself, and he returned to the study of Cicero, on whom he gave courses of lectures in the Collège Royal. Besides lecturing on Cicero he also taught dialectics, and had for one of his students Petrus Ramus (q.v.). As a sympathiser with the new teaching in religion, identified as yet only with the name of Luther, it was at some risk that Sturm made his home in Paris. Accordingly, when a request was made to him (1536) by the authorities of Strasburg to come to their assistance in reorganising the education of their town, Sturm willingly accepted their offer. By its position on the frontiers of France and Germany Strasburg played a part of the highest importance in the political and religious history of the 16th century. Both in the religion and politics of his time Sturm took a prominent part, and on different occasions was sent on missions to France, England, and Denmark. In religion he took sides with Zwingli against Luther, with whose followers in Strasburg he was in constant controversy, which embittered all the later years of his life.

Before Sturm's settlement in Strasburg its magistrates had shown an enlightened interest in public instruction; but guided and inspired by Sturm the town became one of the most important educational centres in Europe. Two years after his arrival (1538) a new gymnasium was established, with Sturm as its rector, and at the same time boarding-houses were erected for poor students with the object of suppressing the mediæval practice of

mendicancy. Elementary and secondary education were thus provided for; but it was the ambition of Sturm that the higher studies should also be within reach of every youth of Strasburg. The divided councils of the town, however, and the outlay the organisation of such studies would imply delayed Sturm's scheme till as late as 1564. In that year was founded the Strasburg Academy, which, together with the Gymnasium, supplied a complete course of instruction in all the learning of the time. Sturm's ideal in education was 'to direct the aspiration of the scholars towards God, to develop their intelligence, and to render them useful citizens by teaching them the skill to communicate their thoughts and sentiments with persuasive effect.' In carrying out this ideal, described in his favourite phrase *pietas literata*, Sturm showed his superiority by his judicious gradation of the course of study, and by his novel and attractive methods of instruction. It is his chief praise that beyond all his contemporaries he succeeded in correlating public instruction to the moral and intellectual development of his time. It was little to the credit of Strasburg, therefore, that in his last years he was forced to leave the town through the intolerance of Lutheran zeal. Eventually permitted to return, he died on 3d March 1589. He was a voluminous writer, but, except for the light they throw on the great questions of the 16th century, his works possess no independent value.

See Charles Schmidt, *La Vie et les Travaux de Jean Sturm* (Strasburg, 1855), and German works by Laas (1872) and Kückelbahn (1872).

Sturm and Drang. See GERMANY, p. 188.

Sturt, CHARLES, one of the most resolute of Australian explorers, went as captain of his regiment to Australia, and between 1828 and 1845 headed three important expeditions (see AUSTRALIA, Vol. I. p. 592), from the last of which he returned blinded by hardship and exposure. He held several colonial appointments, and in 1851 received a pension from the first South Australian parliament. He wrote two narratives of his explorations (1833 and 1848), and died in England, 16th June 1869.

Stuttering. See STAMMERING.

Stuttgart, the capital of Württemberg, stands in a natural basin (817 feet above sea-level) surrounded by hills, which are studded with villas, vineyards, and gardens, and crowned with woods, about 2 miles from the Neckar, and 189 by rail WNW. of Munich, 127 SSE. of Frankfort. Except the churches, most of the public edifices date from the 19th century, and are chiefly built in the Renaissance style. The centre of the place is the Palace Square, upon or near which stand the following buildings—the new royal palace (1746–1807), the old royal castle (16th century), two or three other palaces of the royal family, the Königsbau (shops, bourse, concert-rooms, &c.), the theatre, the railway station (one of the finest in all Germany), the post-office, the Akademie (formerly the Carl School; now library and guardhouse), and the jubilee column (1841), and statues of Schiller and Duke Eberhard. The Collegiate Church, St Leonard's, and the Hospital Church date from the 15th century. The last two, as well as the modern church of St John, are in the Gothic style. The other chief public institutions of Stuttgart are its famous Polytechnic (with 250 students), the Conservatory of Music, the royal library (425,000 vols., with a fine collection of 7000 Bibles), the museum and picture-gallery (fine Thorwaldsen casts), and other collections and educational establishments. Stuttgart ranks next after Leipzig as a centre of the German book-trade. It has, moreover, active industries connected with textiles, beer, pianofortes, chemicals, chocolate, artists' colours, furniture, and

has celebrated fairs for books, hops, horses, and cloth. North-east from the palace lies the picturesque royal park (with some good statuary), extending almost all the way to Cannstatt (q.v.). There are an unusually large number of royal seats and palaces in the vicinity of this place, as the Solitude, Hohenheim, Wilhelma, Rosenstein, Berg, Hegel and Hauff were born at Stuttgart. Pop. (1875) 107,573; (1890) 139,659. Stuttgart owes its name and origin to a stud-farm of the early Counts of Württemberg, and has been the capital since 1482.

Stuyvesant, PETER, governor of New York, was born in Holland in 1602, became governor of Curacao, and lost a leg in the attack on St Martin, and in 1646 was appointed captain-general of the New Netherlands. He proved a vigorous but arbitrary ruler, a rigid Sabbatarian, and an indignant opponent of political and religious freedom. Yet he did much for the commercial prosperity of the city, which received its name of New Amsterdam in 1653, and which he would fain have held against the English in 1664, when it became New York. He afterwards lived at his farm—the 'Great Bouwerie,' whose name survives in one of the older streets of the city which soon covered it; and there he died in August 1682.

Stye. See EYE, Vol. IV. p. 516.

Style, OLD AND NEW. See CALENDAR.

Stylites, SIMEON, the earliest and most famous of the ascetics called Pillar-saints (Gr. *stylites*), had been a monk, and had lived, in the beginning of the 5th century, in extreme seclusion in his Syrian monastery for nine years, without ever moving from his narrow cell. Increasing in enthusiasm he withdrew to Telanessa, near Antioch, where he established himself on the top of a pillar 72 feet high, and only 4 feet square at the top. Here he spent thirty years. During the day he preached to the crowds who gathered at the foot of his pillar; and his admonitions to emperors and empresses were accepted with humility. The fame of his sanctity brought crowds of pilgrims from the most distant countries to see him; and the admiration of his fasting and other austerities is said to have converted many pagans to the church. He died on his pillar in 459, aged seventy-two, and was buried with the greatest pomp at Antioch. A disciple of Simeon, named Daniel, succeeded to his reputation for sanctity, and to his mode of life, which he maintained for thirty-three years, in the still more trying climate of the shores of the Bosphorus, about 4 miles from Constantinople. The emperor at length insisted on a covering being placed over the top of the pillar, and Daniel survived till the year 494. In Syria there were many pillar-saints as far down as the 12th century; but in the west Daniel is all but a solitary example. A monk named Wulfailich, near Treves, attempted the pillar-life in the 6th century, but the neighbouring bishops compelled him to desist and destroyed his pillar.

Styptics (Gr. *styptikos*, 'astringent') are agents employed in Surgery for the purpose of checking the flow of blood by application to the bleeding orifice or surface. See BLEEDING.

Styria (Ger. *Steiermark*), a duchy of Austria, is bounded on the N. by Upper and Lower Austria, E. by Hungary, S. and W. by Carniola, Carinthia, and Salzburg. Its area is 8629 sq. m., and pop. (1880) 1,213,197; (1890) 1,281,023, who are partly (67 per cent.) of German and partly (33 per cent.) of Slavonic origin. Styria is a mountainous country, traversed in all parts by ramifications of the Alps. The Save and Drave water the southern districts; the Mur, going south to the Drave, flows through the middle of the duchy; while the Enns

skirts the north-west boundary. The climate is variable, but generally raw and cold in the northern and more mountainous portion, and mild in valleys and in the south. Forests cover 51½ per cent. of the area; 25½ per cent. is meadows and pastures; and 22 per cent. is under cultivation, producing oats, maize, rye, potatoes, roots for cattle, flax, wine. The chief wealth of the country, however, lies in its mineral products, especially iron; the secondary minerals include salt, coal, graphite, zinc, &c. The chief industries are connected with the production of iron and steel, and their manufacture into such articles as machinery, agricultural implements, wire, and so forth. There are also manufactures of cement, chemicals, candles, cloth, gunpowder, beer, paper, tobacco, and glass. Styria was anciently divided between Noricum and Pannonia, and in the end of the 6th century was colonised by the Wends (Slavs). In 1056 it was separated from Carinthia and made a separate margraviate; and in 1192 it was joined to the Austrian crown, having a few years previously been made a duchy.

Styx (Gr. *styein*, 'to hate'), one of the rivers of Hades—the tenth part of the waters of Oceanus—flowing round it seven times with dark and sluggish stream, across which Charon ferries the shades of the departed. The nymph of this stream was the daughter of Oceanus and Tethys, and she first, together with her children, came to the help of Zeus against the Titans. For this service they were taken to Olympus, and she herself became the goddess by whom the most solemn oaths of the immortals were sworn. When such an oath was taken Iris brought some of her sacred water in a golden cup, and whoso swore falsely by it lay speechless and breathless for a year, and was banished nine from the councils of the gods.—A rocky stream falling into the Crathis in the north-east of Arcadia bore this name, the scenery around it being fittingly weird and desolate.

Suabia. See SWABIA.

Suahell. See SWAHILI.

Sua'kin, or more correctly SAWAKIN, a seaport of the Red Sea, stands on a small rocky island in a bay on its west side, and is the principal outlet for the commerce of Nubia and of the countries of the Sudan beyond. The island-town is connected with the settlement of El-Keff on the adjacent mainland by a causeway. There are active industries in silver ornaments, knives and spear-heads, and leather-work; but the commerce was, previous to the disturbances which broke out in that quarter in 1883, of much greater moment, being valued at one million sterling annually. Since tranquillity was restored the trade has revived (£103,800 in 1886; £251,700 in 1890; £210,768 in 1891). The more important exports are silver ornaments, ivory, gums, millet, cattle, hides, and gold; the imports, durra, cottons, flour, sugar, rice, ghi, dates, and coal. Here some 6000 or 7000 pilgrims embark every year for Mecca. The Egyptians occupied this port when they extended their power over the Sudan; and in its vicinity several battles were fought between the allied Egyptians and English against the fanatical followers of the Mahdi. Ever since those troubles began Suakin has been held by an English garrison. Pop. 11,000. See BERBER; and works by E. G. Parry (1885) and W. Galloway (1888).

Suarez, FRANCISCO, a philosopher and divine of the Roman Catholic Church, was born at Granada on 5th January 1548. As a youth he was so backward that he had considerable difficulty in gaining admission to the order of the Jesuits. But his mind ripened rapidly and developed in some respects unusually high qualities. During the course of his career he taught theology at Segovia,

Valladolid, Rome, Alcalá, Salamanca, and Coimbra. His theology was a modification of that of Molina (q.v.); he held that in the case of the elect there is a peculiar grace granted, specially adapted to their several individual natures. In formal scholastic philosophy he steered a middle course between realism and nominalism. The most notable of his books were what may be termed the earliest foreshadowing of the modern doctrine of international law (*Tractatus de Legibus ac Deo Legislatore*) and a treatise condemning the extravagant pretensions to kingship put forward by James I. of England. This latter (*Defensio Catholica Fidei*) was written in 1613 at the command of the pope. Suarez died at Lisbon on 25th September 1617. His works were published in 23 vols. at Mainz and Lyons in 1630 *et seq.*, and in 29 vols. at Paris in 1859. There is a Life of him by Deschamps (Perpignan, 1671), and another by Werner (2 vols. Ratisbon, 1861).

Subahdar was, under the Mogul government, the title of a governor of a province. It now designates a native officer in the army in India, holding a rank equivalent to that of captain, but subordinate to the European officers.

Subaltern, in the Army, is an officer below the rank of captain—i.e. a lieutenant or sub-lieutenant.

Subiaco (anc. *Sublaqueum*), a city of Italy, lies embosomed in hills beside the Teverone, 32 miles E. by N. from Rome, and was the cradle of the Benedictine order and the place where the printing-press was first set up in Italy (1464). There are two monasteries dating from the 6th century, one of which (Santa Scolastica) contains a small but valuable library, whilst the other was built near the cave in which St Benedict lived. The city was greatly favoured by Pope Pius VI.: he enlarged its castle (built 1068), erected a church, &c. Pop. 6503.

Subinfecundation. See LAND LAWS.

Subject. See OBJECT.

Sublapsarian. See PREDESTINATION.

Sub-lieutenant. See LIEUTENANT.

Sublimation is a chemical process similar to distillation, but differing from it in the nature of the substances to which it is applied. While in distillation *liquids* are converted by the agency of heat into vapour, which is condensed in the liquid form usually by the cooling action of water, in sublimation *solid* bodies are reduced by heat to the state of vapour, which reassumes the solid form on cooling. Sublimation is usually conducted in a single vessel of glass or iron, the product being deposited in the upper part of it in a solid state, while the impure residue remains at the bottom; but in the case of sulphur the vapour is condensed on the walls of a large chamber. Iodine affords a good example of sublimation. On gently heating the lower part of a Florence flask containing a little of this substance a purple vapour rises, which almost immediately condenses in small brilliant dark purple crystals in the upper parts of the flask, while any impurity that may be present remains at the bottom. Amongst the substances obtained by this process, and employed in the Pharmacopœia, are arsenious acid, benzoic acid, corrosive sublimate, and sublimed sulphur.

Submarine Forests. See articles FOSSIL, PEAT, and POSTGLACIAL AND RECENT SYSTEM.

Submarine Mines. See MINES (MILITARY).

Submarine Navigation. When the Diving-bell (q.v.) had shown that air for respiration can be supplied to persons in adequately arranged vessels under water, ingenious men began to speculate on

the possibility of navigating closed ships or boats in similarly exceptional circumstances. The first submarine boat on record was constructed in the beginning of the 17th century by a Dutchman named Cornelius Drebell, or Drebell. She was propelled by oars, and was tried in the Thames by order of James I. She carried twelve rowers, besides passengers. This vessel is alluded to in Robert Boyle's *New Experiments, Physico-Mechanicall, touching the Spring of the Air*, &c. (Oxford, 1660). Pages 363-365 of this curious work contain an account of Drebell's experiment, and state that he accounted his chief secret to be 'the composition of a liquid that would speedily restore to the troubled air such a proportion of vital parts as would make it again for a good while fit for respiration.' The composition of this liquid for enabling the same air to be used again and again was never made public. Bishop Wilkins, who also favoured some other whimsical projects, devoted a whole chapter of his *Mathematical Magick* (1648) to a dissertation 'Concerning the possibility of framing an Ark for Submarine Navigation.' He here recites the difficulties of the scheme, but evidently considers them not insurmountable; and afterwards he enlarges upon its advantages, in privacy, security from pirates, storms, ice, &c., in naval warfare, philosophical experiments, discoveries, &c. In 1774 an inventor named Day lost his life in an experimental descent in Plymouth Sound in a vessel of about 50 tons burden. One of the most successful machines contrived for submarine navigation was that of Bushnell of Connecticut, which was projected in 1771, and completed in 1775. Bushnell's chief object appears to have been the introduction of submarine warfare. His vessel was propelled by screws, somewhat resembling those now in use for steam-vessels, and there was sufficient air to last for half an hour. In 1800 Robert Fulton, also an American, while residing in France constructed a submarine boat, of which he made many trials, some of them at the expense of the French government, on the Seine, at Brest, and at Rouen. Compressed air was used for respiration, and he remained at a depth of 25 feet for four hours, propelling the boat in any direction; he also successfully attached a torpedo containing gunpowder to the bottom of an old vessel lying in Brest harbour, and blew her up. The vessel patented in 1859 by Mr Delaney of Chicago was egg-shaped in transverse section, and diminished nearly to a point at each end. It had two iron tanks in the interior; one had air pressed into it by an air-pump; the second contained water. The engineer of the boat, by pumping water into or out of the second tank through the action of the air in the first, could raise or lower the boat to different depths in the water. In 1863 the Confederates in Charleston made use of a submarine boat against the blockading Federal squadron. This boat, called a 'David' after her inventor, was built of boiler-plates and propelled by hand by eight men at a maximum speed of four knots; two side-rudders were used for sinking and raising the boat when in motion; she was cigar-shaped, and when advancing to attack her top was just on a level with the surface of the water; three trial trips were made, and each time she sank and failed to rise, the crews perishing before they could be rescued; the fourth trial, however, was successful, and passing out of the harbour she succeeded in blowing up the *Housatonic*, but could not get clear, and was carried down by the *Housatonic*. Several of these 'Davids' were afterwards constructed by the Confederates, but none of them again succeeded in inflicting any serious damage upon the Federal ships.

For some years afterwards, although several experiments were carried out in France and

America, no successful results were arrived at, but in 1886 a submarine boat was built at Stockholm by Nordenfält. She was driven by steam, and ran 16 miles at a speed of 5 knots, but was only immersed for five minutes at a time; she descended, however, some 30 feet, and this was repeated several times. A similar boat was constructed for and bought by the Greek government. Two others somewhat larger were built by Nordenfält for the Turkish government, and were tried at Constantinople in 1887; they were 100 feet long, 12 feet in diameter, with a displacement of 160 tons, and when not immersed had a speed of 12 knots, travelling a distance of 100 miles without recoaling; they had a crew of six men, and descended successfully to a depth of about 50 feet. A still later Nordenfält boat was tried at Southampton, also in 1887; she was 125 feet long, with a diameter of 12 feet, a displacement of 230 tons, and indicated 1000 horse-power with a speed of 15 knots when not immersed; with her cupola awash, however, this speed was reduced to 5 knots. Although these boats at the time seemed to answer all expectations, further experiments would seem to have shown that they could not be depended upon for real practical work, and the original boat, after lying some time at Copenhagen without finding a purchaser, was finally bought and broken up as old iron in 1891.

By the choice of steam as his motive power the inventor created difficulties not easily to be overcome, and prevented the satisfactory development of that type of boat. One result of this choice was that the boat, when proceeding without communication with the atmosphere, was entirely dependent upon the energy developed by the boiler. That this method of accumulation is disadvantageous is clear from thermo-dynamic principles, which show that from a kilogram of water of 200° centigrade, when it is cooled to 121° C. by the withdrawal of steam, only 2000 m.kg. of work can be obtained. Then not only is the great weight of the engines and boiler a disadvantage, but the continual radiating heat from the boiler renders a prolonged stay in one of these boats impossible when under the surface. An attempt has since been made in England with the Honigman natron-boiler, but with no better results; and later inventors have adopted electric accumulators with electric motor and engines as the motive power. Experiment shows that as much as 8000 m.kg. of work can be developed per kilogram of accumulator weight. In 1888 a boat called the *Nautilus*, designed by a Mr Campbell, was tried in the West India Docks. She was 60 feet long, with a beam of 8 feet, was driven by electricity, and fitted with two impulse tubes for Whitehead torpedoes. The trial was fairly successful.

The nearest approach to a workable submarine boat was made in two boats built in France, named the *Goubet* and *Gymnote*, and in one, the *Peral*, built at Cadiz. After exhaustive trials, a fair measure of success was obtained; and in 1897 the French navy had four such boats. The *Peral*, so called after her designer, a lieutenant in the Spanish navy, was first tried at Cadiz in May 1889. According to the official reports, with 250 accumulators on board she attained a speed of 7 knots, and it is believed that with 616 accumulators a speed of 11 knots would be reached. She covered during two trials some 120

miles without exhausting all the electricity in the accumulators, answered her helm well, and no difficulty appears to have been experienced in sinking or again rising to the surface, although it appears to have been found necessary to rise to the surface before venturing to alter course. A torpedo, of which she is fitted to carry three, was also successfully discharged at a target 400 metres off, while during the six hours she remained closed up, the air on board remained perfectly sweet. In the case of the *Gymnote* and the *Goubet*, with which since 1889 a series of trials have been carried out at Toulon and Cherbourg, the results have been much the same. No difficulty was experienced in sinking and rising to the surface, yet they ran on a perfectly straight course; and when it was wished to turn, the boats were brought to the surface, and placed on their new course before again sinking. When they were moving at a depth of some 15 feet below the surface no trace of their course could be perceived on the top of the water, although in the case of the *Gymnote* at Toulon she was clearly visible and all her movements followed from a captive balloon some 150 feet in the air. The *Goubet* has a displacement of about 2 tons, is 16 feet 5 inches long, 5 feet 10 inches deep, and with a beam of 3.5 feet; outside the boat at the stem she carries a torpedo charged with 110 lb. of dynamite; she carries a

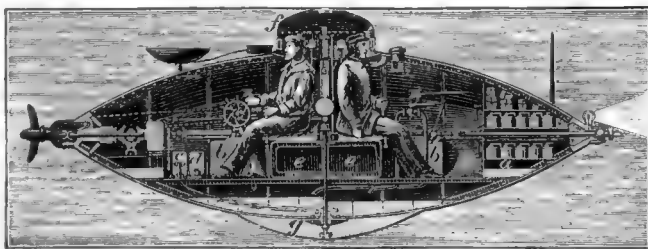

Section of the French Submarine or Surface Boat *Goubet*, built 1888 :
 a, the electric accumulators; b, tanks for compressed air; c, d, pumps; e, e, engines;
 f, cupola; g, the safety or emergency weight, which, in event of pumps or machines
 breaking down, can be detached, when the vessel at once rises to the surface.
 When proceeding on the surface only the cupola, f, is visible above water.

detachable keel weighing 900 kilograms, the dropping of which, in the event of the pumping-out arrangements at any time breaking down, would enable the vessel to immediately rise. Her crew consists of only two men. She is fitted with reservoirs for compressed air, electric accumulators, and motor. The *Gymnote* is a boat about as large again. In spite of the relative success which has attended the trials of these three boats, the experiments seem to have revealed certain practical difficulties which render it problematical if submarine navigation can ever be carried on with any degree of safety or certainty. It has been shown that at a depth of only some 50 feet it is impossible to distinguish objects more than 25 feet off, and that even the electric light fails to illuminate objects at a greater distance in the gloom which obtains at this depth; the colour of the water at this depth is a deep green, and red objects are completely invisible. Navigation under these circumstances must always be dangerous. In the French and Spanish experiments a given course seems to have been steered with mathematical accuracy by means of the gyroscope, but to deviate from this course would appear at present to be difficult without those in the boat losing all knowledge of their whereabouts, and thus being forced to come to the surface to reconnoitre; and the slow speed at present attainable, not exceeding 7 to 8 knots, also militates

against the possible usefulness of these boats. Where they seem really to have achieved a great success is when moving just below the surface of the water with the optical glass, which is only about the thickness of a man's fist, showing above the surface. In 1898-99 very successful experiments were made with the *Gustav Zede*, named after the maker. She sailed, partly above and partly below the surface, from Toulon to Hyères and Marseilles, discharged her torpedoes successfully, and made no noise to betray her position. This vessel has quite superseded the *Goubet* and *Gymnote*. Britain and the United States have also experimented with this species of craft, and in the latter country the Holland type, named for its inventor, has been adopted. See also the article TORPEDO.

Submarine Telegraphy. See TELEGRAPH, and ATLANTIC TELEGRAPH.

Subpoena, in English law practice, means the writ or process by which the attendance of a party or witness in a court of justice is compelled. It is a writ in the Queen's name commanding him to lay aside his business and all excuses, and attend at the time and place indicated, under a penalty. If the witness is required to produce a document the writ is called a *subpoena duces tecum*. If the person summoned do not attend and has not a good legal excuse, such as dangerous illness, he may be sued in an action of damages or committed to prison.

Subsidence. See UPHEAVAL.

Subsidies, parliamentary grants to the crown, levied on persons in the form of so much on the pound for land or goods; or grants of special sums from customs duties (see CUSTOMS DUTIES, and TAX). The term is used to denote money paid by one state to another in order to procure a limited succour of auxiliary troops, ships of war, or provisions. Thus, in the time of the war with the revolutionists of France and Napoleon I., Great Britain furnished subsidies to foreign powers to a large extent in order to engage them to resist the progress of the French.

Substance is a term which has played a great part in philosophical and theological discussion. It occurs first in the Aristotelian enumeration of categories, where *ousia* is in a manner opposed to the other nine categories of attribution and relation. This contrast is expressed in the correlation of the Latin terms substance and accident. Substance is defined as that which exists *per se*, whereas attributes or accidents exist *in alio*. The substance, in other words, is regarded as an independent existence, a permanent subject of which the accidents are predicated, and to which they belong as its qualities or states. Individual things were thus treated by Aristotle and the scholastics as existing *per se*; they are, in the Aristotelian phrase, 'the first substances.' To the objection which readily occurs that God alone is in this sense substance—i.e. truly self-subsistent—they replied by the distinction between *per se* and *a se*. If the world is not to be resolved into a flux of accidents, created substances must exist *per se*; but God alone exists *a se* or absolutely. The same distinction—between created substances and God as the one absolutely independent substance—reappears in Descartes, but is repudiated by Spinoza, who thus reaches his completely pantheistic doctrine of the *unica substantia*. In English philosophy the aspect of substance made most prominent is that of an underlying 'substratum' (the Greek *ὑποκείμενον*) or unknown 'support' of the qualities we know. Locke, like Descartes, believed in two classes of substances, material and spiritual; but the negative criticism of Berkeley was brought to bear against the first class, while Hume directed

the same battery against the spiritual substances which the bishop had spared, and thus pulverised the world into unsupported accidents. All our perceptions, Hume declares, 'may exist separately, and have no need of anything else to support their existence.' The criticism, however, which is valid against the peculiar form which the doctrine of substance had assumed in Locke ignores the really indispensable character of the conception. The notion of substance as something over and above the qualities—an inaccessible somewhat, hidden behind the qualities instead of being revealed by them—is undoubtedly false. But a pure phenomenalism can yield no theory of knowing or being. The world, as it has been said, is not a flight of adjectives; qualities do not fly loose; they are necessarily unified in a substance or subject. In recent philosophy the misleading idea of a substratum reappears in the Kantian theory of the unknowable thing-in-itself, which in turn develops into the characteristic doctrine of modern agnosticism.

Subways. The term subway has been most generally applied to arched passages or small tunnels under streets for the purpose of containing gas-pipes, water-pipes, and sometimes sewer-pipes, or at least drains for surface-water. Some also contain telegraph-wires and pipes for the transmission of compressed air. They are made of sufficient size to permit of workmen walking to and fro in them to examine the pipes and to execute repairs. It need hardly be said that in large towns such subways are a great public benefit. They save the necessity for breaking up streets to get at the pipes for repairs, an operation which not only obstructs the traffic, but prevents the roadways and foot-pavements from being kept in proper condition. Paris has long had an extensive system of subways for the purposes above noted. These are built of stone, and are of various shapes, being circular, oval, or egg shaped, or with straight sides and semicircular top. The lower portions of them are stepped for footpaths, with a track for the drain between these. A number of these subways have been constructed in London—in Southwark Street, Queen Victoria Street, and the Thames Embankment, for example. The subway under the roadway of the Boulevard Sebastopol, one of the largest in Paris, is 16 feet wide and 11 feet high; that under the footway of the Thames Embankment is 9 feet wide and 7 feet 3 inches high.

Another class of subways which has been extensively constructed of late years both in Britain and abroad comprises arched passages under railways to enable passengers to pass from one side to another of a station, or to communicate between two adjacent railway stations. In some cases these are elaborate examples of underground engineering, and when they are faced with glazed bricks, as most of them are, they have a clean and elegant appearance.

The name subway was in general use during its construction for the deep tunnel electric railway between the City and Southwark, now called the City and South London Railway, which was opened in 1890. Two separate tunnels were made for this line—one for the up and another for the down traffic. At the stations the passengers descend and ascend by hydraulic lifts, unless they prefer to use the stairs. A second underground electric railway, the City and Waterloo, $1\frac{1}{2}$ miles, was opened in 1898, and another from Waterloo to Baker Street was making in 1899. The obvious advantage of having so much of the local passenger traffic withdrawn from the crowded streets promises to develop this method of underground railways in London and other busy cities. See TUNNEL.

Consult the *Proceedings of Civil Engineers*, vol. xxiv., for the drains and subways of London and Paris; *Les Promenades de Paris* (1873), for sections of the Paris subways; and *Engineering*, vols. xlix. and l. (1890), for papers on the City and Southwark subway.

Succession, a term used technically in Roman and Scots law (but not in English law) to denote the taking of property by one person in place of another. The order of succession in Roman and Scots law differs in several respects from that in English law. See HEIR, KIN (NEXT OF), EXECUTOR, HUSBAND AND WIFE, LEGITIM. For legacy and succession duties, see LEGACY and the almanac. For APOSTOLICAL SUCCESSION, see under that heading.

Succession Acts. From a comparatively early period in English history parliament occasionally exercised the power of limiting or modifying the hereditary succession to the throne. The first instance of such interference occurred in the case of Henry IV.; and parliamentary interposition was subsequently exercised in the case of Henry VII. and in regard to the immediate successors of Henry VIII. The respective rights of James I., Charles I., and Charles II. were acknowledged by parliament. The revolution of 1688 was founded on the so-called abdication of the government by James II. The Convention bestowed the crown on William and Mary for life, and regulated the claims of Anne. In view of the impending extinction of the Protestant descendants of Charles I. the crown was settled by 12 and 13 Will. III. chap. 2, in the event of the death of William and Anne without issue, on the next Protestant line, according to the regular order of succession—viz. the descendants of the Electress Sophia of Hanover, granddaughter of James I.; and it was at the same time enacted that whoever should hereafter come to possession of the crown should join the communion of the Church of England as by law established (see GEORGE I., HANOVER). This is the latest parliamentary limitation of the crown; but the right of parliament to limit the succession was secured by 6 Anne, chap. 7.

Succession Wars is the general name given to contests which took place in Europe during the 18th century on the extinction of certain dynasties or ruling houses. Four such wars are usually enumerated—that of the Spanish succession (1701–13), of the Polish succession (1733–38), of the Austrian succession (1740–48), and of the Bavarian succession (1777–79). The first and third alone are of sufficient general historical interest to be noticed here.

(1) **WAR OF THE SPANISH SUCCESSION.** Charles II., king of Spain, having died without direct descendants in November 1700, claims were raised to the vacant throne by the husbands of his two sisters, Louis XIV. of France, who had married the elder, and the Emperor Leopold I., who had married the younger. Both these monarchs were also themselves grandsons of Philip III. of Spain; but neither desired the Spanish crown for his own head. Louis put forward his grandson Philip of Anjou; whilst Leopold advocated the claims of his second son, the Archduke Charles. The Electoral prince Joseph of Bavaria, grandson of the Emperor Leopold, was the heir originally designated in King Charles's will, but he died in the beginning of 1699. Both Louis XIV. and his wife had nine years before solemnly renounced the crown of Spain for themselves and their heirs; nevertheless, after Joseph of Bavaria died the agent of Louis XIV. induced Charles of Spain to nominate Philip of Anjou as his successor. Three months after the Spanish monarch's death the French prince entered Madrid,

and was crowned as Philip V.; and his accession was at first recognised by all the European powers except the emperor. Louis, however, soon provoked the United Netherlands and England, and they joined Austria for the purpose of armed opposition to France.

Hostilities were begun by Prince Eugene in Italy in 1701; and in the following year the conflict raged not only in Italy but also in the Netherlands and in Swabia. At first the allies were victorious all along the line: Marlborough took the fortresses on the Meuse and overran the electorate of Cologne; and the Landgrave of Baden had the good fortune to drive back the most redoubtable of the French commanders, Villars, who had crossed the Rhine from Alsace. But the aspect of things was altered in 1703 by Villars, who, in conjunction with the Elector of Bavaria, penetrated as far as Tyrol and captured Passau, whilst the imperialists in Italy were more than held in check by Vendôme. But in the campaign of 1704 Marlborough and Eugene, acting in concert, inflicted a crushing defeat upon their opponents at Blenheim (q.v.) and drove them back into France. Two years later the forces of Louis were compelled to withdraw from the Netherlands owing to Marlborough's great victory of Ramillies and his capture of the principal Flemish towns. At the same time Eugene and his relative the Duke of Savoy routed the French near Turin and swept them out of North Italy. Meanwhile the war had extended to the Iberian peninsula. The king of Portugal declared for the allies, and Archduke Charles made himself master of Catalonia, and even for a time held possession of Madrid. The English captured Gibraltar in 1704; but they and the Portuguese sustained a severe defeat from the Duke of Berwick (commanding the French forces) at Almanza in 1707. In this latter year Louis, feeling the severity of the strain, opened negotiations for a settlement. But the allies, having the upper hand, thought to humble him yet more, and the war went on.

An attempt of Vendôme and the Duke of Burgundy to reconquer the Spanish Netherlands in 1708 was frustrated by Marlborough and Eugene, who routed them at Oudenarde; and in the next year they defeated at Malplaquet the hitherto invincible Villars. Yet just when the fortunes of Louis seemed to be at their worst, circumstances intervened in his favour. In England the Whigs were supplanted by the Tories, who voted for peace; and in Austria the Emperor Leopold died, and was succeeded by the Archduke Charles. Accordingly the war languished, and Philip V. having pledged himself that the crowns of Spain and France should not be united, all the allies, except the emperor, signed the treaty of Utrecht (q.v.) on 11th April 1713. The emperor, too, was brought to terms after Villars had overrun the Palatinate and Baden, and he signed peace at Rastatt (7th March 1714), whereby he acknowledged Philip as king of Spain, and became himself the ruler of the Spanish Netherlands, Naples, Milan, and Sardinia.

See Mahon, *History of the War of the Succession in Spain* (1832); Colonel the Hon. Arthur Parnell, *The War of Succession in Spain* (1888); Courcy, *La Coalition de 1701 contre la France* (2 vols. Paris, 1886); Von Noorden, *Der Spanische Erbfolgekrieg* (3 vols. Düsseldorf, 1870–82); Arneht, *Prinz Eugen von Savoyen* (3 vols. Vienna, 1858); and the articles EUGENE, MARLBOROUGH, PETERBOROUGH, VILLARS, &c. in this work.

(2) **WAR OF THE AUSTRIAN SUCCESSION.** The Emperor Charles VI. died in 1740, leaving his hereditary dominions—Bohemia, Hungary, and the archduchy of Austria—to his daughter Maria Theresa. She was at once beset by enemies, eager to profit from the presumed weakness of a feminine ruler. The Elector Charles Albert of Bavaria, who

had refused his signature to the Pragmatic Sanction (q.v.), demanded the imperial crown as the descendant of the Emperor Ferdinand I., and he was backed up by France and Spain. Augustus of Saxony and Poland advanced his claim as being the husband of the eldest daughter of the Emperor Joseph I. Frederick the Great of Prussia seized the opportunity to wrest Silesia, which he greatly coveted, from the crown of Austria. The Bavarians and the French (under Belleisle) invaded Bohemia, and crowned the elector king of that country at Prague on 19th December 1741. About two months later he assumed the imperial crown at Frankfort-on-Main; yet on the very next day his own capital (Munich) was occupied by the Austrian general Khevenhüller, who, assisted by the high-spirited Hungarians, had advanced up the Danube, and now speedily overran Bavaria. A few months later the empress-queen bought off her most dangerous antagonist, Frederick, by giving up to him Silesia. At this time, too, Augustus of Saxony, who had at first made common cause with the French and the Bavarians, withdrew from the contest and made peace with Maria Theresa. In the end of 1742 the Austrians were forced out of Bavaria and the French evacuated Bohemia. The English, who from the first paid a substantial subsidy to Austria, took up arms on her behalf in this same year, and in 1743 defeated the French at Dettingen in Bavaria. In this year the Austrians repossessed themselves of the Elector Charles Albert's dominions. Saxony now joined the allies and took the field against his former associates. On the other hand, Frederick renewed hostilities and invaded Bohemia; but after a short interval he was once more willing to make peace. About this juncture Charles Albert died, and his son and successor abandoned his father's pretensions to Maria Theresa's dominions. This left France to carry on the struggle alone. But whilst Austria had the better of the war in Italy, Marshal Saxe captured several of the Flemish fortresses, won the victories of Fontenoy (1745), Rocoux (1746), and Lawfeldt (1747), and reduced the Austrian (formerly Spanish) Netherlands. Peace was at length concluded at Aix-la-Chapelle on 18th October 1748, things remaining pretty much *in statu quo*, except that Frederick was allowed to retain Silesia.

See Arnoeth, *Geschichte Maria Theresias* (10 vols. Vienna, 1863-79); and MARIA THERESA, SAXE, &c.

Succinic Acid derives its name from its having been originally found in amber (Lat. *succinum*). Succinic acid occurs as a natural constituent not only in amber, but also in the resins of many of the pine tribe, in the leaves of the lettuce and wormwood; and in the animal kingdom it has been detected in the fluids of hydatid cysts and hydrocele, in the parenchymatous juices of the thymus gland of the calf, and of the pancreas and thyroid gland of the ox. Succinic acid is convertible into tartaric acid, and conversely.

Succory. See CHICORY.

Succoth. See PITHOM.

Succubus. See DEMONOLOGY.

Succulent Plants, a descriptive phrase applied to the Crasulaceæ, Cactaceæ, Euphorbiaceæ, Mesembryaceæ, some Liliaceæ, &c.

Suchet, LOUIS-GABRIEL, Duc d'Albufera, and marshal of France, was born, son of a silk manufacturer, at Lyons, 2d March 1770. At twenty-two he volunteered into the cavalry of the Lyons national guard, next fought in Italy, and by his conspicuous courage and ability at Lodi, Rivoli, Castiglione, Arcola, and a hundred battles, had risen by 1798 to be general of brigade. He added to his reputation in Egypt and again in Italy, served as general

of division under Joubert in 1799, and the year after was second in command to Masséna. He covered himself with glory by checking a vastly superior Austrian force under Melas (1800), and so preventing the invasion of the south of France. He took a distinguished part in the campaigns against Austria (1805) and Prussia (1806), and was subsequently (April 1809) appointed generalissimo of the French army in Aragon—his first independent command. By marvellous tact no less than military skill he reduced this stubborn province to complete submission within two years. He conquered at Mavia and Lerida, and took Tortosa and Tarragona, for which he was rewarded with a marshal's baton. In 1812 he destroyed the army of Blake at Sagunto, and on the 9th January of that year captured Valencia, earning the title of Duke of Albufera. The details of his five Spanish campaigns have been well given by him in his *Mémoires sur ses Campagnes en Espagne* (2 vols. Paris, 1829-34). He was created a peer of France by Louis XVIII, but joined Napoleon after his return from Elba, and was charged with the defence of the south-west frontier. Deprived of his peerage after the disaster of Waterloo, he did not return to court till it was restored in 1819. He died at the château of Saint-Joseph, near Marseilles, 3d January 1826. O'Meara and Las Cases tell us that of his generals Napoleon ranked Masséna first and Suchet second.

Sucking-fish, a name sometimes given to the Remora (q.v.) or Echeneis, which has a dorsal sucker, and to other fishes which have a sucker formed by the union of the ventral fins—e.g. *Cyclopterus lumpus*, the Lump sucker (q.v.). To the members of the carp-like Catostomidæ, almost exclusively confined to the rivers of North America, the name sucker is also applied, in allusion to their mode of sucking up their food, which consists of small aquatic animals.

Suckling, SIR JOHN, poet, was born at Whittington in Middlesex, and baptised February 10, 1609. He was of good family on both sides, and his maternal uncle, Sir Lionel Cranfield, became Earl of Middlesex; his father held office as a secretary of state and comptroller of the household under James I, and was made privy-councillor by Charles I. Suckling may have been at Westminster, as Aubrey says, but certain it is that in 1623 he entered Trinity College, Cambridge, five years later went on his travels abroad, and served for some time in Germany under Gustavus Adolphus. He returned about 1632, and soon became 'the darling of the court,' distinguished before all by his wit and prodigality. An inveterate gambler, he spent his days and nights at cards and bowls, his intervals divided betwixt gallantry and verse-making. In April 1635 he appeared before the Star-chamber for breaking the statute passed in the eighth year of Charles to require all landowners to spend some time on their estates. To aid the king against the Scots he raised a troop of 100 horse, and equipped them so handsomely that it is said to have cost him about £12,000. They rode north with the king, but shared the shame of the rout before the Scots at Duns. The lampoon by Sir John Mennes has commemorated the cowardice of Suckling and his gay cavaliers, but in reality they behaved no worse than the rest of the royal army. Suckling was returned to the Long Parliament for Brander, joined in the abortive plot to rescue Strafford from the Tower, and in more desperate plots still against the liberties of the kingdom by means of French and Irish troops, and his schemes being discovered he fled for safety to the Continent. Impoverished and disgraced, it is almost certain that he poisoned

himself at Paris before the close of 1642. The works of Suckling consist of four plays, *Aglaura*, *The Goblins*, *Brennoralt*, and *The Sad One*, now utterly forgotten; a prose treatise entitled *An Account of Religion by Reason*; a few *Letters*, written in an artificial style; and a series of miscellaneous poems, beginning with *A Sessions of the Poets*, published in 1637, which is original in style, and happily descriptive of the author's contemporaries. But the fame of Suckling rests on his songs and ballads, which at their best are inimitable for ease, gaiety, and grace. The well-known *Ballad upon a Wedding* is an exquisite masterpiece of sparkling gaiety and felicity of phrase; and his lyrics 'I prithee send me back my heart,' 'Why so pale and wan, fond lover?' are amongst the triumphs of English verse.

See the Rev. Alfred Suckling's *Selections, with a Life* (1836), reproduced by W. C. Hazlitt, with the addition of a few gross poems and portions of poems, poor beyond most of their kind (2 vols. 1874); also the Memoir prefixed to F. A. Stokes's edition (New York, 1885).

Sucre. See CHUQUISACA.

Sucrose. See SUGAR.

Sudamina, or MILIARY ERUPTION, one of the vesicular diseases of the skin, is associated with profuse sweating, though it occasionally occurs in a dry skin; the second name refers to the size of the vesicles, which do not exceed those of a millet-seed. The vesicles are most abundant on the neck and trunk, and are sometimes attended with itching. They almost always occur in association with febrile disorders, particularly acute Rheumatism (q.v.), which, however, do not seem in any way modified by them. They give rise to little irritation, and are of no particular importance.

Sudan. See SOUDAN.

Sudbury, a municipal borough (till 1843 also parliamentary) of Suffolk, on the Stour at the Essex boundary, 16 miles S. of Bury St Edmunds and 58 NE. of London. It has three old churches, mainly Perpendicular in style, a town-hall (1828), grammar-school (1491; rebuilt 1857), corn exchange (1841), and manufactures of cocoa-nut matting, silk, bricks, &c.—the famous woollen industry of the Flemings, dating from the 14th century, having died out. Simon Theobald, Archbishop of Canterbury, beheaded by Tyler in 1381, and Gainsborough were natives. Pop. (1851) 6043; (1891) 7059.

Sudbury, a village of Ontario (pop. 800), by rail 443 miles W. by N. of Montreal and 179 NE. of Sault Ste Marie. It is notable for the immense deposits of copper and nickel close by. Two short branch-lines connect Sudbury and the mines, and smelting-furnaces reduce the ores on the spot.

Sudermann, HERMANN, poet and novelist, was born 30th September 1857 at Matzicken in East Prussia, studied at Königsberg and Berlin, and while acting as domestic tutor, and as editor of a small newspaper, produced tales, tragedies, and poems that were unheeded. But the drama *Ehre*, on somewhat realistic lines, was produced in 1888, and made him famous; and his novels, *Frau Sorge* (1888; Eng. trans. *Dame Care*, 1892), *Der Katzensteg* (1889; trans. *Regina*, 1898), *Im Zwielflicht*, *Iolanthes Hochzeit* (1892), *Es War* (1894), have been widely read. The censor forbade the representation of the tragedy *Sodom's Ende* (1890). Other dramas were *Heimat* (1893; trans. *Magda*, 1895), *Die Schmetterlingschlacht* (1896), *Das Glück im Winkel* (1896), *Moriturus* (1896).

Sudetic Mountains, in SE. Germany, divide Prussian Silesia and Lusatia from Bohemia and Moravia, and connect the Carpathians with the mountains of Franconia. They do not form a continuous chain except in the middle, in the Riesengebirge (q.v.) and Isergebirge.

Sudorifics, or DIAPHORETICS, remedies to excite the secretions of the skin. The simplest of all diaphoretics are baths, which may be warm baths of water or of vapour, either simple or medicated (see BATH). The most powerful of all, however, as regards educing perspiration is probably the Turkish bath, which consists essentially in the use of a sweating process by means of air heated to a temperature of 140°, or even more. The following remedies, used internally, are powerful diaphoretics: antimony, ipecacuanha, opium (these three either singly or in combination); ammonia, and the carbonate or acetate of ammonia (spirit of mindererus), guaiacum, dulcamara, and sassafras; and, most active of all, pilocarpine, the chief active principle of *Jaborandi*. On most of these substances special articles will be found. A favourite formula is Dover's Powder (q.v.), consisting of a grain of opium, and a grain of ipecacuanha in each ten grains of the powder. This in doses of from five to eight grains, followed by warm drinks and plenty of blankets in bed, usually produces copious perspiration, and is very soothing and useful in many commencing inflammatory and febrile complaints. James's powder (antimonial), in doses of from three to five grains, is often added to the above in domestic prescriptions; but neither of these medicines should be used rashly, as in certain states of the system they may prove dangerous; and they should never be given to very young children.

Sûdra. See CASTE.

Sudreys, or SUDOREYS. See MAN (ISLE OF).

Sue, MARIE-JOSEPH-EUGENE, a master of melodramatic fiction, was born at Paris, 10th December 1804. The son of an army surgeon, he himself served as such in Spain and at Navarino, and worked up his experiences into the Byronic and absurd novels, *Kernock le Pirate*, *La Salamandre*, &c., as well as the unhistorical *Histoire de la Marine Française* (5 vols. 1835-37) and *Histoire de la Marine Militaire chez tous les Peuples* (1841). In 1829 his father died leaving him a handsome fortune, which enabled him to give himself seriously to literature. His first hit was the too famous *Mystères de Paris* (10 vols. 1842), which first appeared in the columns of the *Journal des Débats*. Its successor, *Le Juif Errant*, which appeared in the *Constitutionnel* (10 vols. 1845), was no less successful. Later works were *Martin*, *l'Enfant Trouvé* (12 vols. 1846), *Les Sept Péchés Capiteux* (16 vols. 1847-49), and *Les Mystères du Peuple* (16 vols. 1849), the last condemned by the law-courts of Paris as immoral and seditious. Sue was elected deputy for Seine in 1850, and attached himself to the Extreme Left. The *coup d'état* of December 1852 drove him into exile. He lived at Annecy in Savoy, and there died 3d August 1859.

Sue was often grouped with his contemporary Dumas, but is far his inferior in breadth, humanity, and interest generally. But he possesses undeniably the power of holding a reader fast in his story, and if his novels are never re-read and soon forgotten, at least they are read once in a fever of curiosity. Unfortunately their author was nothing of an artist, so that they possess as little excellence in form as in substance. Indeed these novels are hardly to be taken seriously as works of art, yet they have the vitality that ever belongs to a group of strong situations, however improbable. As for the unhealthy thread that runs throughout, that is nowadays no disqualification far beyond the bounds of France.

Suet is a variety of solid fatty tissue, which accumulates in considerable quantity about the kidneys and the omentum of several domestic animals, especially the ox and sheep. Beef suet

is extensively used in cookery, while purified mutton suet under the name of *Sevum Præparatum* occurs in the Pharmacopœia, and is obtained by melting and straining the internal abdominal fat. It consists of a mixture of the ordinary animal fats, with a great preponderance of the most solid of them—viz. stearin, which constitutes about three-fourths of the whole. The pure suet of the Pharmacopœia is 'white, soft, smooth, almost scentless; and is fusible at 103° (39.4° C.)' It is used as an ingredient in plasters and ointments. Ordinary melted suet is frequently employed in the same manner as lard, to preserve potted meats, fish, &c. from the action of the air. See FATS.

Suetonius. CAIUS SUETONIUS TRANQUILLUS, grammarian, critic, and chronicler, was contemporary with Domitian, Trajan, and Hadrian, having been born (birthplace and parentage unknown) under Vespasian. Of his manhood we find some traces in the letters of the younger Pliny, who, when appointed by Trajan proconsul of Bithynia, took Suetonius with him. Pliny's friendship, manifested in bringing him under the emperor's notice as 'probitissimus, honestissimus, eruditissimus virum,' procured him means and leisure enough for literature, of which he was a professed votary. After Pliny's death he was befriended by C. Septicius Clarus, prefect of the prætorians, to whom he dedicated his best-known work, in eight books, *The Lives of the First Twelve Cæsars*. He became Hadrian's private secretary, a post he long held till, compromised in a court intrigue, he forfeited it, to devote himself entirely to literature. He was then about fifty years of age, but no further incident of his life is known to us.

In the compilation of his *Lives* Suetonius must have had before him the *Annals* and *Histories* of Tacitus; perhaps (according to some scholars) the *Lives* of Plutarch. But he has neither the dramatic power of the Roman nor the philosophy of the Greek. The Augustan historian Vopiscus praises him as 'most finished and impartial writer' (*emendatissimus et candidissimus scriptor*)—merits which later criticism still allows him. His method, indeed, is of the simplest. After detailing the emperor's family history, he describes his youth and manhood till he assumes the purple; after this he abandons the chronological order and dwells on the character of his subject, as shown in public and private, according to virtues and vices, irrespective of periods of life; next he reverts to the order of time in relating the portents of death, the mode of death itself, and the terms of the emperor's will. Ever anxious to exclude uncertainty from his narrative, he deals with ascertained fact and does nothing by interposed discussion to bias the reader's judgment one way or another. With no affectation of epigram, his brevity is masterly, and probably no writer ever compressed so much that is interesting into so brief a space. He had many imitators (St Jerome among them) in antiquity and in the middle ages. His other works, *De Illustribus Grammaticis* (of which a complete copy existed in the 15th century) and *De Claris Rhetoribus*, need only be mentioned here, as also the fragmentary lives of Terence, Horace, Persius, Lucan, Juvenal, and Pliny.

British scholarship has done nothing for the text or exegesis of Suetonius. After the *editio princeps* (Rome, 1470), the best are those of Casaubon (1596) and 1610), F. A. Wolf (1802), Roth, with admirable prolegomena (1857), and Reifferscheid (1860). See also D. Ruhnken's *Scholæ* (Leyd. 1888). Of translations those of Adolf Stahr in German (1864) and of Rigutini in Italian (1882, with Roth's text) are among the best. That in Bohn's Classical Library is fair. For Suetonius Paulinus, the Roman governor of Britain, see BOADICÆA.

Suevi. See SWABIA.

Suez, a town of Egypt, is situated at the southern extremity of the Suez Canal and on the Gulf of Suez, a northern arm of the Red Sea. Close beside the town the Peninsular and Oriental Steamship Company have extensive storehouses and magazines, there is a large English hospital, and the sweet-water canal from Ismailia terminates here. The railway from Ismailia runs through the town on to the spacious harbour 2 miles beyond. The streets are generally neglected and uneven, and by night unlighted. Suez has not a very large trade of its own (£800,000 to £900,000 annually); most of the commerce passes through it without making halt. Pop. (1890) 13,000. The town is surrounded by the desert. At more than one period in the past this place was the seat of a flourishing trade, as for instance in the time of the Ptolemies, when it was called Arsinoe; under the first Moslem rulers of Egypt, who called it Kolzum, the Greek name being then Clysmā; and from the 16th to the 18th century, when it formed an important *étape* in the European trade with India; but by the beginning of the 19th century it was again quite decayed. It began to revive when the overland mail route between England and India was opened in 1837, and has improved yet more since the completion of the canal.

SUEZ CANAL.—The ancient Egyptian king, Rameses II., seems to have been the first to excavate a canal between the Nile delta and the Red Sea. This, having been allowed to fill up and become disused, was reopened by Darius I. of Persia. It was once more cleared and made serviceable for the passage of boats by the Arab conquerors of Egypt. The plan of connecting the Mediterranean and the Red Sea by means of a canal wide enough to admit of the passage of ocean-going vessels caught the attention of Napoleon, and he commissioned the engineer Lepère in 1798 to examine and report to him as to the practicability of the idea. This expert's opinion, which was *de facto* erroneous, that the surface of the Red Sea was nearly 30 feet higher than that of the Mediterranean, put an end to the project. But the mistake having been corrected by English officers in 1841, the French diplomat Lesseps (q. v.) set himself (in 1849) to study the isthmus more thoroughly, and in 1854 he managed to enlist the interest of Saïd Pasha, khedive of Egypt, in his scheme. Two years later the Porte granted its permission and the Universal Company of the Maritime Suez Canal was formed, receiving important concessions from the ruler of Egypt. Half the capital was raised by public subscription in Europe, chiefly in France; the other half was contributed by the khedive. The first spadeful of earth was turned at Port Saïd, the Mediterranean terminus of the canal, on 25th April 1859. Soon from 25,000 to 30,000 men were at work excavating. But in 1862 progress was greatly delayed owing to the necessity of first completing the canal that was to bring drinking-water from the Nile to Ismailia, near the middle point of the isthmus, and thence carry it southwards to Suez on the Red Sea; moreover the new viceroy, Ismail, refused to ratify the concessions that had been made to the company; it was, however, agreed to let him buy them back for the sum of £3,800,000. This hindrance being removed, the work went on again; and at length, on 16th November 1869, the canal was duly opened for vessels. It had cost altogether about 20 million pounds. The total length is 100 miles; the width of the water-surface was at first 150 to 300 feet, the width at the bottom 72 feet, and the minimum depth 26 feet. At Port Saïd two strong breakwaters, 6940 and 6020 feet long respectively, were run out into the Mediterranean; at Suez another

substantial mole was constructed. The making of the canal was facilitated by the existence of three or four valleys or depressions (formerly lakes), which, when the water reached them, became converted into lakes. Immediately south of Port

Both in respect of tonnage and of the number of vessels Great Britain greatly exceeds all other nations put together; in 1896, 2162 of the vessels were British, their tonnage reaching the aggregate of 8,057,706 tons. Since 1886 the time of making the transit through the canal has been greatly accelerated. In that year a vessel took on an average thirty-six hours to get through; but in 1898 the average time of passage was fifteen hours thirty-six minutes. Moreover, since 1st March 1887 the electric light has been used to light the way during the night. The first year that this adjunct was in operation it was used by 395 vessels out of 3137; in the year 1896, 3217 out of 3409 used it. The cost of getting through by electric light amounts to about £10 for each vessel. Besides 100,000 founders' shares, the original capital of the company consisted of 400,000 shares of £20 each, making a sum total of £8,000,000. Of these shares 176,602, which belonged to the khedive, were purchased from him by Beaconsfield for the British government in 1875 for the sum of £3,976,582, although he had mortgaged the interest on them up to the year 1894. Since the formation of the company additional obligations have been incurred to the amount of £8,110,567. All net earnings that remain after 5 per cent. interest has been paid are divided in the following proportions: 71 per cent. as dividend to the shareholders, 15 per cent. to the khedive, 10 per cent. to the holders of founders' shares, 2 per cent. to the managing directors, and 2 per cent. to the company's employees. In 1898 the net profits thus divided amounted to £1,600,923. The widening of the canal is being carried out.

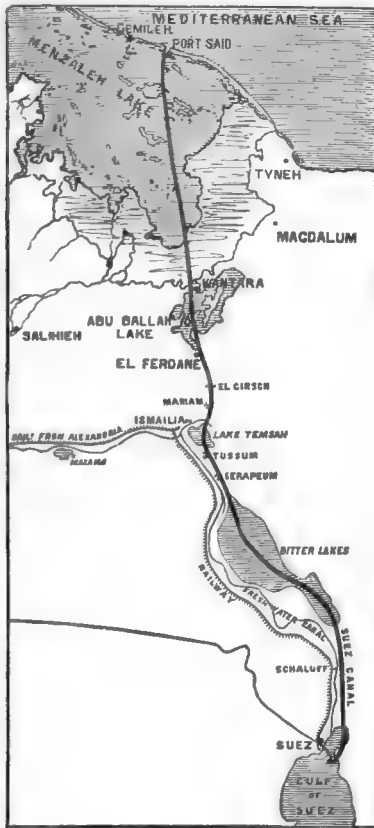

Map of Suez Canal.

Said the canal crosses Lake Menzaleh (28 miles long); and three more—Lake Ballah, Lake Timsah (5 miles long), and the Bitter Lakes (23 miles)—are traversed to the south of it. The highest point or elevation that was cut through does not exceed 50 feet above sea-level. At intervals of 5 or 6 miles 'sidings' or side-basins are provided to enable vessels to pass one another. At the end of a dozen years the traffic had increased so enormously that a second canal began to be talked about; and in 1886 the task of widening, and also deepening, the existing canal was commenced. By 1890 the canal had been deepened to 28 feet, and widened between Port Said and the Bitter Lakes to 144 feet, and from the Bitter Lakes to Suez to 213 feet.

The increasing use of screw-propellers in steam-vessels, with the enormous shortening of sea-voyages to India, China, and Australia effected by the canal, rapidly increased the tonnage of vessels using this route. The subjoined table gives the salient particulars:

Year.	No. of Vessels.	Gross Tonnage.	Receipts.
1870	486	654,915	£206,373
1875	1264	2,423,672	994,375
1880	2025	4,844,519	1,629,577
1885	3624	8,985,411	2,488,297
1890	3389	9,749,129	2,680,486
1895	3434	11,838,687	8,124,149
1898	2986	7,989,878	8,024,280

See F. de Lesseps, *Le Canal de Suez* (Paris, 1875), and *Lettres, Journal, et Documents à l'Histoire du Canal de Suez* (5 vols. Paris, 1881); *Journal of the Statistical Society* (June 1887); *Suez Canal, Returns of Shipping and Tonnage, 1888-91* (Lond. 1891); D. A. Cameron, *Egypt in the Nineteenth Century* (1898); and other recent books on Egypt (q.v.).

Suffioni, name given to the exhalations of hot sulphurous vapours, which are common in volcanic regions. See VOLCANOES.

Suffocation. See ASPHYXIA, RESPIRATION, STRANGULATION.

Suffolk, the easternmost county of England, is bounded on the N. by Norfolk, E. by the German Ocean, S. by Essex, and W. by Cambridgeshire. In length from east to west it measures 57 miles, and the mean breadth from north to south is about 30 miles. Area, 1475 sq. m.; pop. (1801) 210,431; (1831) 296,317; (1861) 337,070; (1891) 371,235. Though no hills of any notable character rise within its confines, Suffolk is not by any means flat. Bordering on the seacoast, it is low and skirted by banks of shingle, except near Lowestoft and Southwold, and again at Dunwich and Felixstowe, which all rest on sandstone cliffs; adjoining and running parallel with these last stretches an almost continuous series of light sandy heath-lands, glorious in summer with gorse and heather; and inland the country is undulating, well watered, and for the most part well wooded, the scenery in places—e.g. at Yoxford, aptly called the garden of Suffolk, and in the vale of the Gipping—being very picturesque. More than two-thirds of the county consists of heavy land, a stiff clay prevailing in Mid (or as it is locally termed 'High') Suffolk, whilst the western part lies upon chalk, terminating at its north-west corner with a tract of peaty fen-land. The Waveney, Alde, Deben, Orwell, and Stour, all flowing eastwards, are the principal rivers; with the exception of one branch-line, the railways are all worked by the Great Eastern Company. The Suffolk crag, or white crag, is one of the divisions of the British Pliocene System

(q.v.); and Coprolites (q.v.) are raised in the region between Ipswich and Woodbridge, gunflints at Brandon. Agriculture, despite the depression of late years, still forms the staple industry, 780,000 acres being under cultivation. A red polled breed of cattle, of which the cows are deservedly held in high esteem, is peculiar to the county; and its pigs, some black and others white, are also widely known. Horse-breeding too, apart from the racing establishments at Newmarket, is a specialty, a large export trade being carried on in both riding and cart horses; and immense quantities of lambs—blackfaced, and a cross between the Norfolk-horned and the Southdown—are raised. The manufactures are noticed under Ipswich (the capital), Beccles, Stowmarket, and Sudbury, these being, with Bury St Edmunds, Lowestoft, and Woodbridge, the most important towns. Containing 21 hundreds and 517 civil parishes in the dioceses of Norwich and Ely, its parliamentary divisions are five in number, each returning one member, and it has two county councils, one for the eastern and the other for the western district. The assizes are held alternately at Ipswich and Bury St Edmunds.

The history of Suffolk, presumably from its lying somewhat off the beaten track, presents but few facts deserving of special mention; prior to the Conquest it was in common with the rest of East Anglia (of which it formed part) oftentimes overrun and pillaged by the Norsemen, whilst of incidents of later date it will suffice to mention the descent of Flemish mercenaries under the Earl of Leicester in 1173 in support of the claims of Henry II.'s eldest son, culminating in their defeat at Fornham, near Bury St Edmunds; and the sea-fights off Lowestoft (1665) and Southwold (1671). In antiquities the county is especially rich, and amongst them may be noted the ruins of the castles of Burgh (Roman), Framlingham, Orford, and Wingfield (the last the place of Charles d'Orleans' imprisonment); the gatehouse of Butley Priory (Norman); earthworks at Fornham, Haughley, Nacton, and Snape; the fine flint-work churches scattered throughout the county, of which perhaps the best examples are those of Blythburgh, Lavenham, Melford, Southwold, Stoke-by-Nayland, and Walberswick; and the old halls (many of them moated) of Helmingham, Parham, Hengrave, Rushbrooke, Ickworth, Somerleyton, Giffords, and West Stow. Of Suffolk worthies (exclusive of those named under Ipswich and Bury St Edmunds) the best known are Bishops Gosseteste, Aungerville, and Bale; Archbishop Sancroft; Chief-justices Glanvill and Cavendish; George Cavendish (Wolsey's biographer); Nash, Crabbe, and Robert Bloomfield (poets); Sir Simonds D'Ewes; the Earl of Arlington, Roger North, Capell (the Shakespeare commentator); Gainsborough, Frost, Constable, and Bright (artists); Bunbury (the caricaturist), Edwards (the etcher), Woolner (the sculptor), Lord Chancellor Thurlow, Arthur Young, Clara Reeve, Mrs Inchbald, Kirby (the naturalist), John Hookham Frere, Crabb Robinson, Sir Philip Broke, William Johnson Fox, Professor John Austin and his brother Charles, Admirals Fitzroy and Rous, Dr Routh, Professors Maurice and Cowell, Edward Fitzgerald, Sir J. D. Hooker, Sir Henry Thompson, Agnes Strickland, and Miss Betham Edwards.

See works by Kirby (2d ed. 1764), Callum (1813), Gage (1838), Page (1844), Suckling (2 vols. 1846-48), Glyde (1858 and 1866), Baynes (2 vols. 1873), Taylor (1887), White (new ed. 1891), Raven (1896); *Excursions in the County of Suffolk* (2 vols. 1818-19); and an article in the *Quarterly* for April 1887.

Suffragan (Lat., 'assistant'), in England a coadjutor-bishop appointed to assist a bishop in the

administration of some part of his see: such bishops cannot succeed to the see in which they have been suffragans. The name also, and originally, belongs to all bishops in a province, as expressing their relation of subordination to the metropolitan.

Suffrage. See PARLIAMENT, REFORM.

Suffren. Pierre André de Suffren Saint-Tropès, a French naval hero, was born a younger son of a good Provence family, July 17, 1729. At fourteen he entered the navy, and first saw fire in the indecisive action with the English off Toulon in 1744. He took part in the unsuccessful attempt to recapture Cape Breton (1746), was captured by Hawke in the Bay of Biscay the next year, but soon exchanged, and after the peace went to Malta and served for six years amongst the Knights Hospitallers. Again in the French service, he took part in the action off Minorca (May 1756), was again captured in Boscawen's destruction of the Toulon fleet (1759), after the peace of 1763 cruised in the Mediterranean for the protection of trade, and took part in the bombardment of Salées in 1765. Commander in 1767, he served four years in the service of Malta, and returned to France to the rank of captain in 1772. Early in 1777 he sailed to America, and his ship began the indecisive battle of Grenada on 6th July 1779. He next served with the allied fleet blockading Gibraltar, and early in 1781 was placed in command of a squadron of five ships for service in the East Indies. After an action at the Cape Verd Islands, he outsailed Commodore Johnstone to the Cape, and so saved the colony for the time. Sailing to Madras, he fought a hard but indecisive battle off Sadras, and soon after, in a bloody two days' battle off Providien on the coast of Ceylon, proved himself a consummate master of naval tactics. But he had to struggle against scurvy, want of supplies, and, still worse, the disaffection and cowardice of his senior officers. Having captured Trincomalee, he two days later stood out of the harbour with fifteen ships against the English twelve, and fought a hard but irregular battle. His last fight (June 1783) was also indecisive. Suffren arrived in Paris early in 1784, and was received with the greatest honours, and created vice-admiral of France. He died suddenly at Paris, 8th December 1788, most probably of apoplexy, to which his extreme corpulence made him subject. Frenchmen give the Bailli de Suffren (he had been made Bailli of the Order of Malta) the most exaggerated praises, and Professor Laughton styles him 'one of the most dangerous enemies the English fleets have ever met, and without exception the most illustrious officer that has ever held command in the French navy.' See Laughton's *Studies in Naval History* (1887).

Sufism, a form of mysticism within Islam. The Koran is unfavourable to mysticism, for it tells of a God perfectly distinct from the world and from the souls of men, who has decreed from all eternity the lot of every person, and who is to be pleased with outward rites and conduct. Sufic mysticism has come into Islam through Persia, where, under the influence of Indian Buddhism, its pantheistic ideas existed before the Mohammedan conquest. Sufis claim as their founder the woman Râbia, whose grave on a hill east from Jerusalem drew many pilgrims in the middle ages. But that distinction rather belongs to Abû Saïd ibn Abi-l-Chair, a Persian of Khorassan, who, notwithstanding the saying of Mohammed that there is no monkery in Islam, founded a monastery about 815. His followers were called Sufis or Woollers from their ascetic garb. A contemplative life soon naturally sought in Pantheism that rest for the heart which it could not find in the distant, unsym-

pathetic God of Islam. Thereafter Sufism divided itself. Some with the Persian Bestāmī, who died in 875, professed openly that man is God. Others with Jonaid, who died in 909, a Persian too, though born in Bagdad, were of like faith, but cautious and orthodox in their language. The favourite watchword of Islam, the Unity of God, meant with them that God is all. The object of all Sufism was to deliver the soul from the sway of the passions by destroying human nature and the power of the flesh, and so to make the soul merely spiritual, uniting it by love with God, from whom it had emanated as a ray emanates from the sun. Cautious Sūfīs were often revered as saints, while sometimes the incautious became martyrs. Many, like Jonaid's pupil Hallāj, who was executed by Hāmīd, the vizier of the calif Al-Mōqtadir, at Bagdad in 922, were alternately adored and persecuted. In Sufism the devotee must choose a teacher, and strive toward development through degrees, of which there are commonly reckoned three. First is the Law, wherein the Sūfī is merely a Muslim, blameless in all ordinances of morality and of Islam; but the only motive to worship or obedience is not fear of punishment nor hope of reward, but love. Second is the Way or Method, wherein he practises asceticism, fasts, watches in silence and solitude, studies Sufistic lore, drives away other thought, rises into an occasional ecstatic state, Hāl, which when permanent is called a position, Makām. Positive religion, needful for the weak, is now needless for him. The final degree is Certainty; the transcendental objective God has now become subjective; the Sūfī is now consciously God; all religion is vain. The first great Sūfī poet was the Persian Ferīd eddīn Attar, who died c. 1220. The greatest Sūfī poet was another Persian, Jelāl eddīn Rūmī (1207-73). But Sufism, the dream of the least and the most cultured alike, has been the religion of Hāfiz and Sādi and of nearly all the great Persian poets. Their luscious language of love and beauty's charms, of intoxication and the wine-house, is strongly sensual or spiritual according as it is taken. Of the Sufiides, who reigned over Persia from 1499 to 1736, the first was Ismael the Sūfī. In 1777 a famous Sūfī, Mīr Maḩmūd Ali Shah, came from India to Shirāz, and raised a great Sūfī fervour, against which a very severe persecution was started by church and state in 1782, and lasted many years. Yet the influence of Sufism in Persia and eastward is rather increasing than waning; and in all orthodox lands this most fatal dissolvent of Islam is welcomed. There are many sects in Sufism. In Persia when the 19th century began there were at least a quarter of a million of Sūfīs. There are more now; but with the majority the name means not pantheist but freethinker. In this sense the Sūfīs or Wise may include half of the Persian middle class.

Sugar. The sugars form a natural group of substances, for the most part of vegetable origin, connected with glycerol and the glycols on the one side and with the dextrins and with bodies of the starchy class on the other. They are, as a rule, crystallisable, soluble in water, less soluble or insoluble in alcohol, and insoluble in ether and in other solvents which are immiscible with water; they have a sweet taste, a physical characteristic varying in the several members of the group from the luscious sweetness of cane-sugar to the feeble sweetness of some of the saccharoids. This quality, however, is not confined to the sugars, being also possessed by the glycols, by glycerol, by glycocine, by certain compounds of the aromatic group, and even by some inorganic salts, such as those of lead and yttrium. Most sugars possess the property of causing rota-

tion of a ray of polarised light, and this optical activity serves as a means of estimation of very great value to the analyst. The sugars are divided according to the views entertained as to their constitution into three classes: the *saccharoids*, the *glucoses*, and the *saccharoses*. The *saccharoids* are regarded as saturated hexatomic alcohols, and have the general formula $C_6H_{14}O_6$, or differ from this in having in certain instances the elements of water superadded. Mannite, dulcite, isodulcite, hesperidin sugar, persite, sorbite are the chief saccharoids, but quercite, pinito, raffinose, and erythro-mannite, which possess formulæ departing from the type $C_6H_{14}O_6$, are usually included under the same heading. The saccharoids are all crystalline, and not capable of being fermented either with yeast or with the lactic and butyric bacteria, or in one or two instances undergo a very feeble action of this kind. The *glucoses* are more important; they are the aldehydes of hexatomic alcohols, and have the general formula $C_6H_{12}O_6$. Dextrose, lævulose, and mannitose closely resemble one another, reduce Fehling's solution, readily ferment (except the last) with yeast, rotate the plane of polarisation, and when oxidised yield saccharic acid. Galactose, which is probably a mixture of two dextro-rotatory sugars, closely resembles lævulose, but has a feebleness of action on Fehling's solution, and yields mucic acid under the influence of oxidants. Inosite, sorbinose, and eucalyptose do not ferment with yeast, but are acted upon by the lactic and butyric bacteria (milk and cheese).

Dextrose (synonyms glucose, grape-sugar, starch-sugar) is the most important sugar of the glucose class. It occurs in the anhydrous condition as transparent prismatic crystals, and in warty masses having the composition $C_6H_{12}O_6 + H_2O$, which lose all their water below $100^\circ C$. It melts at $146^\circ C$., is less soluble in water and in alcohol than sucrose, and dissolves in boiling water in all proportions. Dextrose has a dextro-rotatory action upon polarised light, and reduces Fehling's solution. It is not affected by moderate boiling with dilute acids, nor does it readily char under the influence of strong sulphuric acid, but forms with this body an acid ethereal salt decomposed by water. It also forms analogous compounds with many other acids. It is rapidly decomposed on boiling with caustic alkalis or caustic lime. Dextrose is found ready formed in the grape to the extent of 15 per cent., and in many other fruits. It may be prepared by decomposing the glucosides and by the hydrolysis of starch, dextrin, cane-sugar, &c., by means of dilute acids, diastase, or invertase, also by the action of sulphuric acid upon cellulose. In honey and in many fruits it occurs in association with lævulose, a glucose which bears a great resemblance to it, but is distinguished by having a greater sweetness and a levo-rotatory power. Lævulose is said to be even sweeter than cane-sugar.

The *saccharoses*, with the general formula $C_{12}H_{22}O_{11}$, are the most important sugars, inasmuch as ordinary sugar, malt-sugar, and sugar of milk are members of this class. They may be regarded as condensation products of the glucoses, and derived from two molecules by elimination of the elements of water, thus: $2C_6H_{12}O_6 - H_2O = C_{12}H_{22}O_{11}$. The saccharoses are, with the exceptions of malt-sugar (maltose) and milk-sugar (lactose), incapable of reducing Fehling's solution. They are fermented by yeast, but only after previous conversion into glucoses by the agency of an enzyme (or enzymes), invertase, secreted by that organism. The saccharoses are charred by strong sulphuric acid. Besides the three already mentioned, this group contains melitose, melezitose, mycose, and synanthrose.

Sucrose (syn. cane-sugar, saccharose, saccharon,

cannose, &c.) is a solid crystallising in the form of monoclinic prisms—generally with hemihedral faces—which are transparent, colourless, and have a sweet taste, a specific gravity of about 1.6, a melting point of about 160° C., and strongly rotate the plane of polarisation to the right (see below). Sucrose is soluble in about half its weight of cold water and in boiling water in all proportions; it is nearly insoluble in absolute alcohol and soluble in dilute alcohol, the solubility increasing with the dilution in an ascending ratio. Ether, chloroform, carbon disulphide, oil of turpentine, petroleum spirit, and liquids immiscible with water generally, have no solvent action upon this sugar. Sucrose melts at about 160° C. (320° F.), and assumes on cooling the condition known as 'barley-sugar,' which is probably an allotropic form; at a little above the fusing-point it passes into a mixture of dextrose and levulose without loss of water. When still further heated water is given off, and the mass begins to blacken with evolution of fumes having a characteristic odour; and at about 200° C. caramel, a mixture of caramelan, $C_{12}H_{12}O_5$, caramelen, $C_{28}H_{50}O_{25}$, and caramelin, $C_{30}H_{102}O_{81}$, is obtained. Caramel is largely used for the colouring of wines, beer, vinegar, &c. Alkaline hydroxides in the cold have little or no action on sucrose, but when fused with caustic potash this sugar yields oxalate and acetate of potassium.

Solutions of sucrose possess the property of dissolving the oxides of the alkaline earths, with which the sugar forms compounds of definite composition. The *Liquor Calcis Saccharatus* of pharmacy is a solution of lime in syrup, and with baryta sucrose forms the compound $C_{12}H_{21}(BaOH)O_{11}$, which falls as a precipitate when syrup is mixed with a concentrated solution of barium hydroxide. With strontia sucrose forms the compound $C_{12}H_{20}(SrOH)_2O_{11}$ as a precipitate, and this reaction is employed commercially for the separation of crystallisable sugar from molasses. The precipitate is granular, easily separates, and after being washed with hot water is decomposed with carbonic acid.

Sucrose in the solid condition, or in the form of a strong syrup, is decomposed in the cold by concentrated sulphuric acid, with formation of a spongy carbonaceous mass, and evolution of sulphur dioxide and other volatile products. Nitric acid acts upon sucrose, forming nitrosucrose, saccharic acid, oxalic acid, or carbonic acid, according to the concentration of the nitric acid; the fuming acid in the cold produces nitrosucrose. Sucrose, like all the members of the saccharose group, is hydrolysed when heated in solution with dilute acids; in the case of sucrose a mixture of dextrose and levulose results, the change consisting in the assimilation of the elements of water and bisection of the sucrose molecule. This action is termed 'inversion,' because the solution after the action of the acid rotates the plane of polarisation to the left, but the term is now applied generally to the hydrolysis of saccharoses by acid. Inversion takes place slowly even in the cold with hydrochloric or sulphuric acid, and with dilute solutions of sucrose, but at 70° C. the change is very rapid; acetic, tartaric, citric, and the other weak acids have much less power in this respect. The process of inversion is of value in analysis of mixtures of various sugars.

Sucrose is a strong reducing agent, which is another way of saying that it is readily oxidised. It quickly decolorises solutions of potassium permanganate even in the cold, and on boiling with this reagent yields oxalic and carbonic acids. When heated with solutions of silver or mercury it causes separation of the metals, and it precipitates gold from the chloride. When boiled with cupric salts in presence of alkaline hydroxides

there is no separation of cuprous oxide, but after continued ebullition a partial reaction occurs. After undergoing inversion by dilute acids or invertase it quickly and completely reduces alkaline solutions of copper (see below).

The behaviour of sugar under the influence of living ferments is of great interest theoretically, and of importance from a practical point of view. Some of the mould fungi (*Hyphomycetes*), nearly all the yeasts (*Saccharomycetes*), and many torula forms ferment solutions of sugar with formation of alcohol and carbonic acid in presence of some forms of albumenoid matter, and of certain inorganic substances. The mould fungi, particularly those of the genus *Mucor*, function as alcoholic ferments, that property being especially but not exclusively possessed by the budding spores of these organisms, which in many instances closely resemble the yeasts in appearance. The commonly occurring mould *Penicillium glaucum* possesses the power of secreting an invertive ferment which is able to convert sucrose into other sugars. *Monilia Candida* directly ferments solutions of this sugar without previous inversion, a property not possessed by the strong yeasts; *Mucor racemosus* secretes invertase and ferments sucrose after inversion; several other *Mucors*, as *M. erectus*, *M. spinosus*, *M. mucedo*, *M. circinelloides*, &c., have no inverting action, but can produce fermentation after the sugar has been inverted by extraneous means. But the chief interest attaches to the action of yeasts, which are *par excellence* the true alcoholic ferments. The strong yeasts, *Saccharomyces cerevisiae* (both top and bottom forms), the two forms of *S. ellipsoideus* (bottom forms), and the three forms of *S. pastorianus*, all secrete invertase and vigorously ferment sucrose. Of the feeble yeasts *S. marzianus* and *S. exiguus* (Hansen), which have little action on maltose, invert sucrose and ferment it with energy. Of the other species of *Saccharomyces* in some instances little is known regarding their fermentative action; but *S. membranifaciens* is believed to be the only *Saccharomyces* which neither inverts nor incites fermentation of one kind or another. *S. apiculatus* (so called, although not a true *Saccharomyces* because it forms no gonidia) secretes no invertase, and therefore cannot act upon sucrose. The action even of the stronger yeasts upon this saccharose is very feeble in the absence of albumenoids of the peptone class and of the necessary salts, but in the presence of these latter ammonium compounds, asparagin, and some other nitrogenous bodies can to a great extent supply the place of the albumenoids. Under favourable conditions—viz. the presence of these necessary yeast foods and of sucrose to an extent not too great—the introduction of a small quantity of healthy yeast is quickly followed by the multiplication of the organism, accompanied by inversion of the sugar and the production of alcohol and carbonic acid. The process of inversion takes place at an early stage of the fermentation, and is a chemical reaction capable of being effected by the enzyme (invertase), separately presented in the absence of the organism; the production of alcohol is a function of the living cell, and becomes slower and more difficult as the percentage of spirit increases, the alcohol constantly tending to inhibit the fermentative act, until at length, when about 14 per cent. of alcohol has been produced, it ceases altogether. Pasteur, who was the first to show the true character of yeast, formerly considered the fermentation of sugar to be an anaërobic phenomenon, taking place only in the absence of oxygen, in order to obtain which the yeast tears up the sugar molecule; this view, however, is not now held, it being believed that the *Saccharomycetes* are to a great extent indifferent in this respect, playing their part equally well in presence of



SUGAR-MILL, OAHU, HAWAII.



much oxygen or of a minute (necessary) quantity. Besides alcohol and carbonic acid other substances are produced from sucrose by yeast, notably glycerol and lactic acid, and certain odorous principles to a small extent. Pure cultures of yeast are said not to elaborate the higher alcohols (fusel-oil), but this view requires to be supported by further investigation.

Sucrose occurs very widely in the vegetable kingdom. It is found in the sugar-cane (*Saccharum officinarum*), of which a number of varieties are known and cultivated; in many other grasses (Graminæ); in the sap of many forest trees; in the roots of certain plants; in numerous seeds; in most sweet fruits, usually in association with invert sugar; and in the nectar of flowers. The sugar-cane was the source from which sugar was originally prepared, and the East first learned the use of this article of diet. The cane has doubtless been known in India from time immemorial, and

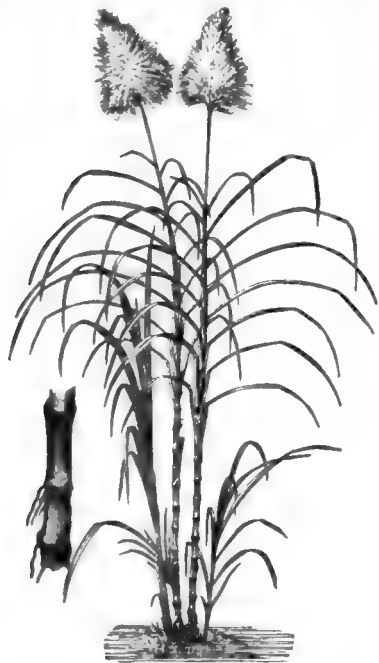

Sugar-cane (*Saccharum officinarum*).

sugar is still produced from this source in that country, but the quality of that now exported does not bear comparison with the product of other lands. The early classical writers, especially Herodotus, Theophrastus, Seneca, and Strabo, make undoubted references to sugar, which they speak of as 'honey of canes,' or 'honey made by human hands;' and at about the date of the Christian era this substance had become pretty generally known under the name of *saccharon* or *saccharum*. Our word sugar is derived, through Fr. *sucre*, Span. *azúcar*, Arabic *sakkar*, Persian *shakar*, from the Sanskrit *sharkarâ*, which signifies a substance consisting of small grains. The term candy, applied to sugar in large crystals, took its origin from the Arabic and Persian *kand* or *kandat*. It is believed that Bengal was the locality in which cane-sugar in a dry granular state was first prepared. The Chinese admit that they first gained their knowledge of the art of making sugar from India, somewhere about 766 to 780 B.C. We have evidence that at a later period, the 9th

century of our era, sugar was grown in Persia, and the Persian physicians of the 10th and 11th centuries first introduced it into medicine. The Arabs cultivated the cane in many of their Mediterranean settlements, and as early as 961 A.D. the plant flourished in the Iberian peninsula. Soon afterwards sugar of Egyptian origin formed a staple of trade between the merchants of Venice and of London, wool, which then constituted the great wealth of England, being largely exported in exchange for it. The manufacture of sugar from the cane, thus interesting historically, still furnishes a considerable part of the entire supply; and the best sugar is derived from this source, although the beet-root now actually yields a greater quantity.

The sugar-cane has been introduced into almost all tropical and subtropical countries; the East and West Indies, the southern United States, Central America, Brazil, Peru, Chili, Mauritius, the Malayan Archipelago, Egypt, northern Australia, south Africa, and many islands of the Pacific may be mentioned as illustrating the wideness of its range, although the list is by no means exhaustive. The cane seems to have been introduced by Jesuits into the southern United States from the West Indies about 1750; but sugar culture was neither an important nor prosperous industry when Louisiana was ceded to the United States in 1803. This state soon became and still is a great sugar-producing state; the cane is grown in all the Gulf states on both sides of the Mississippi (though in all these states it sometimes suffers from frost). In Europe it is or has been grown a little in Sicily and in Andalusia.

The cane, which may be described as a gigantic grass, thrives best in a warm, moist climate, with prevalent sea-breezes and moderate intervals of hot, dry weather. Many descriptions of cane exist, and these are regarded as varieties of one species, although some botanists have raised a few to the rank of distinct species. The common sugar-cane of the United States is the Creole or Madeira; others cultivated being the Otaheite, Batavian, Chinese, and Salangore. The stem, which varies from 6 to 14 feet in height, is from 1 to 1½ inch thick, and jointed at intervals of from 3 to 6 inches; its pith, of open cellular structure, contains the sugary juice. The tops and lower joints are not crushed; the outer skin contains much silica. The 'arrow' or flowering stem is without joints, and bears a panicle of soft, silky flowers. The cane suffers much from the ravages of rats (to check whose ravages the mongoose or ichneumon has in some places been successfully used), from white ants, and several boring insects. The plant is propagated from the eyes or buds which grow on the stems, as no cultivated cane seems to ripen its seed; and the 'stoles,' or portions remaining in the ground, throw up fresh canes, called ratoons, for several seasons—sometimes twenty years—after which replanting is necessary. The young cuttings are planted in rows 3 feet apart, and at intervals of 2 feet from plant to plant. The cane requires a fertile, marly soil, not too heavily charged with common salt or other saline ingredients. The most suitable manure is farm-yard dung or night-soil; superphosphates and the various artificial fertilisers are considered to be less advantageous, but the presence of lime is of primary importance.

The sugar exists in a state of solution in certain cells in the stem of the plant, and in order to obtain it several methods are adopted. The juice is sometimes expressed by means of powerful roller-mills which rupture the cells, or the crushing is preceded by maceration in water. Sometimes the diffusion method is adopted, which consists in

cutting the canes into short pieces and soaking these in an equal weight of water; several vessels are employed, the liquor from the first being passed into the second, where it becomes more concentrated, and so on throughout the series. Cane-juice, pure and simple, of course contains the highest percentage of sugar, its average composition being as follows: water, 81; sugar, 18; uncrystallisable sugar, 0.4; other organic matter, 0.6; mineral matter, 0.4. To obtain such juice the canes are passed lengthwise through the rollers, usually three in number, which have a combined slow rolling and sliding motion, and great care is taken to prevent doubling up of the canes and consequent stoppage of the mill. So long as the juice is enclosed within the cells of the plant it never enters into fermentation, but when liberated it rapidly undergoes such change, and it is therefore necessary for it to be submitted to the processes of clarification and evaporation without loss of time. Clarification, or defecation, is carried out with lime and chemicals, and may be described in general terms as follows. The juice is raised to a temperature of 80° C. (176° F.), and milk of lime is added in quantity sufficient to neutralise the acid, the liquor then being allowed to stand for the separation of the coagulated impurities, some of which subside while others rise to the surface. Sulphurous acid or its salts are also sometimes used, as well as finings, such as clay, which help to carry down the suspended matter. The clarified juice is next run through bag, charcoal, or capillary filters, and then concentrated. This is effected either in open coppers, by means of film evaporators, or in vacuum-pans. The first method leads to loss of sugar and discoloration of the product, and is becoming obsolete. The second operation may be briefly described as passing the juice in a thin layer over the surface of a cylinder (or 'wetzell') heated internally by steam. The vacuum-pan, for a fuller description of which the student must consult larger works (e.g. Spon's *Encyclopædia of Industrial Arts*), is essentially a spherical copper vessel heated at the bottom by steam-coils, and communicating at the upper extremity by means of a still-head with a powerful air-pump which draws off the vapour as fast as it forms, and thereby maintains the boiling-point of the syrup at about 66° C. (150° F.).

The art of pan-boiling consists in concentrating the syrup until minute grains are formed, and then 'feeling' these by repeated admissions of fresh liquor. The *masse-cuite*, as the thick mass of crystals is termed, is usually submitted to the action of centrifugal machines which separate it into two portions, dry crystals and syrup or molasses.

Sucrose is at the present time prepared more extensively from the beet-root than from the cane, and the article so produced is commonly, but erroneously, called cane-sugar. The beet-sugar industry was first stimulated by Napoleon I., especially during the period when France was deprived of sugar by the English blockade, and has assumed immense proportions owing in great measure to the scientific skill that has been expended upon it. The Beet (q.v., *Beta vulgaris*) is indigenous to Europe, and many varieties of this plant, as of the sugar-cane, are known. The juice of the root contains from 12 to 18 per cent. of crystallisable sugar associated with various salts, such as the phosphates, oxalates, malates, and chlorides of potassium, sodium, and calcium, besides albuminous, pectinous, and other substances. The plant thrives best in a deep, friable 'turnip loam,' neither too stiff nor too light, and manuring with phosphatic manures gives the best results; peaty and moorland soils and farmyard manure are

less suitable. The seed is usually sown in April, and the crop gathered in autumn before the incidence of early frosts.

The methods for the extraction of the sugar are in the main analogous with those appertaining to the manufacture of sugar from cane-juice. The roots having been harvested are stored until required for use in pits dug in the ground, and covered with straw and earth for protection from frost. They are afterwards taken out and introduced into vessels called 'washers,' where they are separated from stones and adhering dirt by a rapid current of water. The roots thus cleansed are then treated for the extraction of the sugar either by (1) rasping and pressing, (2) maceration, or (3) diffusion. The first of these methods consists in reducing the roots to a fine pulp by machinery, and subsequently squeezing out the juice by powerful presses, the combination representing the cane-mill of tropical regions. The maceration process is applied to the pulp, which is subjected to the action of water in suitable vessels, the exhausted pulp being afterwards strained from the liquid which now contains the sugar in solution. The diffusion method does not require the rupture of the cells, but utilises the power which sugar and the saline matters, as crystalloids, possess of passing through the unbroken cell-membrane, leaving behind the colloid, albuminous, and pectinous substances. The juice or solution obtained in one or other of these ways is defecated by 'double carbonation,' according to which lime is first introduced in the cold, and afterwards removed by the action of carbonic acid, followed by heating to 90° C. (194° F.), the treatment being subsequently repeated upon the decanted juice this time at a boiling temperature throughout. The liquor is next filtered through animal charcoal for the removal of colouring matter, and of the slight excess of lime still remaining, boiled down to a density of 25° B., again passed over charcoal, and then evaporated to a mass of crystals in a vacuum-pan as in the case of cane-juice.

Sucrose is also made in America from the sugar-maple (*Acer saccharinum*) and the melon (*Cucumis melo*); in America and elsewhere from different varieties of sorghum (see DURRA) and from maize (*Zea mays*); and in various tropical countries from the date-palm and other species of Palmyra. Palm-sugar is derived from the juice which flows from incisions made in the trunk of the tree. This is very pure, containing less non-saccharine matter than cane-juice, and far less than beet-juice, and the sugar is obtained by simple evaporation in open pans. Sorghum sugar is extracted and fabricated by processes that are almost identical with those employed in making sugar from the cane, but the machinery is usually constructed on a much smaller scale. Maple-sugar is manufactured by simple evaporation in iron or copper pans of the sweet sap draining from auger holes made in the trunk during the months of spring. In 1891 the total production of sugar of all kinds in the United States was estimated at 539,710,000 lb.—500,000,000 lb. from cane, 29,210,000 from beet, 2,500,000 from sorghum, and 8,000,000 from maple sap. The cultivation of sugar beet is making progress under the auspices of the Department of Agriculture.

In former years, before the beet industry assumed its present enormous proportions, and when the cane was the chief source of supply, sugar was to a great extent consumed in the condition in which it arrived from the producing country. This, which was possible and even pleasant with the sweet and fragrant cane muscavadoes, became impossible when raw beet-sugar with its unpleasant vegetable flavours was introduced, and the practice of refining all sugars became established. Sugar-refining is

carried out in high buildings, so that the materials may gravitate from higher to lower levels in order to avoid the cost of pumping. The first operation, that of discharging the hogsheads of muscavado, bags of beet, mats of jaggery (as most of the sugar from the East is called), or other packages, takes place on the highest floor of the refinery. Here the sugars are mixed, and thence delivered on to the next lower or 'blow-up' floor by means of shoots. The 'blow-ups' are large vessels in which the sugar is dissolved in hot water to a syrup of 25°–27° B. when hot, equal to 27°–30° B. when cold. The syrup next flows through filter-bags, of which a large number are required, owing to the slimy nature of the suspended matter, and is then caused to gravitate down large iron cylinders packed with granulated animal charcoal. This is produced by heating bones to redness in closed vessels without access of air, and possesses the power of removing colouring (and other) matters not only from sugar solutions, but from most organic liquids. After a time the charcoal becomes spent and ceases to act, but regains its properties upon reburning, an operation which is carried out in a refinery as many as a hundred times. The first syrup running from the char-cisterns is quite colourless, and this portion is collected apart and boiled for the production of loaves or crystals. The last portions of syrup yield the 'pieces' or yellow moist sugar. The boiling is effected in vacuum-pans, and a small quantity of sulphurous acid is added to the pan and greatly improves the colour of the 'pieces.' In boiling this class of goods the object is to form a 'false grain'—i.e. an aggregation of small grains having the appearance of larger particles; in this way a soft-looking sugar of primrose complexion and carrying a large quantity of syrup, which pleases the eye much more than a gray-looking 'piece' sugar of bolder grain, is obtained. The thick mass from the pan is discharged through an opening in the bottom into centrifugal machines, which, with the aid of a little wash water, separate the crystals from the syrup. This operation of 'machining,' it should be mentioned, is frequently applied to hard grainy beet-sugars in the initial stage of refining, and the resulting ill-smelling impure syrup treated apart from the grayish white and comparatively pure crystals left upon the machine.

Lump sugar is made by draining a very stiff *masse-cuite* of small grain in moulds, and afterwards drying the concreted loaves; for the production of cube sugar moulds of peculiar shape are used, which when filled are placed in centrifugal machines to facilitate the removal of the syrup.

Analysis.—Three estimations are chiefly necessary for the analysis of raw sugar, the determination of polarising value, of glucose, and of ash or mineral matter. The polarimeter is an instrument by which the rotatory power of sucrose (or other sugars) upon a ray of polarised light is made available for purposes of quantitative measurement. Those instruments are the best that require the use of the yellow light of the sodium ray. The two Nicol prisms of the polarimeter being crossed and the vernier at zero, a filtered solution of sugar containing a known weight of the sample in unit volume is introduced into a tube 20 centimetres long and placed between the prisms. The result is a transmission of light requiring for its suppression the rotation of the analysing prism, the one nearest to the eye. From the angular degrees of this rotation the polarising value of the sample is deduced.

In actual instruments an ingenious device is made use of for the sake of gaining delicacy. This consists in covering one-half of the optical field with a half-wave plate of quartz, or, in the modern

instrument made by Field & Co. of Birmingham, by a less expensive but equally efficacious half-wave plate of mica; the field in these instruments is always more or less bright, but the slightest movement of the prism in either direction from the neutral point causes an unequal shadowing of the two semi-discs, and very sharp observations can be made. The presence of glucose in sugar, and the amount, are ascertained by *titration* with standard Fehling's solution made by dissolving in every litre 34.64 grams of crys. sulphate of copper, 70 grams of caustic soda, and 180 grams of Rochelle salt. This liquid is not affected by sucrose, but when a solution of a sample containing glucose (also maltose, lactose, &c.) is delivered into a known volume of the copper solution diluted with water, and kept at the temperature of boiling, the copper is precipitated as red suboxide, and the supernatant liquid becomes colourless. The volume of the solution of sugar required to effect this result is a measure of the glucose present. The ash of sugar is ascertained by burning 1 gram of the sample in a platinum capsule at a red heat; but, owing to the difficulty of obtaining a white ash from the fusible salts, it is usual in technical practice to add two or three drops of strong sulphuric acid before ignition, and to deduct one-tenth for the extra weight thus introduced. From the various determinations made as described the *rendement* or refining value of the sample is deduced by subtracting five times the percentage of ash plus the percentage of glucose from the percentage of sucrose indicated by the polarimeter; in the case of sugar from the cane only three times the ash is deducted by some analysts.

Besides sucrose the only saccharoses of practical importance are lactose and maltose. Lactose is the natural sugar of milk. It is a solid substance of sweetness inferior to sucrose, crystallising in hard, white, semi-transparent masses, having the composition $C_{12}H_{22}O_{11} + H_2O$, and soluble in water, but insoluble in alcohol or ether. When boiled with dilute sulphuric or hydrochloric acid it is converted into the two glucoses dextrose and galactose. It is not fermented by yeast alone, but in contact with yeast and putrefying casein it ferments, yielding alcohol and lactic acid. Koumiss is a product of such fermentation acting upon the milk of mares. Lactose reduces Fehling's solution and rotates the plane of polarisation to the right.

Maltose, $C_{12}H_{22}O_{11}$, occurs in fine crystalline needles, soluble in water and in alcohol, but to a less extent than sucrose. This sugar reduces Fehling's solution, and has a dextro-rotatory polarisation. It derives its chief interest and importance from the fact that it is the principal ingredient in beer worts, in which it owes its presence to the action of an enzyme, diastase, possessing the power of hydrolysing starch, and forming from it maltose and dextrin, but not glucose, as was formerly supposed. It is probably not directly fermentable by yeast, but is rapidly inverted by that organism and converted into alcohol and carbonic acid.

The world's product and consumption of sugar—especially beet-sugar—has increased largely within recent years. In an average year of the period 1853–55 the total was estimated, in papers published by the British Board of Trade in 1889, at 1,423,000 tons; in 1871–73, at 2,786,000; in 1886–87, at 5,187,000. In the same years beet-sugar production was respectively 190,000 tons, 1,042,000 tons, and 2,433,000 tons; cane-sugar from British colonies, 261,000 tons, 336,000 tons, 580,000 tons. For 1898 the total crop of beet-sugar was estimated at 4,500,000 tons. Of the total supply the United States is believed to consume 29 per cent., and the United Kingdom 21 per cent. The

sugar-refining industry of Britain (as in Greenock, q.v.) has suffered much from the Bounties (q.v.) given by sugar-producing countries and foreign tariff legislation. In 1872 Great Britain imported 1,729,302 cwt. of refined sugar, and of unrefined 13,776,696 cwt. (of which 5,139,499 cwt. were from British possessions). In 1888 the imports of refined sugar were 6,871,681 cwt., and of unrefined 17,857,469 cwt. (of which 6,282,088 cwt. were beet-sugar, and 3,446,949 from British possessions). In 1897 the imports of refined sugar were 15,830,759 cwt., and of unrefined 13,553,527 cwt. (8,694,590 cwt. beet-sugar, and 1,679,113 cwt. from British possessions). In 1872 the United States raised 146,906,125 lb. of sugar at home, imported 1,509,185,674 lb., and exported 16,958,822 lb. In 1898 it raised 707,951,878 lb., imported 2,689,920,851 lb., and consumed 3,277,874,000 lb. Much sugar is used by brewers. The cost of sugar has sunk since about 1850 from 7d. or 8d. per lb. to 2d. In 1892 the sugar-refining industry of the United States passed almost wholly into the hands of one syndicate with a capital of \$85,000,000.

See P. Soames, *Manufacture of Sugar* (1872); Lock, Wigner, and Harland, *Sugar Growing* (2d ed. 1885); Ware, *Sugar Beet* (1880); M'Murtrie, *Report on the Culture of Sugar Beet* (1881); Lock and Newlands, *Sugar: Handbook for Planters and Refiners* (1889); F. G. Wiechmann, *Sugar Analysis for Refineries* (1891); H. L. Roth, *Guide to the Literature of Sugar* (1890); also the exhaustive article in Spon's *Encyclopædia of the Industrial Arts*, with full bibliography. For the chemistry and analysis of sugar, see Allen's *Commercial Organic Analysis* (1879; new ed. 1889), or Prescott's *Organic Analysis* (New York, 1888). For legislation, see Boizard and Tardieu, *Histoire de la Législation des Sucres, 1664-1891*. See also the article SACCHARIN.

Sugar of Lead. See LEAD, Vol. VI. p. 543.

Suhl, a town of Prussia, standing in a romantic valley on the south-west side of the Thuringian Forest, 32 miles by rail SW. of Erfurt. It has long been celebrated for its manufacture of firearms, both military and sporting, and from the middle ages down to the 18th century was no less celebrated for its swords and war-armor. There are also iron and machine works, potteries, and tanneries. Pop. (1890) 11,533.

Suhm, PETER FREDERIK (1728-98), a Danish historian, was born and died at Copenhagen.

Suicide (a word coined in England on a French model, but of Latin elements), according to English law, is a Felony (q.v.). A person found *felo de se* (guilty of self-murder) by a coroner's jury was formerly buried at a cross-road with a stake driven through his body, but this barbarous practice (a survival probably of the vampire superstition) was abolished in 1823. A person is *felo de se* if he commits any felonious act which results in his own death; a person who shoots at another with a gun which bursts and kills himself, a woman who dies of poison taken to procure miscarriage are both guilty of self-murder. If two agree to assist one another in committing suicide, and one survives, he is guilty of murder. Policies of life insurance are usually so framed as to be void if the insured dies by his own act, whether he is of sound mind or not. In Scotland suicide involves 'single escheat'—i.e. forfeiture of the movable estate of the deceased to the crown; but this rule does not apply in cases of insanity. In the United States the constitutions of eleven states provide that the property of suicides is not to be forfeited.

The question as to the moral justification of suicide has exercised the minds of ethical philosophers from the days of Plato, Marcus Aurelius, and Seneca down to the present time. Some schools of thought, notably Stoics and their adversaries the Epicureans, defended suicide under proper conditions; Christianity has always refused

to admit any justification for self-destruction, and the Roman and Anglican churches deprive of ecclesiastical burial those who have without doubt wilfully committed self-murder.

From the medical point of view suicide is in the majority of cases a symptom of disease of the brain. It is not now denied, however, by any competent medical authority that sane men may and do commit suicide; and then the attempt is unquestionably a crime deserving of punishment. The brain constitution of some persons is such that when they are under the immediate influence of alcohol they always become suicidal. The next kind of case in which suicide is attempted is one on the borderland of disease. It is the man intellectually sound and not emotionally depressed who simply loses for the time his primary instinct of the normal love of life, ceases to have any fear of death, and suffers from the *tadium vite* of the ancients, and who in this state, for trivial causes or for no outward cause at all, attempts his life. Some such men are in Hamlet's frame of mind: 'To be or not to be? That is the question.' A man in this state, which is often a hereditary one, cannot always be reckoned insane, and yet he is in an abnormal state of brain and mind. The mass of suicides, however, are committed or attempted by persons who are either insane or on the verge of insanity, though as yet we cannot tell the percentage of sane and insane suicides. The two forms of insanity in which suicidal impulses are most frequent are melancholia and alcoholic insanity. Four-fifths of all patients suffering from melancholia have suicidal feelings, and two-fifths of them make actual attempts on their lives. It is a risk that should be considered and provided against in every case of melancholia and in every case beginning to suffer from alcoholism or alcoholic insanity. The love of life, with efforts to preserve it, is the primary and strongest instinct not only in man, but in all the animal kingdom, without which all animated creation would soon come to an end. The loss of this is the most striking change that can possibly take place in the higher faculties or functions of the brain. The tendency to suicide is very hereditary. Suicide may be carefully contrived and planned for months, or it may be done through a momentary morbid impulse. It may be done, and commonly is done, from insane delusions, such as that the patient is going to be killed and tortured, that he is going to be tried, that his food is poisoned, that he is too great a sinner to live and must make expiation, that he is the cause of evil to all around him, that he cannot recover, &c. Physicians especially guard against suicide with patients who are very much afraid they are to be put to death, and who therefore might be supposed to be too much afraid of dying to do any harm to themselves. Prolonged sleeplessness will sometimes lead to suicidal feelings through brain exhaustion. Suicidal feelings are sometimes the very first symptom of insanity, before anything mentally wrong is suspected and before any watching or precautions are therefore taken. Attempts at suicide are sometimes made while the patient is quite unconscious or in a state of altered consciousness, so that there is no recollection of it afterwards. Sometimes it is suggested by the sight of a weapon or water or any such means of destroying life. When the suicidal desire is strongly present it is a mistake to suppose that the patient's former religious sentiments, or his sense of duty, or his obligations to those dependent on him, or any other rational motive can be depended upon to prevent his committing the act.

The modes of committing suicide vary in different countries, in the two sexes, and in different

professions. Hanging is the favourite method in most European countries, except Italy, where drowning and shooting are most common. Suicide is much more common among men than among women, being in the proportion of 3 or 4 to 1; and this applies to all countries and races. As to age, 'suicide augments in the two sexes in direct ratio with age,' at least up to the seventieth year; there are instances of suicide at five years of age, and also over ninety. The critical periods of life, adolescence, the climacteric, pregnancy, parturition, nursing, and senility all increase the tendency to suicide, just as they increase the tendency to insanity. Suicide in all civilised countries is becoming more common year by year. The solitary system in prisons is found to increase the number of suicides as compared with the older system of associating prisoners together. Physical diseases, notably those that are very painful and those that are slow and chronic, increase the number of suicides. The increased consumption of alcohol, especially spirits, increases the suicides of any country, they having doubled from this cause in France from 1849 to 1876. The religion of a people seems to exercise a marked influence on the number of suicides. In states where the Roman Catholic form of religion prevails there are 58 suicides per million of the population; in Protestant states there are 190 per million, and in countries where the Greek Church is dominant only 40 per million. But the social circumstances of each country need to be taken into consideration to correct in some degree the conclusions derived from such religious statistics, the Protestant states being on the whole the most advancing and the most modern in spirit, and a higher standard of general culture being always accompanied by a larger number of suicides. No doubt it takes a highly developed brain that has been cultured to feel keenly, and keen feeling is the basis of painful emotion. Suicide is most common among the widowed and least frequent among the married. The military profession furnishes much the largest proportion of suicides in all countries, being usually twice or thrice that of any other calling, and in Italy fourteen times larger than the average; next comes domestic service; next come the liberal professions. 'The proportion of suicides in all Europe is greater among the condensed population of urban centres than amongst the more scattered inhabitants of the country' (Morselli). But the proportion is not precisely according to the density of population. Denmark stands highest in Europe (285 per million of population), Germany, north and south, next (from 150 to 165), Norway and Sweden next (128), Great Britain, her colonies, and the United States at 70 per million.

Amongst notable suicides (omitting cases referred to in Scripture) may be mentioned :

Sappho	B.C. 7th c.	Clive	1774
Empedocles (q.v.)	435	Rousseau (?)	1778
Demosthenes	322	M. Roland	1793
Hannibal	183	Pichegru	1804
Mithridates	63	Tannahill	1810
Cato the Younger	46	Berthier	1815
Brutus and Cassius	42	Romilly	1818
Mark Antony	30	Castlereagh	1822
Cleopatra	30	Haydon	1846
Nero	A.D. 68	Hugh Miller	1856
Otho	69	Admiral Fitzroy	1865
Maitland of Lethington	1573	Prévost-Paradol	1870
Sir John Suckling (?)	1642	E. M. Ward, painter	1879
Robert Burton (?)	1649	Fred. Archer	1886
Vatel the cook	1671	Louis II. of Bavaria	1886
Earl of Essex	1683	Crown-prince of Austria	1889
Blount the Deist	1693	Pigott	1889
Eustace Budgell	1737	Balmaceda	1891
Chatterton	1770	Boulanger	1891

See Forbes Winslow, *The Anatomy of Suicide* (1840); French works by De Boismont, Bertrand, Mme. de Stael, Legoyt (1831), Gavisson (1885); Italian works by Mor-

selli (1880; Eng. trans. 1881), Carrieri (1883), Ferri (1884); O'Dea, *Suicide: Studies on its Philosophy, its Causes, and its Prevention* (New York, 1882); Westcott, *Suicide: its History, Literature, and Jurisprudence* (with bibliography, 1885); and some thirty other works cited in *Notes and Queries*, June 1890, p. 489. Also the articles INSANITY, EUTHANASIA, HARI-KARI, and SUTTEE. The suicide of Scorpions (q.v.) and snakes, often asserted, has been proved to be impossible.

Suidæ, a family of even-toed, non-ruminant Ungulates, including pigs, hogs, or boars, the Babiroussa, and the wart-hogs (*Phacochoerus*). The snout is mobile but truncated; the feet have four toes, of which two reach the ground; the upper canine teeth curve more or less outwards or upwards; the molars bear rounded tubercles; the stomach is almost simple. In distribution they are entirely confined to the Old World.

Suidas, the reputed author of a *Lexicon*, though when he lived, or who he was, or whether he was even called Suidas, no one can say; but it is customary to place him about the 10th or 11th century. The *Lexicon* bears unmistakable evidence of having gone through many hands; and though we can fix the date when several of the articles *must* have been written, it is impossible to ascertain whether they are the composition of the first compiler or of a later editor. The work is a sort of cyclopædia, giving an explanation of words, and notices of persons, places, &c., in alphabetical order. It possesses almost no literary or critical merit, but is valuable for its numerous extracts from ancient writers, whose works in many cases have perished. The first edition appeared at Milan (1499); since then the best editions have been those of Küster (3 vols. 1705), Gaisford (3 vols. Oxf. 1834), Bernhardy (2 vols. Halle, 1834), and I. Bekker (1854).

Sui Juris, in the Roman law, the condition of a person not subject to the *Patria Potestas* (see FAMILY, Vol. IV. p. 542). The paterfamilias was the only member of a family who was *sui juris*, all the rest being *alieni juris*, including sons, unmarried daughters, the wife, and the wives and children of the sons of the paterfamilias. A son or unmarried daughter became *sui juris* on the death of the paterfamilias. In his father's lifetime a son could only become *sui juris* by emancipation.

Suir, a river of Ireland, flowing 85 miles southward and eastward, chiefly along the boundary of the counties of Tipperary, Waterford, Kilkenny, and Wexford, past Clonmel, Carrick, and Waterford, till it meets the Barrow, and immediately afterwards falls into Waterford Haven. It is navigable by barges as far as Clonmel.

Suite, a series of dances arranged for instruments in the same or relative keys, and usually preceded by a prelude.

Sukhum Kale, a fortified seaport town of the Caucasus, on the east coast of the Black Sea, 70 miles N. by W. of Poti. It stands on the site of the ancient Milesian colony of Dioscurias, and since 1809 has been alternately in the hands of the Turks and the Russians; the latter have held it since 1877. Pop. 1947.

Sukkur, a town on the right bank of the Indus, 28 miles by rail SE. of Shikarpur; it is connected by rail also with Karachi (Kurrachee), and is the terminus of the Bolan Pass Railway to Afghanistan. The river is crossed by a magnificent cantilever bridge (1889), or rather by two bridges (one with a span of 820 feet), resting upon the fortified island of Bukkur in the middle of the channel. New Sukkur, which grew up after the British occupied (1839) the fort on Bukkur, has considerable trade in silk, cloth, cotton, wool, opium, saltpetre, sugar, brass utensils, piece-goods, metals, wines and spirits. Pop. (1834)

4000; (1872) 13,318; (1881) 27,389; (1895) 29,500. Old Sukkur, about a mile away, has a good many old tombs in its immediate vicinity.

Suleiman Pasha, Turkish general, was born in Roumelia in 1838, entered the Turkish army in 1854, fought in Montenegro, Crete, and Yemen between that date and 1875, and in the intervals of peace taught in the Military Academy at Constantinople, and finally presided over it as director. He greatly distinguished himself as a corps commander against the Servians in 1876, and was in 1877 nominated governor of Bosnia and Herzegovina. When the Russians declared war (1877) against Turkey Suleiman checked them at Eski Zagra, and destroyed his army in heroic but vain attempts to force them from the Shipka Pass. In October he was appointed commander-in-chief of the army of the Danube, but failed to accomplish anything, retreated behind the Balkans, and suffered defeat near Philippopolis (January 1878). He was condemned to be degraded and imprisoned for fifteen years. The sultan pardoned him, and he died at Bagdad 11th August 1892. Personally brave, he seems to have been a corrupt and designing traitor.

Suliman or **SULAIMAN HILLS**, a mountain-range upwards of 350 miles in length, running in a straight line from north to south, and forming the historic boundary between Afghanistan and the Punjab, India. The highest summit of the range, Takht-i-Sulaiman (Solomon's Throne), 11,295 feet high, was first ascended by a European, Major Holdich, in 1883. The general appearance of the range is rocky, precipitous, and bare of trees.

Sulina, one of the lower branches of the Danube (q. v.). The town of Sulina, on its south bank and near its mouth, has a lighthouse and 5000 inhabitants. Bombarded by the Russians in 1877, it has been a free port since 1879.

Suliotcs, a tribe who inhabited the valley of the ancient Acheron, in the Pashalik of Janina (*Epirus*) in European Turkey, are a mixed race, being partly of Hellenic and partly of Albanian origin. They are the descendants of a number of families who fled from their Turkish oppressors to the mountains of Suli (whence they derive their name) near Parga during the 17th century. In this corner of the Turkish empire they prospered, and towards the close of the 18th century numbered 560 families, inhabiting 90 hamlets. For several years they heroically resisted the attempts of the Turks to deprive them of their independence. But vanquished at length (1803), they retreated to the Ionian Islands, where they remained till 1820, when Ali Pasha, finding himself hard pressed by the Turks, invoked their aid. The Suliotcs, eager to return to their home, threw in their lot with him, but were ultimately forced to surrender their stronghold of Suli to the Turks, and again to flee from their country. About 3000 of them took refuge in Cephalonia, though large numbers preferred to skulk in the neighbouring mountains. Though they took a glorious part in the war of Greek independence, their country was not included by the treaty of 1829, nor by the extension of 1881, within the Greek boundary line. Nevertheless most of them established themselves in Greece, where their leaders were raised to important offices. See Perrhaebos' *History of Suli and Parga* (1815; Eng. trans. 1823).

Sulla, **LUCIUS CORNELIUS**, surnamed by himself **FELIX**, a scion of the illustrious house of the Cornelii, was born in 138 B.C. His limited patrimony was sufficient to secure him a good education, and his youth was spent not more in the pursuit of pleasure than in the study of the Greek and Roman authors. The liberality of his step-

mother increased his slender means, and enabled him to aspire to the honours of the state. As quaestor in 107 under Marius in Africa he crowned a series of important successes by inducing Bocchus, the Mauritanian king, to surrender Jugurtha, whom he brought in chains to the Roman camp (106). The war of the Cimbri and Teutones (104-101) saw Sulla again serving under Marius, whose jealousy, however, drove him to take a command under the other consul, Quintus Catulus. In 93 he was praetor, and in 92 proprætor in Cilicia, where the senate sent him with special orders to restore Ariobarzanes to the throne of Cappadocia, from which he had been expelled by Mithridates. After achieving a complete success, Sulla returned to Italy in 91. The private hatred of Marius and Sulla began now to take on a political aspect, as the aristocratic tendencies of the latter grew prominent. Their long-smouldering animosity was on the point of bursting forth, when the breaking out of the Social War hushed all private quarrels for the time. The aged Marius had now the deep mortification of finding his military achievements thrown into the shade by the brilliant successes of his rival. The expectations of Marius were dashed to the ground when the senate bestowed on Sulla, after his consulship in 88, supreme command in the Mithridatic war. Marius rushed headlong into treason and civil strife. Then followed the expulsion of Sulla from Rome, his triumphant return at the head of his devoted legions, the overthrow of the Marian party, and the first proscription. By the beginning of 87 Sulla was able to embark for the East. During the four years he spent there he won the victories of Chæroneæ (86) and Orchomenus (84) against Archelaus, the general of Mithridates. Next he crossed the Hellespont, crushed Fimbria, who had obtained the command of the army sent out by the Marian party (which, in Sulla's absence, had again got the upper hand in Italy), forced Mithridates to sue for peace, then sailed for Italy and landed at Brundisium (83). The victory over the Samnites and Lucanians at the Colline gate brought the struggle to a close (82), and Sulla was now master of Rome and Italy. Then followed his dictatorship, and the period of the proscriptions (81)—a virtual reign of terror, in which of senators were slain perhaps from one to two hundred, of knights between two and three thousand. During the next two years several very important constitutional reforms were carried, mostly reactionary, and tending to increase the authority of the senate. The restoration of the *judicia* to the senate, the abolition of the functions of the *comitia tributa*, the withdrawal from the tribunes of the right to summon the *comitia*, the doubling of the number of the senate, the annual election of twenty quaestors, the enactments that no man should be praetor without having been quaestor, or consul without having been praetor, and that *tribuni plebis* should be eligible for no other office, the institution of *quaestiones* without appeal confined to special classes of crimes—these were some of the provisions of a legislation, with a few exceptions, doomed to fall within ten years. In 79 Sulla resigned the dictatorship and retired to his estate at Puteoli, where, surrounded by buffoons and dancers, he indulged to the last in every sensual excess of which his exhausted frame was capable. He died in 78, at the age of sixty. His monument in the Campus Martius bore an inscription, attributed to Sulla himself, which said that none of his friends ever did him a kindness, and none of his foes a wrong, without being largely requited.

Sulla's manners were haughty and morose, though not devoid of a certain sensibility, for he was easily moved, it is said, even to tears, by a

tale of sorrow. His keen observation enabled him to see in young Cæsar, in spite of a careless temper and dissipated habits, what would yet prove 'more than one Marius.' His eyes, we are told, were of a piercing blue, and his complexion was disfigured by pimples and blotches, compared by the rallery of the Greeks to a mulberry sprinkled with meal.

Sullivan, SIR ARTHUR SEYMOUR, was born in London, 13th May 1842. He studied music under Sterndale Bennett and Goss, and at Leipzig, and had his music to *The Tempest* performed at the Crystal Palace in 1862. He then produced the cantata *Kenilworth* in 1864, the overtures *In Memoriam* (1866), *Marmion* (1867), and *Di Ballo* (1869), the oratorios *The Prodigal Son* (1868) and *The Light of the World* (1873), a Festival Te Deum for the Prince of Wales's recovery in 1872, and at Leeds in 1880 and 1886 *The Martyr of Antioch* and *The Golden Legend*. To the general public, however, he is better known by his hymn tunes, his songs, and still more his tuneful and popular operas and operettas. The latter began with *Cox and Box* in 1866, and include the long list given already in the article on W. S. Gilbert (q. v.); they are notable for an orchestration full of subtle and humorous touches that render his operas of special interest to musicians. The fertility and technical resource squandered on these productions were devoted to higher work in the grand opera of *Ivanhoe* (1891). He was the first principal (1876-81) of the National Training School for Music, was made Mus. Doc. of Cambridge in 1876 and of Oxford in 1879, received the Legion of Honour in 1878, and in 1883 was knighted. He died 22d November 1900, and was buried in St Paul's.

Sullivan, BARRY, tragedian, born at Birmingham in 1824, first appeared at Cork in 1840, played at Edinburgh and elsewhere, and at the Haymarket in London as Hamlet in February 1852. He visited America in 1857-60, and Australia in 1861-66. He was afterwards for a while lessee of the Holborn Theatre; but he was more popular in the provinces, especially in Ireland and the west of England. He died at Brighton, 3d May 1891.

Sully, MAXIMILIEN DE BETHUNE, DUKE OF, the famous minister of Henry IV. of France, was the second of the four sons of François, Baron de Rosny, and was born at the château of Rosny near Mantes, 13th December 1560. At an early age he was committed to the care of Henry of Navarre, head of the Huguenot party, narrowly escaped the St Bartholomew massacre (1572), and accompanied Henry in his flight from court (1576). He took an active part in the war, had command of the artillery at Coutras (1587), and helped materially to decide the victory. He reached Ivry but an hour and a half before the battle, but was fortunate enough, though severely wounded, to capture the white standard with black crosses of Mayenne. He approved of the king's politic conversion, and throughout the whole of the reign remained his most trusted counsellor. His first task was to repair the ruinous finances of the realm, and to this gigantic labour he gave himself with an energy and persistence that entitle him to rank with Richelieu and Colbert among the few great ministers of France. Before his time not half the nominal sum raised from taxes reached the treasury, the whole administration being an organised system of pillage; but Rosny made a tour through the provinces armed with absolute authority, personally examined the accounts, discovered the actual delinquents, and dismissed or suspended them, besides compelling them to disgorge their ill-gotten gains into the treasury. All this he effected with iron rigidity and persistence, heedless of the clamour and

hatred of all the army of dishonest tax-gatherers and revenue-farmers, however high in station. In 1596, according to Henri Martin, the disposable revenue of the state was but nine millions of livres; in 1609 it was no less than about twenty millions, with a surplus as great in the treasury, and the arsenals and fleet besides in an excellent state of equipment. He brought actual order out of chaos, and would have done yet more for France but for the vast expenditure of the pleasure-loving king and his mistresses. Yet Sully was no far-seeing or philosophical financier, but only a dexterous master of expedients. He made no great innovations, but, if not a genius of creation, he was undoubtedly one of order. He distrusted manufactures as a source of prosperity, his main economic ideas summed up in his well-known aphorism, 'Labourage et pâturage sont les deux mamelles qui nourrissent la France.' His own honesty has been impugned by hasty writers, but, even if he himself grew rich in his years of office, there is absolutely no proof that he ever robbed his master.

In February 1601 he became grand-master of the artillery, and in March 1606 he was created Duke of Sully. After the assassination of his master he was forced to resign the superintendence of finance, but was allowed to retain the care of the woods and the artillery, and was even presented by Marie de Médicis with a reward of 300,000 livres. But his reign was at an end, and ere long he retired to his estate, surviving till December 22, 1641. In his retirement his Memoirs were compiled by his secretaries, and submitted to him, being actually composed in the awkward and tedious fashion of a narrative addressed to himself. Here naturally his own actions are put in the most favourable light; yet, although the judicious student will by no means accept the whole as completely historical, the work remains a document of priceless value for the reign of Henry IV. Chapter vi., treating of the remorse of Charles IX. after St Bartholomew, was copied from an earlier MS., doubtless entirely Sully's own work, and is an admirable example of direct and vigorous writing. The first and second folio volumes were printed under Sully's own eye (undated, but really in 1634); the third and fourth volumes were printed at Paris in 1662. These last contain the famous scheme of the countries of Europe, with the exception of Russia and Turkey, grouped into a grand Christian republic of fifteen states, kept in equilibrium by the magnificent chimera of an international Amphictyonic Assembly, with a rational rearrangement of boundaries and toleration for different faiths. The scheme is no doubt a dream of Sully's rather than Henry's brain, although it may well be that its germ may have been found in the careless talk of the king with his trusted minister as they paced together the broad walk of the Arsenal gardens.

Sully was a harsh and unamiable man, of vast self-esteem and little humour; but his unpopularity was a natural enough fruit of his inflexibility of principle, and his devotion to the interests of France and the person of his king it is absolutely impossible to gainsay.

The full title of his work is its best description: 'Mémoires des sages et royales Économies d'État, domestiques, politiques et militaires de Henri le Grand, l'exemple des rois, le prince des vertus, des armes, et des lois, et le père en effet de ses peuples français; Et des Servitudes utiles, obéissances convenables et administrations loyales de Maximilian de Béthune, l'un des plus confidants familiers et utiles soldats et serviteurs du grand Mars des Français; Dédies à la France, à tous les bons soldats et tous peuples français.'

Marbault, secretary of Sully's chief rival, Du Plessis-Mornay, wrote a severe criticism on the *Mémoires*—the foundation of the unhistorical and calumnious article on Sully in the *Historiettes* of Tallemant des Réaux. The

singular form in which the *Mémoires* was cast proved so intolerable to the 18th century that the Abbé de l'Écluse in 1745 re-edited the whole in ordinary form of narrative, but modernised and spoiled the work. The original text may be found in the collection of Michaud and Poujoulat (vols. xvi.-xvii.). See Sainte-Beuve's *Causeries du Lundi*, vol. viii.; also the books by Legouvé (1873), Gourdault (3d ed. 1877), Bouvet de Cressé (1878), Dusieux (1887), and Chailley (1888); also Ritter's study of the *Mémoires* (Munich, 1871).

Sully-Prudhomme, RENÉ FRANÇOIS ARMAND, a great French poet, was born at Paris, 16th March 1839, and after the early death of his father was brought up by his uncle, a notary, for his own profession. He studied the sciences, law, and philosophy, but soon devoted himself entirely to letters, and in 1865 published his first volume of poems, *Stances et Poèmes*, which had the good fortune to gain and to deserve the praises of the veteran critic Sainte-Beuve. One poem, the 'Vase brisé,' at once became widely popular. Later volumes, *Les Épreuves*, *Croquis Italiens*, *Les Solitudes*, *Impressions de la Guerre*, *Les Destins*, *Les Vaines Tendresses*, *La France*, *La Révolte des Fleurs*, extended his fame as a poet of great delicacy of feeling, as well as subtlety and depth of thought. His finest poems are steeped in a serene but penetrating melancholy, and almost all reveal sincerity of inspiration, nobility of aims, and an austere beauty of form that sometimes attains perfection. But he has ever been a thinker wrapped up in a poet's robe, and the things nearest his heart have been the graver questions of life and death, of good and evil. Masterpieces of analytic subtlety are his great didactic poems *La Justice* (1878) and *Le Bonheur* (1888), but the question remains debatable whether these themes really admit of poetic treatment. Other works are an accurate but somewhat harsh metrical translation of the first book of Lucretius (new ed. 1886); *L'Expression dans les Beaux Arts*, a contribution to the history of art; and *Réflexions sur l'Art des Vers* (1892). His *Œuvres Complètes* appeared in five volumes, 1882-88. He was elected to the Academy in 1881. See Caro, *Poètes et Romanciers*; and Jules Lemaitre, *Les Contemporains* (series i. and iv.).

Sulmona, or SOLMONA, a city of Italy, 80 miles by rail E. of Rome. It stands 1575 feet above sea-level, has a cathedral (1119), and paper and fulling mills. Here were born Ovid and Pope Innocent VII. On a mountain close by stood until 1870 the 'mother monastery' of the Celestines (q.v.). Pop. 14,171.

Sulphates. See SULPHURIC ACID; and for sulphides and sulphites, see SULPHUR.

Sulphocyanates, or SULPHOCYANIDES, are prepared by fusing cyanides with sulphur. These salts do not possess the poisonous character of the cyanides. *Sulphocyanide of potassium*, KCNS, is anhydrous, but very deliquescent, and occurs in long streaked colourless prisms, somewhat resembling nitre both in appearance and taste; it is extremely soluble in water, and fuses on the application of a gentle heat. The *sulphocyanide of mercury* is a white powder which possesses the property of swelling or growing in size to an almost incredible degree when moderately heated. The resulting mass often assumes a most fantastic shape, and is sufficiently coherent to retain its form; it is of a yellow colour externally, but black within. It is this sulphocyanide which is the ingredient of the toy known as 'Pharaoh's serpents.' Each serpent consists of a little cone of tinfoil, resembling a pastille in shape, and filled with the above-named compound. On lighting the cone at the apex, there begins to issue from it a thick serpent-like coil, which continues twisting

and increasing in length to an extraordinary degree, the serpent-like shape resulting from the salt being burned in the tinfoil cone.

Sulphonal, a synthetic hypnotic now largely used, of highly complex composition, with the formula $(\text{CH}_3)_2\text{C}(\text{SO}_2\text{C}_2\text{H}_5)_2$. It forms colourless tasteless crystals, very slightly soluble in cold water. For sleeplessness it is given in doses of 15 to 45 grains, but opinions differ as to the place it will ultimately take in medicine.

Sulphonic Acid. See DYEING, p. 142.

Sulphur is one of the most important of the non-metallic elements; sym. S, eq. 32, sp. gr. of rolled sulphur 1.98, and of amorphous sulphur 1.957; sp. gr. of vapour 6.617 at 900° (482° C.) and 2.2 at 1904° (1040° C.), atmospheric air being the unit of comparison for the vapour. At ordinary temperatures it exists as a solid, brittle, tasteless, and inodorous body, of a characteristic yellow colour, and insoluble in water. A piece of solid sulphur, heated to a temperature of 239° (115° C.), fuses into a thin yellow liquid; while in closed vessels it may by further heat be distilled, the boiling-point being about 836° (446° C.), and at this temperature it yields a deep yellow vapour of sp. gr. 6.617. When the sulphur-vapour comes in contact with cold air it condenses in the form of a fine yellow powder, known as *Flowers of Sulphur*. If fused sulphur be rapidly cooled it solidifies into a compact mass, of a granular crystalline texture; and if, in its liquid state, it be allowed to run into cylindrical wooden moulds, we obtain the ordinary roll-sulphur, or common brimstone. If allowed to cool slowly, it crystallises in long, glistening, deep yellow, oblique prisms, with a rhombic base, which, however, soon lose their most characteristic properties. As native sulphur is frequently met with in yellow crystals, whose form is derived from the octahedron with a rhombic base, it is obviously a dimorphous substance. Sulphur exists in several allotropic forms, red, black, or brown. When sulphur is heated it melts and forms a mobile amber-coloured liquid, which, by continued heat, gradually darkens, at the same time becoming more viscid, until a temperature of 356° (180° C.) is reached. Even though the heat be still continued, the temperature remains stationary for a time, but eventually it rises gradually to 500° (260° C.), the melted sulphur becoming less viscid. If at this stage it is poured into cold water it forms a tenacious ductile mass, which can be drawn out into threads having a certain amount of elasticity. In the course of a few hours these become brittle, and are seen to be crystalline in structure and in no way different from the original sulphur.

Sulphur is a bad conductor of heat, and the mere heat of a warm hand often causes it to crackle or even to fall to pieces, from the unequal expansion. It is an insulator of electricity, and becomes negatively electric by friction. It is slightly soluble in alcohol, ether, and the fatty oils; its best solvents being the bisulphide of carbon and chloride of sulphur. When it is heated in the air it takes fire at about 470° (243° C.), burning with a blue flame, and becoming converted into sulphurous acid, whose pungent suffocating fumes are characteristic of sulphur. This element is second only to oxygen in its powerful affinity for other elements, with most of which it unites, and often in several proportions. With most of the metals it combines very readily, and in some cases with a development of light and heat; thus, silver and copper burn in sulphur-vapour just as iron-wire or zinc-foil burns in oxygen. In consequence of its power, with the aid of heat, of forming sulphurous acid with the oxygen of the air, and thus rendering the latter incapable of supporting combustion, burning sulphur may be

usefully employed for the extinguishing of fire—as, for example, in chimneys.

Sulphur occurs very widely distributed in the mineral kingdom, partly free and partly combined with other elements. The free sulphur is either found pure in regularly formed crystals, or intimately mixed with earthy matters. Sulphur is usually plentiful in volcanic districts; most of what is used in Europe has been obtained from Sicily (which in 1880-90 exported from 213,000 to 350,000 tons yearly), but of late large quantities are recovered from the waste of soda manufacture, and sulphur has been actually exported from Newcastle to Italy (see SODA, p. 553). Sulphur is found in many parts of the United States, and some Californian deposits have been utilised to a small extent, but have been unable to compete with Sicilian sulphur. In the form of sulphide, sulphur occurs abundantly in combination with iron, copper (iron and copper pyrites), lead (galena), zinc (blende), &c., the bisulphide of iron (or iron pyrites) furnishing most of the sulphur that is employed in the manufacture of sulphuric acid. Many of the metallic sulphides (formerly known as *Sulphurets*) occur native, and form highly valuable ores. They are all solid at ordinary temperatures, and, with the exception of those of potassium, sodium, calcium, strontium, barium, and magnesium, are insoluble in water; they are, moreover, conductors of electricity. Many of them, especially of those that occur native, exhibit very brilliant and characteristic colours. The same metal may have several sulphides, and in general there is a sulphide for each oxide. The sulphides are, however, sometimes the more numerous. Sulphur is still more extensively distributed in the form of sulphates, as in the sulphates of lime, magnesia, baryta, &c. In the vegetable kingdom sulphur is a constituent of Albumen (q.v.), and of the volatile irritant oils of mustard, garlic, asafoetida, &c.; moreover vegetable juices contain it in the form of certain sulphates. In the animal kingdom it is not only a constituent of the albuminous, fibrinous, and gelatinous tissues, but of the hair, saliva, bile, urine, &c.

The grosser impurities of sulphur are removed by crude processes of fusion and distillation at or near the place from whence it is obtained. What is called refined sulphur is purified by distillation in a large cast-iron still, and condensed in a receiver kept cool. When the vaporised sulphur is condensed in a large chamber it is obtained in the form of sublimed sulphur, or flowers of sulphur; but as the walls get hot it melts and collects on the floor, and is run into cylindrical wooden moulds, from which, when cool, it is taken out as roll or stick sulphur. The residue left in the retort is a mixture of sulphur with various impurities. Under the name of black sulphur, or *Sulphur vivum*, it is used in veterinary medicine, and for the purpose of dressing mouldy hops. Sulphur is thrown down from certain of its compounds (as from a strong solution of a polysulphide of calcium, sodium, or potassium) by dilute hydrochloric acid; it falls as a grayish-white, very fine, light powder, known in the *Materia Medica* as milk of sulphur, or precipitated sulphur. The most common impurities met with in ordinary commercial sulphur are selenium and realgar (bisulphide of arsenic). Flowers of sulphur frequently exhibit a slight acid reaction, in consequence of a little sulphurous acid clinging to them. By rinsing them with water this impurity is at once removed.

Sulphur is extensively employed in the arts and manufactures, as in the manufacture of some matches, gunpowder, &c. When converted into sulphurous acid it is employed as a powerful bleaching agent, as also for the destruction of

insects, fungi, &c.; but its chief consumption is in the manufacture of sulphuric acid.

The eight compounds of sulphur and oxygen, when combined with water, present the characters of acids. These acids have this composition:

Hyposulphurous acid	H ₂ SO ₂
Sulphurous	"	H ₂ SO ₃
Sulphuric	"	H ₂ SO ₄
Thiosulphuric	"	H ₂ S ₂ O ₃
Dithionic	"	H ₂ S ₂ O ₆
Trithionic	"	H ₂ S ₃ O ₆
Tetrathionic	"	H ₂ S ₄ O ₆
Pentathionic	"	H ₂ S ₅ O ₆

We shall here notice the most important members of this group—the second, third, and fourth; the third, *Sulphuric Acid*, is discussed in a special article. (The last four derive the essential part of their name from the Greek *theion*, 'sulphur'.)

Sulphurous Anhydride (often called Sulphurous Acid), SO₂, occurs under the ordinary relations of temperature and pressure as a colourless gas, possessing the suffocating odour of burning sulphur. In its concentrated form it is quite irrespirable, and in a diluted state it excites cough. It not only is incapable of burning, but it rapidly extinguishes the flame of burning bodies. It is very freely soluble in cold water, which at 32° (0° C.) takes up nearly 69 times its volume of the gas, while at 75° (24° C.) it only takes up 32 volumes; the solution known as *Aqueous Sulphurous Acid* having at first the same smell and taste as the gas, but soon absorbing oxygen from the air, and becoming converted into sulphuric acid. By the action of cold sulphurous acid may be condensed to a colourless transparent limpid liquid, which freezes at -105° (-76° C.), forming a transparent crystalline solid. The specific gravity of the gas is 2.247 (atmospheric air being the unit), and that of the liquid is 1.49 (water being the unit), the solid being considerably heavier. Although dry sulphurous acid gas and dry oxygen when mixed exert no action on one another, there are many conditions under which sulphurous acid rapidly absorbs oxygen, and is converted into sulphuric acid—e.g. if the gas be dissolved in water; a similar action takes place under the influence of hydrated nitric acid, iodic acid, and certain metallic oxides. Hence sulphurous acid is a powerful reducing or deoxidising agent. This gas is a common and abundant product of volcanic action, and is occasionally met with in solution in the springs in volcanic regions. It may be prepared artificially by simply burning sulphur in the air or in oxygen gas, or by heating in a flask 4 parts of flowers of sulphur mixed with 5 parts of powdered black manganese, sulphurous acid and sulphide of manganese being the products, as shown by the equation S₂ + MnO₂ = SO₂ + MnS. In consequence of its solubility in water this gas should be collected over mercury. In addition to the uses of sulphurous acid as a bleaching agent, it is valuable both as a disinfectant agent and as a powerful antiseptic, and has been used as an application for lumbago, &c. But by far its most important use is in the manufacture of sulphuric acid. In combination with bases this acid forms the *sulphites*—a class of salts which, excepting the sulphite of soda, are of little importance, except for their power when moist of extracting oxygen, and thus acting as reducing agents. The salts of the sesquioxide of iron are reduced by them to salts of the protoxide.

Thiosulphuric Acid, H₂S₂O₃, formerly called Hyposulphurous Acid, is, as yet, only known in a state of combination with bases; for on attempting to separate the acid from the base the former becomes decomposed into sulphur and sulphurous acid. The most important of its salts is the *Hypo-sulphite of Soda*, Na₂S₂O₃ + 5H₂O, described in the article SODIUM. This and other soluble hypo-

sulphites may be easily recognised by the facility with which they dissolve the haloid salts of silver, forming a solution of an extremely sweet taste, and containing a double hyposulphite of silver and soda, with an admixture of chloride, iodide, or bromide of sodium. It is this power of dissolving those salts of silver which are insoluble in water that renders the hyposulphite of soda useful in photography.

With hydrogen sulphur forms two compounds: (1) *Persulphide of Hydrogen*, an oily liquid, having the smell and taste of sulphuretted hydrogen; (2) *Sulphuretted Hydrogen*, H_2S , known also as Hydro-sulphuric Acid and Sulphydic Acid, a natural gaseous constituent of many Mineral Waters (q.v.), as for instance Harrogate and Strathpeffer in Great Britain. It is formed spontaneously wherever organic compounds containing sulphur undergo putrefaction, as in stagnant sewers and cesspools and in waters charged with organic matter and sulphates. By acting on sulphide of iron with dilute sulphuric acid, sulphate of iron is produced and sulphuretted hydrogen liberated.



Sulphuretted hydrogen is a poisonous colourless gas, with the nauseous odour of rotten eggs. By pressure it may be liquefied and solidified. It is soluble in one-third of its volume of water; but the solution does not keep well unless preserved from contact with air. It is readily combustible, burning with a blue flame, and forming water, sulphurous acid, and usually a little sulphur. It has a weak acid reaction, but combines readily with bases forming sulphides. It is very poisonous, birds perishing in air containing $\frac{1}{1000}$ part, and dogs in air containing $\frac{1}{15}$ part of the gas. Owing to its presence in illuminating gas silver becomes tarnished in rooms where gas is burned, while librarians find the bindings of their books become corroded by the sulphuric acid eventually produced by the combustion of the gas. From its property of forming insoluble sulphides with most metals, sulphuretted hydrogen is the sheet anchor of the analytical chemist. These insoluble sulphides again are some of them produced in an acid solution, and some only in an alkaline one. It follows that by first acidifying the solution to be analysed and then adding the sulphuretted hydrogen certain metals will be removed as insoluble precipitates, while others will have been unaffected. On now adding an alkali a second portion will be removed, and so a working method of separating the metals can be devised. The simplest test for sulphuretted hydrogen at the mouth of a drain is the use of blotting-paper soaked in solution of acetate of lead. This rapidly turns brown in presence of the gas.

Sulphur combines with carbon to form *Bisulphide of Carbon*, CS_2 , a colourless, inflammable liquid, heavier than water, and having a disagreeable odour and taste. It is soluble in alcohol, but not in water, and it is a powerful solvent of fats, sulphur, phosphorus, and india-rubber. Owing to its high refractive power it is used in the construction of prisms. It may be obtained by heating fragments of charcoal to bright redness in a porcelain tube, and passing sulphur vapour along it. Its vapour when freely inhaled exerts an anæsthetic action similar to that of chloroform and ether. Workmen in caoutchouc or other manufactures in which bisulphide of carbon is used as a solvent suffer from prolonged exposure to its vapour, which produces headache, loss of appetite, impairment of vision and hearing, and causes general derangement of health by its deleterious action on the nervous system.

Sulphur combines with chlorine in several proportions, the most important of these compounds

being the *Dichloride of Sulphur*, SCl_2 , and the *Chloride of Sulphur*, S_2Cl_2 . Both of them are liquids, and are formed by the direct action of the combining elements. The chloride is a yellow liquid which is decomposed by contact with water—sulphur, hydrochloric, and other acids being produced. It is capable of dissolving about 67 per cent. of sulphur at an ordinary temperature, and, like bisulphide of carbon, is extensively employed in vulcanising india-rubber. The dichloride of sulphur is formed by saturating the chloride with chlorine; a deep-red liquid, resembling the previous compound in most of its properties; it is decomposed by the sun's rays into the chloride and free chlorine.

Sulphur seems to have been known from the earliest times, and sulphuric acid was most probably known to the Arabians; the English manufacture of sulphuric acid dates, however, only from the 18th century. Sulphur is used for various purposes in medicine. It is given internally either as sublimed sulphur (flowers of sulphur) or as precipitated sulphur (milk of sulphur), in somewhat large doses, as a mild cathartic—generally combined with jalap and cream of tartar. The *Confection of Sulphur* of the Pharmacopœia is composed of sulphur, cream of tartar, and syrup of orange-peel rubbed together—the dose being from half an ounce to an ounce, or from one to two tablespoonfuls. In small doses sulphur is of great value in cases of atonic gout and chronic rheumatism. The external use of sulphur in the form of ointment has been already noticed in the article ITCH. It is also used externally in other cutaneous disorders, particularly in lepra and psoriasis; its application in the form of vapour is often of service.

Sulphuric Acid, H_2SO_4 , is the chemical name of the liquid commercially known as *Oil of Vitriol*—so called from its having been first produced by the distillation of green vitriol (sulphate of iron). It is an odourless, dense, oily-looking liquid, sp. gr. 1.842. When pure it is colourless, but usually it is of a straw to brown colour, derived from impurities which have fallen into it and been charred. It has all the properties of a typical acid, being intensely corrosive and changing vegetable colours. Exposed to the air it absorbs water, and when mixed directly with water great heat is evolved, the liquids contracting in bulk. It does not evaporate at ordinary temperatures, and dilute solutions spilt on cloth gradually become stronger till the acid begins to destroy the fibres of the cloth. Oil of vitriol, or the protohydrate, is not the only hydrate of sulphuric acid. Three others are known to exist. When the fuming oil of vitriol of Nordhausen is exposed to a low temperature a white crystalline substance separates, which is a hydrate, containing half as much water as the common liquid acid; its formula is $H_2SO_4SO_3$, and its fusing-point is 95° (35° C.). Again, a mixture of 49 parts of the strong liquid acid and 9 parts of water freezes at 47° (8.3° C.), and crystallises into splendid rhombic prisms, from which property it is often termed *glacial sulphuric acid*, with sp. gr. 1.780. Lastly, when a very dilute acid is concentrated by evaporation *in vacuo*, at 212° (100° C.), till it ceases to lose weight, there will be a resulting compound, consisting of 40 parts of the real acid and 27 of water, and represented by the formula $H_2SO_4 \cdot 2H_2O$. The compound formerly known as *anhydrous sulphuric acid* possesses none of the characteristic properties of an acid; see SULPHURIC ANHYDRIDE.

Sulphuric acid in its free state is a very rare natural product; although in combination with bases it is common in the animal and vegetable, and abundant in the inorganic kingdom. In plants

it exists in the juices, and in animals in the blood and its derivatives chiefly in the form of sulphates of the alkalies; while in the mineral kingdom it occurs as gypsum (sulphate of lime), heavy spar (sulphate of baryta), celestine (sulphate of strontia), &c. It may be prepared on a small scale by boiling sulphur in *aqua regia* or in nitric acid, the sulphur becoming gradually oxidised into sulphuric acid. As a general rule, however, the commercial acid is employed even for laboratory experiments. In order to obtain the acid in a pure form, suitable for medical use or medico-legal analysis, it must be redistilled with sulphate of ammonia in a retort containing a few slips of platinum foil, the first and last portions being rejected. The distillation is attended with violent concussions, partly owing to the high specific gravity of the acid, and partly owing to its high boiling-point, and this convulsive action is moderated mechanically by the platinum slips. Sulphuric acid thus prepared according to the directions of the British Pharmacopœia may be regarded as perfectly pure, presuming arsenic is not present. Strong sulphuric acid has comparatively little action on the metals except at a high temperature, when it dissolves them, and at the same time undergoes partial decomposition; the metal being oxidised by a portion of the acid which becomes decomposed into oxygen and sulphurous acid, and then uniting with a portion of undecomposed acid to form a sulphate. Silver, copper, mercury, arsenic, antimony, bismuth, tin, lead, and tellurium are thus acted on. Gold, platinum, rhodium, and iridium are not affected by the acid even at a boiling temperature. The more oxidisable metals, such as zinc, iron, nickel, and manganese, are readily soluble in the dilute acid, water being decomposed and hydrogen liberated, while the oxygen of the water unites with the metal; and the metallic oxide, at the moment of its formation, combines with the sulphuric acid to form a sulphate.

The *sulphates*—or salts formed by the combination of sulphuric acid with a base—are generally composed, as in the case of green vitriol, $\text{FeSO}_4 \cdot 7\text{H}_2\text{O}$, of 1 equivalent of acid and 1 of metallic oxide, with or without water of crystallisation. With the alkalies this acid also forms acid salts, as bisulphate of potash, and in a few cases—copper, for example—it forms basic salts. The insoluble sulphates, such as that of baryta, may be obtained by precipitating a soluble salt of the base by a soluble sulphate; thus, nitrate of baryta and sulphate of soda yield an insoluble sulphate of baryta and nitrate of soda, which remains in solution. The soluble sulphates may be prepared by dissolving the oxide or carbonate in dilute sulphuric acid, in those cases in which the metal itself is not readily attacked by the acid. Sulphuric acid and the soluble sulphates are easily detected by their yielding, with a solution of a baryta salt, a white precipitate of sulphate of baryta insoluble in acids.

Sulphuric acid is prepared on a large scale by two distinct processes—viz. by the distillation of green sulphate of iron—the original process of Basil Valentine (15th century); and by the oxidation of sulphurous acid through the agency of nitrous acid

and hyponitric acid. The first process is chiefly employed at Nordhausen in Germany. The sulphate of iron is distilled in earthen retorts, and the acid passes over into a receiver containing a little ordinary sulphuric acid, forming a brown fuming oily liquid, of about sp. gr. 1.900. This acid is known in commerce as Nordhausen acid, and is chiefly used for dissolving indigo.

The second method is that universally followed in Great Britain, the germs of which were likewise discovered by Valentine. He observed that when the fumes of burning sulphur were collected under a bell jar, slightly moistened with water, a small quantity of liquid was deposited. This liquid, which was simply sulphuric acid, on being concentrated from its solution by boiling was long sold as oil of sulphur at prices as high as 2s. 6d. per ounce. About the year 1740 the French chemists Lefevre and Lemery suggested that, by the use of nitre along with the sulphur, the operation might be conducted in close vessels, and a much greater quantity of acid might be produced. This idea was acted on in England by Dr Ward, who established works at Twickenham and Richmond, conducting his manufacture by burning the mixed sulphur and nitre in large stoppered glass receivers, into each of which a small quantity of water was first introduced. The substitution, in 1746, by Dr Roebuck of Birmingham, of lead chambers in place of the glass vessels may be regarded as essentially the establishment of the process of manufacture followed at the present day.

The first stage in the manufacture of sulphuric acid is the preparation of sulphurous acid by the burning of sulphur or of iron pyrites. Previous to the year 1838 Sicilian sulphur was almost exclusively used in the manufacture, but in that year

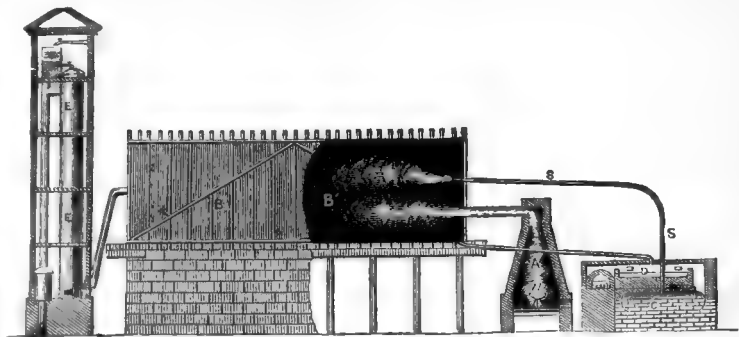

A, sulphur-burner, or furnace; B, lead chamber, shown in section at B'; C, steam-boiler; D, leaden pan; E, coke tower; S, steam-pipe; n, nitre pot.

the establishment of a monopoly of the sulphur trade by the Sicilian government, and its consequent increase in price, diverted the minds of manufacturers to the employment of iron pyrites (sulphide of iron). Iron pyrites is now much more used than sulphur, and the only hindrance to its universal adoption is the presence of foreign matter in the pyrites, the most deleterious being arsenical compounds; and it has hitherto been found impracticable to free the sulphuric acid wholly from the arsenious acid which renders it inapplicable for many purposes.

When sulphur is the material used for producing the sulphurous acid it is burned in an oven or 'burner' (A) of brickwork, having a sole or bottom of iron, termed the 'burner-plate.' Under this a small fire is at first lighted, which is allowed to go out after the sulphur has ignited. A little above the sulphur a small pot, called the nitre pot, n, is either placed on a stand or hung from the roof.

filled with a quantity of either nitrate of soda or nitrate of potash, with sulphuric acid sufficient for its decomposition—8 or 10 lb. of the nitre with 5 or 6 lb. of sulphuric acid being allowed for every cwt. of sulphur. The decomposition of the nitre by the action of heated sulphuric acid furnishes nitric acid fumes, which go over into the chamber along with the sulphurous acid. The sulphurous acid readily abstracts from the nitric acid the additional oxygen required for its conversion into sulphuric acid, reducing the nitric acid to nitric oxide, NO. Nitric oxide in its turn quickly converts itself into nitric peroxide, by the abstraction of additional oxygen from the air that is constantly entering the chamber through the burners. Again, in the presence of moisture which is supplied by a jet of steam from the boiler, C, sulphurous acid readily deprives the nitric peroxide of oxygen, and thus forms more sulphuric acid, and again liberates nitric oxide; which is ready once more to seize upon the oxygen of the air, and would continue so acting and reacting *ad infinitum*, were it not carried forward and out by the chimney.

The chamber is an immense box or room of lead, bound together with a strong framework of timber, and generally raised on arches several feet above the ground. Chambers vary in size from 60 to 140 feet in length, and from 20 to 40 feet in width and height. Curtains of lead proceeding alternately from the bottom to near the top, and *vice versa*, are very frequently used; they serve to retard the progress of the gases, and thus ensure the transformations desired. The floor of the chamber is covered with water, into which the sulphuric acid falls as it is formed; and when this solution attains a certain strength it is tapped off for concentration. When the gases reach the chimney, on account of the reactions of the nitrous compounds already explained, a large amount of nitrous acid would not only be wasted, but would also be deleterious to the neighbourhood, were steps for its recovery not adopted. This recovery is usually effected by means of a tower filled with coke, F, down which a constant stream of strong sulphuric acid trickles, the acid absorbing the nitrous fumes in their way upwards. Instead of a single chamber, curtained off or not as the case may be, sometimes three or five distinct chambers, connected by pipes, are employed, those communicating directly with the burners being termed working chambers, and the others receiving chambers, the last either acting as or communicating with a condenser or chimney.

When iron pyrites is used as the source of sulphurous acid suitable burners are used. In England these are arched chambers about four feet each way, on plan with furnace-bars placed a little above the ground. There are also the necessary doors and air-holes. The pyrites is broken into pieces and spread in layers on the bars, which are previously heated to redness, and the heat evolved by the burning sulphur is thereafter sufficient for the fresh charges. The exhausted ore is frequently sufficiently rich in copper for its extraction; indeed, when there is as little as 2½ per cent. present in pyrites it is now recovered. In consequence of strong sulphuric acid absorbing both sulphurous acid and nitrous acid, the acid requires to be drained off from the chamber while the solution is comparatively weak, at which strength—viz. of a specific gravity of about 1·4—it is used for some purposes in the arts under the name of 'Chamber Acid.' This is concentrated by evaporating in lead pans, D, till it reaches the specific gravity of 1·6, then boiling in a platinum retort, on which strong acid does not act, even at high heat, or in large flint-glass retorts. In the process introduced in 1859 by Mr Glover the gaseous

sulphuric acid from the sulphur or pyrites burners is not conducted direct to the lead chamber, but is first passed through a Glover's or denitrating tower, and there purified of nitrogen compounds, which are saved for use in the lead chamber.

The manufacture of sulphuric acid is a very extensive industry; immense quantities of it being consumed in the manufacture of Soda (q.v.), in that of bleaching-powder, in calico-printing and dyeing, and in fact in most chemical operations both in the manufactory and the laboratory. In medicine a dilute sulphuric acid, formed by gradually mixing the strong purified acid with water, or aromatic sulphuric acid (known also as *elixir of vitriol*), prepared by mixing sulphuric acid, rectified spirit, tincture of ginger, and spirit of cinnamon, are almost always employed. In doses of from ten to thirty minims, properly diluted, these preparations exert a strong astringent power, and are serviceable in all forms of passive hæmorrhages, and in checking inordinate discharges when they arise from debility. Poisoning with this and other irritant acids is noticed at POISON, Vol. VIII. p. 265.

There are works on the manufacture by Smith (1873), Lock (1879), and Lunge (new ed. 1891).

Sulphuric Anhydride, SO₂, is obtained by distilling fuming Nordhausen sulphuric acid, a fibrous mass of silky crystals being deposited in the receiver. It may also be prepared by the distillation of anhydrous bisulphate of soda. It is a tough solid, melting at 65° (18·3° C.), and possessing none of the properties of an acid, not even affecting the skin. In contact with moisture much heat is developed, and it then possesses the corrosive properties of sulphuric acid.

Sulphuric Ether. See ETHER.

Sulphurous Acid. See SULPHUR, p. 795.

Sulpicians, an order of priests for training young men for the church, founded in 1645, and named from the church of St Sulpice (q.v.) in Paris.

Sulpicius Severus (363–410), a Christian historian, born in Aquitaine, who wrote a *Historia Sacra* from the Creation downwards, and a *Life of St Martin* (q.v.) of Tours.

Sultan (Arab., Turkish, and Persian *Sultán*), a Mohammedan ruling prince or monarch, as of Morocco or Zanzibar; especially used of the Sultan of Turkey, who calls himself Sultan of Sultans. The name of *Sultana* is given to the mother, wife, or daughter of a sultan. The old English form of the word was *Soldan* or *Sowdan*.

Sulu Islands, an archipelago stretching from Borneo north-eastwards to the Philippines, in the south-east of Asia. The group, numbering 162 islands in all, most of them mountainous and all covered with luxuriant vegetation, has a total area of 948 sq. m. and a total pop. of 75,000. The inhabitants, Malays by race and Mohammedans by religion, were bold pirates, until the Spaniards conquered them in 1876. The latter retired from the archipelago as a result of the Spanish-American war (1898), and in 1899 the sultan of Sulu acknowledged the sovereignty of the United States. The town of Sulu was taken in 1851 by the Spaniards, by whom it was much improved. It is on the north-west coast of Sulu Island, and has a good roadstead.

Sumach, Sumac, or SHUMACK (*Rhus*), a genus of small trees and shrubs of the natural order Anacardiaceæ; having small inconspicuous flowers in panicles or in corymbs, and the fruit a small, nearly dry drupe. The species are numerous, diffused over almost all parts of the world, except its coldest regions and Australia; some of them are useful in the arts and in medicine, and some

are remarkable for their poisonous properties. Venetian Sumach (*R. cotinus*), known also as Wig



Sumach (*Rhus cotinus*), showing leaves, flowers, and fruit.

Sumach (*Rhus cotinus*), known also as Wig Sumach, or Wig Tree, is a native of the south of Europe and west of Asia, and is often planted in Britain as an ornamental shrub. It has simple leaves, and hairy corymbs of fruit, which have a sort of resemblance to periwigs. The twigs and leaves dye yellow (see FUSTIC), and are used in tanning. The bark has been used as a substitute for Peruvian Bark. The seed resembles the almond in flavour. The very acid fruit of the Sicilian or Elm-leaved Sumach (*R. coriaria*)—a native of the countries around the Mediterranean, with pinnate leaves, not unfrequent in British shrubberies—has been used as a condiment, and the seeds and the leaves medicinally as tonic and cooling. This species is also used for tanning and dyeing. Similar to this in its properties is the Virginian Sumach, or Stag's-horn Sumach (*R. typhina*), a native of eastern North America, and common in British shrubberies, which has the branches curiously crooked, and covered when young with a soft velvety down. It has pinnate leaves, with numerous leaflets, and is valuable as an astringent and refrigerant. The milky juice which exudes from incisions made in the bark affords a varnish. The flowers supply abundance of honey. The Smooth-leaved Sumach (*R. glabra*), a very similar species, also North American, has very acid leaves, and this species is sometimes troublesome as a weed. Of the acid and poisonous species the most important is the Poison Ivy (*R. toxicodendron*) of North America, a shrub from 1 to 3 feet high (when it is also called Poison Oak), or a climber, with leaves of three leaflets, and a milky juice, which becomes black on exposure to air. The leaves have been used in medicine as a stimulant of the nervous system. Similar to this in properties is the Poison Sumach (*R. venenata*), with from 7 to 13 leaflets, also known as Poison Elder and Swamp Dogwood, and other North American species, the juice of which is very acid; even the emanations are injurious to some persons, who, from standing close to these plants, or from handling them, experience a cutaneous eruption with violent itching. The Varnish Sumach (*R. vernicifera*), a native of Japan and Nepal, yields a varnish much used in Japan for lacquer-work. *R. metopium* yields in great abundance a gummy resin, which in a pure state is yellow in colour, and of a hard brittle consistence. *R. pumila* is regarded as one of the most poisonous of the genus. *R. succedanea*, a native of Japan, yields a fleshy fruit containing a nut, which yields an oil that is made into candles.—The name Tanners' Sumach is given to *Coriaria myrtifolia*, a shrub of the south of Europe.

Sumatra (so called probably from the ancient town of Samudera in the north) is after Borneo the largest island of the East Indian Archipelago or Indonesia, having an area not much less than that of Spain, calculated on very imperfect data at 165,600

sq. m. (or, including the numerous and important islands off the coasts, 170,780 miles). Towards the middle it is crossed lengthwise by the equator, and it extends from 5° 40' N. lat. to 5° 59' S. lat., and from 95° 16' to 106° 3' 45' E. long. The greatest length is 1115 miles, the greatest breadth 275. An imposing mountain-system—the Bukit Barisan, or Chain Mountains, consisting of several more or less parallel ranges (7000 to 10,000 feet high), with intervening plateaus and valleys—forms the framework of the island, which has a bold and frequently precipitous coast towards the west, but has been carried eastward by the formation of vast expanses of alluvial ground. This striking contrast between east and west has been produced in part by the difference between exposure to the full force of the Indian Ocean and the shelter afforded by the Malacca Peninsula and the other islands of the archipelago. Slates and clay-schists of high antiquity, with granite not so frequently visible, form the original kernel of Sumatra, which has been subsequently modified by Carboniferous strata, long afterwards by Tertiary breccias, sandstones, marls, and coal-beds, and still further by very extensive Post-tertiary deposits. Volcanoes have played a large part in embossing the surface. Of the numerous cones along the Bukit Barisan ranges some seven or eight are still active, including Indrapura (the culminating peak of the island, 11,800 feet), Merapi (the most restless), Pasaman or Mount Ophir (which broke out in 1891), &c. In 1883 the southern end of the island was involved in the Krakatoa eruption. The mountain-lakes, which are characteristic of the island, are largely of volcanic, and more especially of craterial origin; of these the most important are the Singkarah, the Korintji, the Ranau, and the Tobah. Towards the west the rivers of Sumatra are of necessity short and rapid, but several of the eastward streams, the Rokan, Siak, Indragiri, Jambi, and Palembang or Musi, grow to imposing rivers in their passage through the plains. They are fed by an abundant rainfall; the average precipitation at Deli, for example, is 83 inches per annum. The clouds descend much lower than in other islands of the archipelago. The division of the seasons is of course quite opposite in the two halves of the island lying respectively north and south of the equator. Hail-storms are not infrequent in the higher regions. The Sumatra flora is exceptionally rich. Jungluhn's paradox that an ape could traverse the island from north to south without descending to the ground is almost literally true. Vast but too rapidly diminishing areas of the mountain regions are covered with virgin forest, a striking contrast to the vast prairies of alang (oralang), that vigorous grass which seizes on every clearing not occupied by human industry. Though it only explored a small portion of the western side of the island, the Dutch expedition of 1877-79 collected 400 varieties of timber. The vegetation-contours of the island descend much lower than those of Java. In Java, for instance, the oaks do not grow below an altitude of 4500 feet; in western Sumatra they come down to within 500 or even 100 feet of sea-level. The flora of the east coast is almost entirely unexplored. Rice, sugar (from cane and the Arenga palm), coffee, pepper, cocoa-nuts, sago, maize, sweet potatoes, yams are among the principal cultivated products. In recent years the tobacco of the Deli district, grown by Dutch planters with Chinese coolie labour, has become favourably known both in European and American markets. Of several minerals existing in average quantities in the island only two, gold and coal, are worked to any economical result, the latter especially at Ombilin, united with the west coast by railway in 1891. The petroleum wells of Langkat (Lankhat) are very rich.

The Sumatran fauna is of peculiar scientific interest. Of the 112 mammals known to exist in the island (19 more than those in the larger island of Borneo) 45 are common to Borneo and 39 to Java. The birds are in the main Bornean, and the same is true of the snakes (44 species). The Bornean forms, however, are almost entirely confined to the eastern side of the island; as soon as the naturalist crosses the Barisan Mountains he finds himself in a new region. The Orang-outang (of limited range and not abundant) and the *bru* (Malay name) or Meester Kees (Dutch), employed by the natives to gather their cocoa-nuts, are the most noteworthy of the numerous apes. The true tiger, the bruang or Malay bear, the much-hunted rusa deer, the dainty kanchil deer, the Malay hog, the tapir, the two-horned Sumatran rhinoceros, and the Sumatran elephant are characteristic forms. Among the commonest birds are Argus pheasants, hornbills, goatsuckers, and grakles (one species of the latter largely kept in cages for their parrot-like powers of speech). Both the python (15 to 20 feet long) and the cobra are of frequent occurrence, and the crocodile swarms towards the coast and ascends the rivers as far as the foot of the mountains. As an indication of the extraordinary variety of insect life, 250 species of spiders have been discovered since 1858.

Sumatra is peopled in the main by tribes of the Malay stock, differing very markedly, however, in degree of civilisation, custom, and language. An earlier non-Malay element is more or less distinctly represented. The Kubus, a savage forest-dwelling race, the Battas (q.v.) or Batahs—now one of the best-known and ethnographically most interesting tribes—and the Redjangers may be singled out from a host of others. Hindu influences, which have left their mark in ruins of temples, religious customs, language, alphabets, &c., began to tell on Sumatra at a period prior to the 7th century. In the 13th Mohammedanism was introduced. The island became known in 1508 to Europeans through the Portuguese Lopez de Figuera, whose fellow-countrymen were not long in founding trading stations on the coasts. The Portuguese were ousted by the Dutch towards the close of the 16th century. Begun in 1620 by their East India Company, the permanent Dutch occupation was not completely carried out round the coast till 1881, and much of the interior is still semi-independent and unexplored. The Dutch possessions were in the hands of the British between 1811 and 1816, and portions down till 1825. The residency of the East Coast was established in 1873; the government of the West Coast in 1819; and the residencies of Bencoolen, Palembang, and Lampong respectively in 1824, 1825, and 1857. Atjeh, Achin, or Acheen (q.v.), only subdued after a long war (1875-79) and not yet pacified in 1892, was formed into a government in 1881. The total population of Sumatra and the adjacent islands is estimated at 3,572,000 (Achin, 445,000; west coast, 1,457,500; East Coast, 450,000; Bencoolen, 151,800, &c.). Among the more important centres of population are Padang (150,000), Achin (10,000), Bencoolen (12,000), and Palembang (43,000).

For literature on Sumatra, see *Aardrijkskundig Woordenboek van Ned. Ind.* (1869); Kan in *Tijdschrift van het K. Ned. Aard. Gen.* (1889). See especially Marsden's classical work, *The History of the Island of Sumatra* (1783); the Memoir of Sir Stamford Raffles; Veth, *Midden-Sumatra* (1882); Kielstra, *Atjeh Oorlog* (1885 & 6); Wallace, *Indian Archipelago*; Forbes, *A Naturalist's Wanderings in the E. Archipelago* (1885); Hagen, 'Die Pflanzen- und Tierwelt von Deli auf der Ostküste Sumatras,' in *Tijds. van het N. Aard. Gen.* (1890). Recent explorations are those of Schouw-Santvoort (1877), Brenner-Felsach (1887), and Isermann (1891).

Sumbawa, one of the chain of the Sunda Islands to the east of Java, lies between Lombok (on the west) and Flores (on the east). Area, 5192 sq. m.; pop. about 160,000, all Malays and Mohammedans. They are divided between four native rulers, who owe allegiance to the Dutch governor of Celebes. The islands are mountainous but fertile, and yield rice, tobacco, cotton, sandalwood, &c. In 1815 an eruption of Tambora, the loftiest peak on the island, whereby the altitude was decreased from 14,000 to 7670 feet, depopulated the kingdoms of Tambora and Papekat, 12,000 lives being lost, and great damage done to the whole island by the ashes. Another eruption took place in 1836, and one of another peak, Gunong Api, in 1860, though with little loss.

Sumir. See BABYLONIA, Vol. I. p. 631.

Summer Isles, a group of twenty rocky islets off the west coast of Scotland, near the entrance of Loch Broom, an inlet in the north-west of Ross-shire. The largest, Tanera, measuring $1\frac{1}{2}$ by $1\frac{1}{4}$ mile, rises 406 feet, and has 119 inhabitants.

Summons, in English law, means generally a writ or order directed to a party to appear and answer some complaint before a court or judge. All actions in the High Court now begin with the issue of a writ of summons. A summons is usually the first step in summary proceedings before magistrates. In Scotland the first writ in an action is called a summons; and the term is also in use in the colonies and in the United States.

Sumner, CHARLES, orator and statesman, was born in Boston, Jan. 6, 1811. The founder of the family in America was William Sumner, a native of Oxfordshire in England, who settled in Massachusetts about 1635. Charles Pinckney Sumner, of whose nine children Charles and his twin-sister Matilda were the eldest born, held the post of sheriff of Suffolk county from 1825 till shortly before his death in 1839, and was highly respected for his probity and independent spirit, despite his stiff and formal manners and his outspoken anti-slavery sentiments at a time when such opinions were generally unpopular and were rarely expressed by persons in official station. Educated at the Boston Latin School and at Harvard College, where he graduated in 1830, Charles Sumner entered the law-school in the following year, and in 1834 was admitted to the bar. An enthusiastic student of the principles of law, he had little taste for the ordinary routine of office work, and hence, though occasionally engaged in important cases, he failed to secure a remunerative practice or to acquire reputation as a pleader. He found more congenial employment as a lecturer on legal topics and a contributor to law journals and compilations. In private life he was greatly esteemed for his sincerity and earnestness, his general cultivation, his stainless character, and his cheerful and kindly demeanour, though too devoid of humour, wit, and playful fancy to become a favourite in ordinary social circles. In December 1837 he went to Europe, where he remained till May 1840, pursuing with his habitual assiduity the study of jurisprudence at the Sorbonne and elsewhere, widening the general range of his knowledge, and cultivating the acquaintance, especially in England, of the most eminent men, of whom his letters at this period, published since his death, give many graphic sketches and lively anecdotes. On his return to Boston he resumed his professional practice, but with even less liking for the drudgery of its details than he had before evinced. Abstract discussion had stronger attractions for him, and he first came into prominence by a civic oration, on July 4, 1845, which, under the title of 'The True Grandeur

of Nations,' was simply a vehement denunciation of war, as 'utterly and irreconcilably inconsistent with true greatness.'

It was because the current of events was then bringing to the front a subject involving the deepest moral considerations that Charles Sumner was drawn into the vortex of political life. A member of the Whig party by descent and associations, he took but a languid interest in politics until the threatened extensions of negro slavery over newly-acquired territory awakened a spirit of resistance in the free states. Despite the efforts to stifle agitation by party leaders and all who feared for the results, the growth and preponderance of the slave power, with the foundations on which it rested, became the absorbing question of the day, entering like a wedge into established political combinations and thrusting aside all other issues. Sumner was at one with the Abolitionists in asserting the inherent and total sinfulness of slavery; but unlike them he maintained that the constitution did not recognise property in man, and that slavery, a purely sectional institution, could be combated in the political arena, and so crippled by legislation that it would necessarily dwindle and become extinct. In 1848 he joined with others holding similar views in the formation of the Free Soil (q.v.) party, in which his abilities, learning, high character, and social standing gave him a prominence which he cannot be said to have sought by any purely ambitious efforts. Nominated for congress in the same year, he was easily defeated by the Whig candidate, R. C. Winthrop; but in April 1851, after a protracted contest, he was elected to the national senate as the successor of Daniel Webster, by the combined Free Soil and Democratic votes of the Massachusetts legislature. The post thus gained he continued to hold during the remainder of his life, being re-elected in 1857, 1863, and 1869. At the outset he stood alone in the senate as the uncompromising opponent of slavery, and his elaborately prepared speeches, characterised alike by their studied array of facts and arguments and their bold denunciatory tone, excited universal attention, and were perhaps equally effective in winning support in one section and inflaming hostility in the other. The latter spirit found vent in an act which produced a more startling and profound impression throughout the northern states than any speech could have made. On the 22d May 1856, while sitting at his desk in the senate chamber after an adjournment, Sumner was suddenly assaulted by Preston S. Brooks, a member of congress from South Carolina, and by repeated blows on the head with a heavy cane prostrated on the floor in a state of insensibility. His injuries were in fact so severe as to incapacitate him for public life during nearly four years, while his vacant chair was pointed to as the most eloquent reminder of the violent and lawless animosity against which the advocates of freedom must prepare to contend. He resumed his seat at the close of 1859, and in June 1860 delivered a speech on the question of the admission of Kansas as a free state, which he published under the title of *The Barbarism of Slavery*.

But the predestined course of events no longer needed any impulse from oratory, and the attempts to arrest it by conciliatory offers, in which Sumner naturally took no part, only pointed more plainly to the inevitable collision. The secession of the southern states left the Republican party in full control of both houses of congress, and in March 1861 Sumner was elected chairman of the senate committee on foreign affairs. His interest in domestic affairs was still centred on those in regard to which moral principles could be adduced as the proper basis of political action. He was

urgent for the emancipation of the slaves, and not less strenuous, after this had been secured, in obtaining for the coloured race the fullest civil and political equality with the whites. He supported the impeachment of President Johnson, regarding it as a continuation of the struggle for the overthrow of slavery, and he was foremost in opposing President Grant's project for the acquisition of San Domingo, on the ground that the assent of Baez, the president of that republic, had been given in opposition to the wish of the inhabitants. His conduct on this occasion led to his exclusion in 1871 from the chairmanship of the committee on foreign relations, and his continuous and acrimonious censures on Grant's administration brought about a rupture with the leading politicians of the Republican party which was rendered complete by his support of Greeley as candidate for the presidency in 1872. But, although the result of the election left him in the ranks of a discontented minority, his course had been too evidently dictated by principle to allow of his sinking in esteem with the mass of the party, and the breach was gradually closing when his death, at Washington, on the 11th March 1874, obliterated all asperities, and left only the remembrance of his great services and distinguished career.

Sumner's position in the field of politics was in some respects unique. From first to last he was an independent rather than a partisan. Nature had given him neither the submissive temper of the follower nor the tact, the shrewdness, the persuasive eloquence, and the skill in the management of men and of affairs which are the requisites of leadership. Expediency had no place in his thoughts, flexibility in his disposition, or suavity in his methods or language. Had it been otherwise he might, on the death of Lincoln, have succeeded to the highest place in the national confidence and regard. For his position was a commanding one, owing to his unimpeachable integrity, his unflinching courage, his singleness of purpose and consistency of action, his freedom from every suspicion of intrigue or self-seeking, and his identification both as a victim and a victor with the cause to which he had devoted all his energy and talents. In person he was tall and well proportioned, and, though his features were rugged, the expression of his countenance was engaging. His speeches lacked the charm of spontaneous eloquence, but they were effective as essays or lectures, and furnished his supporters with an arsenal of arguments and illustrations. That his frequent virulence in public debate sprang from no bitterness of spirit is attested by his freedom from vindictiveness, his cordiality in private intercourse, and the warmth and fidelity of his friendships. His nature was too open to admit of misconstruction, and the poet Longfellow, with whom he lived in intimacy, described him as the whitest soul he had ever known.

See his *Works* (15 vols. 1870-79); his *Memoirs and Letters* by Pierce (4 vols. 1877-93); and shorter Lives by Lester (1874), Chaplin (1874), and Anna L. Dawes (1892).

SUMNER, JOHN BIRD, Archbishop of Canterbury, was born in 1780, and educated at Eton and Cambridge. Successively rector of Mapledurham (1818), Bishop of Chester (1828), and Primate of all England (1848), he was distinguished for his conciliatory disposition and moderate views, and wrote works on *Apostolical Preaching*, *The Moral Attributes of the Creator*, and *Evidences of Christianity*. He died 6th September 1862.—His brother, CHARLES RICHARD (1790-1874), was Bishop of Winchester, and his Life was published in 1876.

Sumptuary Laws (Lat. *sumptus*, 'expense'), laws passed to prevent extravagance in banquets,

dress, and private expenditure. They abound in ancient legislation. The Locrian legislator, Zaleucus, 450 B.C., ordained that nobody should drink undiluted wine; and in Solon's code there were many sumptuary enactments. At an early period in Roman history the Censors, to whom was entrusted the superintendence of public and private morality, punished with the *notatio censoria* all persons guilty of luxurious living; but as the love of luxury grew with the increase of wealth and foreign conquest various legislative enactments were passed with the object of restraining it. The Lex Orchia, 187 B.C., limited the number of guests to be present at a feast; the Lex Fannia, 161 B.C., regulated the cost of entertainments. There were also the Lex Didia, Lucretia, Cornelia, Emilia, and others, most of them passed in consequence of the practical disregard of the similar laws that had preceded them; but they all seem to have been habitually transgressed in the later times of the Republic. Julius Cæsar, Augustus, and other rulers also made laws against luxury.

Sumptuary laws were in great favour in the legislation of England from the time of Edward II. down to the Reformation. Statute 10 Edward III. chap. 3 narrates that 'through the excessive and over-many costly meats which the people of this realm have used more than elsewhere many mischiefs have happened; for the great men by these excesses have been sore grieved, and the lesser people, who only endeavour to imitate the great ones in such sorts of meat, are much impoverished, whereby they are not able to aid themselves, nor their liege lord, in time of need as they ought, and many other evils have happened as well to their souls as their bodies;' and enacts that no man, of whatever condition or estate, shall be allowed more than two courses at dinner or supper, or more than two kinds of food in each course, except on the principal festivals of the year, when three courses at the utmost are to be allowed. All who did not enjoy a free estate of £100 per annum were prohibited from wearing furs, skins, or silk, and the use of foreign cloth was allowed to the royal family alone. Act 37 Edward III. declares that the outrageous and excessive apparel of divers people against their estate and degree is the destruction and impoverishment of the land, and prescribes the apparel of the various classes into which it distributes the people; it goes no higher than knights, but there are minute regulations for the clothing of women and children. This statute, however, was repealed the next year. In France there were sumptuary laws as old as Charlemagne, prohibiting or taxing the use of furs; but the first extensive attempt to restrict extravagance in dress was under Philip IV. By an edict of Charles VI. no one was allowed to exceed a soup and two dishes at dinner. Frederick the Great and other German princes endeavoured to suppress the use of coffee as a harmful luxury. Sumptuary laws continued to be introduced in England in the 16th, in France as late as the 17th century; and burial in woollen, prescribed by English law from 1678 till 1815, was akin to them, though its primary object was to lessen the importation of linen. The Scottish parliament attempted to regulate the dress of the ladies, to save the purses of the 'pair gentlemen their husbands and fathers;' and statutes were passed against superfluous banqueting, and the inordinate use of foreign spices 'brought from the parts beyond sea, and sould at dear prices to monie folk that are very unskill to sustain that coaste.' Neither in England, Scotland, nor France do these laws appear to have been practically observed to any great extent: in fact, the kings of France and England contributed far more, by their love of pageantry, to excite a taste for luxury

among their subjects than by their ordinances to repress it. Froude has suggested that such statutes may have been regarded, at the time when they were issued, rather as authoritative declarations of what wise and good men considered right than as laws to which obedience could be enforced. Enactments of this kind have long been considered to be opposed to the principles of political economy. Most of the English sumptuary laws were repealed by 1 James I. chap. 25; but regulations of a similar kind survive in the university statutes of Oxford and Cambridge. There is a trace of the same principle in the present-day taxation of luxuries—wine and spirits, tobacco, tea, and coffee (though mainly with a view to regulating the incidence of the tax), and in the duties on male servants, armorial bearings, &c. And one reason sometimes urged for the suppression of the liquor traffic is the diminution thereby to be effected in wanton waste and pernicious luxury. In Montenegro strong laws were passed in 1883 against gloves, umbrellas, and non-national costumes.

Sumter, FORT (named after General Thomas Sumter, 1734-1832, an active partisan leader of the revolutionary war), an American fort associated with both the beginning and the end of the civil war, was built of brick, in the form of a truncated pentagon 38 feet high, on a shoal, partly artificial, in Charleston Harbour, 3½ miles from the city. On the secession of South Carolina in December 1860, Major Anderson, in command of the defences of the harbour, abandoned the other forts, and occupied Fort Sumter, mounting sixty-two guns, with a garrison of some eighty men. The attack on the fort was opened by General Beauregard on April 12, 1861, and it surrendered on the 14th: this event marked the beginning of the war. The Confederates strengthened it, and added ten guns and four mortars. In April 1863 an attack by a fleet of monitors failed. In July batteries were erected on Morris Island, about 4000 yards off, from which in a week 5000 projectiles, weighing from 100 to 300 lb., were hurled against the fort; at the end of that time it was silenced and in part demolished. Yet the garrison held on amid the ruins, and in September beat off a naval attack; and in spite of a forty days' bombardment in October-December 1863, and for still longer in July and August 1864, it was not till after the evacuation of Charleston itself, owing to the operations of General Sherman, that the garrison retired, and the United States flag was again raised, April 14, 1865; an event soon followed by the evacuation of Richmond and the Confederate surrender.

Sunny, a town of Russia, 125 miles by rail NW. of Kharkoff. Pop. 15,831.

Sun, the star which warms, governs, and illuminates the earth and the other bodies forming the Solar System. By the patient efforts of astronomers and physicists a vast body of knowledge, of which here we can but give the outline, has been gained regarding it. For convenience we condense such of this information as admits of the treatment into the subjoined table.

Equatorial horizontal parallax.....	8" 794
Mean distance.....	92,965,000 miles
Diameter.....	867,000 miles
	{ Max. 32' 36" 4
Diameter (apparent angular).....	{ Min. 31' 32" 0
Mass.....	330,000
Density.....	0 25
Volume.....	1,305,000
Force of gravity at surface.....	27 6
Period of rotation on axis.....	25 days 7 hours 48 minutes
Inclination of axis to plane of ecliptic (1860).....	82° 45'
Velocity of rotation at equator.....	4407 miles per hour
Longitude of node of equator (1860).....	73° 40'
Surface in square miles.....	2,288,621,466,000
Energy radiated from each square foot of this surface (Stokes)	= 12,000 horse-power

Early observations of the sun were necessarily confined to records of its motions and eclipses, of which a very fair mastery was gained even in Chaldean and Egyptian times, as well as early in the history of China (see ASTRONOMY). The apparent motions of the sun, determining as they do what part of our world shall at any time receive his heat and light more or less abundantly, are so regular and so important to our life that they naturally give us our principal time measures (see DAY, YEAR, SEASONS). For long the observation of these formed perhaps the chief part of astronomy. But when Copernicus showed that the sun was really the centre of our system, and Galileo discovered the moons of Jupiter, the idea of a community of nature between the sun and our world—the earth circling around the sun as the moons around Jupiter—began to take firm root in men's minds. Newton's extension of the law of gravitation to the heavenly bodies greatly aided this process. The idea that the sun shone because composed of mysterious fiery elements faded away, and men began to ask after its real constitution, and seek the secret of its stores of energy. But to answer this question required much preliminary investigation, and to trace this, so far as it has gone, is to track some of the best and purest triumphs of human patience and skill.

(1) *The sun's distance* was the first problem to be attacked. In ancient times Aristarchus of Samos tried to solve this by measuring the angle between the sun and moon when the latter was in her quarters (see MOON). This method, even if accurately followed, would give no absolute measure, but only the *relation* between the distances of the sun and moon. From his attempts Aristarchus concluded the sun to be eighteen times as far from us as the moon. In reality his method is one which can give no accurate result, though it represents a great step in astronomical investigation. As instruments improved, and especially when the telescope was invented, new measures were made, only to result in the conviction that the sun was so far away that accurately to measure its distance appeared impossible. The distance of celestial objects is found by the measurement of their *Parallax* (q.v.). If an observer changes his own position, all the objects around him appear also to shift their relative positions, those nearer shift more than distant ones, and by the amount of shift for a known change of the observer's place their distance may be calculated. The greater the distance between the observer's two positions the greater (and therefore more easily measurable) is the apparent shift of the objects before him. It was found ere long that no change of place possible on our small earth, 8000 miles in diameter, was sufficient to produce a *definitely measurable* change in the sun's position on the celestial sphere. By an opposition of Mars (see below) observed in 1672 by Richer at Cayenne and Cassini at Paris this angular change of place (or parallax) was given at $9''.5 =$ a distance of 87,000,000 miles. Flamsteed, by the same method, reached a parallax of $10'' =$ 81,700,000 miles, Picard's measure was parallax $20'' =$ 41,000,000 miles, and Lahire's 136,000,000 miles.

At last, in 1716, the English astronomer Halley proposed a method of employing the transits of Venus. Accordingly the transits of 1761 and 1769 were observed in a variety of places; but the results at first deduced were discordant and unsatisfactory, until in 1824 the German astronomer Encke 'discussed' the observations of 1769, and arrived at a distance of about 95,300,000 miles; and this number held its place in books of astronomy for a good many years. A transit can occur only when the planet is in or near one of

her nodes at the time of inferior conjunction, so as to be in a line between the earth and the sun. The coincidence of these two conditions follows a rather complex law. There are usually two transits within eight years of one another, and then a lapse of 105 or 122 years, when another couple of transits occur, with eight years between them. The transit of 1874 had for its successor that of 1882, and there will not be another until June 2004. The way in which a transit is turned to account may be understood by the help of fig. 1, where E represents the earth, V Venus, and S the sun. It is to be premised that the *relative* distances of the planets from the sun are well known. Their periodic times can be observed with accuracy, and from these by Kepler's (q.v.) Law we can deduce the *proportions* of the distances, but not the distances themselves. It is thus known that, if the distance of the earth from the sun is taken as 100, that of Venus is 72. In the fig., then, AV is 28, or about one-third of Va or Vb. An observer at a station, A, on the northern part of the earth will see the planet projected on the sun as at *a*, while a southern observer will see it at *b*. The distance of the sun from Venus being about three times her distance from the earth, it is



Fig. 1.

obvious that the distance *ab* will be three times the distance AB; and it is a great advantage to have the stations A, B, as far apart as possible, as the interval *ab* is thus increased, and its measurement rendered more accurate.

But how is it measured? For each observer sees only one of the spots, and does not know where the other is; and there are no permanent marks on the sun's surface to guide us. The difficulty is got over in the following way. Each observer notes the exact duration of the transit—i.e. the time the spot takes to travel from C to D, or from F to G. Now as we know the rate of Venus' motion in her orbit, this gives us the length of the lines CD and FG in minutes and seconds of arc. Knowing then the angular diameter of the sun ($32'$) and the lengths of two chords CD and FG, we can easily, by the properties of the circle, find the distance *ab* between them. This gives us the angle *aAb*. In the triangle AVb, then, we know the angle at A and the proportion of the sides AV and Vb, and from that we can find the angle *aAb* and *AAb*. Now this is the quantity sought, being the parallax of the sun as seen from two stations on the earth. Whatever the distance AB actually is, the angle is reduced to correspond to a distance equal to the earth's semi-diameter. The parallax deduced by Encke, as above referred to, was only $8''.5776$. The advantage of this roundabout procedure is that a comparatively large angle (*aAb*) is measured in order to deduce from it a smaller (*AAb*), so that any error in the measurement is diminished in the result.

Meanwhile during the later part of the 18th century efforts had been made by Dr Stewart of Edinburgh (1763) and Mayer of Göttingen to determine the sun's distance by the lunar 'parallactic inequality' (see MOON). These amounted to little until Laplace (q.v.) solved the problem and gave a result hardly different from Encke's. In 1854 and 1858, however, Hansen and Leverrier found reason to doubt its correctness. A favourable opposition

of Mars in 1862, observed by Stone and Winnecke, justified their doubts, fixing the distance somewhere between 91 and 92½ million miles. The method employed so far resembled that of the transits of Venus that it depended on measuring the distance of a nearer object than the sun—viz. the planet Mars in opposition. From this, the *proportions* of the planetary distances from the sun being accurately known, the solar distance was easily calculated.

Meanwhile, by a most ingenious method, another measure of this was obtained. Römer (1675), Delambre (1792), and Glasenapp (1874) had ascertained (the last with great accuracy) by observation of Jupiter's Satellites (q.v.) that light takes 500·84 seconds to cross the earth's orbit from side to side (Glasenapp's result). Also the amount of the Aberration of Light (q.v.) had been carefully measured. If the velocity of light were known these would afford a means of estimating the sun's distance. This velocity was measured by Fizeau and Foucault in 1862. The result confirmed the later and smaller estimate of solar distance given above. A rediscussion of the transit observations of 1769 by Ponalky (1864) and Stone (1868) also confirmed it.

The transit of Venus in 1874 was impatiently awaited, as with modern instruments and methods a final settlement of the question was anticipated. But, although about eighty posts of observation were provided all over the world and many observers carefully trained, little or no progress was made. Atmospheric effects and photographic defects left an uncertainty estimated by Professor Harkness of Washington, D.C., at 1½ million miles.

Dr Gill in 1877 observed a favourable position of Mars, which gave a result of 93,080,000 miles. Observations of minor Planets (q.v.) were also utilised, and a number of expeditions sought a value from the transit of 1882. Michelson of the United States navy anew determined (in 1879) the velocity of light, and Professor Harkness used his value for it in another estimate. The amount of accuracy obtainable at present in such discussions may be judged by the various estimates given by the best authorities as follows: Professor Harkness, 92,365,000 miles; Professor Young, 92,885,000; Dr Ball, 93,000,000; Mr Stone, 92,000,000; M. Faye, 92,750,000. These various values will explain the varying estimates of the size, mass, density, &c. of the members of the solar system, as the sun's distance enters as a factor into all such calculations. The table at the beginning of this article is based on a solar parallax of 8"·794. In it the reader will find the results as to the sun's size, mass, density, and gravitational power of this conclusion as to his distance.

(2) *The sun's true motion in space* is ascertained from the comparison of observed stellar *proper motions* (see STARS). It is directed to a point on the line joining the stars π and μ Hercules. Its velocity is 1·623 radii of the earth's orbit *per annum*.

(3) The investigation of the *physical structure and chemical constitution* of the sun has been in modern times most successful. A long series of efforts by many workers has brought us to something like definite ideas as to its radiating power, which is a fundamental factor in this investigation (see HEAT). In 1837 Pouillet measured the amount of solar radiation. His result was that 1·76 calories per minute were received on every square centimetre of our earth's surface. Much of the sun's heat is absorbed by the terrestrial atmosphere. Hence Forbes ascended the Faulhorn in 1842 and obtained there the greater value of 2·85 calories. Violle on Mont Blanc in 1875 got 2·54. Professor

Langley, probably the most accurate observer, gives very nearly 3·00. Computations of the sun's temperature in degrees Cent. have varied from a few hundreds to many millions. They are essentially misleading, as the condition of matter in the sun is not yet known sufficiently well to enable us to calculate its temperature from its radiation. We know, however, with certainty that the most refractory substances are vaporised long before the solar temperature is reached. And the sun's surface, seen by Langley through the then smoke-laden air of Pittsburgh, appeared 5300 times as bright as the molten metal in the fierce heat of a Bessemer converter. At the temperature indicated by this all known substances would exist as tenuous vapour, were the pressure bearing on them that of our terrestrial atmosphere. But in the interior of the sun, under pressures inconceivable to our minds, such vapours would behave very differently. Under such conditions the usual distinctions between solid, liquid, and gaseous forms of matter to which we are accustomed would be obliterated. In fact, how matter would behave in such a state science at present cannot tell. Of the sun's *surface*, however, we have learned much. According to the researches of Professor Rowland of Johns Hopkins University, Baltimore, in 1891, the following elements are present there. The list is in order, according to the number of spectral lines in the elements identified in the solar Spectrum (q.v.), iron coming first with more than 2000 lines identified, potassium last with 1 only. Iron, nickel, titanium, manganese, chromium, cobalt, carbon, vanadium, zirconium, cerium, calcium, scandium, neodymium, lanthanum, yttrium, niobium, molybdenum, palladium, magnesium, sodium, silicon, strontium, barium, aluminium, cadmium, rhodium, erbium, zinc, copper, silver, glucinum, germanium, tin, lead, potassium, and possibly iridium, osmium, platinum, ruthenium, tantalum, thorium, tungsten, uranium.

These as vapours form a layer upon the solar surface, which is in fact the solar atmosphere. Immediately *beneath* this is the *photosphere*, which marks to the eye the boundary of the sun's disc. *Above* this layer of vapours rise vast jets and clouds called variously *flames*, *prominences*, or *protuberances*. Above these again is the bright and curiously shaped solar *corona*, extending along the ecliptic, as once seen, to a distance of twelve solar diameters.

The *photosphere* presents to the telescope of low power an apparently even surface. Under higher powers its structure is seen to be complex. The whole surface is granulated, resembling a gravel heap seen from a little distance. These granules have been described as like 'willow leaves' and 'rice grains.' A multitude of minute dark points or pores, black in comparison with the granules, serve to emphasise their outline. This may be said to be the normal condition of the photosphere. There are always, however, some portions of the surface which show an indistinctness of granulation, sometimes so marked that they are named 'veiled spots.' Bands of this indistinctness in less marked form spread over the whole photosphere as a kind of network called by French observers the *riseau photosphérique*. They are continually in a state of fluctuation, and are most probably due to the currents of varying density in the solar atmosphere. The granules and spores are due to intense convection currents, the tops of ascending masses of vapour glowing white with the heat derived from the solar interior. These show as 'granules,' while the descending masses, having radiated their energy, return to be again heated below the surface, and in their descent show as the comparatively dark 'pores.' The appearance of

the surface of a large mass of molten iron in an open mould gives a fair idea of this process. It must always be remembered, when vapour or gas is spoken of as at the sun's surface, that the enormous temperatures and pressures there prevailing, with the scale on which these must vary in short intervals of time, will make vapours behave much more like terrestrial solids than like gases as we know them. The impact of a small jet of solar 'vapour' would in fact be far more powerful than that of a projectile from a 100-ton gun. The rapidity of these convection currents must therefore be enormous, and a little careful watching soon shows that the whole solar surface is in a state of constant change.

In certain regions of the photosphere, between 6° and 35° solar latitude, both north and south of the solar equator, large black spots are frequently observed. In size these vary from 150,000 miles in largest diameter to small black dots approaching in appearance the 'pores.' The largest are easily seen by the naked eye when fog or dark glass protects it from the excessive solar glare. The activity of their producing cause is subject to a considerable variation. Schwabe of Dessau in 1843 announced



Fig. 2.—Sun-spots. From a photograph taken February 13, 1892, 9 hours 47 minutes. By permission of the Astronomer-royal. The centre of the sun's disc is at *a*.

the discovery of this important fact, giving about ten years as its period. Wolf in 1852 corrected this to 11.11 years. This is generally accepted as the *mean* period, but individual periods may vary from it considerably. The shortest periods are the most intense. There is an undoubted connection between this period and that of terrestrial magnetic phenomena. Auroræ and sun-spots wax and wane together, even in their smaller fluctuations. But the theory that sun-spots depend

for their frequency on the influence and position of the planets has had to be abandoned. These spots usually have three well-marked areas, distinguished by their different degrees of blackness. The *penumbra* forms the outer border of the spot, and is only grayish compared with the general white of the solar surface. Within this is a much darker area called the *umbra*, and within this a still blacker spot, the *nucleus*. While sometimes persisting for months, spots frequently vanish or form in a few days, sometimes even in a few hours. They are the theatre of constant changes. Long filaments are often extended from the penumbra across the umbra, forming 'bridges.' In fact the whole penumbra appears filamentary in structure, being composed of the 'granules' drawn inwards from the edge by the force in the spot. Cyclonic movements have been observed in spots, but are not usual. The spot is most probably a cavity formed in the photosphere by the pressure of a vast descending mass of vapour. In spot latitudes, for some unknown reason, these masses collect in unusual size, not descending by the minute 'pores,' but requiring larger openings. Both spots and pores appear dark, not because the uncovered lower solar layers are cooler than those above, but because the cool masses of vapour pressing on them from above absorb their light, and prevent it reaching us. In reality their blackness or grayness is only such as compared with the intensely white photosphere. It is almost certain that these absorbing vapours are considerably cooler than the neighbouring surface. Great differences of pressure, as well as of temperature, exist in spots. Hence they are accompanied by (or accompany) great disturbances and fierce vapour currents. These affect even the earth, and cause simultaneous disturbances in our magnetic needles. White ridges (called *faculae*) are raised in the neighbourhood of spots, indicating enormous pressures, and spreading often over a wide area of the solar surface. The spectra of sun-spots are most complex. Their meaning cannot yet be said to be fully understood. But they give certain evidence of vapour movements of enormous rapidity, and of pressures on a like scale. One example of this occurred in the great spot of June 1889, when a dark spectral line of iron was widened to five times its usual thickness, indicating an immense pressure. Displacements of lines from their normal position have also been observed, indicating vertical vapour movements at a velocity as high as 320 miles per second.

During total solar eclipses certain solar phenomena become visible, which bear closely on the problem of the sun's physical condition. Chief among these are the *corona*, *prominences*, and *chromosphere*. The last (sometimes called the *sierra*) surrounds the sun completely. It consists of a layer of vapours covering the entire photosphere. Its depth varies at different times and in different parts, ranging from about 6000 to 2000 miles. As seen in eclipses it is of a beautiful rosy hue, and its surface, seen in profile at the edge of the solar disc, appears sharply jagged and broken into waves or spear-like jets of varied altitude. It consists chiefly of hydrogen and an element, till 1895 unknown in our laboratories, called 'helium.' (See the article ARGON). Sometimes heavier vapours, as of iron, calcium, titanium, magnesium, and others, are projected into it from the true solar atmosphere below. There is indeed no marked border between these groups of gases other than a fluctuating one due to their varied weight. The chromosphere rises often in local jets of rosy gas to an enormous altitude. These form the *prominences*, first recorded as seen at an eclipse by Captain Stannyan, who observed at Bern, Switzer-

land, the total eclipse of May 12, 1706. Since recorded at many Eclipses (q.v.), they are now daily studied through the open slit of the spectroscope, a method devised by Lockyer and Janssen in 1868, and improved in 1869 by Zöllner and Huggins. They form two well-marked classes, 'Cloud' and 'Flame' prominences. A 'Cloud' prominence resembles a terrestrial cloud, but, as seen by this method, of an indescribably delicate rosy hue, often connected by slender stems to the chromosphere. Such are relatively permanent, lasting usually a few days. 'Flame' prominences are eruptive, often connected with spots, and subject to violent changes even in the space of a few minutes. Delicate clouds of hydrogen are sometimes seen to form and disperse, *in situ*, in and close above the prominence region, exactly as clouds in our air, pointing out the fact that not even here is to be found the limit of matter ejected from or retained by the sun. The existence of the *corona* confirms this. Its appearance during a total eclipse may be gathered from fig. 3. Its shape varies, while



Fig. 3.—Corona during Total Eclipse of the Sun, 12th December 1871. From plate engraved from photograph taken at Baikal, on the Malabar coast of India, by Mr Davis, Lord Crawford's assistant (see *Memoirs of the Astronomical Society*, vol. xli., 1879).

yet a general agreement in form is preserved. In periods of sun-spot maximum it is more fully developed than at minimum periods, and differently shaped. At a spot minimum it is smaller and most developed towards the solar poles. At a maximum it gathers in great rays above the spot-region of the surface. As yet only to be studied during the short period of a total eclipse, the true nature of the corona is not determined. On one theory it has been thought to be like the Zodiacal Light (q.v.); on another it was supposed to consist of streams of meteorites; on yet another of cometary matter; and in a fourth it was regarded as chiefly terrestrial atmospheric glare. It is now generally admitted to consist of tenuous gas, hydrogen, and helium, possibly also some hydrocarbon and clouds of finely-divided dust, while electric discharges similar to an aurora play an important part in its illumination. It is hoped that yet a method may be devised of studying it independently of eclipses, when more definite knowledge of its structure will speedily be obtained.

See G. F. Chambers' *Descriptive Astronomy* (4th ed. 1889-90); Miss Clerke's *Hist. of Ast. in the 19th Cent.*; *The Sun*, by Professor Young (1881; new ed. 1888);

Le Soleil, by Secchi; Herschel's *Outlines of Astronomy*; Proctor, *The Sun* (1871); Lockyer, *Chemistry of the Sun* (1887); Sir R. S. Ball, *The Story of the Sun* (1894); for the age of the sun and the probable duration of its heat, Siemens' *Conservation of Solar Energy* (1883); Lord Kelvin's *Mathematical and Physical Papers* (1882-90), &c.; for the assumed connection of the cycles of sun-spots with Indian famines, papers in *Nature*, vol. xliii., &c.; and for the connection of volcanic dust with the phenomena of sunsets and afterglows, see the works cited at KRAKATOA.

SUN-WORSHIP.—In early philosophy throughout the world the sun and moon are regarded as alive and credited with sex, as brother and sister or husband and wife; but their worship cannot be said to be universal among the lower races, being more especially characteristic of the higher levels of savage religion, of tillers of the soil rather than nomads, of temperate rather than torrid climates. Thus, it was the main worship of the old pastoral Aryans, as may still be seen in Brahman rites, and it appears in the Persian Mithra, the Greek Helios, the Egyptian Ra. It flourished in Tartary, in the fullest development in ancient Peru, and widely among the North American Indians, while in Africa it is hardly found except in Egypt, and in Australia and Polynesia it is seen much more plainly in myth than in religion. And the rites of worship of earthly Fire lead naturally upwards to the religion of heavenly Fire in its great personification, the Sun. But while we give its place to the great nature myth of the Sun staying the Darkness of Night and Winter, we need not read it into everything in mythology after the fashion of the ingenious vagaries of professed solar mythologists like Max-Müller, Cox, and A. de Gubernatis. The worship of the sun lingered long even under the shadow of Christianity, which was skilful to turn its rites to profit. Thus, these survive disguised in the Easter bonfires, as do its great Festivals in the Yule Log bonfires of Christmas Day—*Dies Natalis Solis Invicti*—the Roman winter solstice-festival, identified as early as the 4th century with the birthday of Jesus, but on no adequate historical evidence, and in its pendant at Midsummer, with its fire-wheels and bonfires. See APOLLO, BELTANE, CHRISTMAS, ZEND-AVESTA, FOLKLORE, MYTHOLOGY, PARSEES, SOLAR MYTH, and ZOROASTER.

Sun-animalscules. See HELIOZOA.

Sunart, LOCH, a picturesque sea-inlet in the west of Argyllshire, winding 19½ miles eastward.

Sun-bath. See BATH, Vol. I. p. 792.

Sun Bear. See BEAR.

Sunbirds (*Nectariniidæ*), a family of Passerine birds related to the Honey-eaters (q.v.), having tenuirostral beaks and a protrusible and deeply-cleft tongue. In general appearance and habits they resemble the Humming-birds of America, with which, however, they have no real affinity. They are birds of brilliant plumage, glittering with metallic lustre. They are confined to the hotter regions of the Old World, being particularly abundant in Africa and southern Asia and extending to North Australia, but the species commonly have a limited range. Captain Shelley in his monograph on the Sunbirds (Lond. 1876-80) subdivides the family into three sub-families, (1) *Neodrepaninæ*, (2) *Nectariniinæ*, (3) *Arachnoterinae*. They are all of small size, although none are so small as the smallest humming-birds; they rival humming-birds in brilliancy of plumage, and like them they feed on the juices of flowers, which they suck by their long bill, occasionally hovering in the air before a flower when feeding, but generally hopping about or clinging to the smaller twigs and flowering branches. They have a feeble chirping

note. They feed partly on the nectar of flowers, but also on small cicadellæ, flies, and spiders. *Cinnyris* is a synonym of *Nectarinia*.

Sun-bittern (*Eurypyga helias*), so called from the brilliant many-coloured markings on its plumage, a South American bird about the size of a small curlew, long legged and long necked, which usually struts in a solemn balanced manner, but at times goes through a series of poses somewhat like the Argus (q.v.). It is found from Brazil northwest into Central America.

Sunbury, capital of Northumberland county, Pennsylvania, on the Susquehanna River (here, a mile below the junction of its branches, crossed by a bridge), 53 miles by rail N. of Harrisburg. It contains foundries, machine-shops, and planing-mills. Pop. (1890) 5930.

Sun-cracks, superficial markings frequently seen on the surfaces of thin bedded flagstones and argillaceous sandstones. They are believed to have been formed in the same way as the fissures which are produced upon the mud-flats of tidal rivers or estuaries by the drying and shrinking of the deposits during their temporary exposure at low tide. The cracks are of course filled up by new deposits when the mud-flats are again overflowed. Not infrequently the material filling the sun-cracks is of harder consistency than the rock in which they occur. When the bed overlying the cracks is removed a cast of these often projects from its under surface, or frequently the casts remain in the moulds so as to form a series of polygonal ridges ramifying over the whole surface of the exposed stratum.

Sunda Islands, a name that bears in geography two interpretations. (1) It is applied, but not very correctly, to the long chain of islands which stretches from the Malay Peninsula south-east to the north coast of Australia, beginning with Sumatra and ending with Timor. (2) In the more proper sense of the term it means the islands that lie between the east end of Java and the north side of Timor, namely Bali, Lombok, Sumbawa, Flores, Sandalwood Island, and some smaller ones. These have been already treated of in separate articles, with the exception of Lombok. This island, with an area of 2098 sq. m. and a pop. of 405,000, is traversed by two chains of mountains (highest summit, 11,620 feet), some of which show signs of volcanic activity, and yields rice, maize, cotton, tobacco, sugar, indigo, and coffee; three-fourths of the people are aborigines (Sassak); all, except 20,000 immigrant Balinese (Brahmans), profess Islam. The Dutch have exercised suzerainty over the native chiefs since 1840. The principal town on the island is Mataram on the west coast.

Sunda Strait is a passage, from 70 to 90 miles in breadth, lying between Sumatra and Java and connecting the Indian Ocean with the Sunda Sea. Several islands stud its waters, as Krakatoa (q.v.), Princes Island, Steers, and Calmeijer.

Sundarbans, or **SUNDERBUNDS**, the lower portion of the delta of the Ganges in British India, extending from the mouth of the Húgíli on the west to the mouth of the Meghna on the east, a distance of 165 miles, and stretching inland for half that distance. The total area is estimated at 7550 sq. m. The region is entirely alluvial, is intersected by a network of anastomosing streams, and contains a vast number of swamps and morasses. Next the sea is a wide belt of dense jungle and underwood, the haunt of the tiger, leopard, rhinoceros, buffalo, wild hog, deer, monkeys, python, cobra, and numerous sea-birds and birds of prey. Behind this belt the land is cultivated, the fields being enclosed with embankments. Rice is the staple crop, though the people also grow

pulses, vegetables, jute, and sugar-cane. Besides rice the principal products of the region are timber and fish. There are no villages, the population being thin and scattered. The population are counted in the adjoining districts of Bengal, and there is no separate return for the Sundarbans as a whole. Of course the chief highways are the innumerable watercourses, shown in the map at the article CALCUTTA. See *Petermann's Mitteilungen*, Ergänzungsheft (1891).

Sunday. See SABBATH.

Sunday-schools, as we know them in modern times, sprang from the efforts begun in 1780 by Robert Raikes (q.v.), a printer in Gloucester. Although systematic and wide-spread attention to the religious training of children is of modern date, still some attention was bestowed upon it in early times. The father acted as teacher and priest towards the children in patriarchal times; there was provision for the training of children in the knowledge of the law in the Jewish economy. Ezra read and had the law explained 'before the congregation both of men and women and all that could hear with understanding' (Neh. viii.). There were religious schools in connection with the synagogues in New Testament times. The Mishna says, at five years of age 'let children begin the Scriptures, at ten the Mishna, and at thirteen let them be subjects of the Law.' In the apostolic age teachers were set over the young and ignorant. Mosheim says 'the Christians took all possible care to accustom their children to the study of the Scriptures, and to instruct them in the doctrines of their holy religion.' Clement of Alexandria and Origen did duty as catechists. The classes of Catechumens (q.v.) were intended for the instruction of candidates for church fellowship; instruction was given on Sundays just previous to public worship, and the scholars were mostly adults. At the Reformation Luther (1529), finding the people fearfully ignorant, opened schools for children for catechising. Knox (1560) did the same in Scotland. St Charles Borromeo (q.v.), Archbishop of Milan, founded Sunday-schools in his diocese, which still exist, but these were chiefly secular. Sunday-schools are noticed in an ordinance of Albert and Isabel in 1608 as then existing in the Catholic Netherlands. The magistrates were enjoined to see to their establishment and support in all places where not already set afoot. Both Richard Baxter and the Rev. Joseph Alleine (1634-68) were in the habit of gathering young people together for instruction; and there were many irregular and isolated attempts in the same direction in different parts of Britain. But it was Raikes who founded and consolidated the modern Sunday-school system and gave the subject publicity through his journal and other organs of public opinion. There is no doubt that his philanthropic work in Gloucester gaols had impressed him with the direct connection between ignorance and crime. One day, in 1780, he had gone to hire a gardener in a low suburb of the town near the Severn, where the people were mostly employed in a pin-factory. He was grieved at seeing the groups of wretched ragged children at play in the streets, and on inquiry was informed that on Sunday 'the street was filled with a multitude of wretches, who, having no employment on that day, spent their time in noise and riot, playing at chuck, and cursing and swearing in a manner so horrid as to convey to a serious mind an idea of hell rather than any other place.' To check this deplorable profanation of the Lord's Day he engaged four women, who kept dame-schools, to instruct as many children as he should send them on the Sunday in reading and the church catechism, for

which they were to receive one shilling each for their day's service. In this work he was assisted by the Rev. Thomas Stock, of St John's parish. The children gathered into the first Sunday-schools ranged from six to twelve or fourteen years of age. Personal cleanliness was the one requirement. 'All that I require,' said Raikes, 'are clean hands, clean faces, and their hair combed.' Owing to the total ignorance of the scholars the teaching was of an educational nature at first; the little folks learned their letters, and to spell and read. The schools opened at 8 A. M., by 8.30 lessons were begun; afterwards the children went home, or to forenoon service, and in the afternoon to school again at the close of the church service till 5.30 P. M. Boys and girls were separately taught, and once a month they were publicly catechised in church as to their religious knowledge. In a short period a visible improvement was effected in both the manners and morals of the children. One employer of labour said 'the change could not have been more extraordinary had they been transformed from the shape of wolves and tigers to that of men.' More than three years after its foundation the scheme was noticed in Raikes's *Gloucester Journal* (November 3, 1783); but it was a letter by Raikes, quoted in the *Gentleman's Magazine* in 1784, which first drew general attention to the subject. In 1784 the first Sunday-school was established in London by the Rev. Rowland Hill. Numerous schools sprang up in all the principal towns, and a society under high patronage was formed in London in 1785 for the establishment and support of Sunday-schools throughout the kingdom, which in fourteen years spent £4000 in payment of teachers. By 1789 there were already 300,000 scholars throughout the kingdom. Hannah More (q.v.) started a school in 1789, and Sydney Smith one at Netheravon. Adam Smith wrote that 'no plan has promised to effect a change of manners with equal ease and simplicity since the days of the apostles;' and Cowper and John Wesley likewise approved of the system.

One great impediment to the early prosperity of the Sunday-school was the expense of hiring so many teachers. But several young men banded themselves together to teach the children gratuitously; the example spread, and soon the teaching was almost universally gratuitous. One authority says gratis teaching began at Oldham. A higher class of teachers offered their services; the schools ceased to be filled by the very poorest alone; handsome buildings were erected in connection with the different churches and chapels, or by general subscription, and that system was organised which has covered the land with schools. The secular teaching, which in certain instances included writing and arithmetic, was not of a very high order; but it placed the key of knowledge in the hands of multitudes who would otherwise have been unable to read, and the religious instruction with which it was combined moulded the character of some of the best men in England.

Sunday-schools were introduced into Wales in 1789 by the Rev. Thomas Charles of Bala (one of the founders of the Bible Society, q.v.), and were much appreciated even by adults—in one class at Bungor every pupil wore spectacles. The Sunday-school was known in Scotland in 1756, but it was not till 1786, when the Society for Promoting Religious Knowledge was formed, that it was publicly recognised, nor till 1795, when the Gratis Sunday-school Society was originated, that schools became general. At first they met with considerable opposition from both the civil and ecclesiastical authorities. The names of Dr Chalmers, James Gall, and David Stowe deserve mention in connection with the progress of Sunday-schools in Scotland. In Ireland Sunday-schools had been partially anticipated by

Dr Kennedy, in County Down, in 1770; but it was not till 1785 that the system pursued by Raikes was adopted. The Sunday-school Society for Ireland was established in 1809. Of the teaching it may be said that good progress has been made since the passing of the Education Act, and it has more of a scriptural nature than formerly.

In the United States, as in Great Britain, there were isolated attempts at Sunday-school teaching before the example of Raikes reduced it to a system. The Methodist Bishop Asbury (q.v.) is said to have planted the first American Sunday-school in Hanover county, Virginia, in 1786. The Methodist Conference in 1790 resolved to establish Sunday-schools for white and black children. A Sunday-school Union was formed at Philadelphia in 1791 which employed paid teachers; the New York Union was formed in 1813; and the American Sunday-school Union in 1824, which sprang from the Sunday and Adult School Union (1817). During the first fifty-nine years of its existence 74,000 Sunday-schools were organised, with 466,000 teachers and over 3,000,000 scholars. In missionary work £565,000 had been spent, and £120,000 in grants of books and papers. The Congregationalists, Methodist Episcopalians, Presbyterians, and Baptists have also organisations, and now the United States stands in the forefront as regards the excellence of buildings and the vigour and earnestness with which the work has been prosecuted. Dr Vincent, one of the founders of Chautauqua (q.v.), which sprang from a Sunday-school Convention, deserves mention for the excellence of his Sunday-school lessons. Along with Mr Jacobs of Chicago he took the initiatory steps which led to the publication of the International Series of Lessons (1873) now used on both sides of the Atlantic. Sunday-schools were introduced into the West Indies in 1810, into France in 1815, and about the same time into Ceylon and at Serampore. The Sunday-school is an invariable adjunct to the work of the missionary. The Roman Catholics have also numerous Sunday-schools.

The establishment of the English Sunday-school Union in 1803 gave a powerful impetus to the extension of Sunday-schools through the agency of ministers and churches, and the improvement of the voluntary teachers engaged in the cause. Missionaries are supported on the Continent and elsewhere. Lectures are delivered, there are travelling agents, and a publication department which issued eighty new books in 1890 and circulated over 10,000,000 of their serial publications. The catalogue of books offered for sale now contains 1500 volumes suitable for libraries. Its affiliated schools in 1890 numbered 6528, teachers 153,851, and scholars 1,501,729. The Church of England Sunday-school Institute (1844) estimates the number of scholars in England and Wales connected with the Church of England as 2,220,000, with 195,500 teachers. The Wesleyan Sunday-school Union dates from 1874, and in less than ten years had 800,000 scholars. A Sunday-school jubilee celebration was held in 1831; the centenary was observed in 1880, and a monument erected bearing the names of Cardinal Borromeo, Thomas Stock, and Robert Raikes.

In 1818 the Sunday scholars in England and Wales numbered 477,225; in 1833, 1,548,890; and in 1851, 2,407,642; Scotland at the same date having 292,549, and Ireland 272,112. The numbers in America were 3,000,000. The report of the International Convention of 1881 for the United States gave 84,730 schools, 932,283 teachers, and 6,820,835 scholars. At the centenary celebration of 1880 the total number of teachers in the world was given as 1,425,233, and of scholars 12,107,312. Mr F. J. Hartley, of the Sunday-school Union,

gave the number of Sunday-school teachers and scholars throughout the world in 1890 as follows :

	Teachers.	Scholars.
England and Wales.....	616,941	5,733,825
Scotland.....	59,213	651,975
Ireland.....	28,132	310,089
Total United Kingdom.....	704,286	6,695,899
United States of America.....	1,100,104	8,345,431
European Continent.....	58,308	1,027,177
Australasia.....	49,283	680,227
Canada and Newfoundland.....	57,212	490,109
In connection with the several Missionary Societies in India.....	5,744	110,270
Do. West Indies.....	9,523	108,233
Do. Africa, China, Japan, Persia, and Central America.....	12,145	368,289
Total.....	1,996,606	17,720,135

See **RAGGED SCHOOLS, EDUCATION**; also *Watson, Sunday-school Union* (1853); *Gregory, Robert Raikes* (1880), and *Centenary of Sunday-schools* (1880); *The Modern Sunday-school*; *Sunday-school Handbook*; *Vincent's American Sunday-school*; *Inglis' Sunday-school*.

Sunderland, a seaport, municipal, county, and parliamentary borough and market-town of Durham, situated at the mouth of the Wear, 13 miles N.E. of the city of Durham and 12 S.E. of Newcastle-upon-Tyne. The township of Sunderland is on the south side of the river, covering an area of 219½ acres, and forms but a small portion of the municipal borough, which comprises also the townships of Bishopwearmouth, Monkwearmouth, and Monkwearmouth Shore. Monkwearmouth appears in history in 674 as the site of a monastery erected by Benedict Biscop (q.v.), and Bishopwearmouth in 930 as one of the places conferred by Athelstan on the monks of Lindisfarne then settled at Chester-le-Street. The earliest indubitable reference to Sunderland itself does not occur till 1311. Sunderland is a fine, well-built town, with broad, clean streets and pleasant suburbs. Till the beginning of the 19th century Sunderland was a very inconsiderable place, but since then, owing to the improvement of the harbour and the growth of the Durham coal trade, it has developed with great rapidity. The principal public buildings and institutions are the town-hall, a fine new building in the style of the Italian Renaissance, erected 1887-90; the Free Library, Museum, Art Gallery, and Winter Garden (1877-79); Sunderland Literary Society and Subscription Library (1878); the Theatre Royal (1853); the Avenue Theatre; the Victoria Hall, the scene of the terrible disaster of June 16, 1883, in which 182 children lost their lives (1872); the Assembly Hall; the Workmen's Hall (1868); the Liberal Club (1839); the County Constitutional Club (1890); the Infirmary (built 1865; enlarged 1879-87); the Orphan Asylum (1860). There are twenty churches in the borough (seventeen belonging to the Church of England and three to the Roman Catholic Church). St Peter's, Monkwearmouth, retains in a part of the tower and west wall of the nave a remnant of the 7th-century building. There are between fifty and sixty chapels and meeting-houses in the borough belonging to the various dissenting bodies. Sunderland possesses in the People's or Mowbray Park an excellent recreation-ground. The portion south of the railway was purchased in 1854, and contains monuments of Havelock and Jack Crawford. The portion north of the railway, called the New or Extension Park, was purchased in 1866. The village of Roker, a popular watering-place close to Monkwearmouth, also has a park of 17 acres, opened in 1880. Two single-arch iron bridges cross the Wear at a distance of 20 yards from each other. The older bridge, having the large span of 236 feet, was built 1793-96. It was reconstructed and widened under the direction of Robert Stephenson in 1858-59. The railway

bridge was opened for traffic in 1879. The harbour is formed by two piers, the one on the north being 617 yards long, that on the south 650 feet. A new pier, starting from the south end of the terrace promenade at Roker, is over 2000 feet long. Two other piers protect the entrance to the south docks. There are four docks at Sunderland capable of accommodating the largest vessels—the North Dock (6 acres), the Hudson Dock, North (18 acres), the Hudson Dock, South (14 acres), the Hendon Dock (11 acres). Over 208,000 tons of shipping are registered at the port of Sunderland, and in 1890, 6052 vessels of 2,342,161 tons cleared from it. The annual shipments of coal and coke for the last few years reached upwards of 4,000,000 tons. From the commissioners' staiths 15,000 tons can be shipped in a day. Other exports are bottles and glass, earthenware, lime, iron, chemicals, patent fuel, and cement. The principal imports are timber, props, iron ores, chalk, loam, grain, flour, esparto grass, hay, straw, and tar. Sunderland is famous for its iron shipbuilding-yards, of which there are as many as thirteen on the river. During 1890 eighty-six vessels, registering 125,612 tons, were launched on the Wear. In 1889 the tonnage launched was 217,366. There are also in the town extensive ironworks, forges, anchor and chain works, glass and bottle works, chemical works, roperies, paper-mills, breweries, and lime-kilns. In Monkwearmouth is the Pemberton coal-pit, 381 fathoms deep, several of the workings extending under the sea. Sunderland returns two members to parliament. Pop. of parliamentary borough (1851) 67,394; (1881) 124,760; (1891) 142,248, of whom 131,015 were in the municipal and county borough. Havelock was born at Ford Hall, Bishopwearmouth (1795); Jack Crawford, the hero of Camperdown (1775-1831), at Sunderland; and other natives were Clarkson Stanfield, R.A., Tom Taylor, and Swan the electrician.

Sunderland, ROBERT SPENCER, EARL OF, was born in 1640, and in September 1643 succeeded his father, who fell at the first battle of Newbury, having three months before been created first earl. After serving as ambassador to several courts, in 1679 he became Secretary of State, and at first united with Essex and Halifax in opposing Shaftesbury, who wished to set Monmouth on the throne, and favoured the exclusion of the Duke of York. He encouraged Charles II. to persevere in the degrading French alliance, and, with the Duchess of Portsmouth, to whom he attached himself, negotiated a treaty by which, in consideration of an annual French pension, Charles was to assemble no parliament for three years. Before the year was out a new triumvirate, consisting of himself, Hyde, and Godolphin, succeeded to the confidence of Charles. The treaty with France was broken off, and Sunderland, who was now afraid of the Whigs, engaged the king in a more popular alliance with Spain. After the dissolution of the last of the exclusion parliaments he lost his office; but the duchess remained faithful to him in disgrace, and in 1682 he was, 'upon great submission made to the Duke [of York], again restored to be Secretary.' He remained in office until the accession of James II., when his influence in the ministry became greater than ever. Although there is reason to believe he gave some encouragement to Monmouth in his rebellion, he managed, with consummate art, to win James's entire confidence, and in 1685 became prime-minister. He alone was entrusted with a knowledge of the king's intention to establish Catholicism as the national church; and in 1687 he privately conformed thereto, and afterwards openly professed his conversion. His influence was so great that James would grant no favour until he had asked the question: 'Have

they spoken to Sunderland?' and when told that this nobleman got all the money of the court, he would reply: 'He deserves it.' Yet we find him about this time in correspondence with William of Orange. With profligate but masterly dexterity he contrived to deceive both James and Barillon, and to keep them in ignorance of the events that were passing in Holland. When William arrived in England Sunderland went to Amsterdam, whence he wrote to the new monarch, claiming his favour and protection on the ground that he had all along been in his interest. In 1691 he was allowed to return to England, and to kiss the king's hand; in 1695 William spent a week at his house at Althorp. He had changed, it was said, his religion, in the late reign, in order the more effectually to ruin King James; and it was generally believed that he had rendered King William, when Prince of Orange, some signal services, which no one else could have done. This belief gained credit from the favour now shown him. He was made Lord Chamberlain, and as such took his seat at the head of the council table. After directing affairs as the acknowledged head of the government, he resigned office in 1697, and retired to Althorp, where he died, 28th September 1702. By his wife, Anne, daughter of the second Earl of Bristol, he left CHARLES SPENCER, third earl, who was born in 1675, and whom Evelyn describes as a youth of extraordinary hopes, very learned for his age, and ingenious. From 1706 to 1710 he was Secretary of State in the reign of Queen Anne, and under George I. he rose to be all-powerful; but in 1721, being accused of receiving £50,000 worth of the fictitious stock distributed by the directors of the South Sea Scheme (q.v.), in order to bribe the government, he was acquitted only by an inconsiderable majority and that from party considerations, and the indignation of the public made him resign his office. He died on 19th April 1722, not without suspicion of having intrigued, after his fall, for the restoration of the Tories, if not for the return of the Pretender. Sunderland was a type of the political morality, or rather immorality, of a disgraceful age, when the greatest statesmen made no scruple of sacrificing either their own party or the interests and dignity of the nation to personal ambition. His title descended to Charles, his second son, who succeeding in 1733 to the honours of his maternal grandfather, John Churchill, the earldom of Sunderland became absorbed in the dukedom of Marlborough. The third son, John, was father of the first Earl Spencer (q.v.).

Sundew. See INSECTIVOROUS PLANTS.

Sun-dial. See DIAL.

Sundsvall, a seaport of Sweden, on a bay of the Gulf of Bothnia, 80 miles N. by W. of Stockholm, and 290 miles by rail E. by S. from Trondhjem in Norway, has ironworks and saw-mills, and a large trade in iron and timber. Pop. (1890) 13,780. The town was almost entirely destroyed by fire in 1888.

Sunfish (*Orthogoriscus*), a genus of pelagic fishes of the family Diodontidæ (see GLOBE-FISH), having the body compressed, and not capable of inflation, as in the other Diodontidæ; abruptly terminating in a very short tail; the dorsal and anal fins long and pointed, united to the short tail-fin; the jaws undivided in the middle, and comparatively feeble, and furnished with a cutting edge of bone instead of teeth. The total number of vertebrae is seventeen, and the spinal cord is merely a short appendage of the brain. The species are found in every part of the oceans within the tropical and temperate zones. The young undergo remarkable changes. The food consists of small

pelagic crustacea. The Short or Rough Sunfish (*O. mola*), found frequently on the south coasts of England and Ireland, when young is almost perfectly round, but becomes rather more elongated when full grown. The name Sunfish is variously regarded as derived from the form of the fish and from its habit of floating at the surface of the water, in fine weather, as if to enjoy the sunshine. It attains a large size, being sometimes 7 or 8 feet long, and is captured by sailors. Its skin is rough and minutely granular. Its flesh is white and well flavoured, somewhat resembling that of the skate.

Short Sunfish (*Orthogoriscus mola*).

The liver yields a large quantity of oil, which is in repute among sailors as an external application for the cure of sprains, rheumatism, &c. The Oblong Sunfish (*O. truncatus*), of which specimens have also been taken on the British coasts, but more rarely, is of a longer form. It also attains a large size. It has a smooth tessellated skin, and is one of the rarest fishes in collections.

Sunflower (*Helianthus*), a genus of plants of the natural order Compositæ, sub-order of Corymbiferae, having large flowers; the florets of the ray strap-shaped, without stamens or pistils, yellow or orange; the florets of the disc tubular, perfect, yellow or purplish brown; the flowers solitary or in corymbs, with an involucre of numerous leaves; the fruit compressed, with a pappus of two or more deciduous scales. The species are numerous, all natives of America; large herbaceous plants, with opposite or sometimes alternate undivided leaves. The Annual Sunflower (*H. annuus*), common in flower-gardens, is a native of tropical America, where it sometimes attains a height of 20 feet. The stem is thick and rough; the flowers solitary, and from 1 foot to 2 feet in diameter, nodding; the leaves heart-shaped-ovate. This plant is now cultivated in almost all parts of the world, and in the south of Europe is sometimes a field-crop, the seeds being valued as food for cattle and poultry, and on account of the oil which they yield, which is little inferior to olive-oil. An acre of good land produces about fifty bushels of seed, each bushel yielding a gallon of oil. The seeds are also used like almonds for

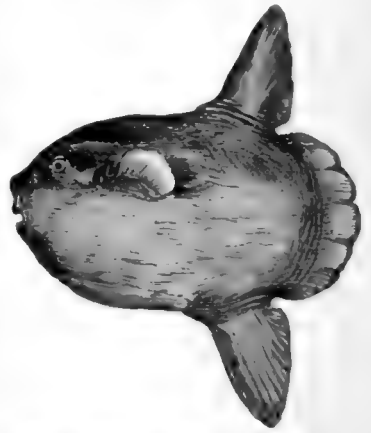

Sunflower
(*Helianthus multiflorus*).

making demulcent and soothing emulsions; and in some parts of Europe a bouilli is made of them which is used as food for infants. Russians eat them like nuts, and American Indians make bread of them. The flowers abound in honey, and are much frequented by bees. The leaves are good fodder for cattle. The stems are used for fuel, and yield much potash. A profusely flowering garden variety, *H. multiflorus*, is referred to the same species. The fallacy that the flowers of the sunflower turn with the sun is mentioned by Gerarde (1597), who adds, however, 'the which I could never observe, although I have endeavored to finde out the truthe of it.'—The Jerusalem Artichoke (q.v.) belongs to this genus.

Sungei Ujong, a native state of the Malay Peninsula under British protection, lies on the west side, between the British colony of Malacca and the native state of Selangor. Area, 660 sq. m.; pop. (1891) 23,602, mostly Chinese. The productions are the same as those of the neighbouring Straits Settlements (q.v.).

Sunium. See COLONNA (CAPE).

Sunn. See CROTALARIA, FIBROUS SUBSTANCES.

Sunnites, the name commonly given to orthodox Muslims, because in their rule of faith and manners the Sunna (pron. *Soonna*), or traditionary teaching of the Prophet, is added to the Koran. According to Islam the human mind is incapable of attaining light in law or religion but through the Prophet, and all expressions of God's will are equally important. Reason and conscience are here of no value; memory is all. Hell-fire is the award due alike to him that prays without being properly washed and to him that denies the word of the Prophet. Accordingly during the Prophet's life his counsel was eagerly and continually sought; and after his death his example and sayings were collected as of infinite value. After the death of the four rightly guided califs, Abu Bekr, Omar, Othman, and Ali, intimate friends of the Prophet, fearful uncertainty arose and gradually occasioned the four schools of the four orthodox Imams. The first of these was Abu Hanifa, born in Basra of a noble Persian family. He taught in Kufa on the Euphrates. He logically deduced from the Koran all religion and law; for the Koran says (Sura 16 : 91) 'to thee we have sent down the book which clears up everything.' Consequently, when the Koran says (S. 2 : 20) 'for you have I created the whole earth,' it follows that to Muslims belongs all the property of unbelievers. Hence the propriety of piracy and aggressive war against them. In his school arose the famous legists of Irák, and his system, the most widely spread of the four, is now professed by the Turkish empire. He would never hold any office under government, fearing the doom due according to prophetic tradition to every giver of a wrong decision, namely, to be plunged into hell from a height of forty days' journey. He died in 767 in prison, where the calif had confined him for refusing to be Cadi over the new capital Bagdad.

In 795 died Málík ibn Anas in his eighty-fourth year at Medina, where he was born and had lived all his days. There, surrounded by traditions of the Prophet, he had taught after the custom of Medina. This had been impossible to Abu Hanifa, residing amid a partly foreign people and a very complex civilisation. Málík gathered from the Koran and from local traditions of Mohammed his *Muwáttaa*, or Beaten Path, a complete body of law and religion. He never announced any such tradition without a previous ablution. On his death-bed he regretted with tears that he had ever used his own judgment in pronouncing an opinion on a point of law, and wished that he had been flogged and re-flogged every time. His system was established

in North Africa by African students, who found Medina the most convenient school, and in Spain by his Berber pupil Yahya 'bn Yahya. The third orthodox imám was Ash-Sháfi't of the Koraish tribe, and descended from the Prophet's grandfather, Abdul-Múttalib. He was born, it is said, on the day of Abu Hanifa's death. He taught in Cairo, and there he died in 820. He was an eclectic, but leaned more to the traditionary precedents of his teacher Málík than to the deductive method of Abu Hanifa. His system prevailed in Egypt, and was not uncommon eastward. It still flourishes in the Asiatic islands.

The use of reason and Greek philosophy had by this time wrought such laxity in faith and in public and private conduct that rigid puritanism was a natural concomitant. Its exponent was Ibn Hanbal, the fourth orthodox imám, who died in 855 in his native city Bagdad, beyond which his system never had much power. He was a pupil of Ash-Sháfi't, whose lectures, however, he would never allow his own pupils to attend. Tradition and Sunna had now immensely increased, and by these alone the Hanbalites were guided. They are now almost extinct, but were strenuous in their early days, when they would break into festive meetings in Bagdad, beat the singers, break the musical instruments, and pour the wine into the streets. The bulk of tradition had now made editing indispensable, and those huge masses of it began to appear under which the Muslim mind has been crushed to death. As Ibn Hanbal said, 'the punishment of the learned man in this world is blindness of heart.' Abu Hanifa had used only 18 traditions, Málík 300. Ibn Hanbal used 30,000. These were mainly collected by his friends and pupils. One of these, the excellent Abu Da'ud Suleimán, travelling in many Muslim lands, collected half a million, which he sifted down to 4800. Another, Yahya 'bn Main, spent a large fortune and wore out his last pair of shoes in collecting 600,000. Helpers copied as many more for him. 'I copied quantities of traditions to the dictation of liars,' he said, 'and heated my oven with them, whereby my bread was well baked.' But of the six accepted collections the standard one was made by Al Bukhári, a friend and pupil of Ibn Main. He taught in Bagdad, and like the best Muslim theologians was a Persian. He died in 870. Of the 600,000 traditions heard by him he admitted only 7275, whereof the half are probably genuine. Till he had washed and performed two rekas of prayer he never inserted any tradition. An edition by Krehl appeared at Leyden in 1862-72, in 3 vols. The collection by his Muslim pupil is better arranged, and is more used. The sources of tradition were Áysha, the first four califs, and the six companions of the Prophet, of whom Abu Horaira, a manifest liar, was more prolific than any other. Through one of these channels to Mohammed the *isnad* or pedigree of every tradition had to be traceable. Worth or internal evidence counted for nothing. The work of collecting was begun too late. The real origin of most traditions was the requirements of interested parties, conscious mendacity, or gossip, specially in the standing camps of Arabs required in every conquered land. The matter is called Hadith, events, tradition, and is much more entertaining than the Koran. Besides the legal and religious utterances of Mohammed, which are generally in one or two sentences, it embodies endless nonsense about his life and miracles, although Mohammed disowned all miracles but his own inspiration, about spirits, the beginning of the world and its end. Whatever in the Hadith can be imitated or obeyed is Sunna, method; compulsory for guidance if connected with religion, but redundant or collateral, though praiseworthy, if

giving mere details of such things as the Prophet's mode of standing and sitting. Its object is to make needless all appeals to reason and conscience. In legislation it is much less used than formerly; but, like the Koran, it is infallible and unalterable, and its only independent exponents are the four orthodox imâms. Legislation merely means a declaration by the Sheikh-ul-Islâm and his council of ulemâ or doctors that this or that agrees with the Koran or tradition. Reformation of law or religion from within is impossible.

Sunstroke (otherwise called **Heatstroke**, **Heat Apoplexy**, **Heat Asphyxia**, **Coup de Soleil**, **Erythimus tropicus**, and **Insolatio**) is a very fatal affection of the nervous system, which seldom occurs in Great Britain, except in extremely hot summers, but is very common in India and other tropical countries. The symptoms of the disease are liable to be greatly modified in different cases. Two contrasted forms are recognised. In the *cardiac* the heart is chiefly affected, and the symptoms are weakness, faintness, dimness of sight, giddiness, &c. Death may take place either suddenly or more gradually from failure of the circulation. If recovery occur it is complete. This form is said to occur only from direct exposure to the sun's rays. In the *cerebro-spinal* form, the commoner of the two, the symptoms usually come on more gradually; nausea and giddiness may be present at first; but the most striking feature of the disease is either wild delirium or coma, with a pungently hot skin and extremely high temperature—106° F. or upwards. Even those who recover from this form of the disease are apt to suffer for a long period, or it may be permanently, from severe headache, epilepsy, enfeebled mental power, or other nervous disorders. Intermediate varieties are also met with, forming links between these two extremes. The mortality from sunstroke is about 50 per cent. of those affected. In the cases that terminate favourably a gradual remission of the symptoms takes place; and when the skin becomes cool and moist, and sleep has been procured (phenomena which usually occur within thirty-six hours of the attack), the patient may be regarded as out of danger.

The predisposing causes of sunstroke are (1) an unusually elevated degree of temperature; (2) heavy or unduly tight clothing, particularly if it interfere with the free expansion of the chest; (3) a contaminated atmosphere from overcrowding; (4) all debilitating causes, such as prolonged marches, previous disease, intemperate habits, &c. Death sometimes occurs so suddenly that there is little opportunity for treatment, but the general indications in these cases are the cold douche, from a height of three or four feet, keeping the surface wet and exposed to a current of air, the exclusion of light as far as possible, and the free employment of stimulants. In less rapidly fatal cases the outer clothing should be removed, and the douche applied, as before, over the head and along the spine. Relaxation of the pupil is the first favourable sign. If the pulse flags the douche must be replaced by the mere application of cold to the head, and it may be necessary to apply hot bottles, &c. to the extremities. The hair must be cut short, and the nape of the neck blistered as speedily as possible. If insensibility recurs after an interval of ten or twelve hours, a blister should be applied to the crown of the head. The extremities and chest should be stimulated with mustard poultices. Immediately after the employment of the douche a strong purgative injection should be thrown up the lower bowel. Under no circumstances should there be any abstraction of blood. If injurious effects persist long after partial recovery, the patient should be removed to a cooler climate.

The preventive measures are of more importance than the treatment. There has occasionally been an extraordinary mortality from sunstroke in the United States in very hot summers.

Sun-worship. See **SUN**, p. 806.

Suonada, or the Inland Sea of Japan, separates the islands of Kyushu and Shikoku from the main island, Honshu. It is about 250 miles in length from the strait of Shimonoseki (q.v.) to Osaka, greatest breadth about 50 miles, and is studded with innumerable islets and rocks. The scenery is most beautiful, but the navigation is difficult.

Superannuation. See **CIVIL SERVICE**.

Supererogation, **WORKS OF** (Lat. *opera supererogatoria*), a class of works which, in the Roman Catholic system, are described as not absolutely required of each individual as conditions to his eternal salvation. The doctrine is based on the distinction between *præcepta* and *consilia evangelica*, the former including the common duties of all, the latter (called also 'Counsels of Perfection') establishing a merit. Roman Catholics found this definition on the distinction between what they believe to be commanded and what they hold to be only counselled, for an example of which they appeal to the words of our Lord to the young man in Matthew, xix. 21, which distinguish one class of works which are necessary in order to 'enter into life,' and a further class which must only be done if we 'would be perfect.' Roman Catholics do not profess to recognise in works of supererogation any distinctive essential quality by which they differ, whether in their physical or their moral entity, from other works, and in virtue of which, by their own nature, the individual may found upon them a personal claim to reward. For works of supererogation, as for all supernaturally good works, they hold that the assistance of God's grace is indispensably necessary; and they do not ascribe to them any merit, except that which arises from God's own free and gratuitous promise. In one word, the only distinctive characteristic of a work of supererogation lies in its not being supposed to be prescribed or commanded as absolutely necessary for the salvation of the individual, and its being done for the sake of greater perfection; and the doctrine which teaches the possibility of such works is, according to Catholics, a necessary consequence of the unequal fervour and unequal degrees of holiness which exist even in the class of the virtuous servants of God. The main difficulty comes in at the next step—the claim that a further consequence of this doctrine is that God may accept the superabundant works of one in atonement for the defective service of another. Hence in the theory of indulgences, along with what they regard as the infinite and inexhaustible treasure of the merits of our Lord, Roman Catholics also regard, although in a degree infinitely inferior, the superabundant merits of the saints as forming part of that 'treasure of the church' which is applied in the form of indulgences. See **INDULGENCE**.

Superfœtation, or the circumstance of two distinct conceptions occurring in the same woman at a considerable interval, so that two fœtuses of different ages—the offspring possibly of different fathers—may co-exist in the uterus, is a subject of great interest both in a scientific and in a medico-legal point of view. Two centuries ago there was a universal belief in not only the possibility but the comparative frequency of this occurrence. Early in the 19th century it was as universally disbelieved; and now again (owing to the investigations of various inquirers) we are returning to the belief of our ancestors. The cases described as instances of superfœtation may be arranged in three

classes; but it is only to the cases of the third class that the term superfœtation is truly applicable. The first class includes the numerous undisputed cases in which two mature children, bearing evidence, from their different colours, that they are the offspring of different parents, are born at the same time. (In the slave states of America it was by no means uncommon for a black woman to bear at the same time a black and a mulatto child—the former being the offspring of her black husband, and the latter of her white lover; and the converse has occasionally occurred—a white woman at the same time bearing a white and a mulatto child.) There is no difficulty in accounting for these cases, which may be examples of nearly contemporaneous conception rather than true superfœtation. The second class includes those cases in which a twin has aborted, leaving its fellow undisturbed in the uterus, to be matured and born in due time, or in which twins have been produced at the same time, one of which was fully formed, while the other was small and apparently premature, from being 'blighted' or arrested in its development at an early period, or in which the birth of two children, both mature or nearly so, is separated by a short interval. Cases of these kinds are by no means rare; but there is no reason for believing that the infants were conceived at different periods.

The third class only presents serious difficulty. 'In a case of genuine superfœtation,' says Dr Bonnar of Cupar, 'a woman must bear two (or more) mature children, with an interval of weeks or months between the birth of each; or, if she part with the whole contents of the uterus at the first delivery, the difference of the ages of the fetuses, or the mature child and the fœtus, as the case may be, must be unmistakable, and there must be the absence of all marks of blight of the latter, so as to leave no doubt that, had it remained in utero, it would have gone on to perfect maturity.' Several apparently well-authenticated cases are on record where a second living child has been born three, four, or five months after the first; and these seem inexplicable on any hypothesis except that a second conception has taken place during the progress of the first pregnancy. Theoretical objections to the possibility of such an occurrence cannot outweigh the recorded facts, and by some of the highest authorities are not considered valid for the early months of pregnancy. Cases, moreover, of double uterus occasionally occur; and in the absence of clear evidence to the contrary in any particular case it is possible that the second conception may have taken place in the unoccupied division of such an organ. See Taylor's *Medical Jurisprudence* for further details.

Superior, a flourishing city of Wisconsin, at the W. end of Lake Superior. It became a city in 1889, has about 40 church organizations, fine public school buildings, a public library, city hall, grain elevators and flouring-mills, several banks, and extensive manufactures of iron and steel products. Pop. (1887) 3353; (1890) 11,983; (1900) 31,091.

Superior, LAKE, the largest body of fresh water on the globe, is the highest and most western of the great lakes lying between Canada and the United States. It is bounded on the N. and E. by Ontario, on the S. by Michigan and Wisconsin, and on the NW. by Minnesota. Greatest length, 412 miles; greatest breadth, 167 miles; area, 31,200 sq. m.—nearly that of Ireland. The surface of the lake is 601½ feet above the level of the sea, and its mean depth about 475 feet; its maximum depth is 1008 feet, or 406 feet below the level of the sea. Its surface has an elevation of 20½ feet above that of Lakes Huron and Michigan; this difference occurs in the rapids of St Mary's River, the only

outlet (see SAULT STE MARIE), where the average discharge is 86,000 cubic feet per second. Lake Superior, being situated very near the watershed between Hudson Bay and the Mississippi, receives no rivers of importance, although hundreds of small rivers pour themselves into it, the largest the St Louis and the Nipigon. Its aggregate drainage area (including its own area) is 82,800 sq. m. (Compare the articles on the four other lakes of the system, and those on Victoria Nyanza, Baikal, &c.) Near Dog Lake (318 miles by rail E. of Port Arthur) a short portage connects streams flowing to Lake Superior with others flowing north to Hudson Bay. The Sault Ste Marie Canal (¾ mile, opened 1895) gives continuous navigation from the head of Lake Superior to the sea, 2384 miles.

The bold northern coast is fringed with rocky islands, some rising from deep water to 1300 ft. above the lake. The largest island is Isle Royale, which is 44 miles long. The southern shore is generally lower and more sandy, with occasional ridges of limestone. Keweenaw Point (q.v.) projects far into the lake. At Grand Isle Bay, about 100 miles W. of Sault Ste Marie, are the Pictured Rocks, cliffs of sandstone from 50 to 200 feet high, in many places presenting fantastic forms, and marked by numerous vertical bands and blotches of red and yellow. The boundary line between Canada and the United States is drawn through the centre of the lake from its outlet to the mouth of Pigeon River, but is diverted so as to include in the United States Isle Royale.

The water of Lake Superior is singularly pure and transparent. It never freezes over, but the shore ice prevents navigation in winter. The lake also is subject to very violent storms; waves have been observed, during protracted autumn gales, 15 to 18 feet high. It has the small tides common to the great lakes (see MICHIGAN), and also the *seiches* seen in Swiss lakes—a regular series of small waves, or pulsations, at intervals of about ten minutes.

The rocks around the lake are very ancient, belonging principally to the Laurentian and Huronian systems of the Azoic series, overlaid in some places, especially on the south side, with patches of the Lower Silurian (soft sandstones). There is everywhere much evidence of glacial action. On the north side, both on the islands and shores, copper and silver are worked, especially at Thunder Bay; while the copper and red hæmatite iron ores of the south side are celebrated for their extent and richness (see COPPER, p. 464). The principal towns on the Canadian side are Sault Ste Marie and Port Arthur, and on the American side Duluth, Superior, and Marquette, all of which are discussed separately. The Canadian Pacific Railway passes along the northern shore. See Crosman's *Chart of the Great Lakes* (Milwaukee, 1888).

Superphosphates. See PHOSPHORUS.

Supervision, BOARD OF. See POOR-LAWS, Vol. VIII. p. 315.

Supple Jack, a name given in the southern United States to the *Berchemia volubilis*, a twining shrub of the natural order Rhamnaceæ, which is found as far north as Virginia. It has oval leaves, small flowers, and violet-coloured berries. Some of the tropical American Paullinias are also called Supple Jack. The same name is also given in the West Indies and tropical America to *Serjania* (or *Seriana*) *triterinata*, a shrub of the natural order Sapindaceæ (q.v.), with a long, flexile, woody stem, which climbs to the tops of the highest trees, and is used for walking-sticks.

Supply. See DEMAND AND SUPPLY.

Supply, COMMISSIONERS OF, so called because they were originally appointed for the purpose of

levying and collecting the land tax or cess offered as 'supply' to the sovereign, were long the chief county authority in Scotland for administrative and rating purposes. They were first appointed by the Act of Convention of 1667, and in order to qualify them to act they required formerly to be possessed of £100 Scots of yearly valued rent in property, superiority, or liferent. Until 1854 they were individually named in acts of supply; but since the passing of the Valuation Act in that year they have consisted of all owners of lands and heritages (other than houses) of the annual value of £100, of owners of houses of the value of £200 a year, of the eldest sons of owners of lands of £400 annual value, and, in the absence of their constituents, of the factors of owners of £800 a year, together with the sheriff and sheriff-substitute and certain representatives of the burghs within the county. It was by them that the general business of the county used to be conducted; they executed the statutes regulating its administration and finance; under the County General Assessment Act of 1868 they raised by rate the money necessary to meet the general expenditure of the county; they prepared annually a valuation roll of all lands and heritages within the county; they appointed the county officials; and in each county, with the exception of Orkney and Shetland, they maintained a force of police. By the Local Government (Scotland) Act, 1889, all these powers and duties were transferred to and vested in the County Council. Under the Act of 1889 the Commissioners of Supply still meet annually in May on the same day as the County Council. They transact no business, however, other than electing a convener and concurring with the County Council in the appointment of a standing joint committee which superintends the police and the capital expenditure of the county. For a parliamentary Committee of Supply, see PARLIAMENT, Vol. VII. p. 774.

Supporters. See HERALDRY, Vol. V. p. 667.

Suppuration is a morbid process which gives rise to the formation of Pus (q.v.), which, as is well known, is one of the commonest products of inflammation. The fluid portion of pus is agreed by all to be derived mainly from the liquor sanguinis; but with regard to the origin of the pus-corpuscles there has been a singular fluctuation of opinion. Before 1850 it was generally held that they developed in the fluid exudation of an inflammation by aggregation or growth of granules contained in it. This doctrine was replaced by that of Virchow (1858), who believed that they resulted from rapid multiplication of the cells of the irritated tissue. In 1867 Cohnheim, repeating accurate but neglected observations made in England more than twenty years before, showed that during inflammation (q.v.) white blood-corpuscles escape from the capillaries, and make their way through the tissues; and he maintained that these, and not fixed tissue-cells, give origin to pus-corpuscles. At present Cohnheim's view is generally regarded as the true explanation in the majority of instances; but it is maintained by some pathologists that at least in some cases many of the corpuscles arise from multiplication and alteration of the cells of the inflamed tissue, an opinion which has not yet been altogether disproved.

With regard to the causes which lead to suppuration there has been almost as great a change of current opinion during the same period. It used to be regarded as the natural result of any kind of severe irritation, and a necessary incident in the healing of the great majority of wounds. But when Lister demonstrated the possibility of preventing it in many cases by Antiseptic (q.v.) methods, and

when micrococci were found in the pus of many abscesses, even where there had been no visible breach of surface, it became clear that microscopic organisms play an important part in the process. The experiments of some observers indeed led them to conclude that though some of the results of inflammation may be manifested, suppuration cannot take place without their presence and activity. It has been shown, however, (1) that dead micro-organisms can excite suppuration; (2) that a fluid in which they have grown, even when completely freed from solid particles, can do so - i.e. that their influence depends at least in part not on the organisms themselves, but on chemical products of their growth; (3) that certain chemical irritants (e.g. mercury, turpentine, croton-oil) experimentally introduced into the tissues of animals with the most complete antiseptic precautions do lead to suppuration. Such conditions, however, can hardly occur except as the result of a carefully planned experiment; and in cases coming under the care of the surgeon it may be assumed that where suppuration is present it is due to micro-organisms.

Suppuration must thus be regarded as one phase of that effort of the organism to resist the causes of disease which takes so prominent a place in pathology at the present day. But though essentially a defensive process, it very frequently becomes harmful, and leads to serious results. If suppuration takes place beneath a surface which does not participate in the morbid change, or which is capable of resisting it for a time, an abscess is formed; when pus-cells are poured forth from an exposed surface we have an ulcer.

For some of the controverted points discussed above, see Leber, *On the Origin of Inflammation*, &c. (Leip. 1891), and Metschnikoff, *On the Comparative Pathology of Inflammation* (Paris, 1892).

Supralapsarian. See PREDESTINATION.

Supra-renal Capsules, two small, flattened, glandular bodies of a yellowish colour, situated, as their name implies, immediately in front of the upper end of each kidney (q.v.). In weight they vary from one to two drachms. They belong to the class of ductless glands, and on making a perpendicular section each gland is seen (like the kidney) to consist of cortical and medullary substance, surrounded by a fibrous investment which is intimately connected with the subjacent structure, and is continuous with the fibrous stroma which pervades the organ. In the cortical portion the cells are arranged in rows or columns, and are polyhedral in shape, while in the medullary portion the stroma forms a network, in the meshes of which groups of cells of more irregular outline are found. The blood-vessels and nerves of the glands are exceedingly numerous. Their function is extremely obscure, and with regard to it nothing is positively known. In 1855, however, Dr Thomas Addison showed that a rare form of disease, characterised by progressive debility and emaciation, with increased pigmentation of the skin (known as *Addison's Disease*, or *Bronzed Skin*), is associated with disease of these organs. It has since been proved that only one particular form of degeneration leads to this result; cancer, sarcoma, &c. have no similar consequence.

Supremacy, ROYAL. The term supremacy is, in politics, chiefly used with regard to authority in matters ecclesiastical. From the time of Pope Gelasius (494 A.D.) to the Reformation the pope exercised a very extensive authority, judicial, legislative, and executive, over all the churches of western Europe, somewhat undefined in its limits, varying in different countries and at different periods; and this continues to be more or less

recognised in all countries whose inhabitants are in communion with the Church of Rome. The Statutes of Provisors (q.v.) and Præmunire (q.v.) asserted in some measure the authority of the sovereign; but at the English Reformation the papal supremacy was abolished, and 26 Henry VIII. chap. 1 declared the king and his successors to be the 'only supreme head on earth of the Church of England.' A document was at the same time drawn up by the government, in which it was explained that the recognition of this headship of the church implies only that the king should have such power as of right appertaineth to a king by the law of God, and that he should not take any spiritual power from spiritual ministers, or pretend to 'take any power from the successors of the apostles that was given them by God.' In 1535, the year in which this act was passed, Bishop Fisher of Rochester, Sir Thomas More, and others were beheaded for denying the king's supremacy. On Elizabeth's accession it was thought prudent, while again claiming the supremacy in all causes, as well ecclesiastical as civil, to keep that designation in the background. By successive statutes the oath of supremacy was appointed to be taken by the holders of public offices along with the oath of allegiance and of abjuration; these three oaths were consolidated into one in 1858; and now the oath of supremacy is not explicitly imposed on members of parliament. See OATH, ENGLAND (CHURCH OF), HENRY VIII.

Supreme Court of Judicature, in England, comprises the Court of Appeal (q.v.) and the High Court of Justice, with its four divisions—Chancery, Common Law, Bankruptcy and Probate, Divorce and Admiralty, all separately dealt with. In Scotland the term refers to the Court of Session (q.v.) and the Justiciary Court (q.v.).

Surabaya, a seaport on the north coast of Java, and on the strait of Madura, over against the island of Madura. Here the Dutch have a marine arsenal, a cannon-foundry, and a mint, and there are machine, sugar, and furniture factories, shipbuilding-yards, and foundries. Sugar, coffee, hides, and tobacco are the chief articles exported; rice and cotton are also grown in the province (area, 2327 sq. m.; pop. 1,856,635), of which Surabaya is the capital. Pop. 127,403, of whom more than 6000 are Europeans and nearly 7500 Chinese.

Suraja Dowlah. See BLACK HOLE, CLIVE.

Surakarta, a town in the centre of Java, but connected by rail with Samarang on the north and Surabaya on the east. It is the residence of the native sultan of Surakarta, who, however, is a dependent of the Dutch government and is advised by a resident. The town (pop. 124,000) is the capital of his kingdom, a mountainous but in part very fertile region, with an area of 2191 sq. m. and a pop. of 1,053,985.

Surat, a city of British India, on the south bank of the river Tapti (crossed by a five-girder bridge), 14 miles from its mouth, and 160 by rail N. of Bombay. It stretches in a semicircle for more than a-mile along the river, the *quondam* citadel (1540; government offices since 1862) forming the central feature in the line. The houses are closely packed, but the streets are clean and well paved; beyond them lie the suburbs, widespread in the midst of gardens. The chief ornaments of Surat are four handsome Mohammedan mosques, two Parsee fire-temples, three Hindu temples, the old English and Dutch factories, and a clock-tower (80 feet high). The existing city was founded early in the 16th century, and very soon after (in 1512) was burned by the Portuguese, who burned it again in 1530 and 1531.

A stronger fort was erected in 1546, and Surat, already a place of considerable trade, soon rose to be one of the greatest commercial cities of India. In 1612 the English established themselves there, in spite of the opposition of the Portuguese, and shortly after they were followed by the Dutch. These last were the busiest of the European traders. Surat at this time had commercial relations with western Europe, with the great cities of Northern India, with Arabia, Persia, the coast-towns of Southern India, Ceylon, and the East Indies, silk, cotton, and indigo being the most valuable exports. Here, too, the Mohammedan pilgrims of India were wont to embark for Mecca. Shortly after the middle of the 17th century the Mahrattas began to harass the city, and they pillaged it several times before the century ran out. But towards the end of the 17th century the commerce of Surat began to decline, Bombay gradually taking its place, especially after the East India Company transferred to that city the headquarters of their government. Just previous to this change Surat is believed to have had a population of 200,000. The place was transferred to English rule entirely in 1800, and for a time it had a revival of its old prosperity and became the most populous city in India. But by a quarter of a century later it had once more declined, and in 1837 was almost wholly ruined by a disastrous fire followed by a great flood. In 1858 it began once more to revive, and flourished during the period of the American civil war, its chief export being cotton. Pop. (1811) 250,000; (1847) 80,000; (1881) 109,840; (1891) 109,229. Cotton, silk brocade, and embroidery are manufactured.

Surbiton. See KINGSTON-UPON-THAMES.

Surcouf, ROBERT, a great French privateer, was born at St Malo, 12th December 1773, and died there, a taciturn but prosperous and corpulent boat-builder, in 1827. He preyed on the English shipping in the Indian seas during the long war, and showed extraordinary skill and courage. His greatest exploits were the capture of the Company's ships *Triton* of 800 tons (1785) and of the *Kent* (1800), almost at the end of her voyage from England to Calcutta. See Prof. J. K. Laughton's *Studies in Naval History* (1887).

Surd. See IRRATIONAL NUMBERS.

Surety. See GUARANTY.

Surface-tension, in liquids, is that property in virtue of which a liquid surface behaves as if it were a stretched elastic membrane—say a sheet of india-rubber. We owe the idea to Segner (1751); but it was Young who, in 1805, first applied it successfully to the explanation of various physical phenomena, such as those of capillarity. The whole subject was subsequently developed in its complete mathematical form by Laplace and Gauss. The general description of the meaning of surface-tension has been given under CAPILLARITY. Here we shall refer to a few other phenomena, which require for their elucidation the assumption of a tension existing in liquid surfaces. Pure water has the highest surface-tension of any ordinary liquid except mercury. If a little alcohol be dropped on the water, the surface-tension will be diminished there. The more powerful surface-tension over the pure water will show its superiority by pulling the alcohol over the whole surface until the surface is reduced to uniformity, and equilibrium produced. Again, a piece of camphor placed on water will dart from place to place in the most capricious manner. This is due to the irregular way in which the camphor dissolves in the water, so that the surface-tension is more weakened on one side than on the other. It is the action of surface-tension that draws out all over the surface

any impurities that may settle on it; and hence arises the great difficulty of getting a clean water or mercury surface. Drops of liquid, free from all but their own molecular forces, assume spherical forms, this being the only shape consistent with equilibrium under the influence of equal surface-tension at all parts of the curved surface. Ripples on the surface of any liquid progress because of the action of surface-tension, which gives rise to an inward pressure on any convex surface. The laws governing the propagation of ripples on the surface of mercury have been recently studied by Professor C. Michie Smith and Lord Rayleigh. Some very instructive experiments may be made with soap-films (see SOAP-BUBBLES); while in cohesion figures we have some very exquisite phenomena, which have been closely studied by Tomlinson. These are produced by dropping a dark-coloured liquid into a transparent liquid of slightly smaller density. Ordinary ink dropped into water will serve the purpose very well, although better effects are obtained with a solution of permanganate of potash. As the drop meets the water-surface, the action of the surface-tension pulls the under surface of the drop outwards, and transforms the drop into a vortex ring, which slowly sinks through the clear fluid. As it so sinks it breaks up into smaller rings and shoots out fantastic ramifications of rare beauty. Ultimately, of course, under the influence of diffusion, the vortex motion decays and the dark liquid mixes with the clear liquid.

Surf-bird (*Aphriza virgata*), a plover-like bird found on the Pacific coasts of North and South America, akin to sandpipers and turnstones, and sometimes called Boreal Sandpiper.—The Surf-duck or Scoter is treated at SCOTER.

Surgeons, COLLEGE OF. The present 'Royal College of Surgeons of England' dates its origin from 1460-61, when Edward IV. 'did, at the application of the freemen of the mystery of barbers of the city of London using the mystery or faculty of Surgery, grant to them that the said mystery, and all the men of the same mystery of the said city, should be one body and perpetual community.' An act of 1511 prohibits any one from practising as physician or surgeon unless duly examined and admitted. Hence arose a company called the Surgeons of London. In 1540 the Company of Barbers of London and the Company of Surgeons of London were united; it was not till 1745 till the surgeons of London were by act of parliament separated from the barbers of London, and made a distinct corporation under the name of 'the Master, Governors, and Commonalty of the Art and Science of Surgery of London.' This company was dissolved, and in 1800 replaced by 'the Royal College of Surgeons of London.' A new charter granted in 1843 to the Royal College of Surgeons of England gave power to the council to elect not less than 250, nor more than 300, members of the college to be Fellows. By an addition to the charter, obtained in 1852, power was given to the council, subject to certain regulations, to appoint members of fifteen years' standing to the fellowship without examination. The college was likewise empowered to test the fitness of persons to practise midwifery and to grant certificates; in 1859 it was similarly authorised to grant certificates to dentists; finally, in 1888 certain additional powers were conferred, but the duty of examining in midwifery was withdrawn.

The government of the college is vested in a Council of twenty-four persons, including one president and two vice-presidents; and none but Fellows are eligible. There is a Board and a Court of Examiners for the fellowship, and examining boards for the membership. There are pro-

fessorships of comparative anatomy and physiology, of surgery and pathology, and of dermatology, besides lectureships. A Hunterian Orator is appointed every second year. The museum of the College of Surgeons is incomparably the finest museum of its kind in the United Kingdom. The Hunterian Collection (see HUNTER, JOHN), which forms its basis, was purchased by a parliamentary vote of £15,000, and presented to the college in 1799. The original edifice in Lincoln's Inn Fields (the germ of the present pile of buildings) was completed in 1813. See the Calendar of the college.

THE ROYAL COLLEGE OF SURGEONS OF EDINBURGH obtained their first charter in 1505, and had it confirmed by James IV. next year. For a century and a half the members of the craft were sole teachers and almost sole professors of the surgical art in Edinburgh. In 1694 they obtained from the town-council a grant of the bodies of convicts and founding infants; in 1705 the professorship of anatomy was founded; about the same date botany, chemistry, and physic were taught; in 1726 the teachers of theory of physic, practice of physic, and chemistry in the college were constituted professors of medicine, and from this time the constitution of the medical school in the university dates; and in 1778 this college became a royal college. The present building, dating from 1832, possesses a fine museum. The college grants the diplomas of Fellow, Licentiate, Licentiate in Dental Surgery, and a diploma in public health; about 300 diplomas are granted annually.—The Royal College of Surgeons in Ireland was incorporated in 1786; see history by Cameron (1886).

Surgery, or manual intervention, mediate and immediate, in all lesions or malformations of the human body, was already an art when medicine proper was but a phase of superstition. The earliest notices of it occur among the Egyptians, who, as we find represented on obelisk and in temple, practised incisions, scarifications, probably even amputation, long before the date of the Ebers papyrus (3500 B.C.). Castration (to supply eunuchs for the royal harem) was also a frequent operation. Preserved in museums may be seen surgical instruments contemporary with votive offerings of the remotest Egyptian epoch—lancets, tweezers, catheters, uterine specula, iron rods for the actual cauter, &c. Among other indications of early proficiency in ophthalmic surgery, couching cataract must have been known to them.

Jewish surgery, like Jewish medicine, was an importation from the Egyptians. The sexual regulations characteristic of the Jews affected their surgery, from simple circumcision up to the Cæsarean section, which very early in their history was practised on pregnant women in death as in life.

Without entering into the controversy as to the Greek origin of the Indian healing art, we find surgery enjoying high esteem among the Indians in very remote times. 'A physician who is no surgeon,' so ran their proverb, 'is like a bird with but one wing.' Surgical instruments skilfully made of steel, to the number of 127, still attest their proficiency in cutting and cauterising—the latter performed in observance of an aphorism quite Hippocratic in its ring—'What drugs and knives cannot cure may be cured with fire.' Their surgeons were trained to operate by practising not on animals or on the dead human subject, but on wax-covered boards, on beasts' skins, or on succulent plants and fruits. Hæmorrhage they checked by cold, by compression, and by styptics. The ligature they seem not to have known. Amputation was confined to the hand in cases of intractable hæmorrhage. Lips or surfaces of wounds they smeared with an arsenical salve. For intus-suscep-

tion, volvulus, and such abdominal lesions they practised laparotomy, while fistula in ano (diagnosed by the speculum) they treated with the knife and corrosives. Lithotomy, in no case performed without the sanction of the rajah, they practised on the method (*sectio lateralis*) described by Celsus. The claim asserted for them of having independently of the Greeks devised the operation of rhinoplasty (constructing a nose from the neighbouring tissue—in this case from the cheek), and also that for cataract, has still to be made good.

As to the surgery of the other orientals we possess but obscure notices. Among the Persians we find Greeks in general practice under King Cambyses. The Chinese six centuries B.C. performed surgical operations (castration, for example) in the rudest fashion, and placed much reliance on acupuncture and the moxa. Japanese surgery betrays similar features.

In Greece surgery had attained high development before Hippocrates put medicine on a rational basis, and in the Hippocratic books we find a rich collection of surgical doctrine and practice drawn from centuries of experience. The treatise called *Iatreion* contains a description of the practitioner's room, its lighting, the instruments and appliances necessary, the duties of assistants, the accommodation of the patients, the position of the operator, the use of the hands, of water, of bandages, of sounds manufactured from tin or lead, &c. A full account of wounds and their treatment is given, hæmorrhage being arrested by cold, by compression, and styptics, the wounds themselves healed by primary union or through suppuration. Cataplasms cold and warm and plasters are also described in this connection. Lesion of the joints and its manifold consequences, and injuries to the medulla spinalis (paraplegia, &c.) are also dealt with. Dislocations and fractures have special treatises devoted to them. On the battlefield, on shipboard, in building operations, gymnastic and athletic contests the Greek surgeon lost no opportunity of perfecting the knowledge to which the latter-day world has surprisingly little to add. Medical scholarship has proved that many of the rarest forms of dislocation had not escaped Hippocrates. Even modern appliances were in great part anticipated by him—splints, for example, and bandages of various kinds. The gem of the Hippocratic surgery (according to Häser) is the treatise on injuries of the cranium—fractures, fissures, and contusions with or without depression. For such cases trepanning is the sovereign operation, to be performed as early as possible, less to get rid of effused blood, pus, &c. than, by removal of the injured osseous structure, to prevent inflammation of the scalp. This bold and circumspect practice creates surprise that the greater operations (extirpation of tumours, aneurisms, amputations, &c.) were ignored, till we remember that in their meagre knowledge of anatomy Hippocrates and his school were slow to risk section of the more important vessels and nerves. The removal of extremities which had become gangrenous shows again the Hippocratic surgery in a wonderfully favourable light. Hernias, hæmorrhoids, fistula are also described and treated with a judgment and skill remarkable for the time.

The post-Hippocratic school (its greatest surgeon being Praxagoras of Cos, noted for his cure of volvulus) has little to detain us; but the Alexandrians left a distinct mark on every branch of the healing art—surgery included. Our best knowledge of them comes from Celsus, who names as the most celebrated surgeon of Alexandria Philoxenus, a voluminous writer on the subject. Ammonius, the lithotomist, is another light of the school, lithotomy being his special contribution to practice.

Roman surgery can hardly claim M. Porcius Cato (234–149 B.C.) as more than a shrewd amateur who left some handy rules for the treatment of fractures, ulcers, nasal polypi, fistulae, strangury, &c., having doubtless drawn on his experience as a slave-owning patrician. Archagathus (218 B.C.) was a regular practitioner, known, for his skilful handling of dislocations, fractures, and particularly wounds, as the 'Vulnerarius.' The senate confirmed the popular appreciation by providing him with a 'taberna' in a much frequented thoroughfare. But when from such practice he proceeded to operate with the knife his popularity fled, he was nicknamed the 'Carnifex,' and had to leave the city. Celsus, the patrician dilettante in medicine, is really the highest name in Roman surgery, though it is doubtful whether he ever operated. Of the eight books of his admirably written work the last two treat of surgery, including plastic replacement of defects in the outer ear, the nose, and the lips; lithotomy as practised on boys (a celebrated chapter); amputation, previously described by no other author; diseases of the bones, with the operation of trepanning, fractures simple and compound, and dislocations.

Galen, though a master of surgery and, before his settling in Rome under M. Aurelius, a practitioner of it, seems to have contributed nothing of his own to its doctrine or practice. As he found it (with some notable additions) it remained to the close of the Byzantine period. An intimate knowledge of its *modus operandi* during these centuries may be inferred from the collection of surgical instruments dug up at Pompeii and now on view at Naples. These are about 300 in number, consisting of some sixty different kinds: needles, hollow probes (straight, curved, and toothed), catheters, specula vaginae, pincers, cauteries, bistouries, lancets, scissors, &c., mostly of bronze, many of the cutting ones of iron. To sum up: blood-letting was practised in antiquity by venesection, arteriotomy, cupping, and (later) by leeches. Hæmorrhage was checked by cold water, styptics, cauterising, ligature, and torsion—the two latter not mentioned by Hippocrates, the ligature being a device of the Alexandrians, as torsion was of the empire, after which time it fell into desuetude. The treatment of fractures and dislocations was practically the same from Hippocrates to Paulus Aegineta (650 A.D.). Trepanning received several modifications in practice up to Galen's time, while tracheotomy (introduced by Asclepiades, 1st century) was by Paulus restricted to cases of choking, when the deeper air-passages were free. The evacuation of pus in empyema, frequently mentioned by Hippocrates, was seldom performed in later times—Paulus recommending, instead of the knife, the application of the actual cautery to the wall of the thorax. The operation for hernia, perfunctorily dealt with by Hippocrates, had by the epoch of Celsus assumed the practical development in which it is found during the later empire, Heliodorus, under Trajan, being noted for his radical cure of the scrotal form. Lithotomy, in the Hippocratic period confined to specialists, was by the Alexandrian school raised to full surgical honours, to be supplemented under the Byzantine empire again by lithotripsy. In Paulus we find a well-nigh exhaustive list of operations for disease or malformation of the genitals, even including syphilis (Häser), while rectal and anal affections (hæmorrhoids, fistula, &c.) were skilfully treated by Leonides (200 A.D.), who seems to have used the écraseur as well as the knife and the cautery. Large tumours in the neighbourhood of great vessels were untouched by Hippocrates or Celsus, though the latter makes mention of the surgical cure of goitre. On the other hand, Leonides extirpated the cervical glands;

Antyllus (300 A.D.) tied their vessels above and below the point of section; and Paulus removed them by constricting them at their base by a ligature. Cancerous tumours after Celsus' time came within the category of *Noli me tangere*. Aneurisms find no place in Hippocrates, and Celsus refers only to the extirpation of varices. Antyllus seems first to have classified and dealt with the former—in true aneurism isolating the artery with a ligature above and below the sac, which he then opened and emptied. Amputation after Celsus is described by Archigenes, hæmorrhage being obviated by ligature of the great vessels or constriction of the limb. Flap-amputations were performed by Heliodorus and Leonides. Resection of the humerus, the femur, and the lower jaw proves (according to Häser) the high development to which surgery under the empire had attained, as also do the plastic operations which Antyllus describes with a fullness and freedom unknown to Celsus. A word may be added here for the medico-military service of that time, afloat and ashore, apparently quite as well organised as the combatant arm. Under the Byzantine emperor Maurice (582–602) the cavalry had an ambulance-company whose business it was to bring the severely wounded out of action, and who were provided with water-flasks and cordials to relieve the fainting.

The Arabs borrowed their surgery from the Greeks, chiefly from Paulus Ægineta, even more slavishly than their medicine. Their neglect of anatomy and their oriental repugnance to operations involving the effusion of blood serve to explain the fact that except Abulcasim (died 1122) they contribute no memorable name to this branch of the healing art.

Salerno did incomparably less for surgery than for medicine, partly because its representatives being mostly ecclesiastics held aloof from manual intervention, partly because its copyist monks reproduced from the classic authorities only the medical writings, leaving out those which had little or no interest for men of the cloister—gynæcology, surgery, pædiatry, &c. Still there is evidence that from the 10th to the first half of the 13th century they did take cognisance—theoretical at least—of wounds, burns, abscesses, fractures, dislocations, cancer, urinary calculi, and external applications.

Surgery continued to be looked down upon by physicians, all the more that the recently founded universities gave the latter the prestige of a culture denied to the adventurers who healed wounds, reduced dislocations, and set fractured limbs. Throughout the middle ages surgical literature seems to have shared the fortunes of medical literature—first the Greeks were in the ascendant, then their servile imitators the Arabs. The earliest mediæval writers in surgery were Italians, superseded in the 14th century by the French, while the same period witnessed the first English, Dutch, and German books on the subject. Guy de Chauliac, the highest name in that century, laboured to bridge the chasm between surgery and other branches of medicine. For all that, the mediæval surgeon in eastern Europe remained far behind his predecessors of the Roman and Byzantine empires. Traumatic hæmorrhage was arrested by the cautery and styptics, though the ligature had not quite fallen into oblivion. Operations for hernia and vesical calculus ranked highest in importance. Plastic surgery was a 15th-century revival of the ancient procedure, carried to rare perfection a century later by Tagliacozzi, again to sink into disuse. Similar fate befell the narcotic drinks (see ANÆSTHESIA), resuscitated in the same century, to dull the pain of surgical operations. The active principle of these had been inhaled even

in the 13th century, and Guy de Chauliac also used opium internally for the same end.

With the 16th century we find surgery sharing the advance communicated to every art by the Renaissance, while its practitioners improved their social standing. In this the way had been led by Paris with her College of Surgeons (Collège de St Côme, 1279), which in the teeth of the university 'faculty' conquered the right to create licentiates in surgery. Other qualifying corporations (in London, for example, and Edinburgh) arose gradually on similar lines. But what crowned the recognition of surgery as a liberal profession was its steady progress as a beneficent public agent in peace as in war. Skill in treating gunshot wounds, in substituting the ligature for the cautery in amputations, and in dealing with the cutaneous affections due to pestilences like that of syphilis reinforced the claims to respect already established by fuller anatomical, chemical, and botanical knowledge. The powerful if eccentric genius of Paracelsus was signally instrumental in this direction; still more so the sound sagacity and nobly philanthropic inspiration of Ambrose Paré (1517–90). Galileo, Bacon, and Descartes revolutionised scientific method, among the fruits of which was Harvey's discovery of the circulation of the blood. With the diffusion of juster and more comprehensive notions of structure and function surgery took bolder and more effective flights, reaching her highest point in the 17th century under Richard Wiseman, 'the father of English surgery,' from whose *Seven Chirurgical Treatises* may be gathered the great accessions he made to sound practice, particularly in tumours, wounds, fractures, and dislocations. The lines of scientific surgery were now laid, and her advance became at once safer and swifter. In the 18th century Paris improved upon her Collège de St Côme by her Académie de Chirurgie, long the headquarters of the highest professional and literary culture. England contributed Cheselden and Pott, Scotland James Douglas, the three Monros, Benjamin Bell, and above all John Hunter to the promotion of a more enlightened practice, based on anatomical and physiological research. London, Edinburgh, and Dublin became centres of surgical education, which, by the admission of Häser, no continental school, not even Paris, could equal in the sovereign qualities of sagacity in diagnosis and assured boldness in operation. Prussia came far behind with her Collegium Medico-Chirurgicum in Berlin, and Austria only in 1780 and 1785 obtained the means of training surgeons of the higher grade, civil and military; while America by her school, under Dr Shippen in Philadelphia, laid the foundations of her subsequent and nobly sustained proficiency.

To the distinguished anatomists Mascagni and Scarpa in Italy, Breschet and Geoffroy St Hilaire in France, the brothers John and Charles Bell in Great Britain, the Meckels, Berres, Tiedemann, C. M. Langenbeck in Germany, seconded by physiologists like the Italian Panizzo, the Scottish Charles Bell, the English Marshall Hall, the French Magendie, Flourens, Duchenne, and Bernard, the German Prochaska, Purkinje, the brothers Weber, and Joannes Müller, surgery owes the mighty advance she made in the first decades of the 19th century. Of these pioneers some were themselves surgeons of the first rank, such as Scarpa and the brothers Bell; while among those who were equally great as teachers or writers and operators must be noticed Desault, Dupuytren, Roux, Delfsch, and Lallemand in France; Lizars, Allan Burns, Liston, and Syme in Scotland; Abernethy, Astley Cooper, Brodie, and Lawrence in England; Warren, Mott, and Gross in America; Wattman, Siebold,

Walther, Chelius, Langenbeck (already mentioned), Stromeyer, Graefe, and Dieffenbach in Germany; Kern, Pitha, and Linhart in Austria; Pirogoff and Szymanovsky in Russia. Anatomico-pathological museums and clinical instruction, displaying a wealth in object-lessons impossible before, are among the chief causes of the perfection to which the surgical profession is rapidly attaining. Add to these the introduction of anæsthetics, of the antiseptic ligature and dressing, of the galvano-cautery, of the transfusion of blood, and of the engrafting on patients of tissue taken from the healthy subject, and we can realise the revolution that has so altered the surgeon's art as to make its present position one of the greatest triumphs of human intellect, energy, and resource.

Häser's and Puschmann's works (the latter translated into English by Hare, Lond. 1892) give the fullest and most trustworthy account of the healing art, surgical as well as medical. Monographs like Wise's *History of Medicine among the Asiatics*, Young's *Annals of the Barber-Surgeons of London*, Struthers' *Historical Sketch of the Edinburgh Anatomical School*, and Cameron's *History of the Royal College of Surgeons in Ireland* may also be consulted. Special operations in surgery (Lithotomy, Ovariotomy, &c.) are dealt with under their respective heads, or in connection with the articles on such subjects as AMPUTATION, DISLOCATION, EYE, FRACTURE, HIP-JOINT, SHOULDER, &c. There are articles on CATHETER, OPHTHALMOSCOPE, STETHOSCOPE, TOURNIQUET, &c. See also Ashhurst's *International Encyclopedia of Surgery* (6 vols. 1882-86); *A System of Surgery*, by various authors, edited by Treves (1895 *et seq.*); the articles in this work on the great surgeons; and for a record of contemporary surgery the annual summaries in the concluding numbers of the *Lancet* and *British Medical Journal*.

Suricate, a South African carnivore belonging to the family of the Viverridae, of which the civet, genet, and ichneumon are representatives, but with much longer legs than these its kin. The body and head reach a length of 12 or 13 inches, the tail 6 inches. There are only four toes, and the claws are very long, suited for burrowing.

Surinam. See GUIANA (DUTCH). For the Surinam Toad, see AMPHIBIA.

Surmullet. See MULLET.

Surname. See NAMES.

Surplice (Lat. *super pellicium*, 'above the robe of fur' worn by the monks from the 9th century), a white linen garment worn over the cassock by clerks of all degrees. Its most ordinary use is for the service of the choir, and it is also employed, along with the stole, by priests in the administration of the sacraments, and in preaching. The use of the surplice was strongly objected to by the Calvinistic and Zwinglian reformers on the Continent, and by the Puritans in England, who regarded this vestment as a relic of popery, and made it the subject of vehement denunciations. Ere ritualism became so common in England, no little stir used from time to time to be created by the use of the surplice, instead of the Gown (q.v.), in the pulpit, contrary to the more general practice in the Anglican Church. The length of the surplice varies, never in the Roman Church coming below the knees; the short Italian *cotta*, adorned with lace, dates from about the 17th century.—*Surplice-fees* are payments to the clergy by the laity when any sacred functions—baptisms, marriages, funerals—are performed for the latter's benefit.

Surrender. See CAPITULATION.

Surrey, an inland county in the south of England, is bounded on the N. by the Thames, which separates it from Middlesex, E. by Kent, S. by Sussex, and W. by Hants and Berks. Its maximum length from east to west is 39 miles; greatest

breadth, 26 miles; and it contains 758 sq. miles, or 485,129 acres. Pop. (1801) 269,043; (1831) 485,700; (1861) 831,093; (1891) 1,731,343. Far-famed for the beauty of its scenery, Surrey is traversed from east to west by the North Downs (see DOWNS), which, near Titsey on the Kentish border, rise to the height of 880 feet; on the north side of this range the land slopes gradually to the banks of the Thames—though even there plenty of high ground is to be found, as Cooper's Hill, St George's Hill, Richmond Park, and Wimbledon Common—but on the south the descent is rugged and broken up before the level of the Weald is reached. South of the main range, and about 5 miles distant from Dorking, is Leith Hill (967 feet), the highest point in the county, whilst in the extreme south-west rises Hind Head (903 feet). From all these places, as also from many others—e.g. the Hog's Back, St Martha's Chapel, and Newland's Corner (both near Guildford), Box Hill, the downs above Reigate and Epsom, and at Virginia Water—glorious views are to be obtained, a noticeable feature in the landscapes being the prevalence of commons and heath-lands—the latter chiefly in the west—scattered throughout the county. Of rivers the most important are the Wey and the Mole, both tributaries of the Thames. The soil of the northern half of the county is fertile, especially in the vicinity of London, where large tracts are occupied by market-gardens and nursery-grounds, but in the centre and southern districts the land is of a poor quality, consisting mostly of sand and chalk; it is well wooded, box-trees especially growing in great profusion, and around Farnham some 2000 acres are under cultivation as hop-grounds. Croydon, Guildford, Kingston, and Reigate are—not reckoning the suburbs of London—the principal manufacturing centres and most important towns, near the last named also extensive beds of Fuller's Earth (q.v.) being found. The county is divided into fourteen hundreds, and since 1885 has returned six members to parliament; the county council consists of seventy-six members.

In history Surrey has played but a meagre part, the only incident of importance of which it was the scene, other than those noticed under Kingston, being a defeat of the Danes at Ockley in 851. Between the two last-named places traces of the old Roman road between London and Chichester are plainly visible, whilst on Wimbledon Common, Hascombe Hill, and near Aldershot are Roman encampments. Of buildings of an architectural or historical interest the castles of Farnham and Guildford and the ruined abbeys of Newark and Waverley most call for attention, whilst at Claremont, Oatlands Park, and Sheen (now Richmond), were royal residences; nor must mention be omitted of the quaintly-timbered old houses—many of them moated—abounding in the districts around Goshall, Godalming, and Haslemere. Of Surrey worthies the best known are William of Ockham, Thomas Cromwell, Earl of Essex, Archbishops Abbot and Whately, Bishops Corbet and Wilberforce, Middleton and Oxenford (the dramatists), John Evelyn, Sir W. Temple, Viscount Bolingbroke, Admiral Lord Rodney, Banks (the sculptor), Gibbon, Horne Tooke, William Cobbett, Malthus, Herring (the animal painter), Michael Faraday, George Rennie, Sydney Herbert, Robert Browning, Hablot K. Browne, Albert Smith, Dr Jowett, Eliza Cook, Sant (the R.A.), Sir George Grove, Professors Cayley and Sidney Colvin, Dr Furnivall, Gilchrist (the biographer), and Miss Faithfull.

See works by Manning (3 vols. 1804-14), Allen (2 vols. 1829-30), Brayley (5 vols. 1841-48), Bevan (Stanford's series, new ed. 1891), and Murray's *Handbook to Surrey and Hants* (new ed. 1888); also *On Surrey Hills* (1892).

Surrey. HENRY HOWARD, EARL OF, poet, was born between 1516 and 1518, most probably in Suffolk, either at Framlingham or Tendring Hall, the eldest son of Thomas Howard (q.v.), who in 1524 succeeded as third Duke of Norfolk. In 1532 he was married to Lady Frances Vere, daughter of the Earl of Oxford, in the same year accompanied Henry VIII. to France, and afterwards spent about twelve months in study at Paris in company with Henry's natural son, the young Duke of Richmond, who was affianced to his only sister, but died an untimely death in 1536. Surrey's eldest son Thomas was born that same year, and it is interesting that the child's nativity, which still exists, foretold dark disaster to the father. It was soon after this that his romantic passion for the fair but disdainful Geraldine awoke, unless she is to be relegated to the domain of fancy in the same sense as Héloïse, Petrarch's Laura, and Tasso's Leonora. It seems certain, however, that if she had real existence she was the Lady Elizabeth Fitzgerald, the second of the three daughters by his second marriage of Gerald, ninth Earl of Kildare. But the story is surrounded with difficulties, and we are not helped by Thomas Nash's absurd account (*Unfortunate Traveller*, 1594) of how Surrey traversed Italy like a knight-errant for his mistress' sweet sake. His second son, afterwards Earl of Northampton, was born in 1539. In 1542 he was made a Knight of the Garter. Later in the same year he lay some time in the Fleet for challenging a gentleman with whom he had quarrelled, and next year he was again committed for roystering and breaking windows in the streets at night. Soon released, he went to serve in the camp before Landrecy near Boulogne, and returned in winter to complete his beautiful seat of Mount Surrey near Norwich. It was at this time that he admitted to his household the physician Hadrian Junius and the poet Churchyard. Again in 1544 Surrey went to France as marshal of the invading army, and distinguished himself at the siege of Montreuil, being severely wounded in the attempted storming (19th September). Again next year we find him holding command at Guisnes and at Boulogne, and defeated by a superior French force in the beginning of January, for which he was soon superseded by the Earl of Hertford, who, as uncle to the heir to the throne, looked forward to a regency on the king's death, and at once feared and hated the Norfolk party. For his bitter speeches against Hertford Surrey was imprisoned at Windsor in July, and on the 12th December was, like his father, committed to the Tower on a charge of high-treason. His offence was merely that he had assumed the arms of his ancestor Edward the Confessor, in conjunction with his own proper arms, a thing which by all the laws of heraldry and common usage he was perfectly entitled to do, and which, moreover, had been specially allowed the Duke of Norfolk by Richard II. His father's mistress and his own sister gave evidence against him, and, though he defended himself with singular ability at his trial at the Guildhall on the 13th January 1547, he was found guilty by the jury, condemned to death, and beheaded eight days later, 21st January 1547. His body was first buried in All Hallows-Barking, Tower Street, but was removed by his son, the Earl of Northampton, to Framlingham Church, where it rests under a stately monument of black and white marble.

Surrey's character would seem to have been much less amiable than it appeared to his eulogist, Dr Nott. He was proud, headstrong, and imprudent, and his unkindness to his mother remains a blot upon his memory, however unworthy of respect she may have been. His poems seem to have circulated freely in manuscript during his lifetime, but were

not printed till 1557, when they appeared, together with poems by Wyatt and others, in *Tottel's Miscellany* (ed. Arber, 1870). They consist of sonnets, lyrics, elegies, translations, paraphrases of the Psalms of David and Ecclesiastes, besides translations in good blank verse—the first in English—of the second and fourth books of Virgil's *Æneid*, the last not given in Tottel. As a poet he shows grace, delicacy, a quick eye for the beauties of nature, and a sensitive ear to the harmonies of versification. His love-poetry follows Petrarch too closely, yet not without a truth and genuineness of feeling of its own. He was not only the first in English to employ the sonnet, but within his range he had mastered the difficulties of that artificial form.

See the edition of Surrey and Wyatt in two goodly quartos, by Dr G. F. Nott (1815-16); of Surrey alone, in the 'Aldine Poets' (1831; reprint 1866).

Surtees, ROBERT, born at Durham, 1st April 1779, graduated B.A. from Christ Church, Oxford, in 1800, and, after less than two years at the Middle Temple, in 1802 came into his paternal estate of Mainsforth, near Bishop Auckland. Here till his death on 11th February 1834 he largely devoted himself to the compilation of his *History and Antiquities of the County Palatine of Durham* (vols. i.-iii. 1816-23), to vol. iv. of which (1840), completed by the Rev. James Raine, a memoir by George Taylor is prefixed. To Scott's *Minstrelsy* Surtees contributed two 'ancient' ballads he himself had made—*Barthram's Dirge* and *The Death of Featherstonhaugh*. The Surtees Society, founded in 1834 for the publication of unedited MSS. relating chiefly to the northern counties, issued its seventy-third volume in 1884.

Surturbrand, a kind of Lignite (q.v.) found in the north of Iceland, and used for fuel, has a great resemblance to the black oak found in bogs.

Surveying. Land-surveying may be considered the earliest practical application of the art of geometry or earth measurement, and must have been in some more or less rude form coeval with agriculture and the division or appropriation of the soil. In Rome surveying was considered one of the liberal arts, and the measurement of lands was entrusted to public officers who enjoyed certain privileges; and it is probable that the system of measurement practised by them was very similar to our plain surveying with the chain and cross-staff of the present day, and has been handed down to us through the feudal period. An examination of ancient records and title-deeds will show that both areas and boundary lines of the different enclosures forming fields, hundreds, town-lands, &c. are often laid down with much accuracy.

Land-surveying may be considered under the following heads: (a) Plain surveying with the chain, and without the aid of angular instruments, except the cross-staff or fixed angle of 90°; (b) modern engineering surveying, in which angular instruments are used; (c) coast and military surveying; (d) trigonometrical surveying.

The fundamental rule of every description of land-surveying, from the humblest attempt to lay down an irregular garden-plot to the trigonometrical survey of a large extent of the earth's surface, when the aid of the most refined improvements of modern science is indispensable, is simply to determine three elements of a triangle, and thence to calculate its area.

In plain surveying with the chain the three sides of the triangle, ABC, are supposed to be accessible, and are carefully measured on the ground, and then laid down or platted to scale on paper, when an accurate figure of the triangle will be obtained, on which the length of the sides can be marked. To get the area, however, it will be necessary to

determine the length of the perpendicular line AD, and this is usually done (when possible) on the ground by means of a simple instrument called a cross, which consists of two sights or fine grooves at right angles to each other; which being placed on the line BC (keeping B and C visible in one of the sights), nearly opposite the angle A, is moved gradually till the angle A is intersected by the other sight. The line AD can also be laid down on the drawing, and its length found by scale and afterwards verified on the ground, or it may be at once laid down on

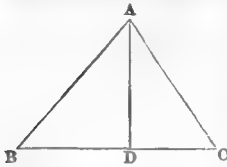

matter what the form of the surface to be surveyed may be—polygon, trapezium, or trapezoid—it may thus be determined by a judicious subdivision into triangles; and when the survey is not of a very extended nature or character, and when no serious obstructions exist, chain surveying is both accurate and expeditious, especially if proof or tie lines are properly introduced for the purpose of testing the accuracy of the work.

In every description of surveying it is best to make the original triangle as large as possible, and to work from a whole downwards rather than build up a large triangle by the addition of several small ones. It would be impossible here to lay down rules to meet the many difficulties which arise in the practice of surveying; indeed the best test of a good surveyor is the ease with which he will overcome local obstructions which appear almost insurmountable to a novice, or even to a theoretical surveyor with little field practice. Where buildings or other impediments are found in the measurement of a straight line, they are generally passed by the erection of short perpendiculars sufficient to clear the obstacles, and a line parallel to the original measured as far as they exist, when the original line can be again resumed. Differences of level occurring in measuring a line where no instruments are used are generally compensated or allowed for by the judgment of the surveyor.

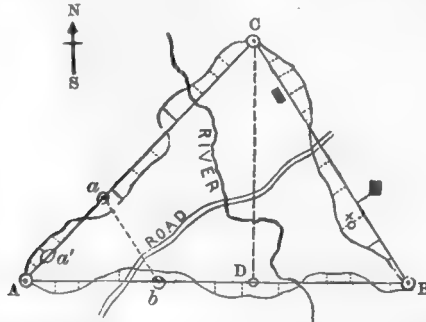

PAGE 1.		PAGE 2.	
To \odot C	To \odot C	To \odot C	To \odot C
1500	1274	500	486
1400			
1200			
1000			
900			
800			
700			
600			
500			
400			
300			
200			
100			
0			
From B	L \odot B	From D on A	\odot to C.
	To \odot B		To \odot A
	2075		1800
	1950		1700
	1900		1600
	1800		1500
	1600		1400
	1500		1300
	1380		1200
	1360		1100
	1300		1000
	1275		900
	1100		800
	1000		700
	900		600
	800		500
	700		400
	600		300
	500		200
	400		100
	350		0
	220		
	0		
From A	go to B.	From C	go to A.

The line *ab* may be similarly booked and platted.

the ground by the use of the chain alone. An improved reflecting instrument, called an optical square, is also often used for this purpose. Any boundaries along the lines or sides of the triangle, ABC, can be determined by the use of offsets or insets, as they occur on right or left of line. No

In registering the dimensions taken on the ground, such as sides of triangles, offsets, intersections of roads, fences, &c., and everything necessary to make a perfect delineation or plan of the surface, surveyors use what is called a field-book, the mode of keeping which varies very much with individual practice. Some surveyors use hand sketches or rough outlines of the form of the ground, and mark the dimensions on them, while others use the ordinary form of field-book, or a combination of the two methods, which perhaps is the best when any difficult complications happen on the ground, such as the frequent occurrence of buildings, enclosures, water, &c. along the line. In the ordinary field-book the centre column, commencing from the bottom, represents the length of any line or side of a triangle, and the figures in the column the distance at which the offsets to the right or left are taken, or where roads, streams, fences, &c. cross the line, or buildings adjoin the same. We give herewith the field-book of the assumed survey of the triangle ABC, with the different offsets and insets on its sides, and where roads, fences, streams, &c. cross them, the detail of which can be obtained by subdividing the triangle into smaller internal ones. The figure can thus be laid down from the book, and its area calculated by the formula $\frac{AB \times CD}{2}$, and the offsets and insets calculated, and added or deducted.

Ponds, plantations, and enclosures of different kinds may be surveyed with a chain, especially if their form be such that they can be conveniently included in the area of a triangle, the correctness of which being proved by proper tie-lines, the form, area, &c. may be ascertained by offsets, or rather insets from the sides.

See ORDNANCE SURVEY, LEVELLING, MENSURATION, THEODOLITE, CONTOUR, &c.; and for the United States Coast Survey, see CHART.

Surya, in Hindu Mythology, the sun-god.

Sus, (1) a river and district of Morocco (q.v.), between the Atlas and the Anti-Atlas.—(2) A port of Tunis, 75 miles SE. of the capital. Pop. 8000.

Susa, the same as the Shushan of Daniel, Esther, &c., a town of Persia, identified with the modern Sus, anciently the capital of Susiana (the *Elam* of Scripture, mod. *Khusistan*), and one of the most important cities of the old world. Its foundation is ascribed by some ancient writers to Darius Hystaspes, by others to Memnon, the son of Tithonus; and its name, together with its ground-plan, is traced on Assyrian monuments of the reign of Assur-bani-pal (about 660 B.C.). At the time of Daniel's vision 'at Shushan in the palace' it was under Babylonian dominion, but it was brought by Cyrus under Persian rule; and the Achaemenian kings raised it to the dignity of a metropolis of the whole Persian empire, having there a strong citadel and one of their treasure-houses. At the Macedonian conquest Alexander is reported to have found in it vast treasures, together with the regalia. On Babylon becoming the principal city of Alexander and his successors, Susa gradually declined, but seems still to have contained enormous wealth when it fell into the hands of Antigonus (315 B.C.). It was attacked by Molon in his rebellion against Antiochus the Great, and held out bravely for a long time against the Arab invaders at a later date. They, however, destroyed the fortifications. The ruins of the ancient city, the palace described in Esther among them, cover a space of about three square miles. The principal existing remains consist of four spacious artificial platforms above 100 feet high. Traces of a gigantic colonnade were laid bare by Mr Loftus, with a frontage of 343 feet and a depth of 244. Cuneiform inscriptions exist, together with many relics similar to those found at Persepolis. The 'tomb of Daniel' shown near Susa was a place of pilgrimage previous to the Arab conquest. See books by Williams, Loftus, Churchill, and Dieulafoy, all of whom have explored the site.

Susa, a city of Northern Italy, on a tributary of the Po, at the foot of the Cottian Alps, 32 miles by rail W. of Turin. It has a cathedral (1029), and a triumphal arch erected by the Romanised Segusian chief to Augustus in 8 B.C. The people (3305) grow fruit and grapes, and carry on iron, leather, and silk industries. See also **SUS**.

Susannah, HISTORY OF, *The Judgment of Daniel*, also *Susannah and the Elders*, are the different titles of a well-known story, which forms one of three apocryphal additions to the book of Daniel; the other two being *The Song of the Three Holy Children* and *The History of Bel and the Dragon*. It relates how Susannah, the wife of Joacim, and daughter of Hilkiah, celebrated alike for her beauty and her virtue, was falsely accused of adultery by two of the elders, whose own unchaste proposals she had spurned; and how, being condemned to death on their evidence, she was saved by the wise young Daniel, who made the elders confound each other in separate examination, and doomed them to the same fate they had designed for her. In most MSS. this story precedes the first chapter of the Book of Daniel, and so we find it in the old Latin and Arabic versions; but the Septuagint, the Vulgate, the Complutensian Polyglot, and the Hexaplar Syriac place it at the end of the present book, and reckon it as the 13th chapter. There are two Greek versions varying considerably—that of the LXX. and that of Theodotion. There is no satisfactory evidence that it ever had a Hebrew or Aramaic original at all. Africanus had a controversy with Origen on the authenticity of *Susannah* and *Bel and the Dragon*, and pointed

out that their original could only have been a Greek one, as the example of paronomasia in the words of Daniel depended on the Greek. Porphyry based his attack on Daniel partly on the Greek origin of *Susannah*. Jerome is careful to distinguish it from the rest of Daniel, as not possessing the authority of Scripture. At the same time the story is used by Hippolytus, Origen, Tertullian, Ambrose, Gregory Nazianzen, and Chrysostom. The object of the story may have been to correct the procedure of the Sanhedrin, by insisting on the proper use of evidence and the examination of witnesses.

See Churton's edition of the *Apocrypha* (1884), and Wace's *Commentary on the Apocrypha* (1888).

Suso, Henry (1295–1366), German mystic, was a monk at Constance, and died at Ulm. He was a follower of Eckhart (q.v.).

Suspended Animation, the temporary cessation of the outward signs and of some of the functions of life, is treated under various heads in this work. In men it may be due to Asphyxia, Drowning, Strangulation, &c. See also **CATALEPSY**, **COMA**, **INSANITY**, **SLEEP**, **DEATH**, and for premature burial, **BURIAL**. For phenomena of this kind in the lower animals, see **LIFE**, **DESICCATION**, **HIBERNATION**, **LATENT LIFE**, **ROTATORIA**, &c.

Suspension Bridge. See **BRIDGE**.

Susquehanna, an American river, the North Branch (350 miles) of which has its origin in Schuyler Lake, in central New York, and the West Branch (250 miles) in the Alleghany Mountains. These two unite at Northumberland, Pennsylvania, and the river thence flows south to Harrisburg, and then south-eastward into Maryland, and so to the north end of Chesapeake Bay. Length, 150 miles; chief tributary, the Juniata. It is a shallow, rapid, mountain river, with varied and romantic scenery, and is of use mainly for floating timber. On its banks Coleridge and Southey proposed to found their 'pantisocracy.'

Sussex, a maritime county in the south of England, washed on the south-east and south for 91 miles by the English Channel, and elsewhere bounded by Hampshire, Surrey, and Kent. It has an extreme length from east to west of 76 miles, an extreme width of 27, and an area of 1464 sq. m., or 936,911 acres. From the Hampshire border, near Petersfield, to Beachy Head (q.v., 575 feet) the county is traversed by the chalky South Downs, whose highest point is Ditchling Beacon (858 feet), and whose northern escarpment is steep, but leads down to the fertile and richly wooded Weald. Beyond this again, in the north-east, is the Forest Ridge (804 feet). A very productive tract, 2 to 7 miles broad, extends westward from Brighton along the coast to the Hampshire boundary; in the south-east are rich marsh-lands, affording excellent pasture. The chief streams, all unimportant, are the Arun, Adur, Ouse, and Rother. Rather more than two-thirds of the entire area is in cultivation; and 177 sq. m. (second only to Yorkshire) are occupied by woods—in the Weald, St Leonards and Ashdown Forests, &c. The Downs (q.v.) are clothed with a short, fine, and delicate turf; and here and elsewhere more than half a million of the well-known Southdown sheep are grazed, the live-stock also including some 25,000 horses and 113,000 cattle. Sussex was once the chief seat of the iron trade, when wood was used for smelting, and its last furnace was not blown out till 1809; to-day the manufactures are not important. The county, which contains six 'rapes,' 68 hundreds, and 317 parishes, has since 1885 returned six members to parliament. Brighton and Hastings are parliamentary and Arundel, Chichester, Eastbourne, Lewes, and Rye municipal boroughs; whilst Newhaven, Worthing, Seaford, Littlehampton, and

Bognor also deserve mention. Pop. (1801) 159,471; (1841) 300,075; (1881) 490,505; (1891) 550,446. Sussex contains the landing-place of Cæsar (55 B.C.) either at Pevensey or near Deal; of Ælla (477 A.D.) at Keynor, near Chichester, from whose subjects, the South Saxons, the county derived its name; and of William the Conqueror (1066) at Pevensey, as well as the battlefields of Hastings and Lewes. The antiquities include a British camp at Cissbury, Roman remains at Pevensey and Bognor, a dozen mediæval castles (Arundel, Bodiam, Hurstmonceaux, Hastings, Bramber, &c.), and nine or ten religious houses (Lewes, Battle, &c.). Cobden, Collins, Fletcher, Otway, Sackville, Selden, and Shelley have been among the eminent natives; and Sussex also has memories of Chillingworth, Lyell, Archdeacon Hare, John Sterling, Cardinal Manning, and Titus Oates.

See works by T. W. Horsfield (2 vols. Lewes, 1835), M. A. Lower (3 vols. 1865-70), C. W. D. Parish (*Domesday Book in relation to Sussex*, 1886), and G. F. Chambers (3d ed. 1891).

Sustentation Fund. See FREE CHURCH.

Sutherland, a maritime county in the extreme north of Scotland, is bounded W. and N. by the Atlantic, E. by Caithness, SE. by the North Sea, and S. by the Dornoch Firth and by Ross and Cromarty. Measuring 63 by 59 miles, it has an area of 2126 sq. m., or 1,360,459 acres, of which 47,633 are water and 12,812 foreshore. The Atlantic coasts, deeply indented by sea-lochs, are bold and rock-bound, in Cape Wrath (q.v.) attaining 523 feet; the south-eastern seaboard is comparatively flat. On the Caithness boundary rise the Hill of Ord (1324 feet) and Cnoc an Eireannaich (1698); but the mountains of Sutherland are all in the west—Benmore Assynt (3273), Coniveall (3234), Bendibrick (3154), Ben Hope (3040), Foinaven (2980), Canisp (2779), and Sulven or the Sugar-loaf (2399). The Oyckell, tracing the Ross-shire boundary, and falling into the Dornoch Firth, is the longest stream (35 miles); and of over 300 lochs and tarns the largest are Lochs Shin (16 × 1½ miles) and Assynt (q.v., 6½ × ½). The geology is of great interest—Archean gneiss predominating in the west, then Silurian, and then Old Red Sandstone. Coal has been mined at Broa off and on since 1573; and a find of gold at Kildonan in 1868 for a time caused a rush of 'diggers.' The total percentage of cultivated area is only 2.9, in spite of costly reclamations carried on by the 3d Duke of Sutherland (1828-92), the largest proprietor—so costly indeed that during 1853-82 the expenditure on his estates exceeded the income derived from them by nearly a quarter of a million sterling. The live-stock includes over 10,000 cattle and 200,000 sheep; and the deer-forests, grouse-moors, and fishings (especially good for trout) attract many sportsmen. The climate varies much, and also the rainfall, which increases westward from 32 to 60 inches. Sutherland returns one member to parliament; its county town is Dornoch (q.v.). Pop. (1801) 23,117; (1851) 25,793; (1881) 23,370; (1891) 21,896. The Northmen, who down to the 12th century often descended on Sutherland and pillaged it, called it the 'Southern land,' as lying to the south of the Orkney and Shetland islands. An earldom of Sutherland was held from about 1228 by the Freskin family, but passed by marriage in 1514 to the Gordons, whose line also ended in an heiress in 1766. She married in 1785 George Granville Leveson-Gower, second Marquess of Sutherland, who in 1833 was created Duke of Sutherland. To him was due the credit or discredit of the so-called 'Sutherland clearances' (1810-20), by which the small tenants, living wretchedly in the interior, were compelled to remove to the coast or to the valleys near the sea.

See Sir Robert Gordon's *History of the Earldom of Sutherland* (1813), Bishop Pococke's *Tour in 1760 in Sutherland and Caithness* (1888), C. W. G. St John's *Tour in Sutherlandshire* (2 vols. 1849; new ed. 1884), A. Young's *Angler's Guide to Sutherland* (1880), A. Mackenzie's *History of the Highland Clearances* (1883), and J. E. Edwards-Moss's *Season in Sutherland* (1888).

Sutherland Falls. See NEW ZEALAND, Vol. VII. p. 487.

Sutlej, or SATLAJ (anc. *Hypphasis* or *Hesidrus*), the eastmost of the five rivers of the Punjab, rises in the sacred lakes of Manasarowar and Rakas-tal in Tibet, at a height of 15,200 feet, and near the sources of the Indus and the Brahmaputra. It flows at first north-west, but turns westward to cut its way through the Himalaya Mountains, in the course of which passage it drops to about 3000 feet. After entering British territory it pursues a general south-western direction, receives the Li or river of Spiti, passes round the Siwalik Hills, picks up the waters of the Beas and the Jhelum-Chenab, and after flowing 900 miles in all joins the Indus at Mithankot, south of Multan. Not far from Jullundur it is crossed by a magnificent iron bridge, 5200 feet long, carrying the Sind, Punjab, and Delhi Railway, and near Bhawalpur, just before its confluence with the Jhelum-Chenab, is spanned by the bridge of the Indus Valley Railway.

Sutler. See CAMP FOLLOWERS.

Sûtra, in Sanskrit Literature, the technical name of aphoristic rules, and of works consisting of such rules. In such aphorisms the ground-works of the ritual, grammatical, metrical, and philosophical literature of India are written. See SANSKRIT, VEDA, PITAKA.

Suttee (an English spelling of the Sanskrit *sati*, 'a virtuous wife'), a usage long prevalent in India, in accordance with which on the death of her husband the faithful widow burned herself on the funeral pyre along with her husband's body, or, if he died at a distance, was burned on a pyre of her own. The practice was in use in India as early as the times of the Macedonian Greeks, and was based by Hindus on various of their sacred books and laws (the Brahma Purāna, the Vyāsa, &c.). But the researches of European scholars have made it absolutely certain that no countenance to this barbarous rite can be derived from the oldest and most sacred scriptures. The few passages professedly cited from the Vedas have been proved to be misquoted, garbled, or wholly false; and the laws of Manu are silent on the subject. Nevertheless self-immolation, though not enforced on an unwilling victim, and not practised except in certain castes and families of old descent, was almost made incumbent on well-born widows by force of public opinion, unless they were willing to risk their own happiness here and hereafter. The rite was no doubt entirely alien to pure Brahmanism, and was derived from a belief common to many savage races at all times of the world's history, that it was well to send wives, slaves, horses, favourite weapons, &c. along with a great man into the other world, by burying them with him, burning or slaying them at his tomb. In 1823 there were 575 widows burned in Bengal Presidency, 310 within the jurisdiction of the Calcutta court. Of these 109 were above sixty years of age, 226 from forty to sixty, 208 from twenty to forty, and 32 under twenty (Max-Müller, *Biographical Essays*, 1884). When Lord William Bentinck resolved to put an end to this hideous sacrifice he was met by fierce opposition both from natives and Europeans, though backed by some official and public opinion. And on the 4th December 1829 he carried the regulation in council which made all who

encouraged suttee guilty of culpable homicide. The enactment soon told on the custom. The prohibition of suttee is a feature of treaties between the imperial government and the native states; and though occasional cases of suttee occur in native territory, and rarely within the British area (on the death of Sir Jung Bahadur, prime-minister of Nepal, in 1877 several of his wives immolated themselves), suttee may be said to be practically extinct.

Sutton Coldfield, a municipal borough of Warwickshire, 8 miles NE. of Birmingham by rail, with an old Early English church, extended in Henry VIII.'s reign, and a new aisle built in 1880. Henry VIII. granted a charter in 1529, and the manor was entirely transferred to the corporation; a new charter was granted in 1885. Agriculture is the chief occupation of the neighbourhood; the borough is rapidly becoming a residential suburb of Birmingham. The picturesque Sutton Park (3500 acres), belonging to the inhabitants, is a favourite resort of picnic parties. Pop. (1891) 8685.

Sutton-in-Ashfield, a town of Nottinghamshire, 3 miles SW. of Mansfield. It has a fine church (1390; restored 1868), hosiery manufactures, and neighbouring coal-pits and lime-works. Pop. (1881) 8523; (1891) 10,563.

Sutton-on-Sea, a seaside resort on the coast of Lincolnshire, much frequented by the people of the big towns of Nottingham, York, Lancaster, and Leicester, is 28 miles NE. of Boston by rail. It has a fine stretch of broad, firm sand, and close by a submerged forest may be seen at low tide.

Suture (Lat. *sutura*, 'a seam') is a term employed both in Anatomy and Surgery. In anatomy it is used to designate the modes of connection between the various bones of the cranium and face. A suture is said to be *serrated* when it is formed by the union of two edges of bone with projections and indentations (like the edge of a saw) fitting into one another. The coronal, sagittal, and lambdoidal sutures (see SKULL) are of this kind. A suture is termed *squamous* when it is formed by the overlapping of the bevelled (or scale-like) edges of two contiguous bones.

In surgery the word suture is employed to designate various modes of sewing up wounds, so as to maintain the opposed surfaces in contact. The materials most commonly used are silk, silver wire, horsehair, and specially prepared catgut. As it may fall to the lot of any person, on an emergency, to have to sew up a wound, the following general rules, applicable to all forms of suture, should be attended to. In passing the needle, the edges of the wound should be held in contact with the fore-finger and thumb of the left hand; and the needle

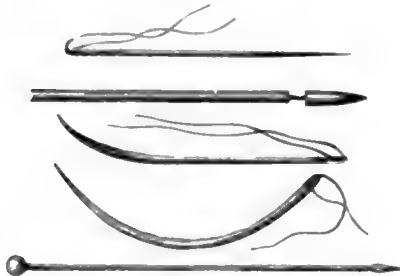

Fig. 1.

should penetrate the surface at about an angle of 50° (rather more than half a right angle), and should, at least, pass through the whole thickness of the skin at each stitch. The distance from the edge of the wound at which each stitch should

enter and leave the skin must vary with the depth of the wound; but there should never be less than the eighth of an inch between the margin of the wound and the entrance or exit of the needle. Sutures should not include vessels, nerves, muscles, or tendons. The line of the thread should cross that of the wound at right angles. For incised wounds on the surface of the body, when the edges can only be transfixed from the cutaneous surface, or when the opposite margins can both be traversed by one plunge, a curved needle (such as a common packing-needle) is most convenient for the completely free margins of extensive wounds, such as are left after amputation. Fig. 1 represents various forms of needles used by surgeons; fig. 2 shows the *twisted suture*, as used in the operation for hare-lip, in which the wound is transfixed by pins, around which, beginning with the uppermost, a thread is twisted, in the form of the figure 8.



Fig. 2.

Suvalky (*Suwalki*), a Polish town, capital of a Russian government, 48 miles NW. of Grodno. Pop. 19,367. For the area and population of the government, see RUSSIA.

Suvóroff, or SUWARROW, ALEXANDER VASILIEVITCH, a Russian general, was born at Moscow on 24th November 1729, his father, of Swedish descent, being a general and senator. Small of stature and sickly in appearance, Alexander was a devoted student, and whilst still a boy acquired an excellent knowledge of languages; but his heart was fired with the passion of military glory, Caesar and Charles XII. of Sweden being the heroes of his imagination. He entered the army as a private when seventeen, but advanced rapidly in rank after the Seven Years' War, in which he greatly distinguished himself at Kunersdorf (1759) and Reichenbach (1761), and after the Polish war of 1768-71, in which his impetuous bravery, and the boldness and celerity of his attack, brought him prominently forward. From this time to the end of his life he was almost constantly in the field. In 1773 he passed from Poland to the south of Russia to war against the Turks; in 1774 he put an end to the insurrection of Pugatcheff; and in 1780 he crushed the revolt of the Kuban Tartars and other Caucasian tribes. He covered himself with glory in the Second Turkish War, defeating the armies of the sultan at Fokshani (1789) and at the river Rymnik, and storming the strong fortress of Ismail. In the Polish war of 1794 Suvóroff captured Praga, and so compelled the surrender of Warsaw. On the accession of the Emperor Paul he was for a time sent into retirement; but shortly afterwards Paul recalled him and ordered him (1799) to Italy to assist the Austrians in opposing the French. As usual he won battles, defeating Moreau on the Adda, Macdonald at the Trebbia, and Joubert at Novi. Then he was directed to cross the Alps and unite his forces with Korsakoff for the purpose of sweeping the French out of Switzerland. After a terrible march, with fearful sufferings and heavy losses, he found, on descending towards the canton of Schwyz, that Masséna had defeated Korsakoff, and being himself too weak to attack he barely managed to escape over the mountains into Austria. On his return to Russia he was overtaken by death at St Petersburg on 18th May 1800. Suvóroff was a little man (5 feet 4 inches), with a wrinkled

face and a stooping attitude; yet he was strong and healthy, and inured to hardship—he lived like a common soldier, and slept by preference on a truss of hay. Of great intelligence, he was a constant reader, even when on campaign, and a clever linguist. The idol of his soldiers, who loved to call him 'Father Suvóroff,' he was never defeated, and only once in his life acted on the defensive. He had a superb faith in his own star, and trusted to the inspiration of the moment, to rapidity of movement, and to boldness and dash in making the onset. Notwithstanding the terrible loss of life that attended his storm of Ismail (26,000 Turks were killed) and of Praga at Warsaw (where 15,000 Poles were massacred), he is stated to have been averse to shed blood, and to have been even humane and merciful. In his manners he was extravagantly eccentric, brusque and curt in speech, laconic in his despatches, and sarcastic to all who incurred the contempt of the soldier and man of action. Byron's description of him in *Don Juan* is as inaccurate as the biographies written by his enemies, the French. See *Life* by Lieut.-Col. Spalding (Lond. 1890).—The name of Suwarow Islands belongs to a part of the Manihiki (q. v.) group.

Suwanee River rises in southern Georgia, in the Okefinokee Swamp, and flows in a winding, generally south-south-west course through Florida into the Gulf of Mexico.

Suzdal, a small Russian town (7000), 12 miles N. of Vladimir, once capital of an important Russian principality. See **RUSSIA**, pp. 42, 43.

Suzerain, a feudal lord. The term was applied less to the king than to his vassals who had subvassals holding of them. In modern times suzerainty indicates a degree of formal or real authority varying from the relation of the Ottoman porte to the tributary states, to that of the British crown to the Transvaal or South African Republic.

Svas'tika, a religious symbol used by early races of Aryan stock from Scandinavia to Persia and India. It consists of a Greek cross, either enclosed in a circle the circumference of which passes through its extremities ⊕, or with its arms bent back thus , and was intended to represent

the sun, being found invariably associated with the worship of Aryan sun-gods (Apollo, Odin). Similar devices occur on the monumental remains of the ancient Mexicans and Peruvians, and on objects exhumed from the prehistoric burial-mounds of the United States. See **CROSS**.

Sveåborg, a fortress in Finland, sometimes called 'the Gibraltar of the North,' protects the harbour and town of Helsingfors (q. v.), from which it is 3 miles distant. The present strong fortifications, which were planned by Count Ehrensward in 1849, have been already described under Helsingfors. It only remains to add here that at Sveåborg there are an arsenal, docks, slips, and a monument to the 'father' of the fortress. Pop. 1000, excluding the garrison. The fortifications were betrayed into the hands of the Russians by the Swedish commandant in 1808.

Svendborg. See **FÜNEN**.

Svendsen, JOHAN SEVERIN, composer, born at Christiania, 30th September 1840. He studied at Leipzig, Paris, and in Italy, conducted concerts in his native town, and in 1883 became master of the Chapel Royal at Copenhagen. His works comprise symphonies, an overture, and quartets, quintets, and concertos for strings.

Sventigorodka, a town in the Russian province of Kieff, 100 miles S. of Kieff. Pop. 11,562.

Swabia (Ger. *Schwaben*), or **SUABIA**, an ancient duchy in the south-west of Germany,

stretching from Franconia to Helvetia (Switzerland) and from Burgundy and Lorraine to Bavaria. It was so named from the Germanic Suevi, who drove out the Celtic inhabitants of the region in the 1st century B.C. With those conquerors the Alemanni, who invaded that part of Europe in the end of the 5th century, became amalgamated; and from that time there were dukes in Swabia, except for the period 746-919. During the reigns of the Hohenstaufen emperors, who were natives of Swabia and almost invariably conferred the ducal dignity on some relative of their own house, this duchy was the most rich, most civilised, and most powerful country of Germany, and the ducal court was the centre of art, literature, and learning. After the extinction of the imperial Swabian (Hohenstaufen) line the dignity of duke of Swabia remained in abeyance; the feudatories of the duchy asserted an immediate dependence upon the empire, and waged frequent wars one upon another. Of these minor states the most important and most powerful were the countships of Würtemberg and Baden. The towns and cities, very many of which enjoyed the freedom of the empire, preserved a strong feeling for independence and a no less strong feeling of opposition to the feudal lords. In 1331 twenty-two towns (Ulm, Reutlingen, Augsburg, Heilbronn, &c.) united for purposes of mutual defence. Thirty years later many of the minor feudal lords formed a league to oppose the towns, and bloody feuds arose between the parties. The league of the feudal party was broken up by the Count of Würtemberg, the ally of the Swabian league (of towns), in the last years of the 14th century. Nevertheless feuds and violent dissensions still raged rampant, and even continued to do so after the emperor summoned all the parties concerned to a conference at Esslingen (1487), where the Swabian League was formed (1488) for the maintenance of peace throughout the old Swabian duchy. This unhappy region suffered terribly during the Peasant War (q. v.) of 1525, in the Thirty Years' War (1618-48), and during the wars of the French Revolution. From the time of the Reformation the rulers of Würtemberg contended with the German emperors for preponderance of power in what since the beginning of the 16th century was called the Circle of Swabia (one of the ten into which the empire was divided). The former proved the stronger in the long run, and in 1806 founded the modern kingdom of Würtemberg, which embraces the greater part of the old duchy.

The *Swabian School*, in German literature, indicates a band of writers who were natives of Swabia (as Uhland, Schwab, Kerner, Mörike, Hauff, and others). For the *Swabian Alb*, see **WÜRTEMBERG**.

Swaffham, a market-town of Norfolk, 15 miles SE. of Lynn. It has a cruciform Perpendicular church (1474) of great beauty, a corn-hall (1858), and an ugly market-cross (1783). Pop. (1851) 3858; (1891) 3636.

Swahili (Arab. *Waswahili*, 'coast people'), the name given to the people of Zanzibar and the opposite coast belonging to the Bantu stock, with an Arab infusion, and speaking a Bantu tongue modified by Arabic. The Swahili are intelligent and enterprising, and are in demand as porters by travellers into Central Africa. There is a collection of Swahili Folk-tales (1869) and a handbook by Bishop Steere (1871; new ed. 1875), and a dictionary by Krapf (1882).

Swale, a river in the North Riding of Yorkshire, flowing 60 miles ESE., and near Aldborough uniting with the Ure to form the Ouse (q. v.).

Swallow, a genus (*Hirundo*) and family (*Hirundinidæ*) of Passerine birds. The members of

this family are distinguished by their long and pointed wings, long head, slender wide bill, small legs and feet, tarsus scutellated in front, and tail generally forked. They have no autumn moult, but acquire their new dress in February; hence Seeböhm thinks they are a recent import from the south which, like some shrikes, have changed their breeding time, but have not yet altered their moulting time. The genus *Hirundo* is cosmopolitan in distribution, and contains about sixty species. The members are gregarious, and prefer well-cultivated districts and the proximity of water. They have great powers of flight and perch but little, catching their prey, which consists chiefly of insects, on the wing. Their usual

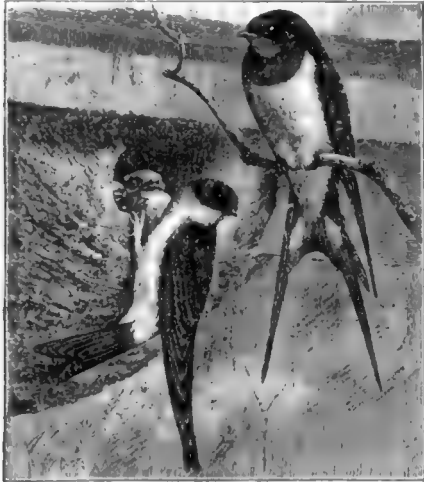

Fig. 1.—a, Common Swallow (*Hirundo rustica*);
b, House-martin (*H. urbica*).

note is a twitter, but some species sing sweetly. Their nests are built of mud, straw, and feathers, on ledges under eaves, on rocks, in caves, and in holes in earthy cliffs. Five species are found in Europe, and three are migrants to the British Isles. The Common Swallow, or Chimney-swallow (*Hirundo rustica*), is distributed in Europe, Asia, and Africa, from Lapland to the Cape of Good Hope and to the Moluccas. It breeds in the Orkney and Shetland Islands, and straggles to Iceland, Spitzbergen, and Nova Zembla, but does not reach America. It exhibits a character common to many other species, in the very long and deeply-forked tail, the two lateral feathers of which far exceed the others in length. The plumage is very beautiful, the upper parts and a band across the breast glossy bluish black, the forehead and throat chestnut, the lower parts white, and a patch of white on the inner web of each of the tail-feathers except the two middle ones. The whole length of the bird is about 8 inches, of which the outer tail-feathers make 5 inches. The female has a shorter tail, less chestnut on the forehead, and whiter under parts. The nest, probably originally built in caves, is made of mud or clay, formed into little pellets and stuck together, along with straw and bents, and lined with feathers. It is open and cup-shaped, and is generally placed in a situation where it is sheltered from wind and rain, as a few feet down an unused chimney, under the roof of an open shed, or in any unoccupied building to which access can be obtained. From four to six eggs are laid, blotched and speckled with shades of gray and brown. Two broods are produced in a year. Large flocks collect together in autumn before

they depart for the south. Some birds, probably belated individuals, have been found in a torpid state in winter. A popular delusion, shared in by Johnson, credited swallows with hibernating regularly under water. The Window-swallow, or House-martin (*H. urbica*, or *Chelidon urbica*), is another very common British species, glossy bluish black above, white below and on the rump; the feet covered with short, downy white feathers. Its length is a little over 5 inches; the sexes are alike in plumage. The nest is built of mud or clay, like that of the chimney-swallow, but is hemispherical, with the entrance on the side, and is attached to a rock, or, very frequently, to the wall of a house, under the eaves or in the upper angle of a window. Two or even three broods are produced in a season, and the old birds return year after year to nest in the same spot. House-martins congregate in great numbers, as the chimney-swallows do, before their autumn migration, and disappear all at once. The only other common British species of swallow is the Sand-martin (*H. riparia*), smaller than the two preceding and arriving before them. It has the toes naked, the tail moderately forked, the plumage brown on the upper parts and across the breast, the under parts white. It makes its nest in sandy river-banks, the sides of sand-pits, and other such situations (even the turf-covered roofs of peasants' houses in Norway), excavating a gallery of 18 inches or 2 feet, sometimes 3 or even 5 feet in length, and more or less tortuous, in the



Fig. 2.—Sand-martin (*Hirundo riparia*).

slightly dilated extremity of which some soft material is placed for the reception of the eggs. This wonderful excavation is accomplished entirely by the bill of the bird. The floor slopes a little upwards from the entrance, so that the lodgment of rain is prevented. The sand-martin, on account of the nature of its haunts, is somewhat more local than the other British swallows; but it is distributed over most parts of Europe, Asia, Africa, North America, and South America to the Amazon valley. The Purple Swallow, or Purple Martin (*H. or Progne purpurea*), is a North American species, which is said to have visited the British islands. The general colour, both of the upper and under parts, is shining purplish blue; the wings and tail black. It abounds in North America, and is a universal favourite in the northern parts, being hailed as the harbinger of spring, and frequenting even the streets of towns. It is a very general practice to place boxes near houses for the martins to make their nests in, which are very inartificial, consisting merely of dried grass, leaves, moss, feathers, and the like. Boxes nailed to trees are also readily occupied by the Rufous-bellied Swallow (*H. erythro-gaster*), another North American species. But this species, which very nearly resembles the chimney-swallow of Britain, makes a nest of mud and fine hay, in the form of the half of an inverted cone, with an extension at the top, for one of the parent birds to sit in occasionally. The Republican

Swallow, or Cliff-swallow (*Petrochelidon lunifrons*), of North America, makes a nest of mud, in form somewhat like a Florence flask, which it attaches to a rock or to the wall of a house. Hundreds sometimes build their nests in close proximity. The Fairy-martin (*H. ariel*), a small Australian species, also builds a flask-shaped nest with the mouth below, attaching it to a rock, or to the wall of a house; and numerous nests are often built close together. Another Australian species (*Pterochelidon nigricans*) lays its eggs in a hollow tree or rock without any nesting material. Some of the swallows of tropical countries are much smaller than any of the European species. See SWIFT.

Swallowing. See DIGESTION, CHOKING.

Swallow-wort. See ASCLEPIAS.

Swammerdam, JAN, entomologist and anatomist, born at Amsterdam, 12th February 1637, showed almost from his boyhood the greatest zeal in the study of natural history. Choosing medicine for his profession, he was trained at Leyden, and settled down to practise in Amsterdam. But he gave far more time and attention to investigating the life-history and anatomical structures of insects than to his calling, became straitened for means, and finally was carried away by the religious mysticism of Antoinette Bourignon (q.v.). He died at Amsterdam on 17th February 1680. His chief services in the advancement of science were the application of a method of studying the circulatory system by injections of hot wax, demonstrations in the anatomy of bees and other insects, and investigations into the metamorphoses of insects, the results of which afforded sure groundwork for subsequent classification. His most important books were *General Treatise on Bloodless Animals* (in Dutch, Utrecht, 1669) and *Biblia Naturæ* (ed. Boerhaave, 1737-38), giving the results of his researches in insect anatomy.

Swan (*Cygnus*), a genus of birds constituting a very distinct section of the Duck (q.v.) family Anatidæ. They have a bill about as long as the head, of equal breadth throughout, higher than wide at the base, with a soft cere, the nostrils placed about the middle; the neck longer than the body, arched, and with twenty-three vertebrae; the legs short and placed far back; the front toes fully webbed, the hind toe without membrane; the keel of the breast-bone very large; the intestines very long, and with very long caeca. They feed chiefly on vegetable substances, as the seeds and roots of aquatic plants, but also on fish spawn, of which they are great destroyers. They are the largest of the Anatidæ. They have a hissing note like geese, which they emit when offended, and they deal tremendous blows with their wings in attack or defence. The Common Swan, Mute Swan, or Tame Swan (*C. alor*) is about 5 feet in entire length, and weighs about 30 lb. It is known to live for at least fifty years. The male is larger than the female. The adults of both sexes are pure white, with a reddish bill; the young (cygnets) have a dark bluish-gray plumage and lead-coloured bill. The bill is surmounted by a black knob at the base of the upper mandible, and has a black nail at its tip. In its wild state this species is found in the eastern parts of Europe and in Asia as far as Mongolia and the north-west of India, breeding in Denmark, the south of Sweden, in central and southern Russia, and in Turkestan; in a half domesticated state it has long been a common ornament of ponds, lakes, and rivers in all parts of Europe. It is said to have been brought to England from Cyprus by Richard I. It is perhaps the most beautiful of water-birds, when seen swimming, with wings partially elevated, as if to catch the wind, and finely-curving neck. The ancients called the

swan the Bird of Apollo or of Orpheus, and ascribed to it remarkable musical powers, which it was supposed to exercise particularly when its death approached. The note of the male bird at breeding time is loud and trumpet-like; the tame bird's note is little more than a hiss. The nest of the swan is a large mass of reeds and rushes, near the edge of the water, an islet being generally preferred. The female begins as a rule to lay in her second year from three to five eggs; when older she lays ten to twelve eggs, of a dull greenish-white colour. These birds are said to pair for life. The female swan sometimes swims about with the unfledged young on her back; and the young continue with their parents till the next spring. The swan is now seldom used in Britain as an article of food, but in former times it was served up at every great feast, and old books are very particular in directions how to roast it and to prepare proper gravy. The Polish Swan (*C. immutabilis* of Yarrell) is generally believed now to be a mere variety of the common swan. The Whistling Swan, Elk Swan, or Whooper (*C. ferus* or *musicus*) abounds

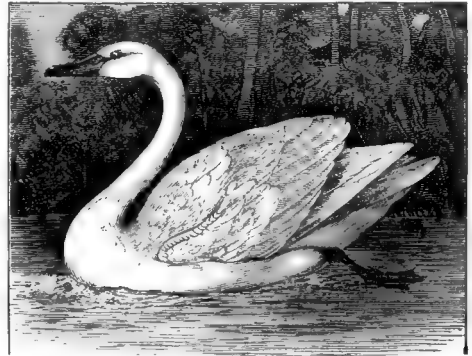

Fig. 1.—Wild Swan, or Whooper (*Cygnus ferus*).

in the northern parts of Europe and Asia, but to Britain it is now merely a cold-season migrant from more northern regions, although about a century ago it used to breed in the Orkneys. The size is about equal to that of the common swan, and the colour is similar, but the bill is more slender, is destitute of a knob, and is depressed and black at the tip and yellow at the base. This bird is frequently brought to the London market. The names whooper and whistling swan are derived from the voice. Like all swans of the northern hemisphere, except the common swan, this one has a large cavity in the interior of the breast-bone in which the windpipe coils before passing to the lungs. Bewick's Swan (*C. bewicki*), another native of northern Europe, is more rare in Britain, but large flocks are sometimes seen. It is about one-third smaller than the whistling swan. The American Swan (*C. americanus*), closely resembling Bewick's swan but larger, is sometimes found in Britain. It breeds in the northern parts of North America, but its winter migrations extend only to North Carolina. The Trumpeter Swan (*C. buccinator*) is another American species, breeding chiefly within the Arctic Circle, but of which large flocks may be seen in winter as far south as Texas. It is rather smaller than the common swan. The ancients spoke of a black swan proverbially as a thing of which the existence was not to be supposed, but Australia produces a Black Swan (*C. atratus*), discovered towards the end of the 18th century, rather smaller than the common swan, the plumage deep black, except the primaries of the wings, which are white. The neck is long, thin, and

gracefully curved. The eye is red. The bill is vivid carmine, with a white cross band. It has been entirely acclimatised in the northern hemisphere. The black-necked Swan (*C. nigricollis*), perhaps the handsomest bird of the genus, is a



Fig. 2.—Black Swan (*Cygnus atratus*).

South American species, ranging from Chili to the Falkland Islands. The Duck-billed Swan (*C. anatoides*), the smallest of all the species, common about the Strait of Magellan, has the head and neck dark brown, and the rest of the plumage of the purest white. It is curious that the black colour appears in all the species of the southern hemisphere, and in them alone, except in the approach to it made in the cygnets of the north.

Swans, according to the law of England, are birds-royal. When they are found in a partially wild state, on the sea and navigable rivers, they are presumed to belong to the crown. The royal birds generally have a 'nick' or mark on them, and the king's swanherd once was an important person. But any person may have tame swans in his grounds, and then he has a property in them. Whoever steals or destroys swans' eggs forfeits 5s. for every egg, and whoever steals a marked swan of the crown, or a tame swan, commits felony. The most famous swannery is that of Abbotsbury in Dorsetshire, 8 miles NW. of Weymouth, though the number of its swans has diminished from 7000 to 1000.

Swan, ANNIE S. (MRS BURNETT SMITH), daughter of a farmer at Gorebridge near Edinburgh, has been a prolific writer of tales and magazine stories, and edits *The Woman at Home*. Among her books may be mentioned *Ups and Downs* (1878), *Aldersyde, Carlourie, Gates of Eden, Maitland of Lauriston, A Lost Ideal, A Divided House, Elizabeth Glen, The Curse of Cowden, The Ne'er-do-Weel* (1897), *Not Yet* (1898).

Swan, JOSEPH WILSON, F.R.S., was born in Sunderland, 31st October 1828. Best known as the inventor of the incandescent electric lamp bearing his name, he was also an influential worker in photography. The carbon or autotype process, the

dry-plate process, the Woodbury type process (with Mr Woodbury), and other photographic methods owe much to his inventive genius. He also devised a miner's electric safety-lamp. He was president of the Institution of Electrical Engineers 1898-99.

Swanage, a pleasant little watering-place of Dorsetshire, in the 'Isle' of Purbeck, nestling in the southern curve of a lovely bay, 9½ miles S.E. of Wareham, but 11 by rail (1885). In Swanage Bay, in 877, King Alfred won England's first naval victory—a defeat of the Danes. Pop. of parish, 2674. See **PURBECK**, and *Braye's Swanage* (1890).

Swanice River. See **SUWANEE**.

Swanetia. See **CAUCASUS**.

Swan River. See **WESTERN AUSTRALIA**.

Swansea (Welsh *Abertawe*), a seaport of Glamorganshire, South Wales, on the banks and at the mouth of the river Tawe, 45 miles WNW. of Cardiff and 216 W. of London. A municipal, parliamentary, and also (since 1888) county borough, it owes its rapid progress after 1850 to the manufacture of tin-plate here and in the neighbourhood, and to its harbour and docks (of over sixty acres). Owing to the abundance of fuel from the coal-pits in the district, there is a large manufacture of iron, zinc, lead, copper, tin, &c. The tin-plate prepared in and near Swansea is estimated at about two-thirds of the total product of Great Britain. Much copper is made, mostly from foreign ore. In 1897 the total number of steam and sailing ships cleared from the port was 5756, with a tonnage of 1,552,609. In 1890 the total exports were valued at £4,953,635, while in 1897 the total value was £3,394,384, the difference being chiefly due to the reduction—mainly owing to the McKinley tariff in the United States—in the export of iron manufactures (including tin-plate), 203,638 tons in 1890, 174,766 tons in 1897; cotton manufactures, 1,936,400 yards in 1890, 64,700 yards in 1897; copper and its manufactures, 278,028 cwt. in 1890, 150,000 cwt. in 1897. The other principal exports are coals and fuel and chemical manufactures. In 1897 the total imports were valued at £2,835,245, including corn, copper ore, iron ore, petroleum, sugar, potatoes, onions (26,790 bushels), and wood. Pop. of municipal borough (1851) 31,461; (1881) 65,597; (1891) 90,349. Since 1885 Swansea returns two members to parliament, one for the district division (Aberavon, Kenfig, Loughor, and Neath). The charter dates from the days of John and Henry III. The castle, of which a tower still remains, was founded in 1099 by the Earl of Warwick, but in the reign of Edward IV. passed by marriage from the Herberts to the Somerset family, and is still the property of the Dukes of Beaufort. The Royal Institute of South Wales contains a library, art gallery, and museum with an Egyptian collection. Swansea has also a Free Library and Institute of Science and Art. The grammar-school dates from 1682.

See works by L. W. Dillwyn (1848), G. G. Francis (1849-67), P. Rogers (1878), L. C. Martin (1879), and F. Grant (1881), and the articles **COPPER** and **TIN**.

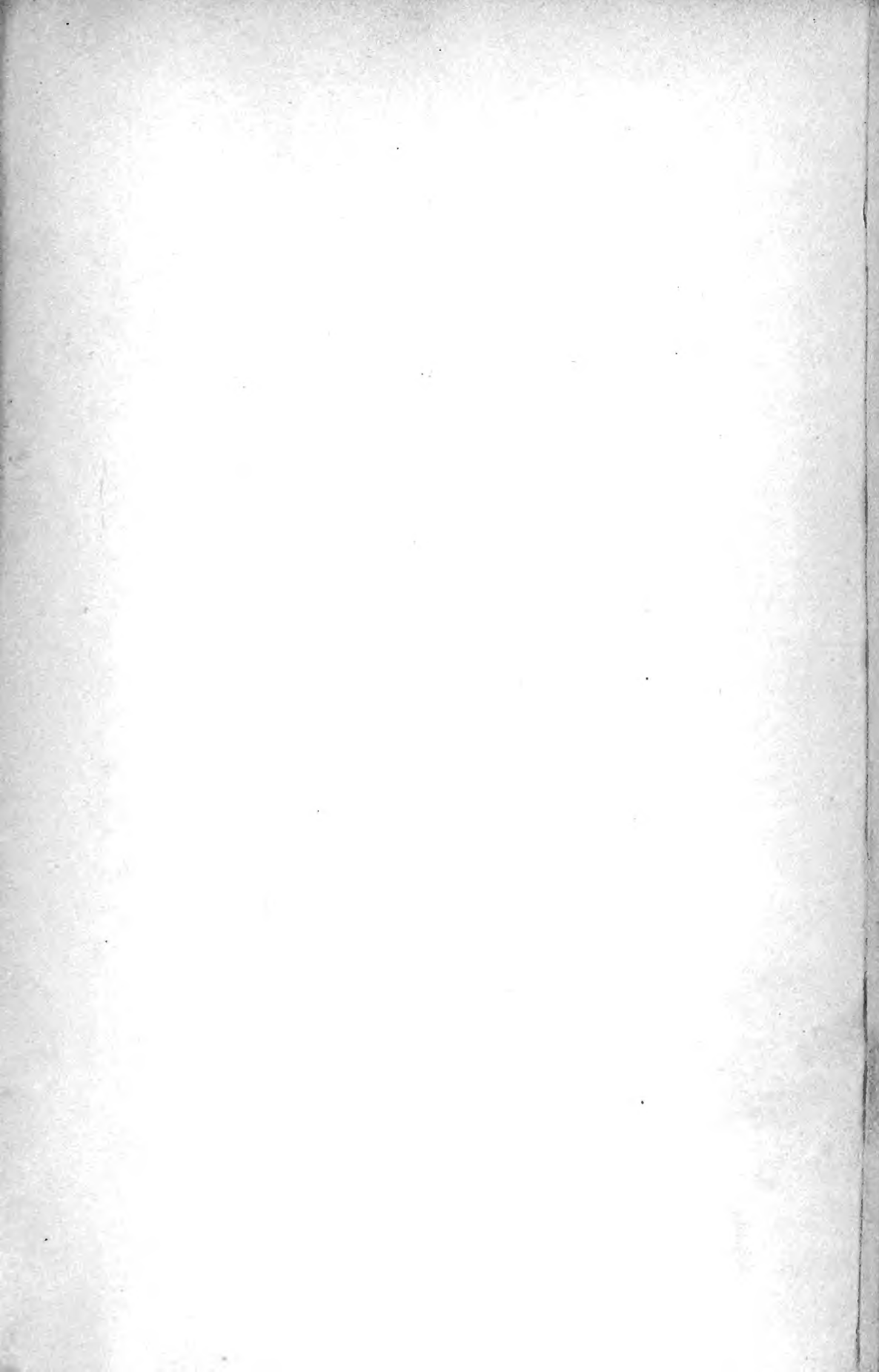



54406

Chambers's encyclopaedia. New ed.
Vol. 9

S.D
C4457

University of Toronto
Library

—
**DO NOT
REMOVE
THE
CARD
FROM
THIS
POCKET**



