

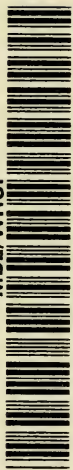

MBL/WHOI



0 0301 0021019 1

DRUG RESISTANCE IN
MICRO-ORGANISMS
Mechanisms of Development

Ciba Foundation Symposia

General Volumes:

Visceral Circulation	-	-	-	-	-
Mammalian Germ Cells	-	-	-	-	-
Preservation and Transplantation of Normal Tissues	-	-	-	-	-
Leukæmia Research	-	-	-	-	-
Chemistry and Biology of Pteridines	-	-	-	-	-
Porphyrin Biosynthesis and Metabolism	-	-	-	-	-
Histamine	-	-	-	-	-
Extrasensory Perception	-	-	-	-	-
Bone Structure and Metabolism	-	-	-	-	-
Paper Electrophoresis	-	-	-	-	-
Ionizing Radiations and Cell Metabolism	-	-	-	-	-
The Nature of Viruses	-	-	-	-	-
Chemistry and Biology of Purines	-	-	-	-	-

A leaflet giving fuller details of these volumes, also of the Ciba Foundation Colloquia on Endocrinology and Colloquia on Ageing, is available from the Publishers.

C.I.F.

CIBA FOUNDATION SYMPOSIUM
ON
**DRUG RESISTANCE IN
MICRO-ORGANISMS**
Mechanisms of Development

Editors for the Ciba Foundation

G. E. W. WOLSTENHOLME, O.B.E., M.A., M.B., B.Ch.

and

CECILIA M. O'CONNOR, B.Sc.

With 62 Illustrations



LITTLE, BROWN AND COMPANY
BOSTON

THE CIBA FOUNDATION

for the Promotion of International Co-operation in Medical and Chemical Research

41 PORTLAND PLACE, LONDON, W.1.

Trustees:

THE RIGHT HON. LORD ADRIAN, O.M., F.R.S.

THE RIGHT HON. LORD BEVERIDGE, K.C.B., F.B.A.

SIR RUSSELL BRAIN, Bt.

THE HON. SIR GEORGE LLOYD-JACOB

SIR RAYMOND NEEDHAM, Q.C.

Director, and Secretary to the Executive Council:

DR. G. E. W. WOLSTENHOLME, O.B.E.

Assistant to the Director:

DR. H. N. H. GENESE

Assistant Secretary:

MISS N. BLAND

Librarian:

MISS JOAN ETHERINGTON

Editorial Assistants:

MISS CECILIA M. O'CONNOR, B.Sc.

MISS MAEVE O'CONNOR, B.A.

ALL RIGHTS RESERVED

*This book may not be reproduced by
any means, in whole or in part, with-
out the permission of the Publishers*

*Published in London by
J. & A. Churchill Ltd.
104 Gloucester Place, W.1*

First Published 1957

Printed in Great Britain

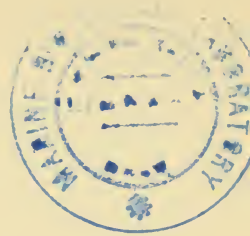

PREFACE

It was Sir Charles Harington, Director of the National Institute for Medical Research, and also Chairman of the Medical Research Council's Committee on Chemotherapy, who put forward to the Director of the Ciba Foundation the proposal of a symposium on drug resistance. It was his belief that the more fundamental problems at the basis of chemotherapy were not attracting as much attention in research as was desirable, and his hope that out of a thorough discussion of the question some suggestions might come which would stimulate fresh investigations, more particularly perhaps on the part of chemists.

The Director of the Foundation thought it would be most profitable, and more in keeping with the facilities of the Foundation, if the subject to be considered were narrowed down to "Mechanisms of Development of Drug Resistance in Micro-Organisms." With the expert advice and ready assistance of Sir Charles, and also of Dr. M. R. Pollock, such a meeting was realized in March 1957, Sir Charles himself acting as its Chairman. The Trustees and the Director of the Foundation remain much indebted to both of them, and to the Members who contributed so freely and informatively in the papers and discussions.

The group was a small one, as usual at the Ciba Foundation, partly because the Foundation's accommodation is severely limited, but mainly because experience has shown that useful discussions can best be conducted when members can get to know each other quickly and well, and can be seated in a convenient and comfortable manner for conversation.

This record of the papers presented and the discussions they aroused is prepared for the many people who could not be invited on this occasion, and the Editors hope it will prove an acceptable substitute for personal participation.

To some readers this book may form an introduction to the work of the Ciba Foundation, and it may be helpful to add a few words about its interests.

Under its eminent Trustees, the Foundation is engaged in a number of activities with the purpose of improving co-operation in medical and chemical research between workers in different countries and different disciplines. At its house in London the Foundation provides accommodation for scientists, organizes conferences, conducts a medical post-graduate exchange scheme between Great Britain and France, arranges a variety of informal discussions, awards two annual lecture-ships, and is building up a library service in special fields. The Foundation assists international congresses and scientific institutions, and it is hoped that in its hospitality, its meetings, and in such a volume as this, it is also usefully helping the individual scientist.

CONTENTS

	PAGE
Chairman's opening remarks	
SIR CHARLES HARRINGTON	1
Aspects of the problem of drug resistance in bacteria	
<i>by</i> A. C. R. DEAN and SIR CYRIL HINSHELWOOD	4
<i>Discussion:</i> DEAN, EAGLE, HINSHELWOOD, LEDERBERG, POLLOCK, PONTECORVO	24
Indirect selection and origin of resistance	
<i>by</i> L. L. CAVALLI-SFORZA	30
<i>Discussion:</i> CAVALLI-SFORZA, DAVIS, DEAN, GYÖRFFY, HINSHELWOOD, HOTCHKISS, KUNICKI-GOLDFINGER, LEDERBERG, PONTECORVO, YUDKIN	40
Genetic aspects of drug resistance	
<i>by</i> M. DEMEREC	47
<i>Discussion:</i> ALEXANDER, DAVIS, DEMEREC, HINSHELWOOD, HOTCHKISS, LEDERBERG, POLLOCK, PONTECORVO, SLONIMSKI, WALKER, YUDKIN	58
Inheritance in single bacterial cells	
<i>by</i> W. HOWARD HUGHES	64
<i>Discussion:</i> CAVALLI-SFORZA, DAVIS, DEMEREC, EAGLE, HAYES, HUGHES, IERUSALIMSKY, LEDERBERG, PONTECORVO, STOCKER, YUDKIN	71
Penicillin-induced resistance to penicillin in cultures of <i>Bacillus cereus</i>	
<i>by</i> M. R. POLLOCK	78
<i>Discussion:</i> ALEXANDER, BARBER, DAVIS, HAYES, HOTCHKISS, KNOX, LEDERBERG, POLLOCK, PONTECORVO, SLONIMSKI, STOCKER	96
Directed hereditary changes of fermentative properties of yeast by a specific substrate	
<i>by</i> K. V. KOSSIKOV	102
<i>Discussion:</i> HARRINGTON, IERUSALIMSKY	136

	PAGE
Multiple mechanisms of acquired drug resistance	
<i>by</i> MARGARET J. THORNLEY, JEHUDITH SINAI and JOHN YUDKIN	141
<i>Discussion:</i> DAVIS, DEAN, FREDERICQ, FULTON, HOTCHKISS, HUGHES, POLLOCK, ROSE, SLONIMSKI, WALKER, YUDKIN	161
Physiological (phenotypic) mechanisms responsible for drug resistance	
<i>by</i> B. D. DAVIS	165
<i>Discussion:</i> DAVIS, EAGLE, KNOX, POLLOCK, PONTECORVO	180
Genetic and metabolic mechanisms underlying multiple levels of sulphonamide resistance in pneumococci	
<i>by</i> ROLLIN D. HOTCHKISS and AUDREY H. EVANS	183
<i>Discussion:</i> CAVALLI-SFORZA, DAVIS, DEMEREC, HOTCHKISS, LEDERBERG, PONTECORVO, STOCKER	193
The phenotypic expression of genes determining various types of drug resistance following their inheritance by sensitive bacteria	
<i>by</i> W. HAYES	197
<i>Discussion:</i> BARBER, CAVALLI-SFORZA, DAVIS, FREDERICQ, HAYES, HOTCHKISS, LEDERBERG, POLLOCK, PONTECORVO, STOCKER	205
Specific polyhydroxy compounds as cofactors of enzymic adaptation and its inheritance	
<i>by</i> P. P. SLONIMSKI and H. DE ROBICHON-SZULMAJSTER	210
<i>Discussion:</i> DAVIS, FULTON, POLLOCK, SLONIMSKI, WESTERGAARD	230
Development of resistance to streptomycin in <i>Serratia marcescens</i>	
<i>by</i> B. GYÖRFFY and I. KÁLLAY	233
<i>Discussion:</i> CAVALLI-SFORZA, DAVIS, DEAN, EAGLE, FULTON, GYÖRFFY, HAYES, HOTCHKISS, KNOX, LEDERBERG, STOCKER, YUDKIN	237
Distribution of drug-resistant individuals in cultures of <i>Mycobacterium tuberculosis</i>	
<i>by</i> R. KNOX	241
<i>Discussion:</i> DAVIS, DEAN, EAGLE, HAYES, KNOX, LEDERBERG, POLLOCK, PONTECORVO, STOCKER, WESTERGAARD	246

	PAGE
Physiological adaptation of bacteria to antibiotics	
<i>by</i> W. KUNICKI-GOLDFINGER	251
<i>Discussion:</i> ALEXANDER, DAVIS, GYÖRFFY, KNOX, KUNICKI-GOLDFINGER, LEDERBERG, SLONIMSKI, STOCKER, YUDKIN .	259
Drug resistance of staphylococci with special reference to penicillinase production	
<i>by</i> MARY BARBER	262
<i>Discussion:</i> BARBER, BISHOP, CAVALLI-SFORZA, DAVIS, EAGLE, HAYES, HUGHES, KNOX, LEDERBERG, POLLOCK, PONTECORVO, WESTERGAARD	274
On the identification of genetic and non-genetic variation in bacteria	
<i>by</i> M. WESTERGAARD	280
<i>Discussion:</i> ALEXANDER, DAVIS, DEMEREC, HAYES, HUGHES, KNOX, LEDERBERG, PONTECORVO, ROSE, WESTERGAARD .	290
The reactions of the mutagenic alkylating agents with proteins and nucleic acids	
<i>by</i> P. ALEXANDER, SHEILA F. COUSENS and K. A. STACEY	294
<i>Discussion:</i> ALEXANDER, DAVIS, HAYES, LEDERBERG, PONTECORVO, ROSE, WALKER, WESTERGAARD	318
Genetics of two different mechanisms of resistance to colicins: resistance by loss of specific receptors and immunity by transfer of colicinogenic factors	
<i>by</i> P. FREDERICQ	323
<i>Discussion:</i> CAVALLI-SFORZA, FREDERICQ, HAYES, LEDERBERG, POLLOCK, PONTECORVO, STOCKER	335
<i>General Discussion:</i> DAVIS, DEAN, HAYES, HOTCHKISS, LEDERBERG, POLLOCK, SLONIMSKI	339
Chairman's closing remarks	
SIR CHARLES HARRINGTON	344



List of those participating in or attending the Symposium on
Drug Resistance in Micro-Organisms
26th-28th March, 1957

P. ALEXANDER . . .	Chester Beatty Research Inst., London
MARY BARBER . . .	Dept. of Bacteriology, St. Thomas's Hospital Medical School, London
ANN BISHOP . . .	Molteno Inst. of Biology and Parasitology, University of Cambridge
L. L. CAVALLI-SFORZA . . .	Istituto Sieroterapico Milanese, Milan
B. D. DAVIS . . .	Dept. of Bacteriology and Immunology, Harvard Medical School, Boston
A. C. R. DEAN . . .	Physical Chemistry Laboratory, Oxford
M. DEMEREC . . .	Dept. of Genetics, Carnegie Inst. of Washing- ton, Cold Spring Harbor, Long Island, New York
H. EAGLE . . .	Dept. of Experimental Therapeutics, National Inst. of Allergy and Infectious Diseases, Bethesda, Maryland
P. FREDERICQ . . .	Dept. of Microbiology and Hygiene, University of Liège
J. D. FULTON . . .	National Inst. for Medical Research, Mill Hill, London
B. GYÖRFFY . . .	Inst. of Genetics, Hungarian Academy of Sciences, Budapest
SIR CHARLES HARRINGTON . . .	National Inst. for Medical Research, Mill Hill, London
P. HARTMAN . . .	Dept. of Bacteriology and Immunology, Harvard Medical School, Boston; and Faculté des Sciences, Brussels
W. HAYES . . .	Dept. of Bacteriology, Postgraduate Medical School, London
SIR CYRIL HINSHELWOOD . . .	Physical Chemistry Laboratory, Oxford
R. D. HOTCHKISS . . .	Rockefeller Inst. for Medical Research, New York
W. HOWARD HUGHES . . .	Wright-Fleming Inst. for Microbiology, St. Mary's Hospital Medical School, London
N. D. IERUSALIMSKI . . .	Inst. of Genetics, Academy of Sciences of the U.S.S.R., Moscow
R. KNOX . . .	Dept. of Bacteriology, Guy's Hospital Medical School, London
K. V. KOSSIKOV . . .	Inst. of Genetics, Academy of Sciences of the U.S.S.R., Moscow

LIST OF PARTICIPANTS

- W. KUNICKI-GOLDFINGER . . . Dept. of Microbiology, The University,
Warsaw
- J. LEDERBERG . . . The Medical School, Dept. of Medical Genetics,
University of Wisconsin
- ESTHER M. LEDERBERG . . . The Medical School, Dept. of Medical Genetics,
University of Wisconsin
- M. R. POLLOCK . . . National Inst. for Medical Research, Mill Hill,
London
- G. PONTECORVO . . . Dept. of Genetics, The University, Glasgow
- F. L. ROSE . . . Research Dept. Chemical Group, Pharma-
ceuticals Division, Imperial Chemical
Industries Ltd., Manchester
- P. SLONIMSKI . . . Laboratoire de Génétique Physiologique du
C.N.R.S., Université de Paris
- B. A. D. STOCKER . . . Lister Inst. of Preventive Medicine, London
- J. WALKER . . . National Inst. for Medical Research, Mill Hill,
London
- M. WESTERGAARD . . . Dept. of Genetics, The University, Copen-
hagen
- J. YUDKIN . . . Dept. of Nutrition, Queen Elizabeth College,
University of London



OPENING REMARKS

SIR CHARLES HARRINGTON

IN spite of the great advances that have been made in recent years in the chemotherapeutic treatment of infectious diseases—advances that have brought under some measure of control the majority of protozoal and bacterial infections and some helminthic infections—the subject of chemotherapy remains distressingly empirical. The relationship between chemical structure and biological action in this field is still so ill-defined that we have only one significant guiding principle, based on biological theory, to help us in the search for new synthetic drugs for specific chemotherapeutic purposes. As for antibiotics the attempt to discover new substances of therapeutic value is admittedly based on no scientific principle at all, but is an operation such as oil prospecting would be with no adequate background of geological information.

Even when a new synthetic drug is discovered that proves to be of value in the treatment of a particular infection, it is usually impossible to explain the nature of the action of the drug; indeed the type of activity found is not infrequently quite different from that which is being sought, as is shown for instance by the discovery of a valuable antimalarial, pyrimethamine, in the course of a search for folic acid antagonists. Sometimes the drug proves not to have a direct action on the infecting organism at all, although it can suppress or cure the disease which the micro-organism causes; thus the anti-malarial drug proguanil has no direct lethal effect on plasmodia, but it is metabolized in the body of the host to a substance that has such an effect. Again hetrazan, which is the most effective remedy so far known for filariasis, does not kill the microfilariae directly but so alters them that they become susceptible to attack by the natural defence mechanisms of the host. The most striking example of such indirect chemotherapeutic action is afforded by the high-molecular surface-active

compounds that are curative of experimental tuberculosis and leprosy; in this instance there is clear evidence that the drugs, which are quite innocuous to the infecting organisms, confer on the monocytes of the host the power of inhibiting the growth of these organisms, thus exercising their effect by reinforcing the natural defence mechanisms of the host. The discovery of these drugs again was a totally unexpected outcome of the line of research that was being pursued.

All this means that the life of a chemist working in chemotherapy is apt to consist of long periods of unexciting work, punctuated if he is fortunate by occasional successes; even these successes however, whilst practically satisfying, may well be intellectually disappointing, since they will very likely bear little or no relation to the thought that he has put into his research.

By emphasizing as I have done the uncertainties and lack of fundamental knowledge that bedevil chemotherapy I must appear to have painted a very gloomy picture of the subject. If this is so, it is certainly not because I wish to say anything in disparagement of its importance. On the contrary, my object is to analyse the difficulties that we face, and which are particularly discouraging to chemists, in the attempt to see how they may be overcome.

It might be argued that in spite of all that I have said the situation is not unsatisfactory. New and effective chemotherapeutic agents continue to be discovered and the range of diseases brought under control increases. But so long as we cannot explain the reason for our successes we must remain scientifically dissatisfied, and there is one biological phenomenon, namely drug resistance, which makes the situation much less favourable than it appears even from a strictly utilitarian point of view. We can hardly be easy about a state of affairs in which it is reported that in many hospitals over 50 per cent of the strains of staphylococci causing infections have become resistant to penicillin, even though we now have other antibiotics with which they can be controlled; nor is the encouraging emptying of our tuberculosis sanatoria cause

for complacency, when we reflect that this would not be occurring had not the discovery of streptomycin been opportunely followed by those of the antituberculous effects of *p*-aminosalicylic acid and isoniazid. We cannot be sure that the searchers for new drugs and antibiotics will always win the race.

However hard and successfully we may work in the search for new drugs we shall therefore continue to labour under discouragement so long as we are faced with the bugbear of drug resistance. The problem is one of microbial biochemistry, physiology and genetics, and can only be solved by work in these fields. Until we understand the problem we shall have no hope of overcoming it, and until we overcome it we shall have no real sense of security in our chemotherapy. The subject of this symposium therefore is not only of the greatest scientific interest and importance; it has also a background of practical medical urgency, and I think we should do well to keep this thought in our minds.

There are, I am sure, plenty of chemists who would be eager to devote their abilities to research in chemotherapy if they could see it as a less empirical subject than it still is. This is obvious indeed from the mass of work that has resulted from the Woods-Fildes hypothesis of metabolic interference, a theory which, born by biochemistry out of microbiology, has been the most encouraging lead that the chemists have yet received from the biologist; it has systematized thought in the search for new drugs, and if its practical yield, apart from the folic acid antagonists, has so far been small, this is in my view because full fructification of the idea cannot be expected until microbiology is further advanced.

Now a further lead is needed, which can only come from the biochemists and the microbiologists. The greatest encouragement to chemical research would be the achievement of clearer insight into the development of drug resistance together with even a glimmering of an indication that this phenomenon may ultimately be subject to control. If our discussions bring nearer the day when a confident lead in this direction can be given our time will not have been wasted.

ASPECTS OF THE PROBLEM OF DRUG RESISTANCE IN BACTERIA

A. C. R. DEAN AND SIR CYRIL HINSHELWOOD

Physical Chemistry Laboratory, Oxford

General Observations

IN presenting this brief review of our present ideas on the subject of drug resistance it may be well to begin by mentioning views which have at one time or another been attributed to us, but which we have never held and of which no expression could be quoted from any of our publications.

We have never doubted that the essential characters of a cell are inherent in the structure of certain fundamental units including (though not necessarily exclusively) the deoxyribonucleic acid (DNA). We do not suppose these basic structures to be easily susceptible to change, and indeed in our experience easily provoked changes are normally destructive. The maintenance of species characters is of course a matter of the copying of the genetic patterns, and if and when these have been changed the heredity will be changed. We have never denied that structural mutations leading to increased drug resistance or improved utilization of nutrient sources can and do occur, or the obvious consequence that the mutants so arising would be rapidly selected in the appropriate environment.

On the other hand, we have contested the assumption that random mutation and selection is the sole mechanism (or perhaps even the major mechanism) for adaptation to new media or for the development of drug resistance. We have proposed more direct mechanisms, and quoted what appears to us to be good experimental evidence that in various specific examples these mechanisms operate.

Before outlining the proposed mechanisms and summarizing this evidence another point should be made clear. The primary concern of the work has been to explore the problem of the way in which cell reactions are co-ordinated, and the manner in which adjustments in the cell economy can take place, not to assert the relative importance of this or that evolutionary mechanism. A sound judgement on this latter question will probably be reached only when the number of examples studied is considerably greater than it is at present.

In quoting the kinds of evidence on which our current views are based we shall group together examples of adaptation to drugs and certain examples of adaptation to new substrates. The mechanisms will be often, though not always, the same. The addition of a drug to the medium often impedes certain essential enzyme reactions and so imposes a new reaction pattern on the cell. This is not unlike what happens when an unfamiliar substrate has to be used. On the other hand, drug resistance could arise, as in some cases phage resistance seems to, by a mutation leading to a deficiency whereby receptors for the drug in the cell are extirpated. In such a case the analogy with enzymic adaptation would be absent.

In its essentials the mechanism of adaptive change which we believe to operate in certain examples is the following. Although the major characters are determined by the basic gene structures, their quantitative expression is a function not merely of what structures are present but of the proportions in which they occur in the cell. When the medium is changed so that some parts of the reaction sequence are impeded relatively to others, corresponding changes in the relative proportions of the major cell constituents must occur. If division is governed even approximately by the attainment of a threshold amount of some key substance (and DNA seems to be roughly an invariant in this respect), then it is easily shown that the cell composition adjusts itself automatically to give an optimum growth rate.

The details need not be repeated here, but a very crude analogy may be cited in illustration. Suppose we have a tank with an inflow and an outflow of water. A certain level is established. If now the outflow is restricted the head of water rises until eventually outflow equals inflow once more. The kinetic theory of the automatic adjustments in cells is less crude than this analogy but still, no doubt, far cruder than reality. Nevertheless, it is very general, and one point which is worth emphasizing is that if certain quite general and extremely likely conditions are fulfilled the development of drug resistance becomes a predictable phenomenon. If the mechanism just mentioned does not operate in nature there should be a positive explanation of why it does not.

In principle, such adjustments are reversible when the original conditions are restored, and a major clash of opinion has occurred in this connexion. Drug resistance and properties such as ready utilization of substrates are often rather persistent, and are often cited as manifestations of "stable heredity". We differ from this view in two ways. In the first place, we believe these phenomena in fact to be essentially reversible, on experimental grounds which will be summarized later. The reversion can be slow, for reasons not wholly unlike those which account for the delay of many other chemical transformations. In the second place, we consider that the term "heredity" is a rather ambiguous one to use of organisms which multiply by binary fission. With such organisms new individuals do not develop from special cells which are a minute fraction only of the total somatic make-up of the progenitors. When the two new cells are formed by division there is no question of parent and offspring. Each is roughly half of the original cell and retains its cytoplasmic make-up. If there is an inertial lag to adjustments in this (and reasons can be imagined why there should be) the existing organization will persist. But the persistence might just as well be called the stability of the physiology of an individual as a hereditary quality.

In fact this stability is not absolute, and in some examples

it is very low. Since the phenomenon is neither one of completely stable changes, nor one to which the term hereditary has a clear meaning, we consider arguments invoking the name of Lamarek to be largely meaningless or irrelevant. The way is thus opened for the consideration on its merit of experimental evidence (which, it should be repeated, applies only to the particular examples with which it is found—except in so far as it illustrates what can happen as distinct from what must happen).

Some aspects of the mutation-adaptation controversy offer an interesting analogy with the history of the phlogiston theory in chemistry. This doctrine, it has been said, was never formally abandoned by its supporters. But under the pressure of facts they changed it, added to it, and buttressed it with auxiliary hypotheses until it became indistinguishable from its rival, except for some superfluous nomenclature which was presently forgotten.

Is something of the sort in process of happening with the uncompromising version of the mutation theory? At first mutations were catastrophic, one-step events, occurring in a purely random manner to an excessively minute proportion of the population, and essentially during the hazards of nuclear division. Gradually the lines of the picture have softened. Mutations may occur in the absence of nuclear division and may affect almost the whole population (Ryan, 1955; Szybalski, 1954–55); they may be induced by a drug to which the mutant subsequently shows resistance, a marked departure from randomness (Akiba, 1955; Szybalski, 1954–55); they are sufficiently dependent on cytoplasmic events to be associated with a considerable “phenotypic delay” (Newcombe, 1948, 1953); and as to their discreteness, so elaborate a polygenic system is frequently assumed that the results of recombination experiments become indistinguishable from those which would be given by quantitative cytoplasmic changes.

This last fact would be even more commonly realized but for the practice of creating an illusory impression of discreteness

in the phenomena by dividing continuous ranges of quantitative variation into two arbitrarily defined ranges such as "fast" and "slow" or + at 24 hours and - at 24 hours. Add to this the fact that the resulting changes are not nearly as stably heritable as is sometimes implied (Dean and Hinshelwood, 1954a), and the theory of rather sluggishly reversible cytoplasmic adaptations no longer looks quite so much like belonging to a different ideological world.

Stability and Reversibility

In our experience partial reversion often occurs rather quickly, slow subsequent reversion following an erratic course. Sometimes almost complete reversion occurs rather quickly, as with *Bacterium coli* trained to utilize D-arabinose (Cross and Hinshelwood, 1956), and with some yeast strains made drug-resistant (Wild and Hinshelwood, 1956). Sometimes reversion is hastened by growth in media to which fresh adaptation is needed, the disturbing effect of the new adjustment relieving the metastability of the old. For example, growth in the presence of phenols resulted in a loss of the adaptation of *Bacterium lactis aerogenes* (*Aerobacter aerogenes*) to proflavine (Davies, Hinshelwood and Pryce, 1945) and adaptation to proflavine of a sulphanilamide-trained strain of the same organism led to the loss of the sulphanilamide adaptation (James and Hinshelwood, 1947). With *Aerobacter aerogenes*, adaptation to D-arabinose is gradually removed in this way. That the phenomenon is not due to the re-selection of a few reverse mutants has been shown by the fact that deliberately added cells of the original untrained strain are in fact not preferentially supported by the media used (Cross and Hinshelwood, 1956; Baskett and Hinshelwood, 1951).

In general, the more thoroughly the training to drugs has been impressed on the bacterial cells the less readily is it lost. For example, cells which have just acquired the ability to grow in the presence of the drug readily lose it on subculture

in a drug-free medium. As training proceeds reversion takes place less readily until eventually the adaptation appears to be relatively stable. This pattern of behaviour is seen in the adaptation of *Aerobacter aerogenes* to proflavine (Davies, Hinshelwood and Pryce, 1944, 1945; Pryce and Hinshelwood, 1947), and to sulphanilamide (Davies and Hinshelwood, 1943). Reversion when it does take place need not be complete but a lower level of immunity, the "equilibrium state", may be reached and held for a considerable time.

The stability, however, is never absolute. For example, Dean and Hinshelwood (1954a) have trained *Aerobacter aerogenes* to moderately high concentrations of proflavine, propamidine and chloramphenicol and have subcultured these trained strains for a very long time (about 1,000 generations) in the drug medium. The adaptations, although of considerable stability, were eventually lost on long-continued subculture in a drug-free medium, thus emphasizing the fact that arguments from stable heredity cannot by themselves be used to disprove the theory of environmental response. Moreover, the entire pattern of events in these and in the earlier drug experiments was more easily explained by an adaptive hypothesis than by a theory involving mutations and reverse mutations.

Similar results have been obtained with *Aerobacter aerogenes* and acetate and with *Bact. coli mutabile* and lactose as sole carbon sources. In the latter example although it has been relatively easy to detrain the Lac⁺ strains partially (Dean and Hinshelwood, 1954c) complete reversion to the Lac⁻ state has proved more difficult. It has, however, been achieved in one or two cases (Dean and Hinshelwood, unpublished).

Mass-Number Relations

If the only cells to develop and multiply in a given medium are pre-existent mutants, the bulk of the population remaining inert, then there can be no increase in the mass of the culture as a whole without a corresponding increase in the number of cells. If the average size of a mutant is nearly equal to that

of a non-mutant (and it will never differ from it by more than a small factor) then an increase of mass of x per cent will only occur as a result of an increase in number of approximately the same amount.

The proportion of mutants initially present is usually assumed to be about 10^{-8} (to account for observed delays in growth), and the approximate doubling of the mass of each mutant, which would precede its division, would make an unobservably minute contribution to the change in the total mass of the culture.

If, on the other hand, most of the cells in the culture develop after a suitable lag period, there can be a substantial increase in mass before any detectable increase in number occurs. In the simplest case, where the lags are all equal and each cell doubles in size before dividing, there will be a 100 per cent increase in mass before the numbers increase. This limiting case would, however, not be observed since some of the cells divide before others have completed their lag.

Nevertheless, in several examples of adaptation to new carbohydrate sources increases in mass of about 40 per cent have been observed without any observable multiplication. Since no cell is likely to grow to much more than about double its original size, this result indicates that at least a considerable proportion of the population is concerned in the adaptive process (Baskett and Hinshelwood, 1951; Kilkenny and Hinshelwood, 1951; Mims and Hinshelwood, 1953).

Tests for the Presence of Mutant Forms in Massive Inocula

A mutation rate of about 1 in 10^8 is not infrequently assumed for bacteria. This would mean a very small probability of any mutants at all in an inoculum of 10^4 and near certainty of the presence of several in an inoculum of 10^9 . Frequently the plating of 10 to 100 cells on a medium to which adaptation is required leads to the formation of colonies in 100 per cent yield, but only after a long lag. In

such cases the further assumption is sometimes made that an initial proliferation of the inoculated cells occurs through the intervention of impurities in the plate-medium, and that during the process mutations occur so that each of the microcolonies formed in this preliminary growth contains at least one mutant. This mutant can then eventually multiply to give the final colony. Objections to the universal application of the underlying assumptions have already been mentioned. However, when they are accepted they are usually coupled with the analogous one that if a large enough inoculum is plated those few cells which form colonies not later than a given relatively short time, regarded as the normal development time, represent the mutants initially present.

To test the likelihood of this interpretation experiments have been made on the rate of development of colonies of *Bact. coli mutabile* on lactose-agar and of *Bact. lactis aerogenes* on D-arabinose-agar. Inocula were varied from 10 to 10^9 , and distributions of sizes and numbers of colonies at various times were recorded (Dean and Hinshelwood, 1956; McCarthy and Hinshelwood, 1957).

The conclusion reached was that in these examples the colonies which appeared the earliest need not be ascribed to any special mutant type but represented nothing more than the tail of the nearly Gaussian distribution which the development times (for a given colony size), or the sizes at a given time, were found to follow.

Time-Number Relations

When resistance can be developed by training, the assumption commonly made is that drug-resistant mutants are present in minute proportion in the culture before it has ever been exposed to the drug. Some cultures may, of course, be heterogeneous, containing cells with a higher natural resistance than others, and such cells would be enriched by selection. This, however, is quite a different proposition from the denial of direct adaptive processes as possible in themselves.

That in certain examples the resistant forms, which emerge from the process of "training" in the presence of the drug, are not present at all in the original culture is strongly supported by a study of the development as a function of time of colonies on drug plates. Suppose a given number of cells to be plated. Let α_∞ be the fraction which ever form colonies and α_t the fraction which has done so at time t . With a trained strain, α_∞ will approach unity, while with an untrained strain it may vary from near unity to a vanishingly small value according to the drug concentration. Even when α_∞ is very small countable numbers of colonies can nevertheless be obtained by the use of large enough inocula. If these inocula contain preformed resistant mutants similar to those in the trained strain, then α_t/α_∞ , no matter how small α_∞ may be, will be a function of time similar to that which would be found in experiments with the trained strain itself. In a number of examples tested, however, this consequence was not verified. The time required for a given fraction of the final number of colonies to appear was much longer for the untrained strain. Thus it would seem that the nature as well as the number of the resistant cells in the trained culture differs from that of anything present in the original culture (Dean and Hinshelwood, 1955).

The only way of reconciling these observations with the uncompromising mutation-selection theory is to postulate an almost continuous series of minute mutational steps, and to assume that the chance of a considerable number of successive mutations is negligible unless cells that have already taken a few of the steps are first selected and then given further opportunities for taking subsequent steps. But in some examples α_∞ may be not far short of unity (i.e., nearly all the population consists of mutants) and yet the time of colony formation is longer than for a trained strain. So it seems (a) that there would have to be a very high proportion of early step mutants and (b) that even these are not fully adapted at first. If (a) is true then the complete absence of the more profoundly mutated cells is strange, and if (b) has to be

assumed, the usefulness of the basic assumption about pre-existing mutants loses most of its point.

Adaptation of Bacterial Cultures during the Lag Phase in Media containing New Substrates or Antibacterial Agents

There is a long lag when cultures of *Bact. lactis aerogenes* are introduced for the first time into media containing D-arabinose as the sole carbon source. Baskett and Hinshelwood (1951) showed that if samples are withdrawn at intervals during this lag phase and are plated on D-arabinose agar the time taken by the colonies to reach the A⁺ size progressively diminishes as the time of sojourn in the liquid medium increases. Similar results have been reported for *Bact. coli mutabile* and lactose (Dean and Hinshelwood, 1954*b*). Since the majority of the cells in the culture took part in the adaptive response and since the response preceded the growth of the culture these results were interpreted as showing that the substrate induces the adaptation. An explanation based on the selection of spontaneously-arising pre-adapted cells is not compatible with the experimental findings.

More recently Dean (unpublished) has investigated this topic in greater detail. He used *Bact. coli mutabile* with lactose, *Escherichia coli* K12 with D-arabinose and with dulcitol and *Bact. lactis aerogenes* with D-arabinose. His experiments confirmed the earlier interpretation but in addition he found that the response of the cells to the environment was of three types. Usually there was a considerable increase in cell mass towards the end of the lag phase and this preceded any division. Less frequently, however, division preceded any swelling of the cells. The third type of behaviour was characterized by swelling and division taking place almost simultaneously.

The experiments in which the first two types of behaviour were observed showed the progressive reduction in plate lag reported earlier. Those in which the third type of behaviour

was in evidence also showed the reduction in lag but since the increase in mass and the onset of cell division took place almost at the same time as the plate lag began to fall it was not possible to draw any definite conclusions from them. Of a series of eighteen experiments nine were of the first two types and nine were of the third type.

A technique somewhat similar to that of Baskett has been used by Akiba (1955) and by Szybalski (1954-55). They have shown in certain cases that cells exposed to streptomycin were, at the end of a definite period, if they had survived at all, fully resistant to the drug. Akiba and Szybalski, however, used a medium lacking the materials essential for division while Baskett and Hinshelwood used a medium which would support growth and division.

Dean (unpublished) has carried out experiments of the Akiba-Szybalski type with *Bact. coli mutabile* and lactose and with *Bact. lactis aerogenes* and D-arabinose by omitting a nitrogen source from the medium. Out of four experiments two gave definite positive results as regards the plate lag whilst in the other two very little adaptation took place. In another experiment which involved *Bact. lactis aerogenes* and both D-arabinose and streptomycin, the plate lag on D-arabinose and D-arabinose-streptomycin agar dropped progressively in the usual manner while the survival on streptomycin plates containing either glucose or D-arabinose as sole carbon sources gradually increased to 100 per cent. In a final experiment involving *Bact. coli mutabile* and chloramphenicol the survival on chloramphenicol-agar gradually increased to 100 per cent.

Although this experiment was continued until the viable population had fallen from 10^7 /ml. to 400 cells/ml. there was no evidence of lysis, a fact which excludes the possibility of a multiplication of mutants on the débris from other cells.

Graded Response

Sometimes the degree of resistance of bacteria to a drug is continuously graded to conform to the exact concentration

at which "training" has been carried out. A good example of this type of behaviour is found with *Bact. lactis aerogenes* and proflavine and it is easily explained on an adaptive theory involving an automatic adjustment of the enzyme systems in the cells in response to the environment (Davies, Hinshelwood and Pryce, 1945; Dean, 1955). The alternative is to assume a complex polygenic system—a theory which encounters difficulties when the resistance of colonies picked from proflavine plates is re-tested. It is found that resistance or non-resistance on re-test depends on the buffering capacity of the agar medium in the primary plating. Since proflavine is antagonized by the acids produced by growing cells, a simple explanation of a non-genetic nature can be given. It is that on the lightly buffered plates cells which have just begun to adapt to proflavine will de-adapt when the acid antagonizes the drug and hence on re-test would be expected to be no more resistant than in the primary test. On the well buffered plates, however, the acids produced by the growing cells will not be present in sufficient amount to change the pH of the medium and hence no considerable antagonism of the drug or de-adaptation will take place (Dean and Hinshelwood, 1955).

Accelerated Adaptation to Drugs

It has been shown that if proflavine is added gradually to an actively growing culture of *Bact. lactis aerogenes* the cells can be rapidly adapted to grow in concentrations of drug which if added directly to the culture would cause long lags or even cessation of growth. Using this method Baskett (1952) was able to adapt cells of *Bact. lactis aerogenes* to 110 mg./l. of proflavine in 220 minutes, a time interval too short for an appreciable selection of pre-existing proflavine-resistant mutants in the culture.

Dean (unpublished) has carried out similar experiments with *Bact. lactis aerogenes* and proflavine and sodium azide. Any pH changes in the medium were carefully followed since both proflavine and azide would be expected to be less active

at lower pH values. In the proflavine experiments concentration levels of 42 and 63 mg./l. were reached in 98 and 185 minutes respectively. In the first case the pH was unchanged at the end of the experiment and in the second case it had dropped from 7.0 to 6.7. Controls in which the cells were inoculated directly into media adjusted to the pH reached at the end of the respective experiments and containing 42 and 63 mg./l. of drug respectively had lags of 380 and 1,300 minutes respectively.

In experiments with sodium azide, concentrations of 263 and 430 mg./l. were reached in two experiments lasting for 130 and 245 minutes respectively. Controls put up as in the proflavine experiments had lags of 3,000 minutes and infinity respectively.

There can be little doubt that these experiments involve the adjustment of the cells to the adverse environment since the time intervals are too short for any extensive selection of pre-existing resistant mutants. This "physiological" adaptation, is however, unstable on subculture. Continued subculture in the drug media stabilizes it. In this process there would be time for selection. It would, however, be rather surprising if there were two quite distinct mechanisms involved in the development of a resistance and the *gradual* stabilization of that same degree of resistance to the same drug by the same organism. This matter is under further investigation.

Binding or Adsorption of Drugs by Resistant and Non-Resistant Cells

Proflavine-resistant cells of *Bact. lactis aerogenes* take up from solution not less but more proflavine than those of the non-resistant strain from which they have been derived (Peacocke and Hinshelwood, 1948). On the other hand, certain phage-resistant forms of *Esch. coli* B take up no phage, in contrast with the corresponding sensitive forms for which Brenner (1955) determined the adsorption isotherms. Eagle

(1954) found that some penicillin-resistant forms of bacteria take up more and some take up less of the drug than the sensitive forms.

These facts support the idea that there may be more than one mechanism of resistance. If the cell has suffered damage (e.g. by exposure to radiation) so that it has lost receptors which bind the drug, then it may thereby acquire a certain passive kind of resistance which would contrast with a more active type of resistance to be suspected in those examples where the drug is actually taken up more readily by the adapted form.

The passive type due to loss of a function would be that for which a spontaneous origin could be most readily explained.

Among drug resistances, as distinct from resistance to phage, that to streptomycin seems more likely than many to have, on occasion though not necessarily always, a spontaneous origin. In this connexion the adsorption isotherms are of interest. Dean (unpublished) found that the sensitive form of *Bact. lactis aerogenes* took up streptomycin according to a conventional type of adsorption isotherm. A resistant strain took up little or none in most experiments, but occasionally showed a positive adsorption. If the resistant bacteria were grown anaerobically, however, the adsorption was once more considerable. The phenomena are still under investigation but they seem, on the whole, to provide evidence that loss of receptors may play some part in one type of streptomycin resistance of at least some bacteria.

The complexity of the situation is, however, illustrated by the fact that Neumark and Pasynskii (1954) found about equal adsorptions of streptomycin for resistant and sensitive varieties of the same strain of *Staphylococcus aureus*.

Papilla Formation

The papillae or secondary colonies which, in certain conditions, form on the edge or on the surface of primary colonies have generally been supposed to owe their origin to mutant

cells. We have set forth elsewhere evidence in support of our view that this is an oversimplified, and sometimes incorrect interpretation of the phenomenon (Dean and Hinshelwood, 1957). Our present views, and the arguments for them, may be summarized as follows.

(1) Secondary colony formation is essentially a phenomenon shown by the *ageing* primary colony. In this we are in complete agreement with the work and views of Haddow (1937).

(2) Observations on the very early stages of colony growth show that cells align themselves into more or less regular arrays giving the colony a characteristic internal structure. This is generally very close-packed.

(3) Growth of the colony stops when nutrient is exhausted or toxic products accumulate. Renewed growth is only possible when one of several things has occurred. The cells have thrown off mutants or have adapted themselves to utilize a substrate not utilized at first, or they have become resistant to something which has hitherto impeded their growth, or regions of lysis occur permitting cannibalism in parts of the existing colony, or cracks and channels may develop in the mass of the colony allowing nutrient to diffuse from the medium below to its surface so that fresh growth can take place there.

(4) The renewed growth can result in papilla formation, when for any of a number of reasons it is localized. If, for example, capillary channels to feed nutrient to the aerated surface of the colony are required, the papillae will occur at the points where such "craters" exist. The surface may be preferred to the periphery because the concentration of toxic products is lower. Particular points on the periphery may be preferred for such reasons as that the highly heterogeneous microstructure of the agar gel there provides adsorption sites which remove inhibitors, or concentrate growth factors.

(5) If renewed growth depends in this way on fortuitous structural factors, the new array of cells will not conform to the former one in orientation and packing, and a visibly

distinct secondary colony will result. Heterogeneity of colony form is sometimes manifested in ways other than papilla formation—colonies with crinkled edges, “rough” colonies and so on. In the course of our work we have often observed in ageing colonies the development of “lenticular” areas of changed internal colony texture, possibly connected with local lysis and re-growth. The papilla is one of quite a series of departures from regular monotonous colony development.

(6) Several lines of experimental evidence show that papillae need not arise from mutants.

(a) When drugs, such as phenol or thymol, are added to the solid medium, papillae occur in numbers which do not increase with the total number of cells grown (i.e. with the chance of mutation) but simply with the age and diameter of the colonies. The same total growth distributed among a large number of smaller colonies may be associated with no papilla formation at all, even though the chance of mutation is as great, and the opportunity for mutants to develop is probably greater.

(b) Re-spreading of inocula derived from the secondary colonies sometimes give colonies still showing papillae—even to the sixth re-spreading. In general, re-spreading may lead to fresh papilla formation or not, according to circumstances. Where it does not, the disappearance is usually attributed to the selection of the mutants. This conclusion is, however, ambiguous. When any form of adaptive response, whether by mutation or otherwise, has once occurred (as it can do during the slow growth of a primary colony on an initially unsuitable medium) the times of colony formation in the “re-spreading” experiment are less than in the original test. Thus the period elapsing between the initiation of growth and the final complete exhaustion of the medium is reduced. By the time any parts of the colony have aged enough for papilla formation to occur, all nutrients may have been removed and no secondary growths can develop. In the first plating the utilization is so slow that some parts of the colony age sufficiently while there is still unexhausted material for growth.

(c) When colonies are formed in such examples as the growth of *Bact. coli mutabile* on lactose or *Bact. lactis aerogenes* on D-arabinose, the primary colony has often become so large before any of the secondaries appear that to attribute all the utilization of the adaptation-requiring substrate to these is impossible. Moreover, re-spreading of inocula taken from primaries and papillae on lactose-endo-agar plates may result in nearly as many Lac⁺ colonies from the former as from the latter. In general, however, the papillae should yield more thoroughly adapted cells since they have utilized lactose after the lag required for the adaptation, whereas parts of the primary grew on peptone, and had no opportunity for using lactose (Dean and Hinshelwood, 1957).

Fluctuation Tests

The belief that the Luria and Delbrück fluctuation test is a reliable proof of the spontaneous origin of drug-resistant mutants or of mutants capable of utilizing new substrates is now less widely held than formerly. Factors other than mutation, which are not usually controlled rigidly in the test, have been shown to be capable of producing the observed variation between samples from the same culture and samples from different cultures. It has also been questioned whether Newcombe's spreading technique provides unambiguous evidence for the existence of spontaneous mutants and whether the results of the fluctuation test are necessarily strengthened by the inclusion of a test for correlation between relatives or by invoking the Lea-Coulson distribution (Dean and Hinshelwood, 1952*a* and *b*; Hinshelwood, 1953; Dean, 1955).

The Technique of Replica Plating and Related Methods

The natural level of resistance of bacteria to drugs differs among varieties of the same strain and among closely related

strains. *Bact. lactis aerogenes*, for example, will grow without previous adaptation in presence of proflavine at concentrations several times greater than those which completely inhibit the growth of most strains of *Esch. coli*.

The biochemical history of the strain also affects the natural resistance level. A strain of *Esch. coli* transferred from a broth medium to a minimal glucose-ammonium sulphate medium acquired substantially increased resistance to proflavine (in the minimal medium) as it became thoroughly adapted to the medium itself. The maximum concentration of proflavine tolerated rose about threefold (McConnell, unpublished). Adaptation of *Esch. coli* to various nutrient sources caused changes in the resistance level to various drugs within a range of 50 to 150 per cent.

These relatively minor differences may be of structural (genetic) origin, or may reflect changes in the enzymic organization of the cell as the case may be. Cavalli-Sforza and Lederberg (1956), by a selection technique with liquid media, obtained strains which showed an increase from about 10 to about 35 mg./l. in the maximum concentration of chloramphenicol which they would tolerate. We have, as stated, observed variations of this order in the proflavine resistance of mass cultures not subjected to selective techniques, and the increase from 10 to 35 mg./l. in the chloramphenicol, even if it is due to the selection of mutants is very small compared with the increase to many hundreds which is readily achieved by culture in presence of the drug itself. A strain of *Esch. coli* has been trained to resist 1,100 mg./l. of chloramphenicol.

With streptomycin, as with phage, much more drastic increases in resistance have been reported (Lederberg and Lederberg, 1952; Cavalli-Sforza and Lederberg, 1956). One of the forms of streptomycin resistance is probably due to loss of receptors for the drug, just as some phage resistance is due to inability of the cell to take up the phage. This passive type of resistance is, in our view, much more likely than any other to arise spontaneously, since most controlled mutations seem

to be destructive, and in the course of their normal life the cells encounter destructive agencies such as radiations in an unpredictable manner.

Nevertheless, in the absence of more detailed knowledge of the structural changes which determine difference in biochemical properties, it would be unwise to neglect the possibility that spontaneous mutations giving rise to positive new capacities in the cell may sometimes occur, and if they do they could be selected. The fact that sometimes such mutants can be enriched by selective methods (though we are rather doubtful about the evidence of successful application of these methods except in the case where the passive type of resistance is at least possible) does not in any way show that direct adaptation is not also a common method by which drug resistance appears.

The positive evidence for this direct adaptation is strong, and the arguments have already been summarized. One final comment may be added: by methods of accelerated training high degrees of unstable resistance can be produced under conditions where selection could not possibly have operated. We do not believe that the gradual and progressive stabilization of this represents the complete substitution of one phenomenon by another having no connexion with it.

In conclusion, perhaps we should make clear once more that we have never contested the part that selection of mutants may play (*cf.* Hinshelwood, 1946). If that denial has sometimes been gratuitously made for us by others, it is perhaps because we have been more interested in investigating and following up the nature of the adaptation process itself. This, indeed, is a matter of very great biochemical and biophysical interest, and should need no apology, though it may not seem the aspect of major interest to those whose approach is through classical genetics. Similar efforts to form a picture of how spontaneous mutations occur, and how they lead to resistance, is another problem well worthy of attention.

REFERENCES

- AKIBA, T. (1955). *In* Origins of Resistance to Toxic Agents, p. 82. Ed., Sevag, M. G., Reid, R. D., and Reynolds, O. E. New York: Academic Press.
- BASKETT, A. C. (1952). *Proc. roy. Soc. B*, **139**, 251.
- BASKETT, A. C., and HINSHELWOOD, Sir CYRIL (1951). *Proc. roy. Soc. B*, **139**, 58.
- BRENNER, S. (1955). *Proc. roy. Soc. B*, **144**, 93.
- CAVALLI-SFORZA, L. L., and LEDERBERG, J. (1956). *Genetics*, **41**, 365.
- CROSS, J. R., and HINSHELWOOD, Sir CYRIL (1956). *Proc. roy. Soc. B*, **145**, 516.
- DAVIES, D. S., and HINSHELWOOD, C. N. (1943). *Trans. Faraday Soc.*, **39**, 431.
- DAVIES, D. S., HINSHELWOOD, C. N., and PRYCE, J. M. G. (1944). *Trans. Faraday Soc.*, **40**, 397.
- DAVIES, D. S., HINSHELWOOD, C. N., and PRYCE, J. M. G. (1945). *Trans. Faraday Soc.*, **41**, 778.
- DEAN, A. C. R. (1955). *In* Origins of Resistance to Toxic Agents, p. 42. Ed., Sevag, M. G., Reid, R. D., and Reynolds, O. E. New York: Academic Press.
- DEAN, A. C. R., and HINSHELWOOD, Sir CYRIL (1952*a*). *Proc. roy. Soc. B*, **139**, 236.
- DEAN, A. C. R., and HINSHELWOOD, Sir CYRIL (1952*b*). *Proc. roy. Soc. B*, **140**, 339.
- DEAN, A. C. R., and HINSHELWOOD, Sir CYRIL (1954*a*). *Proc. roy. Soc. B*, **142**, 45.
- DEAN, A. C. R., and HINSHELWOOD, Sir CYRIL (1954*b*). *Proc. roy. Soc. B*, **142**, 225.
- DEAN, A. C. R., and HINSHELWOOD, Sir CYRIL (1954*c*). *Proc. roy. Soc. B*, **142**, 471.
- DEAN, A. C. R., and HINSHELWOOD, Sir CYRIL (1955). *Proc. roy. Soc. B*, **144**, 297.
- DEAN, A. C. R., and HINSHELWOOD, Sir CYRIL (1956). *Proc. roy. Soc. B*, **146**, 109.
- DEAN, A. C. R., and HINSHELWOOD, Sir CYRIL (1957). *Proc. roy. Soc. B*, in press.
- EAGLE, H. (1954). *J. exp. Med.*, **99**, 207; **100**, 103; **100**, 117.
- HADDOW, A. (1937). *Acta Un. int. Cancr.*, **2**, 376.
- HINSHELWOOD, C. N. (1946). *The Chemical Kinetics of the Bacterial Cell*. Oxford: Clarendon Press.
- HINSHELWOOD, Sir CYRIL (1953). *Symp. Soc. gen. Microbiol.*, **3**, 18.
- JAMES, A. M., and HINSHELWOOD, C. N. (1947). *Trans. Faraday Soc.*, **43**, 274.
- KILKENNY, B. C., and HINSHELWOOD, Sir CYRIL (1951). *Proc. roy. Soc. B*, **139**, 575.
- LEDERBERG, J., and LEDERBERG, E. M. (1952). *J. Bact.*, **63**, 399.
- MCCARTHY, B. J., and HINSHELWOOD, Sir CYRIL (1957). *Proc. roy. Soc. B*, in press.
- MIMS, N. M., and HINSHELWOOD, Sir CYRIL (1953). *J. chem. Soc.*, p. 663.

- NEUMARK A. M., and PASYNSKII, A. G. (1954). *Dokl. Akad. Nauk., USSR*, **95**, 329.
- NEWCOMBE, H. B. (1948). *Genetics*, **33**, 447.
- NEWCOMBE, H. B. (1953). *Genetics*, **38**, 134.
- PEACOCKE, A. R., and HINSHELWOOD, Sir CYRIL (1948). *J. chem. Soc.*, p. 2290.
- PRYCE, J. M. G., and HINSHELWOOD, C. N. (1947). *Trans. Faraday Soc.*, **43**, 1.
- RYAN, F. J. (1955). *Genetics*, **40**, 726.
- SZYBALSKI, W. (1954-55). *Antibiotics Annual*, p. 174.
- WILD, D. G., and HINSHELWOOD, Sir CYRIL (1956). *Proc. roy. Soc. B*, **145**, 32.

DISCUSSION

Lederberg: In 1954, Sir Cyril, you sent us a culture of your *Bact. lactis aerogenes*; we have been experimenting with it from time to time, and I regret to say that we do not get the observational results that you have indicated. According to your published results (Baskett and Hinshelwood, 1951, *loc. cit.*), the inoculation of this organism into tubes of minimal medium containing D-arabinose as a sole carbon source is followed by an interval in which there is an increase in total mass; and during this interval there may be a homogeneous response during which each of the cells in the suspension has become gradually (but all of the cells uniformly) better adapted to this environment, so that when they are plated they show a uniform decrease in the lag for the time of colony development. Our own findings are that when samples are taken from a tube inoculated—say with 10^7 or 2×10^7 cells per ml.—in such a medium, and these samples are plated out at half-daily or daily intervals, there is a variable time of onset of visibly turbid growth. That is invariably preceded by the appearance of a large colony-forming type, and during the interval this increase in turbidity gives a very clearcut distinction between small and large colonies, and the large colonies simply increase. I have seen nothing in this system which is not most readily explainable by the sporadic occurrence of a better adapted mutant which will form large colonies. However, there are several features in this system which make it less precise to work with than some other selectable systems, and which may perhaps account for some of the questions of increase in mass. It is quite clear that the original type is capable of utilizing arabinose, but I think at a much slower rate than the wild type. Even unadapted cells will form colonies, so that as these colonies are replated they continue to form visible colonies; it may take a week before they reach a size of 1 mm. or so in diameter. Every once in a while one finds a colony—one of a number of hundreds of colonies on a plate—that has become quite large over a period of a day or two, and this on replating always gives a large colony. In addition, there is a very large stimulation of colonies by products from the adapted types, and I suspect that is one of the reasons for the conclusion that there is a uniform response. If the colonies are plated too densely there is a marked

stimulation from the plus to the minus colonies so that there appears to be a uniformity of colony type which in fact does not exist, as can be shown by replating. To summarize: my own experience has been that there occurs from time to time, in these cultures held in D-arabinose medium, a new cell type which increases very rapidly over a period of about 1-1.5 days, and that this overtakes the bulk of the population; but one can see these two colonies side by side with one another in these platings, provided they are not plated too densely.

Hinsheewood: We never get this division into two sharply defined types unless actual growth and multiplication of numbers in the culture is already well under way. With the arabinose-negative type and the lactose-negative type we get at any given time a distribution of colony size, or for any given size a distribution of times, which is practically a Gaussian distribution.

The essential point of our argument is that *before* any growth or multiplication in the liquid medium begins all or most of the cells show a reduction in the actual time required to form a colony of standard size on the plate. I should attribute Prof. Lederberg's large colonies to cells taken from a culture in which growth in the liquid has already begun to make some appreciable progress. A very careful watch on total and viable counts is necessary. There are two arguments: increase in mass precedes increase in number, and decrease in plate lag may precede either. Plating after measurable increase in turbidity may give colonies from cells which have reached a still more advanced stage of adaptation.

Lederberg: We have done a variety of experiments. If we put e.g. 100 cells into a plate then we get a fairly uniform development which gives colonies of quite good size over a period of a week. When these colonies are replated they almost invariably give exactly the same picture, though it may take another week before they come out. Occasionally one finds a colony that has an actual burgeoning-out from it, and when such a colony is replated it gives the plus-type which immediately grows up (it takes about a day and a half to reach the same colony type). This experiment can be done, for example, by making rather dense platings of about 10^4 or 10^5 cells into a plate; this gives a sort of ground glass appearance, and with a binocular microscope one can see the individual colonies. Undoubtedly the minus-type is capable of utilizing at a fair rate either D-arabinose (which I suspect is the case) or some contaminant in the preparation. I think some of the imprecision that may creep in here is due to the fact that we are not jumping from a zero state to a 100 state, but from a 5 state to a 75 state, so to speak, as compared with the rate of utilization of glucose. In such densely inoculated plates there appear from time to time, over a period of a week or ten days, occasional large colonies which are surrounded by a very dense halo of satellites of colonies from the background. Now, if we replate the large ones, which are quite rare, these give new platings which consist mostly of large colonies. If we replate from the satellites immediately around them, or from the background growth, we generally get a small colony development. So here are cells, side by side in the same environment, which have quite diverse histories; and there must occur a sudden "catastrophe"

which strikes an occasional part of the plate and gives rise to wide divergences in subsequent behaviour.

Hinshelwood: Do you keep complete time-size logs of all the colonies on the plate? We have always thought it necessary to do this, i.e. to measure or photograph the plate day by day or every half-day. Otherwise, if you inspect things at arbitrary intervals and arbitrary sizes you do tend to create sharp distinctions which may not exist. These are especially marked if the liquid culture has already begun to multiply.

Lederberg: No, we have not done this. Nor are we acquainted with such a detailed presentation in the literature.

Pollock: We have done some work on the original strain of *Bact. coli mutabile* used by Sir Cyril (see Dean and Hinshelwood, 1954*b*, *loc. cit.*) for studying the lactose training phenomenon which he maintains is specifically induced in most of the cells by lactose. Most of our findings correspond to what Lederberg has described for D-arabinoase training. Cells untrained to lactose (Lac^-) plated into lactose-agar produce small colonies (Fig. 1*a*) compared to cells from a lactose-trained culture (Lac^+) which form much larger, denser colonies (Fig. 1*b*) in the same period (5-7 days). If you leave the Lac^- colonies for longer, most of them eventually grow into large colonies (Fig. 1*c*) comparable in size to the Lac^+ colonies (as described by Dean and Hinshelwood) but mottled and irregular in appearance. A series of stages in the development of Lac^- colonies is illustrated in Fig. 2*a* to *f* showing clearly the emergence of papillae. Subcultures from the papillae yield nearly 100 per cent colonies of the Lac^+ type (Fig. 1*b*) in lactose agar. It might be quite easy to miss these papillae in colonies growing deep in agar and they were only easily visible by the use of a binocular plate microscope. With surface-inoculations, the papillae were quite obvious to the naked eye and it was much easier to distinguish between colonies of the Lac^+ and Lac^- type. Fig. 3 is a re-analysis of the Hinshelwood and Dean curve of increase in cell numbers of a glucose-grown culture inoculated into a liquid lactose medium. As well as plating samples out into glucose agar (for total viable count) they were also plated into lactose agar and Lac^+ and Lac^- colonies counted. The total viable count corresponds exactly with Dean and Hinshelwood's curve, but it can be seen that the final rise in numbers is due entirely to growth of Lac^+ cells (which have, indeed, been increasing logarithmically during most of the experiment). With surface inoculation on lactose agar there is absolutely no difficulty, after 4 days of incubation, in distinguishing the two types of colony. The Lac^+ colonies are opaque and dome-shaped and nearly twice the diameter of the much thinner and flatter Lac^- colonies. Fig. 4*a* shows the appearance of colonies, after 8 days of incubation, from a Lac^- culture inoculated on the surface of lactose agar. Fig. 4*b* shows 3 Lac^+ and 3 Lac^- colonies from an artificial 50 : 50 mixture of Lac^+ and Lac^- cells inoculated in the same way and incubated for the same period. The Lac^- colonies in Fig. 4*b* are about twice the diameter of those in Fig. 4*a*; their growth has obviously been greatly stimulated by a substance produced by the Lac^+ cells. It might be something as simple as glucose. It seems possible that this effect might

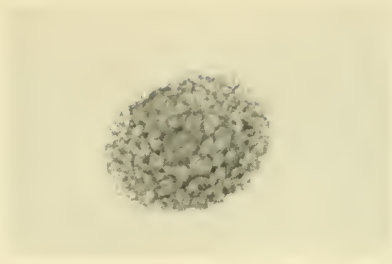

a

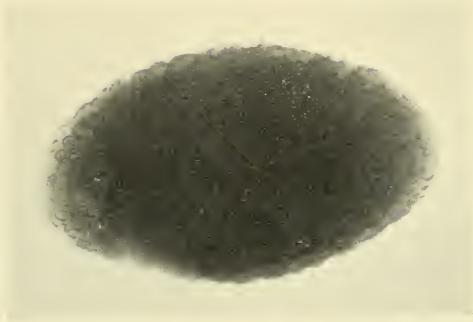

b

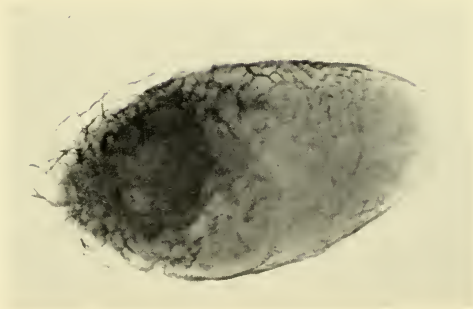

c

FIG. 1 (Pollock). Single deep colonies of *Bact. coli mutabile* growing in lactose-agar. $\times 80$.

- a*. From Lac⁻ inoculum. 7 days' incubation.
b. From Lac⁺ inoculum. 5 days' incubation.
c. From Lac⁻ inoculum. 9 days' incubation.

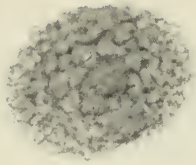

a

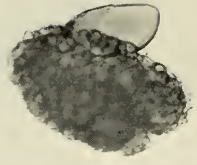

b

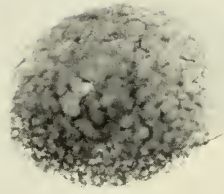

c

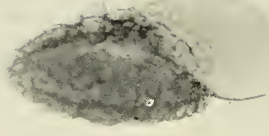

d

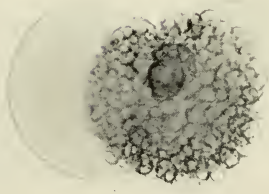

e

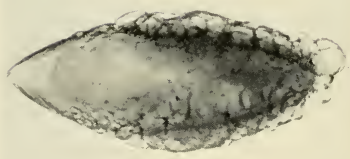

f

FIG. 2 (Pollock). Single deep colonies (chosen at random) from Lac⁻ inoculum of *Bact. coli mutabile* growing in lactose-agar. 7-9 days' incubation. $\times 80$.

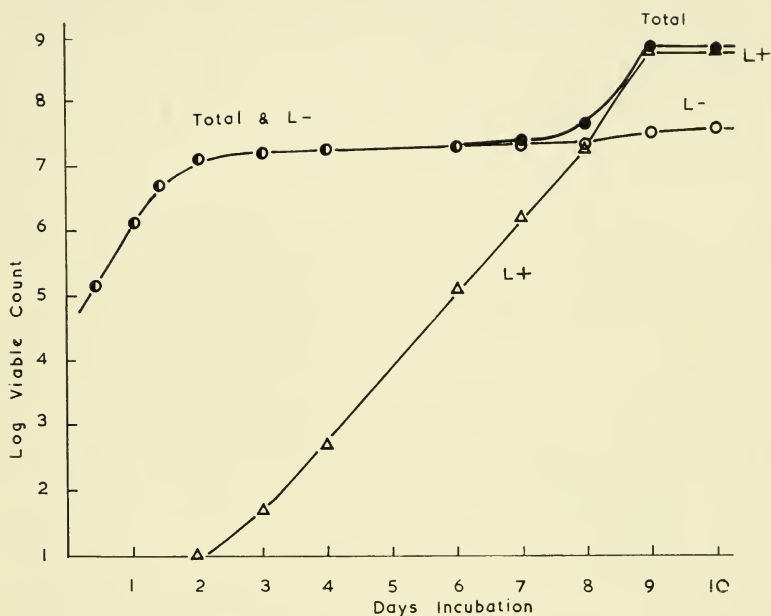
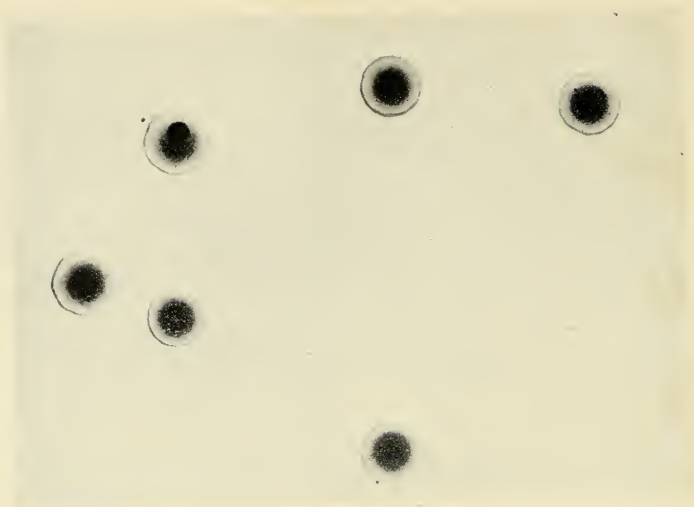
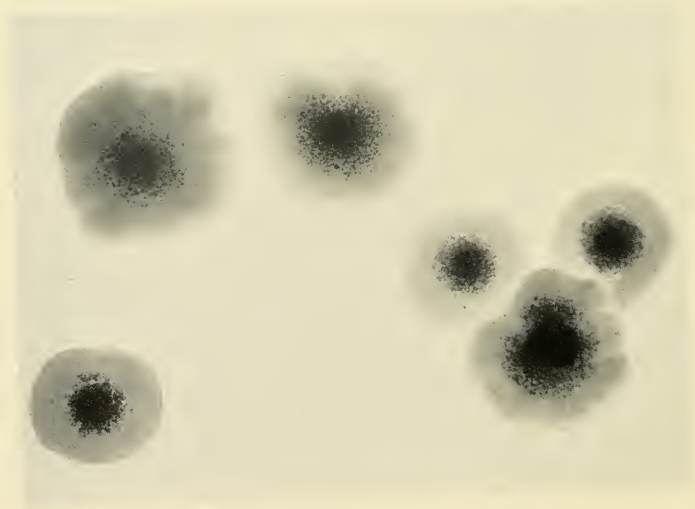

FIG. 3 (Pollock). Numbers of Lac^+ and Lac^- colonies found on plating out on the surface of lactose-agar samples of a culture of *Bact. coli mutabile* (from a glucose-grown inoculum) during "training" in a liquid lactose medium.



a



b

FIG. 4 (Pollock). Colonies of *Bact. coli mutabile* growing on the surface of lactose-agar. 8 days' incubation. $\times 8$.

- a. From Lac^- inoculum (all Lac^- colonies).
b. From an inoculum containing a 50 : 50 mixture of Lac^- and Lac^+ cells (showing 3 Lac^+ and 3 Lac^- colonies).

explain why Dean and Hinshelwood failed to observe the two distinct types of colony in their experiments during the course of training to lactose. All these findings obviously do not explain the origin of papillae; nor do they exclude the possibility of some direct induced change in individual cells, as has been claimed. I only suggest that it is much simpler to assume that you have got some kind of mutation in a very few cells, followed by selection.

Hinshelwood: We don't agree with the interpretation of that curve. We don't agree that if you plate out and then observe the relation between the time and the size of the colony you find this distinction between the two types. Moreover, we are very well aware of the mutual stimulation, and indeed have published a paper on it. But if you plate a culture that has been lagging in a medium, and you get perhaps 30-40 colonies all in a short space of time, it is hardly possible for those to have stimulated one another. If they have been lagging in the medium for 24 hours, and you plate out enough cells to give a total count of 50 and these all come up, e.g. within 30 hours of one another and not at widely different intervals, then they do not have much chance to stimulate one another.

Pollock: I am thinking of the half-trained culture.

Hinshelwood: Yes, that is exactly what I am talking about.

Pollock: Would that not be 2 or 3 or 4 days, rather than 24 hours?

Hinshelwood: It depends on how advanced the stage of training is.

Pollock: We did not pursue the problem any further, and we did not prove anything, but mutation followed by selection seems a likely explanation.

Hinshelwood: I do not see how this matter of having two juxtaposed colonies, one affecting the other, is relevant to this particular question.

Pollock: My point is that it might be very misleading when you were scoring your large colonies and your small colonies.

Dean: The colonies are too far apart on the Petri dish to stimulate one another.

Pollock: We find that you get stimulation over a very long distance.

Hinshelwood: That is when a big colony has been formed and the small colony is near it.

Lederberg: I have seen this develop in the course of two days, e.g. with D-arabinose.

Pontecorvo: Prof. Hinshelwood has clearly stated that, of course, he does not deny that there are changes in cell structures which segregate; on the other hand, no geneticist will deny that there are permanent heritable changes definitely not due to changes in structural elements like chromosomes. If we denied this of course we would deny somatic differentiation in higher organisms! Now what seems to me an important point to discuss is that of the relations between kinetic changes and changes in cell structures during a process of phylogenetic adaptation. This has been attempted at the level of higher organisms: Waddington, for instance, has developed theories to show how responses which are at first directly elicited by an external stimulus may be taken over and made permanent by changes in structures later on.

Eagle: Although I agree with Dr. Pontecorvo in general, I think the question that Prof. Hinshelwood and Dr. Dean have raised is specifically whether the development of resistance to antibiotics is adaptational or mutational. We have some data, very similar to those presented by Dr. Pollock, in relation to this point. We made a serious effort to show that the development of resistance was indeed the result of adaptation, but were reluctantly forced to the conclusion that all our data were

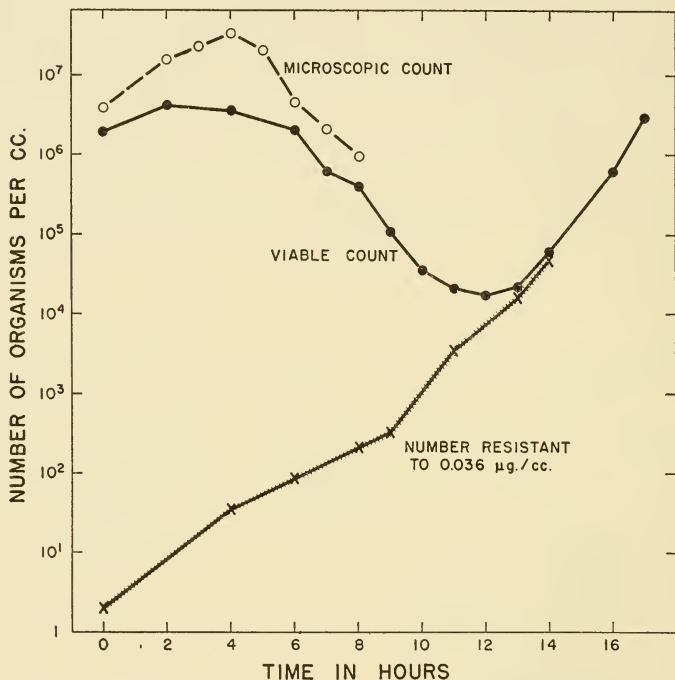

FIG. 1 (Eagle). Development of resistance to penicillin in broth cultures of *Micrococcus pyogenes* (concentration of penicillin in medium, 0.036 µg./ml.).

consistent with a rare mutational event, followed by selection. There was no conclusive evidence for adaptation.

With staphylococci and penicillin we get precisely the curves which Dr. Pollock showed. As indicated in Fig. 1, at an appropriate concentration of penicillin in a fluid medium, the total number of viable organisms at first falls steeply, after which the survivors apparently begin to remultiply. Actually, however, throughout the entire period, resistant organisms present *ab initio* have been multiplying, and eventually take over the population.

In this instance, precisely as with the Lac^- and Lac^+ , we are dealing with the selective multiplication, in a large population, of the rare resistant organism.

A more interesting experiment was that with chloramphenicol and *Strep. faecalis* in a sealed agar plate. If the plate was poured with no more than 50–100 organisms, then at threshold concentrations of chloramphenicol, after periods of as long as 50 days, every organism inoculated ultimately grew out to form a visible colony. At this point we thought we had demonstrated adaptation, because each colony which appeared proved to be relatively resistant to chloramphenicol. However, if during this period of supposed adaptation, and before visible colonies had appeared, the agar were cut into e.g. 100 sectors, and the number of organisms in each sector determined, we found that all through this period there had been an extremely slow but progressive multiplication of the organisms. Initially, these organisms were not resistant. It was only after the population of the microcolony reached fairly large proportions that resistant organisms began to appear; and those resistant organisms then multiplied at a relatively rapid rate. These results are again consistent with mutation and selection, and do not prove adaptation. At least with penicillin and chloramphenicol, we have therefore found no need to invoke physiological adaptation as the basis for the development of increased resistance. All our data are consistent with the rare appearance of mutation, followed by selection.

Hinshelwood: Dr. Eagle, what is the criterion of a resistant organism?

Eagle: An organism which is capable of growing rapidly to form a colony at a concentration of penicillin or chloramphenicol at which normally no colony appears.

Hinshelwood: Under what conditions?

Eagle: In the case of penicillin, plating out in agar and watching the plates for about 5 or 6 days. The proportion of organisms which develop colonies is of course a function of the concentration used. With our particular strain of staphylococcus, for instance, at $0.02 \mu\text{g./ml.}$ 100 per cent will grow up in time; at $0.03 \mu\text{g.}$ the number begins to fall off very sharply; at $0.04 \mu\text{g.}$ one gets down to a very small fraction of viable organisms.

Hinshelwood: In the curve you showed, the cells are dying off in one part, obviously. There is a race between dying and adaptation. At a given stage you plate, and the surviving cells will partially adapt. Suppose that slow adaptation is going on, in competition with the dying off; now you plate your samples at intervals, and naturally a larger and larger number of cells can survive on the plate as the adaptation in the liquid approaches completion. The number that can survive is steadily increasing as the adaptation approaches more nearly to perfection. But if you have too small an inoculum all the cells will be dead before anything like adaptation has set in, so on the adaptive hypothesis you would expect precisely the result found. I would suggest that the experiment is not unambiguous and is made uncertain by your very criterion of what is a resistant form. It is a form which has achieved some measure of adaptation by the time the sample was taken.

INDIRECT SELECTION AND ORIGIN OF RESISTANCE

L. L. CAVALLI-SFORZA

Istituto Sieroterapico, Milan

Adaptation of individuals and of populations

ADAPTATION to environmental changes in living organisms can take place both at an individual and at a populational level. Mechanisms of the first type are often efficient enough to cope with the altered situation, but there will be some variation in the individual responses to the changed environment. If the following two conditions are fulfilled: (i) that this variation is at least in part heritable, (ii) that there is differential reproduction of individuals showing different degrees of adaptation, then the population is also bound to change, in the sense that the frequencies with which the variously adaptable types are represented will be modified.

This mechanism is of course nothing but natural selection and its consequence is evolution. How much evolution takes place in any given population in a given time is dependent on how much heritable variation is available, and this is a property of the population; and on how much variation in the reproduction of the various types is created by the change in living conditions. The use of antibacterial drugs in concentrations at which they exert their specific effect constitutes a fairly drastic change in conditions, which is bound to affect deeply the rates of reproduction of individual cells. One should therefore expect drugs to effect major changes in the composition of a bacterial population whenever this contains—either because of original heterogeneity or because of new hereditary change—types which have different adaptability.

Heritable changes

There would probably be full agreement so far but for the question of the heritability of individual changes in drug adaptation. In order to avoid irreconcilable disagreement at a later stage, we must agree on operational definitions of what is heritable and what is not; only the former type of change is of direct interest to the geneticists. Considering the necessity of distinguishing individual from populational adaptation, the heritability of an observed change in a population must be examined as much as possible at the level of single individuals, and not limited to that of the population as a whole. As this is often technically impossible, compromises should be attempted and their results analysed with care. For most ordinary work the following definition, which corresponds to what is routinely done in many laboratories, was found to be useful. A population is considered to contain resistant individuals, if single cells isolated (usually by plating) from it and allowed to grow into colonies in the absence of the selection medium, are found to be resistant, the test being carried out on samples from such colonies, or sub-cultures from them.

These "minimum" requirements for heritability have obvious shortcomings, but unless we accept an unequivocal definition, confusion is inevitable, as has indeed happened. Further definitions may be elaborated: this one has the advantage of corresponding to the usual procedure, and of being simple. It will fail on exceptional occasions, for highly mutable and poorly growing mutants. But if any sluggishly reversible, directly induced adaptation is taking place, it should be picked up with this procedure.

Pre- or postadaptation

Since it has been ascertained that heritable changes in drug resistance, or any other trait, do in fact occur after treatment of the population, the question has repeatedly arisen: is the change induced by the drug itself or does this simply select

pre-existing, or independently forming, variants? These two mechanisms have also been called post- and preadaptation, respectively (Cavalli-Sforza and Lederberg, 1953).

The available data may be considered. In higher organisms the distinction between phenotype and genotype is an absolute necessity if confusion is to be avoided. The effects of environmental conditions, bringing about individual adaptation, affect the phenotype but not the genotype, i.e. the sum of the hereditary potentialities from which successive generations are moulded. Therefore, selection can be effective only when it picks up spontaneous variation, in other words, variation which occurred at a level where the selective conditions cannot act: that of the hereditary determinants. To clear the issue we have, it is true, to simplify and forget about a few systems, essentially cytoplasmic inheritance; but the cost does not seem to be too high, at least at present.

Higher organisms, on which these conclusions were developed, are probably best defined in this connexion as those in which the ratio of sizes between the adult soma and the gamete is high. In fact, some workers have developed the view that in unicellular organisms (where this ratio is low, soma and germ being of nearer orders of magnitude in size) the distinction between genotype and phenotype is an artificial one. However, experiments like those reported by Hayes (this symposium, p. 197) will be helpful in showing, if necessary, which differences exist between what is hereditarily determinant, and what is determined, even in a unicellular organism. Also, the fact that observation of simple individuals usually takes place on colonies produced from them helps to eliminate, though perhaps only partially, the effects of the "phenotype" of the individual giving rise to the colony, by the "dilution" to which it is subject when a large clone is built from it.

Adaptation of bacterial populations

The facts on "lower" organisms are simply summarized. Early attempts were made (early at least in the short history

of bacterial genetics) to see if the model which was so fruitful for the study of evolution in higher organisms, namely the selection of spontaneous genotypic changes, could be applied to explain changes in resistance, in particular to viruses and drugs. The elegant methods of Luria and Delbrück, and of Newcombe, were used successfully and gave practically unequivocal answers in favour of the preadaptation theory.

Both the strength of these methods and the validity of the conclusions which rely on the statistical properties of clones have been questioned. While the present author would agree as to their insufficient strength, which leaves the door ajar to equivocal results or interpretations, the evidence collected later has fully confirmed the validity of the early conclusions. In view of the existence of such stronger evidence, methods of analysis such as the so-called "fluctuation test", the test of "average clones" and the "correlation between relatives" will not be considered here. They have been reviewed elsewhere (Cavalli-Sforza, 1952; Cavalli-Sforza and Lederberg, 1953). A method will be considered instead, the strength of which nobody would question, namely that of indirect selection.

Indirect selection

Indirect selection was first introduced by Lederberg and Lederberg (1952) in streptomycin- and T1 phage-resistance. It uses sib-selection (or, in general, selection by tests on relatives) to obtain strains which are resistant to some agent, without using this agent for sorting out the resistant mutants. By substituting genetic testing for direct isolation with the drug, it can be proved, and has been proved unequivocally that the resistant cells are present in the population spontaneously, as they can be isolated from it without exposure of the population to the drug. To express the principle in simple terms, suppose we can isolate the two descendants of one cell for a great number of cells, and test for resistance to a drug one of the daughter cells, keeping the other for reproduction in the absence of the drug: if the mother cell was sensitive, apart from rare mutational events both cells should

also be sensitive. Therefore, the test on one of the two daughters will permit us to formulate with good probability the prediction that also the other daughter is sensitive. If the mother cell was resistant, both daughters should be resistant; this situation being revealed by the test carried out on one of the two daughter cells, it will be possible to verify the prediction that the untested sister should give rise to a pure colony of resistant cells.

This method has been made technically possible, for the first time, by the use of replica plating on solid media; and it has permitted the indirect isolation of streptomycin- and phage-resistant mutants. Later (Cavalli-Sforza and Lederberg, 1956), a method was developed for carrying out indirect selection in liquid cultures—which has the advantage over replica plating of leading more easily to quantitative analysis—with a view to answering the question: Have all resistant cells arisen by spontaneous mutations, or have some arisen by other mechanisms, such as mutation induced by the drug, or adaptation not controlled by nuclear determinants?

Concentration by limiting dilution

The principle of this method (Cavalli-Sforza and Lederberg, 1956) is to concentrate spontaneous mutants to resistance by using a sample which contains few resistant cells, possibly only one, and subdividing it further. If there is in the sample before subdivision just one resistant mutant and $(N-1)$ normal sensitives, i.e. if the relative frequency of mutant cells is $\frac{1}{N}$, after subdivision in n tubes the frequency of mutants will be $\frac{n}{N}$ in the tube which happened to receive the single mutant, and zero in the other tubes. Each tube will, in fact, receive N/n bacteria but only one of them contains the resistant mutant. This tube will therefore show an enrichment of mutants of n times. It will be possible to identify it by incubating all tubes after addition of fresh broth, and testing samples from them for drug resistance.

When statistical fluctuations are considered, as shown by Dr. J. Pfanzagl of Vienna (personal communication), the enrichment expected is:

$$E = \frac{1 - e^{-m}}{1 - e^{-m/n}} = \frac{f_1}{f_0}$$

where E is the ratio between the relative frequency of mutant cells in tubes which have received at least one of them (f_1), and that one in the original suspension (f_0); while m is the expected number of mutants in the sample which has been subdivided into n tubes.

One such experiment, e.g. on 10 tubes, will give at best a tenfold enrichment; but on repeating the indirect selection experiment it is possible to isolate in a predictable number of cycles a pure culture of resistant mutants, which will never have experienced direct contact with the drug.

This experiment was successfully carried out for high degree resistance to streptomycin and for low degree resistance to chloramphenicol in *Escherichia coli*. The speed of selection observed was comparable to that predicted, as is shown in greater detail in the paper by Cavalli-Sforza and Lederberg (1956).

A short report is given here of data in which this experiment was amplified, considering that every experiment of indirect selection tests just one culture, and that the most informative stage is the first cycle (or, occasionally, the first two cycles) of indirect selection. This usually permits the counting of spontaneous mutants, and the comparison of their number with that of the resistant cells counted by direct selection, i.e. by plating in presence of the drug. In view of the greater simplicity of the system, the experiment was made on streptomycin resistance.

Samples from a number of independent saturated cultures were tested for streptomycin resistance and concentrations of resistant cells per ml. ranging from 0 to 105 resistants were found. The tests on two cultures will be considered in detail.

Table I shows the results obtained with a saturated culture of *Esch. coli* K12 no. 176 which was expected, from the assay, to contain zero streptomycin-resistant mutants. Three samples from it (of 0.5 ml., 0.25 ml. and 0.125 ml., respectively) were diluted each to 20 ml. with fresh broth. Each 20-ml. quantity was distributed into 10 tubes, in quantities of 2 ml. per tube, and the 30 cultures thus obtained were incubated to saturation. Eventually the total number of resistants per culture was counted on streptomycin agar

Table I

A PROTOCOL OF QUANTITATIVE INDIRECT SELECTION

From a culture which has been assayed for streptomycin resistants and found to contain zero resistants per ml., further samples have given :

<i>Sample</i>	0.5 ml.	0.25 ml.	0.125 ml.
<i>Multiplication factor</i>	40 ×	80 ×	160 ×
Resistants	5	0	2
	6	0	1
	0	12	10
	4	10	10
	6	3	6
	13	6	17
	5	5	1
	1	0	11
	6	14	5
	3	14	0
Average per subculture	4.9	6.4	6.3

(500 µg./ml.). Some resistant cells were found (Table I), but only a few, and often there were none per culture; the average number of mutants expected in such conditions from more extensive tests is 4.8 ± 2.0 per culture, and the results from the three series agree within the limits of error with this number.

Table II shows what happened instead when a culture known to contain 39.5 resistant cells (from the assay of a sample from it plated in streptomycin agar) was treated in the same way. Here the sample of 0.125 ml. was expected to contain 5 mutants and if, on subdivision into 10 tubes, each of these fell into a separate tube, 5 out of these would

be expected to contain a mutant at the beginning of growth. As the sample of 0·125 ml. was made up to 20 ml. with fresh broth, every cell inoculated was allowed to grow into a clone of 160 cells on average. There should then be about 160 resistant cells in 5 out of 10 tubes of the 0·125-ml. series. This was found to be true of 4 tubes instead of 5. In other samples, of 0·5 and 0·25 ml., there is evidence that, as would

Table II

A PROTOCOL OF QUANTITATIVE INDIRECT SELECTION

From a culture which has been assayed for streptomycin resistants and found to contain 39·5 resistants per ml., further samples, after addition of fresh broth to a total of 20 ml. and incubation, have given:

<i>Sample</i>	0·5 ml.	0·25 ml.	0·125 ml.
<i>Multiplication factor</i>	40 ×	80 ×	160 ×
Resistants	0	160	19
	44	59	7
	0	65	0
	89	0	132
	31	0	0
	59	0	184
	53	102	156
	49	0	105
	159	164	0
	3	82	0
<i>Spontaneous mutants :</i>			
Expected	19·8	9·9	5·0
Found	11	8	4
Found (corr.)	13·2	9·1	4·5

be expected, more than one mutant fell into some tubes (e.g. the first and ninth tube of the 0·25-ml. sample, etc.).

One can in this way count the number of spontaneous mutants in a culture and compare it with the expected one, if the hypothesis is made that all resistants observed on drug plates are the consequence of spontaneous mutation. These two values are given for each sample in the second-last and third-last lines of Table II.

Corrections have to be made, however, to account for the statistical distribution of mutants and for the possible

differences in growth rate between mutant and parent in drug-free medium. Corrected figures for the numbers of spontaneous mutants are given in the last line of Table II. When this was done for 18 cultures, no significant deviation was found from the hypothesis that all resistants are the consequence of spontaneous mutations.

Some precautions

The following precautions should be taken in applying this test:

(1) The growth rate of mutants is usually lower than that of the normal sensitive. In 18 independent mutants, the distribution of relative growth rates k given in Table III was

Table III

DISTRIBUTION OF THE GROWTH RATES OF STREPTOMYCIN-RESISTANT MUTANTS
 k = Growth rate of resistant relative to growth rate of sensitive

k	Number of strains
less than 0.70	1
from 0.71 to 0.75	4
„ 0.76 „ 0.80	2
„ 0.81 „ 0.85	6
„ 0.86 „ 0.90	1
„ 0.91 „ 0.95	0
„ 0.96 „ 1.00	4
Total	18

obtained, where k is the ratio between the growth rate of the resistant and that of the sensitive parent in mixed culture.

If $k \neq 1$, the expected numbers of resistants per culture differ from those expected on the basis of the ratio of increase in total cell numbers (the “multiplication factors” in Tables I, II and IV). Table IV gives the expected numbers of resistants for some k values. When k is small the “enriched” mutants are not easily sorted out from the background of new mutants.

(2) In some circumstances, e.g. chloramphenicol resistance, first-step mutation does not determine a high level of resistance, and resistants may be incompletely recovered in tests

Table IV

NUMBER OF RESISTANTS EXPECTED FROM THE MULTIPLICATION OF A SINGLE CELL

 k = Growth rate of resistant relative to growth rate of sensitive

k	Multiplication factor		
	40 ×	80 ×	160 ×
0·6	9·2	13·8	21·0
0·7	13·2	21·4	34·8
0·8	19·1	33·3	58·0
0·9	27·6	51·6	96·0
0·95	33·2	64·0	124·0
1·0	40·0	80·0	160·0

with the drug concentrations necessary to eliminate all or most of the sensitives. There may also be interactions between sensitives and resistants in mixed populations, increasing (protection: Cavalli-Sforza and Lederberg, 1956) or decreasing (co-killing or suppression: Eagle, 1955) the count of the resistant type. Such situations can usually be revealed, and their consequences evaluated, by appropriate reconstruction experiments.

(3) Cells do not always divide regularly. For example, chains may be formed with the strain used here if static unaerated, but not aerated, cultures are employed. Where static unaerated cultures are used, situations of the type shown in Table V may be encountered. The irregularity

Table V

AN UNAERATED CULTURE CONTAINING 102 RESISTANTS PER ML. (STREPTOMYCIN AGAR ASSAY) TESTED BY INDIRECT SELECTION

Sample Multiplication factor	0·25 ml.	0·125 ml.	0·0625 ml.
	20 ×	40 ×	80 ×
Resistants	8	0	83
	47	10	24
	17	350	15
	24	42	11
	0	15	42
	132	24	0
	32	14	43
	5	77	0
	49	0	8
	27	0	610

in the distribution of the number of resistant per tube is immediately apparent. Thus the last tube of the 0.0625-ml. sample must have contained 8 or 9 mutants at least; the same is true of the third tube of the 0.125-ml. sample, and so on. This distribution could hardly be random. Presumably, resistant cells tend to form short chains which are not split on dilution in broth, while they are more easily broken up in agar, perhaps as a consequence of the joint action of temperature of the agar plus its chelating power. In such cases one would tend to underestimate the number of resistant mutants if the frequency of tubes showing enrichment were used for its assessment, while if enrichment ratios were used one would tend to overestimate it.

Conclusions

Tests of adaptation in bacterial and other populations are available that permit the assessment of the relative importance of genetic and non-genetic adaptation, defining the former as the selection of spontaneous mutants. In the cases tested so far—essentially streptomycin and chloramphenicol resistance—evidence was found for the adequacy of the hypothesis of genetic adaptation, and no need arose for additional alternative explanations.

REFERENCES

- CAVALLI-SFORZA, L. L. (1952). *Bull. Wld. Hlth. Org.*, **6**, 185.
CAVALLI-SFORZA, L. L., and LEDERBERG, J. (1953). *VI Int. Congr. Microbiol.*, p. 108.
CAVALLI-SFORZA, L. L., and LEDERBERG, J. (1956). *Genetics*, **41**, 367.
EAGLE, H. (1955). *Perspective and Horizons in Microbiology*, p. 168. Rutgers University Press.
LEDERBERG, J., and LEDERBERG, E. M. (1952). *J. Bact.*, **63**, 399.

DISCUSSION

Hinshelwood: This is a beautiful method with streptomycin, and I admire the experiment very much. But what level of chloramphenicol resistance can one get by the indirect method?

Cavalli-Sforza: The degree of resistance that was obtained in the work with Lederberg was perhaps two or three times the original level. You

cannot get in one step a high increase in resistance to chloramphenicol, and you must therefore work on what occurs in nature. In the case of chloramphenicol, in fact, some trouble was encountered and indirect selection took a little longer. The level of resistance of the particular mutant selected indirectly was such that it did not give 100 per cent survival with the concentration of the drug that would kill all of the sensitives, it gave only 12-20 per cent survival.

Hinshekwood: As regards chloramphenicol resistance, by means of growing mass cultures in different biochemical media (in different sugars, broth and synthetic medium and so on) we can change what may be called the natural level of resistance in the range from 10 to 20 or 30 parts per million; and in the same way resistance to proflavine and certain other drugs changes. On the other hand, the resistance can be raised to 800 or 1000 by the direct action of the drug, so it is a very low-grade resistance indeed which is selected in your experiment. There is a great contrast, in any case, between chloramphenicol and streptomycin where the degree of resistance rises abruptly after adaptation, by whatever means, to quite a low concentration of streptomycin.

We think that there is a distinction between types of resistance. We think, moreover, that streptomycin resistance may sometimes be due to the lack of the power of cells to take up the drug.

Cavalli-Sforza: I think that with chloramphenicol you have to work in those conditions, because you cannot get higher resistance in just one step. It is another genetic system. You have not got any single gene capable of giving high resistance at once. You could get higher resistance only by repeating the entire process of selection on first-step mutants, and so on.

Hinshekwood: Still, when mutants are selected up to a certain point in your environment, the further steps should be coming in quite freely.

Cavalli-Sforza: The later cycles of an indirect selection experiment may be easier than the first ones; but if not, you can change the method if you want to, for instance you could go over to replica plating.

Hinshekwood: You would not be inclined to entertain the idea that there are really two types of adaptation?

Cavalli-Sforza: What was done here was to test one hypothesis. The present method can only disprove the genetical hypothesis; if it does disprove it, it leaves the field open for the alternative one, but it has not done that.

Hinshekwood: Have these resistant cells obtained by the indirect method been tested for streptomycin adsorption? That would be a very interesting datum to have.

Cavalli-Sforza: I don't think they have been tested.

Dean: Would you consider, if you got no selection, that the genetical hypothesis is disproved for a particular drug and a particular organism? For instance, if one did an experiment with a certain drug and a certain organism and found no selection at all, would you consider that as disproving the genetical hypothesis?

Cavalli-Sforza: Of course; but you have to be very careful, in using indirect selection, about those shortcomings that I mentioned, for

instance that mutants have to multiply in competition with the wild type. This is not a gratuitous assumption, it is something which you can test directly; if the mutant multiplies much more slowly than the normal, then the method is difficult to apply.

Lederberg: A control is needed in such a case, i.e. an artificial reconstruction of a mutant which you know was produced; you then put it in with the wild type to show that you can select it under those conditions. If you then fail to obtain similar mutants without making artificial mixtures you can conclude that no mutants of that type are present in untreated cultures. I emphasize of that type, because this consideration of differential growth rate might still come in, but you would certainly have to stretch the genetical hypothesis quite far to get selection.

Yudkin: Prof. Cavalli-Sforza said that mutants would be expected necessarily to be at a disadvantage, compared with the natural types. When we are dealing with drugs like some of the antibiotics which may occur in nature, it is reasonable to suggest that the resistant mutants grow more slowly than the wild type, for otherwise the sensitive strains would have disappeared at some time. But when we are dealing with drugs like proflavine, which the bacteria are most unlikely to have encountered in nature, then there is no reason to suppose that the resistant mutants have a growth disadvantage.

Cavalli-Sforza: I don't think that the fact that the particular strain has had experience before of one particular drug is very important.

Any mutation that arises in an otherwise homogeneous population of cells has a fitness value relative to the normal type, which of course

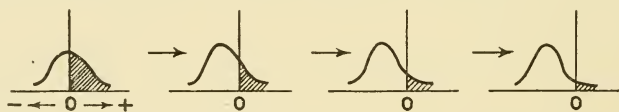

FIG. 1. (Cavalli-Sforza). An oversimplified picture of the process of genetic adaptation taking place automatically in a culture kept under fairly constant conditions, in terms of the distribution of fitness values of mutations arising in the population at various stages. It shows why most mutations are likely to be "unfavourable." The abscissa gives the fitness value of a mutation; the ordinate, the frequency of mutations having given fitness values. Arrows indicate the lapse of generations. The stippled area represents the proportion of mutations which are "favourable", i.e. have positive fitness; the white area the proportion of "unfavourable" ones.

depends on the specific environment considered. Different mutations will presumably show different fitness values; a few may have a fitness value of zero or nearly so (if we thus describe the absence of advantage or disadvantage in respect to the normal type, e.g. the mutant grows and dies at the same rate as the normal); others may have a positive fitness value (i.e. they are "favourable" mutations), and the rest a negative fitness value ("unfavourable" mutations) (Fig. 1)*. If a bacterial strain

* For greater clarity Fig. 1 was added in proof.

has had a long experience of growth in given conditions, such as normal laboratory media and transfer routine, which are fairly constant, it must have adapted genetically to it. Genetic adaptation by natural selection takes place automatically, in fact, and most of the favourable mutations must have been fixed by it, thus decreasing the proportion of favourable mutations available to the organism and increasing that of unfavourable mutations. Of course, the strain must have had time to adapt to the "usual" conditions, or in other words these must really be "usual"; therefore, the previous history of the strain may have some importance. On the other hand, the tendency of any new mutation to have a negative fitness value is not only a theoretical expectation; it is a fact, as for instance the data in the present paper have shown.

Davis: It seems to me that we are using the term "drug resistance" for two different concepts. When we say that one *strain* is more resistant than another we mean operationally the following: two families of cells are both grown under identical conditions and then identically tested to determine the concentration of drug that brings about a certain degree either of interference with growth or of active bactericidal action; and one family is found to require for this effect a higher concentration of drug than the other. But when we say one *cell* is more resistant than another we mean quite a different thing. If a number of cells are plated on a medium containing a borderline concentration of drug, some cells will die and others will give rise to colonies. We have a right to conclude that the ones that died were less resistant, by definition (i.e. if they would not have died in the absence of the drug). But we do not know that the more resistant survivors are more resistant in an inheritable way. They may be. They may also be simply those cells, in the inevitable range of physiological variation in a genetically homogeneous population, that happened to be able to withstand the borderline concentration of drug sufficiently to initiate colony formation. And, once initiated, the microcolony could so modify its environment as to ensure its continued growth.

No geneticist would deny that such physiological variations can affect the chance a cell has of resisting a borderline concentration of drug. Indeed, it would be safe to predict that one could shift the average level of such phenotypic resistance by varying the richness of the medium, the aeration, the stage in the history of the culture at which the organisms were harvested, etc. Furthermore, it seems inevitable that the surviving cell, in beginning to grow in the presence of the drug, would undergo further physiological changes in adaptive response to the presence of the drug; such adaptive changes not only might alter the susceptibility of the cell to the drug; they also should be passed on to the progeny as long as these progeny are grown in the presence of the drug. But such adaptive changes in resistance, in contrast to inheritable ones, would disappear after a suitable number of generations of growth in the absence of the drug.

While genetically orientated microbiologists have recognized the possibility of such adaptive influences on the resistance of a cell, they have not been much inclined to investigate the problem. I think Sir Cyril

Hinshelwood has performed a service in focussing on this interesting and neglected area of biology. However, the real rub comes in his claim that such reversible adaptive resistance, if carried through enough generations will gradually develop (by some process other than random mutation plus selection) into a stable, inheritable resistance. Most biologists would be sceptical about the existence of such gradual, non-mutational stabilization of an adaptation; and I feel that the experiments cited in support of this concept are all compatible with mutation and selection.

One further comment: as Sir Charles Harington pointed out in his introduction, the general interest in drug resistance and the *raison d'être* of this symposium have arisen from the practical importance of the problem. I would like to emphasize that the problem to which he refers is the emergence of *strains* with an inheritable increase in resistance. This is what is ordinarily meant by drug resistance. The problem of the adaptive and other non-inheritable physiological factors affecting the observed level of resistance of a cell is also interesting—but it is not the problem of drug resistance.

Pontecorvo: This last point which Prof. Davis has made is precisely the one I meant when I mentioned what has been done in higher organisms, particularly by Waddington. The experiment there is to expose embryos of flies to a certain concentration of drug at certain critical periods in development; a proportion of them develop into abnormal adults. Breeding is selective, i.e. only from the abnormal adults. After a few generations abnormal adults develop even without treatment or with a reduced one. In this case it is quite evident from the procedure of the experiment that what has happened is that there was initially, let us call it "physiological", variability: some individuals responded, some did not. A genetic mechanism which can be pin-pointed to particular regions of the chromosome set has taken over later on. That is precisely the transition from one mechanism to the other. It would be important to see whether this transition can or cannot be favoured by means other than selection by the stimulus; so far, I am not convinced that there has been any proof one way or the other.

Györfly: To raise a point concerning definition: we need to make a distinction between the terms "heritable" and "genetic"; they are not synonymous, and we must take care in using them, because "heritable" or "hereditary" means transmissible or transmitted from one generation to another; and "genetic" implies control by the genotype, by genes; and it is well known that all modifications are non-genetic changes. The "Dauermodifikationen", which very often occur in micro-organisms, are "inherited" through a number of generations although they are not genetic changes. Another complication is that each bacterial cell in itself represents one generation, and if it is modified as by environmental influence it may be "inherited" through a number of generations. That again is not a real genetic change. I wonder whether we really are able, in the usual experiments, to differentiate by the criterion of the term "heritable" between a genetic change and a Dauermodification. The term "heritable" seems to me somewhat ambiguous, and it will be better when we no longer use this term in microbial genetics but use instead

the word "genetic". Then we can make the distinction that the genetic change is controlled by the genotype.

Pontecorvo: We have, of course, an operational test in some cases. In *Esch. coli* we can use segregation and recombination, either by a sexual process or by transduction. In other organisms, for instance ascomycetes, we have the ordinary test of sexual reproduction and segregation as well as "parasexual" segregation, etc. So we can unequivocally distinguish in the majority of cases, even in micro-organisms, a genetic change from an inheritable change which is not genetically determined.

Davis: It seems to me that the science of genetics must be concerned with all mechanisms of inheritance, and not simply those involving chromosomal genes. Indeed, the term "gene" was surely derived from "genetics" and not *vice versa*. I therefore wonder whether it might not be useful to use the term "genetic" to include all mechanisms of indefinitely transmitted inheritance, both chromosomal and non-chromosomal, and to use the term "genic" for chromosomal mechanisms.

Kunicki-Goldfinger: One should be very careful when differentiating between genic mutation and physiological, more or less stable, change, especially if recombination analysis is not possible.

In this connexion some phenomena may be pointed out which are apparently due to mutation, but which are, in fact, caused by physiological changes in bacterial cells. In an *Esch. coli* population only a very small fraction of cells can grow in the presence of lithium chloride. Not more than 1 per 100,000 cells is capable of forming a colony on media containing lithium chloride. In the majority of strains these resistant forms are not stable and their progeny are as susceptible as the parental strain. Without analysis of population during growth the change may be interpreted as being due to the selection of pre-existing mutants. In reality it is caused by a physiological adaptation in a small fraction of the heterogeneous population.

The characteristic growth curve, which Prof. Cavalli-Sforza discussed, may also be due to selection of spontaneous mutants, or to overgrowing of the culture by a new physiological variant induced by the environmental conditions. This is the case in *Brucella* grown in synthetic medium. A growth curve with many peaks is then obtained. At least some variants, whose growth resulted in the formation of additional peaks, were shown to be of non-mutational origin. Some R-variants could be obtained from homogeneous S-populations in conditions excluding cell multiplication. In this case the majority of cells were transformed into a new type. If this change is not due to semi-stable physiological adaptation, it may be caused by total mutation of almost the whole population, induced by environmental factors, which seems to me less probable.

Hotchkiss: Prof. Davis has pointed out quite clearly what the conceptual disagreement is. I suggest we turn more to the experimental inconsistencies. Sir Cyril has mentioned that cultures selected in low concentrations of streptomycin would be resistant to high levels of streptomycin. I know that in many organisms one may find streptomycin resistance also; so I would like to know whether a low resistance is

found in the same situation; if not, I would be concerned about possible special selective features.

The other point is rather similar, related to the case of sugar fermentation—the inconsistency between the results of Hinshelwood and Dean and those of Lederberg and Pollock. I think the cultures that Lederberg and Pollock have been examining should have a complete round trip and return to Hinshelwood's laboratory and be observed under his conditions again. I would be very pleased, for instance, to see that cultures which they had submitted to some very brief processing would also show large colonies in your media, Sir Cyril, and if they did not, then one could infer that differences in your media have prevented you from seeing this selection in favour of the more rapidly growing or rapidly utilizing mutant.

GENETIC ASPECTS OF DRUG RESISTANCE

M. DEMEREC

*Carnegie Institution of Washington, Department of Genetics,
Cold Spring Harbor, New York*

IF the problem of origin of bacterial resistance to drugs had arisen recently, instead of about ten years ago, it would have been a relatively simple matter to plan appropriate experiments to elucidate the rôle played by genetic mechanisms in the development of such resistance. A decade ago, however, genetical research with bacteria was in a very early stage, and it was still an open question whether or not the hereditary mechanism operating in bacteria would prove to be the same as the mechanism that had been demonstrated in higher organisms, including fungi. Since then, ample evidence has been accumulated to justify the conclusion that the genetic mechanism in bacteria is similar to that in higher organisms. This conclusion is further strengthened by the results of studies made with bacterial viruses, which can be crossed more easily than bacteria. In such crosses, using easily distinguishable markers, one may identify classes of offspring representing the two recombinant types as well as the two parental types (Hershey, 1946; Hershey and Chase, 1951). Further analysis has shown that the proportions in which the four classes are represented agree with expectation based on Mendelian segregation (Visconti and Delbrück, 1953). Moreover, the results of experiments using several markers (Hershey and Rotman, 1948) reveal the existence of linkage relationships. Taken together, these findings indicate that the basic genetic process in bacterial viruses—the lowest living organisms known—is similar to that with which we were already familiar in all higher organisms. Thus it is reasonable to suppose that the basic genetic mechanism is the same in all living organisms, not excluding bacteria. This basic genetic

mechanism is vested in genes, which are component parts of threadlike structures known as chromosomes.

Since it is now a well established fact that in every organism genes carry the primary responsibility for transmission of all biological properties whose mode of inheritance has been investigated, and since bacterial resistance to drugs has all the characteristics of such properties, it is to be expected *a priori* that a genetic mechanism is responsible for the origin and transmission of resistance. It would be remarkable indeed if bacterial resistance did not conform with what appears to be a general biological rule. And the experimental evidence obtained by direct studies of resistance fully confirms the *a priori* expectation. Geneticists have directed a greater than ordinary effort towards this analysis, not only because in the beginning very few of the methods now available were at their disposal, but also because the problem was of considerable practical importance for purposes of regulating the clinical use of antibiotics, and therefore evidence adequate to convince non-geneticists as well as geneticists was called for. The results of their work fully support the conclusions reached, namely, that as a rule genes determine bacterial resistance to drugs, and that mutations in certain genes are responsible for its origin. Comprehensive reviews of the literature on microbial drug resistance have been published by Cavalli-Sforza and Lederberg (1953) and by Bryson and Szybalski (1955).

The most conclusive evidence of genic determination of resistance to drugs is the fact that in all genetic tests bacterial resistance has shown the same patterns of inheritance as other gene-determined characters studied. The tests have involved three different approaches: studies of the origin of resistant variants; studies of frequencies of spontaneous and induced mutations; and studies of transmission of resistance by crossing, by transformation and by transduction.

Origin of resistant variants

Much of the work has been directed toward distinguishing between two possible modes of origin of bacterial resistance:

(1) induction, either in non-genic or in genic components of the bacterial cell, by the drug used in treatment; (2) gene mutation, independent of the treatment, and subsequent selection of the mutants by the drug. The primary object of these studies has been to determine whether or not resistant variants appear spontaneously in a bacterial population and give rise to clones of resistant individuals, as would be expected if they originate by mutation but not if their origin were dependent upon non-genetic change of phenotype. Several methods have been used.

The first evidence of genic origin of resistance was obtained with *Staphylococcus aureus* and penicillin (Demerec, 1945), by means of the so-called fluctuation test developed by Luria and Delbrück (1943) in their studies of the origin of resistance to bacteriophages. The fluctuation test was later performed with several other bacteria and several other drugs (Oakberg and Luria, 1947; Demerec, 1948; Newcombe and Hawirko, 1949), with results that confirmed the genetic origin of resistance. Exceptions that have been reported (Eriksen, 1949; Welsch, 1952; Banic, 1954) are readily explainable (Cavalli-Sforza and Lederberg, 1953) in terms of the nature of the materials used or the techniques employed, and do not constitute evidence against the genetic origin of resistant variants. The fluctuation test allows quantitative predictions of the magnitude of any variance dependent upon mutation. By means of statistical models (Lea and Coulson, 1949; Armitage, 1952) it has been possible to predict the exact distribution and size of clones on the basis of the mutational theory.

A second method of testing the spontaneous origin of resistant variants is based on a technique devised by Newcombe (1949) for studies of phage resistance. Newcombe's technique compared the number of resistant colonies observed on plates to which phage had been added after the growth of microcolonies with the number observed on control plates on which the microcolonies had been dispersed by spreading just before the application of the phage. By the introduction of

membrane filters, upon which bacterial colonies could be transferred from one medium to another without disturbing their position, this technique was adapted for studies of drug resistance (Bornschein, Dittrich and Höhne, 1951; Dittrich, 1951).

A third method of testing the origin of resistant variants is the replica-plating method originated by Lederberg and Lederberg (1952), in which samples of colonies grown on an agar surface can be transferred to a drug-containing medium, without serious disturbance of their spatial arrangement, by stamping consecutive plates with a piece of sterile velveteen. With this method it has been possible to show the drug-independent origin of mutants resistant to streptomycin (Lederberg and Lederberg, 1952) and isoniazid (Bryson and Szybalski, 1952).

A fourth method, which like the replica-plating method permits "indirect" selection of resistant variants in the absence of the drug, was described recently by Cavalli-Sforza and Lederberg (1956), and its further application has been discussed by Cavalli-Sforza (this symposium, p. 30). It is carried out by making subcultures in liquid medium and choosing the "best" subcultures by testing samples on agar medium containing the drug. Using this method, Cavalli-Sforza and Lederberg have supplied additional evidence of the spontaneous origin of variants in *Escherichia coli* that are resistant to streptomycin or to chloramphenicol.

Mutability

Two features usually associated with bacterial resistance to streptomycin, namely, the appearance of highly resistant variants in a single step and the appearance of streptomycin-dependent variants, make it especially suitable for quantitative studies of the occurrence of changes from sensitivity to resistance or dependence, of reverse changes from dependence to sensitivity, and of changes from dependence to resistance. Such quantitative studies have been carried out extensively with *Esch. coli*. It has been found that whenever any such

change occurs it is transmitted to the offspring of the variant bacteria and behaves as a heritable characteristic. Observations of changes from sensitivity to resistance (Newcombe and Hawirko, 1949; Demerec, 1951) have indicated that they occur at a predictable rate (about 1×10^{-9} to 1×10^{-10} per bacterium per division) as is expected of changes due to gene mutations. Reverse changes from streptomycin dependence to non-dependence also occur spontaneously with a certain frequency, characteristic in each strain; and the frequency of occurrence can be increased by treatment with any agent that has been proved capable of inducing gene mutations in bacteria (Demerec, 1951; Demerec, Bertani and Flint, 1951). The frequency of occurrence of changes from dependence to non-dependence varies considerably among different dependent strains of separate origin. Similar variation has been detected with regard to the frequency of occurrence of changes from sensitivity to resistance and dependence among sensitive strains derived from dependent strains by isolation of sensitive variants (Demerec, 1950). These patterns of behaviour are analogous to those observed in genetic analyses of spontaneous and induced mutability in several genes concerned with biochemical reaction in *Esch. coli* (Demerec, 1953), *Salmonella typhimurium* (Hartman, 1956) and *Neurospora crassa* (Giles, 1951), which studies have shown that each gene as well as each allele of a gene has its own characteristic mutation rate.

Another way in which the determinant of streptomycin resistance acts like a gene is evidenced by studies of a mutator factor in *Esch. coli* (Treffers, Spinelli and Belser, 1954; Treffers *et al.*, 1956). This factor, whose location on the chromosome has been determined (Skaar, 1956), affects the stability of the genome by increasing the rates of mutation of individual genes. Similar factors have been identified in *Drosophila* (Demerec, 1937; Plough and Holthausen, 1937), and in maize (McClintock, 1951). It has been found that this mutator factor in *Esch. coli* has the same general effect on the determinant of streptomycin resistance as on the other

genetic markers with which it has been tested; in other words, in this respect also streptomycin resistance behaves as a gene-determined character.

Thus the most reasonable conclusion to be reached from quantitative studies of resistance to streptomycin is that a genic mechanism is responsible for its origin and nature. It would be difficult indeed to visualize an adaptive mechanism that would account for the complex and at the same time precise patterns of action revealed by the genetical studies. The predictability with which changes from dependence to non-dependence occur, and the ease with which they can be observed experimentally, have made it possible to utilize this property in developing one of the most efficient methods now available for the study of induced mutability, and particularly for the detection of mutagenicity among various chemicals (Demerec, Bertani and Flint, 1951).

Mendelian analysis

Although there is very little doubt at present that the basic genetic mechanism in bacteria is similar to that operating in higher organisms, bacteria as a group are still notoriously unsuited to simple Mendelian analysis—which continues to be regarded by many as the only source of indisputable evidence of genic inheritance of characters. It seems to me that at the present stage of our knowledge about genes and their action we can afford, in cases where segregation tests cannot be carried out because of a lack of suitable techniques, to accept the results of analysis by other, more recently developed methods.

Evidence about drug resistance obtained by the recombination method, which closely approaches standard Mendelian tests, supports the conclusion that in the bacteria studied by this method a genetic mechanism is responsible for resistance. The recombination method has been used to analyse high resistance to and dependence on streptomycin in strain K 12 of *Esch. coli*. The results indicate that a single gene locus is involved in the transmission of both resistance

and dependence (Demerec, 1950; Newcombe and Nyholm, 1950), and that a linkage relationship exists between streptomycin resistance and a methionine marker (Lederberg *et al.*, 1952). Other studies made with the K 12 strain have shown that any one of several gene loci—four or five at least—may be responsible for the inheritance of a low degree of resistance to chloramphenicol (Cavalli and Maccacaro, 1950, 1952). It has also been established that one gene locus is responsible for a low degree of resistance to azide, and that it is closely linked with the locus controlling resistance to bacteriophage T1 (Lederberg, 1947). In this case, further experiments using the two linked markers have demonstrated segregation conforming to Mendelian expectation (Cavalli, 1952). Work done by several investigators has shown that the genes governing resistance to certain drugs (streptomycin and azide), as well as those involved in resistance to some phages, are distributed more or less indiscriminately among other gene loci; and there is no reason, at least from their positions on the chromosome, to assume that they are in any way exceptional as compared with other bacterial genes.

Transformation and transduction analyses

Two unique mechanisms have been discovered whereby genetic properties—presumably conveyed in genes or chromosomal fragments—may be transferred from one bacterial strain to another. In transformation, the transfer is accomplished by deoxyribonucleic acid (DNA) extracted from donor cells and brought into contact with the recipient bacteria, whereas in transduction phage particles act as vectors. Genetic markers that have been used successfully in transformation experiments include resistance to penicillin, streptomycin, and sulpha drugs (Hotchkiss, 1951; Alexander and Leidy, 1953); and transduction has been used to study streptomycin resistance (Zinder and Lederberg, 1952; Baron, Formal and Spilman, 1953; Iseki and Sakai, 1954). Thus, in this respect also, drug resistance corresponds to other properties that are controlled by genes.

Discussion

Experimental evidence shows that resistance to drugs originates in discrete steps, and that a high degree of resistance may either be built up through successive changes or be attained in a one-step change. The pattern followed is characteristic of the drug. Two patterns have been recognized: the "penicillin" pattern, in which high resistance is reached only through multi-step changes; and the "streptomycin" pattern, in which high resistance may arise either by multiple steps or in a single step (Demerec, 1948). Recombination, transformation, and transduction analyses all show that the transmission of each successive degree of multi-step resistance is distinct and independent—as required by genetical theory—and leave no room for theories involving the blending inheritance that would result from adaptive changes.

One argument that has been advanced in favour of adaptive change is based on the observation that bacteria exhibiting higher resistance than the original strain can readily be obtained from cultures grown in medium containing a drug in low concentration, where all the bacteria survive. It is reasoned that in such cases the drug has no opportunity to select resistant mutants that might already have been present in the culture, and therefore that the observed increase in resistance results from adaptive changes. However, detailed studies in which *Esch. coli* was grown in low concentrations of streptomycin have shown that even under these conditions the presence of the drug gives an advantage to resistant variants, which most likely originate as mutants during the previous growth of the bacteria used in the experiments (Demerec *et al.*, 1950). In the most critical portion of this study, aliquots containing about one hundred bacteria were plated onto a series of broth agar plates, half containing one $\mu\text{g.}$ of streptomycin per ml., and the other half—used as controls—containing no streptomycin. After 24 hours of incubation the numbers of colonies appearing on the experimental and on the control plates were about equal, indicating that the presence of streptomycin had not affected survival

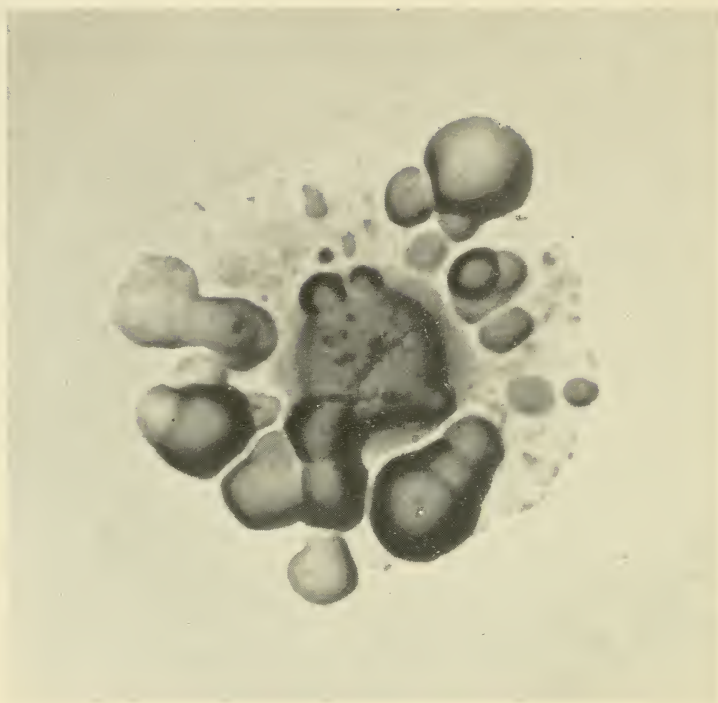

FIG. 1. Magnified photograph of an *Esch. coli* colony grown on broth-agar medium containing 1 μ g. of streptomycin per ml. and incubated at 37° for 48 hours. Note the light background region of bacterial growth with a number of faster-growing secondary colonies on top of it. Bacteria from these secondary colonies are more resistant to streptomycin than bacteria taken from the background region.

of the plated bacteria. The colonies on the streptomycin plates, however, were smaller than those on the plates lacking streptomycin. After an additional 24 hours of incubation their size increased, and their shape became irregular because of the growth of secondary colonies. Microscopic examination revealed that each was composed of a thin base of background growth with several fast-growing secondary colonies on top of it (Fig. 1). Bacteria taken from the secondary colonies exhibited higher resistance to streptomycin than bacteria taken from the light background region. Thus it is evident that, even at low concentrations of the drug, resistance does not develop adaptively but originates through an abrupt and discrete change, and that the drug acts as a selective agent by favouring the growth of resistant variants.

As a rule, a bacterium that becomes resistant to one drug still remains sensitive to others, which is consistent with the assumption that mutations in different genes are responsible for resistance to different drugs, and with the prevailing view of geneticists that a gene mutation affects primarily one biochemical reaction. One would expect the spontaneous occurrence of multiply resistant mutants to be very rare, since in general the probability of double mutation is equal to the product of the individual mutation rates of the two genes involved. Experimental tests of that expectation were made by Szybalski and Bryson (1953), working with resistance to isoniazid and sodium *p*-aminosalicylate (PAS) in *Bacillus megaterium*. The high mutation rates in this organism and the single-step development of resistance to those drugs, without the production of intermediately resistant variants, made the experimental determination of rate of mutation to double resistance technically feasible. The rate of mutation to isoniazid resistance was found to be $6(\pm 1.5) \times 10^{-5}$, that to PAS resistance $1(\pm 0.3) \times 10^{-6}$, and that to double resistance $8(\pm 1.8) \times 10^{-10}$. Thus the observed rate of mutation to double resistance, although statistically higher than predicted, falls well within one order of magnitude of expectation. It is very likely that a better agreement between the observed and

the calculated values might be obtained if the formula for calculating probabilities could take into account the variability due to several biological factors of which geneticists are well aware.

As a logical consequence of the genetic concept of the origin of bacterial resistance, multiple chemotherapy was suggested by geneticists as the most effective means of preventing the development of resistant pathogens. Its successful clinical use provides good confirmation of the validity of the assumption that gene mutations play the most important rôle in the origin of resistant variants.

Very little is known yet about the chemical structure of genes, but it has been convincingly demonstrated that they are not protein molecules and thus cannot be enzymes. Evidence is rapidly accumulating, however, to indicate that each gene controls one enzymic reaction—in other words, that there is an intimate relationship between genes and enzymes. This constitutes a common ground for agreement between those geneticists who judge that change in a certain gene is responsible for a particular resistance and those biochemists who consider that resistance is the result of modification in a certain enzymic reaction. The striking difference between the two groups lies in their interpretation of the nature of this change—the geneticists concluding that it is brought about by gene mutation, independent of the presence or absence of a drug, whereas the biochemists believe that it develops gradually under the influence of the drug. Even here, however, there is a certain degree of concurrence between the two groups, since neither denies the possibility that both kinds of mechanism may operate. Nevertheless, geneticists have ample experimental evidence to justify the conclusion that a mechanism involving gradual adaptation must play only a minor rôle, if any, in the development of resistant strains.

Summary

During the past decade much time and effort have been devoted to examination of the rôle played by genetic mechanisms in the origin of bacterial resistance to various drugs.

When the problem of bacterial resistance first arose, the background of information about genetic mechanisms in microorganisms, and particularly in bacteria, was still very meagre; consequently the genetical analysis of such resistance proceeded slowly and encountered a number of difficulties that would not be met with at the present stage of our knowledge.

The accumulated evidence is ample to show that drug resistance follows a pattern to be expected of characters determined by genes. This evidence is derived from statistical analyses of the mode of origin of bacterial resistance; from genetical studies of recombination between different grades of resistance, and also between resistance and other genetic characters; from studies of the transfer of genetic characters, including resistance, from one bacterium to another by transformation and transduction techniques; and from studies of spontaneous mutability and of mutability induced by various mutagens and by a mutator factor.

None of this evidence excludes the possibility that extragenic mechanisms, in addition to genic mechanisms, may operate in the development of drug resistance. However, if we can assume that the findings made regarding numerous other bacterial properties hold true for resistance as well, it can reasonably be inferred that the rôle of extragenic factors is a minor one.

REFERENCES

- ALEXANDER, H. E., and LEIDY, G. (1953). *J. exp. Med.*, **97**, 17.
ARMITAGE, P. (1952). *J. R. statist. Soc.*, B, **14**, 1.
BANIC, S. (1954). *Schweiz. Z. allg. Path.*, **17**, 183.
BARON, L. S., FORMAL, S. B., and SPILMAN, W. (1953). *Proc. Soc. exp. Biol.*, N.Y., **83**, 292.
BORNSCHEIN, H., DITTRICH, W., and HÖHNE, G. (1951). *Naturwissenschaften*, **38**, 383.
BRYSON, V., and SZYBALSKI, W. (1952). *Science*, **116**, 45.
BRYSON, V., and SZYBALSKI, W. (1955). *Advanc. Genet.*, **7**, 1.
CAVALLI, L. L. (1952). *Bull. World Hlth. Org.*, **6**, 185.
CAVALLI-SFORZA, L. L., and LEDERBERG, J. (1953). *VI Int. Congr. Microbiol.*, p. 108.
CAVALLI-SFORZA, L. L., and LEDERBERG, J. (1956). *Genetics*, **41**, 367.
CAVALLI, L. L., and MACCACARO, G. A. (1950). *Nature, Lond.*, **166**, 991.
CAVALLI, L. L., and MACCACARO, G. A. (1952). *Heredity*, **6**, 311.

- DEMEREC, M. (1937). *Genetics*, **22**, 469.
- DEMEREC, M. (1945). *Proc. nat. Acad. Sci., Wash.*, **31**, 16.
- DEMEREC, M. (1948). *J. Bact.*, **56**, 63.
- DEMEREC, M. (1950). *Amer. Nat.*, **84**, 5.
- DEMEREC, M. (1951). *Genetics*, **36**, 585.
- DEMEREC, M. (1953). *Symp. Soc. exp. Biol.*, **7**, 43.
- DEMEREC, M., BERTANI, G., and FLINT, J. (1951). *Amer. Nat.*, **75**, 119.
- DEMEREC, M., WITKIN, E. M., CATLIN, B. W., FLINT, J., BELSER, W. L., DISSOSWAY, C., KENNEDY, F. L., MEYER, N. C., and SCHWARTZ, A. (1950). *Yearb. Carneg. Instn.*, **49**, 149.
- DITTRICH, W. (1951). *Experientia*, **7**, 431.
- ERIKSEN, K. R. (1949). *Acta path. microbiol. scand.*, **26**, 269.
- GILES, N. H. (1951). *Cold Spr. Harb. Symp. quant. Biol.*, **16**, 283.
- HARTMAN, Z. (1956). *Carnegie Inst. Wash. Publ.*, **612**, 107.
- HERSHEY, A. D. (1946). *Cold Spr. Harb. Symp. quant. Biol.*, **11**, 67.
- HERSHEY, A. D., and CHASE, M. (1951). *Cold Spr. Harb. Symp. quant. Biol.*, **16**, 471.
- HERSHEY, A. D., and ROTMAN, R. (1948). *Proc. nat. Acad. Sci., Wash.*, **34**, 89.
- HOTCHKISS, R. D. (1951). *Cold Spr. Harb. Symp. quant. Biol.*, **16**, 457.
- ISEKI, S., and SAKAI, T. (1954). *Proc. Japan Acad.*, **30**, 143.
- LEA, D. E., and COULSON, C. A. (1949). *J. Genet.*, **49**, 264.
- LEDERBERG, J. (1947). *Genetics*, **32**, 505.
- LEDERBERG, J., and LEDERBERG, E. M. (1952). *J. Bact.*, **63**, 399.
- LEDERBERG, J., LEDERBERG, E. M., ZINDER, N. D., and LIVELY, E. R. (1952). *Cold Spr. Harb. Symp. quant. Biol.*, **16**, 413.
- LURIA, S. E., and DELBRÜCK, M. (1943). *Genetics*, **28**, 491.
- MCCLINTOCK, B. (1951). *Cold Spr. Harb. Symp. quant. Biol.*, **16**, 13.
- NEWCOMBE, H. B. (1949). *Nature, Lond.*, **164**, 150.
- NEWCOMBE, H. B., and HAWIRKO, R. (1949). *J. Bact.*, **57**, 565.
- NEWCOMBE, H. B., and NYHOLM, M. H. (1950). *Genetics*, **35**, 603.
- OAKBERG, E. F., and LURIA, S. E. (1947). *Genetics*, **32**, 249.
- PLOUGH, H. H., and HOLTHAUSEN, C. F. (1937). *Amer. Nat.*, **71**, 185.
- SKAAR, P. D. (1956). *Proc. nat. Acad. Sci., Wash.*, **42**, 245.
- SZYBALSKI, W., and BRYSON, V. (1953). *J. Bact.*, **66**, 468.
- TREFFERS, H. P., ALEXANDER, D. C., THANASSI, F., and BONNER, D. M. (1956). *Microbial Genetics Bull.*, **13**, 35.
- TREFFERS, H. P., SPINELLI, V., and BELSER, N. O. (1954). *Proc. nat. Acad. Sci., Wash.*, **40**, 1064.
- VISCONTI, N., and DELBRÜCK, M. (1953). *Genetics*, **38**, 5.
- WELSCH, M. (1952). *Bull. World Hlth. Org.*, **6**, 173.
- ZINDER, N. D., and LEDERBERG, J. (1952). *J. Bact.*, **64**, 679.

DISCUSSION

Walker: Dr. Demerec said that the development of drug resistance takes place quite abruptly. The point of view I would like to suggest for discussion is this: if we have a template upon which genic material is being replicated, and the genic material is assembled and peels off as

it is formed, it comes to a point where the block takes place by the drug; if that is at a very late stage in the formation of the genic material this can split off and convey information for subsequent replication, but is incomplete in so far as the whole information is not available for subsequent replication. In subsequent replication the drug does not enter into the picture at all. That explains why one can get resistance forming in one generation and also quite abruptly. There may be many flaws in that picture, and I am putting it forward only as a basis for discussion: that it may be the means whereby the information can be transmitted for subsequent formation of genic material which is not affected by the drug.

Lederberg: This model is one of a number of formal schemes which can be elaborated to explain the fact that the initial genetic changes (if they arose) were being produced by the drug. I think that if we had many examples where we could unambiguously show that these initial "catastrophes" were produced by the drug, we would then avidly seek details of the models in which they would exist. But I think the whole point we have been discussing is not the ways in which this might happen, if it happened, but whether it happens at all. Prof. Cavalli-Sforza, for example, has shown that we can get these alterations in the copies of the template which occur without the drug ever having been present in those cells. I know there will not be unanimous agreement on this; there will be those here who will continue to insist that there are local effects which are in fact induced by the drug, but I don't think even that is Prof. Hinshelwood's model of what is going on, and he has a rather more subtle understanding of the inductive effects that might come into play. We may come to a time when we know just what reagent to use, when we can create specific blocks in replication of particular genes in the genetic material, but so far we have not found such reagents.

Hotchkiss: It should require a high degree of specificity indeed, to cause a block at one particular unit, when all of it seems to be made of DNA in which the chemist can as yet discern no specificity except that implied in the genic action.

Alexander: I wonder whether Dr. Demerec's point that he finds this sharp distinction is as decisive as it seems (between bacteria which have mutated and those which have not). The time interval in bacterial development is so short that it might be possible that this is a directed mutation, directed by the physiological state of the cell. There may be some similarity in the carcinogenic process, because once a tumour cell has been produced this is a clear case of mutation, yet there is a long interval in which we have to produce an unnatural physiological condition in the animal before this occurs; in some cases this is done with chemicals which are mutagens. But the most decisive proof that a mutagen is not always necessary comes from the experiments by the Oppenheimers, who found that the introduction of an unnatural environment, namely a thin film of any sort, will eventually after a year or so create the condition where tumour cells grow. So there one can make a good case that the mutation which has given rise to the tumour cell has come as a response to an unnatural physiological environment. The same situation might also arise in bacteria, but since cell division and

bacterial growth is so quick, one may not detect this intermediate stage by the methods used. One may only detect the end-effect when the final mutational response to the changed environment has already taken place. If the time interval could be narrowed within division times, one might then find a gradual adaptation finishing eventually in a mutation.

Demerec: The evidence accumulated by geneticists working with various organisms indicates that, as a rule, mutations produce discrete rather than gradual effects; and the findings of research with antibiotics conform with this general picture.

The experiment discussed in my presentation was not designed to show whether or not the drug, in this case streptomycin, induces mutation. It was designed to show that resistance to a low concentration of the drug develops in discrete steps. The critical experiments, as mentioned by Lederberg, in studying whether mutation to resistance originates independently of the drug, are those where the drug has not been used, such as the experiment which was discussed by Cavalli-Sforza this morning, and also a replica plating experiment which was done by Lederberg.

Yudkin: Dr. Demerec, I think we all agree that what you have shown once more is that genetic changes do occur. I don't think that either of the two examples mentioned prove that induction or adaptation did not occur, and I suggest that e.g. the outgrowth of resistant papillae or parts of a colony may indeed have occurred through induction between the drug and some of the bacteria which, when they become resistant, obviously grow much faster.

Another argument used in favour of drug resistance originating only through genetic change is the chemotherapeutic one, i.e. the use of a combination of drugs is much more effective than the use of the drugs singly. And surely Sir Cyril would say that for a bacterium to become adapted to a combination of drugs must be very much more difficult than for it to become adapted to a single drug.

Davis: I would question Dr. Alexander's statement that cancer is clearly caused by mutation. I would agree that a cancer results from inheritable change in a somatic cell; but the inheritable properties of somatic cells, after all, are determined in part by the process of differentiation, and in this process something in the environment directs gradual changes that are inheritable. It would therefore seem reasonable to consider the gradual process of carcinogenesis as an aberration of differentiation.

As Dr. Pontecorvo pointed out, geneticists would not deny the possibility that the environment can direct an inheritable change, for they would then be denying the process of differentiation. Unfortunately, our understanding of differentiation is very primitive compared with our understanding of gene mutations. It has long been hoped that unicellular organisms would be helpful, since it is in principle quite conceivable that one could find chemical or physical agents that would cause such directed inheritable changes in these organisms. However, few cases that fit this category have been observed, and none in bacteria. The burden of proof still rests on those who would claim that drug

resistance, or any other inheritable change in bacteria, can be brought about through a directive environmental influence.

Pontecorvo: Those changes, of any type, that we are actually able to demonstrate as genetic are of course a very selective sample. Any change which is either not big enough or not sharp enough or perhaps too much subject to environmental variation cannot be tested; at least it is very difficult to subject such changes to the test of segregation, which is the only one that we can use for an unquestionable distinction.

Hinshelwood: Dr. Demerec, what is your opinion about the fact that the sensitive cells had grown before the ones that you termed resistant?

Demerec: The reason is that we used a very low concentration of streptomycin, a concentration that did not kill any of the bacteria plated on it, as I have shown by comparing the numbers of colonies obtained on plates containing streptomycin and on control plates without it. Therefore, the sensitive bacteria were able to divide, but they divided slowly and formed a very thin layer of growth. We assume that during those divisions mutants appeared which were better adapted to growth on a medium containing this low concentration of streptomycin, and that thus we had the secondary colonies originating.

Hinshelwood: We have done experiments on the crossing of yeasts and examined the galactose fermentation, and we got clearcut Mendelian phenomena, superimposed on which there were adaptive developments of the segregated characters themselves, so that both adaptive and clearcut Mendelian phenomena were present in the same system. We have also done experiments on the crossing of bacterial strains of certain drug-resistant cells and got an almost continuous spectrum of resistance between the levels of the parents. This may, of course, be ascribed to the fact that the mutation steps are very small, but even so it is hard to regard the result as evidence of a sharp segregation. However, in reference to Dr. Demerec's opening remarks, who has ever said that in sexual recombination or in the segregation phenomena of Mendel there was other than transmission of basic material and information? And who would ever have thought of attributing sexual recombination and segregation to adaptation? I have never heard of anybody who would do it.

Demerec: I agree with you. Fortunately, there is no serious disagreement at present about the mechanism of Mendelian inheritance. Unfortunately, however, until very recently we did not know about sexual recombination in bacteria. And when our first reports on genetic research with bacteria were published, the question was raised by bacteriologists and geneticists: Have bacteria a genetic mechanism similar to that found in higher organisms? Proof of the existence of such a mechanism came only recently.

Lederberg: In any experiment where bacteria grow in the presence of a drug it is possible to attribute special significance to this and to say that perhaps the drug played some rôle in inducing and fixing mutation. That type of discussion was quite profitable ten years ago. At the present time we have a number of sharply delineated cases where, on the one hand, we can demonstrate the occurrence of structural changes leading to resistance in the absence of the drug, and these are mutations; on the

other hand, we have a much smaller sample, but nevertheless a few quite unambiguous cases, of kinetic changes in enzyme balance which are sufficiently self-regenerative so that they fit into the type of picture that Prof. Hinshelwood elaborated. Therefore, there is no need to argue any further as to the fact that these mechanisms do exist. If there is any point in the controversy, it is: What happens in this specific situation, what happens in the next specific situation? I suggest that if we are going into details of experiments, we decide beforehand that there will be two or three chosen as exemplifying the type of analysis that must be done, and then we can concentrate on trying to see to what extent mutational occurrence has been ruled out in any one case; to what extent have directed adapted changes (which may have more or less permanence) been ruled out or ruled in. But to say that something might have happened here and something else there is no longer the point since we have mutual agreement of examples of both extreme types of behaviour.

Yudkin: We are really having this discussion on two levels. Dr. Pontecorvo said that we are agreed—and I wish we were—that we accept that these two phenomena which are most under discussion can occur. What I am a little concerned about is that from time to time we read that “It has now been proved” that mechanism A has occurred and that therefore we may assume that mechanism B does not.

Slonimski: It cannot be said that mechanism A has been proved; all that one can say is that mechanism B has been disproved. On logical grounds a hypothesis can only be disproved, but not proved.

Yudkin: I take exactly the opposite view: I think nothing has been disproved, but certain things have been proved.

Pollock: I agree with Prof. Yudkin’s last remark. I do not know of anyone who has denied the existence of so-called spontaneous mutations appearing in certain cases, but I am not so sure about examples of induced heritable adaptive changes.

Lederberg: Novick has been carrying the two states of lactase formation in *Esch. coli* for what could be considered to be an indefinite number—many hundreds—of generations.

Pollock: I feel fairly certain that they do exist, but if we are going to adopt your suggestion of taking a few isolated examples, then it is important to find one which we can get to grips with on the adaptation side.

Lederberg: The one that has satisfied me without any doubt that there can be such a mechanism is the one that Cohn and Novick showed. That one can be carried on indefinitely.

Davis: Dr. Demerec has pointed out that in the presence of a concentration of streptomycin that did not kill the cells, but allowed them to grow extremely slowly, after a while resistant mutants appeared. In trying to decide whether the amount of background growth would be sufficient to account for the number of resistant clones, it might be important to take into account some work reported by Novick and Szilard a few years ago. It is generally assumed that the rate of appearance of a given mutation in a given strain has a fixed value per generation.

However, when these investigators varied the growth rate by controlling the supply of a required amino acid, they found that the mutation rate remained constant per unit time rather than per generation. Thus, when an organism was growing at one-twelfth its normal rate it produced twelve times as many phage-resistant mutants per generation as when growing at the full rate. I don't know that anyone has carried out parallel experiments on the effect of slowing growth inhibitors, but this work raises an interesting possibility; when we are dealing with borderline drug concentrations that slow growth but do not kill the organisms, mutation rates per generation may be very much higher than what we are accustomed to.

INHERITANCE IN SINGLE BACTERIAL CELLS

W. HOWARD HUGHES

Wright-Fleming Institute of Microbiology, St. Mary's Hospital, London

WHEN Demerec (1948) presented his views on stepwise mutations he stimulated a number of independent workers to challenge them (Hughes, 1952; Eagle, Fleischman and Levy, 1952; Mayr-Harting, 1955). While agreeing with the general

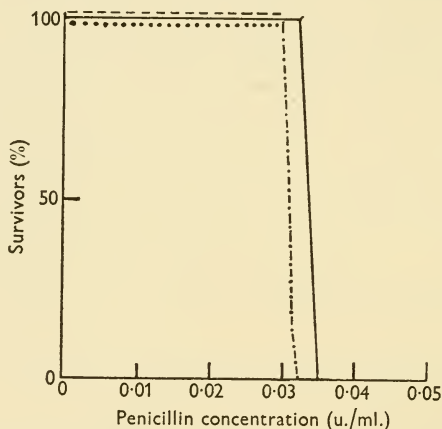

FIG. 1. Titration of sensitivity of single-cell strains of staphylococci using small implants. Key to curves: ---, parent strain; ·····, single-cell strain I; ·-·-·, single-cell strain II. Parent strain and strain I give a value of 0.0325 u./ml. for 0% survivors. Strain II gives a value of 0.035 u./ml. under identical conditions. (Hughes, W. H. (1952), *J. gen. Microbiol.*, 6, 175.)

picture of the emergence of resistance as he painted it, the present author objected to his conclusions that there were clearcut steps in the process, believing the steps might be artifacts imposed by the limitations of titration methods generally. It seemed that only by working throughout with single cell isolates or by maintaining a continuous photographic observation would it be possible to settle this question

to the satisfaction of other workers who had a bias in favour either of adaptation or of major mutation as the basis for bacterial variation.

If single cells are cultured and from the clone further single cells are selected these will differ from one another in antibiotic sensitivity (Fig. 1). The differences here are so small

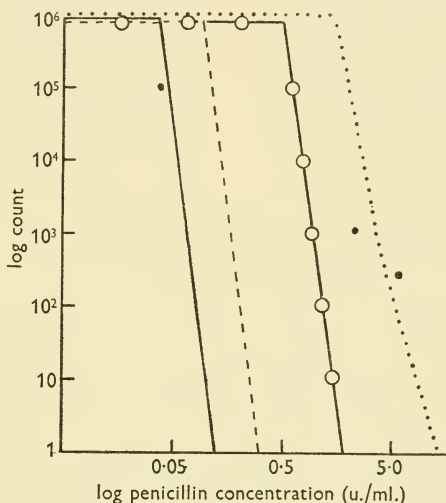

FIG. 2. Results of tube titration of sensitivity of single-cell strains of staphylococci. Key to curves: —, strain I; ---, strain VIa; —○—, strain XXXa;, strain XXXIa. The four subcultures show a similar distribution of sensitivity, although the average sensitivity of each is at a different level. Each curve on this is built up from 11 separate points, the only 3 points not falling on their line are marked ●. (Hughes, W. H. (1952), *J. gen. Microbiol.*, 6, 175.)

that had the titration not been repeated on several occasions with different batches of penicillin over intervals of many months the author would not have been convinced that they were not due purely to experimental error.

If now from the tail of the population the more resistant cells are picked, new populations with increased resistance are obtained. Fig. 2 shows the stages of the investigation. It will be seen that the increase is fairly steady. This impression can be misleading since only the most resistant population is

drawn. If five or six single cells were picked the individual populations derived from them would vary, occasionally being more sensitive than the parent but usually being intermediate between the parent and this most extreme example. The apparent increase in resistance by even steps is here due to selection having been made and is not an expression of any law of variation.

Cavalli-Sforza saw these results before they were completed and pointed out that the pattern was that of a normally distributed population curve rather than that of mutation as ordinarily understood (Cavalli-Sforza, personal communication). It should be noticed that the sensitive moiety of the population is killed off by the methods used and that there is no evidence from this type of experiment of cells more sensitive than the parent.

Yudkin considered this type of experiment on antibiotics and his own work with flavin, and advanced his theory of resistance (Yudkin, 1953). This is still the most likely explanation of the work of the present author, and of that of Eagle and his associates. No subsequent experiments have thrown any serious doubt on it.

Yudkin's theory postulates that when a cell divides, the daughter cells will be unlike each other and unlike the parent cell. Support for this hypothesis was provided by studies of the behaviour of a strain of *Escherichia coli* B when grown under conditions of diminished oxygen supply (Figs. 3-5). The long organism was produced at the first division of the parent cell, the sister cell gave a normal colony. This inability to divide is frequently seen in fresh isolates of most rod-shaped organisms. If these long cells are selected and sub-cultured in broth and then a fresh test is made it will be found that they form an increasingly large proportion of the entire culture and strains can be bred composed of cells all of which are sensitive to the environment. With this phenomenon in mind the reactions of bacteria to antibiotics can be reconsidered.*

* A film that illustrates and contrasts the action of penicillin and of a wide spectrum antibiotic, in this case chloramphenicol, was shown at this point, and can be obtained from the Photographic Department, St. Mary's Hospital, London.



FIGS. 3-5. Development of the mixed colony from a single organism. Fig. 3. Stage of third division. Fig. 4. Stage of fifth division. Fig. 5. Stage of seventh division. The solitary L-form is now vacuolated. (Hughes, W. H. (1953), *J. gen. Microbiol.*, 8, 307.)



FIG. 6. Differences in related single cells. (Hughes, W. H. (1955*b*), *J. gen. Microbiol.*, **12**, 269.)

Now taking the action of penicillin first, Fig. 6 shows a group of organisms transferred to penicillin-agar. Just as the morphological effect of the drug varies with concentration, so if the concentration is kept constant individual cells in a culture will be influenced differently. The cell on the right of

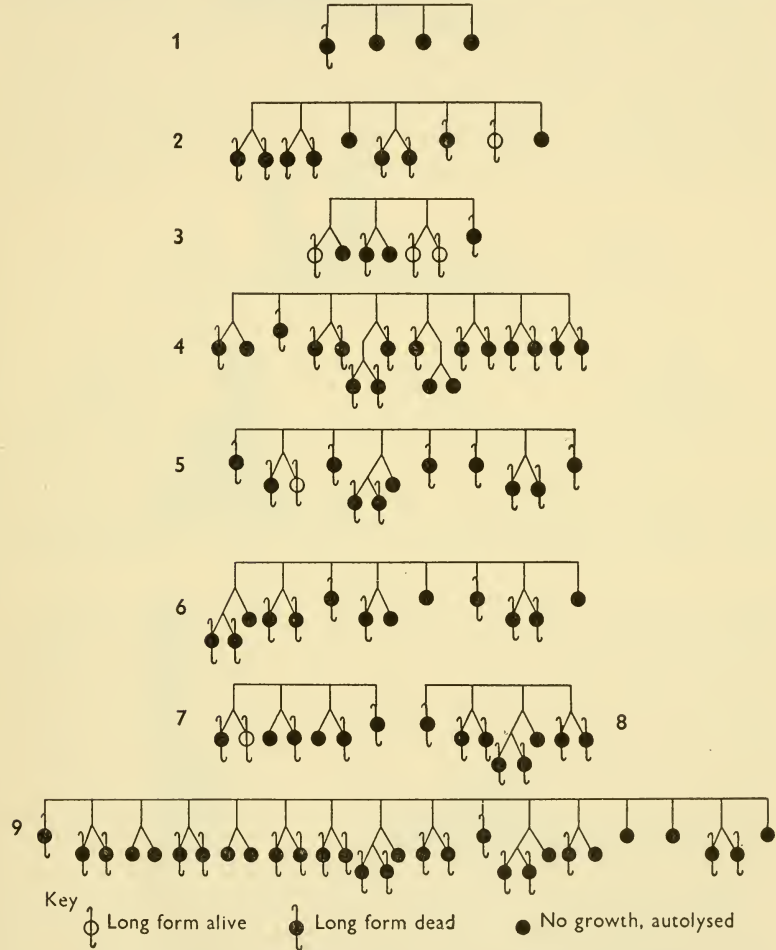

FIG. 7. The effect of 10 u. penicillin/ml. on the individual cells of nine microcultures, grown from nine members of a clone of sixteen cells. (Hughes W. H. (1955b), *J. gen. Microbiol.*, 12, 269.)

Fig. 6 is already dead and lysis is occurring; that at the top is inhibited for division but not for growth and on transfer to penicillinase-agar might recover; the group on the left is dividing. By using the morphological changes and tests for viability to assess the effect on the individual cell it is possible to build up a kind of family tree of resistance and sensitivity. A single cell is taken and allowed to divide to give a colony of from 4 to 16 individuals. These are transferred separately to penicillin-agar and their fate followed for a fixed period of time, anything from 3–5 hours is suitable. At the end of this time all cells which have not autolysed are transferred to penicillinase

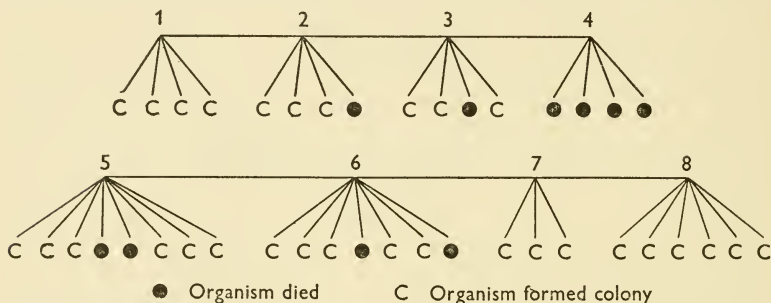

FIG. 8. Diagram showing fate of eight microcolonies derived from the same single cell when plated out on 7.5 u. penicillin/ml. agar. (Hughes, W. H. (1955b), *J. gen. Microbiol.*, **12**, 269.)

broth and their viability tested. Fig. 7 shows typical results. Cell 3 gives among its descendants almost all variations. Cell 1, on the other hand, gives a uniformly sensitive group. This strain in the presence of penicillin gives daughter cells which differ from one another in resistance (Hughes, 1955b). Fig. 8 shows a complete population exposed and tested for viability.

The selection of sensitive populations as well as of resistant ones from the small cell was first done on spontaneous characters in *Esch. coli* B (Hughes, 1955a). It was noticed that in a strain repeatedly subcultured from single cells the growth rate of microcolonies still varied. The difference between slow and quick growing colonies was shown before there was any depletion of nutrients in the medium. Fig. 9 shows the

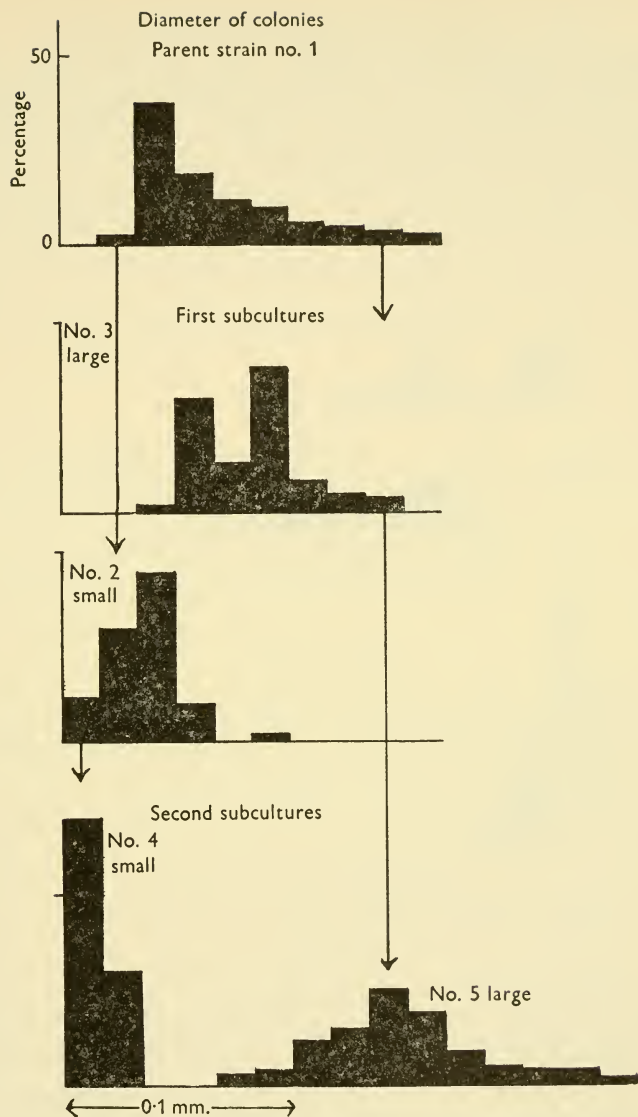

FIG. 9. Histogram showing rates of growth of colonies from single cells of *Escherichia coli* grown under anaerobic conditions. Measurements of colony diameter made after 3 hr. incubation at 37°. Re-selection of the subcultures indicated by arrows. (Hughes, W. H. (1955a), *J. gen. Microbiol.*, 12, 265.)

selection of populations starting with a single cell. The differences between the two lower populations is even greater than appears since many of the "colonies" given an arbitrary diameter of 1 actually failed to divide at all.

This method can be applied to the wide spectrum antibiotics. Streptomycin has been used, since Demerec had

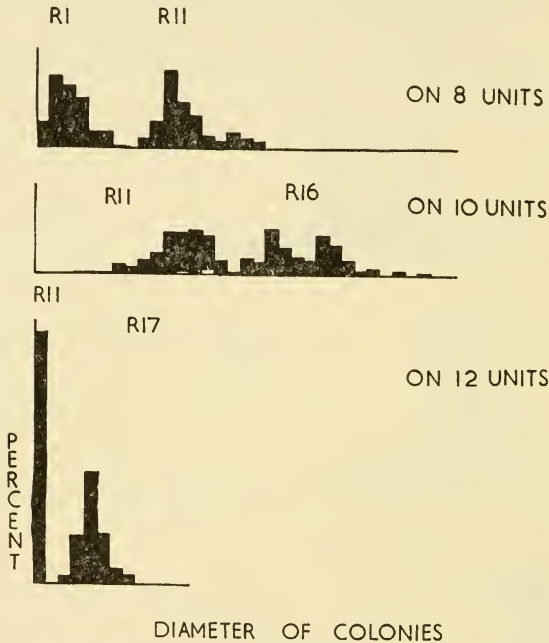

FIG. 10. Stages in the selection of streptomycin resistance.

chosen this to contrast with penicillin in his original paper (Demerec, 1948). *Klebsiella pneumoniae* was used in the present series of experiments, as it forms a neat colony which is easy to measure. The steps in re-selection for resistance are given in Fig. 10. At each level of antibiotic, up to 12 sub-cultures of the largest colonies were necessary before the diameter of the strain on normal medium was reached. At this point the new strain was able to survive and divide, at

any rate for 4 hours, in a strength 20 per cent above that which had originally been used. At the present rate of progress it will require about 40 subcultures to double the resistance of the strain, but the number of cells being examined at each level is from 100 to 300 only.

It appears that the transition from sensitivity to resistance can be made gradually by very large numbers of small steps made possible by the organisms differing from one another just as do the units in any other population.

REFERENCES

- DEMEREC, M. (1948). *J. Bact.*, **56**, 63.
EAGLE, H., FLEISCHMAN, R., and LEVY, M. (1952). *J. Bact.*, **63**, 623.
HUGHES, W. H. (1952). *J. gen. Microbiol.*, **6**, 175.
HUGHES, W. H. (1955a). *J. gen. Microbiol.*, **12**, 265.
HUGHES, W. H. (1955b). *J. gen. Microbiol.*, **12**, 269.
MAYR-HARTING, A. (1955). *J. gen. Microbiol.*, **13**, 9.
YUDKIN, J. (1953). *Nature, Lond.*, **171**, 541.

DISCUSSION

Stocker: Dr. Hughes' approach is, I believe, a very valuable one. In micromanipulation experiments, one is confined to examining small populations. This means that one can only observe frequent mutations. One is apt to think of spontaneous mutations as being very infrequent events; but in bacteria, in regard to certain quantal or all-or-none changes, there are a number of examples of spontaneous changes of heritable character at rates of the order of 10^{-2} or 10^{-3} per bacterium per generation. In most cases no analysis has been made to see whether or not these changes result from changes of chromosomal genes. In *Salmonella*, spontaneous changes of flagellar antigenic phase occur in each direction at about this rate; and this change has been shown to be in fact something occurring at a chromosomal gene (Lederberg, J., and Iino, T. (1956). *Genetics*, **41**, 743). Hughes' demonstration of heritable differences in antibiotic sensitivity between two cells picked at random from the same population is formally analogous to the differences in antigenic phase which one may find between two *Salmonella* colonies obtained by plating out a single colony; and might, like it, result from a 'change of state' at a chromosomal locus.

Hughes has examined cells of a single clone grown in a common environment, and has shown that even a pair of sister cells may differ in their ability to grow in a particular antibiotic concentration. Until a direct test has been made one should not assume that such differences are due to differences in the genetic constitution of the cells concerned,

for one can show that in some systems there is heterogeneity within a clone which is due neither to genetic differences nor to detectable differences in the environments of the differing individuals. For instance, in some *Salmonella* strains only a characteristic proportion (e.g. 10^{-5}) of the cells of a clone can synthesize locomotor apparatus, even when the clone has been grown in a shaken flask of broth, so that all the cells grew in an identical environment (so far as it is possible to provide one). A direct comparison of the progeny of synthesizing and of non-synthesizing individuals (isolated by micromanipulation) shows no difference: therefore the two kinds of cell do not differ genetically. The difference between them can therefore be attributed neither to differences in their genotypes, nor to (detectable) differences in their environments. Thus, the genotype and the environment determine only the relative probabilities of the two alternative phenotypes in any particular individual. This is presumably true also in the case of drug resistance; a common example is that under some conditions of selection (for instance, an antibiotic concentration which permits colony formation by say one per cent of the cells plated) it is not infrequent to find that the antibiotic resistance of the population of these colonies is indistinguishable from that of the parent strain; all one can say is that the original progenitors of these colonies differed in their phenotype from the mode, but that particular variation of phenotype is not heritable.

Dr. Hughes, would you please explain in more detail the actual procedure by which you observed these small steps with apparent increasing resistance to the drug. Did these cells, for instance, go through an intermediate period of cultivation in the absence of the drug to show that something other than a phenotypic adaptation had occurred?

Hughes: Yes; you take a single cell or microcolony, grow up a manageable amount of culture, about 500–1000 cells, then transfer to broth. From this you plant out again in the test medium, which in this case is agar with a given level of streptomycin. You weed the cells out so that there is a clear area to each. You then cultivate for a standard length of time at a standard temperature and measure the colony diameter. Having measured up the whole of the diameters, you pick the smallest and the largest colonies, make new emulsions and repeat the procedure.

In the technique for testing two daughter cells separately, you take a single cell and put it into a drop of broth. You wait until it has divided, then transfer each individual into a drop of broth. You then transfer the drop to a marked position on a small block of agar containing the inhibitor (I always put one on each corner of the block). Then you can follow them at any interval; you recover them after your standard time of exposure and put them into normal nutrient medium, or if you wish, into a penicillinase medium if you are working with penicillin, to see whether they recover and give living organisms or not. You can repeat this as often as your patience will allow.

Davis: In the experiments where drug resistance was building up, were they always cultivated in that concentration of the drug?

Hughes: No, they had one subculture in between each test in normal broth.

Yudkin: Have these strains which gradually progress toward resistance always been derived in the presence of the drug?

Hughes: In the particular case of streptomycin they were so derived. They were then grown out away from the drug, and tested again. On the other hand, I believe it would be possible to pick from the sensitive side, for instance in chloramphenicol; but in streptomycin one can only pick the large colonies, not the small, because in streptomycin a microcolony of about 16 organisms will be dead within 4 hours.

Yudkin: That would still be in the presence of the drug; but I wonder if it would be possible to select toward sensitivity in the absence of drug.

Lederberg: What were the population sizes?

Hughes: You have an overnight subculture; 10 ml. building up to the full population which you would expect of an overnight culture. Then you start again from that.

Eagle: How do you interpret these results? In the specific case of antibiotic resistance, are you suggesting that in these cultures there is a tremendously broad spectrum of mutated organisms, differing in degree of resistance, or are you suggesting that these are indeed adaptive changes?

Hughes: I believe that every time a bacterial cell divides, just as every time you sow a seed of any other plant, you get individuals. I believe that all bacteria in a culture differ from all the other bacteria in a culture; and that is the only explanation that I can see for the very wide differences; and that the so-called mutant is the product of killing off 99.999 per cent of them and taking the one that survives. Then, it is quite impossible to tell whether you have selected from a very broad spectrum or whether you have got a genuine mutant. I don't deny the existence of mutants, I am sure they exist. But I do say that there is a great deal of variation which, if you are going to use the term "mutant" for it, means that every time a bacterial cell divides, the two daughter cells are mutants. I don't think we should use the term in that way. I think that something very much more clearcut should happen—an entirely new characteristic, not a gradation—to merit the term "mutant". I think they are all individuals.

Lederberg: We are all prepared to accept the conclusions which have just been stated. But I wonder if the situation might not be slightly more complex. Firstly, that there might be individual responses on the part of different cells to a drug like penicillin is almost to be expected and you certainly have given us a very beautiful demonstration of it. As your work shows, there is reason to believe that the action of penicillin is concerned with the manufacture of cell walls, and it would be no surprise if the rate at which new walls form were related to the amount already there. One would not be surprised to see that there are individual responses on the part of individual cells. I just raise the question, not because the conclusion you give is in any sense unlikely, but this does mean that every cell division gives rise to a transmissible difference between the two cells. It seems quite likely that when you do finally make measures of the norm of reaction of two clones, that may reflect to some extent mutations which are transmissible. But is it certain

that those transmissible differences, that you find as distinguishing the two clones that you finally isolate, occur at the time that you separate these two cell? Could there not have been occasional large differences in the norm of reaction arising by larger changes during the growth of the large clones; which would mean that you might have physiological individuality occurring in every cell division, and genetical changes occurring perhaps less frequently but with high probability at some time in the growth of the clone (although considering the very small magnitude of the physiological change which is involved here, I would be willing to accept their occurrence during cell division)?

Hughes: In certain stated cases with some particular cells, the daughter cells differ from each other sufficiently for one to be a lethal and the other to survive. That happens with sufficient frequency, and could be bred for. My view is that if you can show that a single individual cell is different from its twin sister, then mutation must be a very frequent thing since it is picked up in my populations of from 100-300 cells.

Lederberg: A difference between sister cells is not necessarily a transmissible difference. Although such transmissible differences may arise, they may be superimposed upon the much more frequent physiological fluctuation—one cell gets more cell wall than the other. We know that in cell division the two cells are not necessarily exactly the same size. You don't know that every step of selection involves a genotypic difference; only an occasional one need have done so.

Hughes: In the case of sensitivity to the environment whereby the cell becomes long in form, there is only one division—that of the parent cell. In that case you subculture the actual cell which varied, and not a clone.

Demerec: I agree with Dr. Hughes that practically no two bacterial cells are the same as far as their genetic constitution is concerned. In our laboratory, in keeping stocks of different mutants we try to avoid passing the stock through a single-colony transfer, because we are afraid that by so doing we might change the other properties of the bacteria. Each bacterial cell has a large number of genes, any one of which may be able to mutate; some cells mutate with higher and some with lower frequency. If we had a test sensitive enough to pick up all the gene mutations that occur, we should get a mutation rate very much higher than that obtained when we observe mutations of a single gene.

Cavalli-Sforza: I am rather worried that Dr. Hughes found such a great deal of variation in using the micromanipulator to select single cells. When you use the much simpler method of isolation by plating you don't find such a tremendous variation. I wonder, Dr. Hughes, if you can give an explanation for that. Do you think that one would perhaps get the same amount of variation from cell to cell if isolation were made in the standard way? Also, what is the accuracy of measurement that can be obtained with your method? You grow your colonies directly in an oil-chamber, so there may be considerable variation in local conditions that may affect the estimation of growth. Also, can you say exactly how many cells die in your selection experiments with penicillin? Do the majority die?

Hughes: It depends on what level you choose; you can choose a 20 per

cent mortality or higher or lower than that. In the case of the "family trees", about 80 per cent died.

Lederberg: In regard to this matter of considering a genotype as a norm of reaction, all geneticists have been worried about what is called residual variation in supposedly pure lines. We never know if we can ascribe this type of statistical variability to uncontrollable variation in the environment, with maternal carry-over effects that have no genetic significance, or very minor minimal changes in the genetic material itself. Most genetic work is purposely concerned with changes so large that they can easily be scored, and in the case of bacteria, usually with changes large enough and persistent enough to be scored in clones. We have here quite a different dimension of analysis from that to which we were accustomed, although it does recall the work of Dr. Jennings with isolated rhizopods (Jennings, H. S. (1929). *Bibliogr. genet.*, 5, 105). We must seriously consider the possibility that there is another dimension in genetic change besides the one to which we are accustomed. Here I agree with Dr. Hughes that there may be, together with the fixed continuity of polynucleotides which give the essential structure, other chemical variations in the chromosome which could control the level of activity of genetic material. Dr. Stocker has already alluded to phase variation; here it was possible to show that the difference in antigenic expression is due to oscillations in state between the expressivity and the non-expressivity of a given specific antigenic determinant (Lederberg J., and Iino, T., (1956), *Genetics*, 41, 743); and this was a major change. We would certainly not want to exclude the possibility that this is going on all the time, and only if you have the most refined methods of analysis are you going to be able to pick up the changes in local activity of the genetic material. We must, therefore, try to translate this type of observation into the possibility of conventional genetic analysis by recombinational methods, and see whether we can localize that sort of change that you have described. Secondly, we should see whether we can control these changes environmentally from the outside. There is no indication as to the inherent nature of these changes, whether they are purely metabolic accidents, or whether the type of medium they are in may have something to do with them.

Pontecorvo: If instead of studying bacterial cells, which seem to be locked into a tough membrane, you looked at mammalian cells in tissue culture, you would find there is an enormous amount of variation in shape, size, etc. Each cell has an individuality, so to speak.

Eagle: There are large differences with respect to resistance to drugs.

Lederberg: You might also find a very wide variation in chromosome number from one cell to another. But is that residual variation wholly genetic in the sense that Dr. Györfly was using the term, or are there other methods of variation?

Hayes: Cells of *Esch. coli* in young culture as a rule contain four nuclear analogues. This means that two generations are required for segregation of a cell which is under the sole control of one of the four nuclei of the initial cell. There is good evidence to suggest that one normal nucleus within a cell is able to support normal growth. If Dr. Hughes' non-viable

cells, which express their defect on the *first* division, are due to something analogous to a lethal nuclear mutation, then this change must either have occurred simultaneously in two adjacent nuclei of the initial cell, or else in one nucleus one generation back. In a scheme of this sort, under conditions such as Dr. Hughes used where the behaviour of cells in a population which had been carried through several generations was studied, one would expect to find a number of non-viable cells which failed to divide *ab initio*, as well as cells which segregated a non-viable cell only at the second generation. What is your opinion on this, Dr. Hughes?

Hughes: I don't know what happens inside the cell. But the type which gives one lethal and one normal cell exists, and so does the one that is immediately a lethal. On the first isolate we have 3 per cent of this lethal, and 12 per cent of a cell that divides to give one lethal and one normal; on re-selection from these we get up to 17 per cent direct lethals and 57 per cent of mixed ones. At no time did I see this second generation type you anticipate. It was first division or nothing. I don't know the explanation.

Hayes: Stress has been laid on the fact that these changes are probably either mutational, or else have something to do with enzymic equilibria and so on in the cytoplasm.

There is another kind of genic change which could have profound effects on the cell, which is not mutational in the sense of altering the direct function of a particular gene, and which is not connected with the cytoplasm, and this is the question of the rearrangement of genes within the chromosome, the position effect. It has been shown recently by Jacob, at the Pasteur Institute, that when selection is made for Hfr derivatives of *Esch. coli* K 12 donor strains, which have a very high fertility, the genes of different Hfr isolates from the same wild-type strain may appear in quite different orders on the chromosome. It is not known whether the change to the Hfr state is directly associated with, and possibly due to, rather rare chromosomal rearrangements, or whether the rather rare Hfr mutations selected for are simply superimposed upon chromosomal reorganizations which may occur quite frequently. There is some vague morphological evidence of nuclear fusion, suggestive of autogamy, in bacterial cells; such a process could possibly result in rearrangement of the order of genes on the chromosomes when they separate out again. Position effects of that sort might greatly influence the viability or the biological efficiency of individual bacterial cells.

Hughes: I should mention that while you can select out for a high proportion of lethals, you cannot select out a lethal-free strain. You can get rid of the cells which die immediately, you can get the percentage down to a fraction of one per cent, but you cannot lose entirely the cells which divide into one lethal and one normal. They persisted however long I have gone on with this type of experiment.

Lederberg: Do I understand correctly that these lethal-type cells only appear during the zero or first generation of transfer from broth or agar and not subsequently in the growth of the clone?

Hughes: That is correct as far as I know.

Lederberg: That would suggest one of two possibilities: either (1) that during the course of growth in broth you accumulate a higher frequency of alteration, depending on the nuclear configuration of the cell that you begin with and that shows up either in both or in only one of the first daughter progeny; or (2) that the noxious stimulus is not agar but the switch from broth to agar, which may cause some imbalance in the relative rate of formation of cell wall or cell substance. Once the cells start to grow on agar they might become well adjusted to those particular circumstances. Have you got the observational evidence that would bear on this question?

Hughes: I don't think so. I have always thought that there was a mutation involved in this, and that in broth it was no disadvantage to have this particular character, and that the population built up in broth would be detected when transferred to solid medium. Whether it is the shock of transfer to solid medium, or something else, I don't know.

Lederberg: Is there any indication that the time of cultivation in broth has an influence on the proportion of lethals which appear when the clones are transferred back on agar? This would be one line of evidence relative to the question of accumulation of these mutations in broth.

Hughes: My impression was that a short subculture, i.e. building up a microcolony of perhaps 200 or 300 in broth, gave much the same percentages as an overnight broth culture. I would like to repeat that.

Lederberg: That would favour the conception that it is the sharp change of medium that is the noxious stimulus.

Ultraviolet light induces a possibly analogous abnormality. After a week of exposure of *Esch. coli* K12 to ultraviolet 60–80 per cent of the cells may divide to give one normal, rapidly dividing offspring, and another abnormal, swollen and probably inviable one. This is almost certainly a reflection of the multinucleate structure of the cells (*Lederberg, J., et al. (1951), Cold Spr. Harb. Symp. quant. Biol., 16, 413.*)

Ierusalimsky: Dr. Hughes mentioned in his interesting report a very important point on the inequality of bacteriological cells arising from division. This question has not been investigated sufficiently. It is not known whether inequality of cells is random and non-regular or whether one of them always resembles the mother and the other the daughter. Málek in Czechoslovakia and Streshinsky in the USSR support the second point of view, and our experiments also tend to support it. Our experiments are directed towards explaining the causes of the varying resistance of individual cells in a population, and discovering the relation between the degree of resistance and the physiological age of cells. Unless these individual differences are taken into consideration, it is very difficult to distinguish adaptive physiological changes from mutations. It seems to me that Dr. Hughes' film has proved that resistance to penicillin arises mostly in young daughter cells, and therefore this phenomenon is probably a physiological adaptation.

PENICILLIN-INDUCED RESISTANCE TO PENICILLIN IN CULTURES OF *BACILLUS CEREUS*

M. R. POLLOCK

National Institute for Medical Research, Mill Hill, London

ALTHOUGH the mechanisms of drug resistance in bacteria are, in general, not well understood, there are certain strains whose ability to multiply after addition of penicillin can be confidently ascribed to their production of an enzyme, penicillinase, which hydrolyses the drug to the antibioticly inactive penicilloic acid. This is true for the naturally occurring penicillin-resistant staphylococci (Barber, 1953) and several different species in the *Bacillus* genus. This report is concerned solely with the mechanism of the development of this penicillinase-type of penicillin resistance in cultures of *Bacillus cereus*, and it will be shown that the change can take place in two quite distinct ways, both of which require the addition of penicillin for their full expression. In both mechanisms, the change involves a purely quantitative increase in the ability to form a single, enzymically active protein. Such a relatively simple system naturally lends itself to a more detailed and more accurate analysis at the biochemical level than most types of drug resistance.

In the first mechanism, the resistance is acquired by the process of enzyme induction. A greatly increased rate of penicillinase formation can be very rapidly acquired, within the space of a few minutes, in all or most of the individual cells in the population by brief contact with low concentrations of penicillin (1 unit/ml. or less). This acquired ability to produce penicillinase at increased rate is biochemically stable but is not inherited by daughter cells as a genetically stable character, being gradually lost as the cells grow in the absence of the antibiotic. After 7 to 12 generations the popu-

lation has returned to the original state of (relative) penicillin sensitivity. The phenomenon of induced penicillinase formation occurs in most strains of *B. cereus*, and in *Bacillus subtilis* and *Bacillus megaterium*, and has been studied in great detail in *B. cereus* strain 569 (Pollock, 1953). It is not proposed to discuss it in much further detail here except to point out that even the uninduced cells (untreated with penicillin) produce small quantities of penicillinase ("basal" enzyme) and that maximal induction results in its formation at about 300 times the basal rate. It has not hitherto been found possible to test the penicillin-sensitivity of cells in the absence of penicillinase induction. This is probably because penicillin, except in very high concentrations, does not itself appear to inhibit induced penicillinase synthesis, which takes place very rapidly after addition of penicillin in sensitivity tests. Thus although the increase in penicillin resistance of individual cells on penicillinase induction is probably considerable, only a relatively slight increase can be actually demonstrated. It could, however, be shown (by the experiment summarized in Table I) that preinduction of cells with penicillin at subinhibiting doses does considerably increase their chances of survival when treated later with much higher concentrations of the drug. Spores of strain 569 incubated for 5 hours in plain nutrient agar (i.e. having grown to produce microcolonies of 16 to 32 cells) were unable to survive addition of penicillin to a concentration above 60 units/ml., while the same inoculum grown in penicillin-agar suffered only slight reduction in viability after addition of 100 units/ml., and a considerable proportion of microcolonies (11 out of 42) were still able to grow into normal colonies after addition of 160 units penicillin/ml. (No such protective effect of induction occurs with the penicillinase-constitutive mutant strain 569/H which forms penicillinase at maximal rate without need for previous treatment with penicillin.)

The second process by which *B. cereus* populations may acquire the penicillinase type of penicillin resistance is the (perhaps) more familiar one of mutation followed by selection.

Very rarely there may appear mutant cells, which give rise to clones able to form penicillinase spontaneously at high rates ("penicillinase-constitutive" mutants). These mutations occur by a process which is independent of the presence of penicillin. Their cause is unknown. Penicillin, however, is necessary for the full expression of resistance within the

Table I

Bacillus cereus: EFFECT OF PREVIOUS TREATMENT WITH PENICILLIN ON THE PENICILLIN RESISTANCE OF (a) THE PENICILLINASE-INDUCIBLE STRAIN 569 (b) THE CONSTITUTIVE MUTANT STRAIN 569/H.

Final concentration penicillin (units/ ml.) added 5 hr. after inoculation of plates	No. of colonies/plate after 16 hr. incubation at 35°			
	Strain 569 inoculated into:		Strain 569/H inoculated into:	
	Nutrient agar	Nutrient agar +1 unit peni- cillin/ml.	Nutrient agar	Nutrient agar +1 unit peni- cillin/ml.
0	35	42	37	43
20	30	51	21	26
40	17	37	27	28
60	4	16	14	15
100	0	29	13	18
120	0	9	9	5
140	0	8	1	9
160	0	11	2	3

Spores of 569 and 569/H were inoculated into a series of nutrient agar plates with and without added penicillin at 1 unit/ml. After 5 hr. incubation at 35° layers of agar containing different concentrations of penicillin were poured on the surface such that final concentrations of the penicillin, after diffusion through the plate, ranged from 0 to 160 units/ml. Incubation at 35° was then continued and the colonies counted after a further 16 hr.

culture, in order to permit the selective growth of the few resistant cells and so allow the evolution of the population towards one in which all or most of the individuals form the enzyme spontaneously at high rate. Resistance developed in this way is genetically stable and may persist undiminished during repeated subcultures in the absence of penicillin. Such "spontaneous" penicillinase-constitutive mutants (569/H) can be detected at an incidence of about 1 in 10⁶ in cultures of strain 569 (derived from a single spore)—i.e. amongst the

same population as that which undergoes penicillinase-induction under the direct influence of penicillin (Kogut, Pollock and Tridgell, 1956). However, a culture of strain 569 cannot be induced to evolve into a culture of 569/H by growth in the liquid penicillin-containing medium. There are three possible reasons for this. (1) The margin of difference between the penicillin resistance of 569 and of 569/H is not large because (as explained above) increased penicillinase formation is induced so rapidly in 569 that cells take only a few minutes before they are able to produce the enzyme almost as fast as 569/H. (2) 569/H grows more slowly than 569. Its specific growth rate in broth or casein hydrolysate is about 80 per cent that of 569 in the same media. (3) Penicillinase is a communal bacterial weapon against penicillin, especially because 85-90 per cent of the total enzyme is liberated into the medium by both strains and therefore its production by one section of a mixed population of cells might be expected also to protect, to some extent, other individuals in the culture.

The mutation-plus-selection method of developing penicillin resistance can, however, be studied satisfactorily in another group of *B. cereus* strains, none of which are susceptible to penicillinase induction. These will be referred to as the "5" group. *B. cereus* strain 5 was found (Sneath, 1955) to be unique amongst 65 strains of *B. cereus* tested, in having a very high penicillin sensitivity (the growth of single spores being inhibited by only 0.01 units penicillin/ml.). No penicillinase production [as tested by the standard manometric method of Henry and Housewright (1947)] could be detected in strain 5, either before or after treatment with penicillin. After overnight growth of a fairly large inoculum (approx. 10^5 cells per ml.) into broth containing 100 units penicillin/ml., strain 5 was found to evolve into a practically homogeneous population of penicillin-resistant cells (5/B) capable of forming penicillinase spontaneously at very high rate. By application of the velvet pad technique of Lederberg and Lederberg (1952), Sneath was able to demonstrate very beautifully that

strain 5 mutated to 5/B "spontaneously" (i.e. in the absence of penicillin). The demonstration in this instance was particularly satisfying because it was possible to show the production of penicillinase (acid-formation—due to production of penicilloic acid—in nutrient agar containing a pH indicator, after addition of a high concentration of penicillin) by 5/B cells which had never been in contact with penicillin, even for the test itself. This is possible simply because the enzyme diffuses out from the colony on or in nutrient agar and can be demonstrated in the medium after the colony itself has been removed. This completely disposes of any objection that the mutation, in the first place, might be a relatively non-specific event resulting in susceptibility to a subsequent specifically induced change.

Subsequently, it was discovered that spore suspensions of strain 5 contained, as well as 5/B mutants, another type (5/P) of cell, with intermediate penicillin resistance, which formed penicillinase at approximately one-eighth of the rate of 5/B. Its "spontaneous" mutative origin was never formally proved, but it seems likely that it arose in the same way as 5/B. The specific penicillinase activities (units enzyme/mg. dry bacterial weight) were measured on whole cultures growing logarithmically in 1 per cent gelatin-broth and found not to vary much within a single strain. All 5/P cells were able to form colonies in agar containing penicillin up to a concentration of 0.1 units/ml. but not higher; whereas 5/B cells could develop into colonies in penicillin up to 1.0 units/ml. It was thus possible to make accurate viable counts of mixtures of 5, 5/P and 5/B cells by plating out in suitable dilutions into agar containing different concentrations of penicillin. The proportions of these three types found in the spore suspension studied were 1,000,000 : 6 : 4. Cultures of 5 from single spore inocula were regularly found to contain this 1 : 250,000 proportion of 5/B mutants, but the 5/P strain has so far only been found in one spore suspension and must presumably therefore result from a very rare mutation. On plates containing 0.1 units penicillin/ml. there was no sure way of

distinguishing 5/P colonies from those of 5/B, but cultures from separate colony isolates were found to form penicillinase at rates characteristic either of the 5/P or 5/B prototypes with slight variation and no overlap (see Fig. 1). Since these isolates were obtained from the same plate, it could hardly be argued that 5/B colonies were simply examples of the extreme limits of a wide variation normally shown by 5/P clones, or *vice versa*. It could be confidently concluded that they represented two distinct strains. If, therefore, there is any clonal variation within populations of 5/P and 5/B of

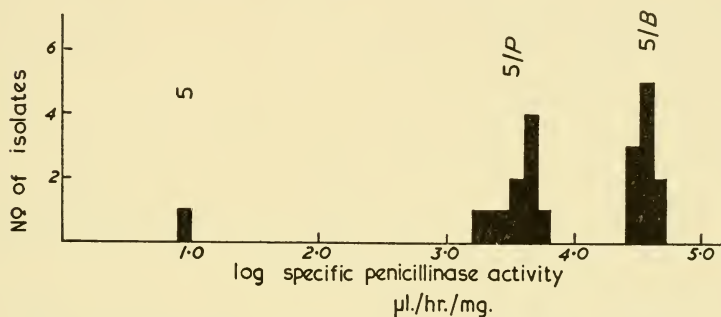

FIG. 1. Distribution of specific penicillinase activities amongst single-colony isolates of penicillin-resistant mutants from cultures of *B. cereus* 5.

the continuous type postulated by Yudkin (1953) affecting the rates of penicillinase formation by individual cells, it must have very low genetic stability and/or a very narrow range and would therefore be of little significance in the evolution of a more resistant population.

Addition of penicillin to cultures of members of the "5" group causes no significant increase in rate of penicillinase formation. This lack of inducibility is probably the explanation of why it is easy (in comparison with the 569 group) to exert differential selection pressure by growth in appropriate concentrations of penicillin.

It was at first thought that the 5→5/B mutation involved the acquisition of a completely new enzyme. However,

concentrates of the supernatant fluid obtained after spinning off cells from cultures of strain 5 were found to contain traces of penicillinase activity. A technique for micro-assay of penicillinase in untreated culture supernatant fluid was eventually evolved which permitted accurate measurement of activity with a sensitivity up to 100 times that of the manometric method. Since this method has not been published before, it is described here in detail.

Micro-assay of Penicillinase Activity

Two-ml. samples of culture supernatant fluid were diluted 1 : 5 in 1% gelatin broth containing 20 units penicillin/ml. and incubated at 30°. One-ml. quantities were withdrawn every 15 min. and added to 9 ml. ice-cold 0.01 M potassium phosphate buffer (pH 7.0). The residual penicillin in the diluted sample was assayed in octuplicate by cup-plate assay using the ICI strain of *B. subtilis* as indicator organism, by comparison with penicillin standards of from 0.8 to 2.0 units/ml. (Humphrey and Lightbown, 1952). After addition of samples, the plates were stored for 2 to 4 hr. at 0° to allow diffusion of the penicillin (and so increase the sensitivity of the test) before incubation overnight at 35°. The amount of enzyme preparation added was adjusted such that not more than 50% of the penicillin had been destroyed before at least 3 samples had been taken.

Zero-point estimation of penicillin made in this way proved that it was possible to make accurate assays in the presence of enzyme. This was feasible because of the decrease in enzyme activity on sampling, due to a combination of 2 factors: (1) the lowering of temperature to 0° until the antibiotic had time to diffuse away from the enzyme in the cups and (2) the 1 : 10 dilution of substrate from a concentration which was, initially, well below enzyme saturation level; this must have caused a nearly proportional decrease in enzyme activity.

For the purposes of this particular assay, the two following assumptions had to be made: (1) The activity in the culture supernatant fluid corresponded approximately with total activity—as with all the other strains of *B. cereus* so far tested. (2) The Michaelis affinity constant of the strain 5 enzyme was identical with that of the 5/B penicillinase. In view of the other similarities between 5 and 5/B penicillinases (to be discussed later) this seems an entirely reasonable assumption.

The enzyme activity was finally calculated by plotting the residual penicillin concentration against time, measuring the initial rate of penicillin destruction and adjusting the value to what it would be were the enzyme saturated with substrate. An accurate figure for the K_m of penicillinase is thus required—and can in fact be calculated, using the same technique, by varying substrate concentration and having samples with rather higher enzyme activities than those available from cultures of strain 5.

In this way it was established that cultures of strain 5 produce penicillinase consistently at approximately one five-thousandth the rate shown by strain 5/B. Although this activity was from 25 to 250 times (in different cultures) that expected from the rather variable content of 5/P and 5/B cells, it seemed essential to eliminate the possibility that these mutants might, when growing in the presence of large numbers of 5, produce much more enzyme than that expected from activities measured in pure culture, and thus themselves be responsible for the activity observed.

The effect on penicillinase production of supplementing the "natural" 5/P and 5/B content of 5 cultures by a known number of added cells and subsequently growing the mixed culture for 5 hours at 35°, with careful differential counts of all 3 types, is illustrated in Table II. It can be seen that only when the 5/P and 5/B content of the culture reached proportions approximately 200 times the normal level, was there any significant increase in the amount of penicillinase produced; and the extent of this increase corresponds to the value expected from the additional number of 5/P and 5/B cells present.

The penicillinase activity of strain 5 cultures cannot therefore be ascribed to the presence of 5/P and 5/B mutants. It is not, however, certain whether this low penicillinase production is a property distributed evenly among the rest of the population. A search was made, without success, for any evidence of further heterogeneity. But it is not known whether colonies consisting of cells producing the enzyme, say at one-fifth the rate of 5/P, would necessarily be detected by the penicillin-sensitivity or penicillinase production tests used, though this seems likely. Such a hypothetical strain would have to form 1 per cent of the total population of strain 5 in order to account for the observed activity. Direct testing of cultures by manometric assay of penicillinase from individual colonies has yielded only 5/P and 5/B types and negatives. We have therefore provisionally concluded that the wild type forms penicillinase, constitutively, at a rate corresponding to the production of about 15 molecules per cell—

Table II
PRODUCTION OF PENICILLINASE BY WILD-TYPE *B. cereus* 5
After 5 hr. incubation at 35° K.

Experiment	Number of spores/ml. at time of inoculation		Total opacity of culture mg. dry bacterial wt. per ml.	Viable Count* per ml.		Penicillinase activity found units/ml.†	Range of expected penicillinase‡ activity from 5/P and 5/B only. Units/ml.‡
	5	5/B		5/P	5/B		
I	5 alone	88,000	0	0	0.34	0	0.00033-0.00058
	5+5/P+5/B artificial mixture	88,000	2.6	1.7	0.32	1,000	0.0030-0.0053
	5+5/P+5/B artificial mixture	88,000	13	8.5	0.31	12,700	0.016-0.028
	5 alone	88,000	0	0	0.31	630	0.00030-0.00054
II	5+5/P+5/B artificial mixture	88,000	5.2	3.4	0.32	4,000	0.0068-0.012
	5+5/P+5/B artificial mixture	88,000	52	34	0.33	25,500	0.039-0.070
	5 alone	88,000	0	0	0.31	630	0.00030-0.00054
	5+5/P+5/B artificial mixture	88,000	5.2	3.4	0.32	4,000	0.0068-0.012

* 5/B—counted in nutrient agar + 1.0 unit/ml. penicillin.

5/P—difference between counts in nutrient agar + 1.0 unit/ml. and + 0.05 unit/ml. penicillin.

† Units as defined by Pollock and Torriani (1953).

‡ Specific penicillinase activities found in pure cultures are: 5/B 1,760 units/mg. dry bact. wt. 5/P 220 units/mg. dry bact. wt.

1 mg. of dried 5/P or 5/B cells is taken to be equivalent to between 4.5 and 8.0 × 10⁸ cell-units (as judged by relationship found between viable counts and dry weight of cells).

or about 1 molecule per cell every 3 minutes—in logarithmically growing cultures. Its penicillin sensitivity would suggest that such a very low level of formation is not of much benefit to the organism under conditions of the test.

A chart summarizing most of the properties of these different strains with respect to penicillinase production has been

Table III

PENICILLINASE ACTIVITY AND PENICILLIN RESISTANCE OF STRAINS OF *B. cereus*.

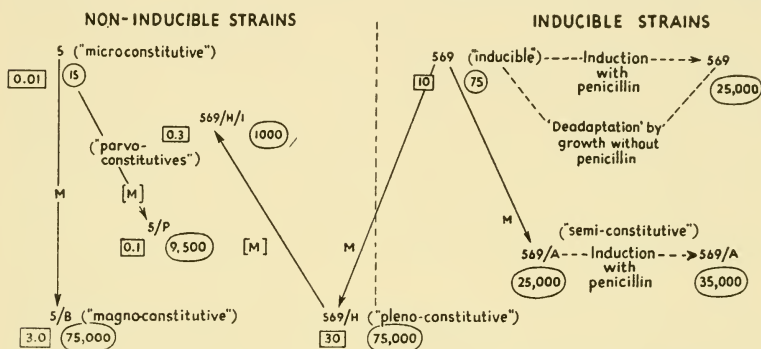

Strains are denoted by numbers, e.g. 569, and presumed mutants therefrom by added letters, e.g. 569/H. Approximate rate of penicillinase production is given in circles as number of molecules per cell (assuming mean wt. of one cell = 1.3×10^{-12} g.). Figures in squares indicate the maximum concentration of penicillin (in units per ml.) allowing colony formation from at least 50 per cent of viable spores inoculated into nutrient agar. M=proved mutation. [M]=presumed mutation.

compiled as illustrated by Table III, and a system of nomenclature suggested. It is more or less self-explanatory; but certain comments are necessary.

(1) Within the 5 group, the relation between rates of penicillinase production and penicillin resistance is obvious. There can hardly be any doubt that the one is responsible for the other. The reason for the relatively slight difference between the penicillinase resistance of 569 and 569/H has been ascribed to the very rapid induction of penicillinase formation by penicillin in 569. Were it possible to inhibit penicillinase induction without affecting growth, this point could be tested

directly. However, there is every reason to believe that were it not for this rapid induction, 569 would be highly sensitive to penicillin; and this conclusion is supported by the relatively low penicillin resistance of the non-inducible double mutant strain 569/H/1 derived from 569/H. In the absence of penicillin, 569/H/1 produces 15 times as much enzyme as 569; 569/H/1 is however strictly non-inducible so that, after addition of penicillin, 569 forms penicillinase approximately 25 times as fast as 569/H/1. It is therefore not difficult to understand why 569 can develop in concentrations of penicillin up to 30 times the highest levels permitting growth of 569/H/1. The significance of enzyme induction as a means of developing specific drug resistance is that it is (usually) adaptive and therefore economical. At the expense of a slightly lower penicillin resistance than 569/H, 569 avoids using up to 1 per cent of its protein-synthesizing ability on a normally useless enzyme—except under just those conditions where that enzyme is essential for survival. It should be noted that enzyme induction may also contribute to the development of drug resistance (of a genetically more stable type) by permitting survival and multiplication of cells after addition of the drug and so increasing the possibility of mutations towards higher resistance (e.g. constitutive mutants, or mutants with more efficient induction systems).

The difference in penicillin resistance of 5/B and 569/H, whose rate of total penicillinase production is the same, may possibly be due to the very much larger amount of intracellular enzyme [" γ -penicillinase": see Pollock (1956*b*)] present in the latter.

These two strains have been referred to respectively as "magno-" and "pleno-" penicillinase-constitutive types. There is really nothing apart from their origin to justify such a distinction. It was made with the intention of emphasizing that the pleno-constitutive strain 569/H was derived from an inducible parent strain which was able to undergo a series of mutations involving different increases in the quantity of basal enzyme. The semi-constitutive strain 569/A which still

retains some inducibility might be regarded as an example of this type of change; and 569/H could be considered as its apogee. However, isolation of the non-inducible 569/H/1 from a culture of 569/H which had grown some time in casein hydrolysate rather suggests that the mutation: 569→569/H might be considered as "development of constitutivity" and the difference between 569/H and 569/H/1 might be similar to that between the magno- and parvo-constitutives of the 5 series. No change from non-inducible to inducible penicillinase production has yet been found.

(2) Strains of the "5 group" are completely insusceptible to penicillinase induction. They form a family which are indistinguishable from one another by any known criterion apart from rates of penicillinase production. But they are physiologically distinct from the 569 family, differing slightly in colonial morphology, in rates of fermentation of salicin and starch (Sneath, personal communication) and in the type of penicillinase produced.

(3) The 5/B and 569/H constitutive penicillinases and the 569 (induced) penicillinase have been purified and their physicochemical and biochemical characteristics compared (Pollock, Torriani and Tridgell, 1956; Kogut, Pollock and Tridgell, 1956). The 5/B penicillinase differs slightly but significantly from the 569/H enzyme by all criteria examined (molecular weight, sedimentation constant, molecular activity, electrophoretic mobility and salt solubility) while the induced 569 and 569/H enzyme are indistinguishable. An immunological comparison [based on slopes of enzyme neutralization curves in the presence of increasing quantities of a specific antibody preparation partially absorbed with the induced 569 enzyme—see Pollock (1956*a*)] has shown the 5/B and 569 enzymes to be related though distinguishable, while the basal 569 (uninduced) penicillinase gives the same slope as the 569 (induced) 569/H and 569/H/1 enzymes.

There is clearly not enough of the "microconstitutive" 5 penicillinase to allow its isolation and physicochemical characterization. But, as with the basal 569 enzyme, an

immunological comparison with 5/B penicillinase is possible. Fig. 2 shows how a partially absorbed anti-569 antibody preparation neutralizes the 5/B enzyme and a preparation of 5 penicillinase (obtained from a culture supernatant fluid concentrate) to give identical neutralization slopes. The 5/P enzyme is likewise indistinguishable from 5 and 5/B; whereas the 569 penicillinase gives a quite different slope. Results obtained (in a different experiment) with culture supernatant

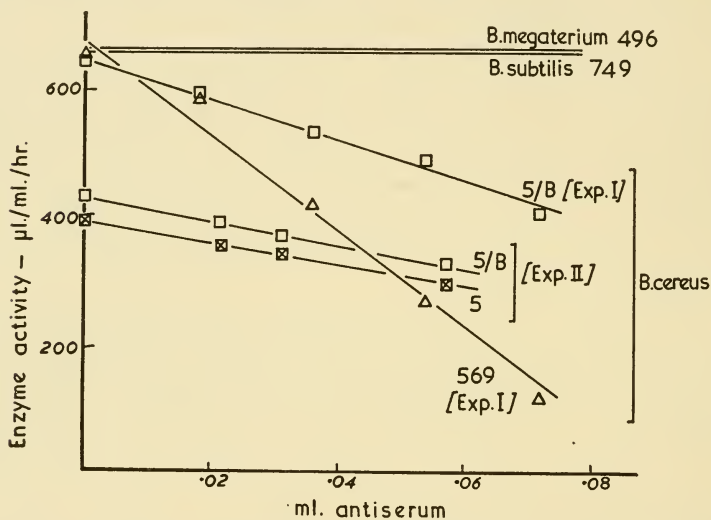

FIG. 2. Neutralization of different penicillinases by partially-absorbed anti-penicillinase serum.

fluids from penicillinase-producing strains of *B. subtilis* and *B. megaterium* show no neutralization whatever and indicate that their enzymes are far less closely related to 569 penicillinase than those of the 5 group.

This immunological test can therefore be regarded as a very sensitive indication of probable identity. It appears reasonable to conclude that within each family of strains the change in rates of increase of penicillinase activity—whether occurring by enzyme induction or by mutation—reflects a purely quantitative alteration in the rates of formation of the same protein.

Speculative Discussion

This symposium will undoubtedly contain many discussions on the extent to which drug resistance may depend in the first place upon a spontaneous change within an organism (followed by selection) or upon a change specifically induced in the organism by some factor in the environment. A study of the development of the penicillinase type of penicillin resistance in *B. cereus*, where changes in resistance can be followed accurately at a biochemical level, has shown that both types can occur, even within the same population of individuals. It is vital, however, to recognize that the specifically induced change (enzyme induction) is due to an increase in the activity of an enzyme-forming system which itself does not appear to play any part—however indirect—in stimulating its own production. It is biochemically stable, but genetically transitory. Although the antibiotic antidote (penicillinase) developed in both types is identical, its mode of acquisition and its genetic stability are quite different. Once this distinction is accepted (but not before), it is permissible to ask whether after all there may be some connexion between the two types of phenomenon.

In a speculative discussion (Pollock, 1953) ways have been suggested by which enzyme induction by specific environmental factors might theoretically lead to a stable heritable change in an organism. It was argued that a necessary prerequisite for such an event would be that the external inducer should, by some means (however indirectly), stimulate the cell to form more of the inducer itself (or its biological equivalent). This attempt was influenced by what was felt to be a need to adapt the theoretical speculations of Hinshelwood (1946) towards the established facts of induced enzyme synthesis. Now although the synthesis or activation of biologically important molecules (e.g. formation of certain polysaccharides or activation of many proteinase precursors) in some subcellular systems often runs an autocatalytic course because the reaction is stimulated by its own product, it

must be admitted that good evidence for "self-reproducing" enzyme-forming systems is so far non-existent.

It is true that there have been a number of interesting claims to have demonstrated that heritable changes can be specifically induced in micro-organisms by environmental factors [acquisition of ability to ferment sucrose in yeast (Kossikov, 1950); development of streptomycin resistance in *Pseudomonas* (Linz, 1950); loss of penicillin resistance in staphylococci after treatment with chloramphenicol (Voureka, 1952); lactose-induced development of ability to ferment lactose in *Escherichia coli* ("mutabile") (Dean and Hinshelwood, 1954); proflavine-induced proflavine resistance in *Aerobacter aerogenes* (Dean, 1955) etc.]. But either these have been open to theoretical objections or the phenomena themselves have not yet been fully confirmed by other workers. It would appear that specifically induced heritable change in individual cells has so far been firmly substantiated only for cases of transformation of bacterial strains by deoxyribonucleic acid-containing extracts from other types of bacteria. Nevertheless, other instances of "specifically directed mutations" may well exist—and indeed should be looked for with increasing persistence.

It has already been emphasized that the changes in penicillin resistance of *B. cereus* reported have involved simple quantitative changes in amounts of penicillinase produced. Similar, though less marked, quantitative changes (due to single gene mutations) have been reported by Markert and Owen (1954) and Owen and Markert (1955) for *Glomerella* tyrosinases and by Yanofsky (1952) for *Neurospora* tryptophan synthase. Different strains of staphylococci (from the same cultures and therefore probably derived one from another by mutations) were found by Rogers (1953) to fall into distinct groups with widely differing rates of hyaluronidase production. Even the penicillin-sensitive parent strain 5 of the penicillin-resistant 5/B mutant forms minute amounts of the same enzyme which, when produced in large quantities, is responsible for the resistance of 5/B. There has been no

change—either by mutation or by enzyme induction—in the kind of protein produced. It is therefore perhaps permissible to wonder how frequently truly qualitative changes at a molecular level may in fact occur. Qualitative changes—both from mutations and interactions of genes—have of course often been described [e.g. hybrid antigens in red cells (*a*) of pigeons (Irwin, 1947), (*b*) of rabbits (Cohen, 1956), atebirin resistance in pneumococci, said to be due to alteration in a flavo-protein (Sevag and Gots, 1948); two types of *p*-nitrobenzoic acid resistance in *Esch. coli* said to be due to alteration in affinity of an enzyme for the drug (Davis, 1951)] but only rarely have attempts been made to show that such changes are due to intramolecular alteration of a protein which can be properly isolated and characterized.

The best instances of possibly qualitative, heritable changes in proteins, due to single gene mutations or interactions, are those involving alterations in the thermostability of an enzyme [e.g. the pantothenate-synthesizing enzyme of *Esch. coli* (Maas and Davis, 1952); and the tyrosinase of *Neurospora* (Horowitz and Fling, 1953, 1956)]. Unfortunately, thermostability is one of the properties of enzymes which is known to vary considerably with variations in composition of the medium and on association with other molecules (Lawrence and Halvorson, 1954; Stewart and Halvorson, 1954).

Other interesting instances are: (1) two types of glutamic acid dehydrogenases (apparently differing in their extent of reversible inactivation) isolated by Fincham (1957) from strains of *Neurospora* differing by a single gene, and (2) the aureomycin-resistant nitratase found by Saz and co-workers (1956) and Saz and Martinez (1956) in an aureomycin-resistant strain of *Esch. coli* (origin not studied genetically), and reported to have a conjugated flavin moiety more firmly bound than had the corresponding sensitive enzyme obtained from the sensitive strain. In neither case have the enzymes been isolated and compared after full purification.

In cases where types of a well-characterized protein species

can be clearly shown to differ qualitatively in the same and closely related organisms (e.g. the human haemoglobins, cattle β -lactoglobulins, etc.) it is often too readily assumed that the respective synthesizing systems have arisen from one another by a single mutation. So far there is no direct evidence to show that this is so.

Again, in cases where some enzymic activity appears to be lost (or gained) on mutation, it is becoming increasingly apparent that the loss or gain is not absolute and that the "loss" strain (whether mutant or wild type) is suffering from a block that (to use Bonner's terminology) is "leaky". Even in cases where none of the relevant biochemical activity can be detected [e.g. the apparent lack of glutamic acid dehydrogenase in an α -amino acid-requiring mutant of *Neurospora* (Fincham, 1954)] some hesitation is justified before concluding that the loss is absolute. Quite apart from the possibility that the assay technique is insufficiently sensitive, even a demonstration that there is less than one molecule per cell of a certain enzyme, has no special significance (in relation to this particular point) in organisms which reproduce by binary fission—as long as the synthesizing system is genetically stable.

Now, there can hardly be any doubt that during the course of evolution qualitative changes in enzymes do occur. Unless there is some quite inconceivable degree of convergent evolution, the systems synthesizing human haemoglobins A, S, C, D and E, for instance, must have evolved either from each other or some common ancestor. The question is therefore not whether qualitative heritable changes in protein occur; but how frequently and by what means do they occur?

So far, the proved results of single mutations as expressed in terms of proteins seem to be purely quantitative. Is it therefore not possible that qualitative changes (at the protein molecular level) never in fact result from single mutations as studied in the laboratory? To use Beadle's terminology: can single mutations ever be (at a molecular level) neo-morphic?—or are they always hypo- or hypermorphic? Or do single

mutations result in minute qualitative alterations (minor changes in folding of the molecule or displacement of a single amino acid within the chain) too slight to be detected by most available techniques? If this is so, perhaps a series of successive mutations and alterations to the protein molecule may be necessary before the change is detectable. Or, perhaps, a single mutation may never result in more than a relatively slight shift in the distribution of properties amongst a microheterogeneous population of very closely related but different individual molecules within a molecular species, all of which have a similar function [see Colvin, Smith and Cook (1954), for evidence of "microheterogeneity" amongst populations of a single species of protein molecules]. The slow evolution, from cultures of penicillin-sensitive staphylococci, grown for very long periods in low penicillin concentrations, of strains apparently capable of producing minute traces of penicillinase (Barber, this symposium, p. 262) is of special interest in this connexion. Naturally occurring qualitative evolution at a molecular level may proceed very much more slowly than might be at first suspected from consideration of the mutation rates and selection pressures observed within the laboratory.

REFERENCES

- BARBER, M. (1953). *Symp. Soc. gen. Microbiol.*, **3**, 235.
COHEN, C. (1956). *Science*, **123**, 935.
COLVIN, J. R., SMITH, D. B., and COOK, W. H. (1954). *Chem. Rev.*, **54**, 687.
DAVIS, B. D. (1951). *Cold Spr. Harb. Symp. quant. Biol.*, **16**, 73.
DEAN, A. C. R. (1955). *In* Origins of Resistance to Toxic Agents, p. 42. New York: Academic Press.
DEAN, A. C. R., and HINSHELWOOD, C. N. (1954). *Proc. roy. Soc. B*, **142**, 225.
FINCHAM, J. R. S. (1954). *J. gen. Microbiol.*, **11**, 236.
HENRY, R. J., and HOUSEWRIGHT, R. D. (1947). *J. biol. Chem.*, **167**, 559.
HINSHELWOOD, C. N. (1946). *The Chemical Kinetics of the Bacterial Cell*. Oxford: Clarendon Press.
HOROWITZ, N. H., and FLING, M. (1953). *Genetics*, **38**, 360.
HOROWITZ, N. H., and FLING, M. (1956). *Proc. nat. Acad. Sci., Wash.*, **42**, 498.

- HUMPHREY, J. H., and LIGHTBOWN, J. W. (1952). *J. gen. Microbiol.*, **7**, 129.
- IRWIN, M. R. (1947). *Advanc. Genetics*, **1**, 133.
- KOGUT, M., POLLOCK, M. R., and TRIDGELL, E. J. (1956). *Biochem. J.*, **62**, 391.
- KOSSIKOV, K. V. (1950). *Dokl. Akad. Nauk., USSR*, **73**, 381.
- LAWRENCE, N. L., and HALVORSON, H. O. (1954). *J. Bact.*, **68**, 334.
- LEDERBERG, J., and LEIDERBERG, E. M. (1952). *J. Bact.*, **63**, 399.
- LINZ, R. (1950). *Ann. Inst. Pasteur*, **78**, 105.
- MAAS, W. K., and DAVIS, B. D. (1952). *Proc. nat. Acad. Sci., Wash.*, **38**, 785.
- MARKERT, C. L., and OWEN, R. D. (1954). *Genetics*, **39**, 818.
- OWEN, R. D., and MARKERT, C. L. (1955). *J. Immunol.*, **74**, 257.
- POLLOCK, M. R. (1953). *Symp. Soc. gen. Microbiol.*, **3**, 150.
- POLLOCK, M. R. (1956a). *J. gen. Microbiol.*, **14**, 90.
- POLLOCK, M. R. (1956b). *J. gen. Microbiol.*, **15**, 154.
- POLLOCK, M. R., and TORRIANI, A. M. (1953). *C.R. Acad. Sci., Paris*, **237**, 276.
- POLLOCK, M. R., TORRIANI, A. M., and TRIDGELL, E. J. (1956). *Biochem. J.*, **62**, 387.
- ROGERS, H. J. (1953). *J. Path. Bact.*, **66**, 545.
- SAZ, A. K., WEISS BROWNELL, L., and SLIE, R. B. (1956). *J. Bact.*, **71**, 421.
- SAZ, A. K., and MARTINEZ, L. M. (1956). *J. biol. Chem.*, **223**, 285.
- SEVAG, M. G., and GOTS, J. S. (1948). *J. Bact.*, **56**, 737.
- SNEATH, P. H. A. (1955). *J. gen. Microbiol.*, **13**, 561.
- STEWART, B. T., and HALVORSON, H. O. (1954). *Arch. Biochem. Biophys.*, **49**, 168.
- VOUREKA, A. (1952). *J. gen. Microbiol.*, **6**, 352.
- YANOFSKY, C. (1952). *Proc. nat. Acad. Sci., Wash.*, **38**, 215.
- YUDKIN, J. (1953). *Nature, Lond.*, **171**, 541.

DISCUSSION

Pontecorvo: The very important question that Dr. Pollock has raised, of whether in gene mutations one can get qualitative changes, has been in the minds of all of us for many years. Some years ago I would have agreed with him that they were mainly quantitative, but the fact that out of not more than ten cases which have been properly studied, one (i.e. tyrosinase) is of that kind is more than I would have expected.

Pollock: I don't think a thermostability change is at all a good criterion.

Pontecorvo: It is a difference in the enzyme itself.

Pollock: No, I don't think this is necessarily so. I think it could be due to association with some other molecule, which changes its thermostability. You can get changes like that, as Halvorson has shown with enzymes derived from spores. There is a profound change in thermostability, which seems to go hand in hand with solubilization of the

enzyme. I don't say that cases previously quoted do not involve qualitative changes but simply that they are not at all good examples, for that reason. One wants a purified enzyme in which one can characterize things like the molecular weight and the specific enzyme activity. Such criteria are much better than thermostability.

Davis: I think that at a sufficiently refined level of analysis one can never answer the question of whether or not a temperature-sensitive mutant, which produces an apparently temperature-sensitive enzyme, is really producing an altered enzyme. One can always ask the question: What is a true enzyme and what is an enzyme with something attached to it? It is true that changes in the environment of a protein, such as solubilization or even changes in the concentration of various solutes in the medium, can change its thermostability. Thus, Dr. Maas and I observed that the thermostability of pantothenate synthase, whether from the wild-type or from the temperature-sensitive mutant, is several degrees higher in the intact cell than in the extract. However, I think that the results of the mixture experiment excluded the possibility that the difference in thermostability of the two extracted enzymes depended on differences in their respective environments; for in this experiment the fraction that had been contributed by the mutant underwent irreversible denaturation, just as when the mutant extract was tested by itself, while the other fraction of the total enzyme activity remained unchanged. Therefore, in such a mixture, whatever the factor may be that makes one of the enzymes more stable, it is not present in an excess that can affect the other. It is a stoichiometric change in the enzyme.

Pollock: Even if you did get an association between some relatively quite small molecular weight compound which conferred thermostability on the enzyme at an earlier stage, it might well be irreversible and not be affected by the subsequent extract.

Davis: This would be a different enzyme.

Pollock: I quite accept your point here. I would only say that it is very easy to change the thermostability of enzymes by treatment. It is not the best criterion.

Slonimski: Emil Smith, in his work on papain, showed that you can chop off something like 18 amino acids without changing the enzyme activity. Therefore, you can have a partial protein molecule without any detectable change, as judged by the usual criteria of enzymic activity. It will be interesting to see whether, in such a case, there is a change in thermostability.

Lederberg: There is really a much more fundamental difficulty in trying to distinguish between qualitative and quantitative changes. The cell produces what it chooses, not necessarily all that it can produce. Even in the case of the human haemoglobin the wild genotype is perfectly capable of making foetal haemoglobin and does so during embryonic life. But in the course of normal development there is a transition to the formation of typical adult haemoglobin. There are certain mutations which prevent this changeover and the result is that in the adult individual of mutant genotype you then get large amounts of foetal haemoglobin instead. If you did not know all the developmental details you

would say that this gene was responsible for a shift in the production of one haemoglobin as against another, whereas in fact it is responsible for suppressing one potentiality and the persistence of another one. This is a difficulty which can be applied to any possible case of mutation affecting the specific properties of protein which have been produced. You have no way of telling whether the original genotype could have produced this new protein if it had "wanted" to, perhaps changing the conditions under which it may "want" to. If we disregard that, we can allude to a considerable series of mutational changes of antigenic specificity in the protein of the flagella of *Salmonella*, which are rather readily selected for by means of antiserum. Here we have unusually favourable conditions for the detection of mutational changes affecting the specific configuration of the protein, but a detailed analysis of the chemical basis of the observed changes in immunological specificity remains to be done.

Pollock: That may be what the trouble is. Is it not possible that there you have simply got a change in the position of the antigens?

Lederberg: Absolutely, but this consideration and the one I stated before will apply to any experiment of this kind. Until we know how two types of protein are being made, so that we can say that one is being made as the direct causal alternative to the other, we shall always be able to say that we are shifting the quantitative or even topographical relations of the products of a cell.

Pollock: You mean that even if an enzyme of type A is formed in a particular strain, and on mutation a functionally similar enzyme, but of type B, is formed; and that if then one were quite unable to detect any trace of type A enzyme in the mutant, one could always say that there were traces there but they were too feeble to be detected.

Lederberg: This would apply to haemoglobin in adult man.

Pollock: I agree, but I was visualizing the possibility of there being a change in the structure of the system that was responsible for forming the protein; that one might substitute itself for the other and that they could not really exist together.

Lederberg: I am not proposing that any bacterium is potentially capable of producing any enzyme that humans do. I am proposing that this is rather a sterile question as far as experimental procedures at the present time are concerned, until we understand more directly the way in which specific proteins are formed and how they are determined by the genetic material.

Barber: Was it possible, by a simple process of enzyme adaptation, to increase penicillinase production in strain 5?

Pollock: No, the 5 and 5P and 5B strains are not inducible under any conditions; nor do they give rise to inducible mutants.

Alexander: Since in successive generations the amount of penicillinase per bacterium goes down, have you proved that this is because the amount produced by each individual organism goes down, or could it be that they are just getting diluted out, i.e. that some retain the full activity and some don't produce any?

Pollock: It could be the latter, yes. It would be very interesting to

know, but we have not succeeded in getting a test critical enough to decide this.

Alexander: The type of dilution technique which Prof. Cavalli-Sforza described this morning could presumably be used.

Pollock: No, because it is not a genetically stable phenomenon. It is only possible to test indirectly the penicillinase-forming ability of individual cells. Theoretically that could be done by penicillin sensitivity, but I am not sure that it is sufficiently sensitive to allow one to decide whether the enzyme-forming property is homogeneously distributed or whether it is confined to the original cells induced.

Barber: The staphylococcus penicillinase-producing culture will quite frequently throw off variants which produce practically no penicillinase. Is that the case with your 569 strain?

Pollock: No, we never have a complete negative. I should point out that we could show, by a reconstruction test, that the low activity of 5 was not due to the presence of 5P and 5B mutants in the 5 culture. We don't know how homogeneously the property forming small amounts of penicillinase is distributed amongst individual clones of strain 5; but 5 cultures are never penicillinase-negative.

Pontecorvo: You would not be able to identify negative strains if you got them. Suppose a strain, instead of having 50 molecules per cell, had none: the only way would be to test millions of single cell isolates.

Pollock: You cannot completely eliminate the possibility of there being some true negatives. But the sensitivity of the micro-assay method is much more than 50 molecules per cell. You can get it down to 50 times that sensitivity quite easily. There may not be a stable genetic distribution of the property amongst individual cells, but you get a very constant level of activity from different 5 colonies. If you go on isolating from individual colonies you always find about the same amount of enzyme, so I suspect it is fairly evenly distributed.

Alexander: Would you get the same rate of penicillinase production if you irradiated an enzyme so as to stop it from dividing?

Pollock: Yes, you can give doses of ultraviolet which will almost completely stop cell division and cause 99·9 per cent reduction in viable count, with very little effect on the enzyme-forming ability, at least for an hour or so.

Alexander: That would indicate that it is probably the ability to produce penicillinase that is diluted out and that you have the same number of penicillinase-producing bacteria at the beginning of the hour as at the end of the hour, when there are very many more organisms.

Pollock: I don't see how you can draw any conclusions about the distribution of the enzyme-forming ability from that.

Stoker: Is the slower growth of the constitutive mutant true only of 569?

Pollock: No, 569/H devotes between 1 and 2 per cent of its synthetic powers to forming an apparently useless enzyme. One would like to think that it makes it up by not growing so rapidly, but it does not fit in. For one thing that would be a very small change in relative growth rate, whereas in fact there is a difference of about 20 per cent. Furthermore, it

certainly does not apply to the 5→5/B mutation; 5/B grows at exactly the same rate as 5, although there is roughly the same relative difference between these two strains as between 569 and 569/H, in rate of penicillinase formation.

Lederberg: Is there a difference in growth rate between 569 in the presence and in the absence of penicillin? This would be another basis for comparison of cells that are and are not making enzymes. It could be used as a method of inducing penicillinase formation to see if that slows down the growth rate, in an inducible strain.

Pollock: No, there is not.

Knox: How do you measure sensitivity to penicillin?

Pollock: We plate either vegetative cells or spores in plates containing different concentrations of penicillin and titre at the concentration which will be necessary to prevent, on an average, 50 per cent of the spores developing into colonies.

Knox: What is the inoculum size?

Pollock: Such that you can count individual colonies on a plate quite easily. If you had a lot you would destroy the penicillin.

Stocker: Is it the case that strain 569 can be grown, for instance, under conditions in which it is unable to respond to penicillin? One might then find an enhanced difference in sensitivity to penicillin, for instance, by plating preadapted and non-preadapted spores on penicillin agar at 44°, or anaerobically.

Knox: We followed up Pollock's observation about temperature, and we found, as you would expect, that penicillin sensitivity did enormously depend on the temperature at which the test was carried out (Knox, R., and Collard, P. (1952), *J. gen. Microbiol.*, 6, 369). At 42° the organisms were highly sensitive, at 37° they appeared resistant.

Stocker: Did it also depend on the previous history of the inoculum, as to exposure to penicillin when tested at the high temperature?

Knox: It depended both on the size of the inoculum and on the previous history. At 42° adapted cells were able to grow in 10–100 times greater concentrations of penicillin than unadapted cells.

Pollock: It is very difficult to get dissociation between induction of penicillinase formation and growth.

Slonimski: Do you have a specific inhibitor for the induction?

Pollock: All one gets is competition between two inducers with different inducing powers. It is rather doubtful whether one can look on that as specific inhibition of induction, but there does appear to be competition for a specific site on the cells.

Slonimski: The difficulty in testing the penicillin sensitivity of strain 569 lies in the fact that it forms an enzyme so quickly that you cannot measure its sensitivity. What if you were to add to the culture of 569 the inhibitor of penicillinase formation?

Pollock: But there is only a competitive interaction between two inducers both of which are very active in inducing the enzyme, one more than the other, and if you mix them together you get a competitive interaction.

Slonimski: It might be worth a trial. Would it not be of interest for

the problem of seeing whether resistance is exactly proportional to the rate of synthesis of penicillinase?

Pollock: Yes, one might possibly do that.

Hayes: What about low pH's, to which I understand penicillinase-producing staphylococci are sensitive, and the enzyme is not produced?

Pollock: I admit I have not exhausted all the possibilities.

Knox: With regard to the relation between penicillin sensitivity and the type of penicillinase, have you tested all these strains at say 42° or 43°?

Pollock: No, I have not, but it might be interesting.

Knox: You might get a better correlation between penicillin sensitivity and the amount of enzyme initially present.

Hotchkiss: Does the amount of penicillinase in your unit correspond approximately to the amount which could destroy an appreciable part of the penicillin in the medium? In other words, I assume that when you say that a strain having penicillinase has resistance to 10 units you must be measuring under conditions in which penicillin is maintained at approximately 10 units. This must mean that you do not destroy very much by this system.

Pollock: It is rather surprising that you can produce such a lot of enzyme and still not have a very resistant organism; also that you can find a strain producing, for instance, 15 molecules of penicillinase per cell and have an organism almost as sensitive as the most sensitive of staphylococci.

Hotchkiss: You can see that the question has a general bearing on the survival of the cell; whether for other systems, too, the amount of inducible protein can be such that it can change response to drugs.

DIRECTED HEREDITARY CHANGES OF FERMENTATIVE PROPERTIES OF YEAST BY A SPECIFIC SUBSTRATE

K. V. KOSSIKOV

Institute of Genetics, Academy of Sciences of the U.S.S.R., Moscow

INVESTIGATIONS into the directed changes of micro-organisms are in full swing in the Soviet Union. At the end of 1951, a conference devoted to this problem was organized under the auspices of the Institute of Microbiology of the Academy of Sciences of the U.S.S.R., the transactions of which were published in 1952. Monographs on the variability of micro-organisms were published by Kalina (1952) and Muromzev (1953). Investigations are under way on the adaptation of micro-organisms to various toxic substances (Imshenetsky, 1953; Planelies and Moroz, 1956; and others).

The extensive experimental data obtained in recent years have shown more clearly the inconsistency of the mutation selection theory in explaining the phenomena of adaptation of micro-organisms to various bactericidal substances and to new sources of nutrition. The nature and speed of the adaptational changes occurring in these organisms, the quantitative and qualitative dependence of these changes on the dose and length of action of the substance to which the organism became adapted, and also a number of other factors observed in the study of these phenomena cannot be accounted for by mere selection of spontaneous mutations.

Dean and Hinshelwood (1953), discussing the main issues of the theory of spontaneous mutations, and of the selection that follows them, came to the conclusion that in some cases, at any rate, changes may occur in populations—according to this theory—which do not take place in reality.

The need to explain these phenomena, starting from other

theoretical assumptions, is becoming more and more urgent. It is reasonable to base these assumptions on the direct influence of environmental factors on the variability of microorganisms; and by so doing we can easily explain the above-mentioned regularities in adaptive changes, and the reversion in certain cases of the adapted forms to the original type, when the adapting factors cease to exert an influence.

However, the question arises as to whether the adaptive changes can, in nature and stability, equal mutational changes, which are usually considered to be spontaneous. In other words, the question (which applies both to vegetative and sexual reproduction) is whether there appear in the process of adaptation changes, other than these already mentioned, which will be inherited even if the adapting substrate is removed from the medium.

This paper is concerned with the elucidation of these questions, and in particular with the directed changes of the fermentative properties of yeasts of some species of the genus *Saccharomyces*, and with the inheritance of new properties developed in them.

Adaptation of *Saccharomyces globosus* to Fermentation of Sucrose

The present author first observed adaptation of *S. globosus* to fermentation of sucrose in 1948, when the phenomenon occurred in a control test-tube on the sixty-seventh day after seeding. At the time, this aroused the interest of the present author because it could not be readily accounted for by the appearance of the adaptive enzyme (cf. fermentation of galactose by certain yeasts), and it led to the systematic investigation of the variability of fermentative properties of *S. globosus* and other yeasts (Kossikov, 1948, 1951, 1952, 1954).

We investigated cultures obtained from single spores of *S. globosus* 349. During the germination of spores, diploidization occurred resulting in the development of homozygous diploid

cultures. Each culture was first tested for its ability to ferment sugars. It was established that none of the cultures selected for the experiment fermented sucrose or maltose during 30 days of cultivation on the nutrient medium, in the presence of 2 per cent of these sugars (these sugars being the only carbohydrate source).

Special experiments were carried out with the aim of investigating the influence of cells which failed to ferment sucrose, on those capable of fermenting this sugar (in a mixed culture). It was found that the presence of non-fermenting cells considerably retarded the fermentation of sugar. It is reasonable to expect that, during the process of adaptation, there first appears in the mass of yeast cells a single cell (or a very limited number of cells) which can ferment a specific sugar. If non-fermenting cells retard the reproduction of these particular cells, and thus hinder the demonstration of fermentative abilities of the progeny, how long will it take such a cell to propagate sufficiently in these conditions and cause the fermentation of sucrose determinable in the experiment?

To answer these questions, additional experiments were carried out which enabled us to find the maximal period necessary for detecting—in the mass of sucrose-nonfermenting cells—this one sucrose-fermenting cell.

These experiments were carried out in test-tubes with gas-traps, on a medium containing 2 per cent sucrose and 0·3 per cent autolysed yeast extract. *S. globosus* 349 was used as the sucrose-nonfermenting culture. The sucrose-fermenting culture was obtained from the adapted cell from the same strain, *S. globosus* 349, by cultivating this strain on the medium with sucrose. Preliminary tests showed that the ability to ferment sucrose, developed by this cell, was very strongly heritable.

In the first series of experiments there were three variants of yeast dilutions, the yeasts being of the sucrose-nonfermenting type. In the first variant the test-tubes were filled with 350–400 million, in the second variant with 3–4 million and in the third variant with 35–40 thousand sucrose-nonfermenting

cells. The fourth variant was the control, where no sucrose-nonfermenting cells were present. After the sucrose-nonfermenting cells had been introduced into the test-tubes, one sucrose-fermenting cell was added to each test-tube of each variant (20 test-tubes per variant). Observations of fermentation of experimental and control cultures were continued for a period of 45 days. A second series of experiments was carried out along the same lines. The results of both series of experiments are shown in Table I.

Table I shows that the increase in concentration of sucrose-nonfermenting cells corresponds with an increase in the time which elapsed between the addition of one sucrose-fermenting cell and the appearance of the first signs of fermentation. If in the absence of sucrose-nonfermenting cells fermentation begins on the third or fourth day, then in the presence of sucrose-nonfermenting cells we observe a retardation of fermentation by approximately 15–20 days. In one case, fermentation commenced only on the twenty-fourth day. However, no very long delay was noted although observations were continued over a period of up to 45 days.

Experiment 1. The above data demonstrate that in order to see spontaneous mutation, a 10-day period of observation of the process of fermentation is not long enough. In the conditions of our experiments the maximal period was 24 days. The above results were taken into account in our first experiment, and we increased the content of sucrose in the medium to 6 per cent, adding 0.75 per cent glucose to the sucrose. It was suggested that, firstly, the yeast cells were propagating and fermenting glucose to form a fermentative type, and that thus the transition to sucrose-fermenting cells was made easier—provided these cells can produce invertase. Secondly, the increased sucrose concentration in the medium could also, to some extent, lead to an increased effect on variability—provided that the presence of this sugar in the medium stimulates the formation of invertase by the cell. A medium containing 6 per cent lactose and 0.75 per cent glucose was also prepared. The number of cultures used in the experiment was

Table I
 VIABILITY OF SOME SUCROSE-FERMENTING CELLS AND APPEARANCE OF THEIR FERMENTATIVE PROPERTIES
 IN PURE AND MIXED CULTURES

Serial No.	Number of sucrose-fermenting cells per single sucrose-fermenting cell	Number of test-tubes in experiment	Number of cultures that started fermenting	Beginning of fermentation (in days)								
				3-4	5-8	9-12	13-16	17-20	21-24	24-45		
1	350-400 million	20	1	—	—	—	—	—	—	—	—	—
	3·5-4 million	20	1	—	—	—	—	—	—	1	—	—
	35-40 thousand	20	2	—	—	—	1	1	—	—	—	—
	0	20	4	4	—	—	—	—	—	—	—	—
2	450-500 million	20	3	—	—	—	—	—	2	1	—	—
	4·5-5 million	20	3	—	—	—	1	2	—	—	—	—
	45-50 thousand	20	12	1	3	1	6	1	—	—	—	—
	0	20	7	7	—	—	—	—	—	—	—	—
	Total	160	33	12	3	1	8	6	3	0		

221. The test-tubes in the experiment were kept under observation for 225 days.

During the first three days slight fermentation was observed in all the test-tubes, as evidenced by a slight evolution of carbon dioxide resulting from glucose fermentation. On the fourth to fifth day fermentation ceased. A certain amount of carbon dioxide accumulated in the gas-traps of almost every test-tube (occupying not more than one-twentieth the volume of the gas-traps).

Further observation of fermentation was made, the control starting-point being a notch on the wall of the test-tube. If amount of carbon dioxide in the gas-trap tended to increase, it was assumed that fermentation had occurred due to adaptation of a culture to fermentation of sucrose or lactose, respectively. On the twenty-eighth day following seeding, an increase was noted in the amount of carbon dioxide in the gas-traps of two of the test-tubes which contained sucrose. Another culture began to ferment sucrose on the eighty-fourth day. In order to ascertain whether what had occurred in this experiment was really the adaptation of cells of a given culture to the fermentation of sucrose, the fermented culture was reseeded onto the medium with sucrose, without adding glucose. It was believed that in the three-stage consecutive fermentation of sucrose by the adapted culture, certain cells developed which transmit this quality of fermentation to the progeny. In the course of 208 days, another 21 cultures of cells were seen to have started fermenting. None of the cultures trained on lactose became adapted to fermentation of this sugar during the same period of time.

Fresh medium (2.0 ml.), consisting of 6 per cent sucrose and 0.4 per cent autolysed yeast extract, was added to the test-tubes containing lactose, 208 days after commencement of the experiment. Fresh medium (2.0 ml.), consisting of 6 per cent lactose and 0.4 per cent autolysed yeast extract was added to the test-tubes containing sucrose. This was the commencement of tests for spontaneous changes. It was assumed that if even one single cell in a culture maintained on

lactose acquired the capacity to ferment sucrose, the addition of sucrose to the medium would cause reproduction to occur. The same might occur in the corresponding case of a culture maintained on sucrose.

On the seventeenth day after addition of fresh medium to the test-tubes (during which time four more cultures had become adapted to fermentation of sucrose), cells from these test-tubes were transferred to those provided with gas-traps and fresh medium. The cultures which were kept initially on sucrose medium, and to which we added 2.0 ml. of a medium with lactose, were now transferred to the medium containing 6.0 per cent lactose and 0.4 per cent autolysed yeast extract. Cultures initially kept on lactose medium, and to which we had added 2.0 ml. of a medium with sucrose, were now transferred to the medium containing 6 per cent sucrose and 0.4 per cent autolysed yeast extract. Observation of fermentation was continued for a further 28 days. Therefore, each culture initially seeded into the sucrose medium could develop on the medium in the presence of lactose for a 45-day period following the 208-day cultivation on sucrose. If lactose-fermenting cells had developed in such cultures, they would have started fermenting this sugar; however, no cultures were detected which had adapted to fermentation of lactose.

Somewhat different results were obtained in the work with cultures initially kept on the lactose medium and later transferred to the sucrose medium. It was to be expected that, in this case, during the 45-day cultivation period of experimental cultures on the medium with sucrose, cells would develop which would be adapted to fermentation of sucrose. The essential question, however, was: on which day after the contact with sucrose did fermentation begin, and how many fermenting cultures appeared? In fact, of the 221 cultures, only 2 were found to be adapted to fermentation of sucrose; and one of these started fermenting sucrose on the twenty-eighth day, and the other on the thirtieth day after contact with sucrose. This experiment shows that, during cultivation on lactose, no cells developed which were capable

of fermenting sucrose. If, in the mass of cells, there had been even one cell capable of fermenting sucrose, fermentation would have begun and would have been evident not later than 24 days after contact with sucrose (see Table I).

The two cultures, which began fermenting sucrose after having been maintained on lactose, should be considered to have become adapted to fermentation of sucrose during the period of their cultivation on sucrose, i.e. due to the influence of sucrose. The results of this experiment are summarized in Table II. This table shows that the ability of yeast cells to ferment sucrose is associated with the presence of this sugar in the medium.

Experiment 2. The previous experiment showed that the addition of glucose to the medium leads to some acceleration of adaptation of experimental cultures to fermentation of sucrose. It was of some interest to do the experiment without adding glucose to the medium. In contradistinction to Expt. 1, one diploid culture of *S. globosus* (obtained from a single spore) was used. The culture was seeded into Petri plates containing wort-agar. The 2-day colonies were re-seeded into test-tubes, with gas-traps, containing a medium which consisted of 4 per cent sucrose and 0.5 per cent autolysed yeast extract. Altogether, 454 test-tubes were seeded with the same number of colonies. The aim of this experiment was to demonstrate spontaneous mutation in response to sucrose-fermenting capacity during the reproduction of cells on wort-agar on Petri plates. The experiment was carried out over a period of 160 days. During this period, out of a total of 454 cultures only 5 started to ferment sucrose; the first one on the seventy-seventh day, and the other four on the eighty-sixth, 120th, 122nd and 122nd day, respectively. Taking into account the data shown in Table I, this experiment can be said to confirm completely the previous ones, and it demonstrates that, out of a great number of cultures, here again not a single case of sucrose fermentation can be explained by the theory of spontaneous mutation.

It should be pointed out that cells which do not ferment

Table II
 DIRECTED CHANGES OF FERMENTATIVE PROPERTIES OF *S. globosus* UNDER THE INFLUENCE OF THE
 SPECIFIC SUBSTRATE

<i>Type of experiment</i>	<i>Number of days required for testing</i>	<i>Number of cultures tested</i>	<i>Specific carbohydrate in medium on which yeasts were cultivated</i>	<i>Number of cultures adapted to fermentation of sugars</i>	<i>Number of cultures tested</i>	<i>Specific carbohydrate in medium on which yeasts were cultivated</i>	<i>Number of cultures adapted to fermentation of sugars</i>
Directed changes	225	221	sucrose ↓ lactose	28	221	lactose ↓ sucrose	0
"Spontaneous" changes	27	221		0	212		0

sucrose when seeded into the medium containing sucrose and autolysed yeast extract, propagate more or less intensively, especially within the first few days after seeding. In an experiment where 32–35 million cells were introduced into the test-tubes, within 6 days the number of cells had increased to 150–200 million. Later on, the reproduction of cells slowed down considerably, and only when sucrose-fermenting cells appeared in the test-tubes did the numbers of cells increase rapidly.

Testing of experimental cultures for their ability to ferment maltose: The sediment of yeast cells from each test-tube was transferred to new test-tubes, with gas-traps, containing a maltose medium. One of these cultures fermented maltose very well; this was culture 72/349, which had previously adapted to fermentation of sucrose on a sucrose medium. Subsequent reseedings showed that the ability to ferment sucrose and maltose, developed by this culture, was very strongly heritable.

The appearance of yeast cells capable of fermenting maltose in a sucrose medium was of special interest for the elucidation of the question of the nature of such changes. In the first place, it was necessary to find out how often these changes occur. In a series of experiments, 55 cultures were developed which were adapted to fermentation of sucrose, when cultivated on a sucrose medium. Out of these 55 cultures, 42 were developed from single spores of *S. globosus*, and 13 from single spores of the second generation of hybrids from *S. ellipsoideus* × *S. globosus*. These hybrids, prior to their adaptation to fermentation of sucrose, did not even ferment sucrose, let alone maltose. Many of the cultures mentioned in these experiments became adapted to fermentation of sucrose (in 2–3 seedings or more).

All 55 cultures were tested for their ability to ferment maltose. It was found that as well as culture 72/349, culture 73/349 also fermented both sucrose and maltose. Therefore, out of 42 cultures of *S. globosus*, 2 cultures became adapted on the sucrose medium to fermentation, not only of sucrose,

but also of maltose. Attention should be drawn to the fact that both these cultures developed from the same cell, which formed a 4-spore ascus. All 4 spores of this ascus germinated and produced cultures designated as cultures 72/349, 73/349, 74/349 and 75/349, respectively.

During a series of four variants of experiments on adaptation to fermentation of sucrose, culture 72/349 became adapted to fermentation of this sugar. However, it developed the ability to ferment both sucrose and maltose in only one of the four variants. During a series of six variants of our experiments, culture 73/349 became adapted to fermentation of sucrose, and in all six cases it developed the ability to ferment both sucrose and maltose. Cultures 74/349 and 75/349, in one instance each, became adapted to fermentation of sucrose, and in both instances failed to ferment maltose. Out of 13 hybrid cultures, only one (153/3), when cultivated on sucrose, proved to have become adapted to fermentation of both sucrose and maltose.

But one cannot, in this case, speak of an accidental variation of fermentative properties of yeast cells, independent of the substrate. The fact is that the effect of sucrose on the yeast cell is conditioned by the biochemical structure of the sugar. Sucrose is composed of 2 monosaccharides, glucose and fructose. Invertase acts in the same way as β -D-fructosidase; but sucrose can be split also by α -glucosidase (maltase): under certain conditions, maltase can hydrolyse not only maltose but also sucrose. Therefore, it is reasonable to expect that sucrose, which consists of glucose and fructose, can stimulate the formation not only of fructosidase but also of glucosidase. This is confirmed by experimental data obtain by the present author. Yeast cultures which fermented both sucrose and maltose failed to ferment raffinose, indicating that the enzyme α -glucosidase was present in the cells of these cultures. Cultures which fermented only sucrose (and not maltose) fermented one-third of the total amount of raffinose, indicating that the enzyme β -D-fructosidase was present in the cells of these cultures. These data led us to conclude that in the yeasts investigated

by us, when cultivated on a sucrose medium, the frequency of formation of the enzyme β -D-fructosidase was eighteen times that of the formation of the enzyme α -glucosidase.

Experiment 3. In this experiment, unlike the previous ones, adaptation to fermentation of sucrose was carried out on a solid medium with agar. The medium consisted of 4 per cent sucrose, 3 per cent glucose and 0.3 per cent autolysed yeast extract. It was poured into shallow glass plates of a capacity of 1000 ml., as much as 200 ml. being poured into one plate. The inoculum used was the 48-hour culture of *S. globosus* 349. After 3–4 days the surface of the agar was entirely covered with a layer of yeast cells multiplying in the presence of glucose. It was assumed that secondary colonies would be formed during the development of cells adapted to fermentation of sucrose. Such secondary colonies did start to appear after approximately 30–40 days of cultivation in a thermostat at 25–26° C. After 58 days, cells from 4 secondary colonies were tested for ability to ferment sucrose, and in 3 of those colonies adaptation of cells was found to have occurred. Numerous reseedings of these cells, on fresh medium containing sucrose, showed that their adaptation to fermentation of sucrose was strongly retained in all 3 cases, and is inherited by the progeny.

Adaptation of *Saccharomyces globosus* to Fermentation of Maltose

Fewer experiments were carried out to elucidate the adaptation of *S. globosus* to fermentation of maltose than were carried out in the case of adaptation to fermentation of sucrose; our data show that it is much more difficult to develop the former type of adaptation than the latter.

Experiment 1. In this experiment we used 12 cultures obtained from single spores of *S. globosus* 349, and 20 cultures obtained from single spores of second-generation hybrids (*S. globosus* \times *S. ellipsoideus*). Preliminary tests showed that neither the hybrid cultures nor the *S. globosus* cultures

fermented maltose during a period of 30 days on a medium containing maltose. The experiment was carried out in flasks fitted with Maysle gas-seals, each flask containing 50 ml. of medium. One-half of each type of culture was seeded on a medium containing 2 per cent maltose, 0·75 per cent glucose and 0·3 per cent autolysed yeast extract; and the other half was seeded on beer-wort (saccharimeter: 14°). Maltose-fermenting cultures of *S. ellipsoideus* 169 were seeded on the same media, as a control. Sugar-fermentation was registered by a decrease in the weight of the flasks due to evolution of carbon dioxide. During the first 3–4 days there was a slight decrease in the weight of all the experimental flasks, due in the one case to fermentation of glucose and in the other to fermentation of the beer-wort monosaccharides. At the end of this period (3–4 days), fermentation ceased in the experimental flasks due to the inability of cells of *S. globosus* to ferment the maltose in the medium; while in the control flasks, fermentation proceeded (as a one-peak curve) and all sugars, including maltose, were largely fermented at the end of 4–5 days. It was assumed that, in the experimental flasks, in the case of the development of cells capable of fermenting maltose, secondary fermentation would arise resulting from fermentation of maltose.

The flasks were weighed daily for a period of 107 days; and it was found that in this time fermentation began in two cases in the experimental flasks—in the one case in the flask seeded with *S. globosus* 72/349, and in the other in the flask seeded with the hybrid culture 217/3. Reseeding of cells from both these flasks, into fresh beer-wort medium (containing maltose), showed that in both cases cells had become adapted to fermentation of maltose, and this maltose-fermenting ability was retained even during numerous reseeded into wort-agar.

Experiment 2. In this case, the solid medium, wort-agar, was used for the adaptation of yeast to fermentation of maltose. The medium was poured into 4 shallow glass plates, of a capacity of 1000 ml., each plate containing 200 ml. of medium

in a 10–12 mm.-thick layer. A 48-hour culture of *S. globosus* was seeded onto the surface of the agar; and in 3–4 days this surface was covered with a thin layer of yeast cells multiplying in the presence of the wort-monosaccharides. It was expected that if cells became adapted to fermentation of maltose, they would propagate and form secondary colonies; such secondary colonies did develop after 200–300 days of cultivation at 25° C. Cells from these colonies were seeded into a medium containing maltose, in test-tubes with gas-traps. In 3 of the 14 secondary colonies tested, cells were detected which were adapted to fermentation of maltose. Numerous reseedings of these cells into liquid wort and wort-agar showed that the maltose-fermenting ability is retained in all 3 cases, and is inherited by the progeny.

Experiment 3. In this experiment on adaptation to fermentation of maltose, we used cultures of *S. globosus* which had previously become adapted to fermentation of sucrose. We used 20 such cultures, each of which was obtained from a single spore. These cultures did not differ in fermenting ability from cultures of *S. paradoxus*; both these species fermenting monosaccharides and sucrose to the same degree.

The experiment was carried out in Maysle flasks, with gas-seals, each flask containing 100 ml. beer-wort (saccharimeter: 14°) at 25–26° C. As in Expt. 1, adaptation to fermentation of maltose was determined by secondary fermentation. The flasks were weighed daily for the first ten days and then every tenth day. During the first 3–4 days there was a slight decrease in the weight of all the flasks, due to fermentation of the wort-monosaccharides. At the end of this period fermentation ceased, and only 200 days later did secondary fermentation begin in one of the flasks. Reseeding of cells from these flasks into fresh medium, containing maltose, showed that in this case cells had become adapted to fermentation of maltose. Numerous reseedings of these cells into liquid wort and wort-agar showed that this fermenting ability is strongly retained and is inherited by the progeny. The remaining 19 flasks were weighed over a period of a further

400 days, and not one of the 19 showed secondary fermentation. The results of experiments on adaptation of yeast to fermentation of maltose are shown in Table III.

Table III
ADAPTATION OF *S. globosus* TO FERMENTATION OF MALTOSE

Medium and conditions of cultivation	Number of cultures tested	Number of cultures adapted to fermentation of maltose	Duration of experiment (in days)
Beer-wort (saccharimeter : 14°) 50 ml. in Maysle gas-seal flasks	12 (strain 349)	1	107
	20 (hybrid)	1	107
Wort-agar in glass plates	14 (strain 349; secondary colonies)	3	400
Beer-wort (saccharimeter : 14°) 100 ml. in Maysle gas-seal flasks	20 (strain 349; cultures previously adapted to ferment sucrose)	1	600

Adaptation of *S. paradoxus* to fermentation of maltose and simple dextrins of malt-wort

S. paradoxus readily ferments monosaccharides and sucrose, but does not ferment maltose and dextrins of malt-wort.

Experiment 1. Cells of *S. paradoxus* 37 were seeded into 8 Maysle flasks, with gas-seals, each flask containing 200 ml. beer-wort (saccharimeter: 15°). The control flasks were seeded with *S. ellipsoideus*. The flasks were weighed daily, and when primary fermentation had ceased they were weighed every tenth day. In one of the experimental flasks, secondary fermentation began on the 350th day after the experiment was begun. Seeding of cells from this flask into fresh medium, containing maltose, showed that cells had become adapted to

fermentation of maltose. The adapted culture was designated as 37,6 m-1. At the end of 490 days, secondary fermentation was observed in a second flask. Seeding of cells from this flask into fresh medium, containing maltose, showed that cells had become adapted to fermentation of maltose. The adapted culture was designated as 37,7 m-1. The remaining 6 flasks were weighed over a period of a further 270 days, and not one of the 6 showed secondary fermentation.

Experiment 2. This experiment, in parallel with the previous one, was carried out on adaptation of *S. paradoxus* 37 to fermentation of maltose, on solid medium (wort-agar). The methods used and the experimental conditions were much the same as those used in adaptation of *S. globosus* to maltose-fermentation on wort-agar.

After approximately 350 days of cultivation, secondary colonies began to appear. Five secondary colonies were observed, 3 of which were found to be adapted to fermentation of maltose. Out of the maltose-fermenting and asci-forming colonies, we selected (by means of a micromanipulator) 29 cultures obtained from single spores, and these were tested for ability to ferment maltose. These cultures, which were designated as A37-9/2m-1-N, all fermented maltose; however, in 7 of them growth ceased and the cultures died on reseeded into wort-agar. This cell-death of adapted *S. paradoxus* on wort-agar was quite unexpected, because all cultures of *S. globosus*, which had become adapted to fermentation of maltose and sucrose, and which had also been obtained from single spores, propagated very well when reseeded into wort-agar, and retained their fermenting ability quite strongly. Besides the 7 cultures of *S. paradoxus* which died, in 3 other test-tubes almost all cells died, and in only one place—i.e. on slanting agar—did there develop one colony the cells of which propagated normally. This phenomenon observed during reseeded of maltose-fermenting cultures of *S. paradoxus* was most interesting. Cell-death did not occur immediately on seeding; the seeded cells multiplied slightly, then ceased to grow and acquired first a light brown and then a dark brown

colour. Reseeding of such cells into fresh liquid and solid media of different contents showed that the cultures could not be revived.

These data testify to the fact that different forms of *S. paradoxus* are developed as a result of their adaptation to fermentation of maltose. In one case the developed form retained its acquired maltose-fermenting property not only on reproduction in conditions of fermentation but also during reseeded into various nutrient media. In another case, the developed form retained its acquired maltose-fermenting property on reproduction in conditions of fermentation, but its vitality was lower. In inadequate conditions, not only does it lose this property (reversion), but it dies. It is quite possible that in this case alterations connected with the adaptation to fermentation of maltose led to a disturbance of some physiological processes in the cell and to disorders in cell-metabolism, under the conditions of the experiment. However, this disturbance is eliminated if a new qualitative alteration occurs and the cells become capable of propagating on wort-agar, as well as on media containing other sugars, the ability to ferment maltose being retained. This statement is confirmed by the above-cited three cases of the appearance of separate colonies in the mass of dead cells on wort-agar. When cultures selected from these 3 colonies were later reseeded, they did not differ from the other 19 cultures which were stable and quite viable from the very moment of development.

Experiment 3. In this experiment, adaptation of yeasts to the fermentation of simple dextrins of malt-wort was observed. Experimental details have already been published (Kossikov and Rayevskaya, 1956); the main results are as follows:

S. paradoxus, previously adapted to fermentation of maltose, was adapted to fermentation of simple dextrins of malt-wort by means of long training on this medium without reseeded. The ability to ferment simple dextrins was increased in further reseedings of the various cultures into fresh malt-wort. Some of the adapted cultures, obtained from single cells, began to ferment malt-wort at the same depth as

S. cerevisiae XII; the intensity of fermentation of the former was somewhat less than that of the latter, during the first 4-5 days.

The scheme of directed changes of the fermentative properties of yeasts under the influence of a specific substrate

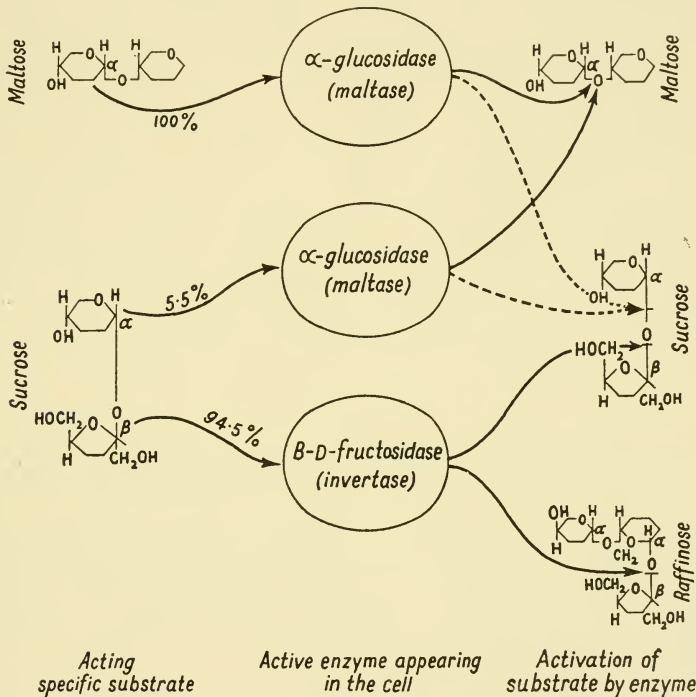

FIG. 1. Scheme of directed changes of fermentative properties of yeast under the influence of the specific substrate.

(Fig. 1) shows that on the medium containing maltose, forms of yeast have been obtained which readily ferment maltose and less readily ferment sucrose. The enzyme developed in these cells is α -glucosidase, which is known to activate maltose and sucrose.

Two forms of yeast have been obtained on the medium with sucrose. One form is analogous to that obtained on maltose;

cells of this type readily ferment maltose and less readily ferment sucrose. Therefore, the enzyme developed in these cells must be α -glucosidase. Cells of the second altered form readily ferment sucrose, and ferment one-third of raffinose, but do not ferment maltose; therefore, the enzyme developed in these cells must be β -D-fructosidase. Thus, sucrose, as the specific substrate, may cause the appearance in yeast cells of two enzymes— α -glucosidase and β -D-fructosidase—and these enzymes can activate not only sucrose and maltose but also one-third of raffinose, i.e. three different carbohydrates.

It follows from the scheme shown in Fig. 1 that the formation in yeast cells of the active enzymes, α -glucosidase and β -D-fructosidase, is due to the presence of certain carbohydrates in the cultural medium, and the biochemical specificity of these carbohydrates conforms completely to the specificity of the enzymes which they cause to appear in the cell. The mechanism of formation of these enzymes is not known.

Inheritance of Fermentative Properties developed by Yeasts as a result of Directed Changes

Because of the specificity of the reproduction of yeasts (sexual reproduction), in making a detailed study of the inheritance of fermentative properties developed in these yeasts we carried out experimental investigations of the following questions:

(a) *Inheritance of sugar-fermenting properties in sexual reproduction (spore formation)*: Cells which fermented a specific sugar were isolated from the previously adapted culture and seeded into wort-agar, where they formed asci. The spores from these asci were selected by means of a micromanipulator, and cultures obtained from single spores were tested for their ability to ferment their corresponding sugars. Observations were carried out over a period of one month.

Five different cultures adapted to fermentation of sucrose were studied. All five gave similar results showing that in

spore formation there occurred segregation in respect of the altered character. If we take into account the 4-spore asci, all the spores of which germinated and produced separate cultures, then all 16 asci obtained from these cultures showed segregation in the ratio of 2 : 2, i.e. 2 spores of each ascus formed sucrose-fermenting cultures and 2 formed sucrose-nonfermenting cultures. It should be pointed out that, in all cases, the difference in sugar-fermenting capacity of the different cultures was very well pronounced: in fermenting cultures fermentation began on the first or second day and ended on the third or fourth day; in nonfermenting cultures no sign of fermentation was observed for 30 days.

The same results have been obtained in experiments with cultures adapted to fermentation of maltose. In two cultures obtained from cells adapted to fermentation of maltose, 11 asci were investigated: all of these showed segregation in the ratio of 2 : 2, and here also the difference between fermenting and non-fermenting cultures was clearly marked.

Another type of heredity was detected in *S. paradoxus* 37, adapted to fermentation of maltose. Out of 60 isolated spores (nine 4-spore and eight 3-spore asci), 29 germinated and formed cultures. All of these fermented maltose. However, among the 4-spore asci not a single one was found in which all the spores would germinate and form cultures. Only 3 asci formed 3 viable cultures each, and in 2 cases the third culture died when reseeded into wort-agar. In one case, one viable colony was formed in a culture among the mass of dead cells. As regards the remaining asci, only 1 or 2 spores proved to be viable.

The fact that all 29 cultures obtained from single spores of the altered cells formed maltose-fermenting cultures gives us ground for suggesting that, in these cultures, segregation does not occur in respect of the altered character. The most likely assumption, in this case, would be that adaptation to fermentation of maltose occurs in the haploid phase of cell development, i.e. in the time between germination of spores and formation of the haploid cell, and fusion of this with a similar

haploid cell. Since the culture of *S. paradoxus* readily produced spores, and adaptation occurred on a solid medium (wort-agar), the presence of a sufficient number of spores has thus been provided for. However, a different explanation is also possible: cells adapted to fermentation of maltose were heterozygous as regards this capacity; in the process of spore-formation they formed spores which yielded not only viable maltose-fermenting cultures but also maltose-fermenting cultures of low viability. It was these cells that died during reseeded on wort-agar.

(b) *Stability of fermentative properties developed during cultivation on agar medium containing other sugars:* Cultures obtained from single spores were inoculated into wort-agar after it had been found that they fermented their corresponding sugar. When yeasts adapted to fermentation of maltose were reseeded into wort-agar, the conditions of existence were changed (aerobic instead of anaerobic), but the mass of the nutrient substrate contained the same sugar, i.e. maltose. In the case of yeasts adapted to fermentation of sucrose not only were the conditions of existence changed, but also the substrate, since the wort-agar contained a very slight percentage of sucrose.

So as to exclude completely from the medium the sugar to which the cells had become adapted, the experimental cultures (after having been trained on wort-agar) were reseeded into agar with galactose (3 per cent galactose; 0.4 per cent autolysed yeast extract). Here, the altered cells did not need to use their newly acquired ability to form an active enzyme, since galactose can be fermented by the original unaltered yeast.

Sixty-six of the cultures, adapted to fermentation of sucrose, were tested. They were cultivated on wort-agar for 261–628 days. None of the cultures tested lost their ability to ferment sucrose; in fact, this ability was retained undiminished. When the same cultures were cultivated on the medium containing galactose for 53–54 days, they retained their ability to ferment sucrose and only in 8 of them was this

ability diminished. Twenty-seven of the cultures adapted to fermentation of maltose were tested. All of these after having been cultivated on wort-agar (for 268–509 days) and after having been cultivated on the medium containing galactose (for 54–56 days) completely retained their ability to ferment maltose.

(c) *Inheritance of fermentative properties, developed by yeasts, when crossed with their original forms:* When cultures adapted to fermentation of sucrose were crossed, by coupling of spores, with the original *S. globosus* 349, a hybrid was obtained which readily fermented sucrose; this experiment was indicative of the dominance of the sugar-fermenting property in the first generation. In the second sexual generation we tested twenty 4-spore asci, all 80 spores of which germinated and produced viable cultures. The tests for the ability to ferment sucrose were continued over a period of one month. It was found that nineteen asci showed very pronounced segregation as regards the ability to ferment sucrose, i.e. in the ratio 2 : 2, and one ascus in the ratio 3 : 1.

When cultures adapted to fermentation of maltose were crossed with the original *S. globosus* 349, a hybrid was obtained which readily fermented maltose. In the second sexual generation we tested thirteen 4-spore asci, all of which showed segregation as regards the ability to ferment maltose, in the ratio 2 : 2.

(d) *Comparative analysis of fermentative properties of original, altered and some other forms of yeasts having a close affinity between them:* As a result of experiments carried out by the author on adaptation of *S. globosus* to fermentation of sucrose and maltose, and of *S. paradoxus* to fermentation of maltose and simple dextrins of malt-wort, new forms were obtained which differed from the original strains as regards their fermentative properties; those obtained from *S. globosus* are divided into 4 groups:

Group 1. In contradistinction to *S. globosus*, these forms ferment not only monosaccharides, but also sucrose and

one-third of raffinose. Therefore, they acquired the ability to produce the active enzyme β -D-fructosidase.

Group 2. These forms ferment not only monosaccharides, but also maltose. Therefore, they acquired the ability to produce the active enzyme α -glucosidase.

Group 3. These forms ferment maltose and sucrose but fail to ferment raffinose. As has already been mentioned, in this case sucrose is hydrolysed by the enzyme maltase. These forms do not differ from the preceding ones in the type of enzyme produced. However, since the ability to produce the active enzyme maltase was developed in this case on the medium containing sucrose, these forms readily ferment sucrose already within the first 10 days, while the cultures of the preceding group failed to ferment sucrose within the same period of time.

Group 4. These forms ferment not only monosaccharides, but also sucrose, maltose and one-third of raffinose. They were obtained in two stages: first a culture of *S. globosus* 74/349 was adapted to fermentation of sucrose; then this was adapted to fermentation of maltose on a medium containing maltose.

The forms obtained from *S. paradoxus* are divided into 2 groups, based on differences in fermentative properties:

Group 1. In contradistinction to *S. paradoxus*, these forms ferment maltose. Therefore, they acquired the ability to produce the active enzyme α -glucosidase.

Group 2. After long cultivation on beer-wort, cultures previously adapted to fermentation of maltose (group 1) became adapted to fermentation of simple dextrins of malt-wort.

The above-mentioned altered forms, obtained from *S. globosus* and *S. paradoxus*, were studied in comparable conditions, with the aim of estimating their sugar-fermenting capacity and the depth at which beer-wort is fermented. In parallel experiments, we also studied in comparable conditions cultures of original forms of *S. globosus*, *S. paradoxus*, *S. chodati*, *S. ellipsoideus* and *S. cerevisiae*. The last three species were used for comparison with the altered forms.

The fermenting medium contained 10 per cent of the required sugar and yeast extract. The substances tried were glucose, galactose, sucrose, maltose, raffinose and the

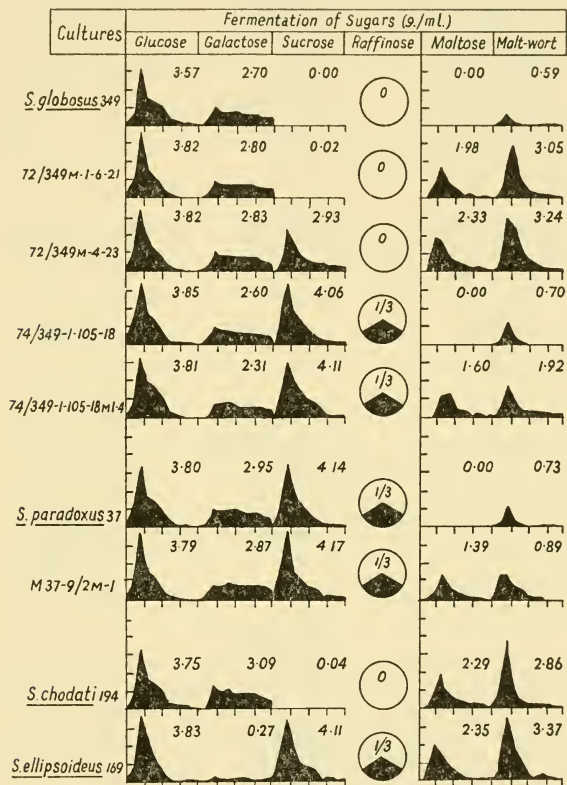

FIG. 2. Fermentative properties of original, altered and some other types of yeast. Upper borderline of shaded portions = curve of fermentation of sugars. Numbers above the curves of fermentation indicate the amount of CO₂ produced during fermentation (in g./100 ml. medium). Only one-third, if any, raffinose was fermented.

usual beer-wort (saccharimeter : 13.5°). The experiments were carried out at a temperature of 25–26° C, over a period of 10 days; results are shown in Fig. 2. Characteristic curves

show the intensity of fermentation for each day. The capacity to ferment raffinose is shown in comparison with the raffinose-fermenting capacity of *S. carlsbergensis*.

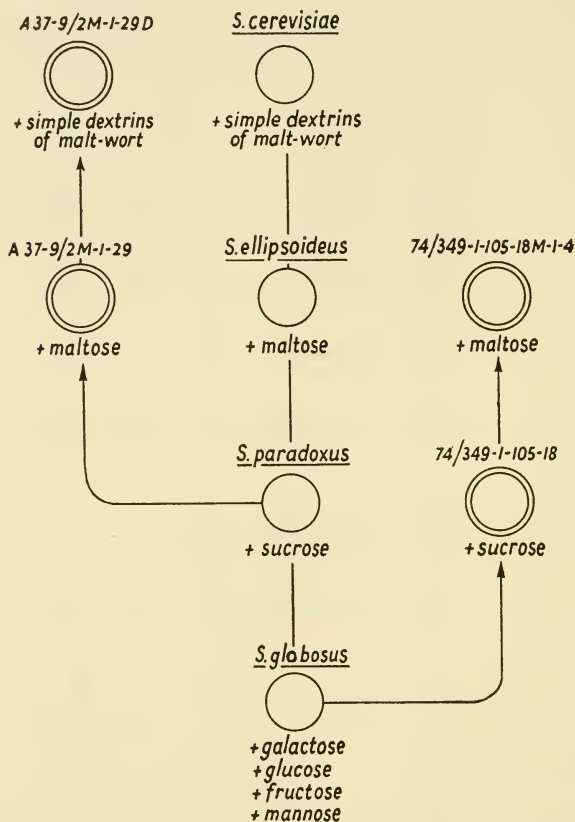

FIG. 3. Fermentative properties of some species of *Saccharomyces* (centre) and of forms obtained experimentally (left and right).

The existing classification of species of yeast of the genus *Saccharomyces* is based on behaviour toward various sugars, i.e. they are classified mainly according to their ability to ferment a specific sugar. On comparison of the data on fermentation of various sugars by altered forms of yeasts

with the data on species of the genus *Saccharomyces* (which species are rather close to the altered forms of yeasts), we concluded that it has been possible to obtain experimentally, from *S. globosus*, new forms which may be referred to the following 3 species: *S. paradoxus* (group 1); *S. chodati* (group 2) and *S. ellipsoideus* (group 4). The forms obtained

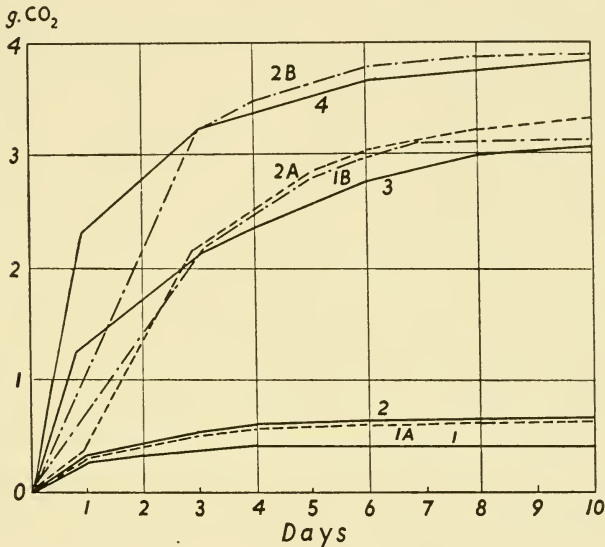

FIG. 4. Fermentation of malt-wort by certain species of *Saccharomyces*, and by new forms obtained experimentally. 1. *S. globosus*; 2. *S. paradoxus*; 3. *S. ellipsoideus*; 4. *S. cerevisiae* XII. Altered forms produced from *S. globosus*: 1A-74/349-1-105-18; 1B-74/349-1-105-18m-1-4. Altered forms produced from *S. paradoxus*: 2A-A37-9/2m-1-29; 2B-A37-9/2-1-29d.

from *S. paradoxus* may be referred to 2 species: *S. ellipsoideus* (group 4) and *S. cerevisiae* (group 2).

These data testify to the fact that by cultivating yeasts of the genus *Saccharomyces* on their specific substrates, it is possible to induce changes in species characters. The scheme of variation is shown in Fig. 3. Fig. 4 shows the intensity of fermentation and the depth at which malt-wort is fermented

by the altered forms, and also by the original forms and by *S. ellipsoideus* and *S. cerevisiae*.

Discussion

The experimental data quoted above enable us to give a positive reply to the question on the stability of directed adaptive changes, which was raised at the beginning of this paper. These changes take place under the direct influence of the specific substrate, and are not only quantitative but also qualitative, i.e. they lead to the development of a new quality. This quality is expressed in the capacity to produce active invertase (or maltase), hydrolyse and ferment sucrose (or maltose), retain this capacity and transmit it to the progeny. It should be pointed out that in the investigations of Oparin, Helman and Elpiner (1954), on extracts of *S. globosus* cells subject to the action of supersonic waves, it was possible to detect very small quantities of invertase. This experiment confirmed the data obtained by Yurkevitch (1950), that active invertase is not found in intact cells and after short autolysis. The appearance of invertase due to the influence of supersonic waves is explained by Oparin, Helman and Elpiner as the freeing of invertase from stable compounds of the protoplasm. The hydrolytic activity of the enzyme is completely inhibited in the process of growth and reproduction of cells. Oparin, Helman and Zhukova (1954), in further investigations on cells previously adapted by the present author to fermentation of sucrose, but trained on a medium without this sugar, and subject to the action of supersonic waves, found an invertase activity 20 times as great as that which was found in the original cells not adapted to fermentation of sucrose but subject to the action of supersonic waves. It should be noted that great changes occurred in the carbohydrate content of the adapted cells.

If we consider the variations occurring in the organisms as being directed ones, i.e. caused by changes in the conditions of their development, this does not mean that we should

agree that there exists only one type of mechanism of development of these variations, and that we should consider them either as being unstable (bearing on quantitative shifts in the enzymic organization of cells) or stable ones of the mutation type. In each and every case, the character of variation will be determined by the nature of the organism undergoing change and by the peculiarities of the factor which exerts its influence in those organisms. As regards the variation in fermentative properties of yeasts, one can speak of four types of adapted variations based on existing experimental data:

The first type of variation involves the fermentative system of the cell. An example of this type of variation is the capacity acquired by the yeast cell to split sucrose by means of maltase. This is not a case of qualitative change in the fermentative system, but of alterations in the permeability of the cell (Oparin, Helman and Zhukova, 1955). As our investigations have shown, a most important factor here is the substrate on which the cell acquires the ability to produce the active enzyme maltase. If this ability is acquired on a medium containing maltose then the splitting of sucrose usually becomes difficult. Cultures obtained in this way from *S. globosus* start to ferment sucrose usually after a lapse of 10 days, but ferment maltose in 1–2 days. The same cultures of *S. globosus*, if they acquire the ability to produce the active enzyme maltase on a medium containing sucrose, will ferment sucrose within the first 2–3 days. In both cases hydrolysis of sucrose is effected by maltase. The time of cultivation of such cells on the sucrose medium is also of great significance. *S. heterogenicus*, *S. protoserdovi* and *S. chodati* were tested for ability to ferment maltose and sucrose (but not raffinose), and it was demonstrated (Kossikov, Helman and Rayevskaya, 1956) that all of these hydrolyse sucrose by means of maltase, since maltase but not invertase was detected in the cells after fermentation of sucrose. Fermentation of sucrose in these species began at varying times (from 2 to 5 days).

The second type of variation was detected in the adaptation of *S. paradoxus* to fermentation of maltose. In this case, the

adapted form did not prove to be very viable, but propagated more or less normally for some time in very strictly defined conditions. In inadequate conditions, not only does this form lose its acquired property (reversion), as one would expect, but it dies off altogether. This form can become viable only if some new qualitative change occurs in it. To the same type of variation belong 10 cultures out of 29 obtained from single spores of *S. paradoxus* 37, adapted to fermentation of maltose; 3 out of these 10 cultures developed (on wort-agar) stable colonies which readily ferment maltose.

The third type of variation is characterized by the appearance in the cells (under the influence of the specific substrate) of the so-called adaptive enzymes which are produced only when there is an adequate specific substrate in the medium. If the specific substrate is removed from the medium the cells no longer produce the enzyme, and they lose their acquired property. This type of variation is known to exist among yeasts of the genus *Saccharomyces* during their adaptation to fermentation of galactose and melibiose. One would think that during prolonged cultivation on the medium with the adequate sugar (as the only source of carbohydrate), cells would develop which could retain the ability to produce an adequate enzyme, the specific substrate being absent from the medium.

The fourth type of variation is that where cells retain the acquired ability to produce an active enzyme, ferment an adequate sugar and transmit this capacity to the progeny after reseeded into media not containing this sugar. In sexual reproduction (spore formation) the altered cells become segregated. An example of this is found in the adaptation of *S. globosus* to fermentation of sucrose and maltose, and of *S. paradoxus* to fermentation of maltose.

Experiments to determine quantitatively the sucrose-fermenting activity of invertase in original cultures of *S. globosus*, in heterozygous cultures adapted to fermentation of sucrose and in homozygous cultures (these last being obtained from heterozygous cultures through spore formation), gave

very interesting results. It was found that in the cells of the heterozygous cultures, the activity of invertase was only one-half of that in the homozygous cultures. Not only the original *S. globosus* cultures, but also those obtained from heterozygous cells, but failing to ferment sucrose, have no active invertase in the intact cell (Kossikov and Rayevskaya, 1957).*

The experimental data on the inheritance of sucrose-fermenting ability during spore formation and on the activity of invertase in heterozygous and homozygous cells, give us grounds to believe that, in this case, in the process of adaptation to fermentation of sucrose the ability to produce the active enzyme invertase appears in the cell. As yet, it is difficult to say whether this capacity is related to the nuclear or other structural elements of the cell. The detection of an invertase activity in the homozygous diploid culture, twice as high as that in the heterozygous diploid culture, leads us to conclude that the production of invertase is related to biochemical reactions and structures characteristic of the haploid cell. Fig. 5 shows the scheme of inheritance, by *S. globosus* cells, of the ability to ferment sucrose during sexual reproduction.

Can one speak in this case of the heritability of acquired characters? The sum-total of our data bearing on the stability and heritability of new enzymic properties of yeast, developed in the process of adaptation to fermentation of sugars (fourth type of variation), leads us to answer this question in the affirmative. However, one should bear in mind that not every single character acquired by the organism is inherited. What we are referring to is the heritability of those characters which arise as a result of changes in the *modus vivendi*, this change leading to stable variations in cell metabolism and to alterations in cell function.

* The activity of invertase was determined by the Berthran method. Cultures failing to ferment sucrose had no active invertase if they were obtained from cells cultivated for a long time in the presence of sucrose or from the spores of heterozygous cultures. The activity of invertase adapted to fermentation of sucrose in the heterozygous cultures was 17 and in the homozygous cultures was 34 (expressed in mg. of glucose per 10 mg. of pressed yeast during 60 min.).

If we accept that the cell structure is the manifestation of the specificity of metabolic processes occurring in this cell, and that alterations in metabolism are the principal or really the sole cause of the development of new forms, we can then clearly understand the (usually negative) action of irradiation,

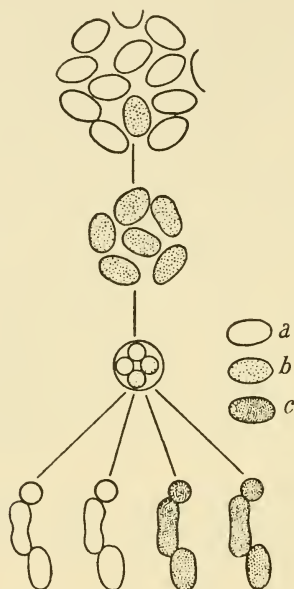

FIG. 5. Scheme of inheritance, by *S. globosus* cells, of newly acquired ability to ferment sucrose during sexual reproduction (spore formation).

- a*: non-fermenting sucrose, invertase activity = 0;
b: fermenting sucrose, invertase activity = +;
c: fermenting sucrose, invertase activity = ++.

leading to disturbances in structure and function, and the creative rôle of induced change in metabolism in the process of adaptation to the changed *modus vivendi*.

Certainly, the substrate cannot cause changes, in all cases and under all conditions, which will remain stable in the progeny. We believe that, as a rule, it is those changes connected with the necessity of adaptation to new sources of

nutrition and to changed conditions of existence that lead to alterations in the chain of biochemical reactions and in the corresponding structural elements of the cell. This conclusion is very simple and at the same time natural, since the constantly observed close interrelationship of the organism with the conditions of its existence testifies to the fact that these conditions are not only the most essential source of development but are also the cause of changes in the organism. The experimental data on the increase of the fermentative properties of yeast, the increase being connected with the acquisition of new hereditary stable functions (under the influence of the specific substrate), confirms this assumption. These are, undoubtedly, positive hereditary changes. The evolutionary significance of this type of change is unquestionable.

Directed changes in the ability to ferment galactose under the influence of the substrate (galactose) were observed by Lindegren and Pittman (1953). Lindegren (1956) believes that what happened, in this case, was the restoration of the recessive locus which evidently had formerly been active but had been damaged and inactivated; so that the non-functioning recessive gene again became functional and active (dominant). Although in this case we speak about restoration of the lost function and, according to Lindegren, restoration takes place due to mutations under the influence of galactose but not of lactose, we failed to detect this type of mutation occurring spontaneously. These data, if considered along the lines already mentioned, can be considered as confirmation of the directed hereditary changes of the fermentative properties of yeast, under the influence of the specific substrate, which were observed in our experiments (Kossikov, 1948, 1951, 1952).

Conclusion

(1) Our experiments carried out in the course of the last eight years, on directed changes of fermentative properties of *S. globosus*, *S. paradoxus* and other yeasts under the influence of a specific substrate, have shown that in these cases single

cells arise which are capable of fermenting an adequate sugar. In control experiments we found no changes of a kind which could be explained as the appearance of spontaneous mutations.

(2) The study of inheritance by yeast cells of the properties which arose as a result of adaptation to fermentation of sucrose and maltose has shown that these properties are transmitted to offspring not only in vegetative but also in sexual reproduction (spore formation). In the latter case segregation was observed. One-half of the spores formed by altered cells usually give cultures which ferment sugar, the remainder form cultures which do not ferment an adequate sugar. In *S. paradoxus* forms were also obtained, adapted to fermentation of maltose, which on sexual reproduction did not show segregation.

(3) The control of the stability of fermentative properties acquired by yeast when resown in agar media containing other sugars has shown that the capacity to ferment both sucrose and maltose remains stable.

(4) Stability of fermentative properties which arose in the cells is clearly evident, also, in crossing altered strains with original (unaltered) strains. We obtained a dominant capacity to ferment an adequate sugar in the first generation and a segregation by the same characteristics in the second sexual generation.

All these experimental data testify to the fact that directed hereditary changes were obtained under the influence of the substrate.

(5) As a result of our experiments we obtained new forms. From *S. globosus* we obtained: (i) forms additionally fermenting sucrose and one-third of raffinose; (ii) forms additionally fermenting maltose, and (iii) forms additionally fermenting sucrose, maltose and one-third of raffinose. These forms may be classified, according to their fermentative capacities, as species of *S. paradoxus*, *S. chodati* and *S. ellipsoideus* respectively.

From *S. paradoxus* we obtained: (i) forms additionally fermenting maltose and (ii) forms additionally fermenting

maltose and simple dextrans of malt-wort. These forms may be classified as species of *S. ellipsoideus* and *S. cerevisiae*, respectively.

(6) Biochemical investigation has shown that the active enzyme invertase is found in intact cells, adapted to fermentation of sucrose and grown on a medium containing glucose, whereas this enzyme is totally absent from original *S. globosus* cells. Homozygous adapted cells have twice as much invertase as heterozygous ones.

REFERENCES

- DEAN, A. C. R., and HINSHELWOOD, C. (1953). *In Adaptation in Micro-organisms*, p. 21. Cambridge University Press.
- IMSHENETSKY, A. (1953). *VI Int. Congr. Microbiol.*, **1**, 685.
- IMSHENETSKY, A., and PEROVA, K. (1955). *Microbiology*, **24**, v. 2, 148.
- KALINA, G. P. (1952). Vegetative Hybridization and Directed Mutability of Bacteria. Kiev.
- KOSSIKOV, K. V. (1948). *C. R. Acad. Sci., U.R.S.S.*, **63**, No. 5, 573.
- KOSSIKOV, K. V. (1951). *C. R. Acad. Sci., U.R.S.S.*, **80**, No. 1, 105.
- KOSSIKOV, K. V. (1952). *Proc. Inst. Genetics, Acad. Sci., U.R.S.S.*, No. 19, 199.
- KOSSIKOV, K. V. (1954). Genetics of Yeast and Methods of Selection of Yeast Cultures. Moscow.
- KOSSIKOV, K. V. (1956). *Proc. Acad. Sci., U.R.S.S.*, Biol. Series, No. 5, 23.
- KOSSIKOV, K. V., HELMAN, N. S., and RAYEVSKAYA, O. G. (1956). *C. R. Acad. Sci., U.R.S.S.*, **111**, No. 6, 1369.
- KOSSIKOV, K. V., and RAYEVSKAYA, O. G. (1956). *Proc. Inst. Genetics, Acad. Sci., U.R.S.S.*, No. 23, 326.
- KOSSIKOV, K. V., and RAYEVSKAYA, O. G. (1957). *C. R. Acad. Sci., U.R.S.S.*, **112**, No. 1, 141.
- LINDEGREN, C. C. (1956). *C. R. Lab. Carlsberg. Sér. physiol.*, **26**, No. 1, 253.
- LINDEGREN, C. C., and PITTMAN, D. (1953). *J. gen. Microbiol.*, **9**, 494.
- MUROMZEV, S. N. (1953). Mutation of Micro-organisms and Problems of Immunity. Moscow.
- OPARIN, A. I., HELMAN, N. S., and ELPINER, I. E. (1954). *C. R. Acad. Sci., U.R.S.S.*, **97**, No. 2, 293.
- OPARIN, A. I., HELMAN, N. S., and ZHUKOVA, I. G. (1954). *C. R. Acad. Sci., U.R.S.S.*, **99**, No. 4, 593.
- OPARIN, A. I., HELMAN, N. S. and ZHUKOVA, I. G. (1955). *Biochemistry*, **20**, v. 5, 572.
- PLANELIES, H. H. (1956). *J. Acad. med. Sci., U.R.S.S.*, No. 6, 17.
- PLANELIES, H. H., and MOROZ, A. F. (1956). *Antibiotics*, No. 6, 30.
- YURKEVITCH, V. V. (1950). Thesis Inst. Biochem., Acad. Sci., U.R.S.S.
- YURKEVITCH, V. V. (1954). *C. R. Acad. Sci., U.R.S.S.*, **94**, No. 2, 329.

DISCUSSION

Harington: Prof. Ierusalimsky, I believe you have some data which you would like to report now.

Ierusalimsky: The experimenters working on adaptation of micro-organisms did their best to distinguish physiological non-hereditary changes from spontaneous mutations. Nature, however, does not know any hard and fast rules. It is possible to admit the existence of categories intermediate between non-hereditary modifications and hereditary changes. It is common knowledge that the precious qualities developed in cultivated plants are inherited by them during an unlimited length of time in vegetative reproduction. However, some of these qualities can very easily disappear in the case of reproduction by means of seeds.

Bacteria undergo adaptive changes which could be transferred to one or to many generations of vegetative cells. However, it seems to me that only those changes that are transferred through sexual or asexual reproductive cells could be considered truly hereditary. To my mind, a certain kind of analogy of the latter are spores. The life cycle of bacteria ends in spore formation; and *vice versa*, germination of spores starts the next life cycle. During the formation of the spore, essential changes occur in the cellular structure and the greater part of the cellular content is not included in the spore. One should assume that it is the most stable properties, which can be considered hereditary, that will be transferred through spores. Unstable changes, which are retained in vegetative reproduction alone and disappear in spore formation, should be considered non-hereditary. To quote an example: strain *Cl. acetobutylicum*, which we had at our disposal, ferments xylose after a certain period of adaptation. Proof of this can be obtained by seeding the spores into glucose and xylose media (Fig. 1). The cells, once they start to produce enzymes, continue to propagate and they ferment xylose at almost the same rate as glucose.

However, the above is true only in those cases where the cells seeded are vegetative ones. As soon as the cells in the xylose medium form spores, their newly acquired capacity disappears, and again a certain amount of time will be needed to produce adaptive enzymes (Fig. 1). Consequently, the ability to produce these enzymes at an increased rate is not transferred through spores and therefore cannot be considered hereditary.

Could the changes which were induced by environmental factors be so strengthened and stabilized as to be transferred through spores, and thus become hereditary?

I shall mention only one example confirming the possibility of the last statement. We adapted *Cl. acetobutylicum* to increased concentrations of butanol. The bacteria were cultivated in an apparatus for continuous cultivation, the concentrations of butanol increasing gradually (by 0.2–0.5 per cent at a time). After each increase of concentration the rate of bacterial propagation dropped considerably; and only after a long period could the rate be increased again to that of propagation of the control culture, after which time we increased the concentration of

butanol again. Simultaneously the culture was inoculated into the media with different doses of butanol, to show the degree of resistance developed by it.

The stock culture could not survive a butanol concentration of more than 0.8 per cent, the adapted one survived a 2.5 per cent butanol concentration and propagated normally at a 2 per cent butanol concentration. The experiment took 200 days, which is equivalent to 4,300

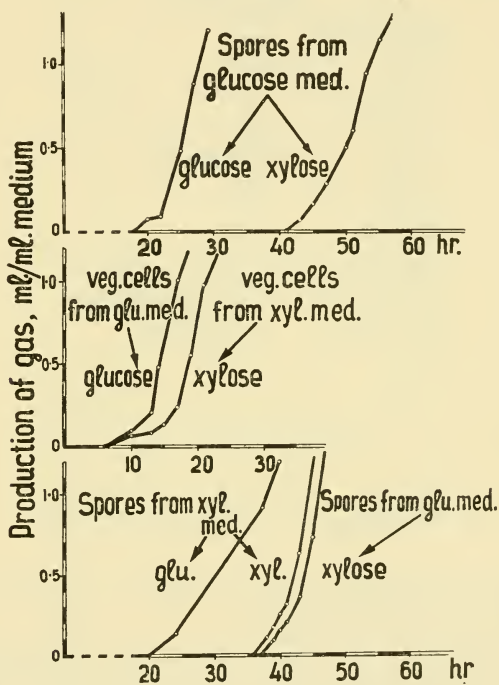

FIG. 1. Adaptation of *Cl. aceto-butylicum* to fermentation of xylose.

successive cellular generations. Fig. 2 shows that the resistance to butanol increased gradually together with the increase in its concentration. No abrupt increase was observed, which might be expected had spontaneous mutations appeared in the population. At the same time the conditions of the experiment were extremely favourable for the selection of resistant mutants. A very simple calculation shows that had there been only one mutant per million cells, the coefficients of propagation of which would exceed that of original cells by a mere 0.1, then after 200 generations, i.e. in approximately 8-9 days, the number

of mutants would have equalled the number of initial cells. Had the propagation coefficient of mutants been twice as large, the number of both groups would have become the same after 40 generations, i.e. in less than 2 days. However, to attain full adaptation to every consecutive

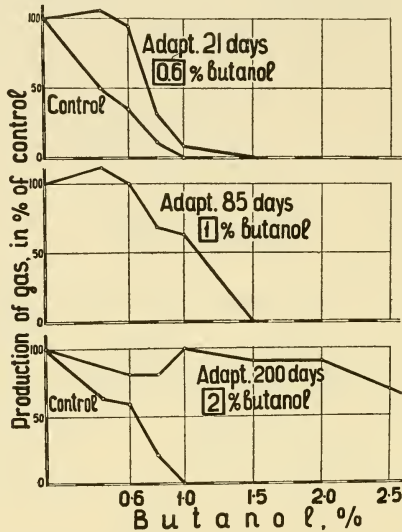

FIG. 2: Adaptation of *Cl. acetobutylicum* to increased concentrations of butanol. Before sporulation.

concentration of butanol, it required from 460 to 1,500 generations, i.e. from 20 to 70 days (Table I).

At first, the increased resistance was not transferred through spores. Later on it became so stable that it was retained by cells growing from the spores on the butanol-free medium and then seeded in the vegetative state in media containing different concentrations of butanol (Fig. 3).

Owing to a shortage of time I shall not refer to other experiments which consisted of adapting *Bact. megaterium* to greater concentrations of norsulphazol. In this case adaptation took place more easily and more quickly than in the case of butanol. Only 70 reseedings were needed to obtain a fivefold increase in resistance. Simultaneously, sulphazol-dependent forms could be detected in the population. In the case of butanol no such phenomenon could be seen. An increased resistance began to be transmitted through spores.

In our opinion, these experiments show the possibility of stabilizing adaptive, non-hereditary changes and of their gradual transition to stable hereditary changes.

Table I
ADAPTATION OF *Cl. aceto-butylicum* TO BUTANOL
IN CONTINUOUS CULTURE.

Butanol % w/v	time of adaptation days	average number of generations
0.6	21	460
0.8	28	610
1.0	36	780
1.5	45	980
2.0	70	1530
Totals	200	4360

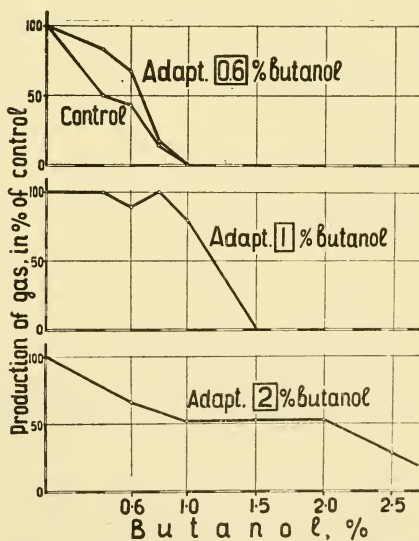

FIG. 3. Adaptation of *Cl. aceto-butylicum*
to increased concentrations of butanol.
After sporulation.

In what way do non-hereditary adaptive changes gradually turn into genotypic properties? To answer this question, special and more profound investigations are required. One can well imagine that the ability to synthesize a particular enzyme, trained for a long time, will finally touch on some more remote enzymic systems, which pass from the vegetative cell into the spores formed in it. Resulting from this, the vegetative cell developed from the spore will have a greater ability to synthesize a given enzyme prior to coming in contact with the external inductor. This will result in hereditary fixing of this ability.

I should like to note that the aim of my report is to draw more attention to the concept—shared by many of my countrymen—of the possibility of gradual transformation of acquired adaptive changes into stable hereditary changes. The experimental testing of this hypothesis might yield important results, which would have been scarcely possible had this theory been disposed of *a priori*.

It would be equally wrong to disagree, without sufficient proof, with the widely acknowledged theory that mutations are the only form of hereditary changes. Facts must be the highest arbiter in all scientific disputes.

MULTIPLE MECHANISMS OF ACQUIRED DRUG RESISTANCE

MARGARET J. THORNLEY, JEHUDITH SINAI
AND JOHN YUDKIN

Queen Elizabeth College, University of London

THERE are two possible ways of reconciling the different theories which have been suggested for the origin of drug resistance. The first is that the different mechanisms occur in different micro-organism-drug systems. The second is that the different mechanisms may occur in a single system and that the different theories derive from different experimental approaches.

We have attempted to demonstrate the latter possibility in the system *Escherichia coli*-proflavine. We began with the usual type of experiments on "training" and "reversion". Each culture so produced was tested against a range of concentrations of proflavine, so as to measure its distribution of resistance. In a culture grown in broth from a single cell in the absence of drug, there was a slight increase in the proportion of resistant cells during the first few subcultures.

"Training" and "Reversion"

When grown even once in the presence of drug there was a great increase in the number of resistant cells, able to grow in much higher concentrations. Cultures derived from different single cells gave significantly different numbers of resistant cells after the same number of subcultures in the same drug concentration.

After subculture in the presence of drug, repeated subcultures were made in the absence of drug. The degree of reversion depended on the number of subcultures in drug, on the concentration of the drug, on the strain of organism

and on the number of subcultures in the absence of drug. But complete reversion rarely occurred even after one subculture in fairly low drug concentration followed by many subcultures in the absence of drug. Conversely, when several subcultures were made in the presence of drug, considerable reversion still occurred and to about the same extent after 12 subcultures in the presence of drug and after 84.

These results are not in conformity with the suggestions of Hinshelwood. First, we do not find that the degree of resistance achieved corresponds to the concentration of drug in which a culture is grown. Second, we find that reversion is usually incomplete even after short contact with the drug, and yet it still occurs after very prolonged contact with drug. We conclude that this approach does not promise to reveal much as to the nature of the origin of drug resistance.

Phenotypic adaptation

Baskett (1952) has claimed a rapid increase in resistance to proflavine in a growing culture of *Bacterium lactis aerogenes* to which the drug was added at short intervals. We carried out this type of experiment with *Esch. coli* but growth ceased soon after the additions of proflavine were begun.

However, since Baskett's work seemed to be a conclusive proof of rapid phenotypic adaptation, we repeated his experiments with the same strain of *Bact. lactis aerogenes*, kindly supplied by Sir Cyril Hinshelwood. We confirmed Baskett's observation that additions of proflavine at intervals of ten minutes to growing cultures of this organism only slightly decreased the rate of growth, even though a high concentration of proflavine of up to 100 $\mu\text{g./ml.}$ was finally achieved. The same concentration of proflavine added at once inhibited growth completely. We found, however, that the cells themselves showed only a small increase in resistance. On the other hand, the presence of filtrate from a culture grown in the absence of proflavine allowed growth of an inoculum when a high concentration of proflavine was added (Fig. 1). We therefore looked for a factor produced in a culture during

growth which antagonizes the inhibitory action of proflavine. The experiments showed that such a factor was the acidity



FIG. 1. Effect of bacterial filtrate from a sensitive culture on the inhibitory action of proflavine on *Bact. lactis aerogenes*.

1. Filtrate 40 ml. + fresh medium 10 ml., to which proflavine was added gradually then inoculated with washed cells in logarithmic phase
2. Proflavine added gradually from 210 min. after inoculation
3. Proflavine added at once at 210 min. after inoculation
4. No proflavine added

----- gradual proflavine addition
 66 $\mu\text{g.}/\text{ml.}$ proflavine present
 _____ no proflavine added

Time from addition of cells in (1) and 210 min. after inoculation in others.

produced during the growth of the culture. Thus, if the pH of a growing culture was kept neutral, growth ceased when the

proflavine additions were made (Fig. 2). On the other hand, if a growing culture was acidified, growth continued even if all

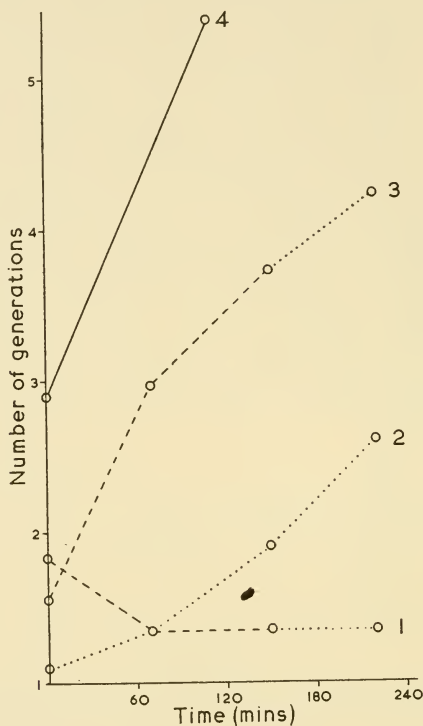

FIG. 2. Effect of maintaining neutral pH in culture during proflavine additions, and of acidifying the culture when large single addition of proflavine made, on growth of *Bact. lactis aerogenes*.

1. pH maintained neutral throughout incubation, proflavine added gradually
2. Culture acidified to pH 4.9, then all proflavine added at once
3. Proflavine added gradually
4. No proflavine added

--- gradual proflavine addition
 65 $\mu\text{g./ml.}$ proflavine present
 ——— no proflavine added

Time from beginning of proflavine additions.

the proflavine was added at once. Finally, acidified fresh medium with the whole amount of proflavine added supported

the growth of the sensitive cells. That the phenomenon did not occur with *Esch. coli* may be due to the differences in the culture medium. With *Bact. lactis aerogenes*, this was an inorganic medium which contained glucose, whilst with *Esch. coli* the medium was peptone broth only.

It is, however, possible to obtain with *Esch. coli* a small increase in resistance in growing cultures if small amounts of proflavine, giving a final concentration of not more than the threshold inhibitory concentration of 5 µg./ml., are added at

Table I

INCREASE IN RESISTANCE IN CULTURE OF *Escherichia coli* 36 BY ADDITION OF PROFLAVINE IN LOGARITHMIC PHASE

	Initial		After 270 min.	
	Proflavine	Control	Proflavine	Control
Increase in resistance				
Gradient plates	1	1	3	1.3
Counts 6.6 µg./ml.	3	3	3.2 × 10 ² and 2 × 10 ⁵ (s)	1 × 10 ²
10 µg./ml.	0	0	1.5 × 10 ²	3 × 10
20 µg./ml.	0	0	1.5 × 10 ²	2.8 × 10
(s) small colonies				

longer intervals of 30 minutes. The increase in resistance occurred in up to 1 per cent of the cells (Table I). It was somewhat less in degree than that of the first-step mutants (see below). It occurred only when the additions of drug were made in the logarithmic phase, and not when they were made in the lag or stationary phases (Fig. 3). The cells showing the increased resistance to proflavine were not cross-resistant to chloramphenicol, aureomycin, erythromycin or terramycin, drugs to which proflavine-resistant mutants show cross-resistance. They lost their resistance to proflavine when grown in the absence of the drug. For these two

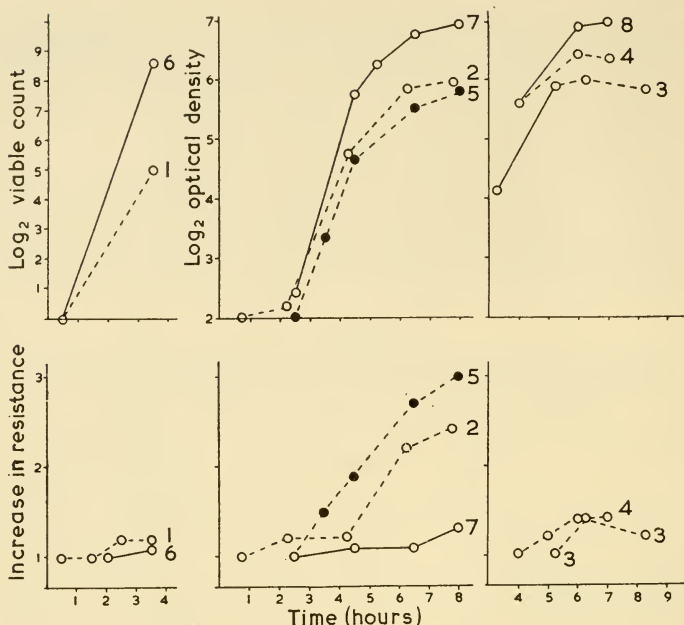

FIG. 3. Effect of proflavine additions at different phases of cultural growth on resistance of *Esch. coli* 36.

Flask 1—Proflavine additions start in lag phase 30 min. after inoculation

Flask 2—Proflavine additions start in lag phase 45 min. after inoculation

Flask 3—Proflavine additions start in late logarithmic phase 5½ hrs. after inoculation

Flask 4—Proflavine additions start in late logarithmic phase 4 hrs. after inoculation

Flask 5—Proflavine additions start in middle logarithmic phase 2½ hrs. after inoculation

Flask 6—Control for flask 1

Flask 7—Control for flasks 2, 3, 4, and 5

Flask 8—Control for flasks 3 and 4

Log₂ of optical density and increase in resistance plotted against time

----- proflavine added gradually

---●--- flask 5
 growth in flask 1 and 6 expressed as log₂ viable count

————— no proflavine added

Time from inoculation.

reasons, we believe that the increase is due to phenotypic adaptation.

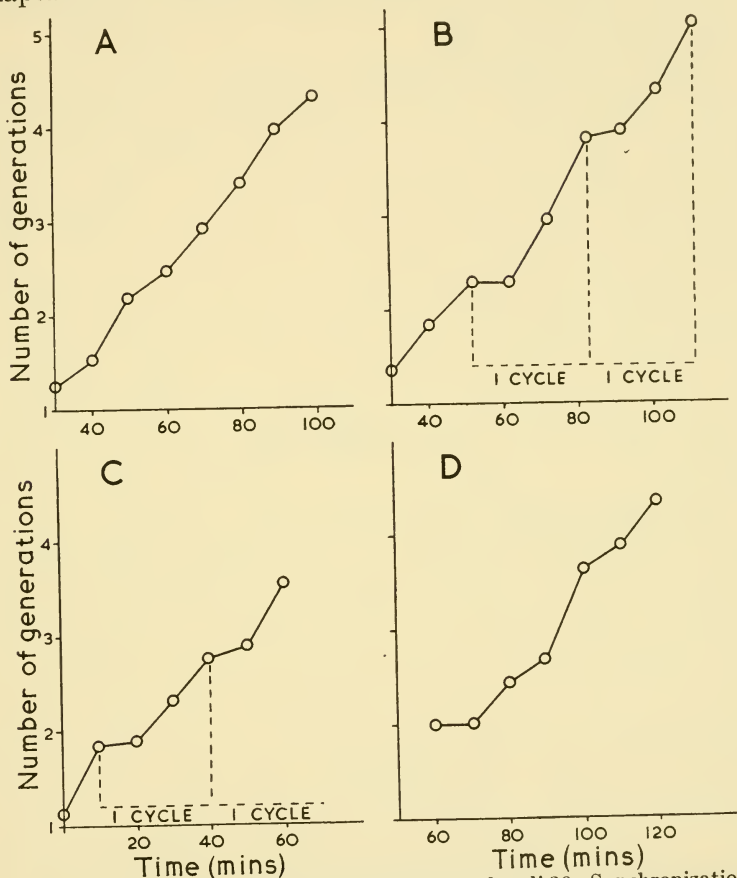

FIG. 4. Growth of a synchronized culture of *Esch. coli* 36. Synchronization by cooling at 12°C for 15 min. begun at different times from inoculation.

- A cooling starts after 120 min. from inoculation
 - B cooling starts after 90 min. from inoculation
 - C cooling starts after 70 min. from inoculation
 - D cooling starts after 60 min. from inoculation
- Time from returning the flasks to 37°C after cooling.

As well as this moderate increase in resistance of a large proportion of the cells, there was a rise in the number of cells

of high resistance. These cells were cross-resistant to the other drugs. We believe that they arise not by division of pre-existing mutants but either by clonal variation or by direct (Lamarckian) induction.

We now investigated whether a variation in this phenotypic adaptability might explain the continuous distribution of resistance in a culture. We tested the possibility that the variation might be a function of the various stages of the division cycle. Synchronization of division was attempted by cooling for a few minutes and then returning to 37°. The degree of synchronization depended on the time from inoculation of the culture, and the temperature and period of cooling. In appropriate conditions, it was possible to obtain a reasonable degree of synchronization, in which a burst of divisions occurred during the first 10 minutes after cooling, followed by cycles of 30 minutes with half of the divisions occurring in the first 20 minutes and half in the next 10 minutes (Fig. 4).

The cultures with synchronized division cycles also showed cycles of fluctuation in resistance. These cycles lasted for about 20 minutes (Fig. 5). The variation in resistance during the cycles was demonstrated by taking samples at intervals and testing on plates with varying concentrations of proflavine. The variation showed itself in three ways. First, with appropriate concentrations of about 6 $\mu\text{g./ml.}$ of drug, there was a great difference at different times in the number of cells able to produce colonies; this difference was as high as 1,000-fold, compared with the maximum of less than tenfold in samples from a non-synchronized culture. Second, the differences at different times became progressively less with lower concentrations of drug on the testing plates, so that when the concentration was about 4 $\mu\text{g./ml.}$ proflavine, the same number of colonies grew throughout the cycles. This concentration thus appears to be the inherent resistance of the cells. Third, the period out of the cycles during which the cells were able to grow on proflavine plates was longer with the lower concentrations of drug.

An important conclusion is derived from a consideration of the technique used for testing varying resistance during the

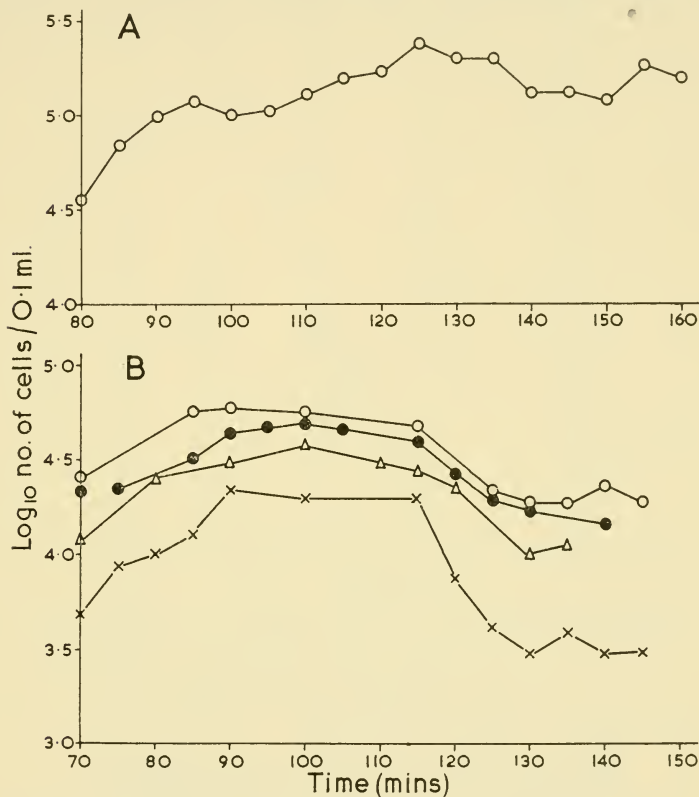

FIG. 5A. Resistance to various concentrations of proflavine of cells in cultures of *Esch. coli* 36. Non-synchronized cultures.

A Tested from 80 min. after inoculation, on proflavine 4 µg./ml.

B Tested from 70 min. after inoculation, on proflavine

- 4.5 µg./ml.
- 5 µg./ml.
- △—5.7 µg./ml.
- ×—6.6 µg./ml.

Time from inoculation.

division cycles. We consider a cell to have a higher resistance at one stage of the division cycle when it is able to produce a colony on a plate with a higher concentration of proflavine.

But in order to do so, its daughter cells must have gone through a stage in the division cycle when their resistance was low. Nevertheless, they continue to grow and divide.

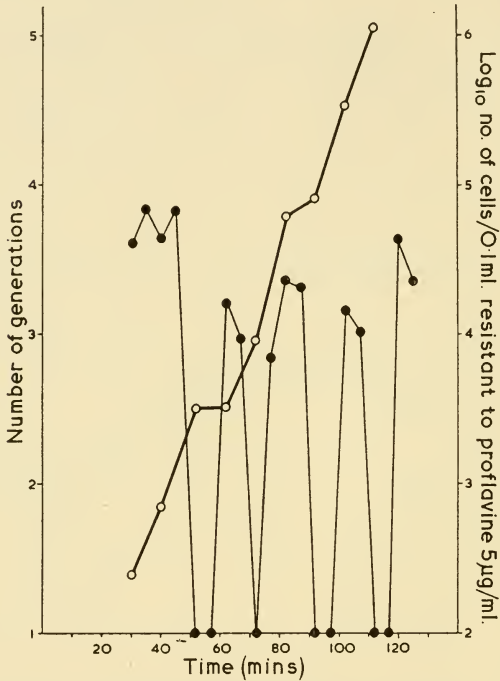

FIG. 5B. Resistance to various concentrations of proflavine of cells in cultures of *Esch. coli* 36. Synchronized culture. Synchronization by cooling after 90 min. from inoculation at 12° for 15 min.

- ——— total viable count expressed as number of generations
- ——— number of cells in 0.1 ml. resistant to proflavine 5 µg./mg., expressed as log₁₀

Time from returning to 37° C at the end of cooling.

This must mean that the apparently higher resistance is really a higher adaptability, which is retained in the presence of the drug throughout the whole of the subsequent division cycles. Thus, the variation we find in the cycles is not a

variation in resistance but a variation in adaptability. If this is so, then the addition of proflavine to a synchronized

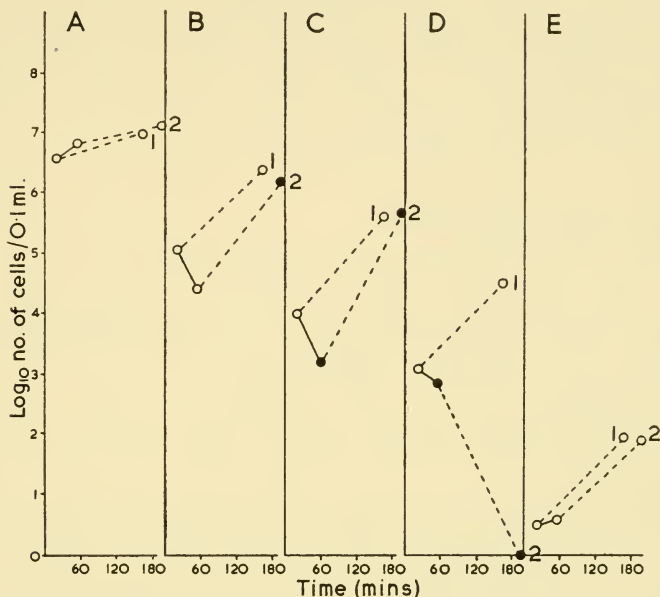

FIG. 6. Effect of proflavine 4 $\mu\text{g./ml.}$ on increase in resistance and growth inhibition when added at different times of a division cycle in a synchronized culture of *Esch. coli* 36.

1—proflavine added at once at 24 min. after returning the culture to 37°C

2—proflavine added at once at 56 min. after returning the culture to 37°C

A—total viable count

B—cells resistant to 5 $\mu\text{g./ml.}$ proflavine

C—cells resistant to 5.7 $\mu\text{g./ml.}$ proflavine

D—cells resistant to 6.2 $\mu\text{g./ml.}$ proflavine

E—cells resistant to 10 $\mu\text{g./ml.}$ proflavine

--- ○ --- normal colonies

----- 4 $\mu\text{g./ml.}$ proflavine present

--- ● --- small colonies

————— no proflavine present

Time from end of cooling.

culture should result in no increase in resistance at some stages and a significant increase at other stages. This prediction we have confirmed experimentally (Fig. 6).

The variation in adaptability during the division cycles can explain the rise in resistance in a growing culture to which proflavine is added. It can also explain the continuous curve of resistance in a culture, which will have cells at all stages of the division cycle and so with the complete range of degrees of adaptability. We cannot, however, exclude the possibility that part of the explanation for the continuous curve of resistance is a superimposed clonal variation.

Lamarckian inheritance

The work of Akiba (1954) and of Szybalski (1955) indicates that *Esch. coli* may acquire resistance to streptomycin by direct induction, and that the resistance so acquired is inherited. We may therefore speak of this type of induction as Lamarckian inheritance. Our own experiments on Lamarckian inheritance of proflavine resistance in *Esch. coli* were made both with growing cultures and with non-dividing organisms.

Most of the work was carried out with rough strains derived from our original smooth strain of *Esch. coli*. In some of these strains, growing cultures in the presence of proflavine, cell extracts and tap water gave a high increase in resistance in up to 10 per cent of the cells. A much smaller increase occurs if cell extracts are not present, recalling the experiments on phenotypic adaptation. Since extracts from sensitive or from resistant cells are equally effective, the increase in resistance is not due to transformation. We believe that it is due to Lamarckian induction, though we were not able to exclude the possibility of selection of pre-existing mutants.

In non-dividing cells of some rough strains, washed and suspended in phosphate buffer, the presence of small concentrations of proflavine produced, in 10–14 days, levels of resistance of about that of first-step mutants in up to 80 per cent of the surviving cells (Table II). A somewhat lower increase was achieved with the original smooth strain. A minimal concentration of proflavine was needed; with increasing concentrations, there was an increase in the rate of induction,

Table II

 INDUCTION BY PROFLAVINE 1 $\mu\text{G./ML.}$ FOR 10 DAYS IN NON-DIVIDING CELLS OF *Escherichia coli* R₂

		Initial	Final	
			Control	Proflavine
Total percentage of survivors		—	0·6	0·1
Percentage of survivors with resistance, $\mu\text{g./ml.}$	20	—	0·6	—
	50	—	0	—
	100	—	0	—
	200	—	0	—
Percentage of survivors with resistance, $\mu\text{g./ml.}$	20	0·004	0·005	80
	50	0·002	0	37
	100	0·0001	0	1·7
	200	0	0	0

in the number of cells induced and in the level of resistance achieved (Fig. 7). No induction occurred at 5° or 20°, or when the cell density was low, or in the absence of tap water. It was found that the presence of proflavine for only two days was enough to give a substantial rise in the number of resistant cells when they were suspended in the absence of proflavine during the following 7 days (Fig. 8). Induction resulted not only in a considerable rise in numbers of cells with pre-existing levels of resistance, but also in the emergence of cells of much higher resistance which previously were not present. During the induction, there was initially a considerable fall in the number of viable cells, which then increased. We believe that cells become temporarily non-viable whilst undergoing induction. The induced cells retained their resistance when subcultures were made in the absence of drug. They were cross-resistant to chloramphenicol and aureomycin. In these ways, and in the much higher levels of resistance achieved, these cells differed from those in which increased resistance (phenotypic adaptation) occurred during growth when small amounts of proflavine were added.

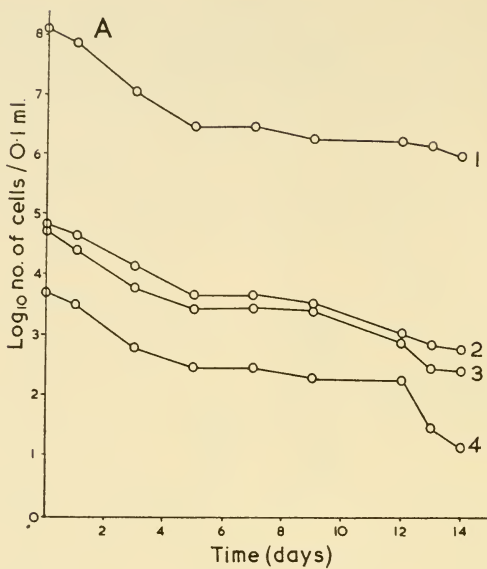

FIG. 7A



FIG. 7B

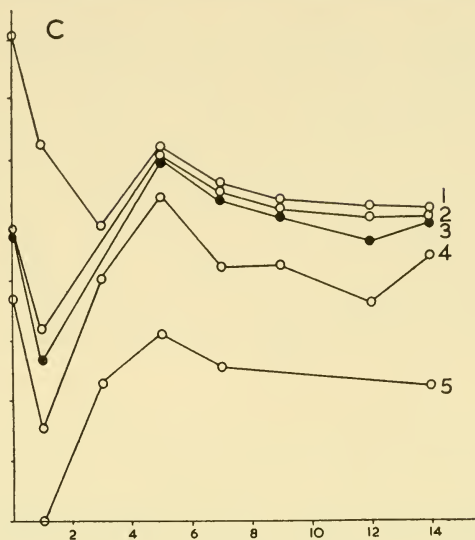

FIG. 7c

FIG. 7. Induction to proflavine resistance by 1.5 $\mu\text{g./ml.}$ and 5 $\mu\text{g./ml.}$ proflavine in non-dividing suspensions of *Esch. coli* R₂. Changes in numbers of sensitive cells, and of cells resistant to different concentrations of proflavine, at different times during 14 days incubation at 37°C.

A—control, no proflavine in suspension

B—induced by 1.5 $\mu\text{g./ml.}$ proflavine

C—induced by 5 $\mu\text{g./ml.}$ proflavine

1—total viable count

2—count of cells resistant to 20 $\mu\text{g./ml.}$ proflavine

3—count of cells resistant to 50 $\mu\text{g./ml.}$ proflavine

4—count of cells resistant to 100 $\mu\text{g./ml.}$ proflavine

5—count of cells resistant to 200 $\mu\text{g./ml.}$ proflavine

Time from beginning of incubation of the induction suspension.

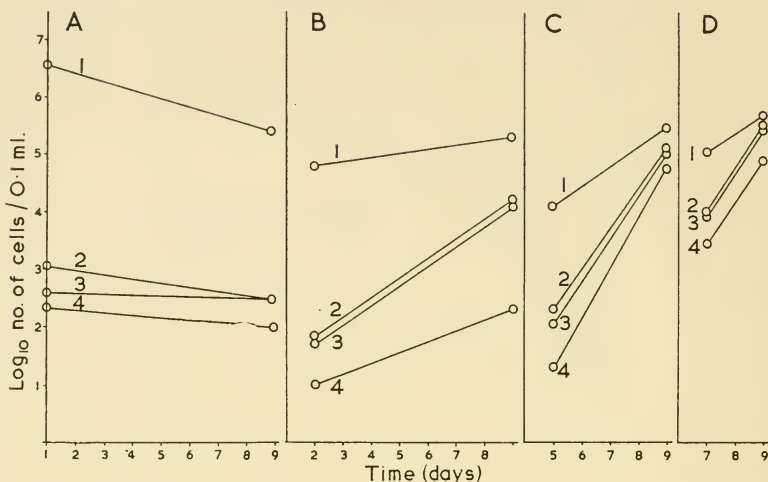

FIG. 8. Induction to proflavine resistance by 2 µg./ml. proflavine in a non-dividing suspension of *Esch. coli* R₂. Samples of the cells washed and resuspended in buffer and tap water without proflavine at different periods during 9 days of incubation at 37°C. The resuspended cells incubated further at 37°C to complete the 9 days incubation period.

A—suspension incubated 1 day in presence of proflavine and 8 days in absence
 B—suspension incubated 2 days in presence of proflavine and 7 days in absence
 C—suspension incubated 5 days in presence of proflavine and 4 days in absence
 D—suspension incubated 7 days in presence of proflavine and 2 days in absence

1—total viable count

2—cells resistant to 20 µg./ml. proflavine

3—cells resistant to 50 µg./ml. proflavine

4—cells resistant to 100 µg./ml. proflavine

Time from beginning of incubation of the induction suspension.

In similar experiments, we were also able to induce to streptomycin resistance but not to chloramphenicol resistance.

Demonstration and isolation of pre-existing mutants

The fluctuation test of Luria and Delbrück (1943) was performed on the sensitive strain of *Esch. coli*. We found a significantly higher variance in the number of colonies on proflavine plates arising from several small cultures than in the number arising from one larger culture. This suggests that there is a spontaneous mutation in the culture to proflavine resistance.

The existence of these was confirmed by the replica plating technique of Lederberg and Lederberg (1952), modified slightly by us. We were able to isolate two first-step mutants, and from one of these two further mutants with successively increased resistance. If we take as a measure of resistance the concentration of proflavine which allows one cell in a thousand to grow, then the increase in resistance of the first-step mutants was $\times 8$ and $\times 18$. The two further steps from the latter had further increases of resistance of $\times 3.2$ and $\times 1.8$. Thus, the increase in resistance of the third-step mutant, compared with the sensitive strain, was by a factor of about 100.

From the same sensitive strain of *Esch. coli*, we have also been able to isolate, in the same way, two first-step mutants to chloramphenicol resistance. In addition, we have isolated a proflavine-resistant mutant from the rough strain in which we had carried out most of our induction experiments.

There was a general relationship between resistance to proflavine and resistance to chloramphenicol in all of these mutant strains. In only one instance, between the first- and second-step proflavine mutant, was there an increase in resistance to one drug—proflavine—with no change in resistance to the other drug.

Transformation to proflavine resistance

We attempted transformation of sensitive cells to resistance by deoxyribonucleic acid (DNA) from resistant cells, prepared with modifications according to the methods of Boivin (1947), McCarty and Avery (1946) and Myers and Spizizen (1954).

The preparations all gave a positive Stumpf reaction, indicating the presence of DNA. They were tested by diluting the preparation with broth and inoculating 0.1 ml. of diluted 3-hour culture of the sensitive organism. After 24–48 hours incubation, the numbers of resistant and sensitive cells were determined on plates with and without proflavine.

Preparations made by toluene treatment according to the

method of Boivin were not able to transform sensitive cells, although various modifications of the conditions of preparation were made.

The method of McCarty and Avery consists of lysis with deoxycholate in the presence of citrate, removal of protein with chloroform and amyl alcohol and precipitation of the transforming principle by absolute alcohol. Four rough strains, derived from the original smooth strain, were tested for competence to undergo transformation. In one of these, there was a slight increase in the number of proflavine-resistant cells. We thought that this might be due to the existence of small numbers of a substrain consisting of competent cells. We therefore devised a method of "double replica plating", by which we might isolate them. A master plate of one of the rough strains was replicated on plates containing the transforming principle. After incubation, this in turn was replicated on plates containing proflavine. Colonies on this plate were traced back to corresponding areas of the master plate which had been kept at 5°. From ten of these, subcultures were made and transformation attempted. In one of them, transformation was achieved as indicated by a 200-fold increase in the number of resistant cells in presence of DNA from resistant cells, but no increase in presence of DNA from sensitive cells. Two further experiments with the same rough strain, and one with a different rough strain, gave similar results.

The third method, that of Myers and Spizizen, was used by these authors to produce a highly polymerized DNA, although they did not carry out transformation experiments with it. The method consists of lysing with sodium dodecyl sulphate (duponol), removal of protein with sodium acetate and precipitation of DNA with acidified alcohol. Transformation was tested on the original smooth strain of *Esch. coli*. The DNA preparation alone did not cause transformation, the protein precipitate caused transformation in about 0.3 per cent of the cells, and both preparations together caused transformation in ten times as many cells. No transformation

occurred with similar preparations made from sensitive cells. Transformation by preparations from resistant cells was lost after treatment with deoxyribonuclease (DNAse). The level of resistance reached in the transformed cells was about that of a first-step mutant, whether the DNA was made from a first-step or a second-step mutant.

Table III

 TRANSFORMATION TO PROFLAVINE RESISTANCE IN *Escherichia coli* 36

Culture	Cell fraction	Protein or substitute	Cells/10 ⁷ resistant to	
			20 µg./ml.	50 µg./ml.
1	—	—	10	0
2	—	PrR	2.5 × 10 ⁴ (s)	5 × 10 ² (s)
3	—	PrS	20	0
4	—	duponol	10	0
5	—	serum	5	0
6	—	deoxycholate	6	0
7	TPR	—	5	0
8	TPR	PrR	3 × 10 ⁵	5 × 10 ⁴
9	TPR	duponol	2.6 × 10 ⁵	2 × 10 ⁴
10	TPR	serum	4	0
11	TPR	deoxycholate	5	0
12	TPS	—	6	0
13	TPS	PrS	23	0
14	TPS	duponol	15	0
15	TPS	serum	12	0
16	TPS	deoxycholate	7	0

TPR, PrR—DNA and protein fractions from resistant mutant.
 TPS, PrS—DNA and protein fractions from sensitive *Esch. coli* 36.
 (s) small colonies.

We studied the rôle of the protein fraction, which contained some DNA, by substituting other substances for it and adding to the DNA preparation. We found that its place could be taken by duponol, but not by deoxycholate or by rabbit serum (Table III). The protein fraction was found to carry duponol with it, so that its activation of DNA presumably depends on its duponol content. Duponol was shown to

inhibit DNase; it seems therefore that it might act by preventing the destruction of transforming DNA by the enzyme of the recipient cells.

Conclusion

We have demonstrated, in the one system *Esch. coli*-proflavine, the origin of resistance through: (1) mutation and selection, (2) phenotypic adaptation to a low level of resistance at some stages in the division cycle, (3) Lamarckian inheritance and (4) transformation. We have not been able to exclude the possibility that clonal variation also occurs. We believe that in natural situations, the environments and micro-environments to which the cells are exposed are so complex that it is profitless to attempt an assessment of the relative importance of these mechanisms in determining the emergence of a resistant population. Nevertheless, in the simpler conditions existing in laboratory experiments, we can readily visualize the ways in which such a population may emerge by the simultaneous or sequential occurrence of these different modes of origin. We believe also that it is possible, through an extension of the unitary theory of enzyme induction (Cohn and Monod, 1953; Pollock, 1953), to bring together these various mechanisms into a unitary theory of the origin of drug resistance.

REFERENCES

- AKIBA, T. (1954). *In* Origins of Resistance to Toxic Agents, p. 82. New York: Academic Press.
- BASKETT, A. C. (1952). *Proc. roy. Soc. B*, **139**, 251.
- BOIVIN, A. (1947). *Cold Spr. Harb. Symp. quant. Biol.*, **12**, 7.
- COHN, M., and MONOD, J. (1953). *Symp. Soc. gen. Microbiol.*, **3**, 132.
- LEDERBERG, J., and LEDERBERG, E. M. (1952). *J. Bact.*, **63**, 399.
- LURIA, S. E., and DELBRÜCK, M. (1943). *Genetics*, **28**, 491.
- MCCARTY, M., and AVERY, O. T. (1946). *J. exp. Med.*, **83**, 89, 97.
- MYERS, V. L., and SPIZIZEN, J. (1954). *J. biol. Chem.*, **210**, 876.
- POLLOCK, M. R. (1953). *Symp. Soc. gen. Microbiol.*, **3**, 150.
- SZYBALSKI, W. (1955). *Antibiotics Annual 1954-1955*, p. 576, New York: Med. Encycl. Inc.

DISCUSSION

Dean: We have frequently said that permanence of training is never absolute. Our general thesis is that the longer the strain is trained the more stable does the adaptation become; you can eventually reverse it if you subculture it for a sufficiently long time in a drug-free medium, but it may take a very long time (Hinshelwood, C. (1953), *J. chem. Soc.*, p. 1947; Dean, A. C. R., and Hinshelwood, C. (1954), *Proc. roy. Soc., B*, 142, 45).

With regard to the accelerated adaptation experiments, I have quoted cases where I got the concentration up to 43 mg./l. without any change in the pH of the medium; the pH was 7 at the beginning and 7 at the end. I have also done a set where the concentration was gradually increased up to 63 mg./l., and there pH began at 7 and ended at 6·8. But if a control was put on at pH 6·8 it did not grow. Furthermore, I think nobody would question that one would get variations in adaptability during the growth cycle, at least with proflavine. In most of the training experiments of Davies, Hinshelwood and Pryce, training was done by subculture in the logarithmic phase.

Yudkin: The point I was making about reversion was that there seemed to us, at any rate, to be no relationship between the number of times a culture has been trained and the degree of reversion; and that very large numbers of subcultures in the absence of the drug may produce degrees of reversion no different from those produced by a few subcultures. It would not be useful to discuss the pH experiment; our findings are just different. I don't see how the pH stayed constant because in fact there is a continuous fall in pH, as I have shown. You have a glucose medium and the culture is growing in logarithmic phase, and I find it difficult to imagine that the pH stayed constant while the experiment went on. We used exactly the same medium as you. I should emphasize that what we are discussing has two aspects: one is the cultural phase, and the other is the cell-division phase.

Walker: If proflavine is added to a culture at the beginning, is it still proflavine after two days?

Dean: It is oxidized in the presence of light and air. One has to protect against that.

Rose: With these antibacterial agents that have amino groups present, one imagines that the amino groups could easily be replaced by hydroxyl through the action of deaminases which would give substances that are only very feebly antibacterial.

Yudkin: In the induction experiments where they were left in contact with proflavine for several days, after taking them out of proflavine or its degradation product, as the case may be, there was then a continuing large increase in the number of resistant cells.

Rose: They may be resistant now because they have the ability to remove one or both amino groups.

Yudkin: I think that may be the basis of resistance.

Slonimski: It has been possible to show with euflavine (2:8 diamino-N-methylacridine) that the compound which can be extracted from the

yeast cell is the same as the one used to induce mutation. To do this one extracts with HCl-ethanol, then one gets rid of the extracting medium. There is no change in the spectrum (measured at different pH's) and there is no appreciable change in the biological activity. One must, however, have taken special precautions to ensure preservation of euflavine. The work must be done in the dark, at constant pH, and in a well defined chemical medium.

Walker: Is the same chemical species present over the pH range in which you carried out your first experiment, Prof. Yudkin?

Yudkin: No, probably not. We wanted to know whether the change which allows bacteria to grow in high concentrations of proflavine is a change in the cells or a change in the medium. We think we have established that it is a change in the medium, and that it is simply a matter of pH.

Slonimski: Albert and his collaborators have shown that 12 years ago; but this is quite an interesting phenomenon in itself because firstly, you have a competitive ratio of 1 hydrogen ion per 500 to 1000 ions of acridine, which is quite surprising; and secondly, this is not always a question of dissociation of acridine. Marcovich (1953, *Ann. Inst. Pasteur*, 85, 199) has shown with euflavine (which has a pK_a of more than 12, while proflavine has 9) that the antimutagenic effect of H^+ ions had a pK_a around 5.5, i.e. it cannot be explained by the dissociation of the drug.

Davis: If one is concerned with determining the mechanism by which a resistant strain becomes sensitive on growth in the absence of the drug, I am not sure I understand the rationale underlying the extensive experiments of Yudkin, and of Dean and Hinshelwood, designed to reveal how many culture passages are necessary to bring about this return of sensitivity. It is known that in mixtures of resistant mutants and the sensitive parental strain one can find differences in relative rate of growth that lead to selection—in favour respectively of the resistant strain in the presence of the drug and the sensitive strain in the absence of the drug. Hence, whether a resistant strain becomes sensitive in the absence of the drug after 5 passages—or only after 500—this observation *per se* does not help us to decide whether the change was based on mutation and selection or on a physiological adaptation.

Yudkin: Speaking solely from our own point of view, what we were trying to do was to see whether we got the same phenomenon as Hinshelwood. We wanted to know what would happen in the Hinshelwood conditions, but measuring resistance in the more orthodox way of survival curves. We concluded that you don't seem to get anywhere with that sort of experimentation.

Dean: In their experiments, Davies, Hinshelwood and Pryce (1945, *Trans. Faraday Soc.*, 41, 163) were investigating the adaptation of *Bact. lactis aerogenes* to proflavine. They trained organisms at certain concentrations, and then did lag-concentration curves with these strains, and found that the resistance was continuously graded to conform to the concentration at which training has been carried out. Then the interesting question arose: Is this resistance stable? The conclusion is that the

strain reverts eventually, but Hinshelwood has often stated that the reversion can be very unpredictable.

Yudkin: What we said was that it makes no difference if you had 12 or 80 subcultures, for example. Indeed we have got a culture which we used in our transformation experiments, which was trained to a high level of resistance in that way, and it still is resistant 5 years later.

Dean: Of course there may be quite a variation in technique.

Hughes: In your culture, which is not multiplying in the presence of proflavine, how satisfied are you that there is not a turnover of cells?

Yudkin: When we did these experiments, we were rather impressed by the work of Szybalski and Akiba. We took even more precautions than they did, but until we go back now and look at the same sort of things that Szybalski looked at, we cannot be absolutely certain.

FredERICQ: You get transformation with DNA extracted from a resistant mutant. Did you try to transfer the resistance conferred by prolonged induction.

Yudkin: No, that is one of the things we shall have to do.

Fulton: How difficult is it to get DNA out of bacteria? Can you hope for purity of the specimen without prolonged chemical operations?

Yudkin: We did not attempt to make entirely pure preparations. We made preparations which had DNA activity. It involved lysing, extraction, precipitation of protein, then taking up in saline. We were content at this stage, to show (a) that, prepared in this way, the extracts are active if they come from resistant organisms—whether from a mutant isolated by replica plating, or from a trained culture—and not when prepared in exactly the same way from a sensitive culture; and (b) that the activity is lost on treatment with DNase.

Pollock: You said that there was a cycle of 20 minutes in changes in proflavine resistance, 30 minutes in the actual division time; yet later on you seemed to imply that there was a relationship between the two. Could you clarify that?

Yudkin: I don't know the answer. This is an odd situation. It was Dr. Hotchkiss who started this. He got changes in transformability which were longer than the division cycles. We get changes in resistance levels which are shorter. There are elaborate ways in which you can possibly explain this by imagining that the cooling process interrupts at more than one level and so on. But I feel there is no explanation at the moment. I still feel that it is likely that these changes in cycles of resistance are in some way tied up with cell division.

Hotchkiss: We have the same problem. The two factors we tried to correlate were the cyclical transformability, i.e. the percentage of cells which respond to DNA; and the number of cells undergoing division, exemplified by colony formation. The lack of correspondence of the cycles might be because cell division is not the same as nuclear division, so that the time at which nuclear processes are going on may well precede the time at which cells become separate enough to form single colonies. Furthermore, when we are measuring cell division, we are measuring a property of all of the cells; what 1000 cells do in 5 minutes, and in the succeeding 5 minutes, and so on. We found steps of division such as

Yudkin has shown. But when we are measuring transformability, we are measuring a property of only a few of the cells, and these few could be gradually deviating from the general mode of behaviour of the population and so be gradually acquiring a longer and longer true cell division time, which would not show up except as a slight damping effect on the overall properties of the divisions of the average cells.

Pollock: If this is a regular change in drug resistance I would have thought that Yudkin's evidence would suggest that one should look for another cause and not try to fit it in with the cell cycle. Might it not for instance be due to the rate of production of an enzyme which is formed at a very low rate, so that you really might have a quantal effect due to only one molecule being formed at a given time? The time it takes for a cell to form one molecule would not necessarily be related to cell division, but it would produce a cyclic effect if that molecule was necessary for the development of drug resistance.

Yudkin: Yes, I find it perfectly possible. The important thing here is that there are cycles of adaptability to resistance. If one accepts that there are these very considerable cycles of resistance, and if one accepts that an ordinary culture will have cells in all stages of these cycles, then clearly if one tests such a culture one will find them having what you call resistance, but which I would suggest is adaptability to resistance, over a whole range. It seems to us that one of the explanations, if not the only explanation, of the range of resistance in a sensitive culture, expressed in survival curves, or distribution curves, is the fact that the cells show the whole range of cycles of adaptability.

PHYSIOLOGICAL (PHENOTYPIC) MECHANISMS RESPONSIBLE FOR DRUG RESISTANCE

BERNARD D. DAVIS

Department of Pharmacology, New York University College of Medicine

FOR the most part this symposium has been concerned with the genetic aspect of the development of drug resistance: i.e. the mechanism or mechanisms by which a hereditary change in resistance to an inhibitor arises in a cell and becomes transmitted to succeeding generations. But the problem of drug resistance has another side that also merits attention: the nature of the physiological changes, regardless of origin, that are directly responsible for the decreased susceptibility of the cell to inhibition by the drug. In other words, for present purposes I am interested in changes in those units in the cell that do its everyday work, such as its enzymes and membranes, rather than in changes in the more intellectual units which govern, in interaction with the environment, the pattern of formation of these working units. Furthermore, I should like to emphasize the distinctness of the two problems. For regardless of the origin of drug resistance, an analysis of its phenotypic mechanism, at a biochemical level, would inevitably lead us to measure such parameters as the level of various metabolites and enzymes, the ability of the cell to concentrate or bind various compounds, and the affinity of enzymes and transport systems for the drug.

As the physiological problem has so far been much less extensively explored than the genetic one, it may offer a greater challenge at the present time. The literature on the subject has recently been comprehensively reviewed (Abraham 1953; Schnitzer and Grunberg, 1957), and so the present paper will be restricted to selected aspects of the problem.

Possible physiological mechanisms of drug resistance

For purposes of orientation it might be well to start by listing the theoretically possible changes in the function of a cell that could be expected to increase its resistance to an inhibitor. These would include the following (Davis and Maas, 1952); and there might well be others that we are missing.

- (1) Alternative metabolic pathway bypassing the inhibited reaction.
- (2) Increased concentration of a metabolite that antagonizes the inhibitor.
- (3) Increased concentration of the enzyme that the drug inhibits.
- (4) Decreased requirement for a product of the inhibited metabolic system.
- (5) Increased destruction of the inhibitor (or decreased conversion of an administered compound into a more active inhibitor).
- (6) Formation of an altered enzyme, with decreased affinity for the inhibitor or with increased relative affinity for the substrate compared with a competitive inhibitor.
- (7) Decreased permeability of the cell (or of subcellular units) to the inhibitor. (As a special case pointed out by Mr. Anton Kris, a medical student at Harvard, this could include increased affinity of a permeation system for other compounds which interfered with transport of the inhibitor.)

I should like to comment briefly on these mechanisms, first pointing out that there is no reason to anticipate that any one mechanism will ultimately be found to tell the whole story. If mutations can give rise to an increment of resistance through various mechanisms, the inhibitor would select them all; and there is little doubt that nature would avail itself of all the means at its disposal to fill such an ecological niche.

The first mechanism, involving an alternative metabolic path, seems to have long been a speculative favourite, especially since drug resistance has been shown in many cases to

arise by mutation, and since certain other mutations were shown to have an all-or-none effect on the formation of a given enzyme. However, it has become abundantly clear that the biochemical consequence of mutations is by no means restricted to such an all-or-none effect, and so this mechanism has lost much of the basis for its appeal. Furthermore, there are definite reasons to doubt whether this mechanism occurs at all. For in a biosynthetic sequence proceeding from compound A to C via B, the appearance of a new route bypassing B would surely have to involve the insertion of more than one new enzyme in the sequence. Of course, it is possible that one or more of these enzymes, though new in the sequence, might already be present in the cell for other purposes. The theoretical objection to this mechanism is therefore not absolute; but it should be added that the mechanism has not been clearly demonstrated in any case with which the present author is familiar.

Mechanism 2, increased concentration of a competitive metabolite, has also had widespread appeal ever since sulphonamides were shown to act by competing with *p*-aminobenzoate (PAB). However, in the few cases where increased formation of PAB has been demonstrated the effect has been too slight to explain more than a trivial increase in resistance. Furthermore, despite much effort none of the antibiotics have been shown to act by competing with a metabolic intermediate.

The next two mechanisms, increased concentration of the enzyme or decreased requirement for its product, could also hardly be expected to produce more than a modest increase in resistance.

Mechanism 5, destruction of the inhibitor, has been shown to be important in some penicillin-resistant strains, which form and excrete the enzyme penicillinase. The behaviour of such strains is dealt with in detail elsewhere in this symposium by Dr. Pollock (p. 78) and by Dr. Barber (p. 262).

And now we come to the last two mechanisms, which involve principles that have become established in microbiology only in the past few years: the ability of mutations to

lead to the formation of qualitatively altered enzymes, and the presence in bacteria of mutable stereospecific permeation systems. Since these developments are so recent it may be profitable here to consider their experimental basis as well as their application, as yet limited, to the problem of drug resistance.

Qualitatively altered enzymes

While evolutionary considerations have long made it evident that mutations must be able to affect the nature as well as the amount of the various enzymes (and other proteins) formed by an organism, this phenomenon was first demonstrated less than ten years ago by Pauling and co-workers (1949), and in mammals rather than microbes. They showed that patients with sickle-cell anaemia, a hereditary disease, formed haemoglobin with different electrophoretic mobility from that of normal human haemoglobin. Since then a number of different kinds of human haemoglobin have been discovered.

Shortly thereafter a mutational change in the nature of a protein was shown for an enzyme, and in micro-organisms, by Maas and Davis (1952) working with pantothenate synthase in *Escherichia coli*, and by Horowitz and Fling (1953) working with tyrosinase in *Neurospora crassa*. In each case the mutant studied was a temperature-sensitive one: i.e. it lacked the enzyme in question when grown at ordinary temperatures, but formed it when grown at low temperatures. When the enzyme was extracted from the cells grown at low temperature, it was found to differ strikingly from the corresponding enzyme of the wild-type strain in one respect: it was irreversibly denatured at moderate temperatures which did not denature the wild-type enzyme. When tested at low temperature the enzymes were indistinguishable in other respects: the reaction catalysed, cofactors required, pH optimum and Michaelis constant. Evidence for the thermal instability of the mutant pantothenate synthase is presented in Fig. 1 (from Maas and Davis, 1952), in which the triangles represent for the wild-type extract, and the circles for mutant (99-1t) extract, the

residual enzyme activity (tested at 15°) after incubation of the extract at the temperatures and for the times indicated. A

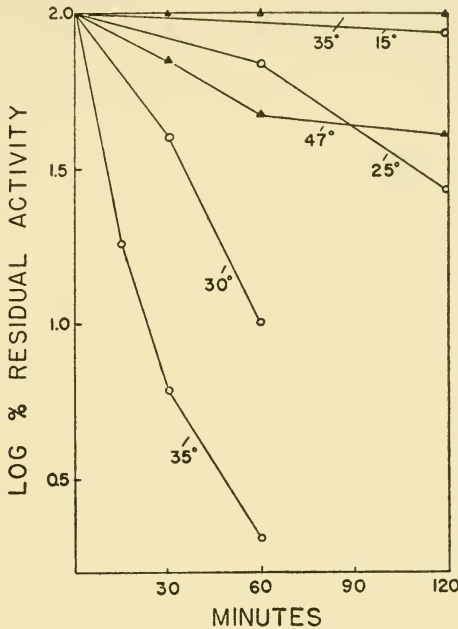

FIG. 1. Effect of temperature on the stability of the pantothenate-synthesizing enzyme in extracts of mutant 99-1t and of the wild type. Acetone-powder extracts of the two strains were incubated at the temperatures noted. At the times indicated samples were removed, cooled to 15° and tested for enzymic activity. In these tests, each tube received extract from 40 mg. of acetone powder of the mutant or extract from 3 mg. of acetone powder of the wild type. In addition, the testing tubes contained in mM concentrations: β -alanine 20, potassium pantoate 20, K_3ATP 10, KCl 100, $MgSO_4$ 10, tris-(hydroxymethyl)-aminomethane (Tris) buffer pH 8.5 100; total volume 1.0 ml. After incubation for one hour samples were assayed for pantothenate as described in the text. 100 per cent residual activity equals 86 μ moles of pantothenate per ml. per hour for 99-1t, 178 μ moles of pantothenate per ml. per hour for the wild type. ○-○- = mutant 99-1t; ▲-▲- = wild type. (Reproduced by permission of University of Chicago Press.)

large difference in thermal stability is seen. Furthermore, the fact that the difference resides in the enzymes themselves, rather than in their environments in the respective extracts,

was shown by the results of another experiment in which wild-type extract, mutant extract, and a mixture of the two were incubated at an intermediate temperature, i.e. one that caused destruction of essentially all of the enzyme in the mutant extract and none in the wild-type extract. The mixture lost a fraction of its activity corresponding to the mutant component of the total.

It is evident that mutations can result in subtle alterations in the nature of the enzyme performing a given reaction. Those resulting in increased thermal sensitivity appear to be frequent, probably because they are easy to select. Mutants with temperature-sensitive blocks in a number of biosynthetic reactions have been detected in our laboratory by starting with an auxotroph which lacks a given reaction at all temperatures, selecting reversions at 15°, and then finding which of these fail to grow at 37° (Maas, unpublished).

Another kind of qualitative alteration, which completely destroys the activity of an enzyme, has been observed by Suskind and co-workers (Suskind, Yanofsky and Bonner, 1955; Yanofsky, 1956). They found that certain mutants which had lost the power to form tryptophan synthase continued to form a protein that reacted serologically with antibody to tryptophan synthase. Other mutants blocked in the same biosynthetic reaction failed to form the serologically crossreacting protein. It therefore appears that the former mutants form an "inactive enzyme" corresponding to the altered gene, while the latter mutants are even more drastically altered.

It seems reasonable to expect that mutations can lead to all sorts of qualitative changes in enzymes, temperature sensitivity and loss of catalytic activity being recognized first because of the ease of their selection. These findings encourage the search for other qualitative changes that would lead to drug resistance.

Indirect evidence for such a phenomenon has been provided by a study (Davis and Maas, 1952) of analogues of two structurally related but metabolically distinct bacterial vitamins,

p-aminobenzoic acid (PAB) and *p*-hydroxybenzoic acid (POB) (Fig. 2). As is well known, PAB utilization is competitively inhibited by analogues in which the carboxyl is replaced by a substituted or unsubstituted sulphonamide group. Similar competition between POB and its sulphonamide analogues was observed. Furthermore, *p*-nitrobenzoic acid (PNB), an

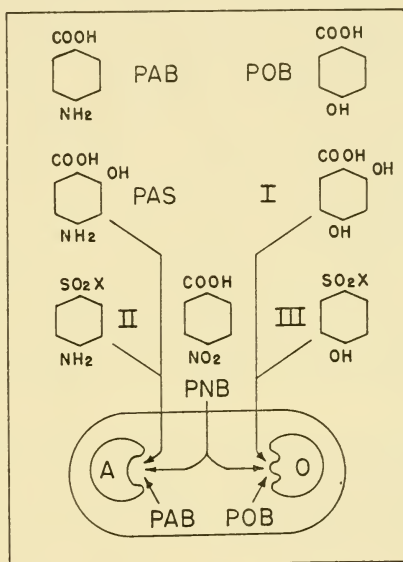

FIG. 2. Schematic representation of competition by analogues of PAB and POB. X = 2-thiazolylamino. (Reproduced by permission of University of Chicago Press.)

analogue involving replacement at the other end of the molecule (amino or hydroxyl), competes with both vitamins. It was observed that mutants resistant to PNB competition with either vitamin were not altered in respect to its competition with the other vitamin. Furthermore, with either vitamin there was no crossresistance between PNB competition and sulphonamide competition. Without presenting in detail the arguments involved or the subsidiary evidence (cf. Davis and Maas, 1952), I should like to summarize by stating that this

concatenation of facts appeared to exclude all but one of the seven mechanisms listed above. The conclusion, reached thus by exclusion, was that the mutants were resistant by virtue of producing an enzyme with decreased affinity for the inhibitor relative to the competitive metabolite.

The ratiocination involved in this study provided the author with a good deal of entertainment, much like that involved in trying to solve a detective story before the last chapter. But as with such a story, one cannot be sure of the relevance of the conclusion to real life. It would be highly desirable to demonstrate directly, with extracted enzymes, the inferred change in affinity. Unfortunately, though the PAB/sulphonamide interaction is the prototype of competitive inhibition, it has been studied only with intact cells; the biosynthetic reaction of which PAB is substrate is still unknown. The same is true of POB. And while growth-inhibiting analogues are known for a variety of other metabolites, including amino acids and vitamins, the biosynthetic reactions in which these metabolites participate are also by and large not enzymically defined.

Alterations in an extracted enzyme, nitro reductase, have been reported in bacteria resistant to chlortetracycline (aureomycin) (Saz, Brownell and Slie, 1956). It is not certain, however, that inhibition of this enzyme is the basis of action of the drug.

Specific permeation systems

Shortly after Ehrlich developed the effective chemotherapy of trypanosomiasis with arsenicals he encountered the phenomenon of drug resistance. Furthermore, he showed that resistant strains took up less of the drug than sensitive ones, and concluded that resistance might be based on decreased permeability to the drug or on a decreased number of receptors that can bind the drug. However, whether one is measuring arsenic or modern radioactive antibiotics, a decreased uptake of drug by resistant cells does not alone distinguish these two mechanisms. Furthermore, our thinking

about cell permeability was long dominated by a physico-chemical approach to the kinetics and thermodynamics of a passive membrane, with the cell viewed as a sort of cellophane bag filled with enzymes. It is therefore hardly surprising that studies based on such a naive model failed to lead to much enlightenment. Indeed, it would be difficult to explain with such a model how quantitative decreases in permeability could lead to corresponding decreases in uptake. For with a non-metabolizable drug, decreased permeability should lead to a decreased *rate* of approach to equilibrium, but not to a change in the distribution at equilibrium.

In the past few years, however, our picture of the permeability properties of bacteria has altered drastically. The cellophane bag now possesses a variety of permeation systems, each stereospecific for a structurally related group of substrates; and the number of units of each kind per cell not only affects the rate of equilibration between intracellular and extracellular substrate, but also affects the value of the ratio reached at equilibrium.

This development has arisen not only from direct studies of the intracellular concentration of various substances, but also from studies of the phenomenon of "crypticity"—i.e. the fact that certain enzymic activities can be demonstrated only after disruption of the cells. It has long been suspected that a permeability barrier prevented the added substrate from reaching the enzyme in such cells; but it could also be argued that the enzyme might be present in the cell in an inactive or latent form which became activated by the process of extraction. The question could be resolved if it could be proved that the enzyme was active in the intact cell.

This demonstration has now been accomplished in two cases by the use of auxotrophic mutants to demonstrate that the enzyme in question was essential for biosynthetic purposes, and hence must be present in active form. Thus it has been established by nutritional, isotopic, and enzymic methods that 5-dehydroquinic acid (DHQ), 5-dehydroshikimic acid (DHS), and shikimic acid (SA) are successive intermediates in the

biosynthesis of a group of aromatic metabolites (Davis, 1954-55).

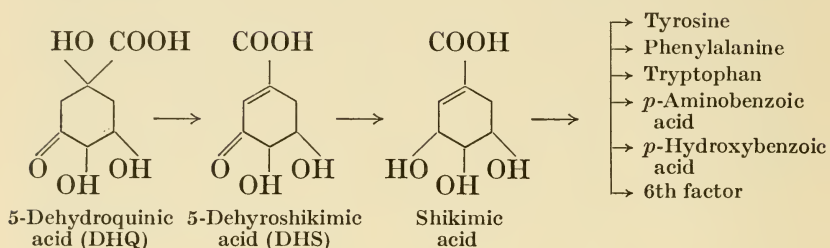

Yet mutants blocked before DHQ, though they contain the normal amount of the enzyme converting DHQ to DHS, are able to grow on DHS but not on DHQ. However, a secondary mutation of these strains, selected for by exposing large populations to DHQ, permits them to grow on DHQ (Davis and Weiss, 1953). Since the enzyme is there all the time, and is essential for biosynthesis, it is difficult to escape the conclusion that the secondary mutation in question has created a mechanism for the permeation of DHQ. The specificity of such permeation systems is shown by the fact that some mutations promote the penetration of DHQ and others similarly affect its close structural relative DHS; but neither mutation affects the other compounds (Davis and Weiss, 1953).

A permeability barrier has been similarly demonstrated for citrate, which has long been known to be inert for many organisms that contain the enzymes for its utilization. Much as in the case of DHQ and DHS it has been shown, with mutants of *Esch. coli* and *Aerobacter aerogenes* blocked before the compound, that citrate is an essential intermediate in glutamate formation (Gilvarg and Davis, 1956). Hence the enzymes between citrate and glutamate, which are readily demonstrated in extracts of these mutants, must be present in active form, and the inability of the organisms to utilize citrate as a replacement for glutamate must be due to a permeability barrier.

An important development in the study of bacterial

permeation systems has been the demonstration that certain of these systems are adaptive, i.e. they appear only when the cells are grown in the presence of the substrate or a related inducer. This adaptability has been demonstrated for the citrate system in *Pseudomonas* (Barrett, Larson and Kallio, 1953; Kogut and Podoski, 1953) and *Aerobacter* (Green, 1956), and for the β -galactoside transport system in *Esch. coli* (Davis, 1956; Monod, 1956). The systems resemble adaptive (inducible) enzymes in two further respects: the adaptation requires conditions that permit protein synthesis; and it is blocked by the presence of glucose or other carbohydrates which are known, in contrast to lactate or succinate, to block formation of many adaptive enzymes (Green, 1956; Davis, 1956; Monod, 1956; Rickenberg *et al.*, 1956).

The kinetics of the formation and action of an adaptive permeation system have been elegantly analysed by Cohen, Monod, and co-workers (Monod, 1956; Rickenberg *et al.*, 1956), employing β -galactosides. This system has the advantage that a substance is available, β -thiomethyl galactoside (TMG), which induces and is transported by the permeation system but is not metabolized; hence it is possible to study the ability of the system not only to transport but also to concentrate substrate. It would be inappropriate to review here all this work; but two further properties of the permeation systems should be noted. They resemble enzymes in their kinetics, which can be analysed in terms of a Michaelis constant, and they exhibit typical competition between structural analogues. Finally, the same group have also studied in detail analogous systems for concentrating various amino acids (Cohen and Rickenberg, 1956). These systems resemble the one for β -galactosides except that they appear to be constitutive rather than adaptive.*

* Monod has referred to stereospecific permeation systems as permeases (Rickenberg *et al.*, 1956), a term which seems to imply an enzymic nature. It seems preferable to avoid such a mechanistic term at this time, since future work will have to determine whether or not the action of these systems involves enzymic conversion of the substrate to another compound in the course of transport.

And now, what can we say about the relation of this work to drug resistance?

It is clear that a variety of specific permeation systems exist in bacteria; only a few have been sought, and they have been readily found. It therefore seems unlikely that non-specific pores in the membrane are important in bacteria except for perhaps the smallest molecules and possibly lipophilic substances. Furthermore, permeation systems, like enzymes, can be gained or lost by mutation, as has been shown for all the systems noted above. Finally, the number of permeation units per cell varies under different conditions, as could be shown by measuring the ratio of internal to external TMG. Applying these facts to the problem of drug resistance, it is easy to imagine that mutations, as well as physiological adaptations, could alter the number of units for transporting a drug, and hence could establish various characteristic ratios of internal to external free drug. Thus, though the passive model of cell permeability was quite unsatisfactory as a basis for explaining various degrees of drug resistance, "permeability" in the active sense described here makes possible a theoretically satisfactory solution. However, these concepts are so new that they have only begun to be applied to the problem of drug resistance. For example, it has been shown that some penicillin-resistant bacteria take up less of the inhibitor than sensitive strains while others do not. Perhaps Dr. Eagle, who has done much of this work, will discuss it here.

Some work of my colleagues (Maas and Frosch, unpublished) provides rather direct evidence for decreased permeability as a mechanism of resistance to the inhibitory action of D-serine on *Esch. coli*. This inhibitor has the advantage that its mode of action has been established as competitive inhibition of a biosynthetic enzyme, pantothenate synthase, whose activity can readily be measured in intact cells and in extracts (Maas and Frosch, unpublished; Maas and Davis, 1950).

The effect of D-serine is shown in Table I, in which wild-type *Esch. coli* is compared with a D-serine-resistant mutant

with respect to the ability of a resting cell suspension to form pantothenate from its precursors, β -alanine and pantoic acid. With intact cells the mutant showed less inhibition of this reaction by D-serine than did the wild type. However, after treatment with toluene to destroy permeability barriers the two cell suspensions were equally susceptible to the inhibition. Furthermore, in growing cultures, studies with radioactive

Table I

INHIBITION BY D-SERINE OF PANTOTHENATE PRODUCTION BY RESTING CELL SUSPENSIONS OF *Esch. coli*

D-serine $\mu\text{g./ml.}$	Wild type		Resistant mutant	
	Pantothenate produced $\mu\text{g./ml.}$	Percentage inhibition	Pantothenate produced $\mu\text{g./ml.}$	Percentage inhibition
	Intact cells			
None	6.1	—	1.4	—
250	1.2	80	1.3	7
500	0.9	85	0.8	43
	Toluene-treated cells			
None	2.1	—	3.6	—
1000	1.0	52	1.7	53

D-serine showed considerably less uptake by the mutant strain than by the wild type (Table II). Finally, inhibition of pantothenate synthesis required about 5 $\mu\text{g./ml.}$ with growing sensitive cells, 25 $\mu\text{g./ml.}$ with growing resistant cells, and 1000 $\mu\text{g./ml.}$ with toluenized cells. These results provide strong evidence that a decrease in permeability to D-serine is responsible for resistance in the mutant studied.

Decreased permeability also appears to be responsible for chloramphenicol resistance in *Pseudomonas*, since intact resistant cells are less susceptible than the sensitive parental

cells to inhibition of oxidation of a variety of substrates, whereas disrupted cells of the two strains fail to show this difference (Kushner, 1955).

In closing, I should like to emphasize several consequences of these recent developments for the study of antimicrobial action and of drug resistance. First, compounds that reverse an inhibition are not necessarily metabolites; they can also be analogues that interfere with penetration of the inhibitor. This concept finally furnishes a plausible explanation, for example, for the previously puzzling observation (Davis and

Table II
UPTAKE OF ^{14}C -D-SERINE DURING GROWTH

<i>Generation</i>	<i>Total counts/min. in bacteria</i>	
	<i>Wild type</i>	<i>Mutant</i>
1	915	136
2	2160	450
3	5000	775
Final medium	2690	7880

Maas, 1949) that D-serine inhibition, though clearly located at pantothenate synthesis, could also be reversed by a variety of metabolically unrelated amino acids. Secondly, alterations in permeability are not necessarily restricted to the cell membrane, since subcellular particles are also present in bacteria, and might be the site of a permeability barrier. Hence, when studies of drug concentration in resistant cells fail to show a marked decrease in permeation into the cell as a whole, the possibility of a change in a permeability barrier has still not been excluded. Finally, in a diploid bacterium, streptomycin resistance has been shown to be genetically recessive to sensitivity (Lederberg, 1951). This observation would be difficult to understand if resistance were due to a qualitative or quanti-

tative change in an intracellular enzyme, and if each of the paired allelic genes exhibited the expected autonomous control over the corresponding protein. However, recessive resistance would be easily explained if the sensitive allele were providing the cell with normal permeation units.

REFERENCES

- ABRAHAM, E. P. (1933). *In* Adaptation in Micro-organisms, Eds., Davies, R., and Gale, E. F. Cambridge University Press.
- BARRETT, J. T., LARSON, A. D., and KALLIO, R. E. (1953). *J. Bact.*, **65**, 187.
- COHEN, G. N., and RICKENBERG, H. V. (1956). *Ann. Inst. Pasteur*, **91**, 829.
- DAVIS, B. D. (1954-55). *Harvey Lect.*, **50**, 230.
- DAVIS, B. D. (1956). *In* Enzymes: Units of Biological Structure and Function, p. 509. Ed., Gaebler, O. H. New York: Academic Press.
- DAVIS, B. D., and MAAS, W. K. (1949). *J. Amer. chem. Soc.*, **71**, 1865.
- DAVIS, B. D., and MAAS, W. K. (1952). *Proc. nat. Acad. Sci., Wash.*, **38**, 775.
- DAVIS, B. D., and WEISS, U. (1953). *Arch. exp. Path. Pharmacol.*, **22**, 1.
- GILVARG, C., and DAVIS, B. D. (1956). *J. biol. Chem.*, **222**, 307.
- GREEN, H., cited in Davis (1956).
- HOROWITZ, N. H., and FLING, M. (1953). *Genetics*, **38**, 360.
- KOGUT, M., and PODOSKI, E. P. (1953). *Biochem. J.*, **55**, 800.
- KUSHNER, D. (1955). *Arch. Biochem. Biophys.*, **58**, 347.
- LEDERBERG, J. (1951). *J. Bact.*, **61**, 549.
- MAAS, W. K., and DAVIS, B. D. (1950). *J. Bact.*, **60**, 733.
- MAAS, W. K., and DAVIS, B. D. (1952). *Proc. nat. Acad. Sci., Wash.*, **38**, 785.
- MONOD, J. (1956). *In* Enzymes: Units of Biological Structure and Function, p. 7. Ed. Gaebler, O. H. New York: Academic Press.
- PAULING, L., ITANO, H. A., SINGER, S. J., and WELLS, I. C. (1949). *Science*, **110**, 543.
- RICKENBERG, H. V., COHEN, G. N., BUTTIN, G., and MONOD, J. (1956). *Ann. Inst. Pasteur*, **91**, 829.
- SAZ, A. K., BROWNELL, L. W., and SLIE, R. B. (1956). *J. Bact.*, **71**, 421.
- SCHNITZER, R. J., and GRUNBERG, E. (1957). Drug Resistance. New York: Academic Press.
- SUSKIND, S. R., YANOFSKY, C., and BONNER, D. M. (1955). *Proc. nat. Acad. Sci., Wash.*, **41**, 577.
- YANOFSKY, C. (1956). *In* Enzymes: Units of Biological Structure and Function, p. 147. Ed. Gaebler, O. H. New York: Academic Press.

DISCUSSION

Pontecorvo: I suggest we add another group of organisms, namely the filamentous fungi. You mentioned dominance and recessiveness. In *Aspergillus* we can use classical techniques to identify and locate genes. Roper has an acraflavine-resistant mutant at one locus which is partially dominant in the heterozygote, i.e. the heterozygote is intermediate in resistance. Then he has, at a different locus, a completely recessive mutant resistant to the same drug. If permeability is responsible in these two cases, as you pointed out there must be quite a number of different ways of altering it.

Davis: I am interested to learn of this work. I wonder whether the mutation to resistance at one of these loci might not involve altered permeability while that at the other locus caused resistance through quite a different mechanism.

Pontecorvo: But the question of recessiveness that you raised is more likely to fall into this type of category.

Eagle: There are two systems in which there is an indication that differences in resistance reflect an alteration in a cell component, rather than differences in permeability. One is the recent demonstration by Saz that *Esch. coli* contains a nitro reductase which is strongly inhibited by aureomycin, and which contains both a protein and flavin moiety. In the nitro reductase of the parent sensitive cell, the flavin dissociates readily; while in the enzyme complex deriving from aureomycin-resistant cells the flavin and protein have a greatly increased affinity. The relationship of this difference to aureomycin resistance, specifically, is not entirely clear; but what seems to be quite clear is that in the resistant cell there is a nitro reductase which is no longer inhibited by aureomycin, and the flavin component of which is strongly bound to the protein. The development of resistance is associated with a specific and qualitative change in an enzyme normally vulnerable to aureomycin.

The other system relates to penicillin resistance. Bacterial species as they occur in nature differ markedly in their binding affinity for penicillin, and in direct proportion to their penicillin-sensitivity. The sensitive organism is one which has a high binding affinity for penicillin, so that lethal concentrations are attained in the cell with a relatively low concentration in the environment. That lethal cellular concentration was of the same order of magnitude for all bacteria examined. Here again we are not dealing with a permeability difference; for the same difference in penicillin-binding capacity between sensitive and resistant organisms is evident in cell-free *sonates*. Macromolecular components of those *sonates* differ, as do the whole cells, in their affinity for the drug. Now the curious thing is that this relationship between binding affinity and penicillin sensitivity applies only to strains as they occur in nature. If one takes a sensitive strain and makes it resistant by appropriate selection, that development of resistance is not associated with changes

in binding affinity, which may increase, decrease or remain unchanged. The mechanism of resistance in these variant cultures is totally obscure.

Pollock: Prof. Davis, would you care to expand on this case of Cohn and Novick in which, apparently, there is an almost perpetual inheritance of an acquired character?

Davis: The essential facts are these. As I noted earlier, when β -thio-methylgalactoside (TMG) is added to a growing culture of *Esch. coli* the cell is induced to form two new entities: one is the well known intracellular β -galactosidase, and the other is the more recently discovered system which transports various β -galactosides into the cell, and even concentrates some of them (e.g. TMG). When the concentration of TMG is sufficient—say $10^{-3}M$ —induction is maximal, and within a minute or two exponentially growing cells start forming the new components at a constant rate per unit of new cellular material synthesized. When the concentration of TMG is too low—between 10^{-5} and $10^{-6}M$ —there is no induction. However, Melvin Cohn found that such a low concentration of TMG will maintain induction in cells that had been previously grown in a sufficient concentration to bring about induction. Furthermore, it is known that at intermediate concentrations of TMG the culture is induced gradually, the rate of enzyme synthesis per cell rising for many generations. Aaron Novick and Milton Weiner have recently found that under these circumstances the rate of synthesis is not increasing gradually in each cell. Instead, the population is heterogeneous, cells being either fully induced or uninduced. This is shown by transferring single cells from such a population to tubes of medium containing a maintenance concentration of inducer. The induced cells formed fully induced clones; the others yielded uninduced clones. Evidently at intermediate concentrations of inducer a cell has a small chance of being induced to form its first permeation unit. This will concentrate the TMG, which will increase the effectiveness of induction, and in this autocatalytic way the cell will soon be fully induced. Then even low external concentrations of TMG will provide sufficient internal TMG to maintain full induction.

This system has a close formal resemblance to an environmentally directed mutation. On growth in an intermediate concentration of TMG a fraction of the cells are altered (induced). The difference between these and the uninduced cells can then be transmitted indefinitely through future generations, provided the medium contains a maintenance concentration of inducer. A difference between these cells and mutants, however, is that the pseudomutations can be uniformly reversed by a few generations of growth in medium with no inducer at all.

Whether this phenomenon will be relevant to problems of drug resistance remains to be seen.

Knorr: Suppose you were to produce resistance with a drug acting as an inducer of an adaptive enzyme which enabled the organism to grow in the presence of the drug either by destroying it as with penicillinase or in some other more indirect way. It is conceivable that some normal metabolite present in very low concentrations might, by being concentrated in some such way as you suggest, also act as a permanent inducer of the same enzyme, so that the organism would remain permanently

resistant to the drug even when repeatedly subcultured in its absence, and without any genetic change having occurred. In other words, there might be some normal metabolite which could maintain drug resistance by some concentrating mechanism of the kind you described.

Davis: Yes, I can imagine that a drug might induce an altered capacity of the cell, or of a subcellular particle, to concentrate both the drug and some substance in the environment other than the drug. Then on further growth in the absence of the drug the other substance, which might be a normal metabolite, could conceivably maintain the induced state.

GENETIC AND METABOLIC MECHANISMS UNDERLYING MULTIPLE LEVELS OF SULPHONAMIDE RESISTANCE IN PNEUMOCOCCI

ROLLIN D. HOTCHKISS AND AUDREY H. EVANS

The Rockefeller Institute, New York

DEVELOPMENT by bacteria of resistance toward a drug to which they are normally sensitive not only challenges the medical men, sworn enemies of bacteria, but has lately commanded the attention of those whose interest in bacteria is that of admirers, the biochemists, as well as those historians, the geneticists. Demonstration by Demerec (1945) that drug resistance in bacteria could be the result of discrete mutational events, led us to seek stable sulphanilamide resistance in *Pneumococcus* which might be transferred to sensitive cells by the technique of transformation. Heritable transfer of specific capsule synthesis had been discovered by Griffith (1928) as an *in vivo* transformation. Langvad-Nielsen (1944) could not demonstrate transformation of pneumococci to sulphonamide resistance, but one must recall that in using the Griffith procedure, he was requiring transfer of both drug resistance and encapsulation (or resistance and mouse virulence) at once, an event we now have reason to consider unlikely. Even after the classic discovery of Avery, MacLeod and McCarty (1944) that the capsule-transforming activity was associated with cell deoxyribonucleate (DNA), our first attempts in 1948 to induce sulphonamide resistance failed for various reasons. It was penicillin resistance and streptomycin resistance which were the object of the first quantitative transformations (Hotchkiss, 1951), and since that time this type of marker has been much used. Sulphonamide resistance transformations were successfully achieved by the present authors in 1952, but although mentioned a number

of times (e.g. Hotchkiss and Marmur, 1954) they have not been described in any detail.

Of the fifteen drug resistance traits that have by now been transformed with DNA into *Pneumococcus* (and one or two into *Hemophilus influenzae*) all have so far been transferred in essentially the normal form as first encountered. In the case of penicillin-resistant pneumococci, the DNA from multiple-step highly resistant donor strains gave transformation to unit resistance steps (Hotchkiss, 1951), but none of the transformants detected bore mutant properties other than those which had been encountered in the history of the donor strain. Essentially the same result was obtained with the first sulphonamide resistance transformations and a number of others.

In 1955, however, a highly resistant pneumococcal mutant, designated Fn, was isolated after selection in a single exposure to sulphanilamide. The indications were that a rare single-step mutation had occurred, resulting in a resistance to more than 600 μ g. sulphanilamide per ml. of standard medium. Like the somewhat analogous single-step mutant obtainable from many bacterial species and highly resistant to streptomycin, this new pneumococcal strain is stable and can be propagated indefinitely without change of resistance level.

Disseminative Transformations

By contrast, when the strain Fn was used as donor of DNA to transform the sensitive parent strain, only a very few transformants displayed the high resistance of the donor. A far greater number of transformants were obtained which were resistant only to lower concentrations of sulphanilamide. Furthermore, when examined at a series of drug concentrations, several fairly distinct classes of transformants could be identified, having quantitatively different resistance toward sulphonamide, and all but one had a lower resistance than the donor. By this direct observation and isolation, four classes could at once be recognized in a first trans-

formation, as indicated in Table I. This result has been repeatedly observed, with different recipient strains and different DNA preparations.

Further genetic analysis of the system was made by isolating and testing several typical transformants of each class, both as donors and recipients in further transformations. All proved to be stable on propagation in culture, but those

Table I
DISSEMINATIVE TRANSFORMATION OF A RESISTANCE PROPERTY
NORMALLY INHERITABLE

Donor a single-step mutant	First-stage transformants	Progeny	Second-stage transformants	Identified genotypes
600	10	10	10	a
	40	40	40	d
	300	300	10 40 300	a d ad
	600	600	10 40 300 600	a d ad adb
	120	120	120	c

which resembled the donor, Fn, gave the same multiple classes of transformants, and the one having resistance to 300 $\mu\text{g./ml.}$ also gave several transformants, when used as donors. Certain other types seemed to transfer their genotypes intact by transformation and accordingly were assigned the unit marker designations Fa and Fd (or simply *a* and *d*), as indicated in Table I.

Starting from this basis, it was possible to seek and discover a third unit marker, *b*. By transforming one unit strain with the DNA from another, it was possible to create the paired combinations *ab*, *bd*, and *ad*, and from each of these with the appropriate single marker DNA to prepare

transformants like the original highly resistant strain Fn, now therefore considered to be *Fadb* or *Fbad*. Each of the pair combinations as DNA donors in transformation gave rise to the expected transformants of their own phenotype and also of the unit types of which they are "composed".

Determining quantitatively the proportions of the various transformants when Fn is the donor, it has been inferred that its units have the probable sequence *adb*, in which the pair *ad* is linked closely and the pair *db* is loosely linked. The linkage between *a* and *b* seems to be lower and is an indication that the donor Fn with a similar linkage has the genetic composition *adb*. All seven possible type of recombinants have been made by transformation of the sensitive strain, and the relative frequencies of their production are in accordance with this arrangement. It is probable that frequencies of linkage in such minute recombinations are determined not only by distances but also by preferential breakage points, and limitations upon the size of the fragment of DNA can be incorporated.

Here, then, is a strain, Fn, whose high resistance to sulphonamides is determined by its genic substance; in particular, its DNA. This DNA is passed on intact from mother to daughter cells at division, but on incorporation into new cells in transformation is usually fragmented. The three regions (*a*, *d*, *b*) of alteration in the mutant DNA represent another example of genetic fine structure (see Demerec, Blomstrand and Demerec, 1955; Benzer, 1955) which seems to be within a single gene. Of interest in the present case is the fact that this linkage of subunits is displayed by chemically purified DNA. Furthermore, it is a welcome feature in this instance that each of the genotypes *a*, *d*, *b*, *ad*, etc. obtained by disseminative or dispersive transformation has a distinctive phenotype providing its own basis for quantitative recovery. In previously investigated cases, the recombining variants all have the same phenotype, a certain biochemical or physiological lack, and cannot be distinguished from each other.

Nature of Sulphonamide Resistance

The possibility of defining the physiological mechanism which implements such a subtle series of genetic controls, has led us to study the effect of sulphonamides upon these mutants and transformants. It is possible to infer from the literature that the drug acts upon a system utilizing *p*-amino-benzoate (PAB) and leading to the production, first of compounds related to folic acid, and through them, of cell substance (Fig. 1). In support of this inference, it can be shown

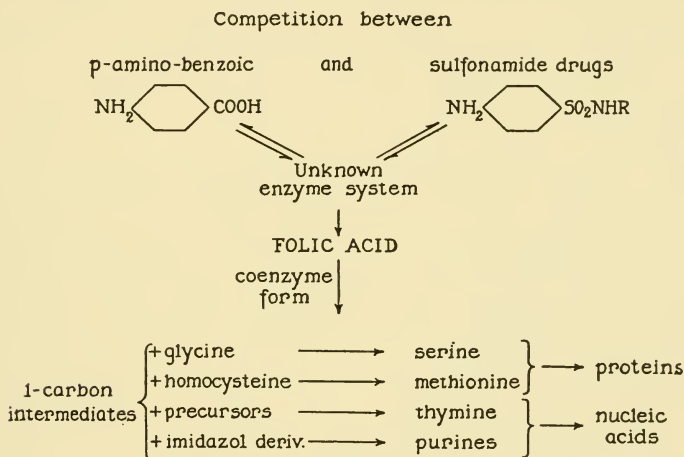

FIG. 1.

that these sensitive and resistant strains of *Pneumococcus* all withstand more sulphanilamide (SA) in the presence of added PAB. The drug and metabolite compete in the classical way defined by Woods (see e.g. Woods, 1950), and SA/PAB molar ratios giving partial growth inhibitions are essentially constant over 50-fold ranges of absolute concentration. The retention of resistance over wide ranges of absolute concentration serves to eliminate hypotheses based upon possible changes in the rates of supply or utilization of metabolite or drug.

There would seem to remain four principal classes of hypotheses which might rationalize this family of three sulphonamide resistance levels and their various combinations: (1) that there are several independent PAB-using enzyme systems essential for cell growth and three of these can become resistant to inhibition; (2) that the affinity of a single enzyme for sulphonamide relative to PAB is being cumulatively reduced by each unit of mutation; (3) that the permeability of the cells to sulphonamide is quantitatively altered as the result of mutations; or (4) that an alternative metabolic pathway, which is PAB-sparing, becomes available in each resistant strain.

Although *a priori* any one mutant might arise as above, the behaviour of the series of mutants makes some of the hypotheses improbable. It is difficult to understand the independence of the factors *a*, *b*, and *d* if they determine separate and essential systems (hypothesis 1)—how, for example, could an enzyme *Ea*, the one altered to give mutant *a* its resistance to SA, be unchanged in both the comparatively resistant mutant *d* and the sensitive wild-type strain? Such an independence would seem more in keeping with a series of independent enzymes which provided alternative pathways to the same end-products (hypothesis 4). On the other hand, the *cumulative* effects of the marker pairs suggest that in their phenotypic effects they are even more co-operative than any independent determinants would be. For example, *a* (giving a resistance to 10 μ g. SA/ml.) and *d* (40 μ g./ml.), when recombined by transformation give a strain *ad* resistant to 300 μ g. SA/ml. It would seem most likely that the co-operating factors *a* and *d* are acting upon the same enzyme (hypothesis 2) or the same permeability-determining system (hypothesis 3) since they potentiate each other so notably.

Little is known about factors controlling permeability, but it seems clear that a time rate cannot be the limiting one, since near-infinite time is available as an inhibited cell slows down and stops growing. Furthermore, if a concentration rate is the limiting one for permeability, the properties of a permeability-determining substance which mutates to states

giving different internal concentrations of SA within the cell, are formally very much like those of an enzyme which mutates so that it responds differently to the same concentration of drug. In both cases a single entity is inferred which can exist in several states having different affinities for the sulphonamide.

Sulphonamide Inhibition of Cell Growth

There is no great difficulty in assessing accurately the level of SA which just permits or slightly inhibits growth of a pneumococcal strain. In such an experiment one is testing

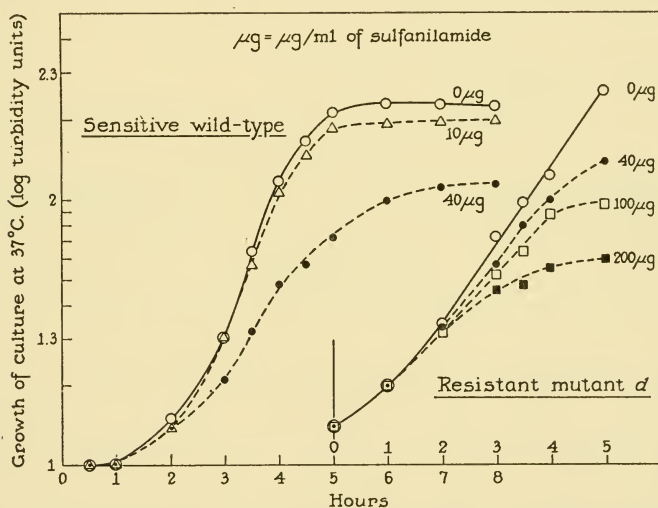

FIG. 2. Inhibition of pneumococcal growth by sulphanilamide in excess.

for indefinitely continued division of virtually every cell within the culture. Such a threshold concentration of drug, however, does not at first sight seem to have much effect upon cell metabolism. Even when so gross a measure of growth as the total turbidity of the culture is followed, the effect of SA seems to be slight. Such turbidity curves as those

shown in Fig. 2 seem confusing when it is realized that turbidity increases almost as much as in the control when 10 to 20 times the inhibitory concentration of SA is present.

The explanation lies in the limited number of divisions observed in the experiment. As indicated in Fig. 3, different growth media can supply different samples and quantities of the eventual products of PAB metabolism. In addition, the cells themselves can accumulate and later use substantial amounts of the catalytically effective product(s) of PAB, folic

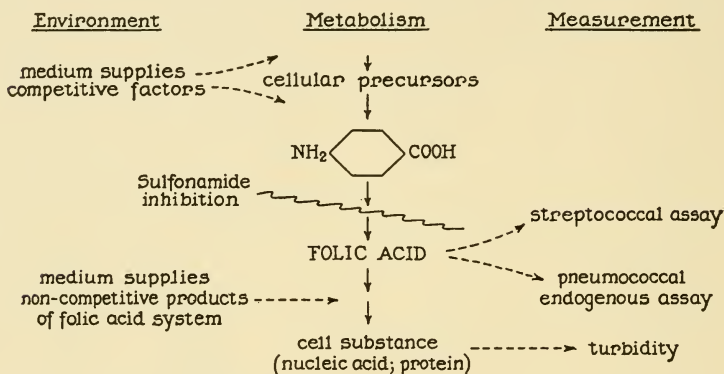

FIG. 3. Determination of inhibitory effects of sulphonamides.

acid(s). Therefore, when placed under conditions fully inhibitory to folic acid synthesis the cells nevertheless are able to complete a limited number (usually three to five) terminal divisions. When using such measures of growth as turbidity, one may purposely start with an initial culture heavy enough to measure. An increase of 10- to 30-fold may be possible in sulphonamide so that the measuring instrument may only reveal the late stages of inhibition or none at all, as in Fig. 2.

It is clear, therefore, that the true ability to survive in sulphonamide is only assessed when indefinite propagation is demanded, as when single organisms are required to produce colonies. A second difficulty is the PAB-sparing effect of end-

products of PAB metabolism such as the purines, pyrimidines and amino acids, normal constituents of the complex media used for pneumococci. Not only the number of terminal divisions but the limiting steady growth of pneumococci in sulphonamide is modified by such metabolites. Accordingly, the inhibitory levels of SA or the SA/PAB ratios for limiting growth can be made to vary in absolute value when such factors in the media are varied.

A strong indication that only a single site of action is involved is found when one relates these indices for mutant strains and wild types to each other, as the medium is altered deliberately in this fashion. It was found that the half inhibitory SA concentrations and SA/PAB ratios could be altered 5- to 10-fold in magnitude through changing the medium, and yet the relation between the indices for mutant/wild type remained constant. It appears reasonable therefore that the actual basis for the sulphonamide resistance in the mutants, at least for the two or three so far tested, is an altered affinity of sites on some single enzyme (or possibly a single permeability-determining concentrating system) for SA relative to PAB. If this proves to be true, it may be hoped that we are now in possession of a system in which a series of interrelated alterations within a DNA particle exerts genetic control over corresponding properties at a site within a protein molecule, altering its affinities for a known metabolite and drug.

The further definition of the phenotypic modifications existing in these resistant mutants seems to be possible when folic acid synthesis is measured, somewhat along the lines of the method of Nimmo-Smith, Lascelles and Woods (1948). The sulphonamide inhibition of this function is, in contrast with growth, not greatly modified by constituents of the medium, and we have little doubt that more fundamental SA affinities will soon be established for each strain. The details of these studies and of a considerably simplified auto-genous pneumococcal assay for folic acid will be published elsewhere.

General Remarks

By way of more general observation, it should be pointed out that there may be many other drug systems for which storage of end-product metabolites, or inhibitors, or their presence in the medium can give temporary independence from drug-inhibition. In such systems, many cell divisions could occur in the presence of the drug. If, during these terminal divisions any adaptive process reduces the requirement for end-metabolite, then of course an adaptive resistance will have been developed. If these terminal divisions have allowed the development of a genetic mutation towards resistance, then that too may have seemed to be favoured by the presence of drug. In general, it should however have appeared in the control populations of equivalent size, and the actual observation would only be an increased proportion of resistant cells among the survivors when drug is present. The familiar variance test should be capable of showing that the presence or absence of the mutant is determined by chance, and that only its accumulation during the period of terminal divisions of the non-resistants is influenced by drug.

The danger exists that in such cases not all cells rated as "resistant" will be really so, since merely replacing with fresh medium or shifting the medium or mode of test between the "adaptation" stage and the challenge for resistance can lead to the result that any cells which may have stored much metabolite during "adaptation" will grow for a long time relatively independently of drug when given a new opportunity in the challenge situation. Clearly in such a case it is important to use subtransfers and lineage tests to inquire to what extent a more or less persistent drug resistance has been achieved.

REFERENCES

- AVERY, O. T., MACLEOD, C. M., and McCARTY, M. (1944). *J. exp. Med.*, **79**, 137.
BENZER, S. (1955). *Proc. nat. Acad. Sci. Wash.*, **41**, 344.
DEMEREK, M. (1945). *Proc. nat. Acad. Sci. Wash.*, **31**, 16.

- DEMEREK, M., BLOMSTRAND, I., and DEMEREK, Z. E. (1955). *Proc. nat. Acad. Sci. Wash.*, **41**, 359.
- GRIFFITH, F. (1928). *J. Hyg.*, **27**, 113.
- HOTCHKISS, R. D. (1951). *Cold Spr. Harb. Symp. quant. Biol.*, **16**, 457.
- HOTCHKISS, R. D., and MARMUR, J. (1954). *Proc. nat. Acad. Sci. Wash.*, **40**, 55.
- LANGVAD-NIELSEN A. (1944). *Acta path. microbiol. scand.*, **21**, 362.
- NIMMO-SMITH, J., LASCELLES, J., and WOODS, D. D. (1948). *Brit. J. exp. Path.*, **29**, 264.
- WOODS, D. D. (1950). *Ann. N.Y. Acad. Sci.*, **52**, 1199.

DISCUSSION

Stocker: It has been suggested that strains of *Neisseria*, resistant to sulphonamides, have an increased ability to synthesize PAB. Is there any suggestion of that kind of resistance in *Pneumococcus* in addition to the more complex one?

Hotchkiss: We don't see it in these strains, and I have never seen it. The argument against it is that when we swamp the PAB which the cells are endogenously making, by supplying PAB in the outer medium, we still retain the same relative resistance level, the relation between different mutants remains the same, even when we add so much that it takes 150 times as much sulphonamide to block growth.

Pontecorvo: Do I remember correctly that in a case of *Neurospora* sulphonamide resistance, there is an increase in endogenous production of PAB?

Davis: I don't know about simple resistance, but the sulphonamide-dependent *Neurospora* mutant does not make more PAB. It is inhibited by an imbalanced biosynthesis resulting from abnormal responsiveness to its normal amount of PAB.

Lederberg: In the control of resistance to penicillin is there a fundamental difference in the interaction of the genes?

Hotchkiss: The higher level of penicillin never gave rise to any low level other than those particular low steps known to be reached during its derivation, in a certain sequence.

Lederberg: So that the interactions are presumably specific? Are you distinguishing the levels purely by phenotype? Because it may be that there are several different mutations which simply give the same level of resistance when you have only one of them, but which may interact to give higher levels, which could be looked for by transformations among the first ones.

Hotchkiss: We tried transformations among them. We took highly resistant donors, recovered all of the low-level transformants that they produced as a mixed culture, made DNA from the mixed culture and generally tested both mixed culture and DNA to see if either contained anything from a higher level; whatever it may have contained was too little to show. It may well be that there are hidden members of the population that have acquired the factor *b* or *c*, but that show no penicillin resistance.

Lederberg: You had a similar evidence for the specificity of interaction with chloramphenicol, Cavalli-Sforza.

Cavalli-Sforza: Specificity of interaction is of some interest. As a consequence of it, every process of selection, leading to multistep resistance, is in itself more or less unique, because much depends, for the later stages, on which is the first resistant gene that came in. The later ones are bound to interact with that one; they have to increase the resistance of that one. Therefore, you may even find situations where the second gene that gives second-step resistance does not give resistance by itself; if you isolate it by recombination, you may find that that second gene is only a modifier of the first. It may have an effect on resistance only in combination with the first.

Lederberg: It should then be possible to cross two strains obtained separately, but of equal resistance, and get progeny which are more sensitive than either parent.

Cavalli-Sforza: Exactly, that is what is happening.

Demerec: In the work you have completed so far, Dr. Hotchkiss, have you obtained any evidence that throws light on the mechanism by which transformation is accomplished? In this particular case dealing with transfer of high resistance to sulphurs, you assume that you have three genes which are linked together and which would be carried in one transforming unit of DNA. You assume the order of these genes to be *adb*. Have you any evidence of a combination of *ab*? Can you tell if that may be transferred when you start with a donor which carries all three?

Hotchkiss: As far as we can see we don't get the *ab*'s from the donor which has *adb*. We get either the whole piece or fragments. If we create *ab* by using the *a* and the *b* separately, then the *ab* transfers approximately as often as the *adb*. So the frequencies fit, in this case, and it is the rareness of this type that is the basic argument for the sequence, the *db*'s and the *ad*'s are much more frequent than the *ab*'s.

Davis: Is the linking of these close enough for you to have any idea as to whether these different units are likely to be concerned with a single genetic unit in terms of physiological function? Do you know any other cases in which a single mutation can give you divisible changes?

Hotchkiss: Mutations can be inversions of whole regions and transpositions and so on. It would require many markers to find them in bacteria, but it would not be out of the question. We tend to think of mutations in the purest case as more or less point mutation.

Demerec: There are large numbers of mutations known which affect a region involving several gene loci, but this is the first case, as far as I am aware, where such mutation is divisible. In most other cases, probably we are dealing with deficiencies involving a part of a gene or adjacent genes.

Davis: Prof. Cavalli-Sforza published evidence some years ago that in multiple-step resistance several different loci can be concerned, each making its contribution. That result may perhaps have lent support to the impression, which seems widespread, that it is hard to picture mutations as giving rise to the enormous numbers of degrees of resistance you can get, because you would have to have so many different loci involved.

However, we know that with auxotrophic mutants you can get not only mutations giving rise to an all-or-none appearance or disappearance of an enzyme, but also mutations causing wide quantitative variations in the amount present, and other mutations causing qualitative variations in the value of an enzyme. Hence, the number of loci affecting resistance to a given drug does not have to be nearly as large as the number of steps of resistance that can be distinguished, since various alleles at a single locus could be expected to produce different degrees of resistance.

Cavalli-Sforza: There is a widespread impression that the gradual type of adaptation is likely to be physiological rather than genetic. I tend to hold another view: I don't see any reason why the gradual adaptation should be easily physiological. Dr. Demerec, in the early stages of his work when he started the genetic analysis of bacterial drug resistance, called the gradual and the abrupt types of adaptation "penicillin and streptomycin patterns". Whether some drug tested on some organism is going to show one or the other pattern depends entirely on the relative frequency of the various types of resistance mutations that can occur. If mutations that have a small effect are more frequent, then you are more likely to have the penicillin type, i.e. the gradual type of adaptation; and that is likely to be the most frequent case, because it seems reasonable to expect that mutations having small effects are more frequent than those having large effects. There has been an accumulation of data showing that gradual adaptation also is indeed of genetic origin. There is evidence from indirect selection, such as the data on chloramphenicol resistance—first step only—and Yudkin's evidence on multistep adaptation to proflavine, which shows that in the case of the chloramphenicol and proflavine systems of "gradual" adaptation you do have genetic adaptation. There is all the evidence from recombination, and transformation data, showing that "gradual" adaptation is due to nuclear genes having small effects, which effects can add together to give a big one ultimately.

Hotchkiss: We have studied what we call lysis transformation, in a mixed culture having penicillin-sensitive organisms which were streptomycin-resistant, mixed with penicillin-resistant organisms which were streptomycin-sensitive. When this mixed culture was grown in penicillin, the penicillin-sensitive cells were killed. Thereupon they lysed, DNA was released, and this DNA interacted with the surviving resistant culture so that streptomycin resistance was introduced into that culture. Therefore, we had a compiling of information; when these cells died, they passed on a high proportion of their information. Now consider what could happen if this were one of the cases such as Prof. Cavalli-Sforza has seen, for let us say a drug which kills. Suppose one component is penicillin-resistant to 5 μg . and another is penicillin-resistant to 10 μg . If we introduce 10 μg . of the drug, the former will be killed, and if these are independent factors, there could now appear transformant "tens plus fives", that might well be resistant to 200 μg . This would now be a mechanism for fairly efficient compilation, within a culture, of all the properties that were present. If we bear in mind that some of these might be of the latent type, they would not be easily recognized

and a lysis transformation such as we have demonstrated might easily produce a dramatic increase in resistance in such a mixed culture.

Lederberg: Since Dr. Hotchkiss has brought this up, a word of caution may be added. There has been some misunderstanding in the literature about the possible rôle of transformation in the development of resistance in bacterial cultures. It has been suggested, for example, that an initial resistant cell might arise by some unspecified process, perhaps by spontaneous mutation, and that this quality could then spread through the population by a transformational process. In all of these cases you are very lucky indeed if you get anywhere near one new resistant for each resistant cell which has died and released its DNA. In most cases that figure is very low, and in no case does it exceed one in any practical situation. For this reason, transformation is not a means by which the proportion of resistant cells in a culture can rapidly increase.

THE PHENOTYPIC EXPRESSION OF GENES DETERMINING VARIOUS TYPES OF DRUG RESISTANCE FOLLOWING THEIR INHERITANCE BY SENSITIVE BACTERIA

W. HAYES

Department of Bacteriology, Postgraduate Medical School, London

WHEN a gene in a bacterial cell is changed to an allelic state by mutation, or is replaced by an allele during recombination in parasexual systems, the altered genotype of the cell will not immediately be expressed in a corresponding change of phenotype. This delay of expression, known as phenotypic lag, can theoretically be accounted for by the operation of one or more of several circumstances. Firstly, genes can only manifest their effects through the enzymic potentialities and organization of the cytoplasm. The new gene finds itself confronted with a cytoplasm adapted to the expression of the allele which it has replaced. Thus, if the new gene determines the synthesis of an enzyme of which the cell is devoid, at least one molecule of enzyme must be created, and its dependent synthesis initiated, before expression can occur. Alternatively, if the new gene differs from its allele in being unable to synthesize a particular enzyme, then its expression will be delayed until the enzyme molecules already present in the cytoplasm have been diluted out by successive divisions of the cell. Secondly, bacteria are peculiar in that each cell possesses, at least during the logarithmic phase of growth, two or more nuclear analogues. The occurrence of a mutation involves a gene in only one of these nuclei so that the mutant cell initially contains one or more wild-type genes as well as the mutant gene and therefore resembles a heterokaryon. If, as appears usually to be the case, the mutant character is recessive to the wild-type character, then the mutant gene

will be unable to express itself phenotypically until it has become separated from the wild-type genes by nuclear and cellular division. In this way, although bacteria are haploid organisms, relationships of dominance and recessiveness can come into play following mutation. Such relationships are found, in a more orthodox way, in bacterial parasexual sexual systems in which a fragment of the chromosome from a donor cell is introduced into a recipient cell. This fertilized cell becomes a partial heterozygote within which a process of recombination occurs. It is not known for certain what this process involves, but the evidence suggests that the incoming fragment of donor chromosome and the chromosome of the recipient cell pair together and then begin to replicate. During this operation, a replica commenced on one of the pair may suddenly switch to copy the other, and thence switch back to continue copying the chromosome on which it started. In this way a completely new chromosome is produced which, although basically that of the recipient cell, incorporates part, or the whole, of the incoming donor fragment. From this stage onwards it is likely that the recombinant chromosome segregates into an autonomous cell in the same manner as a mutant chromosome, so that something may be learned about the phenotypic expression of mutations from the study of the kinetics of segregation and expression in the parasexual systems of bacteria.

A direct approach to the kinetics of phenotypic expression of mutations is a difficult matter from both the theoretical and experimental points of view. In order to study the sequence of events as a function of time, it is necessary to have a high degree of synchrony among these events in the population, and to be able to observe their progress from their inception. By definition, such synchrony is impossible in the case of spontaneous mutations which are rather rare events whose occurrence is determined by chance. Moreover, mutations can usually only be demonstrated by selective techniques so that we can detect only those mutations which have already become expressed at the time when the selective

agent is applied. These difficulties can be overcome to some extent by subjecting bacterial populations to the action of physical or chemical mutagens which not only may greatly increase the total number of mutations but, at the same time, will synchronize their initiation. However, the use of such agents introduces other variables which may have a profound effect on the sequence of events. For example, it has been shown that even a low degree of irradiation with ultraviolet light temporarily arrests the synthesis of deoxyribonucleic acid of which the genetic material of the cell is constructed (Kelner, 1953), and leads to marked aberrations in cellular morphology. The extent to which mutagenic agents may injure cytoplasmic as well as nuclear function is not clear, but may be appreciable.

In practice, experiments designed to determine the phenotypic lag of induced mutations, involving many different types of character, have given most conflicting results. In general, the delay has been found greatly to exceed that required for segregation of the mutant nucleus or for the cytoplasmic manifestation of its genotype (Demerec, 1946; Ryan, 1954). In some systems, on the other hand, a delay of less than one generation has been suggested (Ryan, 1955). The work of Witkin (1956) indicates the importance of nutritional and other factors in the environment, during the first third of the first generation time following irradiation, in deciding whether or not the mutational change will stabilize and become expressed.

We are thus faced with the difficulty that the nature of mutation precludes the direct experimental study of its kinetics unless the mutations are artificially induced, while the inducing agents themselves influence the course of events in such a way as to render the results of such experiments to a considerable extent invalid. It is clear that the action of mutagenic agents, as well as the nature of the interaction of mutant genes with the metabolic processes they determine, can only properly be evaluated against a background of knowledge of the kinetics of segregation and phenotypic

expression in uncomplicated systems which can be reasonably well synchronized. The only available systems of this kind are the parasexual ones in which genes can be transferred from one bacterial cell to another of different genotype, and in which the subsequent behaviour of the resulting recombinant chromosome can be studied.

There are three such systems, which differ from one another mainly in the method whereby the genetic transfer is effected. In each, a part of the chromosome of a donor cell can be transferred to a recipient cell and then incorporated into the recipient chromosome to form a recombinant chromosome. In transformation, already described by Dr. Hotchkiss (this symposium, p. 183) the agent of transfer is DNA extracted from the donor population. In transduction (Zinder and Lederberg, 1952; Zinder, 1953), bacteriophage (i.e. virus) particles of low virulence, derived from the donor population, act as vectors of small fragments of the donor chromosome to those recipient cells which they infect. The frequency with which any particular gene is inherited by the recipient population in transduction is usually low (ca. 10^{-6}).

The third system, conjugation (Lederberg and Tatum, 1946; Lederberg *et al.*, 1951; Hayes, 1953; Wollman, Jacob and Hayes, 1956), which is found in *Escherichia coli*, differs from transformation and transduction in three respects:

(1) Genetic transfer from donor to recipient cell is effected directly, by cellular fusion.

(2) A large part of the donor chromosome, comprising many linked genes, is usually transferred to the recipient cells and may appear in recombinants.

(3) When a special type of donor strain called Hfr (for high frequency of recombination) (Cavalli, 1950; Hayes, 1953; Wollman, Jacob and Hayes, 1956) is employed, the frequency with which certain recombinant types appear may be as high as 10–20 per cent of the recipient population (Hayes, 1957).

The work described here has involved a donor Hfr strain isolated by the present author which, under the experimental conditions employed, transfers a specific part of its chromo-

some to recipient cells with high frequency, to form partial zygotes. The transferred fraction of donor chromosome carries on it, in the order of their arrangement, genes determining the synthesis of the amino acids threonine and leucine (T, L), resistance to valine (Val), resistance to sodium azide (Az), resistance to the virulent bacteriophage T1 and the ability to ferment lactose (Lac); the recipient cell differs from the donor in all these characters. The zygotes formed when cultures of the donor and recipient strains are mixed together in broth can be represented thus:

Donor	T	L	Val	Az	T1	Lac
Recipient	+	+	r	r	r	+
	—	—	s	s	s	—

When such zygotes are plated on synthetic minimal agar devoid of threonine and leucine, only those recombinants can grow which have inherited from the donor chromosomal contribution the two linked genes which control synthesis of these amino acids; i.e. selection is made for the gene T+L+ from the donor parent. The other genes on the transferred segment of donor chromosome are not selected and will be inherited among T+L+ recombinants with a frequency proportional to their distance from the selective markers T+L+. In other words, the closer an unselected donor gene is situated to the selected genes T+L+, whose inheritance is obligatory, the less the probability that it will be separated from these genes by the occurrence of a cross-over between them and the greater the probability that it will be included in recombinants.

The donor genes controlling resistance to valine, sodium azide and phage T1 are all closely linked to the selective genes T+L+ and are inherited by about 100 per cent, 90 per cent and 75 per cent of T+L+ recombinants, respectively. For this reason, and because they are concerned with very different aspects of cellular function, these markers are well

suiting to the study of phenotypic expression. Moreover, in control experiments, exposure of sensitive recipient cells in which the zygotes are formed to any one of these drugs prevents further cell division. The assumption can therefore be made that a resistance gene present in such a phenotypically sensitive cell is unlikely to be able to express itself after the appropriate drug has been applied.

The technique used is as follows (Hayes, 1957): Young broth cultures of donor and recipient cells are mixed and kept at 37° for 30 minutes to allow zygotes to form. The donor cells have then fulfilled their fertilizing function and are killed by adding to the mixture a high multiplicity of the virulent phage, T6, to which the donor parent is sensitive but the recipient cells, and the zygotes resulting from their fertilization, are resistant. In this way, further mating is prevented and we are left with what is termed a "zygote suspension". To assess the kinetics of segregation and expression on synthetic minimal agar, two identical series of plates, warmed to 37°, are inoculated with diluted zygote suspension so as to yield, after incubation, about 20-30 recombinant colonies per plate, each colony being composed of the progeny of a T+L+ recombinant segregant issuing from a single zygote. At intervals after inoculation and incubation, the surfaces of one series of plates are vigorously rubbed, in turn, with distilled water by means of a glass spreader. This has the effect of separating the progeny of any T+L+ recombinants that may have already divided at the time of rubbing so that the subsequent colony count is doubled for each generation. Prior to division, of course, the colony count remains constant since the effect of rubbing is simply to alter the position of the zygotes or segregants on the plates. At the same time as plates of the first series are rubbed with distilled water, plates of the second series are similarly rubbed with an appropriate concentration of valine or sodium azide, or with a washed, high titre suspension of phage T1. Since these agents prevent any further division of sensitive organisms, only those cells, whether zygotes or T+L+ recombinant segregants,

which have inherited the gene controlling resistance, and in which the character of resistance has become expressed, can produce colonies. When the proportion of recombinant colonies arising in the presence of the drugs becomes equal to the proportion of control recombinants which have inherited and expressed the gene for resistance, expression is regarded as complete.

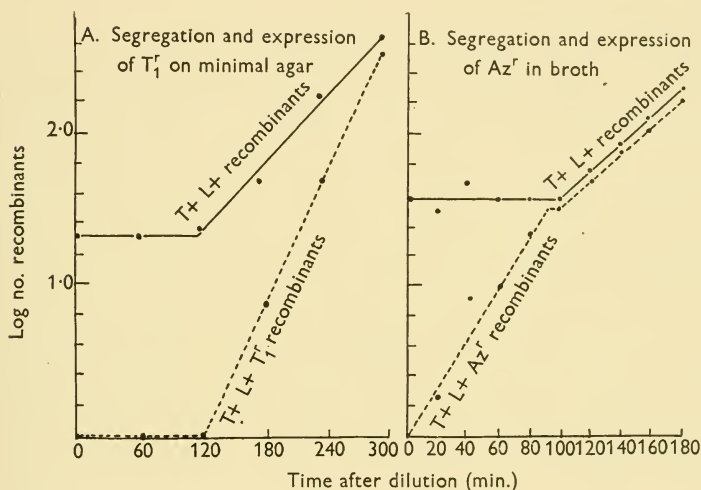

FIG. 1. The kinetics of segregation and phenotypic expression.
 $\times = \text{HfrH.M-Az}^r\text{T}_1^r\text{T}_6^s \times \text{F- .TLB}_1\text{-Az}^s\text{T}_1^s\text{T}_6^r.$

To study the kinetics of segregation and expression in nutrient broth, the zygote suspension is simply diluted 1 : 50 into fresh broth at the desired temperature. Samples are removed as a function of time, appropriately diluted and plated to synthetic minimal agar as well as to the same medium containing a suitable concentration of the drug. Results of two typical experiments are shown in Fig. 1.

The continuous lines represent the kinetics of segregation, and the interrupted lines the kinetics of phenotypic expression. With regard to segregation, it will be seen that on synthetic minimal agar recombinants start to divide about

120 minutes after plating and thereafter multiply with a generation time of about 60 minutes (Fig. 1 A). In nutrient broth at 37° (Fig. 1 B), the first division of recombinant segregants is initiated at 100 minutes after diluting the zygote suspension into fresh broth, and the generation time is 20 minutes.

When the kinetics of phenotypic expression of either sodium azide or phage T1 resistance are plotted in terms of the generation time of the recombinants, closely similar results are obtained on synthetic minimal agar, nutrient agar and in nutrient broth. The patterns of expression of these two characters, however, are very different. Expression of the character Az^r (Fig. 1 B) begins at the time of dilution, or of plating, of the zygotes and then rises exponentially to become complete just before the recombinants which inherit it start to divide. There is good evidence that during the greater part of this period, at least, the genes Az^r from the donor and Az^s from the recipient parent must be present together in the partially diploid zygote. In fact, it is likely that the early stages of expression occur before the process of recombination proper begins (Wollman, Jacob and Hayes, 1956). From this it follows that the gene Az^r is dominant to Az^s .

In contrast, resistance to phage T1 does not begin to be expressed until after segregation, while full expression is delayed until the fourth recombinant generation (Fig. 1 A). This is in conformity with the finding of Lederberg (1949) that phage T1 resistance is recessive to sensitivity in *Esch. coli* diploids. The duration of the phenotypic lag also accords well with that estimated by indirect methods by Newcombe (1948) for the expression of phage resistance in spontaneous mutants. The coincidence of the commencement of expression of this character with initiation of the first segregant division strongly suggests that at this time the recombinant cells make their first appearance as independent units.

The exponential nature of the rise in phenotypic expression of both characters is reminiscent of Dr. Pollock's curves for

induced enzyme formation (this symposium, p. 78) and probably reflects the fact that both are the end-result of enzyme synthesis.

The curve of expression of valine resistance closely follows that of segregation, so that the gene determining this character is dominant and, like the selected genes T+L+, is fully expressed very shortly after entry into the recipient cells.

REFERENCES

- CAVALLI, L. L. (1950). *Boll. Ist. sieroter. Milano*, **29**, 1.
DEMEREK, M. (1946). *Proc. nat. Acad. Sci., Wash.*, **32**, 36.
HAYES, W. (1953). *Cold Spr. Harb. Symp. quant. Biol.*, **18**, 75.
HAYES, W. (1957). *J. gen. Microbiol.*, **16**, 97.
KELNER, A. (1953). *J. Bact.*, **65**, 252.
LEDERBERG, J. (1949). *Proc. nat. Acad. Sci., Wash.*, **35**, 178.
LEDERBERG, J., LEDERBERG, E. M., ZINDER, N. D., and LIVELY, E. R. (1951). *Cold Spr. Harb. Symp. quant. Biol.*, **16**, 413.
LEDERBERG, J., and TATUM, E. L. (1946). *Cold Spr. Harb. Symp. quant. Biol.*, **11**, 113.
NEWCOMBE, H. B. (1948). *Genetics*, **33**, 447.
RYAN, F. J. (1954). *Proc. nat. Acad. Sci., Wash.*, **40**, 178.
RYAN, F. J. (1955). *Amer. Nat.*, **89**, 159.
WITKIN, E. M. (1956). *Cold Spr. Harb. Symp. quant. Biol.*, **21**, 123.
WOLLMAN, E., JACOB, F., and HAYES, W. (1956). *Cold Spr. Harb. Symp. quant. Biol.*, **21**, 141.
ZINDER, N. D. (1953). *Cold Spr. Harb. Symp. quant. Biol.*, **18**, 261.
ZINDER, N. D., and LEDERBERG, J. (1952). *J. Bact.*, **64**, 679.

DISCUSSION

Lederberg: There is one assumption that has to be considered further in this type of analysis, and that is whether the fact that the inhibitor prevents a cell from undergoing a further division likewise prevents it from completing that process of phenotypic development which can lead to the resistant phenotype. In other words, I very strongly suspect that a cell which has both an azide-resistant and an azide-sensitive gene may still be at least partly sensitive to azide in terms of division, but nevertheless be capable of completing those particular synthetic processes which are required for the development of azide resistance. In our tests on the dominance of azide resistance in diploid, we ran into some trouble because the markers could not be scored on synthetic medium and had to be scored only on a complete medium. My impression was that there was an intermediate degree of sensitivity.

Hayes: I have been worried about this very point regarding the azide.

I am, however, quite happy about the phage T1, which rapidly kills sensitive cells.

Lederberg: An analogous example may be seen in that if you take diploids which are heterozygous for streptomycin resistance and sensitivity, these can be prevented from measurable growth by about 5 units of streptomycin. Nevertheless, if those cells are plated in medium containing that level of streptomycin, there is an appreciable yield of segregants, which are streptomycin-resistant, and can grow out, which suggests that they can escape into this new genotype, so to speak. What I am not certain of here is how precisely that multiplication is inhibited.

Hayes: The only way to work with sodium azide in this kind of experiment was to make the assumption that a dose which inhibited division of the sensitive parent also prevented further development of the heterozygote. I quite agree that this assumption may be incorrect. The only check was that on an agar slide, with the drug included, no multiplication of any sensitive cell was observed.

Lederberg: With phage the action is all-or-none, i.e. you have a bactericidal effect of phage if it is absorbed at all.

Pollock: It would be interesting to do this kind of analysis with a mutation which involves loss of the power to form an enzyme. You postulated there being a dilution out of an enzyme after it ceased to be produced. It is quite possible that, following a loss mutation, there might arise an inability to form an enzyme-forming system; which would mean that it would be the enzyme-forming system rather than the enzyme molecule which would be diluted out, and it might take a very long time indeed before cells lost their resistance.

Hayes: The trouble about this kind of experimentation is that you are restricted to certain characters; for instance, you could not estimate the phenotypic expression of sulphonamide resistance under these circumstances because, as Hotchkiss has already pointed out, the cells can still continue to divide after application of the drug. You must have something at the very least which will stop any further division.

Lederberg: Have you some information on the expression of streptomycin resistance?

Hayes: No, but we are going to study this.

Davis: There are some definite advantages in using streptomycin, in that it is the one agent that is bactericidal without any growth of the cell. In addition, the rate of bactericidal action increases practically linearly in proportion to the concentration of the drug.

Hayes: Yes, it is ideal; and there are also Lederberg's results with diploids to serve as comparison. We just have not been able to obtain an Hfr strain yet which will transfer the streptomycin locus to the zygote.

Davis: Are you at all surprised at the speed with which the phenotypic delay is overcome in these cases? For instance, in phage resistance presumably a cell is resistant when it no longer has on its surface any units which the phage can attack. And from electron micrographs a sensitive cell appears to have a great many such units. Yet you find that resistance is phenotypically expressed within a generation or two. This

rapid expression would seem difficult to account for if the units for sensitivity were lost, during growth after the mutation to resistance, simply by dilution.

Hayes: I had visualized a state of affairs in which, after segregation, the genes started functioning, producing the necessary system to manufacture new sites on the cell wall; and that you would have a heterogeneous population of cells at various stages, some of which had a certain proportion of sites, and others a different proportion. It is just a matter of chance; the more sites a particular cell had synthesized at any particular time, the greater the chance that under the experimental conditions it would be able to absorb that phage and be killed.

Cavalli-Sforza: An incidental point is that I do not agree entirely with the genetic map which you showed, Dr. Hayes. I think valine resistance should be between T and L, according to my experience. You said that valine resistance is expressed immediately and more rapidly than azide; do you find any difficulty in scoring for azide resistance in minimal?

Hayes: No, but this is a technical point. I use sodium aspartate in my minimal medium, and if I use $m/1500$ azide there is no difficulty at all in scoring colonies of resistant segregants. This level suppresses the growth of sensitive prototrophs, but allows resistant prototrophs to grow. The colonies are smaller than on minimal agar without azide, but this makes counting rather easier. The colonies come up after overnight incubation at 37° .

Fredericq: When you add your T6 phage to destroy the donor cells, this is at a time when the two cells are sticking together. Do you sometimes observe a transfer of T6 from the donor into the recipient cell?

Hayes: This would be hard to observe directly, but by inference, no. After this treatment one gets exactly the same number of recombinants, within the experimental error, as one gets when the mating pairs are simply separated, diluted and plated out. There is no reduction.

One could assume that if the phage was transmitted, then it would probably multiply and lyse the otherwise resistant cells, and this is not so.

Stocker: With regard to the time needed for expression of streptomycin resistance, one can make an analogous experiment either in DNA transformation or phage transduction. Dr. Hotchkiss and others have described the results in the DNA experiment. In transduction experiments, there is a considerable delay after the phage is added before the cells first become streptomycin-resistant, and there is then a plateau before the number of streptomycin-resistant clones begins to increase. There is also a delay in the case of transduction of motility (where one knows by inference that motility is dominant to absence of motility). But the delay in the first appearance of streptomycin-resistant cells is greater than the delay in the appearance of the first motile cells.

Hayes: Do you know anything about the actual number of generations?

Stocker: In the motility case the delay is of the order of two and a half generation times. I don't recollect the figure for streptomycin.

Hotchkiss: In the DNA transfer of streptomycin resistance, the situation is approximately as follows. There is a delay of about one division

time before any streptomycin-resistant cells can be detected. This could be some kind of recessiveness of resistance, but we feel that the resistance is dominant, because if those newly arising cells are treated with streptomycin you are left with cells that survive streptomycin, but that nevertheless in subsequent generations segregate out sensitive daughters. The rate at which the transformants develop resistance has been shown by Fox in our laboratory to be the summation of a more or less normal time-distribution. The first ones appear one division time after DNA, and the last ones are finished in the course of that next cell-division period.

Barber: Perhaps Dr. Hayes or Prof. Lederberg would comment on the possible applicability of the *Esch. coli* type of recombination for other bacterial species.

Hayes: A system which may have something in common with it has been described in *Pseudomonas* by Holloway in Australia (Holloway, B. W. (1955), *J. gen. Microbiol.*, **13**, 572), but this is in the very early stages of working out. Recombination occurs, of course, as Prof. Lederberg has shown, in many other strains of *Esch. coli*, but I don't know of any other example of this kind of system in other bacterial genera, apart from *Pseudomonas*.

Lederberg: Luria has been able to cross some *Esch. coli* strains with *Shigella*. I don't think that sexual recombination is necessarily very rare in bacteria; it is the investigations of it that are rare.

We have been talking of dominance as if this were an all-or-none affair, and I would ask Dr. Hayes and Dr. Hotchkiss to say what happens if higher concentrations or different concentrations of the antibacterial agent are used? Does one get the same pattern of expression as with the one discussed here?

Hayes: I have not done this with valine, and with azide it is difficult. There is only a rather critical range of concentration of the drug which will stop the growth of sensitive cells and allow the resistant cells to grow.

Hotchkiss: As for the transformation, the transformant is resistant to approximately 2,000 $\mu\text{g.}$ of streptomycin, so we have a wide range to cover. At any one time during the process, there are more cells resistant to say 10 $\mu\text{g.}$ than there are to 100 $\mu\text{g.}$, and more are resistant to 100 $\mu\text{g.}$ than there are to 200 $\mu\text{g.}$, and so on; but if the time-course for any one concentration is obtained, these show very parallel curves and the time displacement of these curves is almost precisely that of the killing rate of the respective concentrations. The higher concentration kills more quickly and therefore it stops any further expression; 200 $\mu\text{g.}$ may allow further expression for perhaps three minutes, 50 $\mu\text{g.}$ may allow further expression for five or six minutes.

Lederberg: So there is some indication from this type of experiment that the levels of streptomycin do allow a progression of the phenotypic development of resistance for a short interval of time.

Hotchkiss: The time is easily reconcilable with the time of the killing period.

Pontecorvo: A minor matter of terminology should be raised here in order to avoid misunderstanding. Prof. Lederberg and I have agreed

on the following terms. One could describe as a "sexual system" any one that involves more or less a total fusion of two genomes; with the subdivisions "eosexual" for unadulterated sexual reproduction, and "parasexual" for cases of less complete orthodoxy. "Transduction", on the other hand, is a system in which only part of the genome from a donor cell goes to a recipient. Under the term "transduction" Prof. Lederberg also includes transformation, but since I have no vested interest either in transformation or in transduction I would not like to go further!

Hayes: In a recent paper in conjunction with Drs. Wollman and Jacob (Wollman, Jacob and Hayes 1956, *loc. cit.*) we have referred to these bacterial systems involving partial zygotes as "merozygotic" systems; but I was very careful to refer to them today as "parasexual" ones, as I thought this would please Dr. Pontecorvo!

Pontecorvo: That is very gratifying, but we have agreed with Prof. Lederberg that it is not legitimate to call them "parasexual".

SPECIFIC POLYHYDROXY COMPOUNDS AS COFACTORS OF ENZYMIC ADAPTATION AND ITS INHERITANCE

P. P. SLONIMSKI and H. DE ROBICHON-SZULMAJSTER

Laboratoire de Génétique Physiologique du CNRS, Gif-sur-Yvette

It is a part of the definition of the word "truism", and not the least important one, that it is accepted as something self-evident. A truism probably as old as genetics is the one exemplified by the following quotation from a well known textbook: "The most important property of a gene is that it reproduces itself, that is, forms a copy of itself from material present in the cell. Furthermore, genes may form and give off substances which influence specific reactions, first within the cell and subsequently elsewhere in the organism. These two properties or functions of genes, that of autocatalysis and of heterocatalysis, may prove to be two aspects of the same process: the specific gene products given off in the cell may be merely byproducts of the reactions of gene synthesis" (Sinnott, Dunn and Dobzhansky, 1950). This statement applies not only to genes but to all types of genetic material whether nuclear or cytoplasmic. According to the authors' preferences, the autocatalytic function is referred to as autoreproduction, self-duplication, copying, covariant replication or transmission of information, most probably from nucleic acid to nucleic acid, while the heterocatalytic function is generally described as control, determinism or information transfer from nucleic acid to proteins and enzymes in particular. A purely formal scheme can represent these two functions:

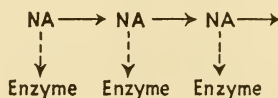

The purpose of the present paper is to introduce a third member into this scheme. This member will be referred to as "cofactor" and the two arrows added to the scheme symbolize that it is specifically involved in the autocatalysis *and* in the heterocatalysis of a special type of the genetic material.

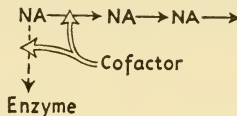

At the present time the evidence concerning autocatalysis is based on the study of the non-Mendelian genetic material responsible for cytochrome oxidase synthesis in yeast. The evidence concerning heterocatalysis is based on the study of the oxygen-induced synthesis of the cytochrome system and of the induced synthesis of maltozymase in yeast. Whether cofactors play any rôle at the genic level in yeast or any rôle in other organisms remains open for investigation.

The discovery of cofactors is due to a systematic study of conditions that are required for the induced synthesis of cytochrome oxidase in yeast and to a fortuitous observation. Although rather of historical interest, it may be of some use to report it briefly. One of the present authors (Slonimski) has been working for the past seven years on the mechanism of the synthesis of cytochrome systems, and was faced quite early by the fact that cells harvested at a certain phase of growth cycle were unable to adapt under the usual conditions. This observation is quite common to students of induced biosynthesis of enzymes. A perusal of the literature shows numerous examples of decreased adaptability according to the "physiological state" of the cells (Gale, 1951; Pinsky and Stokes, 1952). There is no general rule and depending on the organism, enzyme, and medium employed the modifications occur during lag, exponential or stationary phase of growth. Undoubtedly there may be numerous causes, but in general they have not been properly investigated, the authors being satisfied with a plausible and *ad hoc* explanation. This author

has committed himself to one of those, in an effort to explain the poor adaptability to oxygen of exponential anaerobic yeast by a deficiency in the free amino-acid pool (Slonimski, 1956). Subsequent experiments have shown that this explanation was wrong. Anaerobic incubation in glucose-containing buffer may be sufficient to restore adaptability. We started naïvely to investigate the effect of some carbohydrates and

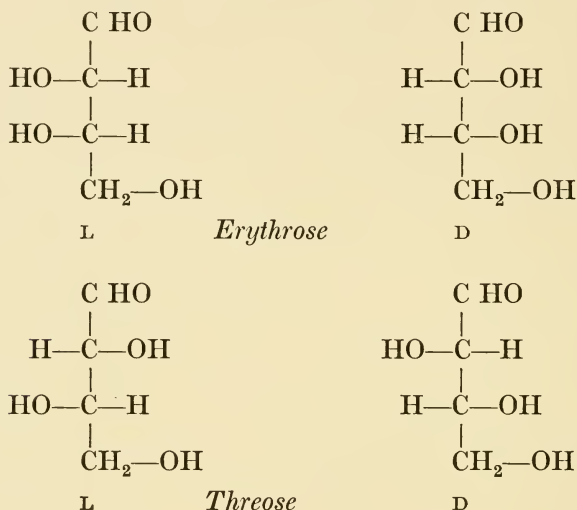

FIG. 1. C₄ Sugars.

their derivatives and found a batch of deoxyribose that had a very strong stimulatory effect on adaptation.

We have eliminated the 2-deoxy-D-ribose which is without effect, and tracing impurity after impurity we have arrived at C₄ sugars : tetroses. Four members of this class are known (Fig. 1). Three of them are found to be inactive; the fourth, D-threose, has not yet been investigated. However, it is possible to synthesize from pure tetroses by a relatively mild chemical treatment certain compounds that have novel biological activity. We shall call them cofactors, those deriving from erythrose will be designated by *E* and those

derived from threose by *T*. The treatment consists in heating an acidified aqueous solution of the pure sugar, and the chemical structure of these derivatives is actually being investigated by Dr. Asselineau and Prof. Lederer. Furthermore, certain batches of commercial preparations of tetroses are contaminated by substances that have biological properties analogous to those obtained by synthesis from pure C_4 sugars.

To verify the hypothesis that tetrose derivatives are involved in the two functions of the genetic material, the autocatalytic and the heterocatalytic one, we have studied their action in four biological systems listed in Table I. Every system has its own particular advantages and drawbacks, and can provide adequate answers only to a certain type of question. A general conclusion can be drawn if a reasonably coherent picture is obtained by comparing results of the ensemble. The principal information we can gain from the first system is whether the cofactors may be involved in the transmission, from the mother cell to the daughter cell, of the genetic material responsible for cytochrome oxidase synthesis; to be more precise, whether they interfere with the interruption, brought about by euflavine, of the normal transmission process. Analogous information can be obtained from the study of the fourth system, with the advantage that the mutation occurs spontaneously. This last system has a considerable drawback, however, because of a possible effect on the selection of mutants which precludes any rigorous interpretation as to the mutation process. The study of mutation by these two methods is relevant to autocatalysis but gives us no information in respect to heterocatalysis. Data on this point are given by the study of the second and third systems, where enzyme synthesis takes place against a constant genetic background. Furthermore, comparison of the first with the second system enables us to study the *two* functions of the *same* genetic material, while comparison of the second with the third permits us to follow the heterocatalytic functions of *two* different genetic materials.

Table I
TEST SYSTEMS EMPLOYED FOR THE STUDY OF COFACTORS

<i>Biological system</i>	<i>Conditions</i>			<i>Type of change</i>	<i>Associated phenotype</i>
	<i>Strain</i>	<i>Growth</i>	<i>Selection of mutants</i>		
"Petite" mutation (induced by ouflavine)	YF, 59R	yes	excluded	genetic material	respiration
Cytochrome oxidase adaptation (induced by O ₂)	YF, 59R	no	excluded	enzyme synthesis	respiration
Maltozymase adaptation	YF	no	excluded	enzyme synthesis (?)	fermentation
"Petite" mutation (spontaneous)	C982/19b	yes	(?)	genetic material	respiration

Induced "petite" mutation

Ephrussi and his collaborators have shown that clones of normal yeast during their growth constantly give rise to respiration-deficient mutants ("vegetative mutants" or "vegetative petites") stable in vegetative reproduction. The respiratory deficiency was shown to be due to lack of several enzymes (including cytochrome oxidase) firmly bound, in normal yeast, to particles which can be sedimented by centrifugation and to behave as a non-Mendelian character in crosses between normal and mutant yeast. Addition of euflavine (2 : 8-diamino-*N*-methylacridine) in sufficient concentration induces mutation in almost every newly formed bud, i.e. the mutation rate is close to 1. It was suggested that the mutation consists of a loss, or irreversible functional inactivation, of a particulate cytoplasmic autoreproducing factor, and the question of the possible identity of this genetic material with subcellular units, defined by various biochemical and cytological criteria, was discussed. Vegetative mutants do contain mitochondria that are morphologically similar to those of normal yeast in spite of the fact that they do not contain cytochrome oxidase. References to the various aspects of this work will be found in Ephrussi (1953), Slonimski (1953*a* and *b*) and Ephrussi, Slonimski and Yotsuyanagi (1955).

Our experiments were performed in the following way. To a culture of diploid or haploid yeast exponentially growing in a synthetic, highly buffered medium with excess of glucose, euflavine is added at zero time. After 6-6.5 hours, cells are plated on euflavine-free medium and the number of mutant clones scored. It can be seen from Table II that the difference in growth of the induced and the control culture is so small that the frequency of mutants directly reflects the mutation rate and selection is excluded. Furthermore, for approximately the first half of a cellular generation no mutants appear in the population. The average mutation rate calculated over the period of 2.5 generations being 0.73, the actual mutation rate is close to 1 for the last two cell generations.

Table II

COMPARISON OF GROWTH AND MUTATION OF CONTROL AND INDUCED CULTURES

	No independent cultures	No colonies counted	Frequency of mutants (%)	No cell generations	Mutation rate* ($\times 10^{-3}$)	
					minimum	maximum
Control	38	ca. 16000	1.2	2.72	1	2
+ Euflavine 1 to 2×10^{-6} M	68	ca. 30000	67.8	2.52	720	740

Data from 12 independent experiments pooled together.

* The mutation rate is defined here as the probability of a bud taken at random giving rise to a mutant clone (cf. Marcovich, 1951).

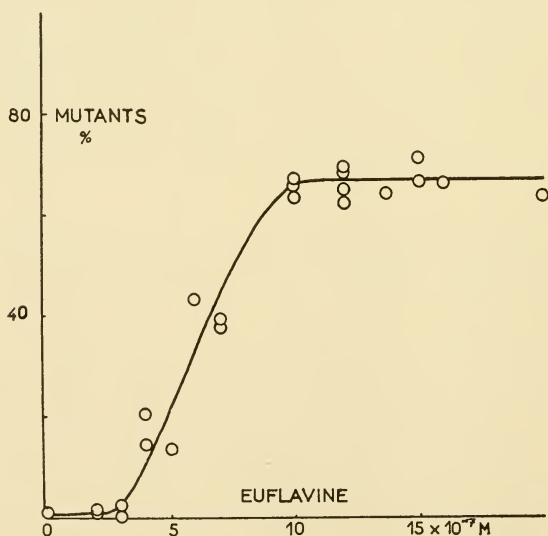

FIG. 2. Frequency of respiration-deficient mutants versus euflavine concentration.

Other conditions as in Table III.

Fig. 2 gives the frequency of mutants as a function of euflavine concentration. It is interesting to find that the relation is not linear. The two simplest explanations of this result are either that two or more molecules of euflavine are necessary to produce a mutational event, or that we are dealing here with a threshold phenomenon. This last interpretation means that a concentration of euflavine up to $3 \times 10^{-7}M$ is rendered ineffective, or neutralized by the cells.

Table III

COMPETITION BETWEEN EUFLAVINE AND PURINES
IN INDUCTION OF MUTATION

<i>Addition</i>	<i>Mutants</i>	
	<i>Frequency (%)</i>	<i>Suppressed (%)</i>
Control	0.3	—
Euflavine $1.2 \times 10^{-6}M$	66.8	—
" " +A 0.04 + G 0.04	60.3	10
" " +A 0.06 + G 0.06	52.9	21
" " +A 0.08 + G 0.08	12.2	82
" " +A 0.08	53.7	20
" " +A 0.12	15.0	77
" " + G 0.08	60.9	9
" $2.4 \times 10^{-6}M$	71.2	—
" " +A 0.12 + G 0.12	61.3	14
" " +A 0.16 + G 0.16	41.7	42

Expt. G 12. Concentration of adenine and guanine in mg./ml.

Addition of a mixture of nucleic acid constituents suppresses the mutagenic action of the dye. Their antimutagenic action is competitive and may be complete. By studying the suppressive effect of individual nucleic acid bases, either singly or in various combinations, it was found that adenine is by far the most effective; guanine and thymine are about three times less active than adenine. Uracil, cytosine, ribose and deoxyribose are ineffective (Table III).

We can turn now to the cofactors. Their addition considerably changes the action of euflavine. Addition of *E* acts like that of adenine, i.e. suppresses the occurrence of mutation (Table IV). On the contrary, the addition of *T*, which derives

Table IV
ANTIMUTAGENIC ACTION OF COFACTOR *E*

<i>Expt.</i>	<i>Addition</i>	<i>Mutants</i>	
		<i>Fre- quency (%)</i>	<i>Sup- pressed (%)</i>
G 17	Control	0·2	—
	Euflavine $0·6 \times 10^{-6}M$	43·8	—
	„ „ + Cofactor <i>E</i> (c-1)	23·8	46
	„ $1·5 \times 10^{-6}M$	73·9	—
	„ „ + Cofactor <i>E</i> (c-1)	64·1	13
G 19	Control	1·1	—
	Euflavine $1·0 \times 10^{-6}M$	76·8	—
	„ „ + Cofactor <i>E</i> (c-1)	14·3	82
	„ „ + Adenine	35·5	55
	„ „ „ + Cofactor <i>E</i> (c-1)	1·3	100
G 27	Control	0·7	—
	Euflavine $1·0 \times 10^{-6}M$	63·1	—
	„ „ + Cofactor <i>E</i> (c-2)	41·1	35
	„ „ „ (j-2)	25·8	59
	„ „ „ (j-4)	12·6	80

Conditions: Adenine 0·15 mg./ml.

Source of cofactor: commercial erythrose batch c-1 : 1 mg./ml.;
batch c-2 : 1 mg./ml.

synthetic derivative of pure D-erythrose
(preparations j-2 and j-4 : equiv. 1 mg./ml.)

from the threo isomer of tetrose instead of the erythro one, potentiates the action of euflavine. In other words, it acts against adenine (Table V). Cofactor *T* by itself does not produce mutation.

Table V
PROMUTAGENIC ACTION OF COFACTOR T

Expt.	Addition	Mutants	
		Fre- quency (%)	Stimul- ation (%)
G 17	Control	0.2	—
	Euflavine $0.6 \times 10^{-6}M$	43.8	—
	“ “ +Cofactor T	50.0	14
	“ $1.5 \times 10^{-6}M$	73.9	—
	“ “ +Adenine	58.1	—
“ “ “ +Cofactor T	69.1	19	
G 19	Control	1.1	—
	Euflavine $1.0 \times 10^{-6}M$	76.8	—
	“ “ +Adenine	35.5	—
	“ “ “ +Cofactor T	61.0	72

Conditions: Adenine: 0.15 mg./ml.

Source of cofactor: commercial threose 1 mg./ml.

Table VI gives a list of substances assayed to verify whether the effect of *E* can be duplicated with something else. All were found inactive. For the sake of comparison two results obtained with synthetic derivatives of pure D-erythrose are included. The actual amount of the derivative is unknown and is probably much smaller than the quantity of the sugar of origin.

Euflavine is a very reactive dye that forms readily additive complexes with a great number of substances (nucleic acids, proteins, deoxyribonucleotides etc.; cf. Peacocke and Skerrett, 1955).

Is it not possible that the interaction of purines and cofactors with euflavine is a chemical combination occurring *in vitro* outside the cells, and bearing no relation to the cellular receptors? This question can be answered in a negative way, for the following reasons:

(a) The complex formation *in vitro* could easily explain the action of *E* but only with difficulty the action of *T*.

Table VI

SUBSTANCES FOUND *inactive* AS ANTIMUTAGENS
 ("Petite" induction by 1 to 1.5×10^{-6} M Euflavine)

<i>Substance</i>	<i>Concentration</i> (mg./ml.)	<i>Mutants</i> <i>suppressed</i> (%)
D-Glucose	1 to 10	0
D-Ribose	1	1
2-Deoxy-D-ribose	0.5 to 1	0
L-Arabinose	1	0
D-Xylose	0.5 to 1	3
D-Sedoheptulose	1	8
D-Ribulose	1	7
L-Erythrulose	1	0
DL-Glyceraldehyde	1	5
D-Erythrose	0.5 to 1	0
L-Erythritol	2	2
Glycerol	2	1
L-Threose	1	3
Gluconic acid lactone	1	3
DL-Glyceric acid	1	0
Reductone	1	4
Furfural	0.1	4
Kinetine	0.1	3

For Comparison

D-Erythrose derivative		
No. J-5	equiv. 1	63
No. H-2	1.5	98

(b) The amount of euflavine fixed by the cells in the presence or in the absence of adenine is practically the same. It can be measured spectrophotometrically after extraction by HCl-ethanol. To explain the suppression of mutation the amount fixed should have been more than halved.

(c) The euflavine spectrum does not change upon addition of adenine, while a definite change is observed upon addition of adenine deoxyribonucleotide or nucleic acid (Peacocke and Skerrett, 1955).

(*d*) The results obtained in the presence of euflavine are very similar to those obtained in the absence of the dye.

It is concluded that adenine and *E* favour the transmission of the genetic material responsible for cytochrome oxidase synthesis, while *T* acts in the opposite way.

Cytochrome oxidase adaptation

Cytochrome oxidase synthesis is the heterocatalytic function of the genetic material sensitive to euflavine. This synthesis can be easily studied in yeast that has been first grown anaerobically, then washed, suspended in glucose-containing buffer and aerated. In the absence of molecular oxygen there is no formation of respiratory enzymes but the genetic material remains unchanged even after hundreds of cellular generations. In such an anaerobically grown yeast, oxygen induces the formation of the whole chain of haemoproteinic enzymes (including cytochrome oxidase) with consequent re-establishment of respiration. The synthesis of these enzymes takes place in the absence of an external nitrogen source and in the absence of cellular multiplication. The references concerning various aspects of this phenomenon can be found in Ephrussi and Slonimski (1950), Slonimski (1953*a* and *b*; 1956).

When yeast is harvested during certain phases of anaerobic growth and exposed to oxygen in glucose-containing buffer, its cytochrome oxidase adaptation is very sluggish. Addition of small amounts of *E* at the beginning of adaptation stimulates considerably the rate of enzyme synthesis. Addition of *T* produces the opposite effect, inhibiting adaptation (Fig. 3 and Table IX).

In such sluggishly adaptable cells the addition of a mixture of all nucleic acid bases produces a certain stimulation of adaptation. There are two important features of this phenomenon: firstly, that *E* acts synergistically with the nucleic acid bases; secondly, only a complete mixture of bases is stimulatory. Certain incomplete mixtures, on the contrary, are inhibitory (Table VII). The synergistic action of *E* and

individual purine and pyrimidine bases is even more striking (Table VIII). Here again we find the same situation as in the mutation study: adenine is the most effective of all the bases studied and thymine is slightly more effective than uracil. Adenine and cofactor *E* act synergistically while cofactor *T* is inhibitory. Substances assayed for stimulation and found

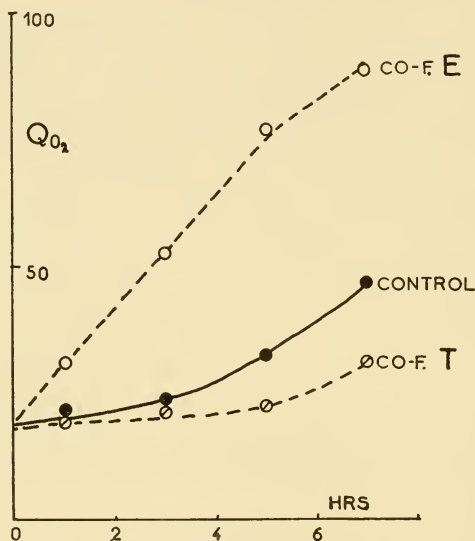

FIG. 3. Effect of commercial erythrose (0.5 mg./ml.) or threose (1 mg./ml.) on respiratory adaptation.

Adaptation in aerated phosphate buffer containing 15 mg. glucose/ml.

inactive are the following: D-glucose, D-ribose, 2-deoxy-D-ribose, D-arabinose, L-arabinose, D-xylose, L-fucose, L-rhamnose, D-erythrose, L-erythrose, L-erythritol, L-threose formate, glycerol, ethanol, gluconic acid lactone, i-tartaric acid, furfural, furfuryl alcohol, meso-inositol, ergosterol, tween 80, yeast extract (Difco), casein hydrolysate (enzymic), vitamin B₁₂, folic acid, haemin, haematoporphyrin, mixture of trace elements.

Table VII
 SYNERGISTIC ACTION OF COFACTORS AND NUCLEIC ACID CONSTITUENTS IN CYTOCHROME OXIDASE ADAPTATION

Addition	Expt. A 197			Expt. A 220-a		
	Adaptation	Increase in enzyme		Adaptation	Increase in enzyme	
		by cofactor	by bases		by cofactor	by bases
None	23.1	—	—	51.7	—	—
Cofactor E	32.5	9.4	—	59.8	8.1	—
A.G.C.U.T.	30.7	—	7.6	59.9	—	8.2
Cofactor E + A.G.C.U.T.	43.0	12.3	10.5	80.1	20.2	20.3
A.G.CR.UR.	14.2	—	0 (-8.9)			
Cofactor E + A.G.CR.UR.	27.5	13.3	0 (-5.0)			
Cofactor T				30.7	0 (-21.0)	—
Cofactor T + A.G.C.U.T.				36.6	0 (-23.3)	5.9

Conditions: Phos. Pht. Succ. buffer : 0.2M pH 4.5
 Glucose: 15 mg./ml.

Bases: ca. 5×10^{-4} M: A: adenine; G: guanine; C: cytosine, U: uracil; T: thymine; CR: cytidine; UR: uridine.

Source of cofactors: commercial tetroses 0.5 mg./ml.

Adaptation during 7 hrs.

Table VIII
 SYNERGISTIC ACTION OF COFACTORS AND
 INDIVIDUAL BASES IN CYTOCHROME OXIDASE ADAPTATION

<i>Addition</i>	<i>Adaptation</i>	<i>Increase in Enzyme</i>	
		<i>by cofactor</i>	<i>by base</i>
None	67.4	—	—
Cofactor <i>E</i>	74.4	7.0	—
A	65.6	—	0 (-1.8)
C	63.5	—	0 (-3.9)
T	62.3	—	0 (-5.1)
U	64.5	—	0 (-2.9)
Cofactor <i>E</i> +A	91.7	26.1	17.3
" C	77.4	13.9	3.0
" T	76.1	13.8	1.7
" U	74.2	9.7	0 (-0.2)

Average of two experiments (A 222 *a* and A 224 *a*).

Conditions: Phos. Pht. Succ. buffer : 0.2M pH 4.5.

Glucose : 15 mg./ml.

Bases: ca. 8×10^{-4} M; A: adenine; C: cytosine; T: thymine;

U: uracil.

Source of cofactors: commercial erythrose 0.25 mg./ml.

Adaptation during 7 hrs.

Table IX
 ACTION OF DERIVATIVES OF D-ERYTHROSE IN
 PROMOTING CYTOCHROME OXIDASE ADAPTATION

<i>Addition</i>	<i>Adaptation</i>	<i>Stimu- lation (%)</i>
Control	71	—
	75	
D-Erythrose pure 0.25 mg./ml.	74	3
" 0.50 "	76	
" derivative No. H-1 equiv. 0.13 mg./ml.	90	23
" " " " 0.25 "	90	
" " H-2 " 0.25 "	101	37
" " " " 0.50 "	99	
" commercial 0.25 mg./ml.	101	39
" " 0.50 "	102	

Expt. A 230, conditions: Phos. Pht. Succ. buffer : 0.2M pH 4.5

Glucose : 15 mg./ml.

Adaptation during 6 hrs.

Maltozymase adaptation

It is well known that glucose-grown yeast does not immediately ferment certain disaccharides, e.g. maltose. It has been shown by a number of workers (cf. Spiegelman, 1950; Spiegelman and Halvorson, 1953), that fermentation can be induced in the absence of a nitrogen source in cells suspended in a buffer solution of the inducer. This phenomenon is referred to as "maltozymase" adaptation.

The nature of the enzymes, of the inducer and of the genetic material involved in this system is very different from that of the cytochrome oxidase system.

The first questions to be asked are:

- (a) Do tetrose derivatives affect maltozymase formation?
- (b) If so, are they identical with cofactors involved in cytochrome oxidase synthesis?
- (c) What is their relation in respect to inducer, energy and building-block requirements and to maltozymase function?

Our attempts were directed principally to providing adequate answers to the first two questions, which are the basic ones. Before presenting experimental evidence, it is however necessary to consider a special feature of yeast growth that may, at first, seem irrelevant.

Maltozymase induction is carried out as follows. Yeast is grown on glucose, harvested, washed, suspended in a buffer solution of maltose and the rate of aerobic fermentation measured. Now, growth of yeast on glucose is a biphasic phenomenon. In the first phase glucose, even under maximum aeration, is mostly fermented to ethanol (Swanson and Clifton, 1948; Lemoigne, Aubert and Millet, 1954). In the second phase (and if oxygen is present) the accumulated alcohol is oxidized. The inefficiency of respiration during the glucose phase is the result of inhibition of synthesis of the cytochrome system by aerobic fermentation brought about by high glucose concentration (counter Pasteur-effect; Slonimski, 1956). A detailed study of the growth cycle has shown profound modifications not only in the enzymic constitution but also in the

structure of the chondriome and of the perinuclear zone (Ephrussi *et al.*, 1956).

If yeast is taken from the glucose fermentation phase it will rapidly adapt to maltose. If it is taken from the ethanol phase no maltozymase is formed.

In such cells an addition of *E* produces a dramatic effect, restoring completely the maltozymase adaptation (Fig. 4). Cofactor *E* does not act as a cofactor of maltozymase function, as is shown by the following experiments.

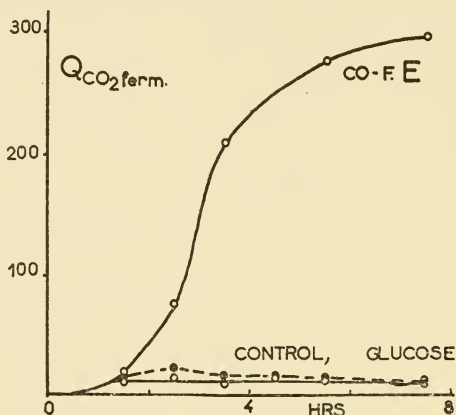

FIG. 4. Effect of commercial erythrose (0.5 mg./ml.) or glucose (0.5 mg./ml.) on maltozymase adaptation.

Adaptation in aerated phos. pht. succ. buffer containing 10 mg. maltose /ml.

Firstly, addition of *E* does not provoke an immediate fermentation of maltose but only permits adaptation to occur. Depending on the amount of *E* added at zero time, adaptation takes place more or less rapidly, but even with saturating concentrations of *E* the half-maximal rate of fermentation of maltose is attained only after ca. 3 hours. Secondly, addition of *E* six hours after the addition of maltose in excess does not bring about an immediate fermentation. This last experiment is of critical importance. If cofactor *E* were involved in permitting the expression of the maltozymase function, its

addition should have provoked an immediate fermentation. As this is not the case, it seems most probable that it is involved in the formation of maltozymase. Moreover, addition of *E* or *T* is without effect on the fermentation of maltose by fully adapted yeast.

The addition of *E* is quite sufficient to transform non-adaptable cells into normal ones, as judged by the rate and extent of adaptation. Furthermore, *E* does not stimulate adaptation of cells harvested during the glucose fermentation growth phase. Therefore, it seems difficult to avoid the conclusion that the cells from the two phases of glucose growth cycle differ by the presence or absence of cofactor *E* or some substance derived metabolically from *E*.

Cofactor *T* added to adaptable cells prevents maltozymase formation. We are faced, therefore, with a situation completely parallel to the cytochrome oxidase one. However, preliminary experiments indicate that erythrose derivatives active in the cytochrome oxidase system are different from those involved in maltozymase adaptation.

A certain number of substances have been tested with respect to their ability to replace cofactor *E* and found ineffective. They are listed in Table X. To minimize variation from one experiment to the other, a standard amount of cofactor *E* contained in 100 μ g. of a given impure preparation of erythrose was run with every experiment and the results recorded in relation to it. Perusal of Table X shows that:

(a) *E* does not act as an energy source. A great number of compounds listed are actually fermented or respired by yeast while remaining ineffective. Furthermore, *E* is not fermented or respired by yeast, although it is metabolized.

(b) *E* does not act as a source of carbon units derived by means of any known metabolic pathway. Representative members of the glycolytic pathway, of the pentose oxidative cycle and of the tricarboxylic cycle were found inactive.

(c) It is possible that *E* or its natural homologue may be synthesized by the cell from small carbon fragments like

Table X

SUBSTANCES FOUND *inactive* IN PROMOTING
MALTOZYMASE ADAPTATION

<i>Substance</i>	<i>Concentration</i> (mg./ml.)	<i>Stimulation (%)</i>
D-Glucose	0.03 to 0.5	0
D-Fructose	0.1	0
L-Sorbose	0.1	0
(+) <i>αα</i> -Trehalose	0.1	1
D-Ribose	0.5	0
2-Deoxy-D-ribose	0.5	0
L-Arabinose	0.5	0
D-Xylose	0.5	0
D-Sedoheptulose	0.3	1
D-Ribulose	0.2	1
L-Erythrulose	0.2	1
L-Erythrose	0.1 to 0.2	4
D-Erythrose	0.1 to 0.5	0
L-Threose	0.6	5
Araboketose	0.1	2
D-Sorbitol	0.1	7
D-Arabitol	0.1	3
L-Arabitol	0.1	1
L-Adonitol	0.1	0
Meso-inositol	0.1	1
Erythritol	0.5	0
Furfural	0.2	0
Furfuryl alcohol	0.2	6
1 : 2 : 3 : 4-Diepoxybutane	0.4	0
Glycerol	0.4 to 1.0	0 to 25
i-Tartaric acid	0.5 to 1.0	13
Acetic acid	0.02 to 0.2	0 to 27
DL-Lactic acid	0.02 to 0.2	0
L-Malic acid	0.02 to 0.2	15
<i>α</i> -Glycerophosphoric acid	0.1	0
DL-Glyceraldehyde	0.02 to 0.4	0 to 35
Diacetyl	0.1	14
<i>For Comparison</i>		
Erythrose (Commercial)	0.1	100

glyceraldehyde or acetic acid. But these two compounds produce only slight stimulation. Moreover, this stimulation is variable from one experiment to another—in contrast to the

stimulation brought about by cofactor *E* which is very much greater and relatively constant.

Only few experiments were done on the mechanism of action of *E*. It can be metabolized by the cells into an inactive form. This can be demonstrated by adding first the cofactor and delaying the addition of maltose. The stimulation is much smaller than the one produced by simultaneous addition of both compounds. Furthermore, the same experiment clearly shows that the cofactor acts in a different way from the inducer and does not replace it.

Spontaneous "petite" mutation

Ephrussi and Leupold (unpublished) discovered certain yeast strains that present a much higher spontaneous mutability than usual. Preliminary experiments were carried out with one of these (strain C982/19b). The results were rather unexpected. Adenine and cofactor *E* seem to increase the percentage of mutants, while cofactor *T* seems to decrease it. It is interesting to note that, although the rôles are reversed, the coupling of cofactor *E* with adenine is maintained. However, a possible effect on the selection rather than on the mutation frequency has yet not been excluded.

Acknowledgement

The authors gratefully acknowledge the continued interest of Prof. B. Ephrussi and the advice and help of Prof. E. Lederer and Dr. J. Asselineau. Our thanks are due to Prof. Frèrejacque, Drs. B. L. Horecker, A. S. Perlin, N. K. Richtmyer and F. Skoog, who kindly put at our disposal samples of rare sugars or their derivatives.

REFERENCES

- EPHRUSSI B. (1953). Nucleocytoplasmic Relations in Micro-organisms. Oxford University Press.
- EPHRUSSI, B., and SLONIMSKI, P. (1950). *Biochim. biophys. acta*, **6**, 256.
- EPHRUSSI B., SLONIMSKI, P., and YOTSUYANAGI, Y. (1955). *Nature, Lond.*, **176**, 1207.
- EPHRUSSI, B., SLONIMSKI, P., YOTSUYANAGI, Y., and TAVLITZKI, J. (1956). *C. R. Lab. Carlsberg, Sér. physiol.*, **26**, 87.
- GALE, E. F. (1951). Chemical Activities of Bacteria. Cambridge University Press.

- LEMOIGNE, M., AUBERT, J. P., and MILLET, J. (1954). *Ann. Inst. Pasteur*, **87**, 427.
- MARCOVICI, H. (1951). *Ann. Inst. Pasteur*, **81**, 452.
- PEACOCKE, A. R., and SKERRETT, J. N. H. (1955). *III Int. Congr. Biochem.*, Abstracts, p. 21.
- PINSKY, M. J., and STOKES, J. L. (1952). *J. Bact.*, **64**, 337.
- SINNOT, E. W., DUNN, L. C., and DOBZHANSKY, T. (1950). *In Principles of Genetics*, p. 457. New York: McGraw Hill.
- SLONIMSKI, P. (1953*a*). *Formation des Enzymes Respiratoires chez la Levure*. Paris: Masson.
- SLONIMSKI, P. (1953*b*). *In Adaptation in Micro-organisms*, Eds. Davies, R., and Gale, E. F. Cambridge University Press.
- SLONIMSKI, P. (1956). *III Int. Congr. Biochem.*, p. 242. New York: Academic Press.
- SPIEGELMAN, S. (1950). *In The Enzymes*, **1**, New York: Academic Press.
- SPIEGELMAN, S., and HALVORSON, H. O. (1953). *In Adaptation in Micro-organisms*, Eds. Davies, R., and Gale, E. F., Cambridge University Press.
- SWANSON, W. R., and CLIFTON, C. E. (1948). *J. Bact.*, **56**, 115.

DISCUSSION

Davis: I gather that these studies on adaptive enzyme formation were carried out under conditions without growth, relying on nitrogen sources within the cell. Have you studied the effect of your compounds on adaptation under conditions of growth?

Slonimski: We have started experiments on *Esch. coli* which is probably the best organism for such a study.

Davis: Your system in yeast has not been tested with growing cells?

Slonimski: Adaptive enzyme formation (cytochrome oxidase and maltozymase) was studied in the absence of growth and in the absence of cellular multiplication. Mutation studies were carried out, however, with cells growing exponentially in full medium. Cytochrome oxidase synthesis in yeast has a preferential character. When, during adaptation taking place in glucose buffer, one starts growth by addition of growth factors and a nitrogen source one gets first a temporary inhibition. Instead of getting a higher rate of synthesis one gets a lower one. This inhibition is resumed in about an hour.

Pollock: Did you get a completely parallel effect with these substances, cofactor *E* and cofactor *T*?

Slonimski: *T* is inhibitory in maltozymase, in cytochrome oxidase and in the euflavine-induced mutation (i.e. it inhibits the transmission of the normal genetic material). With respect to erythrose derivatives, we are not yet certain about this, but the substance that works on maltozymase may be different from the one that works on respiratory adaptation or the induced "petite" mutation.

We have preparations that stimulate cytochrome oxidase formation and are not active on maltozymase; and *vice versa*, we have one substance which stimulates maltozymase adaptation and is inactive on cytochrome

oxidase. But we have an absolutely parallel effect between respiratory adaptation and the induced "petite" mutation.

Westergaard: What happened with your fourth system, that of spontaneous mutation?

Slonimski: This gave a very curious result, but I did not want to talk about it because selection is not excluded and the results are preliminary. Cofactor *E* does not decrease the percentage of mutants; on the contrary, it increases it. Adenine does the same. So, from this point of view, it is exactly the same as in the euflavine-induced mutation. However, the situation is reversed because it is *E* which decreases the percentage of mutants in the euflavine system, while it increases it in the spontaneous mutation; conversely, *T*, which increases the percentage of mutants in the euflavine system decreases it in the spontaneous system. Spontaneous and induced mutants are both respiratory deficient, but recent work by Ephrussi, Roman and Hottinguer showed that in many of the highly mutable strains the "petites" are genetically different from the acridine-induced ones.

Westergaard: These are the somatic "petites"?

Slonimski: I think that the "petites" of C982/19b are somatic (vegetative) but they may be suppressive—dominant instead of being recessive.

Davis: How would you contrast the action of these substances in the mutagenic system with the action of other ordinary mutagens?

Slonimski: "Petite" mutation is genetically something rather unusual and from this material one should not extrapolate hastily to any other phenomenon. It shows, among other things, a unique relation between the process of mutation and the process of adaptation, both processes being, of course, quite distinct. This common reaction is specifically inhibited by acridines and involves tetrose derivatives. How they act is purely hypothetical at the present time. It seems to me possible that a tetrose nucleotide or its polymer is a part of the genetic material. Another possibility is that it acts like a co-enzyme in the synthesis of the proper genetic material. When we start getting down to the molecular level it may be difficult to distinguish between the immediate product of the action of a genetic determinant and parts of its structure. The point is that tetrose derivatives seem to be specifically involved in both.

Westergaard: What is the present status of the mitochondria in the somatic "petite"?

Slonimski: It contains mitochondria which are morphologically similar to those from normal cells. "Petite" mitochondria don't contain cytochrome oxidase, of course, therefore they will not be stained by Janus green-B, but on fixed preparations they can be revealed by Altmann staining. The present status of this problem has been reviewed by Ephrussi, Slonimski and Yotsuyanagi (1955, *loc. cit.*).

Pollock: Have you found any substance or even any conditions which will affect the mutation rate to "petite" without producing a comparable effect on adaptation?

Slonimski: Mutation and adaptation can be dissociated by cellular multiplication. The former requires proliferation, and mutant clones derive almost exclusively from cells formed in the presence of the drug.

Respiratory adaptation does not require proliferation. On the other hand, all the substances showing a specific mutagenesis do produce a comparable inhibitory effect on adaptation. The action of differently substituted acridines is quite parallel, and the concentrations of euflavine necessary to produce a half-maximal effect are very similar for mutation and for adaptation (6 to $7 \times 10^{-7}M$). However, the converse is not true. Several substances like benzimidazole or dinitrophenol inhibit adaptation without producing mutants. It should be added that Harris in our laboratory found that a continuous anaerobic culture for about a hundred cellular generations neither increases the percentage of "petites" in the population nor diminishes the capacity to form cytochrome oxidase adaptively (Harris, M. (1956), *J. cell. comp. Physiol.*, 48, 95).

Fulton: How did you measure the cytochrome oxidase present?

Slonimski: The method we use routinely is as follows: we make an extract of cells, spin down the so-called granules, then either we measure the oxygen uptake in the presence of the hydrogen donor, which is ascorbic acid, and in the presence of a saturating amount of cytochrome *c* (more precisely in the presence of 4 different concentrations of cytochrome *c* and extrapolate to saturation); or we measure spectrophotometrically the rate of oxidation of reduced cytochrome *c*. This is quite laborious. Not all the experiments were performed in this way, the majority of the experiments were performed by measuring the rate of overall respiration of intact cells under the conditions where we have shown previously that it is proportional to the amount of cytochrome oxidase, as measured by the first method.

Fulton: Your first method requires a lot of material, and your second one probably less?

Slonimski: Much less.

Fulton: Had you any trouble in reducing cytochrome *c*?

Slonimski: We had a little difficulty at the beginning when we used palladium.

Fulton: We have always experienced trouble in recovering pure reduced cytochrome *c*, after reduction with palladium, unless the metal is removed in an inert atmosphere, and the method is time-consuming.

Slonimski: The most satisfactory method for reduction is, in my opinion, the one introduced by Chantrenne (1955, *Biochim. biophys. acta.*, 18, 58). It consists in reducing cytochrome *c* by passing it on Duolite S-10, treated previously with $Na_2S_2O_4$. We used this method with commercial cytochrome *c* which contains some impurities.

Fulton: It tends to undergo auto-oxidation.

Slonimski: If you have peroxides, yes. However, the cytochrome *c* reduced on the ion exchange resin can be kept reduced for months if frozen. I personally prefer the first manometric method, although it requires a lot of material; but with yeast we had no trouble.

Davis: Have you tried the mutagenic action of your compound on more ordinary mutations?

Slonimski: We have already started some experiments on two things: one is mitotic crossing over in yeast and the second is what is called gene conversion (non-reciprocal recombination).

Short Communication

DEVELOPMENT OF RESISTANCE TO STREPTOMYCIN IN *SERRATIA MARCESCENS*

B. GYÖRFFY AND I. KÁLLAY

Institute of Genetics, Hungarian Academy of Sciences, Budapest

OUR work in the field of bacterial genetics was begun three years ago, and the results of our studies concerning the problem of the development of streptomycin resistance in *Serratia marcescens* are summarized here.

The bactericidal action of streptomycin was determined by the proportion of cells surviving on exposure to streptomycin for a limited time. Our results agreed with those already obtained for other bacteria (Demerec, 1951; Linz and Lecocq, 1955).

The bacteriostatic action of streptomycin was measured by counting colonies formed on streptomycin-agar. The overall picture of the distribution of the surviving fraction was similar to that reported by other workers (Demerec, 1948; Welsch, 1952). The facts that repeated experiments gave the same fraction of survivors and that not all of the cells survived even at low concentrations suggested the pre-existence of resistant variants in the populations (Sneath, 1956).

Colonies picked at random from streptomycin plates were retested. Many of these clonal populations, and in particular those from the faintly pigmented colonies, when grown at 4, 6 and 8 μg . streptomycin/ml. consisted almost wholly of cells having the same sensitivity as that of the original population. Some colonies, however, with normal pigment production, consisted of cells capable of forming the same number of colonies on plates containing 8 and 16 μg . streptomycin/ml., respectively, as they did on control plates; and giving about 10 per cent survival on plates containing 24 and 36 μg . streptomycin/ml., respectively. This low degree of resistance of substrains was maintained after several subcultures in drug-free medium.

Above the threshold concentration, when strong selection had already taken place, the possibility of resistant colonies occurring was increased. Although some of the colonies formed on plates containing 16–36 μg . streptomycin/ml. consisted of "persistors", many

colonies survived the same concentrations of streptomycin, on retest, in a high percentage; the cells of some of these colonies even extended their survival range beyond that of the parental population, in some cases up to 50–100 μg . streptomycin/ml. Nevertheless, on subsequent retest the colonies formed at higher concentrations of streptomycin showed many "normal overlaps"; and it is by no means unlikely that their occurrence can be explained by the physiological-biochemical heterogeneity of the cell population within a colony, as suggested by Sevag (1955).

In general, we observed that only a small fraction of the isolates of colonies formed on plates containing 50 and 80 μg . streptomycin/ml. consisted of cells which not only gave survival at above 16 and 24 μg . streptomycin/ml., respectively, but which also tended to keep this high resistance unaltered during a number of transfers. It seemed likely, however, that this small proportion of greater resistance originated from the selection of second-step variants which had arisen on the plates on retest (Abraham, 1953).

In summary, variable levels of resistance were obtained in a single exposure to streptomycin, and differences were observed between the independent isolates from the same plate. The survival distributions in retests were highly variable, and we found no adjustment to the concentration at which colonies were isolated (Barer, 1951; Gibson and Gibson, 1951; Eagle, Fleischman and Levy, 1952). The occurrence of "normal overlaps" of an unstable, readily reversible nature was very frequent but stable variants with low levels of resistance also developed.

Serial transfers were carried out with different strains of *Serratia marcescens*. The discrete steps resulting in progressively higher levels of survival were clearly evident. The small size of inocula (10^2 – 10^4 cells) used in the transfers excluded the presence of pre-existent resistant variants.

The average range of the first steps was less variable than that of the succeeding ones. In some instances, resistance to 100 μg . streptomycin/ml. was attained by three successive steps; in others, the number of transfers separating the steps differed, and flat plateaus also occurred (Oakberg and Luria, 1947). No quantitation was made as proposed by Treffers (1956).

This stepwise development of higher resistance was also apparent in serial transfers on solid medium, when the isolated single colonies were repeatedly retested. The average range of the single steps was approximately the same as that obtained in transfers in liquid medium. The outgrowth of second-step variants appearing in microcolonies on a background region on plates containing streptomycin in concentrations above 16 μg ./ml. was very definite in the

series of replica plates. The majority of the cells of colonies isolated at increased concentrations were resistant to the same range of concentrations, and the small fraction surviving on plates with considerably higher concentrations represented the further-step variants.

In general, the higher the concentration to which the organism was exposed, the greater was the resistance of a fraction of the emergent colony; while colonies surviving concentrations of 80–100 μg . streptomycin/ml. in the repeated retests, consisted mainly of fully resistant cells. In some instances, variants resistant to high levels of streptomycin (100 or 1000 μg ./ml.) were selected from large populations of sensitive cells, by plating, and were supposed to have originated by a single step (Newcombe and Hawirko, 1949).

We do not believe that even a low degree of stable resistance to streptomycin was acquired by physiological adaptation alone, as claimed by Gibson and Gibson (1951). Adaptive processes may play a rôle in the phenotypic manifestation of the resistant variant, and unquestionably they favour colony formation of persistors. Thus, the simultaneous appearance of “normal overlaps” and of resistants with a range of phenotypic variability always tends to obscure the stepwise discontinuity, and simulates a “continuous spectrum” which could be used to support the theory of physiological adaptation (Eagle, Fleischman and Levy, 1952).

“Repetitive training”, i.e. repeated subculturing in subthreshold concentrations (0.1 and 4 μg . streptomycin/ml.) is now in progress. Results obtained so far are that, in the series where a concentration of 0.1 μg . streptomycin/ml. was used, the survival fraction remained unaltered after 20 transfers; whereas in the series where 4 μg . streptomycin/ml. was used, a moderate increase in the fractions surviving concentrations of 16–50 μg ./ml. was obtained already after 20 transfers. This is in agreement with results obtained by Eagle, Fleischman and Levy (1952), Gibson and Gibson (1951) and Akiba (1955); (see however English and McCoy, 1951). But, as yet, we can only speculate as to whether enforced phenotypic modification or emergence of step variants occurred during the prolonged subculture.

The mutational origin of streptomycin-resistant variants of *Serratia marcescens* was indirectly demonstrated by the “fluctuation test” of Luria and Delbrück (1943). We are aware of the possibilities of error in analysis by means of this test; variability between independent cultures is not in itself conclusive evidence of mutation, and the results should be treated with reserve (Barer, 1951; Hinshelwood, 1952). In repeated experiments, a highly significant variation was observed in the number of resistant variants among independent

cultures. This was compatible with the spontaneous occurrence of resistant variants (Demerec, 1948; Newcombe and Hawirko, 1949). The actual distribution of numbers of resistant cells in independent cultures, in three fluctuation tests, was compared with the theoretical distribution (Lea and Coulson, 1949; Armitage, 1953). The good correspondence between the observed and theoretical distribution of resistants was satisfactory; a better correspondence could not be hoped for within the limits of experimental error. This result can be considered as quantitative evidence in support of the spontaneous occurrence of streptomycin-resistant cells.

The mutation rates were calculated by means of the following four methods: estimating the number of mutations (1) from the proportion of cultures with no mutants (Luria and Delbrück, 1943); (2) from the mean (Luria and Delbrück, 1943), (3) from the median (Lea and Coulson, 1949) and (4) from the maximum value of the number of resistants (Newcombe, 1948). The mutation rates were found to be approximately of the order of 10^{-9} at a screening level of 100 μg . streptomycin/ml., and progressively lower at screening levels of 80, 50 and 30 μg ./ml. (in a single experiment).

Indirect-selection experiments, by the replica plating technique of Lederberg and Lederberg (1952), have been carried out repeatedly without success; indirect-selection experiments by the use of enrichment cycles (Cavalli-Sforza and Lederberg, 1956) are now in progress.

On the whole, our observations seem to support the theory of the mutational origin of resistance to streptomycin, in the case of *Serratia marcescens*. These results will be published in detail.

REFERENCES

- ABRAHAM, E. P. (1953). *Symp. Soc. gen. Microbiol.*, **3**, 201.
AKIBA, T. (1955). In *Origins of Resistance to Toxic Agents*, p. 82, Ed. Sevag, M. G., Reid, R. D., and Reynolds, D. E. New York: Academic Press.
ARMITAGE, P. (1953). *J. Hyg.*, **51**, 162.
BARER, G. R. (1953). *J. gen. Microbiol.*, **5**, 1.
CAVALLI-SFORZA, L. L., and LEDERBERG, J. (1956). *Genetics*, **41**, 367.
DEMEREC, M. (1948). *J. Bact.*, **56**, 63.
DEMEREC, M. (1951). *Genetics*, **36**, 585.
EAGLE, H., FLEISCHMAN, R., and LEVY, M. (1952). *J. Bact.*, **63**, 623.
ENGLISH, A. R., and MCCOY, E. (1951). *J. Bact.*, **61**, 51.
GIBSON, M. I., and GIBSON, F. (1951). *Nature, Lond.*, **168**, 113.
HINSHELWOOD, C. N. (1952). *Bull. World Hlth. Org.*, **6**, 1.
LEA, D. E., and COULSON, C. A. (1949). *J. Genet.*, **49**, 264.
LEDERBERG, J., and LEDERBERG, E. (1952). *J. Bact.*, **69**, 184.

- LINZ, R., and LECOCQ, E. (1955). *C. R. Soc. Biol., Paris*, **144**, 1698.
- LURIA, S. E., and DELBRÜCK, M. (1943). *Genetics*, **28**, 491.
- NEWCOMBE, H. B. (1948). *Genetics*, **33**, 447.
- NEWCOMBE, H. B., and HAWIRKO, R. (1949). *J. Bact.*, **57**, 565.
- OAKBERG, E. F., and LURIA, S. E. (1947). *Genetics*, **32**, 249.
- SEVAG, M. B. (1955). *In* Origins of Resistance to Toxic Agents, p. 370, Ed. Sevag, M. G., Reid, R. D., and Reynolds, D. E. New York: Academic Press.
- SNEATH, P. H. A. (1956). *J. gen. Microbiol.*, **13**, 561.
- TREFFERS, H. P. (1956). *Antibiot. Chemother.*, **6**, 692.
- WELSCH, M. (1952). *Bull. World Hlth. Org.*, **6**, 173.

DISCUSSION

Hayes: What was the mutation rate at the lower level of selection, i.e. at 30 µg./ml.?

Györfly: That was $2-5 \times 10^{-6}$.

Stocker: In the case where you used low concentrations to screen, so that a high proportion of the colonies formed were "persistors", i.e. they were not resistant on retest, did you find any evidence of fluctuation, i.e. was there marked variation between replicate cultures grown from small inocula, as to number of persistor colonies formed? One theoretically possible explanation for persistors is that they are cells which result from a mutation-like process which occurs very rapidly in each direction, so that there is correlation, persisting for a small number of generations only, between the phenotypes of the parent and the descendants; in which case one might perhaps expect to find some degree of fluctuation in a test of that sort.

Györfly: We did not observe fluctuation; but mostly we used the higher degree of resistance, because repeated retesting gives rise to a great deal of difficulty at lower concentrations.

Cavalli-Sforza: Dr. Stocker's remark might be amplified by saying that not only a high back-mutation rate, but also a low selective value, i.e. a low growth rate of the mutant might easily be responsible for unstable resistance. It is important to think in terms of growth rates also, because that is so much more likely to be effective from the kinetical point of view than the mutation rate.

Knov: We have heard a great deal about the rôle of DNA in determining genetic characteristics and so on, but we have not heard anything about the rôle of the protein in the gene. Is it the view of the geneticists that a gene is a naked DNA or that it is a DNA with some protein fitted to it in some specific way? If so, it is conceivable that a good deal of this controversy as to what is an unstable mutant and what is an adaptive change might actually be due to some change occurring in the protein part of the gene itself. If that were the case, then the DNA in such a system might be normal, but there might be not just a purely adaptational change in the enzyme of the cell, but some change in the protein

component of the gene, if indeed the gene has got a protein component. In that case, you would have an abnormal protein which was in fact a part of the gene; you would then have a system which could be, up to a point, capable of repeating itself, but gradually it would revert to normal as the stimulus which evoked the production of the abnormal protein disappeared. I should like to know what is thought about this problem of the relation between the protein and the DNA in the gene.

Hotchkiss: As far as I know, DNA has never exerted its function in a cell that did not contain protein! We don't know any of the steps in the process of gene action, but one of them might well be a forming of a complementary protein-like structure; but we have not the evidence to give an answer.

Eagle: As a fairly recent convert to the thesis that most resistant variants which we see in cultures arise as a result of mutation and selection rather than physiological adaptation, I confess that I am still puzzled with respect to terminology. I am referring specifically to so-called first-, second- and third-step mutations. If one takes a culture not previously exposed to antibiotics, then, varying with the organism and with the antibiotic, the number of survivors in an agar plate may fall off steeply as the concentration of antibiotic is increased, or may fall very slowly. In either case, if a surviving colony is subcultured, and the distribution of resistance redetermined, then as Dr. Györfy has just reported, some have essentially the same spectrum of resistance as the parent population. Usually, however, the average resistance of sample clones growing out at a given concentration of antibiotic tends to be related to the concentration to which it had been exposed. A single clone may therefore give rise to colonies which differ widely in their resistance to antibiotic; and the gradations are almost imperceptibly fine. Are all of these organisms first-step mutants varying widely in resistance, as these results and those of Dr. Hughes would imply; or are there first-, second-, third-, fourth- and even fifth-step mutants within a single clone?

Cavalli-Sforza: It refers to the sequence in which you have selected.

Eagle: I think we have to be quite clear on this point. I had assumed that a first-step mutant represented the first mutational step toward increased resistance, and it has been so described. If we now redefine the first-step mutant as that isolated on the first attempt at selection, such a mutant could be a second- or third-step mutant in terms of what actually transpired.

Dr. Hughes has reported some observations which indicate that extremely fine gradations of resistance may occur within a single clone. Operationally, as Prof. Cavalli-Sforza would define them, these are all first-step mutants; in fact, they could be second-, third, or fourth-step mutants. The terms should be used with caution, and perhaps avoided.

Cavalli-Sforza: In relation to the first-step variations observed by Dr. Hughes, I don't know that they are mutants.

Eagle: The differences we have observed are certainly stable. Whether Dr. Hughes' extremely fine steps are similarly stable apparently remains to be determined; but at least for streptomycin, penicillin and chloramphenicol, these small differences are real and stable. Are they all to be

called first-step mutants merely because they are distinguished in the first attempt at selection?

Cavalli-Sforza: If that happens after one exposure, I think yes. A first-step mutant might on the other hand be the result of more than one mutation: only genetic analysis could tell. This depends of course on conditions of selection, and on mutation rates.

Lederberg: This terminology was developed when our only method of analysis was mutational; the first-step was just an operational statement as to how many sequences of selection were made. From that you might wish to infer that there was a one-gene change, which is not necessarily true. We now have methods of finding out in some organisms how many genes are involved at various levels of resistance. I think that is a much more important question if what you are interested in is the genetic structure of the resistant forms. I would not ordinarily rely too implicitly on the number of steps with which you could get a highly resistant form to tell how many genes are involved. Dr. Hotchkiss has some contradictory evidence on this point. In one system with penicillin he was able to correlate them very well, in another with sulphonamide resistance he had a one-step isolation which has given him at least three loci. Apparently there can be coincidences or accidents which will lead to some discrepancy between the number of steps you think you made and the number of mutations which have really accumulated.

Dean: It becomes rather important when you calculate mutation rates from the Lea-Coulson formulae, because in their mathematical analysis the distribution is based by hypothesis on one genetic change. It should not be applied to polygenic systems.

Lederberg: You can make reasonable corrections for it, if you keep in mind that what you are measuring is the summation of all genetic changes that have the phenotype for which you are scoring.

Fulton: It is a most difficult problem to isolate DNA in highly polymerized form from bacteria, and I should like to know what accompanies the DNA in the bacteriologists' cell-extracts. Since even the elegant experiments of McCarty on the isolation of DNA from pneumococci have been criticized, do you think that products labelled DNA by the bacteriologist are really DNA?

Yudkin: The important point is that the transforming activity is destroyed by DNase.

Hotchkiss: Then you have another tube in the laboratory which one labels DNase; how good is that DNase?

Davis: Those interested in the genetics of drug resistance have deliberately studied only increments of resistance large enough to permit clean screening. It seems to me we pose impossible questions when we take the techniques that were suitable for such large degrees of resistance and apply them in the region of tiny-step resistance. As Dr. Györfly pointed out, in this region there is an overlap between physiological variations and mutations. A cell may survive a borderline concentration of drug for physiological reasons and then continue to grow in a slow, struggling manner. But before this cell has given rise to a colony of a million cells the clone may have developed one or more mutations that

improved the growth rate in the presence of the drug and so were selected. Hence, when Dr. Eagle subcultures such a colony and finds that it gives a new curve of resistance, this does not tell us whether the parental cell of this colony was genetically different from sister cells that failed to yield colonies. It seems to me that it will take an elaborate new kind of experimentation, along lines initiated by Dr. Hughes, to analyse the rôle of mutation and that of physiological adaptation in the region of small differences in resistance.

Eagle: You have answered my question, at least in terms of your own opinion: that the term "step" is a misnomer, because we don't know either how many mutational steps there have actually been or their individual magnitude.

DISTRIBUTION OF DRUG-RESISTANT INDIVIDUALS IN CULTURES OF *MYCOBACTERIUM TUBERCULOSIS*

R. KNOX

Department of Bacteriology, Guy's Hospital Medical School, London

TUBERCULOSIS shows perhaps more clearly than any other disease the dangers associated with the development of drug resistance. With streptomycin, *p*-aminosalicylic acid (PAS), isoniazid and other less commonly used drugs, initial success in chemotherapy has often been followed by subsequent failure associated with the development of drug-resistant strains. *In vitro* tests of drug sensitivity however are in many respects unsatisfactory, and the information they give is often difficult to interpret and to correlate with results obtained *in vivo*. One of the reasons for this is the difficulty in obtaining accurate information about the number of viable tubercle bacilli and the proportions of drug-resistant individuals present in a given bacterial population.

Recently, we have been using semi-solid (0·125 per cent) agar as a convenient medium for rapid culture of *Mycobacterium tuberculosis* and for the performance of viable counts (Knox, 1955; Knox, Swait and Woodroffe, 1956). We have also found media of this kind very useful for the performance of drug sensitivity tests and for determining what proportion of individuals in a given culture is resistant to different drug levels (Knox and Woodroffe, 1957). Preliminary work showed some interesting differences between streptomycin, PAS and isoniazid in the patterns of resistance they showed in this medium. It seemed, therefore, that it would be interesting to investigate by the use of semi-solid medium the distribution of drug-resistant individuals in different conditions of incubation, with different drugs separately and together.

It was found that the apparent rate of development of drug-resistant colonies in cultures of *Myco. tuberculosis* varied both with the drug and with the medium. Some of these differences have been described elsewhere (Knox and Woodroffe, 1957). With isoniazid in Kirchner semi-solid agar, presumptively resistant colonies of the drug-sensitive H 37 Rv strain grew in decreasing numbers as the drug concentration was increased. But colonies which had developed in tubes which initially contained quite high drug concentrations, up to 10 $\mu\text{g./ml.}$ or more, often appeared to be fully sensitive to isoniazid when retested in subculture. Sometimes they behaved as though they consisted of a "mixed" culture, mainly drug-sensitive but containing more resistant cells than a fully sensitive strain. This could be explained partly by the fact that isoniazid decays rapidly in Kirchner medium and any individual cells which might survive exposure to isoniazid would be able to multiply when the drug decayed below a certain level. Such individuals would clearly not be true drug-resistant mutants. On the other hand, they must be different in some way from the great majority of the individuals in a drug-sensitive population, whether we seek to explain them in terms of temporary adaptation to the drug (Hinshelwood, 1946; Dean and Hinshelwood, 1953), impermeability, "persistence" (Bigger, 1944) or clonal variation (Yudkin, 1953). For brevity, such cells may be described as pseudomutants.

It was felt that more information would be obtained about the distribution of resistant individuals in semi-solid medium if cultures were allowed to grow for a few days before adding drug to the medium. In this way, when a large inoculum was used (say, 10^6 cells/ml. of Dubos culture) innumerable minute colonies could be seen with a hand lens. When serial dilutions of isoniazid were added at this stage (say after 3 days of incubation), the drug diffused rapidly through the medium and these microcolonies showed no further increase in size. However, after 2-4 weeks of incubation a few large isolated colonies could be seen developing from among the innumerable

microcolonies, even in tubes which originally contained up to 50 $\mu\text{g./ml.}$ Thus, although it was not possible to follow the fate of individual cells, it was possible to study the fate of individual small clones in such a population of microcolonies. Single colonies appearing after 2-4 weeks in tubes to which the drug was added after 3 days of incubation were found to be highly resistant on subculture, whereas the pseudomutants mentioned above were much less numerous.

Thus, by incubating cultures of drug-resistant cells for 3 days so that microcolonies developed before exposure to the drug, drug-resistant mutants were much more easily obtained. This phenomenon was unlikely to be simply the effect of inoculum size; if it were it would be reasonable to expect a corresponding increase in the proportion of pseudomutants. This did not occur. It is more likely to be related to the different physiological state of the cultures. When a mature culture is inoculated into drug-containing medium it is possible that some of the cells might survive exposure to the drug because they were not metabolically active at the moment of inoculation, and in the new drug-containing medium they remain in a dormant state until the drug decays. On the other hand, when the drug is added to actively dividing cells without their transference to new medium it is likely that more of the cells will be vulnerable to the drug and the only survivors will be true drug-resistant mutants. This explanation however is not entirely satisfactory, since pseudomutants did not appear, even in tubes to which the drug was added immediately, if the inoculum was increased five- to tenfold, whereas true mutants did appear, in increased numbers, as in the tubes to which drug was added after 3 days of incubation. From this, it seems possible that a large population of normal sensitive cells exerts a suppressive effect on the development of pseudomutants.

It might perhaps be said that by the time we have taken into account factors such as inoculum size, the physiological state of the culture, the composition of the medium and the decay of the drug in it, we have reached a very complex

situation which is not easy to analyse, and that until more precise methods are available for labelling tubercle bacilli the problem of drug resistance in this group of organisms is not a profitable field. But while it is true that precise genetic analyses in tubercle bacilli may be more rapidly advanced by discoveries going on in other groups of organisms, it is after all possible that some of the problems are unique to mycobacteria, and therefore it is worth while trying to collect more information about the different patterns of resistance which they show with different drugs. Szybalski and Bryson (1952), Middlebrook (1954), Mitchison (1952, 1953) and others have already contributed much in this field.

The experiments here described show how careful we must be before we talk about mutation rates in tubercle bacilli. For example, Middlebrook (1956) has stated that by a simple plating technique it is possible to show that the frequency of mutants resistant to high levels of isoniazid is 1 in 10^5 , and to streptomycin 1 in 10^6 , and that the frequency of double mutants seems to be something like the product of these two rates. We have repeatedly tried to demonstrate this but have come up against this phenomenon of pseudomutants. We are trying to find a medium in which isoniazid does not decay, or some means of maintaining the level constant by regular small additions of drug. In the meantime we can say that the pseudomutant phenomenon is especially marked in Kirchner medium in which the drug decays rapidly, that it is less marked in Fisher (1952) medium in which it decays more slowly, and that it does not occur with streptomycin or PAS, both of which are more stable than isoniazid in the media we have used.

One of the most interesting features of isoniazid resistance is the relation between resistance, catalase activity and virulence. It seems to be generally agreed that there are at least two types of isoniazid-resistant tubercle bacilli: (1) stable, highly resistant catalase-negative strains (Middlebrook, 1954) and (2) unstable, catalase-positive strains of lower resistance. A possible explanation for these two kinds of resistant culture is suggested here.

Let us assume that isoniazid in high concentrations blocks the formation of a specific peroxidase (almost certainly not catalase) essential for the growth of the tubercle bacillus, at any rate in conditions in which peroxides are produced. Mutants occur naturally, at a rate of about 1 in 10^5 , which are deficient in the gene or genes controlling the synthesis of this peroxidase. Such mutants (1) cannot grow in media in which peroxides are formed, (2) can grow in such media provided the peroxides are destroyed, e.g. by haemin (Fisher, 1954; Knox, 1955) or catalase (Middlebrook, 1954; Knox, 1955), (3) could grow in media in which peroxides were not formed, (4) must be logically, and are in fact, isoniazid-resistant *because* they lack the peroxidase-forming enzyme system which is *ex hypothesi* the system vulnerable to isoniazid. The DNA of such mutants is abnormal—either because one specific DNA molecule or part of a molecule is lacking or because normal DNA is replaced by an abnormal DNA. Whatever the mechanism, the result is a DNA lacking the ability to control peroxidase synthesis.

The second type of isoniazid-resistant culture is one induced by isoniazid. Whereas in high concentrations isoniazid completely blocks the formation of a specific peroxidase and therefore the only survivors will be cells deficient in the vulnerable system, in lower concentrations isoniazid can induce the formation, by an adaptive process, of an abnormal peroxidase system. It is even possible that the abnormality might be in the protein part of the peroxidase-producing gene itself. If so, then the stable highly resistant cell would have an abnormal or missing gene and therefore might lack the protein and so the enzyme; while the unstable pseudomutant would possess normal DNA but, under the influence of isoniazid, would produce an abnormal protein. If this were actually part of the gene it might be reduplicated for some time even in the absence of isoniazid, but eventually a return to normal protein synthesis would occur. A test of such a hypothesis might be made by extracting transforming substances from tubercle bacilli, but our efforts in this direction

have so far had no success. In some such way it might be possible to explain intermediate stages between a stable drug-resistant mutant on the one hand, and a purely phenotypic and temporary adaptation on the other.

REFERENCES

- BIGGER, J. W. (1944). *Lancet*, **ii**, 497.
DEAN, A. C. R., and HINSELWOOD, C. N. (1953). *Sym. Soc. gen. Microbiol.*, **3**, 21.
FISHER, M. W. (1952). *Amer. Rev. Tuberc.*, **66**, 626.
FISHER, M. W. (1954). *Amer. Rev. Tuberc.*, **69**, 797.
HINSELWOOD, C. N. (1946). *The Chemical Kinetics of the Bacterial Cell*. Oxford: Clarendon Press.
KNOX, R. (1955). *Lancet*, **ii**, 110.
KNOX, R., SWAIT, E. M., and WOODROFFE, R. (1956). *J. gen. Microbiol.*, **15**, 359.
KNOX, R., and WOODROFFE, R. (1957). *J. gen. Microbiol.*, **16**, No. 3, in press.
MIDDLEBROOK, G. (1954). *Amer. Rev. Tuberc.*, **69**, 471.
MIDDLEBROOK, G. (1956). *Amer. Rev. Tuberc.*, **74**, No. 1, 42.
MITCHISON, D. A. (1952). *Lancet*, **ii**, 858.
MITCHISON, D. A. (1953). *J. clin. Path.*, **6**, 118.
SZYBALSKI, W., and BRYSON, V. (1952). *Amer. Rev. Tuberc.*, **65**, 768.
YUDKIN, J. (1953). *Nature, Lond.*, **171**, 541.

DISCUSSION

Pollock: What is the range of different isoniazid concentrations between the end-point for the majority of cells and the end-point for the "pseudomutants"?

Knox: It depends a great deal on the inoculum size, but the arbitrary end-point is usually about 0.01 μg . in cultures grown for 2-6 days. These pseudomutants eventually grow to a range of about "10 μg .". The method which we used in these tubes is simply to put rubber bungs in which prevent evaporation; and we can then put the tube in without disturbing them and look at them when we like. Where a lot of growth is occurring, a lack of oxygen will develop very quickly, and we are investigating that; but where no growth occurs that does not apply.

Pollock: A similar effect is seen with penicillin resistance in *B. cereus* at the end-point; but there is not such a big difference in concentration as you have found. The likely explanation in the case of *B. cereus*, and one which might apply in your case, is that there may be an inducible enzyme responsible for destroying the drug. You would have a very delicate balance between two opposite effects of the isoniazid. One would be the inducing effect on the enzyme which destroys it; the other would be its

general inhibitory effect on metabolism. Therefore, the very smallest difference, say in lag phase of the individual cells, or small changes like that, might determine whether the whole colony appeared or not. I am quite sure that is the explanation in the case of *B. cereus*.

Knox: It is complicated by the decay of the drug. We have made biological estimates of the amount of drug in the semi-solid medium by simply adding organisms on the surface later. It is not a very good method but it does give us some idea; and we have also checked it by polarographic methods.

Eagle: There is a superficial analogy between this phenomenon, in which Prof. Knox gets fewer pseudomutants with a large inoculum than he does with a small one, and the fact that with penicillin and a variety of bacterial species, the number of resistant mutants which show up in a penicillin plate often decreases, rather than increases, with the size of the inoculum. At a threshold concentration of penicillin, with an inoculum of e.g. 10^6 organisms one may get ten resistant colonies; at the same penicillin concentration, with an inoculum of 10^8 organisms, instead of getting the expected thousand colonies, one may get none. The resemblance in the two phenomena is only superficial, however; because in our case these are penicillin-resistant colonies, while in Prof. Knox's case they apparently are not.

Pollock: Is there some inhibition by the non-mutated ones?

Eagle: In the case of *Staphylococcus* and penicillin, we hoped that this might be a case of transformation of the resistant organisms to sensitive, induced by DNA deriving from the enormous numbers of sensitive bacteria which are being killed in the immediate environment of each resistant organism. Unfortunately, however, DNase had no effect, and we have no idea as to what is happening.

Pontecorvo: The suppression of something that *should* grow, by the remaining mass of the population which *should not* grow, is a very widespread fact; it goes under the jargon name of "Grigg effect". It is very specific, some mutants will show it, others will not. In some cases it can be a nuisance in genetic experiments.

Davis: In your case, Dr. Eagle, where you failed to get mutants, might it be that the density of the inoculum was so large that it exhausted the medium through its metabolic activity?

Eagle: No, this was examined and the failure of the organisms to grow with the large inoculum was not due to exhaustion of the medium. When the plate was flooded with penicillinase at the end of the experiment, a surface inoculum of a few organisms grew out readily. There is something going from the sensitive to the resistant organisms in this experiment which makes the latter sensitive. This can be stopped by the interposition of a cellophane membrane in the penicillin-agar between the mass of normal cells and a few resistant organisms. The latter then grew out in normal fashion.

Dean: Would it be possible to confirm the suppression of mutants by non-mutants by means of reconstruction experiments, in which mutants are tested in the presence and absence of a large number of sensitive cells?

Knox: We plan to do that.

Dean: Can you get some indication of the rate of decay of the drug and maintain the drug concentration at a constant level?

Knox: This is also something that we plan to do.

Westergaard: This may not be relevant to Prof. Knox's problem, but when you block catalase, you do increase the concentration of peroxide and thereby the concentration of a mutagen, so you certainly introduce a new variable which you have not taken into account.

Knox: One of the possibilities is, that if isoniazid does interfere with peroxide destruction, and peroxide is accumulating, then the peroxide itself acts as a mutagenic agent; but I don't think that will explain the deficiency of the resistant mutants which have never been in contact with isoniazid.

Hayes: In view of the fact that isoniazid is a killing drug, is it not very likely that the pseudomutants are in fact persistors and that the difference between the 3-day culture and the other is simply that virtually all the cells of the 3-day culture are actively growing when the drug is added and, therefore, susceptible to it? Perhaps if you added some non-specific, purely bacteriostatic substance, which does not kill but which simply stops growth, you could clear this up.

Knox: Schaefer has shown that if you add glucose to a medium of tubercle bacilli, isoniazid immediately becomes much more bactericidal. Oxygenation probably has the same effect; it is fairly bactericidal in some media, at any rate. In the Fisher type of medium in which this pseudomutant phenomenon does not occur, it seems to be fairly bactericidal. Streptomycin, on the other hand, does not show this phenomenon. There seems to be a great controversy as to whether streptomycin is or is not bactericidal for tubercle bacilli.

Lederberg: Is there any explicit evidence that the rate of bactericide by isoniazid depends on the rate at which the cells are grown?

Knox: I think Schaefer's work proves that.

Lederberg: Then there may be a superficial resemblance to some other things that Dr. Eagle described, in that if there were both a bacteriostatic and a bactericidal effect, on the part of isoniazid, those cells which happen to be first inhibited in their growth would be temporarily protected from the bactericidal effect. This might account for the zone in which you can get an increase of either in the presence of isoniazid. This would then be very much subject to external conditions. This bears on the second point, that some more attention should be paid to these cases where there are diffusible effects from sensitive cells to resistant ones in the same population. This is a hopeful point that may have bearing on practical problems of chemotherapy. If we understood those better we would have at least one approach to coping with drug-resistant organisms. It seems not impossible that, in Dr. Eagle's case, these resistant mutants are resistant because of some block or some deficiency in a metabolic process, and that this has been repaired by the products from sensitive cells. One would like to know how specific that is.

Pollock: We have done a few experiments along these lines with penicillin resistance and penicillin dependence of *Staphylococcus*. We made

extracts from dependent cells to see if we could get any effect on the sensitive cells, but we found nothing.

Lederberg: Dr. Eagle has the complete case. These were added resistant cells which were in fact killed by being in the same environment where the sensitive cells were killed, and that is to some extent a model of some real situation.

Eagle: This is an extremely strain-specific phenomenon. A mass of sensitive organisms, e.g. staphylococci, will not kill a few resistant streptococci or pneumococci. As I have mentioned, DNase had no effect, and we concluded that DNA was not passing from sensitive to resistant organisms. Is it possible, however, that this has not been wholly excluded by this experiment—that the mean distance between the sensitive and the resistant organism in a crowded plate is so small, and the amount of the DNase added also so small, that there may not have been time for the complete destruction of the DNA *en route*, so to speak? This is still perhaps an open possibility.

Pollock: It does not necessarily have to be DNA. There are a number of other possibilities to explain this effect.

Lederberg: It seems unlikely that this is a genetic effect at all, just from the empirical fact that you get segregation of markers that have been transduced. In other words, if you put a genetic fragment, i.e. a sensitive gene, into a resistant cell, you don't necessarily get out a sensitive clone. You get a mixture of sensitives and resistants. On the other hand, the simplest assumption would be that you have had a transfer of an essential component of the "phenome" as Prof. Davis calls it, and this could be equally sensitive, and might even be RNA. There are a few experiments that are analogous to this, i.e. transfer of enzyme-forming ability from one genotype to another by means of RNA, or by means of a metabolite of some protein.

Knox: We have made several attempts to see whether heat-killed sensitive organisms have any effect on the development of resistance, but we have found nothing so far.

Stocker: With regard to Prof. Knox's hypothesis on isoniazid resistance resulting from a spontaneous mutation causing a block in the synthesis of a peroxidase system, it is not clear to me why such a block should confer resistance. If the mutants which owe their resistance to this type of mutation can survive only in media with catalase, or anaerobically, then would one not expect sensitive organisms also to survive isoniazid under such conditions? If the system concerned were dispensable under those conditions, then even if the system were blocked by the action of isoniazid the sensitive organism would be unaffected.

Knox: This question is tied up with the whole question of haemin and the destruction of isoniazid. Catalase may be a different matter. With regard to haemin, that is exactly what happens. If you inoculate sensitive organisms into quite high concentrations of isoniazid in the presence of haemin, they grow quite happily. That was originally thought by Fisher to be a case of competitive antagonism. But it was later shown by various people that haemin oxidizes isoniazid. In the presence of oxygen, haemin catalyses the oxidation of isoniazid to a double compound

and *isonicotinic* acid. I am not satisfied that this occurs to the same extent in media in which organisms are growing, because firstly it requires quite a considerable amount of oxygen to occur at all. Secondly, the process is rather slow. We found in some of our experiments, in which we added haemin at intervals to media which had got isoniazid in them, that one could reverse the action of isoniazid if the haemin was added immediately, but after a day or two the effect of the haemin got less and less. In other words, by that time the isoniazid must have caused some irreversible changes. So that you do, in fact, get growth of sensitive cells in the presence of haemin; when you subculture them (they grow in 10 or 50 $\mu\text{g.}/\text{ml.}$, depending on how much haemin you have there) they are found to be quite sensitive.

PHYSIOLOGICAL ADAPTATION OF BACTERIA TO ANTIBIOTICS

W. KUNICKI-GOLDFINGER

Department of Microbiology, The University, Wrocław

RECENT studies with bacteria have shown that the development of drug-resistant strains in the majority of cases is caused by genic changes (Demerec, 1945, 1948; Newcombe and Hawirko, 1949; Bornschein, Dittrich and Höhne, 1951; Cavalli-Sforza and Lederberg, 1953; Bryson and Szybalski, 1952; Gale, 1949; Lederberg and Lederberg, 1952). In connexion with these observations the rôle of phenotypic or physiological changes as a contributing factor seems to be neglected.

It is hoped, therefore, that it will not be out of place at this meeting to discuss some physiological reactions of bacteria, in which the observable changes seem to have a non-genic character and which result in increased resistance.

An apparently total directed change in a relatively stationary population

Akiba (1955) and Szybalski (1955) have shown that in *Escherichia coli*, when suspended in buffer solution and incubated for a long period in the presence of streptomycin, a characteristic change in total population may be observed. Initially sensitive cells become resistant to a rather high level of the drug. The rôle of selection may seem to be neglected, because no growth during the incubation period was noted. The induced streptomycin resistance has been shown by recombination analysis to be genic (Szybalski, 1955). The nature of this change was related by Szybalski to the selective mutagenic action of the antibiotic.

On the basis of this hypothesis we would postulate a double specificity of streptomycin: as an inhibitor of the drug-sensitive biochemical pathway, and as a mutagenic factor specifically altering the genic element, governing just this pathway. This mechanism is possible but rather improbable.

To elucidate this problem some experiments were made in our laboratory. We were not able to confirm these results. Nevertheless, we are careful in interpretation, because the conditions of our experiments were different from those of Szybalski.*

Esch. coli K 12 was used. The sensitivity of the original strain to streptomycin, as assayed with the plate dilution method, is shown in Table I.

Table I
SENSITIVITY OF *Esch. coli* K 12 TO STREPTOMYCIN

<i>Streptomycin</i> concentration μg./ml.	Number of viable units per ml.
0	1.66×10^9
0.78	1.63×10^9
1.56	1.43×10^9
3.13	1.17×10^9
6.25	3.18×10^8
12.50	1.65×10^4
25.00	150
50.00	14
100.00	1

Bacteria were grown in beef-heart broth, harvested after 20 hours of incubation, washed twice in phosphate buffer (pH 7), and resuspended in the buffer to give a turbidity of 10^8 to 10^9 cells per ml. Dihydrostreptomycin (Merek) was then added to bring the final concentration up to 5 μg. per ml.

* In recent communications on this problem Szybalski (1956) and Arndt and Zinder (1956) have shown that in Szybalski's experimental conditions multiplication of bacteria was possible, and was in fact going on during the incubation period. The selection of spontaneous mutants was not excluded.

The suspension was incubated in an ice-box at 4° C. At appropriate time intervals the bacterial suspension was examined for sensitivity by the plate assay method. Representative results are shown in Table II.

Table II

EFFECT OF COOLING AND OF STREPTOMYCIN ON DRUG RESISTANCE OF *Esch. coli* POPULATION (number of viable units giving visible colonies on agar-medium containing various concentrations of the antibiotic).

Time of incubation (hours)	Concentration of streptomycin ($\mu\text{g./ml.}$)				
	0	5	10	25	50
0	10^9	4.0×10^8	1.5×10^5	10^2	10
24	7.0×10^8	3.3×10^8	9.0×10^6	2.0×10^2	20
48	3.0×10^8	2.0×10^8	1.2×10^8	2.0×10^2	40
72	2.7×10^8	2.4×10^8	1.2×10^8	1.4×10^3	60

Almost all cells now became resistant to 10 $\mu\text{g./ml.}$; the number of cells resistant to 25 $\mu\text{g./ml.}$ increased tenfold and more. The resistance to 50 $\mu\text{g./ml.}$ (the highest concentration tested) remained without appreciable change. On agar plates containing 50 $\mu\text{g.}$ of streptomycin per ml., with the exception of a few normal resistant colonies there were observed very small colonies appearing much later (after 5–6 days of incubation), consisting of morphologically changed rods of variable resistance. These small colonies developed from microcolonies, which could be seen on the surface of the medium after 24–48 hours of incubation. We are at present studying the nature of these changed forms and their significance.

The resistant clones, obtained on the plates in the form of visible colonies, were stable in many subcultures. The presumably genic nature of these stable variants is now being studied in recombination experiments.

Some discrepancies between the results of Akiba and of Szybalski and those presented here may be due to differences

in the techniques used and in the bacteria tested. Nevertheless, some increase was shown in the resistance of bacteria after their exposure to streptomycin in conditions excluding growth.

In further experiments it was ascertained that the concentration of streptomycin in the buffer had no effect on the resulting increase in drug resistance. Furthermore, quite similar results could be obtained when bacteria were suspended in the buffer alone and cooled at 4° C for an appropriate time. The effect of the buffer alone on the increase in resistance is shown in Table III.

Table III

EFFECT OF COOLING ON DRUG RESISTANCE OF *Esch. coli* POPULATION (number of viable units giving visible colonies on agar-medium containing various concentrations of the antibiotic).

Time of incubation (hours)	Concentration of streptomycin (μg./ml.)				
	0	5	10	25	50
0	10 ⁹	4.0 × 10 ⁸	1.5 × 10 ²	10 ²	10
24	7.6 × 10 ⁸	4.3 × 10 ⁸	1.7 × 10 ⁶	—	—
48	1.1 × 10 ⁹	8.4 × 10 ⁸	1.5 × 10 ⁷	2.0 × 10 ⁵	20
72	1.1 × 10 ⁹	8.1 × 10 ⁸	—	7.1 × 10 ⁵	20

It is thus conclusively shown that for the induction of streptomycin resistance the presence of the drug is not indispensable. This fact seems contradictory to Szybalski's hypothesis of streptomycin-induced mutation of a total population.

The results of present research suggest that induction of mutation by streptomycin is not operable in this case. Nevertheless the induction of mass-mutation in all cells by other factors, even if improbable, had not yet been excluded.

In order to test this hypothesis some preliminary experiments were made on the stability of resistance. Bacteria incubated in buffer at 4° C in the absence of antibiotics were transferred to beef-heart broth and incubated for various

times. The sensitivity spectrum of the cultures thus obtained was examined by the plate assay method. The acquired resistance was relatively stable, but decreased to some extent after 24, and quite distinctly after 48 and 72 hours of incubation. The instability of a new variant alone is not a good proof of the physiological character of the change. The opinion that development of resistance was in this case due to a physiological change is, however, supported by other observations. The change affected all cells only with respect to 10 $\mu\text{g.}$ of streptomycin per ml. Only a fraction of the population changed its sensitivity to 25 $\mu\text{g.}$ and the sensitivity to 50 $\mu\text{g.}$ did not change at all. There is some correlation between the number of cells capable of forming colonies on various levels of streptomycin and the dimensions of microcolonies appearing on plates containing 25 $\mu\text{g.}$ and even 50 $\mu\text{g.}$ per ml. of the drug.

The number of cells in these microcolonies is of such order that there is a great probability of mutants appearing which are resistant to 10 $\mu\text{g.}$, a smaller probability for mutants resistant to 25 $\mu\text{g.}$, and very little probability for mutants insensitive to 50 $\mu\text{g.}$ per ml.

Further, the induced variation in drug susceptibility was related to some transient changes in the morphology of cells and in the pattern of growth. Firstly, the cell dimensions were greatly diminished (approximately twice). This was probably due to some residual growth in buffer alone as well as in buffer with streptomycin, such residual growth being more prominent during the first hour of incubation, but observable even after 48 hours, and resulting sometimes in an increase of the number of viable units by as much as 50 to 100 per cent. In the majority of cases the final number of cells was not increased due to the fact that these terminal cell divisions were accompanied by the slow death of some cells. Secondly, the chromatin granules or nucleoids in cells so treated were distinctly enlarged and stained more deeply than in normal cells. Thirdly, exposure of bacterial suspension in buffer to low temperature caused synchronization of growth. The synchronous growth of bacteria after cooling

in buffer is shown in Table IV. The synchronization of growth was not quite unexpected, as there is ample evidence of the effects of starvation and variation in temperature on this process (Scherbaum and Zeuthen, 1954; Lark and Maaløe, 1954; Hotchkiss, 1954; Barner and Cohen, 1955; Hunter-Szybalska, Szybalski and DeLamater, 1956; Maruyama and Yanagita, 1956).

Table IV
SYNCHRONIZATION OF GROWTH OF *Esch. coli* AFTER STARVATION
AND COOLING

<i>Time intervals (minutes)</i>	<i>Division per cell during interval</i>	<i>Time intervals (minutes)</i>	<i>Division per cell during interval</i>
0-20	0	136-150	0.03
21-40	0	151-165	0.36
41-60	0	166-180	0.00
61-80	0.05	181-195	0.97
81-100	0.07	196-210	0
101-120	0.28	211-225	0
121-135	0.04	226-245	0.92

What is the mechanism of the development of streptomycin resistance in bacteria in the above experiments? Induced mutation in a total population may seem to have been excluded. The results obtained, i.e. absence of specifically inducing agent and the conditions unfavourable for growth and synthesis of cell material, suggest that the "automatic adjustment" of Hinshelwood (1946, 1953) is not operating in this case.

The synchronous growth is probably accompanied by transient polyploidy. The normal cytological pattern of the cells is, however, restored much earlier than the streptomycin-sensitivity state. Polyploidy could be then only a contributing factor, operating in the early stages of phenotypic change.

It is perhaps relevant here to recall some examples of converting a large percentage of microbial cells by treatments

not involving cell multiplication (Rotman and Spiegelman, 1953; Spiegelman, Sussman and Pinska, 1950; Campbell and Spiegelman, 1956). The results of Spiegelman's research were explained by assuming that new variants contained particles necessary for enzyme formation, which were either lacking or in insufficient numbers in negative, parental cells.

For an explanation of the development of streptomycin resistance in *Esch. coli* a similar mechanism is assumed. Some, at present hypothetical, cytoplasmatic units whose nature is now irrelevant for us, could be related to streptomycin resistance. If the number of these units per cell is below a certain level, the cell is susceptible to the drug action. If the number of these units increases over a certain threshold, cells become resistant due to the possibility of accumulation of some metabolites, or alternatively of bypassing the biochemical pathway sensitive to the drug or by another of the possible mechanisms discussed by Davis (this symposium, p. 165).

There is some evidence, at present not yet fully documented, supporting this assumption. Firstly, the stability of resistance and the rate of the appearance of sensitive cells in media not containing the drug is influenced by the temperature of incubation. In some temperature ranges the process of reversion is relatively rapid, in others it is distinctly retarded. Secondly, the induction of resistance by cooling depends on the physiological state of examined cells. It is inhibited in initially starved cells, and its pattern is different in cells harvested from nutrient broth (bacteria rich in metabolites) and from synthetic medium (cells rich in enzymes). The results of these experiments after their completion will be the subject of future publications. Nevertheless, this hypothesis, with no evidence against it, and some observations supporting it, seems to be a convenient basis for further research.

It is assumed that genotypic change is, in our case, superimposed on a phenotypic one. Incubation in phosphate buffer at low temperature would then result in increase of the

number of hypothetical cytoplasmatic units, making genotypically drug-sensitive cells appear phenotypically drug-resistant. These resistant cells, when transferred to a medium containing streptomycin, can grow and form clones big enough to permit the appearance of genotypically resistant mutants.

This may be an example of a third mechanism, besides spontaneous mutations and directed adaptations, operating in the evolution of new forms. In this mechanism an external factor causes the semi-stable physiological change, having no adaptive value in relation to the acting agent. If the environment of organisms is then changed, their new character may have by chance an adaptive value and thus may increase greatly the possibility of the formation of respective mutants. It is not impossible that these processes may lead to changes temporarily decreasing the resistance of bacteria to drugs, thus helping the macro-organism in eliminating the initially drug-resistant germs.

REFERENCES

- AKIBA, T. (1955). *In* Origins of Resistance to Toxic Agents, p. 82, Ed. Sevag, M. G., Reid, R. D., and Reynolds, D. E. New York: Academic Press.
- ARNDT, W., and ZINDER, N. (1956). *Microb. Genet. Bull.*, No. 14, p. 5.
- BARNER, H. D., and COHEN, S. S. (1955). *Fed. Proc.*, **14**, 177.
- BORNSCHEIN, H., DITTRICH, W., and HÖHNE, G. (1951). *Naturwissenschaften*, **38**, 383.
- BRYSON, V., and SZYBALSKI, W. (1952). *Science*, **116**, 45.
- CAMPBELL, A. L., and SPIEGELMAN, S. (1956). *C.R. Lab. Carlsberg, Sér. physiol.*, **26**, 13.
- CAVALLI-SFORZA, L. L., and LEDERBERG, J. (1953). *VI Int. Congr. Microbiol.*, p. 108.
- DEMEREK, M. (1945). *Proc. nat. Acad. Sci. Wash.*, **31**, 16.
- DEMEREK, M. (1948). *J. Bact.*, **56**, 63.
- HINSHELWOOD, C. N. (1946). *The Chemical Kinetics of the Bacterial Cell*. Oxford University Press.
- HINSHELWOOD, C. N. (1953). *J. chem. Soc.*, p. 1947.
- HOTCHKISS, R. D. (1954). *Proc. nat. Acad. Sci., Wash.*, **40**, 49.
- HUNTER-SZYBALSKA, M. E., SZYBALSKI, W., and DELAMATER, E. C. (1956). *J. Bact.*, **71**, 17.
- GALE, E. F. (1949). *Symp. Soc. exp. Biol.*, **3**, 233.
- LARK, K. G., and MAALØE, O. (1954). *Biochim. biophys. acta*, **15**, 345.

- LEDERBERG, J., and LEDERBERG, E. M. (1952). *J. Bact.*, **63**, 399.
- MARUYAMA, J., and YANAGITA, T. (1956). *J. Bact.*, **71**, 542.
- NEWCOMBE, H. B. and HAWIRKO, R. (1949). *J. Bact.*, **57**, 565.
- ROTMAN, B., and SPIEGELMAN, S. (1953). *J. Bact.*, **66**, 492.
- SCHERBAUM, O., and ZEUTHEN, E. (1954). *Exp. Cell. Res.*, **6**, 221.
- SPIEGELMAN, S., SUSSMAN, R., and PINSKA, E. (1950). *Proc. nat. Acad. Sci., Wash.*, **36**, 591.
- SZYBALSKI, W. (1955). *Antibiotics Annual, 1954-55*, p. 576. New York: Med. Encycl. Inc.
- SZYBALSKI, W. (1956). *Microb. Genet. Bull.*, No. 14, p. 6.

DISCUSSION

Yudkin: Part of the explanation of these results may be that it is the same sort of phenomenon as that which we have found with *Esch. coli*, with proflavine resistance. If we assume that in Prof. Kunicki-Goldfinger's experiment, during the actual cooling in buffer the cells reach a stage of synchronization, and if we assume that there is a change in the resistance to streptomycin, as to proflavine, at different times during division then it may be that the increase in resistance on taking the cells from the cooled buffers expresses the resistance at a particular stage in the resistance cycle.

Kunicki-Goldfinger: I cannot agree with that, because you can obtain synchronization of growth after a few hours of cooling, whereas the increase in resistance is obtained only after very many hours; after 24 hours this increase is not yet complete. There is no correlation in time between this phenomenon of synchronization and the increase in the number of resistant cells.

Yudkin: How did you test for synchronization?

Kunicki-Goldfinger: By direct observation of the time of division of 500 cells on the surface of the agar. A long time was needed for these observations, but I think that they are convincing.

Yudkin: The degree of synchronization is extremely high, much higher than has ever been previously reported.

Kunicki-Goldfinger: It is very high. The first and the second division are not quite synchronized.

Yudkin: That too is unusual, because in general the degree of synchronization falls very rapidly.

Stocker: Perhaps this elegantly investigated phenomenon is one example of a general phenomenon which the geneticists usually ignore, because it is inconvenient. If we compare the logarithmic phase cells (i.e. cells growing in a rich medium) with resting phase cells (i.e. starved cells) we know they differ phenotypically in their resistance to penicillin and in a variety of other characters. It is commonly assumed, as a first approximation, that we can regard all populations of cells in exponential growth as being similar, regardless of whether they have been in exponential growth for some generations or whether they have only recently come back into exponential growth. One has encountered evidence that this is certainly not the case in particular instances; for instance, with

Salmonella it has been observed in my laboratory that on being put back into broth at 37°, after having been kept at 4° for many hours, *Salmonella* cells may for several generations grow in chains, like a rough organism, although on subculture they return to their original form, growing in short rods (Rogers, H. J. (1957), *J. gen. Microbiol.*, 16, 22). It has been shown that staphylococci, taken from a fully grown broth culture and allowed to come back into exponential growth in broth, began to synthesize hyaluronidase; but it took about eleven generations of exponential growth before they reached a steady-state of enzyme secretion per cell per generation. Something similar might be involved here perhaps.

Alexander: There is some very good evidence from radiation experiments which supports Prof. Kunicki-Goldfinger's view that on cooling cells the various physiological processes are not all slowed down to the same extent, so that by keeping them cold one can get a change in the biochemical make-up of the cell. This was first shown by Hollaender, who found that on irradiation of a cell two competitive processes occur, both of which are physiological: the development of the injury and the repair processes. Hollaender found that by storing cells, after irradiation, at a low temperature he was able to increase greatly the number of survivors, because these two competitive processes were not affected to the same extent by temperature. This is known for many other systems. I wonder whether keeping them as low as 4° might not be too low, because in his experiments Hollaender got the best recoveries when he kept them between 12° and 18°.

Kunicki-Goldfinger: At 10° we got rather similar results, but the increase was smaller.

Lederberg: Contrary to the expectations that have been expressed, the shift from the cold-induced state to the normal appeared not to occur during exponential growth, but only during the saturation stage of the culture. Has that been systematically investigated, using different periods of exponential growth, to see whether the shift back to sensitivity occurred at different intervals, depending on the duration of the log phase?

Kunicki-Goldfinger: This has not been done.

Lederberg: I would suggest that you have here a persistent effect of Dauermodifikation, which is so far without clear precedent for bacteria, certainly not for *Esch. coli* K 12. It might be feasible to use a form of genetic analysis for the investigation of the difference between them.

Kunicki-Goldfinger: We are preparing such an experiment now.

Davis: Do you know whether keeping cells for a relatively long period in the stationary phase will have much effect on phenotypic streptomycin resistance?

Kunicki-Goldfinger: No; the duration of experiments was only 72 hours.

Knox: Does freeze-drying have any effect?

Kunicki-Goldfinger: I have not tried that.

Györfly: We have carried out similar experiments with non-dividing *Serratia marcescens* cells. We used 20-hour cultures, washed repeatedly in phosphate buffer and then incubated in rolled tubes overnight, and then

again washed in phosphate buffer and centrifuged; then resuspended in phosphate buffer in tubes in a series containing 12, 16, 24, 50 and 100 $\mu\text{g.}$ of streptomycin per ml. In another series we did just the same but instead of phosphate buffer we used saline. The tubes were kept at room temperature. Samples were taken at 5- or 6-day intervals, and the screen level was the same as the incubation concentration of streptomycin. Over a 2-week period the number of cells remained practically the same in the tubes containing 12, 16 and 24 $\mu\text{g.}$ of streptomycin per ml. A slight but steady killing was observed in the tubes with 50 $\mu\text{g./ml.}$ and a quite marked decrease in the fraction surviving occurred in the tubes with phosphate buffer containing 16 $\mu\text{g.}$ streptomycin per ml. after 5 days, and also in the tubes containing 24 $\mu\text{g./ml.}$ after 10 days; but no increase in the survival fraction was observed in the series where saline was used instead of phosphate buffer. We did not retest, and so we do not know whether these survivors are stable variants with a low degree of resistance or only persistors. It may be that this survivor fraction was only an accumulation of persistors, i.e. the plus variants on the range up to the upper limit of the phenotypic variability of the original sensitive genotype were increased. Some multiplication may have occurred also in the tubes where we used phosphate buffer, because after autolysis of some cells phosphate was present also, and perhaps such an equilibration resulted in no change in the total number of cells. No multiplication could occur, however, in saline, and so we could observe no increase in the survival fraction. A tendency of the survival fraction to increase also occurred in some of the tubes containing 50 and 100 $\mu\text{g./ml.}$, both in phosphate buffer and in saline. I think, however, that this increase is deceptive, because there was a decrease in the total number of the cells and therefore we got a proportionately higher survival fraction. It may be concluded from these observations that in no case did we obtain such a high proportion of induced resistants as was reported by Akiba and by Szybalski; and even before Szybalski published a correction of his early conclusions we were of the opinion that, at least in the case of *Serratia marcescens*, under our experimental conditions there is no "Lamarekian" inheritance of streptomycin resistance.

Kunicki-Goldfinger: I would suggest trying a shorter incubation period. You have incubated your bacteria for 7 or 14 days, whereas 24-25 hours incubation should be enough. After so long incubation more cells are dying and the number of surviving cells is greatly diminished.

Slonimski: Rizet and Marcou (1957, *Microbiology*, in press), working with the filamentous fungus *Podospora anserina*, obtained interesting results on the effect of cooling. Several strains of this fungus are bound to die if reproduced vegetatively. It is necessary to outcross them to keep them. However, if a strain having a vegetative life expectancy of say 2 days at 25° is maintained for a while at 2°, its life expectancy (at 25°) is increased to some 60 days. The kinetics of rejuvenation have been partially worked out; it depends on the duration, temperature and genetic constitution of the strain.

DRUG RESISTANCE OF STAPHYLOCOCCI WITH SPECIAL REFERENCE TO PENICILLINASE PRODUCTION

MARY BARBER

St. Thomas's Hospital Medical School, London

PENICILLIN-RESISTANT strains of staphylococci are many and varied. According to their response to the antibiotic they fall into three distinct groups: (1) drug-tolerant, (2) drug-dependent and (3) drug-destructive. Organisms of the first group are capable of growing in the presence of an increased concentration of the antibacterial agent, which remains unchanged and retains full activity for other bacteria; the growth of organisms of the second group is actually favoured by or even completely dependent on the presence of the antibiotic; organisms of the third group produce an antagonist which inactivates the antibiotic. Penicillin-tolerant and penicillin-dependent strains occur in *in vitro* studies; penicillin-destroying strains, on the other hand, are the cause of penicillin-resistant staphylococcal infection.

Penicillin-tolerant strains are isolated with great frequency when penicillin-sensitive staphylococci are passaged in the presence of penicillin *in vitro* (Barber, 1953*a*). The increase in resistance to penicillin occurs gradually and is lost in a similarly gradual fashion if the strain is passaged in the absence of penicillin. Resistant strains of this type usually show morphological variations and an increase in the lag phase of growth; on solid medium they often yield tiny semi-transparent colonies (Barber, 1953*a* and *b*). They are also deficient in coagulase and α -toxin production and, probably for this reason, are of lowered virulence (Rake *et al.*, 1944; Spink, Ferris and Vivino, 1944; Blair, Carr and Buchanan,

1946), and are thus of little significance in infective processes. The gradual development and loss of resistance, together with the extreme morphological variations seen in the early stages, suggest that physiological adaptation may play some part in the origin of penicillin-tolerant strains.

Penicillin-dependent staphylococci are encountered quite frequently in association with penicillin-tolerant strains when penicillin-sensitive staphylococci are passaged in penicillin *in vitro*. They show similar changes in morphology, cultural characteristics and virulence, but owing to their extreme instability are difficult to study. The concentration of penicillin necessary for optimal growth is variable, but often approximates to the minimal inhibitory concentration for growth of the parent strain. There is no detectable loss of penicillin in the surrounding medium after growth of a penicillin-dependent strain (Barber, 1953*a* and *b*). Jackson (1953) showed that growth of a penicillin-dependent strain of staphylococcus was inhibited by traces of oleate in the culture medium, and that if this were removed by shaking the medium with a fat-solvent, the strain ceased to be penicillin-dependent. He thus concluded that penicillin in some way protected the strain against the toxicity of oleate.

Penicillin-destructive strains are the almost invariable cause of penicillin-resistant staphylococcal infection (Kirby, 1944; Spink, Hall and Ferris, 1945; Bondi and Dietz, 1945; Gots, 1945; Barber and Rozwadowska-Dowzenko, 1948; Martyn, 1949; Forbes, 1949; Barber and Whitehead, 1949). They resemble penicillin-sensitive strains of staphylococci in all respects except the capacity to produce an enzyme, penicillinase, which inactivates penicillin (Barber, 1947). Resistance of this type is comparatively stable, but when subcultured *in vitro* penicillin-destroying strains tend to yield an increasing proportion of variants which have completely lost the capacity to produce penicillinase, and are as sensitive to penicillin as the Oxford staphylococcus (Barber, 1949; Bondi, Kornblum and Phalle, 1953; Fairbrother, Parker and Eaton, 1954).

Production of penicillinase by staphylococci

Kirby (1944) first extracted a potent penicillin inactivator from 7 strains of *Staphylococcus aureus*, which he referred to as "naturally resistant" since they had all been derived from patients who had not received penicillin. In the following year, Bondi and Dietz (1945) showed that all of 16 "naturally resistant" strains of staphylococci produced a penicillin inactivator, whereas in a previous study (Bondi and Dietz, 1944) they had shown that staphylococci which had acquired resistance to penicillin *in vitro* did not. In the same year Gots (1945) found that all of 53 penicillin-resistant strains of *Staph. aureus* isolated from patients produced a penicillin inactivator, and concluded that there was a difference in the mechanism of development of "*in vitro* acquired resistance and *in vivo* acquired resistance".

The properties of this penicillin inactivator were studied by Kirby (1945) who extracted it by the acetone-ether method used by Harper (1943) to obtain cell-free penicillinase from paracolon bacilli. He compared the product thus isolated from penicillin-resistant *Staph. aureus* with the penicillin-destroying enzymes isolated by Abraham and Chain (1940) from *Bacterium coli* and an unidentified Gram-negative rod, and by Harper (1943) from a paracolon bacillus, and regarded the differences as superficial.

Kirby (1945) regarded staphylococcal penicillinase as an intracellular enzyme which was not liberated into the culture fluid. Many subsequent workers agreed that staphylococcal penicillinase was closely bound to the cells (Spink and Ferris, 1947; Gilson and Parker, 1948; Czekalowski, 1950), but Housewright and Henry (1947) recorded one strain of *Staph. aureus* from which cell-free penicillinase could be isolated, and Gots (1945) and Luria (1946) found penicillinase activity in culture supernatants. Recently, Eriksen and Hansen (1954) have reported the production of extracellular penicillinase by 8 strains of *Staph. aureus*. When overnight broth cultures of these strains were filtered through gradocol mem-

branes with an average pore diameter of 0.68μ , the filtrates were found to have considerable penicillin-destroying activity, although less than (in one experiment seven-tenths) that of unfiltered cultures. Although the enzyme could be refiltered through gradocol membranes without loss of activity it was adsorbed onto Seitz, Berkefeld and glass filters.

The resistance to penicillin exhibited by penicillinase-producing staphylococci appears to be almost entirely due to the enzyme. Individual cells of these strains have a sensitivity to penicillin similar to or slightly less than that of typical penicillin-sensitive cultures. The degree of resistance, therefore, depends on the amount and rate of penicillinase production, and in laboratory tests may vary many hundred-fold according to the size of inoculum used (Luria, 1946; Barber, 1947; Gilson and Parker, 1948; Bondi and Dietz, 1948; Barber and Whitehead, 1949).

The production of penicillinase by staphylococci is inhibited by sub-bacteriostatic concentrations of sodium azide, but this agent does not inactivate the cell-free enzyme (Dietz and Bondi, 1948). The enzyme itself is inhibited "at least temporarily" by 1 per cent sodium benzoate or sodium sulphathiazole (Reid, Felton and Pitroff, 1946). Staphylococcal penicillinase is very sensitive to high temperatures, and Bondi, Kornblum and Phalle (1953) and Fairbrother, Parker and Eaton (1954) found that growth at 44° accelerated the natural tendency of penicillinase-producing staphylococci to yield penicillin-sensitive variants.

Penicillinase from certain bacteria has been shown to be antigenic. Perlstein and Liebmann (1945*a* and *b*) inoculated rabbits with a cell-free preparation of penicillinase from an unidentified Gram-negative bacillus, and obtained an anti-serum which inhibited the action of the enzyme against penicillin. Housewright and Henry (1947) found that a rabbit anti-serum prepared against penicillinase isolated from a strain of *Bacillus cereus* inhibited the action of penicillinase from a strain of *Staph. aureus* as well as from *B. cereus*, and concluded that the two enzymes were immunologically

similar. This finding has not been confirmed and is rather surprising, since Manson, Pollock and Tridgell (1954) found that penicillinase from *B. cereus* was immunologically unrelated to penicillinase from *Bacillus subtilis*.

Current views on the mode of origin of penicillinase-producing staphylococci

Enzyme adaptation. Most people do not regard contact with penicillin as an important factor in the mode of origin of penicillinase-producing staphylococci. In the early days of penicillin therapy such strains were usually isolated from patients who had never had penicillin, and passage of penicillinase-producing strains in the presence of penicillin *in vitro* causes little or no increase in the production of the enzyme (Bondi *et al.*, 1954). Thus, unlike the penicillinase of *B. cereus* (Pollock, 1950, 1953), staphylococcal penicillinase is not usually regarded as an adaptive enzyme.

Selection. In hospitals and other institutions where the use of penicillin is widespread, selection of a few penicillin-destroying strains and the dissemination of these has been shown to be the main reason for the increasing incidence of penicillin-resistant staphylococcal infection (Barber and Rozwadowska-Dowzenko, 1948; Barber and Whitehead, 1949; Rountree and Thomson, 1949). In early studies of this kind there was a clear association between penicillinase production and bacteriophage group. Thus, in 1949, Barber and Whitehead in England and Rountree and Thomson in Australia found that most of the strains isolated from penicillin-resistant infection belonged to phage-group III. Later penicillinase-producing strains of phage-group I became common, particularly in Maternity Units (Barber, Hayhoe and Whitehead, 1949; Barber and Burston, 1955), and today they are found among all phage-groups (Anderson and Williams, 1956).

Spontaneous mutation. Whatever the importance of selection in the incidence of penicillin-resistant infection, it does

not explain the existence of staphylococci with and without the capacity to produce penicillinase. A commonly held view is that this is the result of spontaneous mutation. The sudden emergence from penicillinase-producing staphylococci of cells which have completely lost the capacity to produce the enzyme has been clearly and unequivocally demonstrated, and in a manner which suggests spontaneous mutation (Barber 1949; Bondi, Kornblum and Phalle, 1953; Fairbrother, Parker and Eaton, 1954).

Most investigators, however, have failed to demonstrate penicillin-sensitive staphylococci which have gained the capacity to produce penicillinase in *in vitro* studies (Bondi and Dietz, 1944; Blair, Carr and Buchanan, 1946; Spink and Ferris, 1947; Barber, 1956). Spink and colleagues (Spink, Hall and Ferris, 1945; Spink and Ferris, 1947) and Blair, Carr and Buchanan (1946) claim that such a change may be induced *in vivo* by penicillin treatment, but since in neither case were the strains phage-typed it is possible that they were dealing with mixed infections due to penicillin-sensitive and penicillin-resistant strains of different phage-types, which Barber and Whitehead (1949) have shown to be a common occurrence. Penicillin-sensitive and penicillin-resistant strains of the same phage-type have been isolated from a single specimen of pus (Barber and Whitehead, 1949; Fairbrother, Parker and Eaton, 1954), but this is probably due to the instability of the penicillin-resistant strain, and does not indicate a mutation from penicillin sensitivity to penicillinase production.

It is quite possible that penicillin-sensitive staphylococci do yield penicillinase-producing variants, but the change must be a rare one, and until its occurrence can be unequivocally demonstrated it is impossible to be dogmatic about the mode of origin of such variants.

Most workers have assumed that the penicillin-sensitive staphylococcus is the original type and the penicillin-destroying strain the mutant, but Fairbrother (1956) suggests that the reverse is more likely. He points out that under "wild conditions" penicillinase might well assist the staphylococcus

in survival of the species, but when the staphylococcus became established in the human nares, until the onset of penicillin therapy, penicillinase would be of no service and the capacity to produce the enzyme might, therefore, have declined. Although discussion of this type is somewhat reminiscent of the argument about the hen and the egg, there is much to be said for Fairbrother's point of view.

Experimental attempts to isolate penicillin-destroying variants from penicillin-sensitive strains of *Staph. aureus*

When a penicillin ditch-plate is flooded with a penicillin-sensitive strain of *Staph. aureus*, there is an almost straight line of inhibition after 24 hours' incubation (Fig. 1*a*), although resistant colonies are often seen in the zone of inhibition if the cultures are incubated for 4–8 days. When, however, a gradient plate (Szybalski, 1953) is similarly treated, a large variety of resistant colonies are seen even after 24 hours' incubation (Fig. 1*b* and *c*). This difference is no doubt due to the fact that penicillin gradient plates have a much larger area of medium containing a concentration of penicillin only just above the minimal bacteriostatic level than do penicillin ditch-plates. Nevertheless, in experiments involving 26 penicillin-sensitive strains of *Staph. aureus*, the present author has failed to isolate penicillin-destroying cultures by flooding gradient plates with a thick emulsion of bacteria, although the presence of as small a proportion as one penicillinase-producing staphylococcus to 10 million penicillin-sensitive cells can be readily demonstrated by such means (Fig. 1*d*).

Staphylococci with very weak penicillin-destroying activity, however, have been isolated by cultivating penicillin-sensitive strains of *Staph. aureus* for very long periods in very low concentrations of penicillin. Initially the penicillin-sensitive strains were inoculated into fluid medium containing 0·005–0·01 μ /ml. penicillin. At long intervals (one or more weeks) these were transferred to further broth tubes

containing the same amount of penicillin and plated out on ditch-plates. The latter were incubated for 7–8 days, when it was frequently noted that there was a ridge of increased growth, in which case subcultures were made from this into similar fluid medium.

Penicillin-destroying activity was tested at intervals by growing the cultures in the presence of larger amounts of penicillin and testing for penicillin activity after various periods of incubation by the agar-cup method. After over two months of passage, two strains—the Oxford staphylococcus and a penicillin-sensitive mutant (D3S) derived from a penicillinase-producing culture—yielded staphylococci with very weak penicillin-destroying activity. By further transfer in penicillin broth ($0\cdot01 \mu/\text{ml.}$) and selection of likely colonies from penicillin ditch-plates this activity was increased, but even after more than a year the penicillin-destroying capacity of these strains was less than one-hundredth that of a typical penicillin-resistant culture of *Staph. aureus* isolated from an infective process.

Characteristics of penicillin-destroying cultures isolated *in vitro* from two strains of penicillin-sensitive *Staph. aureus*

Penicillin-destroying activity. After 2·5 months, strains were isolated from both the Oxford staphylococcus and D3S which inactivated 2–5 $\mu/\text{ml.}$ penicillin in a week, but not in 48 hours. After 8 months, 2 $\mu/\text{ml.}$ penicillin was inactivated in 3 hours by a strain isolated from the Oxford staphylococcus; and in 24, but not in 3, hours by one from D3S. After 16 months, 2 $\mu/\text{ml.}$ penicillin was inactivated by cultures from both parent strains in one hour, and 20 $\mu/\text{ml.}$ was inactivated in 3 hours by two strains derived from the Oxford staphylococcus; and in 24, but not in 3, hours by two from D3S. Under similar experimental conditions, clinically isolated penicillin-resistant strains inactivated from 100 to 500 $\mu/\text{ml.}$ penicillin in less than one hour.

Associated changes. The penicillin-destroying variant cultures all grew less luxuriantly than the parent strains and yielded small opaque colonies on nutrient agar. The variants isolated from the Oxford staphylococcus showed little or no coagulase or α -toxin activity and were not typable by bacteriophage. Those isolated from D3S had lost the capacity to produce coagulase or α -toxin, but were weakly lysed by some, but not all, of the phages lysing the parent strain.

Appearance on ditch-plates. A comparison of these variants with a typical penicillinase-producing strain of *Staph. aureus* was made by examining penicillin ditch-plate cultures after 24 hours' and 7-8 days' incubation (Figs. 2-7). Fig. 2 shows a plate with the Oxford staphylococcus on one side and an active penicillinase-producing strain (D3R) on the other. It will be seen that after 24 hours the Oxford staphylococcus shows an almost straight line of inhibition, but growth is semi-transparent and fades away as the level of penicillin becomes bacteriostatic. After 7 days' incubation, the area of semi-transparent growth is larger. With D3R, on the other hand, penicillin sensitivity increases as the inoculum becomes smaller by plating out, and growth becomes more luxuriant as the concentration of penicillin increases. Thus the heaviest growth is seen at the edge, just before the level of penicillin is too high to have been neutralized by the penicillinase of the culture and is, therefore, inhibitory.

Fig. 3 shows a plate with on one side a penicillin-destroying culture derived from the Oxford staphylococcus after 8 months and on the other the parent strain. It will be seen that the variant culture grows more closely to the ditch than the parent, and shows an area of semi-transparent growth immediately preceded by a ridge of increased growth. After 7 days of incubation, the ridge is very marked and a few large opaque colonies are also seen at the edge of the semi-transparent growth. This appearance was quite frequent during these experiments and suggested the development of penicillin-destroying variants at the site of the ridge, while the semi-transparent growth consisted of cells showing only an

increased drug-tolerance. From such plates, therefore, sub-cultures were taken from the area of increased growth.

Fig. 4 shows a more active penicillin-destroying culture isolated from the Oxford staphylococcus after more than 12 months. It will be seen that after 24 hours of incubation colonies of the variant strain are smaller than those of the parent culture, but after 7 days the reverse is the case. The resistance, except in degree, resembles that of a typical penicillinase-producing strain.

Figs. 5 and 6 show variants derived from D3S, after 8 or more than 12 months respectively, on one side, and the parent culture on the other. The resistance of the two variant cultures is similar, except in degree, and with the same reservation resembles that of D3R. Again it will be seen that the colonies of the variant strains are smaller than those of the parent after 24 hours of incubation, but larger after 7 days.

Finally, Fig. 7 shows a ditch-plate on which a number of overnight broth cultures have been streaked at right-angles to the ditch. The top three are typical penicillinase-producing strains and the next two are penicillin-sensitive; streak 6 is a semi-transparent penicillin-tolerant staphylococcus; streaks 7-10 are weakly penicillin-destroying strains isolated from the Oxford staphylococcus (7 and 9) and D3S (8 and 10). The penicillin-destroying strains show thick luxuriant growth at the penicillin end of the streak, whereas growth of the penicillin-sensitive and penicillin-tolerant strains fades away as the concentration of penicillin becomes bacteriostatic.

Conclusions

Staphylococci with weak penicillin-destroying activity have been isolated from two penicillin-sensitive strains of *Staph. aureus* after prolonged exposure to penicillin. Whether this be due to a penicillinase similar to that of strains isolated from cases of penicillin-resistant infection remains to be determined. At present the two types of resistant culture differ in

that the laboratory strains show an associated diminution in growth rate and coagulase and α -toxin production, and have a lower order of resistance.

The loss in properties usually associated with pathogenicity may be a laboratory phenomenon, which would not occur *in vivo*. It may, however, be of greater significance. Staphylococcal infections have sometimes yielded penicillin-sensitive *Staph. aureus* in association with penicillinase-producing staphylococci which are coagulase-negative. Moreover, Rountree (1956) studied staphylococci isolated from the anterior nares of 120 people in the Wabag region of New Guinea, an area where penicillin has not yet been widely used, and found that none of 23 strains of *Staph. aureus* was resistant to penicillin, whereas 18 out of 110 coagulase-negative staphylococci were penicillinase producers.

Although, at present, the strains isolated in the laboratory have only very weak penicillin-destroying activity this has increased during the course of the experiments, and with further prolonged exposure to penicillin might approach that of the clinically isolated strains. If so, our views on the mode of origin of penicillin-resistant staphylococcal infection may need modification. Sub-bacteriostatic concentrations of penicillin in the tissues or abscesses of patients treated with penicillin must be very common, and transfer of strains of *Staph. aureus* from patient to patient where this is the case may well constitute a method of passaging strains in the presence of very small concentrations of penicillin, similar to those used in this study. It is also pertinent to note that penicillin-resistant staphylococcal infection was uncommon until the antibiotic had been in widespread use for several years.

It appears possible, therefore, that the penicillinase of staphylococci is an adaptive enzyme for the production of which very prolonged exposure to the substrate is necessary. Even if this is so, however, spontaneous mutation leading to the emergence of cells better able to produce the enzyme almost certainly takes place, and this, together with selection,

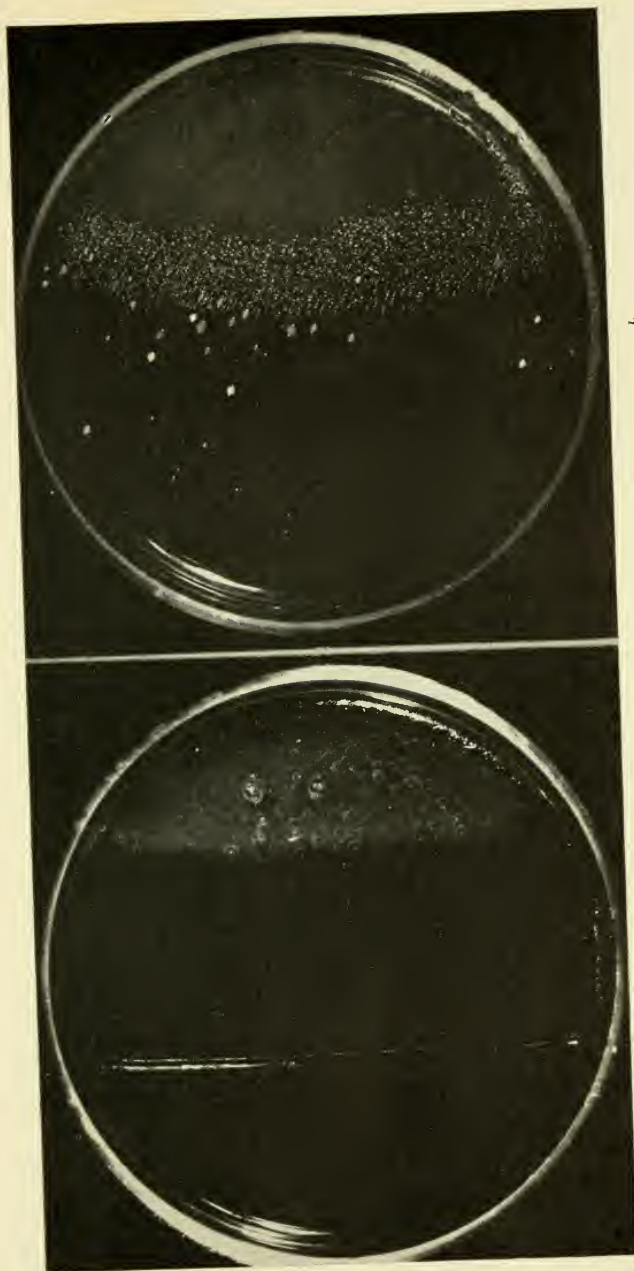

a } flooded with a broth culture of the Oxford
 b } staphylococcus and incubated at 37° for 24 hours.

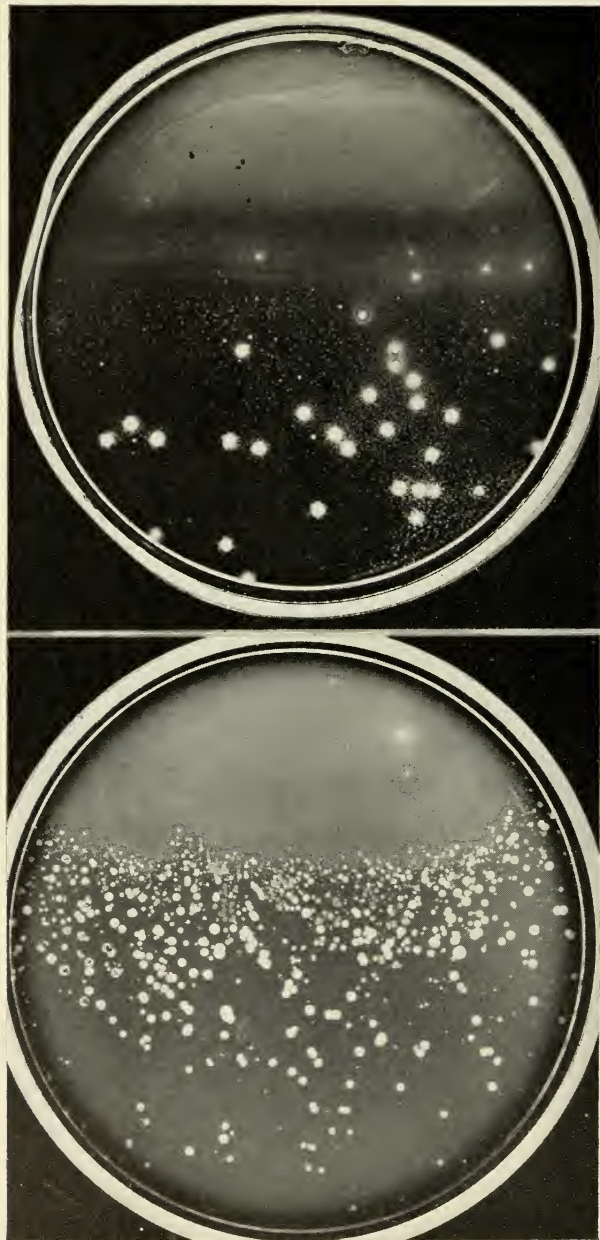

FIG. 1. *c*. Penicillin gradient plate flooded with a broth culture of a penicillin-sensitive strain of *Staph. aureus* and incubated for 48 hours.
d. Penicillin gradient plate flooded with broth containing a mixture of penicillinase-producing and penicillin-sensitive staphylococci in the proportion of 1 of the former to 10 million of the latter.

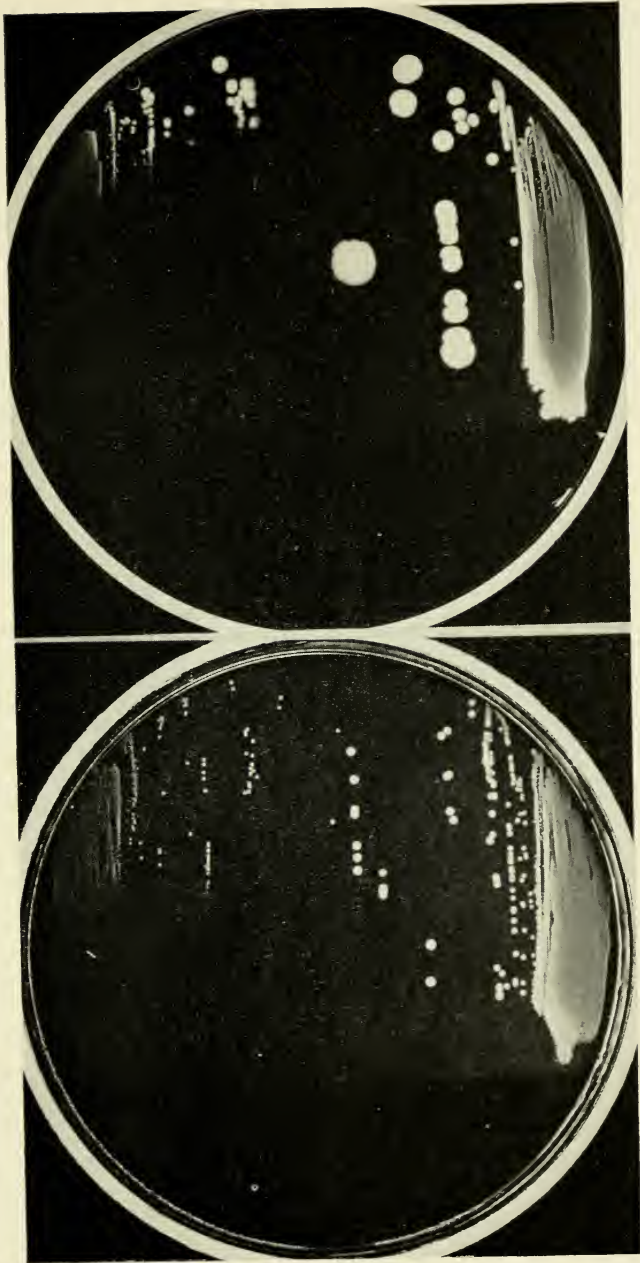
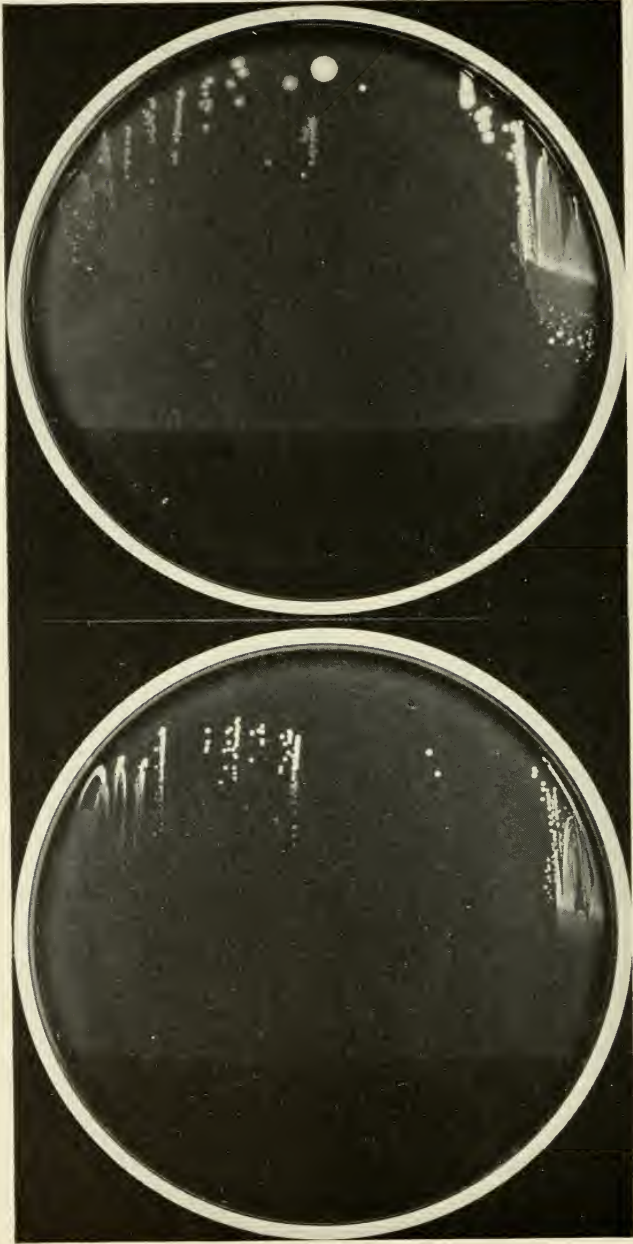

FIG. 2. Penicillin ditch-plates: upper half inoculated with the Oxford staphylococcus; lower half with a penicillinase-producing *Staph. aureus* (D3R). Plates incubated for 24 hours (a) and 7 days (b), respectively.



b

FIG. 3.

a

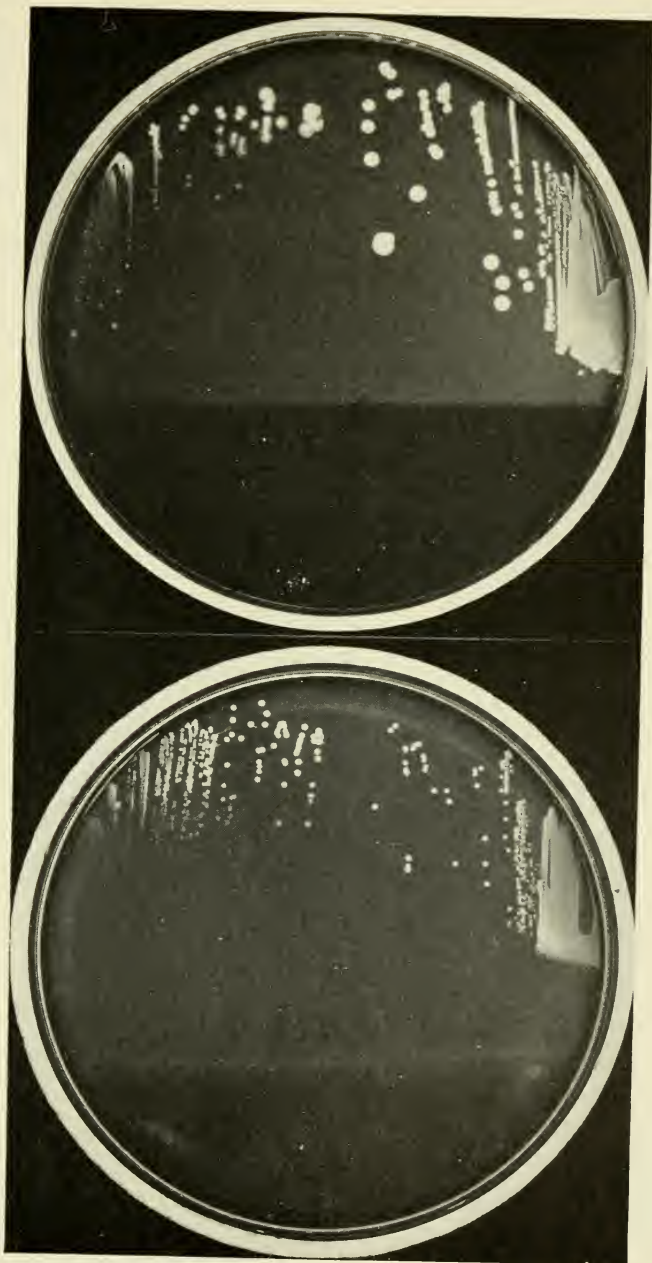

FIG. 4.

a

Figs. 3 and 4. Penicillin ditch-plates: upper half inoculated with the Oxford staphylococcus; lower half with a culture derived from it after 8 months' (Fig. 3) or 12 months' (Fig. 4) contact with penicillin. Plates incubated at 37° for 24 hours (*a*) and 7 days (*b*), respectively.

b

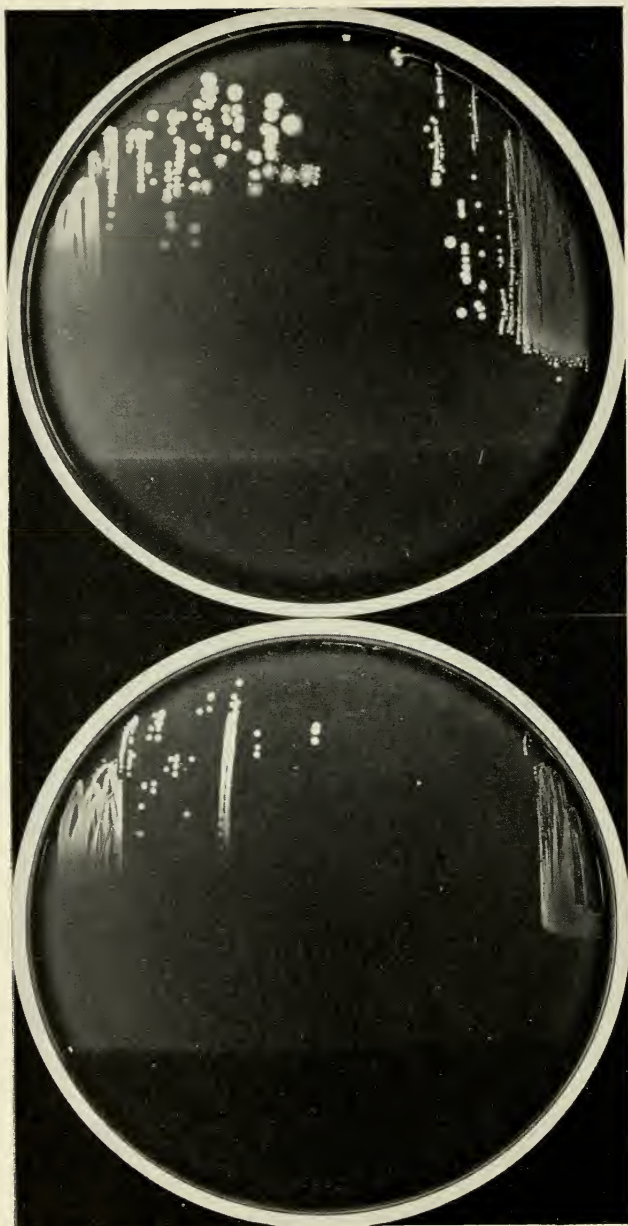

FIG. 5.

b

a



FIG. 6.

b

a

FIGS. 5 and 6. Penicillin dith-plates: upper half inoculated with a penicillin-sensitive strain of *Staph. aureus* (D38); lower half inoculated with a culture derived from it after 8 months (Fig. 5) or more than 12 months (Fig. 6). Plates incubated at 37° for 24 hours (a) and 7 days (b), respectively.

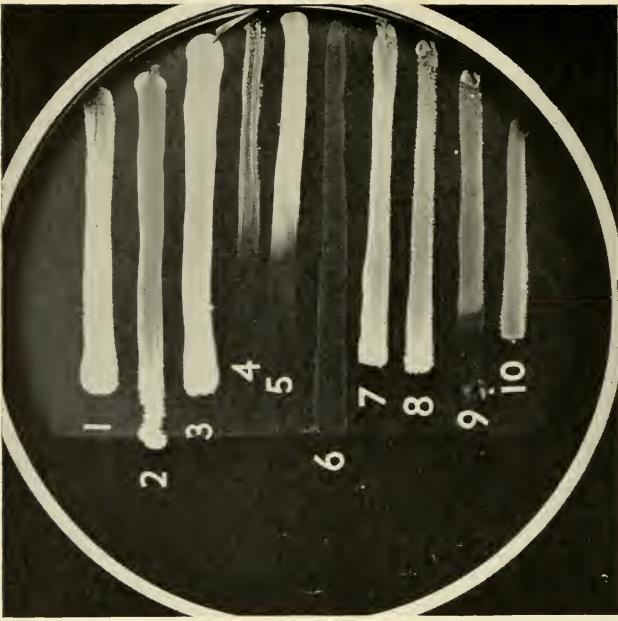
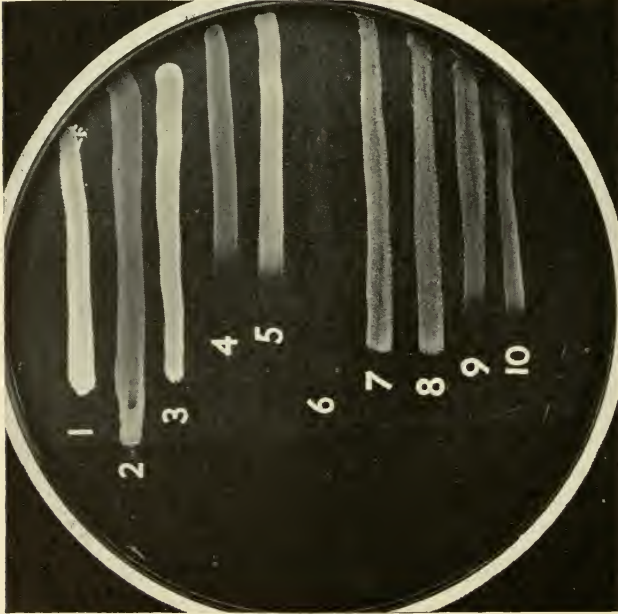

FIG. 7. Penicillin ditell-plates streaked with broth cultures of staphylococci of varying sensitivity to penicillin: 1, 2, 3 are typical penicillinase-producing strains; 4, 5 are the penicillin-sensitive cultures, Oxford staphylococcus and D3S; 6 is a penicillin-tolerant strain derived from the Oxford staphylococcus; 7, 8, 9, 10 are penicillin-destroying strains isolated from the Oxford staphylococcus (7 and 9) and D3S (8 and 10). Plates incubated for 24 hours (a) and 7 days (b), respectively.

may be the major factor in the production of penicillinase-producing staphylococci.

The term *Staph. aureus* is used throughout to denote coagulase-positive staphylococci, regardless of pigment production.

Acknowledgement

The author's thanks are due to Mr. A. L. Wooding for the photographs.

REFERENCES

- ABRAHAM, E. P., and CHAIN, E. (1940). *Nature, Lond.*, **146**, 837.
ANDERSON, E. S., and WILLIAMS, R. E. O. (1956). *J. clin. Path.*, **9**, 94.
BARBER, M. (1947). *J. Path. Bact.*, **59**, 373.
BARBER, M. (1949). *J. gen. Microbiol.*, **3**, 274.
BARBER, M. (1953a). *J. gen. Microbiol.*, **8**, 111.
BARBER, M. (1953b). *Symp. Soc. gen. Microbiol.*, **3**, 235.
BARBER, M. (1956). *J. gen. Microbiol.*, **14**, 111.
BARBER, M., and BURSTON, J. (1955). *Lancet*, **ii**, 578.
BARBER, M., HAYHOE, F. C. J., and WHITEHEAD, J. E. M. (1949). *Lancet*, **ii**, 1120.
BARBER, M., and ROZWADOWSKA-DOWZENKO, M. (1948). *Lancet*, **ii**, 641.
BARBER, M., and WHITEHEAD, J. E. M. (1949). *Brit. med. J.*, **2**, 565.
BLAIR, J. E., CARR, M., and BUCHANAN, J. (1946). *J. Immunol.*, **52**, 281.
BONDI, A., and DIETZ, C. C. (1944). *Proc. Soc. exp. Biol., N.Y.*, **56**, 135.
BONDI, A., and DIETZ, C. C. (1945). *Proc. Soc. exp. Biol., N.Y.*, **60**, 55.
BONDI, A., and DIETZ, C. C. (1948). *J. Bact.*, **55**, 843.
BONDI, A., KORNBLUM, J., and PHALLE, M. DE S. (1953). *Proc. Soc. exp. Biol., N.Y.*, **83**, 527.
BONDI, A., PHALLE, M. DE S., KORNBLUM, J., and MOAT, A. G. (1954). *Arch. Biochem.*, **53**, 348.
CZEKALOWSKI, J. W. (1950). *J. Path. Bact.*, **62**, 85.
DIETZ, C. C., and BONDI, A. (1948). *J. Path. Bact.*, **55**, 849.
ERIKSEN, K. R., and HANSEN, D. (1954). *Acta path. microbiol. scand.*, **35**, 169.
FAIRBROTHER, R. W. (1956). *Lancet*, **i**, 716.
FAIRBROTHER, R. W., PARKER, L., and EATON, B. R. (1954). *J. gen. Microbiol.*, **10**, 309.
FORBES, G. B. (1949). *Brit. med. J.*, **2**, 569.
GILSON, B. St. C., and PARKER, R. F. (1948). *J. Bact.*, **55**, 801.
GOTS, J. S. (1945). *Proc. Soc. exp. Biol., N.Y.*, **60**, 165.
HARPER, G. J. (1943). *Lancet*, **ii**, 569.
HOUSEWRIGHT, R. D., and HENRY, R. J. (1947). *J. Bact.*, **53**, 241.
JACKSON, L. (1953). *Symp. Soc. gen. Microbiol.*, **3**, 251.
KIRBY, M. M. (1944). *Science*, **99**, 457.
KIRBY, M. M. (1945). *J. clin. Invest.*, **24**, 170.

- LURIA, S. E. (1946). *Proc. Soc. exp. Biol., N.Y.*, **61**, 46.
- MANSON, E. D., POLLOCK, M. R., and TRIDGELL, E. J. (1954). *J. gen. Microbiol.*, **11**, 493.
- MARTYN, G. (1949). *Brit. med. J.*, **1**, 710.
- PERLSTEIN, D., and LIEBMANN, A. J. (1945a). *Science*, **102**, 174.
- PERLSTEIN, D., and LIEBMANN, A. J. (1945b). *Science*, **102**, 197.
- POLLOCK, M. (1950). *Brit. J. exp. Path.*, **31**, 739.
- POLLOCK, M. (1953). *Symp. Soc. gen. Microbiol.*, **3**, 150.
- RAKE, G., MCKEE, C. M., HAMRE, D. M., and HOUCK, C. L. (1944). *J. Immunol.*, **48**, 271.
- REID, R. D., FELTON, C., and PITROFF, M. A. (1946). *Proc. Soc. exp. Biol., N.Y.*, **63**, 438.
- ROUNTREE, P. M. (1956). *Lancet*, **i**, 719.
- ROUNTREE, P. M., and THOMSON, E. F. (1949). *Lancet*, **2**, 501.
- SPINK, W. W., and FERRIS, V., (1947). *J. clin. Invest.*, **26**, 379.
- SPINK, W. W., FERRIS, V., and VIVINO, J. J. (1944). *Proc. Soc. exp. Biol., N.Y.*, **55**, 210.
- SPINK, W. W., HALL, W. H., and FERRIS, V. (1945). *J. Amer. med. Ass.*, **128**, 555.
- SZYBALSKI, W., (1953). *Antibiot. Chemother.*, **3**, 915.

DISCUSSION

Pollock: If you simply grow the Oxford staphylococci or other penicillin-sensitive staphylococci in climbing concentrations of penicillin, you can train them to penicillin resistance without the formation of penicillinase. Now, in your technique you plated out the strain in a penicillin ditch plate and then subcultured from the edge. Was this into broth before a further subculture, or into penicillin broth?

Barber: Into broth with traces of penicillin, 0.005 units/ml.

Pollock: You weeded out cases which were resistant to an unknown cause and not to penicillinase?

Barber: Yes, but I did not find many; with that very small concentration of penicillin they are less frequent than with higher concentrations.

Lederberg: Have not you and Rountree both found that the penicillinase-producing strains are fairly characteristic, at least most of them of a single phage type?

Barber: That is not true any more, although it used to be the case. When penicillin-resistant infection first became a menace in hospitals, practically all penicillin-resistant strains were sensitive to phages of group 3. Later, as the process went on, penicillin-resistant strains of phage group 1 were isolated and now even group 2 strains may be penicillin-resistant so that penicillinase-producing staphylococci now encountered in clinical infection may be of any phage group.

Eagle: Many of us who work on the development of resistance under laboratory conditions are inclined to equate that phenomenon with the clinical problem. The inference is that there is a constant race between the development of new antibiotics and the development of resistance

in clinical practice. I believe this is, to say the least, debatable. As Dr. Barber has pointed out, this may be true for streptomycin and tuberculosis; it was probably true for sulphonamide and streptococcal or gonococcal infections. For the rest, however, originally sensitive bacterial species are not becoming resistant to antibiotics in consequence of chemotherapy. After ten years of intensive use, I don't know of a single documented instance of a penicillin-resistant group A streptococcus, pneumococcus, gonococcus or treponeme appearing as the result of treatment. The clinical problem is a very different one. It is the problem of treatment failure, rather than bacterial resistance: treatment failure due to a number of factors, and often unexplained, but not involving drug resistance in the sense that we have been discussing. Even the problem of penicillin-resistant staphylococcal infection, as Dr. Barber has pointed out, does not involve the development of resistance in a strain which was originally sensitive, but, rather, super-infection with a resistant strain prevalent in hospitals. This poses many problems with respect to the genesis and ecology of these penicillin-resistant staphylococci, and their survival value in competition with susceptible strains. These problems are, however, quite different from those under consideration these past few days.

Cavalli-Sforza: Visconti and Szybalski made experiments similar to those you have reported, Dr. Barber. Their point was similar to yours in that you cannot hope to recover penicillinase-producing mutants, except at the very borderline between the highest tolerated concentration and the lowest lethal one. Those workers seemed to get things which were producing a very decent amount of penicillinase.

Barber: In one experiment, Szybalski did get variants producing a fair amount of penicillinase, but he did no studies of phage typing of parent and child at the end. He got them on gradient plates, but did not publish details, with the exception that he said that these strains were producing large amounts of penicillinase. The phage type of these very rarely isolated colonies on gradient plates and the parent strains that they came from were not checked.

Cavalli-Sforza: I think it may be worth emphasizing that the effectiveness of selection for penicillinase-producers only at borderline concentrations has some relevance for the clinical aspects, because on superinfection you cannot usually expect large masses of superinfecting bacteria, but only few, a fact which makes the penicillin concentration even more critical, and therefore you are likely to get superinfection by the penicillinase-producing strains only when very small amounts of penicillin are in circulation.

Hayes: I would like to suggest a possible genetic model for what is happening in your system, Dr. Barber: you may have two mutations involved; mutation 1 would be a mutation to the constitutive production of small amounts of penicillinase; mutation 2 would determine the possibility of induction on the Pollock model in *B. subtilis*. Mutation 2 without mutation 1 is useless, because there is no base-line to work on. When you try to select for penicillinase-producing strains, there may be, in the population, a very small minority of cells which can constitutively

produce a small amount of penicillinase, but not enough to allow initiation of growth in the presence of penicillin, so that you may never find them. If you can, by prolonged subculture under your conditions, obtain a population of constitutive penicillinase producers (i.e. of mutation 1) then selection for mutation 2 from such a population may be possible. In the reverse way, you can lose mutation 1 in one mutational step, and mutation 2 cannot then express itself. Therefore, you may find quite a high reversion rate to something which although genotypically not identical with your wild-type strain, is identical in relation to penicillin.

Pollock: Are you suggesting that mutation 2 is a mutation from what I would call a microconstitutive strain to an inducible strain, i.e. a mutation from a strain that produces small quantities of enzyme, to one that produces a lot of it in the presence of, or after treatment with, the inducer?

Hayes: Yes.

Pollock: It is an interesting point that nobody has yet discovered a mutation in that direction.

Lederberg: I think that can happen, but it may be spurious. The Lac⁻ mutant of *Esch. coli* K 12 might fit that definition: it produces very small amounts without an inducer, and you can get reversions to the Lac⁺ which will produce large amounts. I do not believe that there is any fundamental genetic reason why this should not happen. I think one can find quite a lot of examples.

Hayes: I suggest this model to account for the fact that although selective techniques have failed to demonstrate mutations from sensitive to penicillinase-producing resistant, you do appear to get the reverse mutation occurring at quite a high rate.

Lederberg: The rates at which you can get mutations for the loss and for the regain of the production of different enzymes may be expected to be quite variable in different circumstances.

How many different types of penicillinase-negative cultures have been looked at for their ability to give penicillinase-positive forms? Did not Rountree find, again in this one phage type, that at least the penicillin-sensitives of certain phage types had a much higher rate of mutability to resistance?

Barber: I don't know whether one can talk about rate of mutability when Rountree did not show the actual mutation in single strains. She was postulating a higher rate of mutability on the simple evidence that clinical infections were turning up with penicillinase-producing strains only of this type.

Lederberg: Has she had some laboratory experiments? I had in mind a paper on streptomycin resistance from the same laboratory (Barbour, R. G. H., and Edwards, A. (1953), *Aust. J. exp. Biol. med. Sci.*, **31**, 561).

Barber: In the paper you refer to Barbour and Edwards found that staphylococci of the phage-group III yielded streptomycin-resistant and dependent variants more readily than did strains of other phage-groups. From these findings they suggested that mutation to penicillin resistance might also be higher among strains of group III, but since

neither they nor Rountree have isolated a penicillinase-producing staphylococcus from a penicillin-sensitive parent, this is mere speculation.

Davis: Dr. Barber has emphasized that penicillinase-producing mutants of staphylococci are difficult to obtain by mutation and selection *in vitro*, presumably because their resistance to penicillin depends very much on population density and is negligible for single bacterial cells. I gather that this difficulty in selection is one of the reasons for the belief that the appearance of these organisms in a patient is due generally to spread from another patient, rather than to a fresh mutation of sensitive staphylococci. However, I wonder whether the selection of such a mutant *in vivo* might not be favoured by a factor that is not ordinarily found *in vitro*; namely, wide fluctuations in drug concentration in the course of time. During a drug-free interval a penicillinase-producing mutant that appeared in the tissues might possibly establish a localized clone that would resist the subsequent invasion of penicillin.

Lederberg: Dr. Barber, you did show a case where you could demonstrate minute proportions of penicillinase-producing organisms in sensitive populations, but what were the quantitative features of this? What fraction of the input of penicillinase producers were you able to recover?

Barber: The smallest fraction we could detect was one penicillinase-producing cell mixed with 10^9 sensitive cells. This was on gradient plates.

Prof. Davis's points are very interesting and very important ones. First of all, as regards the transfer of a large enough population from patient to patient, you do not need to have a large number because in the first place, although they are selected out in a patient on penicillin they next pass to a patient who is not on penicillin. They then get established in that patient who has not had penicillin; that is not difficult. On the question of the wave of penicillin resistance, I am quite certain that something has happened to staphylococci, since the introduction of penicillin; but I think it is something that has taken several years to happen even in any single strain. I don't think there is any selective advantage to these strains except penicillinase production; but this, together with the elimination of other bacteria by antibiotics, is an advantage of no mean order and of course by passage in hospital they may become of increased virulence. On the last point, we cannot exclude the possibility that in experiments with penicillin-sensitive staphylococci we are in fact getting penicillinase-producing mutants which are not appearing under the particular conditions of the test. That, of course, is possible, but the mutation must be a rare one.

With regard to Szybalski's work, I am not saying that Szybalski did not isolate a penicillinase-producing variant of a clinical type, in a single stage, on a gradient plate. I think the phenomenon may happen, but certainly it is a very rare one, and the evidence given by Szybalski is not conclusive.

Know: Is there any evidence on this from experimental animals? Has an epidemic of any sort ever been kept going in animals treated and not treated with penicillin, to see whether they eventually produce penicillinase-producing staphylococci?

Barber: I tried that for a short time, but I think again one would have to do this over a very long period. I don't think anyone has carried it on for long enough.

Westergaard: A clinical point came up in discussion with Danish physicians; they pointed out that when penicillin was made available just after the war it was exceedingly expensive, and there was a tendency to use the lowest possible doses, and this may be one reason why we have built up resistance so fast. If such new drugs or antibiotics are being used, they should preferably be used in the highest possible concentrations to avoid a repetition of this.

Pollock: I think clinicians everywhere would agree about this.

Knox: Not in the case of streptomycin.

Westergaard: No, in the case of streptomycin it will not help.

Hughes: From the clinical point of view, when Fleming was first testing penicillin sensitivity, in 1927-28, already at St. Mary's Hospital the outpatients were carrying a small percentage of resistant strains. As far as I know, when we first had experimental supplies available the position was much the same. But now we have 100 per cent resistant strains in infections arising in the hospital, and in the carriers among our nursing staff. The persistence of the resistant strains in the individual is going to be a long-term affair. Valerie Hurst started a study of babies which R. E. O. Williams and I are continuing. The position is that all babies born in our wards today go out at the end of a fortnight carrying resistant staphylococci. The infection takes place within the first 24 hours. Only 40-60 per cent of babies born in their own homes ever carry staphylococci before their schooldays, and of those only a small proportion carry the resistant type. It is quite clear that with the high numbers of children born in hospitals in these days, that we are infecting our own population and are maintaining more or less permanent carriage; i.e. over a period of 4 or 5 years some are still carrying the identical phage type and resistant strains that they were endowed with in their first couple of days.

Dr. Barber, have you tried to cut the labour of your work by using mutagenic agents on your strains — X-rays or anything of that sort?

Barber: I have tried X-rays without success.

Pontecorvo: Dr. Barber, you said that it is easy to get *in vitro* resistance of the non-penicillinase type; what is the clinical position? Are resistants from patients exclusively of the penicillinase type?

Barber: They are almost exclusively of the penicillinase type. One reason is that the penicillin-tolerant type of organism, i.e. the resistant but not penicillin-destroying one, is almost invariably a weak or negative coagulase producer, and shows all sorts of other characteristics which give it less chance in the human body; it grows more slowly and so on.

Bishop: Are these mutants that you produce, by a prolonged period of treatment with the drug, stable in the absence of the drug for any long period?

Barber: Yes, moderately long periods, several months.

Bishop: The naturally produced ones must be very stable, if children

who have been infected with them in hospital still carry them, unchanged, after 4-5 years.

Barber: I don't entirely agree with Dr. Hughes' statement; I agree that babies go out of hospital about 80 per cent or more carrying the strain, but we have managed to follow up a certain number of the babies and they do seem to lose this penicillinase-producing strain very frequently, and Ludham from Nottingham has done a very interesting series showing that by the age of 5 years most of the babies have in fact lost this strain.

Hughes: Ours also are losing it.

ON THE IDENTIFICATION OF GENETIC AND NON-GENETIC VARIATION IN BACTERIA

M. WESTERGAARD

Institute of Genetics, University of Copenhagen

WHEN one has followed, even as an innocent bystander, the discussion of the last 10–15 years on the development of drug resistance in micro-organisms, one finds it difficult to avoid the impression that much of the controversy is due to semantic difficulty. Geneticists and microbiologists often ascribe different meanings and values to the same technical terms (see for instance discussions in Gale and Davies, 1953; Sevag, Reid and Reynolds, 1955). Normally it is unprofitable to quibble about words, but this may be an exception. It poses a problem with which the present author has been concerned for some years, namely whether the genetical terminology which was coined at the beginning of this century, mainly by Wilhelm Johannsen and William Bateson, to describe heritable and non-heritable variation in multicellular, diploid higher plants and animals, is adequate today to describe such variation in unicellular, haploid micro-organisms. Genetics has entered microbial biology only recently, and has brought with it its own language, which has to compete with the terminology already established by microbiologists who, until recently, did not think of variation in micro-organisms in genetical terms.

It may, therefore, be useful to consider the problem under discussion in this symposium from a slightly different angle, using the modern and in some respects less biased language of information theory: cybernetics. Two reasons justify this approach. Cybernetics has several times proved useful when dealing with “border-line” scientific problems; indeed it has sometimes been considered almost a psychiatric miracle-cure

for such problems; and microbial genetics and especially bacterial genetics is certainly a border-line problem. Further, cybernetics, which deals with transmission of information, seems especially relevant to genetical problems. We propose to define genetical information theory as the problem of the mechanism of transfer of genetical information from parents to offspring. In higher plants and animals with normal sexual reproduction, the genetical information, or rather the information specificity (or perhaps even better the information potentiality) is carried in particulate genes, located in the chromosomes and passed on to the sexual offspring through the meiotic cycle. However, the information which is contained in the chromosomes of the gametes and zygotes must be decoded, or translated to be expressed as the offspring's phenotype.

Such an approach to the genetical systems provides us with a three-phase model: (1) the information; (2) a decoding device which transmits the information to (3) a receptor. I find such a three-phase model attractive, because it supplements the classical two-phase model embodied in the concepts genotype-phenotype, which seem inadequate for the analysis of physiological and developmental genetics. I certainly do not claim any priority with this model, and some courageous colleagues have already proposed identifying the information system with the DNA, the decoding device with the RNA, and the receptor system with the proteins (for instance Gamow, 1955), and they have discussed the problem of how to translate the four-digit language of the DNA molecule into the twenty-digit language of the proteins. However, such adventurous spirits have been properly dealt with (Delbrück and Stent, 1956), and we shall here leave the chemical aspect aside, although there will probably be general agreement that we must identify the receptor system with the proteins; that the information system is in the nucleus and that the translation system is to be found in the cytoplasm.

If we accept the above model, any phenotypic event, including the appearance of drug-resistant colonies of bacteria, may

have originated in one of three ways, through a change in (1) the information system, or (2) in the decoding system, or (3) in the receptor system. This is probably too rigid a model, and the decoding system and the receptor system especially may be much more integrated. However, as a basis for discussion, the model may serve its purpose.

What we must know is how to decide whether a given phenotypic variant originates from changes at the receptor, translation, or information level. It would be very attractive indeed if this problem could be decided on a chemical basis (DNA-RNA-protein) but I think we all agree that today this would be wishful thinking. Therefore, the best we can do is probably to consider the genetical work on higher organisms with our model in mind.

There are two terms in which non-heritable variation is described in higher organisms: "modifications" and "phenocopies". Both types of events are induced by the environment and neither is heritable in the sense that they are not transmitted to the offspring through the sexual cycle. Perhaps the best analysis of modification in higher organisms is the work of Clausen, Keck and Hickey (1948). They have transplanted clones of various plants (*Potentilla*, *Achillea* and others) to different altitudinal climates in California and studied over a period of years the response of identical genotypes to drastic climatic changes. The modifications induced mainly affect quantitative characters, they seem to be largely adaptive (in the ecological sense of the word) and they are reversible. If a genetically heterogeneous population of plants is transplanted to a new environment, the degree of modification depends upon the genotype, some being more adaptive than others. If a genetically homogeneous population is transplanted, the response of the clones to the new environment is strikingly uniform.

The term "phenocopy", as defined by Goldschmidt (1935), is a specific phenotypic change imitating a known Mendelian mutant phenotypically, but not transmitted to the sexual offspring. The phenocopy is an irreversible change. It can

be induced with a high degree of specificity by radiation, temperature shock or chemical treatment at particular stages of development. Rapoport (1947) claimed that enzyme inhibitors were especially efficient in inducing specific phenocopies, and found that almost 100 per cent of a treated population responded to chemical treatment by showing the same phenocopy. However, these results have been only partly confirmed (Bertschmann, 1955). Further, Goldschmidt never found phenocopies of mutants which affect colour characters, but only phenocopies of mutants affecting size or shape. Landauer's extensive work on phenocopies induced in chickens by insulin may be cited as giving other examples (Landauer, 1954). It is characteristic of phenocopies that they can be specifically induced, that they seem to be irreversible, non-adaptive, and that they are not inherited, i.e. not transmitted to sexual offspring.

Returning to our model, I suggest that modifications and phenocopies (with certain reservations) are both "receptor events". In bacterial biology it is not sure that the term phenocopy is very useful and even the modification concept is used so loosely that it has become almost obsolete. However, the specific induction of enzyme synthesis by an exogenous inducer could be ascribed to events taking place at the receptor level. Also the phenomenon of "clonal variation", described by Yudkin and by Hughes, as well as the more vaguely defined phenomenon of "physiological adaptation" in Hinshelwood's sense may belong here. However, we should be less concerned with what to call these phenomena than with deciding at which level they take place.

The second problem is: what events, observed at the phenotypic level, may be at the level of the decoding system? The phenocopies might well belong here, but I preferred the receptor level for them. I am more inclined to regard the cytoplasmic mutations—e.g. phenotypic variants showing cytoplasmic inheritance—as possible candidates. The difference between a cytoplasmic mutation and a phenocopy is that the former is transmitted to the sexual offspring through

the cytoplasm (usually by maternal inheritance) whereas the latter is not inherited at all. There are numerous examples of cytoplasmic inheritance in higher organisms, the best probably being concerned with the inheritance of chloroplast defects in higher plants. In micro-organisms the vegetative "petite" mutant in yeast, which lacks certain enzymes in the cytochrome system, may be quoted as an example (see Ephrussi, 1953). The "poky" mutant of *Neurospora* is another (Mitchell, Mitchell and Tissieres, 1953), and the genetical studies of *Paramecium* have revealed many interesting examples of cytoplasmic inheritance (see Beale, 1954).

The work of Gale, Spiegelman and others (cf. Gale and Folkes, 1954; Spiegelman, Halvorson and Ben-Ishai, 1955), in which enzyme synthesis is blocked by inhibition of RNA synthesis, would of course be another good example of a phenotypic event (lack of enzyme synthesis) which is due to blockage of the decoding system.

To complete the model we shall identify changes in the information system with mutations, including intragenic point-mutations as well as intergenic mutations resulting from one or two breaks in the chromosome thread, and even changes due to aneuploidy and polyploidy.

In brief, in our information-translation-receptor framework we may identify (1) "receptor events": modifications and phenocopies in higher organisms; specific enzyme induction, clonal variation, and "physiological adaptation" in bacteria; (2) "translation events": cytoplasmic changes (mutations), especially those which affect the mitochondria or plastids; (3) "information events" which would be nuclear mutations.

In sexual organisms, the Mendelian crossing experiment would decide which type of event has occurred, because receptor events are not transmitted to sexual offspring, translation events show non-Mendelian, mostly maternal inheritance, whereas information events show Mendelian inheritance.

What are the possibilities for a similar discrimination

between these three phenomena in bacteria with imperfect—or imperfectly understood—sexual mechanisms? Not being a bacterial geneticist I would rather ask the question and hope that the discussion will bring the answer. However, I am prepared to accept as information events all such phenotypic changes—spontaneous or induced—which can be passed on to other cells through either transformation, transduction or recombination. As regards “translation events”, in higher organisms cytoplasmic inheritance (maternal inheritance) is identified by means of reciprocal crossing experiments. Is there, in bacteria, the equivalent of a reciprocal cross in (a) transformation experiments, (b) transduction experiments, and (c) recombination experiments?

Receptor events would be phenotypic changes which in experiments involving reciprocal crosses cannot be passed on to the other cells through transformation, transduction or recombination. This should decide whether a bacterial character should be considered heritable (genetic) or non-heritable. However, what weight can be placed upon negative evidence in transformation, transduction or recombination experiments in bacteria? Two of these mechanisms transmit only a fraction of the genetical information from one cell to another. How much can we therefore conclude if a character cannot be passed on through transformation, transduction, etc.?

Anticipating that bacterial geneticists may be unable to give full assurance on this point, I propose to consider other possibilities for approaching the problem, by studying the reaction of the cells to various chemical treatments. Naturally this evidence can never be more than circumstantial.

The last 10–15 years have provided a good deal of information (Table I) about the response of the receptor system, as well as the translation and information system, to chemical treatment. Table I shows that radiation, temperature and alkylating agents have such a non-specific and general effect on the biological systems that they cannot discriminate between different specific events. However, phenocopies in

Table I

<i>Back mutations</i>	<i>Nuclear mutations Chromosome breakage</i>	<i>Cytoplasmic mutations</i>	<i>Phenocopies</i>
<i>Neurospora</i> (1)	<i>Allium, Vicia</i> etc. (2)	Yeast (4)	<i>Drosophila</i> (6)
Radiation (X-rays and u.v.)	Radiation	Acridines	Radiation
Alkylating agents	Alkylating agents	Green algae (5)	Alkylating agents
	Urethane	Streptomycin	Temperature
	Phenols		Ether
	Purines		NaFl
	Maleic hydrazide		HgCl ₂
	Acridines		AgNO ₃
	Coumarine		KSCN
	Quinones		<i>Gallus</i> (7)
	Penicillin		Insulin
	Streptomycin and other antibiotics (3)		Sulphonamides
			H ₃ BO ₃
			Pilocarpin
			Vitamin deficiency
			<i>Lepus</i> (8)
			Colchicine

(1) Giles (1951), Westergaard (1957)

(2) Levan (1951)

(3) Wilson (1950)

(4) Ephrussi (1953)

(5) Provasoli, Hutner and Pintner (1951)

(6) Goldschmidt (1935), Rapoport (1947),

Bertschmann (1955)

(7) Landauer (1954)

(8) Nachtsheim (1956)

higher organisms can be induced by many enzyme poisons, for instance salts of heavy metals, which may not induce mutations in the cytoplasm or in the nucleus. It is also characteristic of the induction of phenocopies that it is remarkably specific, since almost 100 per cent of a treated population may show the same phenocopy if the treatment is properly applied.

The evidence for the induction of cytoplasmic mutations rests mainly on the work of Ephrussi and his colleagues on the induction of "petite" in yeast by treatment with acridines and related compounds (I am aware of the fact that due to the partial sterility of the vegetative "petite" type, the proof for true cytoplasmic inheritance is still inconclusive). Again it is characteristic that the induction of "petite" is surprisingly specific, and we should keep in mind that the effect of the chemical is probably a destruction or inactivation of the

mitochondria of the yeast cells. It is not sure whether the bleaching effect of streptomycin on the chloroplasts of algae belongs to the same category, because there are no genetical data on this (Provasoli, Hutner and Pintner, 1951).

Finally, with nuclear mutations the pattern of specificity disappears. True, there is a pattern of "relative specificity" of mutagens both in *Neurospora* (Kølmark, 1956) and in bacteria (cf. Demerec *et al.*, 1956). However, this specificity, which can be very striking (Table II) is found only with

Table II

THE RELATIVE SPECIFICITY OF 6 MUTAGENS ON THE DOUBLE MUTANT INOSITOLLESS (No. 37401), ADENINELESS (No. 38701). The mutagens are compared under "optimal conditions"*

	Mutations per 10 ⁶ conidia		Proportion ad ⁺ /inos ⁺
	inos ⁺	ad ⁺	
(1) CB 1528†	11·3	17·4	1·5
(2) Ultraviolet light	7·1	3·5	0·5
(3) Diethylsulphate	4·3	16·8	4
(4) Dimethylsulphate	3·4	64·0	19
(5) CB 1506‡	0·3	51·0	190
(6) Diepoxybutane	0·2	89·0	445

* Data from Kølmark (1956, and unpublished).

† Ethyl methanesulphonate (CH₃·CH₂·O·SO₂·CH₃)

‡ Chloroethyl methanesulphonate (Cl·CH₂·CH₂·O·SO₂·CH₃)

reverse mutations. The induction of forward mutations by mutagens does not show the same degree of specificity. The explanation for this difference may be quite simple. Most mutagens act by destroying or inactivating the genetical material. There are so many ways in which a gene may be damaged or inactivated, that a striking specificity is hardly to be expected. However, a few genes may be changed so slightly by the mutagenic treatment, that the change may be reversible. It would, however, require a specific mechanism to repair a damaged gene. Therefore it is not surprising that the pattern of specificity of mutagenic treatment shows up in back mutations but not in forward mutations.

There is, however, one special kind of specificity in the response of the nucleus to mutagens. In the *Neurospora*

back-mutation test, back mutations are induced only by radiation and by strongly alkylating agents, whereas many stable chemicals such as phenols or urethane, which induce chromosome breakage in plants and animals, are inactive (Jensen *et al.*, 1951; Kølmark and Westergaard, 1955).

In terms of our model, how may the results of chemical mutagenesis and phenocopy induction help to identify the different mechanisms of variation in bacteria? Has variation in bacteria, for instance drug resistance, been enhanced by these chemicals which in higher organisms are known to produce only phenocopies, but not mutations? If so, can the variants induced by such treatments be transduced, transformed or recombined? One has sometimes the impression that "mutations" in bacteria can be induced by almost any kind of treatment. However, it may well be that several of these "mutations" are not nuclear, but "receptor events" or "translation events". Only genetical breeding experiments can give the final answer, but circumstantial evidence may be obtained by use of chosen chemicals.

There is also the possibility that the antibiotics against which drug resistance is built up are themselves inducers either of nuclear mutations, cytoplasmic changes or "phenocopies". I think it is possible that they are, but that this is not particularly relevant for understanding the origin of drug resistance. Most antibiotics are probably weak, unspecific chemical mutagens. There is good evidence that streptomycin can affect the chloroplasts of green plants and it would be very interesting to study the effect of other antibiotics on the induction of phenocopies in, for instance, *Drosophila*. However, although the induction of phenocopies may be specific, the result, the phenocopy, seems to be a non-adaptive change. I think we all agree on one thing, namely that what we are seeking in order to explain the origin of drug resistance are mechanisms which can give rise to an adaptive system, in the ecological and evolutionary sense of the word. Hence, although the possible mutagenic properties of many drugs and antibiotics may have important perspectives for other

aspects of drug application in medical therapy, this problem is not especially relevant to understanding the origin of drug resistance *in vitro* or *in vivo*.

I apologize that most of this paper has been concerned with semantic problems, since this is generally considered a most boring subject in biology. However, I have followed a standard practice in dealing with complex problems by constructing a model. To place this model in its true perspective, the reader is referred to a recent publication by two great scientists on the use of models in biological research: "One well established and generally accepted method of treating systems which are complicated beyond comprehension is to construct simple models and see whether they fit the systems in question. If they do, you will immediately become suspicious, and so will your colleagues most certainly, with the result that a blooming literature springs up (or breaks out) dealing with the problem of how you have managed to make all your errors cancel one another. If they do not fit, the beauty of the models themselves may shine for years untainted by the squalid awkwardness of reality" (Fizz-Loony and Linderstrøm-Lang, 1956).

REFERENCES

- BEALE, G. H. (1954). The Genetics of *Paramecium aurelia*. Cambridge University Press.
- BERTSCHMANN, M. (1955). *Z. indukt. Abstamm.-u. VererbLehre*, **87**, 229.
- CLAUSEN, J., KECK, D. D., and HIESEY, W. M. (1948). *Publ. Carneg. Inst.*, No. 581.
- DELBRÜCK, M., and STENT, G. (1956). In The chemical Basis of Heredity, p. 699. Ed. McElroy, W. D., and Glass, B. Baltimore: Johns Hopkins Press.
- DEMEREC, M. *et al.* (1956). *Publ. Carneg. Inst.*, No. 612.
- EPHRUSSI, B. (1953). Nucleo-cytoplasmic Relations in Micro-organisms. Oxford University Press.
- FIZZ-LOONY, F., and LINDERSTRØM-LANG, K. (1956). The Thermodynamic Activity of the Male Housefly. New York: Academic Press.
- GALE, E. F., and DAVIES, R., Ed. (1953). Adaptation in Micro-organisms, p. 69. Cambridge University Press.
- GALE, E. F., and FOLKES, J. P. (1954). *Nature, Lond.*, **173**, 1223.
- GAMOW, G. (1955). *Biol. Med., Kbh.*, **22**, no. 8.

- GILES, N. H., Jr. (1951). *Cold Spr. Harb. Symp. quant. Biol.*, **10**, 283.
- GOLDSCHMIDT, R. (1935). *Z. indukt. Abstamm.-u. VererbLehre*, **69**, 38.
- JENSEN, K. A., KIRK, I., KØLMARK, G., and WESTERGAARD, M. (1951). *Cold Spr. Harb. Symp. quant. Biol.*, **16**, 245.
- KØLMARK, G. (1956). *C. R. Lab. Carlsberg. Sér. physiol.*, **26**, 204.
- KØLMARK, G., and WESTERGAARD, M. (1955). *Hereditas, Lund.*, **39**, 209.
- LANDAUER, W. (1954). *J. Cell. comp. Physiol.*, **43**, suppl. 1, 261.
- LEVAN, A. (1951). *Cold Spr. Harb. Symp. quant. Biol.*, **16**, 233.
- MITCHELL, M. B., MITCHELL, H. K., and TISSIERES, A. (1953). *Proc. nat. Acad. Sci., Wash.*, **39**, 606.
- NACHTSHEIM, H. (1950). *Arch. Klaus-Stift. VererbForsch.*, **25**, 566.
- PROVASOLI, L., HUTNER, S. H., and PINTNER, I. J. (1951). *Cold Spr. Harb. Symp. quant. Biol.*, **16**, 113.
- RAPOPORT, I. A. (1947). *Amer. Nat.*, **81**, 30.
- SEVAG, M. G., REID, R. D., and REYNOLDS, D. E., Ed. (1955). *In* Origins of Resistance to Toxic Agents, p. 423. New York: Academic Press.
- SPIEGELMAN, S., HALVORSON, H. O., and BEN-ISHAI, R. (1955). *In* Amino Acid Metabolism, p. 124. Baltimore: Johns Hopkins Press.
- WESTERGAARD, M. (1957). Chemical Mutagenesis and the Concept of the Gene, in press.
- WILSON, G. B. (1950). *J. Hered.*, **41**, 227.

DISCUSSION

Alexander: Haddow has compared the cytotoxic effects of CB. 1506 (chloroethyl methanesulphonate, $\text{ClCH}_2\text{.CH}_2\text{.OSO}_2\text{.CH}_3$) and CB. 1528 (ethyl methanesulphonate, $\text{CH}_3\text{.CH}_2\text{.OSO}_2\text{.CH}_3$), using the growth of the implanted Walker carcinoma, and found that CB. 1506 has a much higher activity than CB. 1528. As a working hypothesis, it has been suggested that CB. 1506 becomes activated *in vivo* by reaction with cysteine to form a one-armed sulphur mustard:

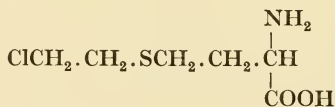

Do you consider it possible that such a reaction may also occur in your plant system? Our reason for believing that it may be necessary to convert CB. 1506 metabolically into a more active compound is that the chlorine atom in CB. 1506 is extremely unreactive, while in the postulated cysteine derivative it would be highly active.

Westergaard: Yes, I should think so. One possibility is that CB. 1506 may act in two different ways. It may form an epoxide, and epoxides are exceedingly efficient in inducing adenine reversions, whereas CB. 1528 only acts as an ethylating agent. The inositolless strain which we use likes everything which is able to ethylate and nothing else, which is very surprising. We cannot account for this at present.

Davis: Do you know whether this kind of study has been applied to allelic mutants blocked in different sites within the same locus?

Westergaard: It has nothing to do with the locus. It is only relevant to the mutant strain which you use. We can get other alleles at the same locus with quite a different reverse-mutation pattern. This pattern probably depends upon how the gene was originally damaged.

Pontecorvo: Is this the first example of real specificity in mutagenic action?

Westergaard: You find the same thing, for instance, if you use dimethyl sulphate and diethyl sulphate and if you use diepoxybutane. This is where it was first found. Giles finds the same pattern with X-rays and ultraviolet light. It all depends upon the particular allele and the pattern for each allele has to be worked out.

Demerec: What is the available evidence about the potentialities of antibiotics as chemical mutagens?

Westergaard: The only evidence is that all the antibiotics which have been tested in plants seem to induce chromosome breakage and rearrangement. This has been shown for penicillin by Levan, and by Wilson and others in the United States for streptomycin and chloromycin. I think that all inducers of chromosome breakage should be considered mutagens, because everything which will induce chromosome breakage may also cause rearrangement. I don't agree with Auerbach in this discrimination between chromosome breakage and mutation.

Alexander: Would you call maleic hydrazide a mutagen?

Westergaard: Definitely so. This again is relatively specific on the cytological level, because it seems to attack only the heterochromatin preferentially and so does 8-oxycaffeine.

Alexander: Have you been able to test in your system whether one of the mutagens acted by changing the gene so that it now transmits a new property, as opposed to destroying the gene so that it no longer has any biological function? Is it possible to distinguish between these two different types of processes in your system?

Westergaard: We have so far induced only back mutations. Demerec has induced both forward and back mutations, but we have not done it on a quantitative scale. We hope to induce forward mutations with urethane, which will not induce back mutations in these two particular loci. We are now trying to get the forward and back mutation patterns worked out, inducing the forward mutations by different mutagens.

Alexander: Surely it is within the realms of possibility that something which is a powerful chromosome breaker may only act in the way of destroying the gene, but never introducing a positively changed gene; i.e. a function has been lost without a new function taking its place.

Westergaard: I would still call them mutations.

Alexander: There are some mutagens which can produce back mutations which would indicate that they can actually change the gene material in such a way that it transmits a new and different code.

Westergaard: This is what I believe, but I am not sure that everybody would agree with me.

Pontecorvo: Can back mutations be produced with X-rays?

Westergaard: Yes, and this is not surprising, since X-rays also initiate radiochemical processes. It has been proved very beautifully by Giles and de Serres that you can produce back mutations with X-rays.

Alexander: From the point of view of chemical mechanism, one will have to distinguish between merely spoiling a molecule, making it useless to the cell (which could be a much less non-specific process—antibiotics or anything could do it) and reaction which can actually change the gene so as to alter its function.

Westergaard: This is what we have been trying to do for years but we have not been very successful in selling the idea.

Pontecorvo: When you get down to the molecular level what is the difference between a breakage and a rearrangement? There may be structural rearrangements of any kind, or additions or removals of side-chains. I don't see that you can have a distinction at the chemical level.

Alexander: There are two clear distinctions: you can take the molecules which are responsible for gene function and render them useless to the cell so that they can no longer fulfil their normal physiological function and then you get a certain type of mutation, and I would expect that type of mutation to be produced by many agents, including the antibiotics. Then there are some agents which can actually change a gene so that it is not just destroyed but that it can now do something different. Can you explain all mutations by loss? In that case evolution ought to have been working backwards very quickly.

Pontecorvo: Not by loss, but by structural rearrangement; and as soon as the structural rearrangement is at a molecular level I don't see that we can distinguish the two.

Alexander: One can chemically envisage rather crude structural rearrangements which cannot conceivably give the molecule an altered function but can merely render it useless to the cell. One can also conceive a rather more refined chemical alteration which can allow the molecule to fulfil a modified function.

Rose: If there has been a chemical deletion the chance of putting that unit back again is remote in the extreme.

Lederberg: There are just one or two points of difficulty here. One is that we do not know the chemical differences between normal and mutated genes and, until we do, this is bound to be very ethereal. In principle, there should be an empirical search for agents which would be purely unidirectional, which could give one type of mutation and not the reverse. Until now there has been no evidence that such agents exist; and things like X-rays which have formerly been thought to be the best test of such a notion have given changes in both directions at the same loci. If Prof. Westergaard is correct in saying that there are agents which are capable of inducing mutations for biochemical loss and not their reverse, he will have established, I think, a new principle in genetic methodology, and if that is so we shall have to incorporate it in our theory. In principle, all these hypotheses have to be considered but until now there has been no critical evidence that would necessitate a distinction between those types of rearrangement that you call a loss and those

types of rearrangement that are changes in quality of existing material. Is that a fair statement, Prof. Westergaard?

Westergaard: That is a fair statement.

Hughes: Reverting to mutation in bacteria from mutation molecules, I have got the impression that Lederberg believes that mutation may be increased by organisms being sent through the long form or the L cycle. I also think that is probably so. Do you hold the view, Prof. Lederberg, that the mutagenic agents do in fact send organisms through that cycle and that that does increase mutation rates? Certainly, some of the chemotherapeutic agents would then fit in very nicely.

Lederberg: I have questioned whether the action of any mutagenic agent has to be considered as the immediate consequence of a chemical reaction between a molecule of a mutagen and a specific nucleotide in the DNA strain, or whether there is a somewhat more general pathology of the cell during the recovery, from which you may get chromosome breakage or other alterations. I do not insist that these are mutually exclusive alternatives; to a very large degree the question is still open as to the exact timing of localization and fixation of mutagenic effects.

Knox: If antibiotics are capable of acting as weak mutagenic agents, is there any information about the effect of antibiotics on a whole range of mutations in bacteria? For example, if you take a fairly mutagenic concentration of streptomycin, does it increase mutation rates?

Westergaard: This has been shown in the case of streptomycin by Japanese workers (see Sevag, Reid and Reynolds (1955), *loc. cit.*, p. 85; also Christensen, J. J. (1956), *In Antibiotics and Agriculture, Publ. Nat. Acad. Sci., Wash.*, 397, 73).

Knox: Does this depend on the sensitivity of resistance of the bacteria?

Westergaard: That was not studied, but it is an interesting point. I should like to try it with azaserine.

Lederberg: It is quite clear that there are types of metabolic disturbances which can greatly influence mutation rate, and which therefore by extension might apply to certain antibiotics. For example, the mutant strains of *Esch. coli* which are defective in the synthesis of thymine, and may be grown under conditions of thymine deprivation, have a very high rate of mutation for all sorts of biochemical deficiencies and reversions as well. One can easily imagine equally non-specific metabolic interferences by antibiotics. Newcombe found a rather small mutagenic effect of streptomycin for phage resistance.

Westergaard: There is also the Japanese work. Is there any evidence of phenocopies being induced in bacteria by different treatments?

Lederberg: I myself have been guilty of using the term once for the suppression of compatibility status of compatible cultures. I think a Lac⁺ genotype which is grown in the absence of an inducer and thereby fails to form the specific enzymes is a phenocopy of a lactose-sensitive. The examples are so numerous that they are almost trivial because all the characters that we use in bacteria are in a sense physiological responses which are dependent on their environment for their expression.

THE REACTIONS OF THE MUTAGENIC ALKYLATING AGENTS WITH PROTEINS AND NUCLEIC ACIDS

P. ALEXANDER, SHEILA F. COUSENS AND K. A. STACEY
*The Chester Beatty Research Institute, Institute of Cancer Research:
Royal Cancer Hospital, London*

A WIDE variety of different substances are now known to be mutagenic but the most active are the nucleophilic alkylating agents of which mustard gas—the first substance to be recognized as mutagenic (Auerbach and Robson, 1944)—is a typical representative. Alkylating groups which confer biological activity are (cf. Fahmy and Fahmy, 1956):

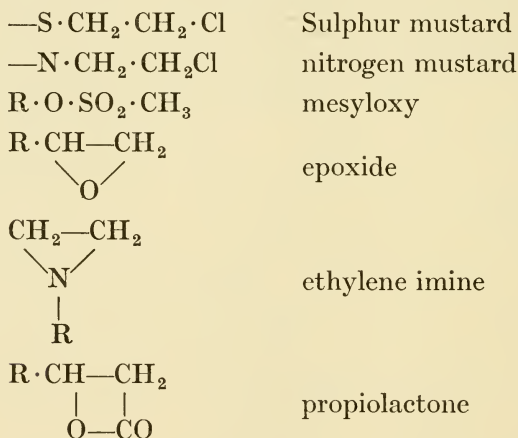

They are often referred to as radiomimetic alkylating agents (Dustin, 1947) since the biological effects they produce at the cellular level simulate closely those which follow exposure to ionizing radiations.

Sir Rudolph Peters (1947) first suggested that the ability to esterify acid groups *in vivo* might be responsible for the biological activity of mustard gas. In the subsequent ten years this suggestion has received a large measure of support.

In spite of widely differing constitution the active agents all share the property of reacting under physiological conditions with nucleophilic (i.e. electron-rich) centres; and that their biological activity is derived from the ability to change some vital molecules in the cell by alkylation seems certain.

There are very many points at which these agents can react in the cell, and the most important are amino (or imino) groups in their uncharged state and anions such as the ionized carboxyl groups in proteins and the phosphate groups of nucleic acid. Ionized —SH groups (i.e. —S^-) react so readily with these alkylating agents that even at pH 7 all the available —SH groups are readily alkylated although less than 0.1 per cent of them are present in the reactive —S^- form at any one time.

In spite of the great diversity of possible reactions it is possible to eliminate a number of these by considering compounds which are inactive although they have some of these reactions in common. Hendry, Rose and Walpole (1951) examined a large number of compounds which were known to react with amino groups by alkylation (such as the alkyl halides), by acylation or in other ways, but which could not esterify anions. Although they were not tested by these authors for mutagenic properties none showed cytotoxic effects on tumours which are such a characteristic feature of the radiomimetic alkylating agents. Similar negative results have been obtained more recently by Haddow (unpublished) with a number of bifunctional thiol esters of the type $\text{R'S}\cdot\text{CORCO}\cdot\text{S}\cdot\text{R}'$ which combine with amine groups under biological conditions. We studied in some detail one of the amine reactors used by Hendry, Rose and Walpole (1951), triacrylfomal,

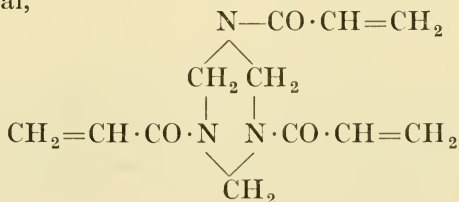

and found that it very readily alkylated amino groups in proteins, but Fahmy and Fahmy (unpublished) were not able to produce any mutations in *Drosophila* with it. Similarly specific thiol reagents which inactivate sulphhydryl enzymes in the cell (cf. Ross, 1953) do not bring about the highly specific forms of genetic damage associated with radiation and the alkylating agents belonging to the mustard class. These experiments indicate that reaction *in vivo* with amino or sulphhydryl groups does not produce radiomimetic effects and the biologically significant reaction of the alkylating agents considered in this paper would appear to be the esterification of acid groups. This type of reaction can only be brought about under physiological conditions by substances most of which are mutagenic, and cannot be produced with the inactive substances.

The *in vitro* reaction with nucleic acids and proteins lends powerful support to the arguments just advanced that combination with acid groups is the biologically important reaction. That is not to say that this is the only or even the predominant reaction which takes place with cellular constituents, and a substantial proportion of the reagents are probably wasted in useless reactions. The important process can therefore not be discovered merely by following the *in vivo* fate of an active compound. The experiments described in this paper were designed to throw light on the mechanism by which these reagents exert their biological activity, although general considerations strongly suggest that the relevant reactions of chemical mutagens must be with the nucleic acid moiety of nucleoprotein. A summary of our results with proteins is given for the sake of completeness.

Reaction with Proteins

A number of papers have been published on the reaction of proteins with mustard gas (see review by Alexander, 1954) but the results do not provide information about the relative reactivities of different groups in the proteins since in almost

every case the agent was present in great excess. Very little is known of the combination of the other types of radiomimetic alkylating agents with proteins and this led us to examine systematically the reaction of a representative number of these with serum albumin under physiological conditions. The reaction with the different groups in the intact proteins was determined by a variety of methods (Cousens, 1956). The results, summarized in Table I, indicate that the most prominent reaction common to all the biologically active alkylat-

Table I

CHANGES PRODUCED IN SERUM ALBUMIN BY RADIOMIMETIC AGENTS

Treatment	% Reduction			
	Carboxyl Groups	Amino Groups	Imidazole Groups	Tyrosine
$\text{O}=\left[\begin{array}{c} \text{CH}_2 \cdot \text{CH}-\text{CH}_2 \\ \diagdown \quad \diagup \\ \text{O} \end{array}\right]_2$	27	46	77	No reaction
$\text{CH}_3 \cdot \begin{array}{c} \text{CH}-\text{CH}_2 \\ \diagdown \quad \diagup \\ \text{O} \end{array}$	22	60	70	No reaction
Myleran	31	0	42	No reaction
Chlorambucil	25	7	5	No reaction

3% Protein Solution + 0.12 Moles of Reagent

ing agents is esterification of the carboxyl groups. The epoxides reacted extensively with amino groups of lysine and the imino group of histidine; the nitrogen mustards reacted to a lesser extent and the mesyloxy compounds hardly at all.

Chromatographic examination of the acid hydrolysate of the reacted proteins showed an almost complete disappearance of the spot due to histidine after reaction with epoxides and a very noticeable decrease after treatment with nitrogen mustard. The intensity of the lysine spot was also changed.

No alteration could be seen in the chromatogram of the mesyloxy-treated proteins; this is to be expected since the esters formed with the carboxyl groups would be broken down again under the conditions used to hydrolyse the protein into its constituent amino acids.

The epoxide- and nitrogen mustard-treated proteins gave rise to additional spots on the chromatogram which are probably due to *N*-alkylated lysine or histidine (Fig. 1). The new spots from proteins treated with bifunctional reagent are close to the origin and this would be consistent with the cross-linking of two amino acids to give a large molecule which diffuses slowly.

The reaction with protein SH groups was not studied in serum albumin since this contains less than one SH group per molecule and ovalbumin was used instead. In the native protein no significant reaction could be obtained (Table II) but

Table II
REACTION OF ALKYLATING AGENTS WITH THE —SH GROUP
3% egg albumin before and after denaturation

<i>Alkylating agent*</i>	<i>% SH groups reacted</i>	
	<i>Native protein</i>	<i>Denatured protein†</i>
$(\text{ClCH}_2 \cdot \text{CH}_2)_2 \text{N} \cdot \text{C}_6\text{H}_4 \cdot (\text{CH}_2)_3 \cdot \text{COOH}$ Chlorambucil (1.7% solution)	14	88
$\text{CH}_3 \cdot \text{SO}_2 \cdot \text{O} \cdot \text{C}_2\text{H}_5$ (2.6% solution)	0	55
$\text{CH}_2 - \text{CH} \cdot \text{CH}_3$ (5% solution) 	0	100

* Reaction time 4 hours at 37° C.

† Denatured by guanidine.

this was to be expected since these groups had earlier been found inaccessible to thiol reagents. After denaturation with guanidine, the —SH groups reacted extremely readily with the three reagents tested. With mustard gas, Bacq (1946) showed that the rate of combination increased rapidly as the pH was raised from 6 to 9 and this is in agreement with the theoretical prediction that the —S⁻ form is the reactive species.

Reaction with nucleic acids

Our attention has so far been confined almost entirely to DNA*; in this substance one might expect reaction with the phosphate and the amino imino groups and ring nitrogen of the purine and pyrimidines, all of which are in the electrophilic (or reactive) form at pH 7. With mustard gas—present in very large excess—Elmore and co-workers (1948) obtained extensive esterification of the phosphate groups of DNA and indication for reactions with amino groups based on changes in the titration curve, but more recent work on the titration behaviour of DNA invalidates their interpretation. Alexander (1952) found that all the other types of radiomimetic alkylating agents readily esterified the phosphate groups of DNA under mild conditions.

With the biologically highly active mustard from *l*-phenylalanine (Bergel and Stock, 1954), i.e. CB 3025.

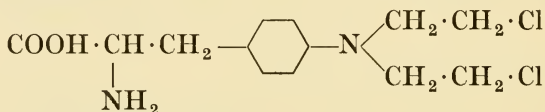

we were able to show, when the mustard was not present in excess, that the only reaction which could be detected with native DNA is esterification of the phosphate groups. By using an automatic titrator the rate of release of acid due to hydrolysis of the mustard group could be followed while maintaining the pH throughout at 7. In the presence of DNA the amount of acid produced is decreased (Fig. 2) and this provides a direct measure of the number of phosphate groups which have been esterified. Acid is liberated to the same extent when the mustard group is hydrolysed by the water or when it alkylates an amino group:

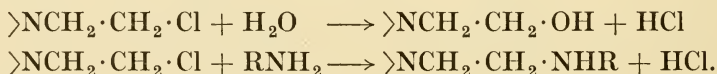

* The DNA we used was obtained from the sperm heads of herring by a modification of the method of Kay, Simmons and Dounce (1952). The protein content is less than 0.1 per cent and the molecular weight of different batches as determined by light-scattering ranged from 6 to 6.8×10^6 .

But on esterification no acid is released:

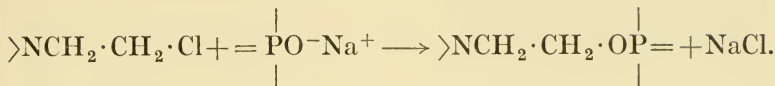

With relatively dilute solutions of DNA a considerable amount of acid is produced during the reaction with the

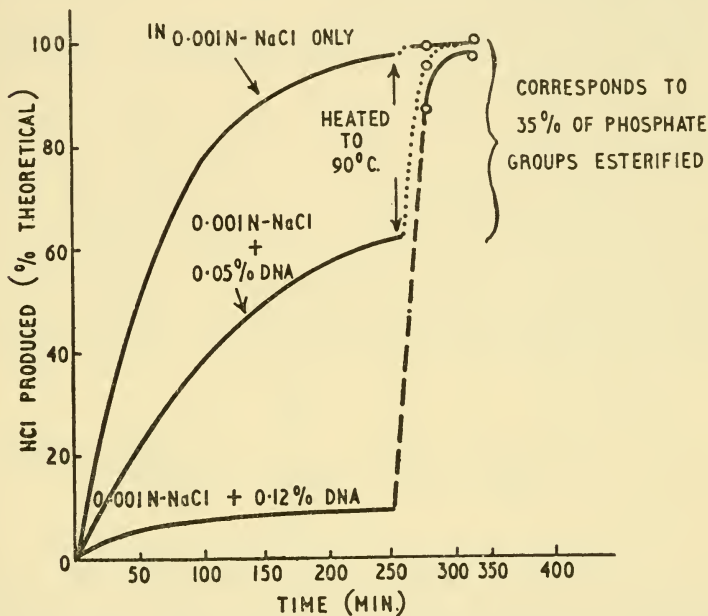

FIG. 2. Rate of acid formation when the phenylalanine nitrogen mustard at a concentration of 0.1% was reacted with different concentrations of DNA at 37° C (pH maintained at 7 by an automatic titrator), and the effect of heating subsequently for 20 minutes at 90° C.

mustard. That the liberation of this acid is entirely due to hydrolysis by water and not produced in part by alkylation of amino groups was shown by analysis of the solution after reaction was complete. The amount of mustard which had combined with the DNA was equal to that bound by esterification as calculated from the decrease in the amount of acid released, while the amount of hydrolysed mustard found

free in the solution after reaction corresponded exactly to the amount of acid produced.

The absence of reaction with amino groups is shown still more strikingly with solutions containing 0.12 per cent DNA when 94 per cent of the mustard is used up in esterification (Fig. 2) and only 6 per cent of it liberates acid. This 6 per cent is entirely due to hydrolysis.

In agreement with the prediction of Brown and Todd (1952) we find that the triesters produced by alkylation of the phosphate groups of DNA are unstable and are hydrolysed completely by heating at 90° C for 20 minutes. Fig. 2 shows that after this treatment the amount of acidity produced is equal to the amount of esterification (i.e. after boiling, the total amount of acid produced is equal to that which would have been produced by hydrolysis in the absence of DNA). Within experimental error (± 5 per cent) all the combined mustard residues were released on hydrolysis and this shows that the triester breaks down predominantly at the mustard linkage. Measure-

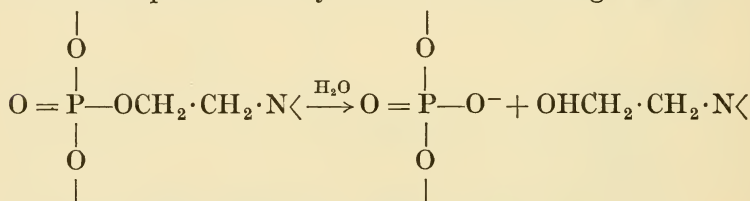

ment of the molecular weight shows that breakdown also occurs, though very infrequently, at one of the sugar esters. When this happens a break in the main chain is produced (see p. 314).

With epoxides, esterification of the mustard groups is also the most prominent reaction. In this case it results in the liberation of alkali which was followed with the automatic titrator (Fig. 3).

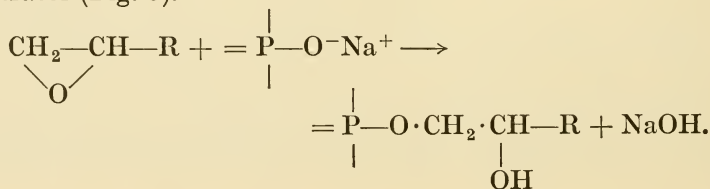

Since the epoxides react much more slowly than the mustards and also since the proportion which hydrolyses is much greater, it is not possible to determine the extent of combination with amino groups. Using excess epoxide the absorption spectrum of the DNA is slightly altered after 50 per cent of the phosphate groups have become esterified, and this indicates that some reaction with the purine⁵ or pyrimidine bases has occurred. No change in the spectrum was observed immediately after comparable treatment with aliphatic nitrogen

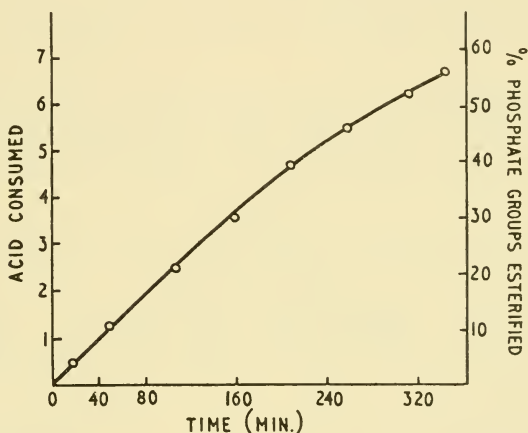
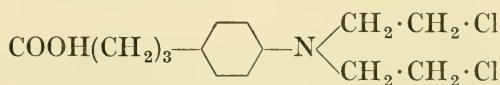

FIG. 3. Rate of alkali produced (i.e., acid consumed to maintain pH at 7) when 0.1% DNA was treated with a 2% solution of propylene oxide at 37° C.

mustards and this is another illustration of the greater reactivity of epoxides with amino groups (cf. Table I).

On extending our investigations to other aromatic mustards we found that some did not combine significantly with DNA in solution. A notable example was chlorambucil,



a compound used clinically and found by Fahmy and Fahmy (1956) to have the highest mutagenic activity of any mustard.

These observations seemed to be very difficult to reconcile with the view that the radiomimetic alkylating agents exerted their effect by combining with DNA, and led us to examine the reaction of a series of water-soluble aromatic nitrogen mustards with proteins and DNA. The relative rates of reaction were expressed as a competition factor (Ogston, 1948) which was defined as:

$$\frac{\text{Amount of mustard combined with macromolecule}}{\text{Amount of mustard hydrolysed by water}} \times \frac{1}{\text{concentration of macromolecule}}$$

The concentration of macromolecule was expressed as a molarity based on the total number of groups present which can be alkylated. Table III shows that there is no correlation

Table III

COMPETITION FACTORS OF AROMATIC NITROGEN MUSTARDS FOR PROTEINS : DNA

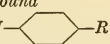
Compound (Cl CH ₂ CH ₂) ₂ N-  -R	Biological Activity	Serum Albumin	Serum Globulin	Fibrinogen	DNA	Poly-methacrylate	Poly-ethyleneimine
R							
CH ₂ ·CH·(NH ₂)·COOH (Phenylalanine Mustard)	++ +	26	23	—	180	2100	21
O·(CH ₂) ₂ ⁺ N·(CH ₃) ₃ Br ⁻	—	40	7	2	460	1400	20
(CH ₂) ₂ N·(CH ₃) ₂	++	20	—	—	310	4400	—
(CH ₂) ₂ ·NH ₂	++	25	—	—	190	2000	—
—COOH	+	31	20	5	0	0	240
(CH ₂) ₃ ·COOH (Chlorambucil)	+++	74	20	20	20	100	170

between reactivity with DNA and biological activity. All mustards carrying a positive charge reacted readily while those like chlorambucil which have a negative charge (i.e. the ionized carboxyl group) at pH 7 fail to react. Experiments

with a positively and a negatively charged synthetic polymer (polyethylene imine and polymethacrylic acid respectively) show that reaction is very largely influenced by electrostatic repulsion or attraction between the reactants.

Reaction with nucleoproteins

In the cell, of course, DNA is not present as such but combined with proteins which will reduce its electrical charge. Consequently we decided to study the reaction of a nucleoprotein with the radiomimetic alkylating agent. Since the extraction of nuclear proteins from the cell gives ill defined products which are difficult to handle, we used sperm heads obtained by plasmolysing soft roe from herrings (Felix, Fischer and Krekels, 1956). These are hard balls with a diameter of the order of 2μ , containing only DNA and the low-molecular weight proteins, the protamines, in the ratio of 39 per cent to 61 per cent. They are surrounded by a tough membrane the weight of which is insignificant. When placed in water they swell only to a very limited extent and take up less than their own weight of water. Suspensions of sperm heads can therefore be handled easily and they are not at all viscous.

The reaction of the sperm heads with the alkylating agents can be followed on the automatic titrator in exactly the same way as with the solution of DNA. From the amount of acid liberated the esterification of the phosphate groups can be determined and is seen to occur extremely readily (Fig. 4). For the aromatic mustards it could again be shown that the only reaction which occurred was esterification of acid groups and there was no evidence of alkylation of amino or imino groups in either the protein or the nucleic acid. Since the number of carboxyl groups in the protein is very much less than that of the phosphate groups from DNA the esterification of the latter would again appear to be the predominant reaction. Other evidence (see p. 311) supports the view that the reaction of the mustard is confined to DNA and that the protamine is not involved.

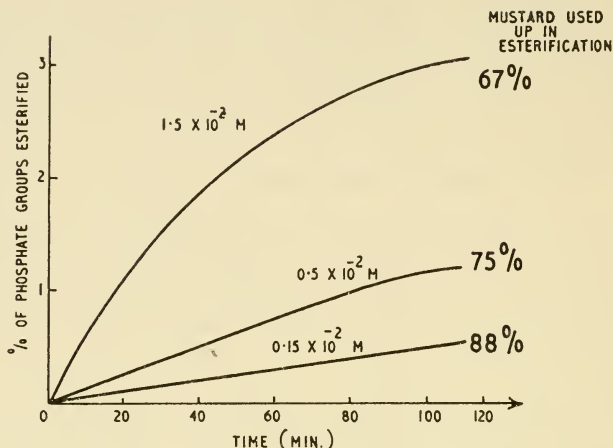

FIG. 4. Reaction of three different concentrations of phenylalanine mustard with a 10% suspension of herring sperm heads. The percentage of esterification was computed from the amount of acid liberated.

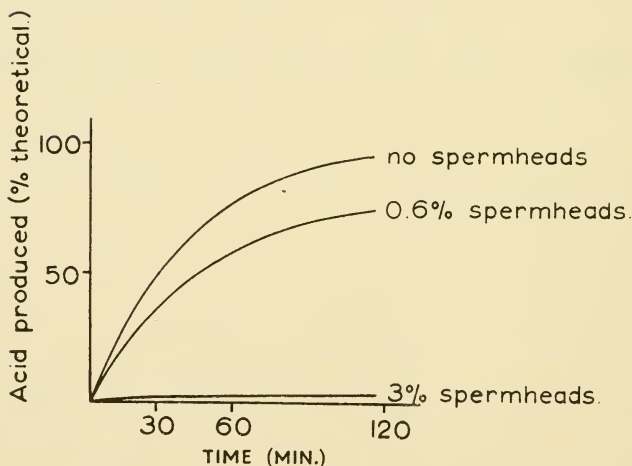

FIG. 5. Reaction of herring sperm heads with chlorambucil, the negatively charged mustard which does not react with DNA. The decrease in the amount of acid produced in the presence of the sperm heads shows that extensive esterification of the nucleoprotein occurs.

The negatively charged mustard, chlorambucil, reacts readily with the sperm heads (Fig. 5) presumably because unlike the nucleoproteins it does not carry a negative charge which repels the mustard. The apparent paradox of a highly mutagenic mustard which does not react with DNA has thus been eliminated.

Reaction with RNA

RNA obtained by the method of Kay, Simmons and Dounce (1953) from rat liver was reacted with the phenylalanine mustard. The course of the reaction was followed on

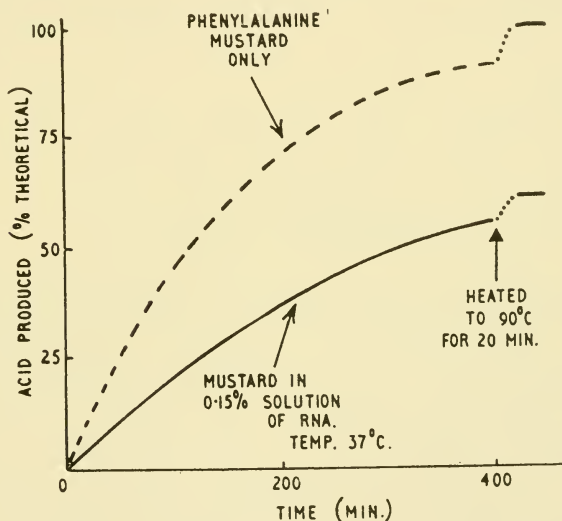

FIG. 6. Rate of acid formation when 0.1% phenylalanine mustard reacts with RNA.

the automatic titrator (Fig. 6) and the reduction in acid production shows that as with DNA there is very extensive reaction with phosphate groups. But the esters formed are stable and no appreciable acidity was produced on heating. Since reaction with the primary phosphate groups would give



triesters which should be less stable than those from DNA (Brown and Todd, 1952) it seems highly improbable that the reduction in the amount of acid produced is due to esterification of the primary phosphate groups. The stable esters which are formed may be diesters derived from esterification of the secondary phosphate groups at the end of the chain. These, of course, would be very much more numerous in the relatively low-molecular weight RNA than in DNA. However, this whole reaction needs much more detailed study.

Crosslinking of DNA

When assessed by growth inhibition and the production of chromosome breaks, the biological activity of alkylating agents containing more than one reactive group per molecule is in general much greater than that of monofunctional compounds (Haddow, 1953). Although a direct comparison has only been made in relatively few cases (Fahmy and Fahmy, 1956; Zamenhof *et al.*, 1956) this same difference seems to persist also for mutagenicity.

In principle, there are three reactions which distinguish a bifunctional from a monofunctional reagent: the ability to form crosslinks between different molecules (intermolecular reaction); to join different groups in the same molecule (intramolecular reaction) and to form rings by reacting twice with the same group (e.g. $\text{RNH}_2 + \text{X} \cdot \text{M} \cdot \text{X} \rightarrow \text{RN} \rangle \text{M} + 2\text{HX}$) or on two adjacent groups (Fig. 7). Since compounds which are sterically prevented from forming a ring by double alkylation such as $\text{CH}_3 \cdot \text{SO}_2\text{O} \cdot \text{CH}_2 \cdot \text{C} \equiv \text{C} \cdot \text{CH}_2 \cdot \text{O} \cdot \text{SO}_2\text{CH}_3$ are highly mutagenic, this last possibility need not be considered.

With a relatively flexible macromolecule like DNA, intramolecular crosslinking will predominate in dilute solution, while in more concentrated solutions reaction between molecules will take place. Using synthetic polymers (Stacey *et al.*, 1957) the change-over from one type of mechanism to the other was followed in detail and was found to take place over a remarkably small range of concentration.

When the reaction occurs within the same molecule it causes a reduction in viscosity (Alexander and Fox, 1952) because the molecule is coiled up so that it occupies less volume*. On intermolecular reaction the viscosity of the solution rises steadily until quite suddenly it sets to a gel, when the number of crosslinks formed exceeds, on average, one per molecule.

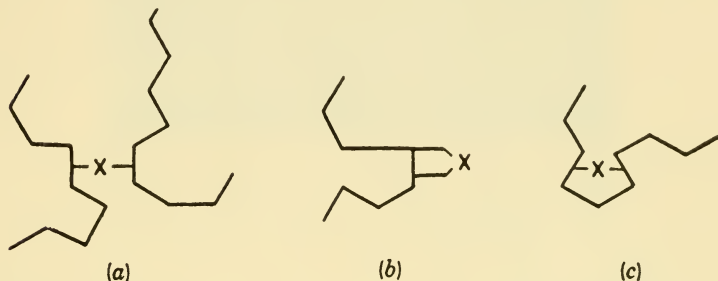

FIG. 7. Different types of reactions produced by bifunctional reagents with a flexible macromolecule like DNA

- (a) Intermolecular crosslinking.
- (b) Reaction with neighbouring groups.
- (c) Intramolecular crosslinking.

Internal crosslinking can be recognized very clearly from light scattering measurements. By plotting the light scattered at different angles, as shown in Fig. 8, the volume occupied by the molecule in solution (expressed as the radius of gyration) is given by the slope and the molecular weight by the intercept (the smaller the value for the intercept the higher the molecular weight). Using this technique it is clear that the first change produced by a polyfunctional reagent is to

* The viscosity of a solution of a macromolecule depends both on the size and shape of the molecule dissolved, and a reduction will be observed both after a reaction which degrades the molecule into smaller fragments and after internal crosslinking which causes a reduction in size. Following the observations of Chanutin and Gjessing (1946) and Sparrow and Rosenfeld (1946) that the viscosity of DNA solution was reduced by treatment with nitrogen mustard and X-rays respectively, Butler (1950) assumed that both agents degraded the molecule. We now know (see p. 310) that initially the two reactions are quite different. While radiation degrades, the mustards reduce the viscosity by internal crosslinking.

coil up the molecule (see Table IV) and only after very extensive reaction is there a fall in molecular weight (this will be discussed on p. 315). With a monofunctional reagent such

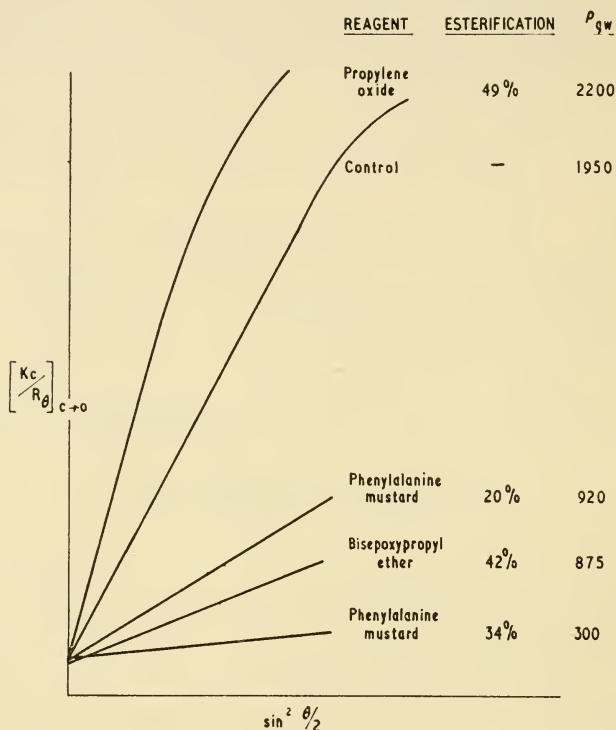

FIG. 8. Light scattering plots (the reciprocal of the scattering at each angle is plotted as a function of that angle), for DNA treated with various alkylating agents.

$\rho_{g,w}$, the radius of gyration which is obtained from the slope of the corresponding line, is a measurement of the extension in space of the DNA molecule after reaction. The molecular weight is inversely proportional to the intercept.

as propylene oxide no change in shape or molecular weight is observed, proving that esterification of the phosphate groups alone is not sufficient to coil up the molecule.

Electron microscope photographs (Fig. 9) also reveal the



FIG. 9a. An electron micrograph of DNA which shows the tendency of two molecules to come together as a side-by-side aggregate under the conditions used in these experiments.



FIG. 9b. An electron micrograph at a lower magnification which shows how, under these conditions, native DNA is stretched out by surface tension.

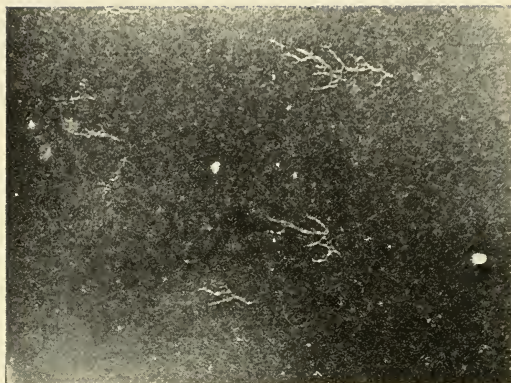

FIG. 9c. An electron micrograph of DNA after reaction with phenylalanine mustard. The cross-links have prevented the straightening and the enforced proximity of different points of the chain has facilitated the side-by-side aggregation and has caused the collapse of the molecule into these shapes.

Table IV

THE INITIAL EFFECT OF ALKYLATION ON THE SIZE OF DNA

<i>Reagent</i>	<i>%</i>	<i>Molecular weight</i>	<i>Radius of gyration</i>
Control	—	6.4×10^6	2000
CB. 3025 (phenyl- alanine mustard)	6	6.0×10^6	1100
	~20	5.4×10^6	980
	21	6.0×10^6	1080
	26	2.7×10^6	350
	34	8.0×10^5	220
	53	8.0×10^5	200
HN2	~10	6×10^6	1530
	~25	4.8×10^6	1040
CB. 1348 (chlorambucil)	0	5.8×10^6	1800
Propylene oxide	49	6.7×10^6	2200
Bisepoxypropyl ether	20	20×10^6	1350
	42	7.4×10^6	875

effect of internal crosslinking, and the difference in appearance between untreated * DNA and DNA after reaction with a nitrogen mustard is most marked. On drying, the various strands in the internally crosslinked DNA molecule are pulled together to give the patterns seen. In solution, the electrostatic repulsion of the phosphate groups opens up the molecule into a more sponge-like structure.

Intermolecular crosslinking of DNA is found after treatment of the sperm heads with bifunctional alkylating agents. The untreated nucleoprotamine dissolves completely in 2 M sodium chloride to give highly viscous solutions but after reaction with bifunctional alkylating agents a proportion of the nucleoprotamine is present as a highly swollen gel, the presence of which cannot usually be detected by inspection. Centrifuging for one hour at 20,000 *g* spins down this gel without producing any sediment in the control solution. The proportion of DNA present as gel after a variety of treatments is shown in Table V. The gel is composed entirely of DNA and contains no protamine. This means that the crosslinking

* DNA molecules are not rigid rods and the linear appearance of the untreated DNA is brought about by surface tension during drying which pulls out the molecules.

Table V
CROSSLINKING OF DNA IN SPERM HEADS

<i>Alkylating agent used</i>	<i>% phosphate groups esterified</i>	<i>Fraction of DNA rendered insoluble in 2M-NaCl *</i>
$\begin{array}{c} \text{COOH} \cdot \text{CH} \cdot \text{CH}_2 \cdot \text{C}_6\text{H}_4 \cdot \text{N} \cdot (\text{CH}_2\text{CH}_2\text{Cl})_2 \\ \\ \text{NH}_2 \end{array}$ <p style="text-align: center;">CB. 3025</p>	2.6	16
	7.7	83
	14.3	91
$\text{COOH} \cdot (\text{CH}_2)_3 \cdot \text{C}_6\text{H}_4 \cdot \text{N}(\text{CH}_2\text{CH}_2\text{Cl})_2$ <p>Chlorambucil</p>	3.4	38
	10.5	84

* Insolubility was defined as DNA removed by centrifuging at 20,000 *g* for 1 hour. If the dispersion of the sperm heads is carried out carefully no DNA from untreated sperm heads is removed under these conditions.

occurs only between DNA molecules, and that reaction with protein plays no part.

Why are the nucleophilic alkylating agents mutagenic?

All attempts to obtain reaction between DNA and compounds such as triacrylformal (see page 295) and thiol esters ($\text{R} \cdot \text{S} \cdot \text{CO} \cdot \text{R}'$), which react readily with amino groups in proteins and single model substances, have in our hands been quite unsuccessful. It seems likely that in native DNA the purine and pyrimidines cannot readily undergo reactions for steric or other reasons. On the basis of the Watson and Crick model this seems very likely and the most vulnerable points to attack in DNA are the phosphate groups. The reason why the nucleophilic alkylating agents are so highly mutagenic is that they are one of the few classes of substances which can react with intact DNA†. Reaction with phosphate groups may not be necessary *per se* for mutagenic action but it happens to be the only way by which DNA can be attacked easily under mild conditions.

† Alkylation of amino groups by epoxides probably occurs after the molecule has been disrupted due to extensive reaction with the phosphate groups.

Many radiomimetic effects such as growth inhibition can probably be explained on a DNA "deletion" hypothesis, i.e. they are the result of rendering DNA, in one way or another, useless to the cell. Obviously, crosslinking both intra- and inter-molecular will be most effective for this purpose since a very few reactions per molecule entirely alter its physical character and are bound to render it biologically inactive. Monofunctional reagents, on the other hand, will only esterify isolated phosphate groups and it seems very reasonable that the blocking of a few of these may be sufficient to spoil the molecule and that a number of these random esterifications are necessary before biological activity is lost. This would explain why higher concentrations of the monofunctional compounds have to be used to produce the same effect.

Probably the lethal as well as some visible and biochemical mutations can be satisfactorily explained by this DNA "deletion" hypothesis since they are manifestations of the loss of a gene. The major difficulty is to explain how non-selective reactions like the alkylation of phosphate groups can produce a change in gene function as opposed to a general destruction of the molecule for biological purposes. We must look to much more subtle processes than crosslinking for causing a rearrangement of a DNA molecule so that it retains its biological integrity but carries a different code. Although we are in no position to put forward any hypothesis, experiments on the production of isolated breaks in one of the chains of the twin molecules may provide the basis for a possible mechanism.

The possible significance of "hidden breaks"

A break produced in one of the twin chains of DNA does not lead to a disruption of the molecule since this is maintained intact by the other chain. A decrease in the particle size will only occur when there are interruptions in both chains close together (i.e. within about 50 Å) (Fig. 10). The hidden breaks can, however, be revealed if the twin chains are

separated and this can be done with DNA from herring sperm (Alexander and Stacey, 1955*a* and *b*; 1957*a*), by exposing a dilute solution to 4M urea when the molecular weight is halved, from 6×10^6 to 3×10^6 , without affecting the length of the molecule. After irradiation with X-rays the molecular weight of the DNA when measured in salt falls much less rapidly than the molecular weight determined after dissociation by urea, because eight out of ten of the breaks occur in

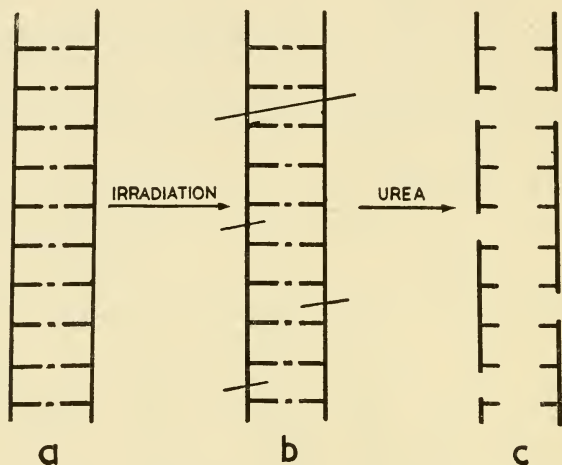

FIG. 10. A diagrammatic representation of the effect of urea on irradiated DNA which shows how breaks hidden in the dimeric structure (*b*) become apparent in urea solution when all the hydrogen bonds are broken.

one of the chains only and remain hidden until the molecule is split* (Alexander and Stacey, 1956). When α -rays are used no hidden breaks are produced because the destruction along the track of the particle is so intense that both chains are invariably broken when crossed by an α -particle (Stacey and Alexander, 1957).

Breaks in the chain are also produced by the alkylating

* The double breaks are not due to a chance event whereby two ionizations are produced close together in each of the two chains. They are probably produced by the densely ionizing tail portion of each electron track.

agents as a result of the instability of the triesters produced. Although in the majority of the hydrolyses the alkylating agent is split off again, occasionally the sugar ester is hydrolysed and this brings with it an interruption of the chain. Table VI illustrates the change (on standing at 37° C) in

Table VI

PRODUCTION OF "SINGLE" AND "DOUBLE" BREAKS IN DNA

<i>Reagent used</i>	% <i>Esterification</i>	<i>Molecular weight</i> × 10 ⁶ <i>in salt soln.</i>	<i>in urea soln.</i>
None	0	6-6.4	3-3.5
propylene oxide			
24 hrs. at 0° C	49	6.7	0.2
24 hrs. at 37° C		3.3	0.1
butadiene bisepoxide			
24 hrs. at 0° C	42	7.5	3.2
24 hrs. at 37° C		2.15	0.77
<i>l</i> -phenylalanine mustard			
24 hrs. at 0° C†	3	6.0	2.85
24 hrs. at 37° C		6.0	2.25
24 hrs. at 0° C	20	5.4	1.8
24 hrs. at 37° C		3.05	1.1
24 hrs. at 0° C	27	2.7	1.05
60 hrs. at 37° C		0.15	—
24 hrs. at 0° C	53	0.8	—

† Even this small degree of esterification was sufficient to bring about appreciable internal crosslinking.

molecular weight due to hydrolysis of DNA treated with alkylating agent. The existence of hidden breaks is very clearly revealed after extensive treatment with the mono-functional epoxide, propylene oxide. The molecular weight of the double molecule is unchanged while after splitting it is reduced to approximately one-fifteenth. With the bifunctional reagents the number of hidden breaks cannot be determined since the two chains are covalently crosslinked and this prevents the splitting into two strands by the urea except when there are breaks in the main chain to compensate for

the crosslinks. The situation here is too complex to be analysed by the methods available to us.

Molecules with hidden breaks appear to retain all their normal properties and it is conceivable that they continue to exercise their biological function but that they transmit a slightly altered code.

Summary

Chemical considerations suggest that the essential characteristic of the radiomimetic alkylating agents (i.e. sulphur and nitrogen mustards, epoxides, ethylene imines and esters of methanesulphonic acid) is their ability to esterify anions such as the carboxyl groups of proteins and the phosphate groups of DNA and RNA. These substances can also alkylate amino and sulphydryl groups. These reactions, although they undoubtedly occur in the cell, are unlikely to be of biological importance since many other substances which can react with amino and SH groups but not with anions are biologically inactive.

In proteins, the radiomimetic alkylating agents react with all the available groups such as NH_2 , SH and COOH but in DNA only esterification of the phosphate groups is found unless the reagent is present in excess. The steric configuration of the DNA probably screens the purine and pyrimidine bases and this is confirmed by the failure of substances, which readily combine with amino groups in proteins, to react with DNA under physiological conditions. Probably the reason why the radiomimetic alkylating agents are such effective mutagens is because they can combine with the most vulnerable group in the DNA, the phosphate group.

Esterification of phosphate groups is also the most prominent reaction when a nucleoprotein (herring sperm heads) is treated with nitrogen mustards. The protamine does not block the phosphate groups in such a way as to prevent alkylation.

The polyfunctional alkylating agents, which are much more active, crosslink DNA. In dilute solution the crosslinks are

formed within one molecule which then becomes distorted. When the nucleoprotamine is treated, crosslinks are formed between different DNA molecules which are thereby rendered insoluble and form a gel when the nucleoprotein is dispersed in strong salt. The greater effectiveness of the bifunctional reagents is attributed to crosslinking which is a much more efficient process of spoiling DNA than the isolated blocking of phosphate groups which is the only reaction produced by the monofunctional reagents.

The triesters formed when the phosphate groups of DNA are alkylated, are unstable and occasionally hydrolyse to give a break in one of the polynucleotide strands of DNA. These breaks are masked by the other chain of the twin molecule and can only be revealed by special techniques. The formation of these hidden breaks may provide a mechanism for the rearrangement within a DNA molecule without at the same time so altering its configuration as to make it useless to the cell. In this way DNA might be made to transmit an altered code.

Acknowledgement

This investigation has been supported by grants to the Royal Cancer Hospital and Chester Beatty Research Institute from the British Empire Cancer Campaign, the Jane Coffin Childs Memorial Fund for Medical Research, the Anna Fuller Fund, and the National Cancer Institute of the National Institutes of Health, U.S. Public Health Service.

REFERENCES

- ALEXANDER, P. (1952). *Nature, Lond.*, **169**, 226.
ALEXANDER, P. (1954). *Advanc. Cancer Res.*, **2**, 1.
ALEXANDER, P., and FOX, M. (1952). *Nature, Lond.*, **169**, 572.
ALEXANDER, P., and STACEY, K. A. (1955a). *Biochem. J.*, **60**, 194.
ALEXANDER, P., and STACEY, K. A. (1955b). *Nature, Lond.*, **176**, 162.
ALEXANDER, P., and STACEY, K. A. (1956). *Progress in Radiobiology*, p. 105, London: Oliver and Boyd.
ALEXANDER, P., and STACEY, K. A. (1957a). *Experientia*, **13**, 307.
AUERBACH, C., and ROBSON, J. M. (1944). *Nature, Lond.*, **154**, 87.
BACQ, Z. M. (1946). *Bull. Acad. Méd. Belg.*, **11**, 137.
BERGEL, F., and STOCK, J. A. (1954). *J. chem. Soc.*, 2409.
BROWN, D. M., and TODD, A. R. (1952). *J. chem. Soc.*, 52.

- BUTLER, J. A. V. (1950). *Nature, Lond.*, **166**, 18.
- CHANUTIN, A., and GJESSING, E. C. (1946). *Cancer Research*, **6**, 599.
- COUSENS, S. F. (1956). Reactions of some Chemical Carcinogens with Macromolecules. Ph.D. Thesis, University of London.
- DUSTIN, P. (1947). *Nature, Lond.*, **159**, 794.
- ELMORE, D. T., GULLAND, J. M., JORDAN, D. O., and TAYLOR, H. F. W. (1948). *Biochem. J.*, **42**, 308.
- FAHMY, O. G., and FAHMY, M. J. (1956). *J. Genet.*, **54**, 146.
- FELIX, K., FISCHER, M., and KREKELS, A. (1956). *Progress in Biophysics*, **6**, 1.
- HADDOW, A. (1953). In *Physiopathology of Cancer*, p. 475. New York: Hoeber.
- HENDRY, J. A., ROSE, F. L., and WALPOLE, A. L. (1951). *Brit. J. Pharmacol.*, **6**, 201.
- KAY, E. R., SIMMONS, N. S., and DOUNCE, A. L. (1952). *J. Amer. chem. Soc.*, **74**, 1724.
- KAY, E. R., SIMMONS, N. S., and DOUNCE, A. L. (1953). *J. Amer. chem. Soc.*, **75**, 4041.
- OGSTON, A. G. (1948). *Trans. Faraday Soc.*, **44**, 45.
- PETERS, R. A. (1947). *Nature Lond.*, **159**, 149.
- ROSS, W. C. J. (1953). *Advanc. Cancer Res.*, **1**, 397.
- SPARROW, A. M., and ROSENFELD, F. M. (1946). *Science*, **104**, 245.
- STACEY, K. A., and ALEXANDER, P. (1957). *Trans. Faraday Soc.*, **53**, 251.
- STACEY, K. A., COBB, M., COUSENS, S. F., and ALEXANDER, P. (1957). *Ann. N.Y. Acad. Sci.*, in press.
- ZAMENHOF, S., LEIDY, G., HAHN, E., and ALEXANDER, H. E., (1956). *J. Bact.*, **72**, 1.

DISCUSSION

Rose: Most of our work over the past ten years with alkylating agents in general, such as those mentioned by Dr. Alexander, has been in the cancer field, but in this last year or two we have investigated their effects in the field of microbiology. The substance I want to mention now is one of the very simplest derivatives of ethyleneimine, namely acetyl ethyleneimine. This substance is freely soluble in water, gives neutral solutions, neither anionic nor cationic, and its chemistry is rudimentary. Yet this substance is a frank carcinogen. Doses of no more than 1 mg./kg. body weight, given subcutaneously into the flank of a rat, produce local sarcoma in very high yield: out of a dozen rats you can usually get at least ten of them bearing tumours, after a period of 200 days onwards. A few tumours are often formed at distal points, for example in the sebaceous glands of the ear, and so on. However, we feel convinced that this substance is a direct carcinogen. Fairly recently Dr. Pryce has been examining the action of this substance on *chromobacterium prodigiosum* (*Serratia marcescens*), the organism which produces the tripyrryl red pigment, prodigiosin. Pryce incubates this organism in the usual way in broth, and harvests the organisms towards the end of the logarithmic

period of growth. He then suspends the organisms in a fairly concentrated suspension, usually containing about 10^{10} organisms/ml., and incubates them in the presence of saline and varying concentrations of acetyl ethyleneimine. After exposure to concentrations of acetyl ethyleneimine of the order of 1 in 10,000 for 18 hours, the suspension is plated out and he finds that about 90 per cent of the organisms have been killed (this substance is quite markedly bactericidal). A high proportion of abnormal colonies is found amongst the survivors; since after 18 hours' incubation on the plate there is a mixture of colonies ranging through white, shades of pink, to red for 24 to 48 hours, then eventually the normal full deep red colour is obtained. In other words there is a delayed pigmentation effect, which is also seen but to a much smaller extent, in control cultures. However, Pryce finds that if he takes a higher concentration of acetyl ethyleneimine (say 1.5 per cent) he only gets a survival of about 1 in 10^8 or 10^9 . The survivors produce colourless colonies, very slow growing, and these properties are retained after repeated serial subculture. These organisms fail to ferment many of the sugars that the parent strain ferments quite easily. As a matter of chemical interest, I might mention that every once in a while, a greenish-yellow variant is produced, but which pigments to the normal colour by contact with a gaseous metabolite seemingly produced by cultures of the normal parent strain. A greenish-yellow pigment has been isolated from these variants and we have shown it to be a pyrrole derivative, evidently an intermediate in the biosynthesis of prodigiosum itself. Prof. Birch at Manchester is culturing this particular variant in quantity and isolating the greenish-yellow pigment with a view to determining its structure. The point I want to make is that there we have a substance that is a carcinogen, which seems to have produced these apparently permanent changes in a micro-organism.

Westergaard: To return to these bifunctional compounds, we are not too happy about crosslinking reactions and induction of mutations. What we do study in these *Neurospora* tests is the back mutation process. We find that bifunctional compounds are exceedingly efficient on one adenine strain, but so also are monofunctional compounds. The correlation is by no means striking.

Alexander: This is interesting, because in a way it can be made to fit in with what I have just said. If we study cytotoxic phenomena and so on, where presumably just the deletion or loss of DNA is sufficient to produce damage, there the bifunctional or ability to crosslink is the key thing, because it removes DNA as a useful material from the cell much better than a monofunctional agent. When one comes to the more subtle, positive mutations, where a rearrangement is postulated to follow as a result of single breaks, then one would not expect that a bifunctional compound would be any more effective than a monofunctional since it would not give rise to any greater number of single breaks.

Westergaard: We do find in the monofunctional compound that there is a rather striking correlation between the positive charge on the carbonium ion and the mutagenic effect on the adenine strain. This is the only correlation that we have been able to establish so far with the

monofunctional compound. The stronger the positive charge, the more mutagenic it is.

Pontecorvo: Dr. Alexander, you showed us electron micrographs of drastically modified DNA molecules. Those were molecules having a molecular weight of 6 million; suppose that instead of numerous molecules of mustard per molecule of DNA you had only one, then they would probably be modified in a less drastic way?

Alexander: The physicochemical methods are of course much cruder than any biological method, but even physicochemically one can show that these molecules are coiled up, i.e. internally crosslinked after only something like 60 reactions have occurred. This is already sufficient to lower the light-scattering curve substantially, showing that the shape of the molecule has been restricted internally. The cell can probably distinguish very much finer changes. So far as forming these gels goes, when we treat the complete nucleoprotein something like 20 reactions is already sufficient to change the DNA from being a soluble material into a crosslinked gel. Therefore, if one makes allowance for the much less refined techniques, one gets down to the orders of magnitude which one might encounter in biology. Few reactions can so effectively modify a big molecule like DNA as an internal crosslink which enforces an unnatural shape on it.

Davis: If agents with polyfunctional groups are mutagenic by virtue of a crosslinking reaction with DNA, I agree with Dr. Alexander that it seems difficult to see how they could lead not only to loss of an enzyme-forming capacity but also to reversion of this loss. However, the difference in mechanism between a loss and a gain may not be so great if we consider that a crosslinking group might distort rather than destroy the function of the altered region of DNA. Because, though the gene normally reduplicates itself precisely, DNA with an added crosslinking group can hardly be expected to duplicate that group. Instead, a mutation might arise if the added group so distorted the parent DNA that it served as a template for forming a third DNA, neither crosslinked nor identical with the original. This DNA could perpetuate its alteration in future generations. In turn, one might imagine that on further mutagenic treatment a crosslinking group could so distort the mutant gene that its progeny turned out to be the original gene again.

Alexander: I think this is quite feasible. I am impressed by the subtlety of these refined biological reactions and I felt that to modify a code, this mechanism is too crude. That was why I suggested that these hidden breaks might form a better starting point for looking at this problem. I must also admit that I had in mind that the great superiority of the polyfunctional agent is usually associated with toxic effects; e.g. Dr. Fahmy finds that the polyfunctional agents are vastly superior to the monofunctional when he scores lethals in his *Drosophila*. Yet when we come to something more decisive, like a back mutation, Prof. Westergaard does not find this difference.

Hayes: When you put your DNA into urea, it breaks down. Do you mean that the two helices come apart, and if so how do they come apart? Surely they don't come apart without breaks?

Alexander: We believe that the two strands of the DNA molecule can be separated in dilute solution by the addition of concentrated urea (4 M); the molecular weight falls to half without a change in dimensions. All our physicochemical data is comparatively consistent with this data. In fact, it would be difficult to envisage a process other than this splitting by which the molecular weight of a molecule is reduced to half while its length remains unchanged. The problem remains, why do they come apart? An important point to remember in this connexion is that they only come apart if the solutions are extremely dilute, i.e. less than 0.05 per cent of DNA. Clearly, the only forces which we can invoke are Brownian motion. If we had to postulate that one of the strands unwound around the other by a rotating motion, then for a molecule of the dimensions of DNA this would take something like 140 days before 10,000 turns all in the right direction had occurred. Prof. W. Kuhn has, however, solved this problem in a most ingenious manner (1957, *Experientia*, 13, p. 301): if after breaking all the hydrogen bonds holding the purine and pyrimidine bases together by adding urea, the double spiral only increases in diameter by some 20 per cent, then the two strands are sufficiently far apart to be able to move through one another without any trouble. This increase in diameter is readily achieved if one assumes that the centre of the molecule remains fixed and the two ends rotate in opposite directions about 500 times. This process occurs quite quickly by Brownian motion (average time required for a molecule of the size of DNA is about 30 to 40 seconds). If this has occurred, the two molecules may well have to move apart, and this again by Brownian motion only requires about 20 to 30 seconds. There is, therefore, a very high probability that both processes will occur (i.e., the two strands will have become separated) within a minute or so.

In our experiments, we could not measure the time required since it takes a minute or so for the concentrated urea to be satisfactorily mixed into the DNA solution. This time of mixing is quite sufficient for the separation to occur. I would like to stress that the method of separation is not a physiological process and can only occur in the artificial situation in which we have studied DNA.

Hayes: It is very hard to visualize this without a model, unless you are accustomed to thinking in terms of double helices, but how DNA replicates is an important biological problem from the genetic point of view. Is Prof. Kuhn's theory applicable to separation of the two helices during DNA replication?

Alexander: This particular mechanism which Prof. Kuhn has worked out could not apply to the cell. It applies to the artificial situation of DNA in very dilute aqueous solution. We cannot get urea to split DNA when this is at a concentration greater than 0.05 per cent. We can only do it when it is extremely dilute, because once the two chains begin to touch one another they interfere with the uncoiling process.

Pontecorvo: Would the Levinthal speedometer-cable system of unwinding apply to your conditions?

Alexander: That does not get you very much further because you then have to postulate a directive and energy-consuming mechanism for

doing it, and you are just moving the problem one stage further. If it comes apart in the cell, there must be a very subtle mechanism.

Lederberg: It is not quite so bad as that. If you build on additional nucleotides, that will do the unwinding and provide the energy for the turning as well. You have a directed mechanism.

Walker: Is the Kuhn model satisfactory from the stereochemical point of view? Can urea get in to direct its hydrogen-bonding power to break the hydrogen bond?

Alexander: The structure is quite open, and urea can get in quite easily. The problem is never one of the urea splitting the hydrogen bonds between the bases, but of getting the strands apart.

Walker: There are directional stereochemical effects involved in the hydrogen bonding.

Alexander: The dissociation only occurs with 4 M urea. The hydrogen bonds are opened up and remade with the urea, and there is no directional effect; the only directional effect occurs when they are originally formed. We cannot in the test tube reconstitute the two isolated strands to reform DNA.

Lederberg: How much re-aggregation do you get if you dialyse the urea away?

Alexander: Very much. Once the urea is dialysed away the single strand aggregates and, in the electron microscope, DNA after treatment with urea has the appearance of a matted mass and no long thin strands which are typical of native DNA can be seen.

Hayes: I understand that when DNA transforming principle is treated with urea in order to break the molecular weight, especially to prevent the aggregation of large lumps, it still retains its transforming potentiality.

Alexander: Herring sperm head DNA and the DNA obtained from *Esch. coli* are the only specimens that we found to be split by urea. DNA which we have obtained from thymus is not split by urea, until it has been treated with relatively high concentrations of versene. We first thought this was because metals formed additional bonds which held the strands of DNA together; but we now believe that it is due to protein contamination. Only from herring sperm, because this sperm is such a particularly clean material, does one get DNA which is really free from protein—there is less than 0.01 per cent protein in it. As soon as the protein contamination is of the order of 0.5 per cent then the material does not split any more.

GENETICS OF TWO DIFFERENT MECHANISMS OF RESISTANCE TO COLICINS: RESISTANCE BY LOSS OF SPECIFIC RECEPTORS AND IMMUNITY BY TRANSFER OF COLICINOGENIC FACTORS

PIERRE FREDERICQ

Department of Microbiology and Hygiene, University of Liège

Introducing colicins and colicinogenic factors

MANY strains of *Escherichia coli* or related strains produce antibiotic substances known as colicins (Fredericq, 1946*a*). These colicins are highly specific antibiotic agents which kill susceptible bacteria belonging to the same family, mostly other *Esch. coli* or *Shigella sonnei* strains (Fredericq and Levine, 1947; Fredericq, 1948*d*; Halbert, 1948; Mondolfo, 1948; Chabbert, 1950; Grosso, 1950; Blackford, Parr and Robbins, 1951; Levine and Tanimoto, 1954).

Colicins produced by various strains may differ by many characteristics: extent and specificity of their activity spectra, specificity of resistant mutants, morphology of inhibition zones in agar, diffusibility, thermoresistance, susceptibility to proteolytic enzymes (Fredericq, 1948*d*; Chabbert, 1950), electrophoretic motility (Ludford and Lederer, 1953) and antigenic properties (Bordet, 1947; Goebel, Barry and Shedlovsky, 1956; Hamon, 1956*a*).

Despite their diversity, all colicins studied give the general reactions of polypeptides or proteins (Heatley and Florey, 1946; Halbert and Magnuson, 1948; Depoux and Chabbert, 1953; Gardner, 1950). Colicin K, which was recently purified by Goebel and co-workers (1955), appears to be a macromolecular substance, consisting of carbohydrate, protein and lipid, and containing 6.5 per cent nitrogen and 1.6 per cent

phosphorus. Its X-ray inactivation curves indicate a molecular weight somewhere between 60,000 and 90,000 (Latarjet and Fredericq, 1955).

Colicinogenic properties are extremely stable hereditary characteristics. The *V. coli*, isolated by Gratia in 1925, still produces the same colicin today, and many strains studied for over 10 years showed no variation in their colicinogenic properties. In view of their hereditary stability and of their constancy, colicinogenic properties must be governed by genetic factors which induce colicin synthesis and ensure their genetic continuity. The hereditary stability, however, is not absolute. Colicinogenic strains may show variations in the amount of colicin produced, and even yield rare mutants which have permanently lost their colicinogenic properties (Fredericq, 1948*d*).

The genetic factors governing colicin production can be transferred from a colicinogenic strain to a non-colicinogenic one in mixed culture (Fredericq, 1954*a*). The efficiency of this transfer is quite variable and a selective technique is often required to demonstrate it. The transfer may be from colicinogenic *Esch. coli* strains to other non-colicinogenic but related strains such as other *Esch. coli*, *paracoli*, *Sh. sonnei* (Fredericq, 1954*a*), or even *Klebsiella pneumoniae*, *Salmonella typhi* and *Salmonella para B* (Hamon, 1956*b*). Conversely colicinogenic *Sh. sonnei* or *S. para B* may also transfer this property to *Esch. coli* strains.

Strains made colicinogenic in this way retain all characteristics which marked the original non-colicinogenic strain and differ only from it by the newly acquired colicinogenic property. This isolated transfer of a single trait by mixed culture of two strains comes within the range of phenomena which Lederberg (1952) called transduction. This term is often used in the restricted sense of a genetic transfer by means of phage particles but, as far as can be judged, phages play no part in the transduction of colicinogenic properties (Fredericq, 1954*b*).

Transduction is specific for each colicin considered and

transduced strains always produce a colicin identical with that of the transducing strain. A strain already transduced for a given colicin may still be transduced by a strain producing another colicin and so yield two distinct colicins. A strain already transduced may in turn transfer the newly acquired colicinogenic property to another strain (Fredericq, 1954c).

Transfer of a colicinogenic property is extremely rapid, at least during the initial stage, and can be obtained by mixing the two cultures for only a few minutes. So far, it has proved impossible to extract the transducing agent or even to separate it from the living cells.

Transduction of a colicinogenic property seems to require contact and probably conjugation of two cells. Transduction in series, investigated in *Esch. coli* K 12, indeed revealed that the transducing activity is linked with F^+ sexual polarity and that an F^- colicinogenic strain is unable to transduce, unless it is first transformed into F^+ (Fredericq, 1954c).

Despite the intervention of the F^+ sexual factor, transduction of the colicinogenic properties appears to be quite independent of recombination of the other genetic characters. In crosses experiments, colicinogenic factors are not linked with any of the numerous other markers studied and colicin production is not allelic with absence of colicin production. When the F^- parent is colicinogenic, all recombinants, without exception, are likewise colicinogenic, whatever markers may be involved in the selection; but some recombinants, up to 70 per cent, still receive the colicinogenic properties when they are borne by the F^+ parent. Colicinogenic factors are therefore completely independent of the normal genetic structure of the bacteria (Fredericq and Betz-Bareau, 1953a and b, 1956).

Resistance by loss of specific receptors

Patterns of susceptibility towards colicins differ extremely from one strain to another. Some strains, like *Esch. coli* B or K 12, are susceptible to all colicins; others may be resistant

to most of them. Sensitivity is controlled by a number of receptors, specific for each colicin to which a strain is susceptible. A resistant mutant, derived from a strain susceptible to many different colicins, does not lose all at once the general susceptibility of that strain. It only resists the particular colicin which selected it but remains sensitive to the other colicins acting on the mother strain (Fredericq, 1946*b*, 1948*d*).

These colicin receptors are fixation receptors. Colicins must first attach to the susceptible bacteria before killing them. Survival curves are exponential and express the adsorption phenomenon underlying colicin action (Fredericq, 1952*b*; Jacob, Siminovitch and Wollman, 1952; Fredericq and Delcour, 1953). Colicin receptors may be extracted from susceptible bacteria and these extracts specifically neutralize the corresponding colicins by fixing them. Similar extracts prepared from resistant bacteria are inactive (Bordet and Beumer, 1948). Antibacterial sera have no direct anticolicin action but they protect sensitive bacteria against the later action of colicins, probably by masking the receptors (Bordet, 1948).

These colicin receptors are quite stable hereditary properties which characterize each susceptible strain, but may get lost by mutation. Resistant mutants arise spontaneously and are merely selected by the corresponding colicins (Fredericq, 1948*a*). Mutations affecting colicin receptors are independent of the other properties of the strain; and, conversely, mutations affecting other characters have no effect upon the receptors (Fredericq, 1948*b*). Mutations affecting these receptors are also specific and independent of one another, but in some cases cross-resistance may be observed (Fredericq, 1948*d*). A strain originally susceptible to many colicins can be transformed into a completely resistant one if all its receptors are taken away step by step in a series of successive mutations (Fredericq, 1948*c*).

Colicins may be grouped according to the receptor on which they adsorb, but the resulting groups include chemically quite

different colicins. For example, all colicins of group E attach to the same receptor of the susceptible bacteria; a mutant resistant to one will be resistant to all colicins of the group. Yet they differ in activity spectra, thermoresistance, susceptibility to proteolytic enzymes and so on (Fredericq, 1950).

Colicin receptors behave exactly like bacteriophage receptors, but are generally independent and separate from them. For example, a mutant resistant to a given colicin can retain all phage receptors as well as receptors for other colicins which characterize the mother strain. Similarly, a mutant resistant to a given bacteriophage remains susceptible to all colicins as well as to other phages which are active on the strain from which it is derived.

Systematic investigations revealed, however, that a specific reciprocal cross-resistance occurs constantly in the case of certain colicins and definite bacteriophages. Thus, all mutants selected by colicin K or by phage T 6 are in every case resistant to both agents simultaneously (Fredericq, 1949*b*). The same holds true for colicin E and phage BF 23 (Fredericq, 1949*a*), and for colicin C and phages T 1–T 5 (Fredericq, 1951).

Each of these phages adsorbs on a receptor common to the phage and to the corresponding colicin, by means of a protein located at the tip of their tail. This protein must be a substance related to colicins because it has the same specificity and, like a colicin, it kills susceptible bacteria even under conditions where the phage particles are not reproduced (Fredericq, 1952*a* and *c*). X-ray-inactivation curves of colicin K and of the lethal protein of phage T 6 revealed that both agents are of the same molecular size (Latarjet and Fredericq, 1955).

The presence of independent colicin receptors and of their genetic determinants was also demonstrated in recombination experiments. Mutants resistant to colicins, derived from the fertile *Esch. coli* K 12 strain, are easily obtainable, and crosses between susceptible and resistant parents were studied using Lederberg's (1947) technique.

The character of susceptibility to colicins behaves in these crosses like any other genetic marker, obeying the general rules of recombination (cf. Lederberg, 1955). Susceptibility and resistance to a given colicin are allelic characters which are linked to other markers and segregate with them according to the selected markers and to the F polarity of the parents (Fredericq and Betz-Bareau, 1952).

Let us take, for example, a cross where the F⁺ parent is M—TLB₁+ (methionine-dependent but threonine-, leucine- and thiamin-independent) and is resistant to colicins E, K and V; and where the F⁻ parent is conversely M+TLB₁— and is susceptible to colicins E, K and V. Most of the prototrophic recombinants are susceptible to colicin V, like the F⁻ parent, because the marker susceptibility/resistance to colicin V is not linked to any of the selected markers given by the F⁺ parent. Less recombinants will be susceptible to colicin K, thereby distinguishing the F⁻ parent, because the K marker is linked to the TL markers which must be inherited from the F⁺ parent, owing to the selective technique used. Still less recombinants will be susceptible to colicin E, because the E marker is still more closely linked to the selected B₁⁺ marker of the F⁺ parent (Fredericq and Betz-Bareau, 1952). If, now, selection is made on a minimal medium supplemented with thiamin (where B₁⁺ is no longer selected), the number of recombinants which receive resistance to colicin E from the F⁺ parent will fall considerably, but in cases where they do receive resistance to colicin E they will also display the B₁-independence of the F⁺ parent (Jenkin and Rowley, 1955).

Resistance to a given colicin may sometimes be determined at more than one locus. An auxotrophic mutant, received from de Haan (1954), and derived from *Esch. coli* B after repeated ultraviolet irradiation, was found to be spontaneously resistant to colicin E. Crosses of this B mutant with a K 12 derivative also resistant to colicin E give a proportion of fully susceptible recombinants, probably by recombinations of —+ × +— loci. A possible cumulative

resistance by action of both loci has not yet been investigated (Fredericq, unpublished).

The occurrence of receptors common to a phage and a given colicin is also confirmed by recombination experiments. In all crosses studied, there is indeed a perfect correlation between resistance/susceptibility to phage T 6 and to colicin K, and between resistance/susceptibility to phage BF 23 and to colicin E. In the cross just mentioned between *Esch. coli* B and K 12, both loci of resistance to colicin E induce resistance also to phage BF 23 and, on recombination, yield cells susceptible to both agents.

In conclusion, sensitivity is controlled by a number of receptors, specific for each colicin to which a strain is susceptible. Resistance may be achieved by mutation through loss of the corresponding receptor and behaves as an allelic marker to sensitivity in recombination experiments.

Immunity by transfer of colicinogenic factors

Colicinogenic strains are not susceptible to the particular colicin they produce but may, of course, be susceptible to other colicins. This immunity is a direct consequence of the colicinogenic property, and non-colicinogenic mutants are as a rule susceptible to the colicin produced by the mother strain (Fredericq, 1948*d*).

Colicin is not produced by every cell of a colicinogenic culture. Only cells which do not yield colicin are immune, the others are killed by the colicin they synthesize. They are, however, too few to be seen and the culture as a whole appears normal. But colicin synthesis may be induced in nearly all cells of a colicinogenic culture by many mutagenic or carcinogenic agents, more particularly ultraviolet irradiation, peroxide, ethyleneimine or halogenoalkylamine (Jacob, Siminovitch and Wollman, 1952, 1953; Lwoff and Jacob, 1952).

Colicin induction was first observed in the ML strain of *Esch. coli* and led to massive lysis of the cells (Jacob, Siminovitch

and Wollman, 1951). It was later found, however, that this ML strain is both colicinogenic and lysogenic and that lysis must rather be attributed to development of its prophage (Fredericq, 1954*d*; Kellenberger and Kellenberger, 1956). Nevertheless, colicin induction may also be obtained in strains obviously non-lysogenic but without lysis (Fredericq, 1955; Hamon and Lewé, 1955; Panijel and Huppert, 1956). Colicins, indeed, are bactericidal but not bacteriolytic agents.

Colicinogenic factors are therefore potential lethal agents whose pathogenicity is only disclosed by the achievement of their potentiality. As long as they remain in the latent condition they induce immunity to the corresponding colicin.

Strains which were originally non-colicinogenic and which have been made colicinogenic by transduction behave exactly like spontaneously colicinogenic ones. The introduction of a colicinogenic factor into transduced cells gives immunity to the colicin whose synthesis it controls, but results in the killing of the cells where that synthesis succeeds (Fredericq, 1954*a*).

Immunity of colicinogenic cultures to the colicin they produce is quite different and independent from resistance through loss of colicin receptors. Cells made colicinogenic by transduction keep the receptor of the colicin they now produce, if they already had it before transduction:

(1) When a strain possessing the receptor for colicins of group E is transduced by a strain producing a colicin of this group, it is no longer receptive to that colicin. However, it retains the receptor, because it remains susceptible to the other colicins of the group, as well as to phage BF 23 which attaches on the same receptor. On the contrary, when non-receptivity is achieved by mutation through loss of the receptor, the resistant mutants always resist all colicins of the group as well as phage BF 23. Immunity is often more specific than resistance and may serve to distinguish colicins which adsorb on the same receptor (Fredericq, 1956).

(2) Immunity and resistance behave as non-allelic markers in recombination experiments. Crosses of two parents which

are both non-receptive to the same colicin, but for different reasons (the one because it produces that colicin and the other because it has lost the corresponding receptor) may yield cells which recombine presence of the receptor received from the immune parent and absence of immunity received from the resistant one, and are therefore fully susceptible (Fredericq, unpublished).

Immunity is more or less pronounced according to the type of colicin produced. Strains made colicinogenic for a colicin of group E are apparently resistant to that colicin even if they keep the corresponding receptor. They tend, however, to lose that receptor in the course of subcultures. It is probable that spontaneous mutants are selected because cells that keep the receptor are somewhat inhibited. Strains transduced for colicin I are resistant to the level of colicin they release but may be inhibited by the same colicin in higher concentration. Immunity to colicin V is still less pronounced and strains rendered V-colicinogenic are partially susceptible to their own colicin. Their broth cultures are less turbid than those of the same strains before transduction; agar streaks develop poorly and isolated colonies are small and irregular (Fredericq, 1956).

In conclusion, transduction of colicinogenic factors introduces into transduced cells a potential lethal agent which controls colicin synthesis and induces immunity to that particular colicin as long as it remains in a latent condition.

Discussion

Resistance to colicins may be induced by two very different mechanisms: by mutation through loss of the corresponding receptors and by transfer of colicinogenic factors. These two mechanisms exactly parallel what happens with bacteriophages.

Resistance by loss of a specific receptor is readily understandable in both cases. Colicins, like bacteriophages, must first attach to the susceptible cells before completing their

action. Indeed, some bacteriophages have a tail constituent which is a substance related to colicins and by means of which they adsorb on receptors common to given colicins.

Immunity of colicinogenic strains is quite comparable to that of lysogenic strains. In both cases, it results from the presence of a potential lethal agent but persists only as long as this agent remains in a latent condition. Induction of colicin synthesis, like that of phage synthesis, kills the bacteria in which it succeeds.

It is perhaps easier to conceive of the immunity of lysogenic than of colicinogenic bacteria. In lysogenic bacteria, the presence of a DNA structure, the prophage, prevents the development of related DNA structures introduced into the cells. A single mechanism is probably responsible for hindering the development of the carried prophage as well as of the related infecting particles. In colicinogenic bacteria, on the other hand, a genetic structure, the colicinogenic factor, must not prevent the development of similar structures but the action of a quite different agent, the colicin, whose synthesis it potentially controls. This is an unprecedented example of cellular immunity to a well defined chemical substance, but nothing is yet known about its mechanism.

Colicinogenic factors, like prophages, control a potential lethal synthesis and are therefore pathogenic. In spite of the fact that they cannot mature into infectious particles set free by lysis of the cells, and require for their transfer the mechanism of conjugation, they could however be considered as bacterial viruses distinct from bacteriophages; the more so as they are independent of the normal genetic structure of the bacteria. Their relations with bacteriophages point perhaps to a common parental ancestry.

Summary

Colicins are a group of highly specific antibiotic substances produced by some strains of the family *Enterobacteriaceae*, mostly *Escherichia* and *Shigella*, and acting upon other strains

of the same family. They are protein substances with a high molecular weight and kill susceptible cells after fixation on specific receptors.

Susceptibility patterns are determined by a number of receptors, specific for each of the colicins to which the cells are susceptible. The presence of these receptors is governed by genetic factors, as shown by mutation and recombination experiments. Resistant mutants are characterized by the independent loss of only one receptor and by resistance to the corresponding colicin. Resistances to different colicins behave as independent units in recombination experiments and show well defined linkages with other markers of the parents. Colicin receptors behave exactly like phage receptors and in some cases the same receptor may be common to a given phage and colicin.

The hereditary property of producing colicin may be transduced to non-colicinogenic strains. The transduced strains retain all their other original markers, except that they become resistant to the particular colicin they now produce. This specifically acquired resistance is not due to the loss of the corresponding receptor but is dependent on the presence of the colicinogenic factor. This immunity is quite comparable to the immunity of lysogenic bacteria towards the phage they carry.

REFERENCES

- BLACKFORD, V. L., PARR, L. W., and ROBBINS, M. L. (1951). *Antibiot. Chemother.*, **1**, 392.
- BORDET, P. (1947). *Rev. Immunol.*, **2**, 323.
- BORDET, P. (1948). *C. R. Soc. Biol., Paris*, **142**, 257.
- BORDET, P., and BEUMER, J. (1948). *C. R. Soc. Biol., Paris*, **142**, 259.
- CHABBERT, Y. (1950). *Ann. Inst. Pasteur*, **79**, 51.
- DEPOUX, R., and CHABBERT, Y., (1953). *Ann. Inst. Pasteur*, **84**, 798.
- FREDERICQ, P. (1946a). *Schweiz. Z. Path.*, **9**, 385.
- FREDERICQ, P. (1946b). *C. R. Soc. Biol., Paris*, **140**, 1189.
- FREDERICQ, P. (1948a). *C. R. Soc. Biol., Paris*, **142**, 853.
- FREDERICQ, P. (1948b). *C. R. Soc. Biol., Paris*, **142**, 855.
- FREDERICQ, P. (1948c). *C. R. Soc. Biol., Paris*, **142**, 1076.
- FREDERICQ, P. (1948d). *Rev. belge Path.*, **19**, suppl. 4, 1.
- FREDERICQ, P. (1949a). *C. R. Soc. Biol., Paris*, **143**, 1011.

- FREDERICQ, P. (1949b). *C. R. Soc. Biol., Paris*, **143**, 1014.
- FREDERICQ, P. (1950). *C. R. Soc. Biol., Paris*, **144**, 297.
- FREDERICQ, P. (1951). *Leeuwenhoek ned. Tijdschr.*, **17**, 227.
- FREDERICQ, P. (1952a). *Bull. Soc. Chim. biol., Paris*, **34**, 415.
- FREDERICQ, P. (1952b). *C. R. Soc. Biol., Paris*, **146**, 1295.
- FREDERICQ, P. (1952c). *C. R. Soc. Biol., Paris*, **146**, 1406.
- FREDERICQ, P. (1954a). *C. R. Soc. Biol., Paris*, **148**, 399.
- FREDERICQ, P. (1954b). *C. R. Soc. Biol., Paris*, **148**, 624.
- FREDERICQ, P. (1954c). *C. R. Soc. Biol., Paris*, **148**, 746.
- FREDERICQ, P. (1954d). *C. R. Soc. Biol., Paris*, **148**, 1276.
- FREDERICQ, P. (1955). *C. R. Soc. Biol., Paris*, **149**, 2028.
- FREDERICQ, P. (1956). *C. R. Soc. Biol., Paris*, **150**, 1514.
- FREDERICQ, P., and BETZ-BAREAU, M. (1952). *Ann. Inst. Pasteur*, **83**, 283.
- FREDERICQ, P., and BETZ-BAREAU, M. (1953a). *C. R. Soc. Biol., Paris*, **147**, 1653.
- FREDERICQ, P., and BETZ-BAREAU, M. (1953b). *C. R. Soc. Biol., Paris*, **147**, 2043.
- FREDERICQ, P., and BETZ-BAREAU, M. (1956). *C. R. Soc. Biol., Paris*, **150**, 615.
- FREDERICQ, P., and DELCOUR, G. (1953). *C. R. Soc. Biol., Paris*, **147**, 1310.
- FREDERICQ, P., and LEVINE, M. (1947). *J. Bact.*, **54**, 785.
- GARDNER, J. F. (1950). *Brit. J. exp. Path.*, **31**, 102.
- GOEBEL, W. F., BARRY, G. T., JESAITIS, M. A., and MILLER, E. M. (1955). *Nature, Lond.*, **176**, 700.
- GOEBEL, W. F., BARRY, G. T., and SHEDLOVSKY, T. (1956). *J. exp. Med.*, **103**, 577.
- GRATIA, A. (1925). *C. R. Soc. Biol., Paris*, **93**, 1040.
- GROSSO, E. (1950). *Boll. Ist. sieroter. Milano*, **29**, 373.
- DE HAAN, P. G. (1954). *Genetica*, **27**, 300.
- HALBERT, S. P. (1948). *J. Immunol.*, **58**, 153.
- HALBERT, S. P., and MAGNUSON, H. J. (1948). *J. Immunol.*, **58**, 397.
- HAMON, Y. (1956a). *C. R. Acad. Sci., Paris*, **242**, 1240.
- HAMON, Y. (1956b). *C. R. Acad. Sci., Paris*, **242**, 2064.
- HAMON, Y., and LEWE, Z. (1955). *Ann. Inst. Pasteur*, **89**, 336.
- HEATLEY, N. G., and FLOREY, H. W. (1946). *Brit. J. exp. Path.*, **27**, 378.
- JACOB, F., SIMINOVITCH, L., and WOLLMAN, E. (1951). *C. R. Acad. Sci. Paris*, **233**, 1500.
- JACOB, F., SIMINOVITCH, L., and WOLLMAN, E. (1952). *Ann. Inst. Pasteur*, **83**, 295.
- JACOB, F., SIMINOVITCH, L., and WOLLMAN, E. (1953). *Ann. Inst. Pasteur*, **84**, 313.
- JENKIN, C. R., and ROWLEY, D. (1955). *Nature, Lond.*, **175**, 779.
- KELLENBERGER, G., and KELLENBERGER, E. (1956). *Schweiz. Z. Path.*, **19**, 582.
- LATARJET, R., and FREDERICQ, P. (1955). *Virology*, **1**, 100.
- LEDERBERG, G. (1947). *Genetics*, **32**, 505.

- LEDERBERG, G. (1952). *Physiol. Rev.*, **32**, 403.
LEDERBERG, G. (1955). *J. Cell. comp. Physiol.*, **45**, 75.
LEVINE, M., and TANIMOTO, R. H. (1954). *J. Bact.*, **67**, 537.
LUDFORD, C. G., and LEDERER, M. (1953). *Aust. J. exp. Biol. med. Sci.*, **31**, 553.
LWOFF, A., and JACOB, F. (1952). *C. R. Acad. Sci., Paris*, **234**, 2308.
MONDOLFO, U. (1948). *Boll. Soc. ital. Biol. sper.*, **24**, 1.
PANIJEL, J., and HUPPERT, J. (1956). *C. R. Acad. Sci., Paris*, **242**, 199.

Reviews

- BORDET, P., and BEUMER, J. (1951). *Rev. belge Path.*, **21**, 245.
EDITORIAL (1953). *Lancet*, **1**, 1084.
FREDERICQ, P. (1950). *Bull. Acad. roy. Méd. Belg.*, **15**, 491.
FREDERICQ, P. (1953). *Ann. Inst. Pasteur*, **84**, 294.
FREDERICQ, P. (1955). *Ann. Soc. roy. méd. nat. Brux.*, **8**, 15.
FREDERICQ, P. (1957). *Annu. Rev. Microbiol.*, in press.
FREDERICQ, P. (1957). *Protoplasma*, in press.
FREDERICQ, P. (1957). *Protoplasmotologia*, Vol. IV., in press. Vienna: Springer.
PIROTTA, F. (1955). *Boll. Ist. sieroter. Milano*, **34**, 552.

DISCUSSION

Hayes: I should like to congratulate Prof. Fredericq on talking about a true antibiotic and not one of these synthetic chemical compounds! Prof. Fredericq has implied that the potentiality to produce colicin is not a genic but a cytoplasmic factor because of the apparent maternal inheritance of this potentiality since, when a donor strain unable to produce colicin is crossed with a colicinogenic recipient strain, then all the progeny are colicin-producers; but when he does the reverse cross, i.e. when the donor is colicinogenic and the recipient non-colicinogenic, then there is segregation of colicinogenicity and non-colicinogenicity among the progeny. What are the details of this reverse cross? Is it a true reverse cross in that the same donor and recipient strains are used, but simply the capacity or incapacity to produce colicin has been reversed?

Fredericq: Yes, this was confirmed in many other types of crosses where different markers were selected. When it is the reverse cross, it is obvious; and when you make it with many different selected markers and always get the same results, I think that is also quite demonstrative. In the classical cross $M^- (F^+) \times TLB_1^-(F^-)$ you can make the F^+ or the F^- parent colicinogenic. If it is the F^- which is colicinogenic, 100 per cent of the recombinants will be colicinogenic; but if it is the F^+ which is colicinogenic, then up to 60 or 70 per cent of the recombinants may still be colicinogenic.

Hayes: Can you transfer colicinogenicity to the F^- parent without infecting it with F^+ ?

Fredericq: Transduction of the colicinogenic property very often results in the simultaneous transduction of the F^+ agent, but some

strains were obtained which were apparently still in the F^- state, as far as one can judge from the absence of recombination with other F^- strains.

Hayes: Have you tried these transfer experiments using an Hfr strain?

Fredericq: In preliminary experiments I have transferred a colicinogenic property to an Hfr strain, but I have not yet had time to look for the results of crosses.

Lederberg: Can you do that experiment in which you have an F^- colicinogenic mixed with an Hfr non-colicinogenic, and by contact obtain colicinogenic Hfr? Is this process of transduction through conjugation frequently reciprocal? This is where one parent is Hfr and the other F^- .

Fredericq: An F^- strain does not seem to be able to transfer its colicinogenic property even to an F^+ cell, or an Hfr cell. However, if you make a prolonged mixed culture in broth you will get the transfer because the F^+ will first transform the F^- into F^+ , and then the transfer between two F^+ can be observed.

Lederberg: Does it matter if the F^- strain that is used as a recipient is carrying a marker for resistance to that culture?

Fredericq: It does not seem to matter. It is often easier to transfer to a non-colicinogenic strain which has the corresponding receptor because there is already a selection for transduced cells as they are immune to that particular colicin.

Lederberg: How frequent is the transfer compared, for example, with the transfer of F^- ?

Fredericq: It is about of the same order. I made no comparative control. It depends also on the type of colicin produced; with some colicinogenic strains between 10 and 80 per cent of the cells are transduced.

Hayes: Do you have any colicinogenic strains whose capacity to produce colicin is not transferred at high frequency from an F^+ to an F^- cell?

Fredericq: I have colicins which are not transferred at all.

Hayes: Even when you select for a whole range of markers on that part of the F^+ chromosome which is only transferred at low frequency in recombination?

Fredericq: Yes, for example with the colicin produced by strain P9, it seems that in the crosses there is induction of colicinogenic production during transfer, and all recombinants which should receive the P9 property disappear. The number of recombinants is very low, not one is colicinogenic, but the distribution of other markers among them is quite normal.

Hayes: In this case, if it had a locus on the chromosome one should expect to find an elimination of a certain class of recombinants inheriting markers which were linked to colicinogenicity.

Fredericq: Yes, at least if it is linked with the markers. I have got no indication that any colicinogenic properties are linked with any of the markers.

Hayes: The phenomenon of zygotic induction occurs in connexion with the genetic transfer of λ prophage and other inducible prophages in the F^+ or Hfr parent, in a cross with a non-lysogenic F^- cell, but it seems

it may not occur if the cross is made at temperatures much lower than 37°. In other words, 100 per cent zygotic induction only occurs when the zygotes are made at 37°. Have you any information as to whether a similar phenomenon arises in those strains where you get no transfer of colicinogenicity? At lower temperatures you might get segregation.

Fredericq: This has not yet been done, but it should be investigated.

Cavalli-Sforza: Have you tried to transduce colicin production by phage?

Fredericq: I have tried this in some experiments, but without success. It has not yet been done on a large scale.

Pontecorvo: Is anything analogous to colicins found in other bacteria?

Fredericq: There may, perhaps, be something analogous to colicins in other bacteria. Jacob (1954, *Ann. Inst. Pasteur*, 86, 149) has studied the production of pyocin by *Pseudomonas*, but so far transduction has not been possible. In Hungary, Ivanovics and Alföldi (Ivanovics, G., and Alföldi, L. (1954). *Nature, Lond.*, 174, 465) studied the production of megacine, an antibiotic whose synthesis is also induced by ultraviolet irradiation, but so far there is no indication that the process may be transduced from one strain to the other.

Pollock: What is the situation with regard to the purification of colicins?

Fredericq: Colicin K has been purified recently by Goebel and his collaborators at the Rockefeller Institute (Goebel *et. al.*, 1955, *loc. cit.*). They obtained a very active product which seems to consist of a protein, lipid and carbohydrate complex containing about 6 per cent nitrogen and 1.6 per cent phosphorus. This compound seems to have all the properties of the somatic antigen of the bacteria; but these authors do not exclude that colicin K may in reality be another molecule which is linked with this complex. Colicins seem to be very high-molecular compounds. Latarjet and I studied the X-ray inactivation curve of colicin K, and the results point to a molecular weight between 60,000 and 90,000 (Latarjet and Fredericq, 1955, *loc. cit.*).

Stocker: Prof. Fredericq, have you made any further observations on the phenomenon you reported some years ago, i.e. the appearance of minute clear areas, similar to phage plaques, produced by the action of colicin-containing sterilized broth cultures on lawns of sensitive organisms (Fredericq, P. (1950), *C. R. Soc. Biol., Paris*, 144, 728, 730)? That seemed to suggest that there was some cell propagation of the active agent under some circumstances, because it seems inconceivable that one molecule could produce a visible area of clearing.

Fredericq: This phenomenon which mimics phage tache is due to the fact that in a colicinogenic culture not every cell produces colicin, and the few which do produce colicin adsorb most of the colicin they produce; and when you put a drop of bacterial cultures on a sensitive indicator those cells which have adsorbed a large quantity of colicin function as a disseminating centre. As a rule, if you centrifuge then most of the tache-producing activity is deposited.

Hayes: Is there any analogue of recombination between two genetic loci each of which determines a different type of colicin production?

Fredericq: I am now studying two strains which produce at the same

time two different colicins, and in which the colicinogenic factors seem to be linked. As a rule, however, when a strain produces two different colicins the two colicinogenic factors are quite independent. For example, if you cross an F^+ which produces colicin A with an F^- which produces B, 100 per cent of the recombinants produce colicin B like the F^- parent; and some but not all of them will at the same time also produce the one from the F^+ parent. Very often, a strain which is doubly colicinogenic can transduce only one of its colicinogenic properties.

Pollock: Has there been any chemical separation of colicins of the same strains from one another?

Fredericq: No, the evidence for different colicins produced by the same strain is most indirect, based on their action on resistant mutants and on their susceptibility to proteolytic enzymes and so on, but there has been no chemical separation.

Pollock: Could there be one molecule with two properties?

Fredericq: It seems to be quite excluded because they have different rates of diffusion. The technique which gives good results in separating colicins according to their proteolytic susceptibility is to inoculate in a plate a streak of the colicinogenic strain and a perpendicular streak of a strain which produces a proteolytic enzyme, e.g. a strain of *Proteus*. If they are allowed to grow for 48 hours and then the whole plate is inoculated with the indicator strain, it will be found that the inhibition zone which should be regular around the colicinogenic streak is destroyed in the vicinity of the proteolytic strain. In the case of a strain which produces only one colicin this curve is quite regular, but when it produces two distinct colicins—which, as a rule, have different areas of diffusibility—the destruction curve in the external part of the inhibition zone is quite different in shape from the destruction curve in the internal part.

Cavalli-Sforza: Does *Esch. coli* K 12 itself produce any colicin?

Fredericq: Not the original K 12. Of course the property of producing many different colicins can be transferred to it, but originally it did not produce colicin.

GENERAL DISCUSSION

Lederberg: At the risk of some diversion, another murky problem should be illuminated, that of genetic variation of the human population in the metabolic disposition of drugs. It has been found, for example, that different individuals respond differently to isoniazid in the chemotherapy of tuberculosis. This finding also rationalizes the effectiveness of combined PAS + INH, since PAS competes with INH as an acetyl-acceptor. These differences are correlated with the extent to which the drug is metabolized by the patient to microbiologically inactive derivatives. The metabolic individuality is uncorrelated with disease status, nutrition, sex or age, and remains fixed for the whole interval of the studies that were reported. To a geneticist, it is hardly escapable that we are dealing here with hereditary differences in the disposition of the drug, but family studies have not been made. This possibility is one that may have great generality, but has scarcely been gone into at all, though it may have much to do with isolated cases of treatment-failure, or of idiosyncratic responses, such as the renal toxicity of the sulphonamides, or aplastic anaemia from chloramphenicol. Even with experimental animals, there has been very little systematic study of genetic differentials in response to drugs, though we know the famous example of atropine-esterase in rabbits, and there are more recent reports of variation in sleeping-time following doses of hypnotics in inbred lines of mice. We have also to consider the possibility of adaptive changes in metabolic pattern which, though it must underlie such an important effect as tolerance to the opiates, is equally understood.

We just do not know the extent to which the genetic variability of the human population must be superimposed upon that of its parasites in the analysis of chemotherapeutic failure, and this is a field that calls for more incisive attention than formerly. However, since micro-organisms that have demonstrably higher resistance to antibiotics are generally isolated from such cases, microbial rather than host variation must be the typical answer.

Hayes: Prof. Hinshelwood mentioned the Akiba type of experiment where well washed cells which were streptomycin-sensitive were exposed to streptomycin for long periods of time in a non-nutrient medium, in which total counts suggested that no multiplication had taken place. The total number of cells of the population exposed in this way was relatively small, and far below the number

in which a spontaneous mutation of the usual type might be expected. It was found that, at the end of a period of several weeks, the entire population showed a high degree of resistance for streptomycin. This is a very important experiment and appeared convincing. It was initially confirmed by Szybalski; but he has now recanted. Szybalski has recently shown some of the reasons why the experiment was fallacious (Szybalski, W. (1956), *Microbial Genetics Bull.*, 14, 6). One reason is that in the depths of the medium, under relatively anaerobic conditions, sensitive cells are able to grow in the presence of streptomycin. Another reason is that the experiment cannot be reproduced when purified streptomycin is used; it seems that impurities present in streptomycin preparations can be utilized for the growth of either sensitive or resistant bacteria. In the case of sensitive cells, some are killed off but others grow in the depths of the medium, where they are unaffected by the streptomycin. There is thus a turnover of cells, and among these a streptomycin-resistant mutant can arise in the normal way.

I would suggest that in this kind of experiment there is one internal control which would help clearly to distinguish between an adaptation phenomenon and one due to a selection of resistant mutants. This is to employ a bacterial population which is not homogeneous but made up of several genetically marked types of the same wild-type organism, mixed in different proportions. If mutant selection operates, then the resistant population issuing from the experiment is likely to be homogeneous for a single type. If, on the other hand, the evolution of resistance is due to adaptation of all, or of the great majority, of the cells, in the population, then all the types should be represented in the resistant population in their initial proportions.

Dean: I am very interested in Dr. Hayes's comments on streptomycin, because from time to time we have had indications that "reduced" streptomycin is sometimes not adsorbed by the cells and is not very toxic. The experiments which we described at this symposium were mainly done in sugar media. They were of two types. The first type was in a minimal medium in which the cells eventually grow. The second was of the Szybalski type, where one had omitted a nitrogen source or else had used phosphate buffer only. In neither case did we see any evidence of lysis, even after 41 days, when investigated by total bacterial mass (turbidity). In these experiments we dilute the samples and plate out less than 100 cells. They all form colonies, and if selection was taking place we should have seen a differentiation of the colonies on the plates. If we were simply selecting mutants during the lag phase we should

surely have picked up a mutant on some plates, if the number of mutants in the liquid culture was increasing.

Slonimski: In the D-arabinose experiment, if you plate 100 cells in a Petri dish you get about 10^{-10} g. of cell-mass. The amount of sugar is of the order of 10^{-1} g. of mass. The analytical reagent grade of sodium chloride has at best a purity of 99.99 per cent. Let us suppose that you could get D-arabinose much purer than the best preparation of sodium chloride, a rather remote possibility. The mass of impurities added with the sugar would still be much greater (by some 10,000 times) than the initial mass of cells. These impurities, as well as those coming from other constituents of the medium, may be used for a slow but definite growth, as was shown by Ryan. Therefore, during this critical period mutation followed by selection may very well occur.

Dean: Prof. Ryan drew attention to the fact that on sugar media agar plates one does get microcolonies by growth on impurities. These microcolonies, he thought, contain sufficient cells to be certain of containing at least one mutant. We think that the experiment of plating during the lag phase rules out this possibility. What we measure is the time taken by the colonies to reach the size which is reached by well trained organisms within two days. If the growth were due to a mutant in the microcolony, the time of appearance of a positive colony should bear no relation to the time spent previously in the liquid medium—if it is plate mutation. If, on the other hand, one is selecting mutants in the liquid culture the number of cells should increase during the lag phase. One should be able to detect an increase in bacterial count, just at the end of the lag phase.

Slonimski: My point is that the discrepancy between the resolution power of genetical analysis (by studying 100 cells put on a plate or seeded for testing) and the amount of unknown chemical substances present in the test-tube or the Petri dish is so enormous that one just should be very cautious in equating a chemical substance, chosen *a priori*, as a causative agent of the genetic change.

Pollock: We all agree that the colony size, even without training, is quite large. I think this growth is partly due to impurities, but that it is probably also due to slow utilization of the lactose. These original parent strains are cryptic mutants and can only use the lactose extremely slowly. I don't know about D-arabinose.

The presence of fully trained cells giving rise to rapidly growing colonies on the plate undoubtedly influences the size of colonies of untrained cells.

The colonies of both types (Lac^+ and Lac^-) do come up together

at first, but the Lac^- (from untrained cells) will not produce large colonies for a long while unless there are some fully trained cells giving rise to colonies on the same plate.

Dean: I don't agree with that. If you keep the Lac^- cells on the plate long enough they will eventually reach Lac^+ size, even if you have only four or five colonies on the plate.

Pollock: Yes, but it is the speed of growth that is affected by the presence of the fully trained cells.

Dean: Surely if you have fully trained it, and if you have Lac^+ and Lac^- cells on the plates, one type is going to come up quicker than the other.

Pollock: The lag is surprisingly short, in my experience.

Davis: I would like to make a suggestion that might apply to the Akiba and Szybalski type of experiment, in which it was originally alleged that mutations occurred in a small population without a background of growth. Szybalski now believes that there is indeed an invisible background of growth that produces enough population to give rise to these hereditarily changed cells as spontaneous mutants. In addition to the elegant method that Dr. Hayes suggested for seeing whether there is indeed selection in this apparently completely barren medium, a simple way of detecting whether there was background growth in such a medium would be to have some penicillin present. It is known that penicillin will sterilize cells only under conditions that permit them to grow. If you had a background of cells that did not grow during this long period, they should survive the penicillin, but if they went through some generations while maintaining a constant population density, they should die out.

Dean: In these experiments on *Bact. lactis aerogenes* and D-arabinose, penicillin has very little action.

Davis: You have to increase the concentration to affect aerogenes but the mode of action is still the same. We can isolate auxotrophs of aerogenes by the selective action of penicillin, which indicates that it sterilizes only those cells that are growing; but you need three or four times as much penicillin as you need for *Esch. coli*.

Hotchkiss: If there is growth occurring in the Akiba-Szybalski experiment, it is a very special kind of growth. I rather object to the induction by which we generalize and say that penicillin must kill any type of growing cell. Szybalski did attempt genetic labelling by putting some streptomycin-resistant cells into the digest, and he found that these with their particular genetic markers were not among those recovered later. His recent conclusion is that these could not have survived. They were not related sufficiently to the others and did not have a selective advantage in the mixture.

Lederberg: We have spent these days in discussing issues of fundamental importance but have not often touched on drug resistance as a practical problem which, as Sir Charles points out, was the original motivation for this symposium. Perhaps now is the time to revert to prospects for practical control, based on the principles we have been elaborating.

Two approaches present themselves: to cope with either the genotype or the phenotype of resistance, though neither offers a panacea. As regards the genotype, we might ask either to prevent the occurrence of resistance mutations, or induce their reversion to sensitive alleles. Neither is within the grasp of present-day genetic technology. It is true that we have fragmentary information on mutagenic and antimutagenic chemicals, but the effects now known would have an inappreciable influence on resistance as a practical matter. Some investigators have hoped that DNA-transduction of sensitivity might be used in a therapeutic sense. But this process is only the transfer of information, not the imposition of it: in all known cases of transduction (excepting lysogenic, colicinogenic and F conversions) several per cent of the recipient cells are the most that can be transformed, and this ratio is often much less. Furthermore, the progeny of a transformed cell are characteristically a mixture of the old and new types. This is not to dampen hopes for the control of the mutational process, but these hopes can be realized only by dint of vigorous attacks on fundamental issues of microbial, indeed of general, genetics.

The control of the resistant phenotype may afford more immediate prospects. Where resistance is physiologically adaptive, as in the developments of penicillinase, we might hope to intervene in the bacterial response, for example if we would find a specific antagonist for it. Or we might equally look for specific antagonists of the resistant phenotype, e.g. an anti-penicillinase. Furthermore, in some instances, resistance may be due to biochemical deletions (of entities which would then be called receptors; in many cases these may be specific permeases) the restoration of which would confer phenotypic sensitivity. (This is one possible explanation of Eagle's co-killing phenomenon discussed earlier.)

We may also reflect that the very pattern of sensitivity of existing pathogens (by which antibiosis itself is defined) must reflect some biological disadvantage, however slight, on the part of resistant genotypes. Our neatest trick would be to turn the tables on resistant types by discovering, exaggerating and exploiting this defect. On the whole, little was said about resistance phenotypes at the symposium, and little more is known. The prospects for the achievement of the necessary understanding are, however,

less remote than for our alternative approach—the control of genotype.

Until then, we can evade the problem by using more and different antibiotics, alone and in combination. However, without fundamental knowledge, we may have to run twice as fast to stand in place, at least for those afflictions, like tuberculosis, where intercurrent development of resistance is a serious problem.

This analysis is premised on the development of inherited resistance by a process of mutation and selection, whose rôle in *at least* some instances is no longer controverted. It has been suggested that this is a counsel of despair. But it is not obvious to me that our tactics would be greatly altered if we had to cope with alternative mechanisms of direct adaptation. In either event, we should need to learn a great deal more about the biology of bacteria before we could put basic principles to practical use. In past years, the inaccessibility of the genetic material to experimental modification may have been overstated. We are just beginning to learn something of its chemical make-up, and this does give us a glimpse of future possibilities of controlled mutagenesis and synthetic genes. But it would be a worse error now to oversimplify the problem, to overlook the very large extent to which bacteria mutate indeterminately, when and as they please, rather than as an accommodation to our own too crude techniques.

* * * * *

Harington: This brings us to the end of our deliberations, and there is little useful that I can add in my final remarks. I would like particularly to thank Prof. Lederberg for his final contribution to the discussion, which seems to me to be an admirable crystallization of the more practical issues.

At the outset of the meeting I referred to the background of disquiet about chemotherapy that was in the minds of some of us, because of the continued empiricism of the subject on the chemical side and because of preoccupation with the practical obstacles raised by drug resistance.

Obviously we have not in the last three days made any apparent progress towards the solution of these practical problems; equally obviously we could not and did not expect to do so. On the other hand there are directions in which we can, I think, claim to have advanced.

We chose for ourselves a subject that is essentially controversial because of the clear distinction between the theoretical biological approaches that can be made to it; these two approaches have

been well represented at this meeting, and at first it seemed that, as has happened in previous discussions of the problem, we might have continued to sit in uncompromisingly opposing camps. This has most fortunately not happened; as time has gone on the sharp dichotomy between the two points of view has tended to disappear and discussion has become more broadly based.

There has, of course, undoubtedly been a trend towards the view that drug resistance is to be explained in terms of genic mutations rather than in terms of directed physiological variations; indeed as we heard yesterday afternoon several of our participants have confessed to conversion on this point. Yesterday evening I referred to these conversions as a welcome measure of the success of the meeting although they might not be in the direction that one wished. In these words of mine of course the welcome was the response of a scientific man and the hint of disappointment that of a wishfully thinking human being. If one regards drug resistance not only as a biological phenomenon of academic interest but as a practical obstacle to be overcome, it is naturally more encouraging to think of it as a directed physiological variation than as a spontaneous mutation; the former phenomenon might conceivably be subject to some sort of control; the latter, so far as I can see, can only be met by rendering an essentially uncontrollable event less likely to occur, that is in practice by multiple chemotherapy.

However, conversions or no conversions, nothing but good can come of the breaking down of barriers between opposing schools of thought, so that a matter of controversy ceases to be a matter of doctrinal disputation and becomes one for impartial scientific discussion. I hope that all who have taken part in this symposium will agree with me that we have indeed advanced in this desirable direction, and that they will return to their laboratories feeling that their time and thought, so generously given, have been well spent.

AUTHOR INDEX TO PAPERS

	PAGE		PAGE
Alexander, P.	294	Hughes, W. H.	64
Barber, Mary	262	Kállay, I.	233
Cavalli-Sforza, L. L.	30	Knox, R.	241
Cousens, Sheila F.	294	Kossikov, K. V.	102
Davis, B. D.	165	Kunicki-Goldfinger, W.	251
Dean, A. C. R.	4	Pollock, M. R.	78
Demerec, M.	47	de Robichon-Szulmajster, H.	210
Evans, Audrey H.	183	Sinai, J.	141
Fredericq, P.	323	Slonimski, P. P.	210
Györffy, B.	233	Stacey, K. A.	294
Hayes, W.	197	Thornley, Margaret J.	141
Hinshelwood, Sir Cyril	4	Westergaard, M.	280
Hotchkiss, R. D.	183	Yudkin, J.	141

SUBJECT INDEX

- Adaptation**, cytochrome oxidase, 221-224
during lag phase in media containing new substrates or antibacterial agents, 13, 14
genetic, 30-46
maltozymase, 225-229
of bacterial populations, 32, 33
phenotypic, 142-152
"physiological", 16
to drugs, accelerated, 15, 16
new carbohydrate sources, 10
proflavine resistance in *Bact. lactis aerogenes*, 142-145
in *Escherichia coli*, 141-164
- Adaptive enzymes**, production of, by yeasts, 128-135
- Aerobacter aerogenes* (see also *Bact. lactis aerogenes*), acetate as carbon source, 9
adaptation to D-arabinose, 8
chloramphenicol, 9
proflavine, 9
propamidine, 9
sulphanilamide, 9
- Agar**, semi-solid, use of, 241, 242
- Alkylating agents**, mutagenic, 294-322
reaction with anions, 316
carboxyl groups, 297, 298
DNA, 308-312
nucleic acids, 300-305
nucleoproteins, 305-307
phosphate groups, 307, 308
proteins, 296-299
proteins and nucleic acids, 294-322
RNA, 307, 308
radiomimetic, 294-322
- p*-Aminobenzoate, 167, 171, 172, 187, 188, 190, 191, 193
- p*-Aminosalicylic acid, antituberculous effects of, 3
resistance in *Bacillus megaterium*, 55
- Anions**, reaction of alkylating agents with, 316
- Antibiotics**, physiological adaptation of bacteria to, 251-261
- D-arabinose**, adaptation of *Aerobacter aerogenes* to, 8, 13, 14
Escherichia coli K12 to, 13
as sole carbon source, 13, 14
utilization by *B. coli*, 8
- D-arabinose-agar**, development of *Bact. lactis aerogenes* on, 11
- Average clones test**, 33
- Bacillus cereus*, 266
penicillin-induced resistance to penicillin in cultures of, 78-101
penicillin resistance in, 246, 247
- Bacteria**, aspects of drug resistance in, 4-29
identification of genetic and non-genetic variation in, 280-293
physiological adaptation to antibiotics, 251-261
- Bacterial cells**, single, inheritance in, 64-77
populations, adaptation of, 32, 33
- Bacterium coli*, stability and reversibility in, 8
- Bacterium coli mutabile*, adaptation to chloramphenicol, 14
adaptation to lactose, 13, 14
streptomycin, 14
development on lactose-agar, 11
Lac⁺ and Lac⁻ strains, 9, 26, 29
- Bacterium lactis aerogenes* (see also *Aerobacter aerogenes*), adaptation to lactose, 13, 14
proflavine resistance, 8, 15, 16, 142-145
sodium azide, 15, 16
streptomycin, 14
sulphanilamide, 8

- Bacterium lactis aerogenes*,
 development on D-arabinose-
 agar, 11
 reversibility, in presence of
 phenols, 8
 stability and reversibility in, 8,
 9
- Bacillus megaterium*, adaptation to
 increased concentrations of
 norsulphazol, 138
 isoniazid and PAS resistance in,
 55
- Bacteriophage, 21, 33, 34, 49, 200
- Carboxyl groups**, reaction of alky-
 lating agents with, 297, 298
- CB 1506 and CB 1528, 290
- CB 3025, 311, 312
- Chlorambucil, 303, 304, 306, 307
- Chloramphenicol, adaptation of
Aerobacter aerogenes to, 9
Bact. coli mutabile to, 14
 resistance of *Esch. coli* to, 21, 35-40
- Clonal variation, 160, 242, 283
- Clostridium aceto-butylicum*, adapta-
 tion to fermentation of
 xylose, 136, 137
 increased concentrations of
 butanol, 136-139
- Cofactors of enzymic adaptation,
 210-232
- Colicogenic factors, 323-325
 immunity by transfer of, 329-332
- Colicins, genetics of mechanisms of
 resistance to, 323-338
- Concentration by limiting dilution,
 34-40
- Crosslinking of DNA, 308-312
 of nucleoproteins, 317
 rôle in mutagenicity, 312, 313
- Cycles of adaptability to resistance,
 148-164
- Cytochrome oxidase adaptation,
 221-224
- Cytoplasmic changes, 7, 8
 inheritance, 32
 mutations, 284-286
- 5-Dehydroquinic acid, 173, 174
- 5-Dehydroshikimic acid, 173, 174
- Deoxyribonucleate, 183-186, 194-
 196, 200, 207, 245, 247, 249, 281,
 282
- Deoxyribonucleic acid, 4, 5, 53
- Deoxyribonucleic acid**,
 transformation experiments with,
 157-160, 163
 intramolecular crosslinking of,
 308-312
 possible significance of "hidden
 breaks" in, 313-316
 reaction of alkylating agents
 with, 308-312
- Drosophila*, 296, 320
 induction of phenocopies in, 288
- Drug resistance**, accelerated, 15, 16
 acquired, multiple mechanisms
 of, 141-164
 fluctuation tests, 20
 graded response, 14, 15
 heritable changes in, 31
 in bacteria, adaptational aspects
 of, 4-29
 indirect selection and origin of,
 30-46
 in *Mycobacterium tuberculosis*,
 241-250
 in *Serratia marcescens*, 233-237
 mass-number relations, 9, 10
 Mendelian analysis, 52, 53
 mutability, 50-52
 of staphylococci, 262-279
 papilla formation, 17-20
 "penicillin" pattern, 54
 phenotypic expression of genes
 determining, 197-209
 mechanism of, 165-182
 physiological mechanisms of, 165-
 182
 pre- or postadaptation, 31, 32
 stability and reversibility, 9, 9
 "streptomycin" pattern, 54
 test for presence of mutant forms
 in massive inocula, 10, 11
 time-number relations, 11, 12
 transformation and transduction
 analyses, 53
- Drugs**, accelerated adaptation to, 15,
 16
 binding or adsorption of, by resis-
 tant and non-resistant cells, 16-
 17
- Dulcitol, adaptation of *Escherichia*
coli K12 to, 13
- Duponol, 159
- Enzyme adaptation in staphylo-
 cocci, 266-268
- Enzyme reactions, 5

- Enzymes**, adaptive, production by yeasts, 128-135
 evolution of, 94, 95
 induced formation of, 78-101
 qualitatively altered, 168-172
 thermostability of, 93
- Enzymic adaptation**, cofactors of, 210-232
 organization of cell, 21
- Epoxide**, 294 (*see also* Alkylating agents)
- Escherichia coli*, 50, 51, 52, 200, 204, 208, 251, 293
 adaptation to proflavine resistance in, 141-164
 chloramphenicol resistance in, 35-40
 demonstration and isolation of pre-existing mutants, 156, 157
 pantothenate-synthesizing enzyme of, 93
 production of colicins by, 323-325
 resistance to chloramphenicol, 21
 streptomycin resistance in, 35-40
 "training" and "reversion" in, 141, 142
 transformation to proflavine resistance in, 157-160
- Escherichia coli* B, 66, 68
 phage-resistant forms of, 16
- Escherichia coli* K 12, 276
 adaptation to D-arabinose, 13
 dulcitol, 13
 effects of starvation and cooling, 252-261
- Ethylene imine**, 294 (*see also* Alkylating agents)
- Expression**, phenotypic, 197-209
- Fermentative properties** of yeast, directed hereditary changes of, 102-140
- Fluctuation tests**, 20, 33, 49
- Genes** determining various types of drug resistance, phenotypic expression of, 197-209
- Genetic adaptation**, 30-46
 and metabolic mechanisms underlying sulphonamide resistance, 183-196
 non-genetic variation in bacteria, 280-293
 aspects of drug resistance, 47-63
- Genetics** of mechanisms of resistance to colicins, 323-338
- Growth rate** as indication of sensitivity and resistance, 64-77
- Heredity**, stable, 6, 8
- Heritable changes** in drug resistance, 31
- Hetrazan**, 1
- p*-Hydroxybenzoic acid, 171, 172
- Immunity** by transfer of colicinogenic factors, 329-332
- Induction** of enzymes, 78-101
- Indirect selection** and origin of resistance, 30-46
- Inheritance**, cytoplasmic, 32
 in single bacterial cells, 64-77
 "Lamarckian", 152-156
 origin of, 47-63
- Invertase**, production by yeasts, 128-135
- Isoniazid**, 3
- Isoniazid resistance**, 50
 in *Bacillus megaterium*, 55
Mycobacterium tuberculosis, 241-250
- Klebsiella pneumoniae*, 70, 324
- Lactose**, adaptation of *Bact. coli mutabile* to, 13, 14
Bact. lactis aerogenes to, 13, 14
- Lactose-agar**, development of *Bact. coli mutabile* on, 11
- "Lamarckian" inheritance, 152-156
- Leprosy**, chemotherapy of, 2
- Lethals**, 76
- Long forms** of cells due to sensitivity to environment, 66, 67
- Maltozymase adaptation**, 225-229
- Mass-number relations**, 9, 10
- Megacine**, 337
- Mendelian analysis**, 52, 53
- Mesyloxy**, 294 (*see also* Alkylating agents)
- Metabolic interference**, Woods-Fildes hypothesis of, 3
- Mustard gas**, 294 (*see also* Alkylating agents)

- Mutability**, 50-52
Mutagenic alkylating agents, 294-322
Mutant forms in massive inocula, tests for presence of, 10, 11
Mutants, concentration by limiting dilution, 34-40
 demonstration and isolation of pre-existing, 156, 157
 fluctuation tests, 20, 33, 49
 mass-number relations, 9, 10
 papilla formation, 17-20
 pre-existent, 9
 resistant to streptomycin, 50, 51, 52
 selection of, 4, 22
 time-number relations, 11, 12
Mutational changes in yeast, induced, 102-140
Mutations, 7
 induction of, 7
 induced "petite", 215-221
 "spontaneous," 80-82
 spontaneous "petite," 229
 to proflavine resistance in *Escherichia coli*, 141-164
Mycobacterium tuberculosis, distribution of drug-resistant individuals in cultures of, 241-250

Neurospora, 93, 284, 287, 319
 crassa, 51
Nitrogen mustards, 294 (*see also* Alkylating agents)
Nuclear division, 7
Nucleic acids, reactions of mutagenic alkylating agents with, 294-322
Nucleoproteins, reaction of mutagenic alkylating agents with, 305-307

Papilla formation, 17-20
Paramecium, 284
Passive type of resistance, 21, 22
Penicillin, resistance in *Staph. aureus*, 49
Penicillin-dependent staphylococci, 263
Penicillin-induced resistance to penicillin in cultures of *B. cereus*, 78-101
Penicillin-resistant staphylococci, 49, 263

Penicillin-tolerant staphylococci, 262, 263
Penicillinase, 78-101
 activity, micro-assay of, 84
 production by staphylococci, 262-279
Permeability changes, 172-179
Permeases, 175
Permeation systems, specific, 172-179
Phage resistance, 21, 49
 indirect selection in, 33, 34
Phenocopy, 282
Phenols, 8
Phenotypic adaptation, 142-152
 delay, 7
 expression, kinetics of, 197-209
 of genes determining drug resistance, 197-209
 lag, 197
 mechanisms of resistance, 165-182
Phosphate groups, reaction of alkylating agents with, 307, 308
Pneumococci, sulphonamide resistance in, 183-196
 disseminative transformations, 184-186
Population, distribution of sensitivity in, 64-77
Polyhydroxy compounds, specific, as cofactors of enzymic adaptation and its inheritance, 210-232
Preadaptation theory, 33
Pre- or postadaptation, 31, 32
Proflavine, adaptation of *Aerobacter aerogenes* to, 8, 9, 15, 16
 resistance in *Bact. lactis aerogenes*, 142-145
 Escherichia coli, 141-164
Propamidine, adaptation of *Aerobacter aerogenes* to, 9
Propiolactone, 294 (*see also* Alkylating agents)
Proteins, reactions of mutagenic alkylating agents with, 294-322
Pseudomonas, 208
 production of pyocin by, 337

Radiomimetic alkylating agents, 294-322
Replica plating, 34, 50
 technique of, 20-22
Resistance cycles, 148-164
Resistant variants, origin of, 48-50

- Reversibility and stability, 8, 9
- Ribonucleic acid, 249, 281, 282
 reaction of mutagenic alkylating
 agents with, 307, 308
- RNA (see Ribonucleic acid)
- Saccharomyces carlsbergensis*, 126
- Saccharomyces cerevisiae*, 119, 124, 127,
 128, 135
- Saccharomyces chodati*, 124, 127, 129,
 134
- Saccharomyces ellipsoideus*, 111, 113,
 114, 116, 124, 125, 127, 128, 134,
 135
- Saccharomyces globosus*, adaptation to
 fermentation of maltose,
 113-116
 fermentation of sucrose, 103-
 113
 induced mutational changes in,
 102-140
- Saccharomyces heterogenicus*, 129
- Saccharomyces paradoxus*, adaptation
 to fermentation of maltose and
 simple dextrans of malt-wort, 116-
 120
- Saccharomyces prostoserdovi*, 129
- Salmonella para B*, 324
- Salmonella typhi*, 324
- Salmonella typhimurium*, 51
- Selection, indirect, and origin of
 resistance, 30-46
- D-Serine, inhibition of pantothenate
 production by, 176, 177, 178
- Serratia marcescens*, 318
 development of resistance to
 streptomycin in, 233-237
- Shigella sonnei*, 323, 324
- Shikimic acid, 173, 174
- Single bacterial cells, inheritance
 in, 64-77
- Sister cells, variation between, 64-
 77
- Sodium azide, 201, 204
 adaptation of *Bact. lactis aero-*
 genes to, 15, 16
- Sperm heads, 300
 reaction with alkylating agents,
 305-316
- Spores, transmission of resistance
 through, 136-140
- Stability and reversibility, 8, 9
- Staphylococci, drug resistance of, 2,
 262-279
 enzyme adaptation in, 266
- Staphylococci,
 penicillinase production by, 262-
 279
 penicillin-dependent, 263
 penicillin-resistant, 263
 penicillin-tolerant, 262, 263
 spontaneous mutation in, 266-268
- Staphylococcus aureus*, adsorption of
 streptomycin, 17
 characteristics of penicillin-de-
 stroying cultures isolated from
 penicillin-sensitive, 269-271
 isolation of penicillin-destroying
 variants from penicillin-sensi-
 tive strains of, 268, 269
- Streptomycin, 3
 adaptation of *Bact. lactis aerogenes*
 to, 14
 adsorption isotherms, 17
 resistance to, 14, 21, 50
 in *Escherichia coli*, 35-40
 Serratia marcescens, 233-237
 indirect selection in, 33, 34
- Substrate, specific, directed here-
 ditary changes of fermentative
 properties of yeast by, 102-140
- Sulphanilamide, adaptation of
 Aerobacter aerogenes to, 8, 9
- Sulphonamide, inhibition of cell
 growth, 189-191
 resistance in pneumococci, 183-196
 disseminative transforma-
 tions, 184-186
 nature of, 187-189
- Sulphur mustards, 294 (see also
 Alkylating agents)
- Tetroses, 212
- β -Thiomethyl galactoside (TMG),
 175, 176
- Threonine, 201
- Time-number relations, 11, 12
- Transduction analysis, 53
- Transformation and transduction
 analyses, 53
 of pneumococci to sulphonamide
 resistance, 183-196
 to proflavine resistance in *Esch-*
 erichia coli, 141-164, 157-160,
 163
- Triacrylformal, 295, 311, 312
- Tuberculosis, experimental, chemo-
 therapy of, 2 (see also *Mycobac-*
 terium tuberculosis)

- Valine, 201
- Variants, resistant, indirect selection of, 50
resistant, origin of, 48-50
- Variation between sister cells, 64-77
- X-rays, effect of, on DNA, 309
- Yeast, cofactors of enzymic adaptation in, 210-232
- Yeast,
cytochrome oxidase synthesis in, 210-232
directed hereditary changes of fermentative properties of, 102-140
induced mutational changes in, 102-140
inheritance of fermentative properties developed as result of directed changes, 120-128

