

## Historic, archived document

Do not assume content reflects current scientific knowledge, policies, or practices.



UNITED STATES DEPARTMENT OF AGRICULTURE

**BULLETIN No. 1036**

Contribution from the Forest Service  
WILLIAM B. GREELEY, Forester

Washington, D. C.

PROFESSIONAL PAPER

October 20, 1922

**COAL-TAR AND WATER-GAS TAR  
CREOSOTES: THEIR PROPERTIES  
AND METHODS OF TESTING**

By

**ERNEST BATEMAN**

Chemist in Forest Products

**CONTENTS**

	Page
Part I. Tars and the Production of Creosotes from Tar . . . . .	3
Part II. Experimental Comparison of Authentic Specimens of Creosote . . . . .	23
Part III. Properties of Creosotes . . . . .	47
Part IV. Methods of Testing Creosotes and Official Specifications for Creosote . . . . .	87
Appendix . . . . .	106
Bibliography . . . . .	112



WASHINGTON  
GOVERNMENT PRINTING OFFICE  
1922

Faint, illegible text, possibly bleed-through from the reverse side of the page.

UNITED STATES DEPARTMENT OF AGRICULTURE



BULLETIN No. 1036



Contribution from the Forest Service  
WILLIAM B. GREELEY, Forester

Washington, D. C.



October 20, 1922

COAL-TAR AND WATER-GAS TAR CREOSOTES: THEIR PROPERTIES AND METHODS OF TESTING.

By ERNEST BATEMAN, *Chemist in Forest Products.*

CONTENTS.

Page.	PART III—Continued.	Page.
PART I. Tars and the production of creosotes from tars.....		
Chapter I. Introduction and definitions.....		
Chapter II. Composition of tars and methods of manufacture.....		
Chapter III. Production of creosote from tars.....		
PART II. Experimental comparison of authentic specimens of creosote.....		
Chapter I. Collecting and testing the specimens of creosote.....		
Chapter II. Determining certain conditions for the tests.....		
Chapter III. Results of the tests.....		
Chapter IV. Comparison of the properties of authentic coal-tar creosotes with those of authentic water-gas tar creosotes.....		
PART III. Properties of creosotes.....		
Chapter I. Composition and chemical properties of coal-tar creosote.....		
	Chapter II. Physical properties of coal-tar creosotes.....	50
	Chapter III. Toxic properties of coal-tar creosotes.....	66
	Chapter IV. Composition and properties of water-gas tar creosotes.....	73
	Chapter V. Comparison of the properties of commercial coal-tar creosotes and commercial water-gas tar creosotes.....	77
	Chapter VI. Tar-creosote solutions.....	79
	Chapter VII. A theory of the mechanism of the protection of wood by oil solutions.....	84
	PART IV. Methods of testing creosotes and official specifications for creosote.....	87
	Chapter I. Practical methods of testing creosotes.....	87
	Chapter II. Specifications now in force by various associations.....	103
	Appendix.....	106
	Bibliography.....	112

FOREWORD.

Creosote as a preservative is widely used in this and certain other countries, and a considerable number of articles have been published from time to time on its chemical, physical, and toxic properties. Most of these articles appeared in various technical periodicals, in the proceedings of a number of societies, or in the form of Government bulletins. It is believed that the presentation of the substance of these articles in compact form will be serviceable to those interested in the use of creosote for preserving wood. In addition to giving such a summary, this bulletin also makes available the hitherto unpublished results of certain minor investigations and also of an extended research conducted at the Forest Products Laboratory at Madison, Wis., primarily for the purpose of obtaining a broader knowledge of

the variations of creosote with different processes of manufacture. The bulletin also presents descriptions of the different methods of testing creosotes which have been used or suggested, and particularly those now adopted as standard by the various associations interested in wood preservation, and gives a discussion of the value of the methods of testing.

The bulletin has been divided into four parts. Part I includes the introduction, a description of tars, and an account of the manufacture of creosote. Part II is a presentation for the first time of the results of researches by the author and his coworkers in the Forest Products Laboratory. Part III gives a summary of the chemical, physical, and toxic properties of creosotes as a whole. Part IV is concerned entirely with methods of testing and specifications.

The author wishes gratefully to acknowledge the services of Messrs. L. E. Cover and J. P. Mehlig, formerly assistant chemists in forest products. Much of the routine work described in Part II was done by one or the other of these gentlemen.

# PART I. TARS AND THE PRODUCTION OF CREOSOTES FROM TARS.

## CHAPTER I. INTRODUCTION AND DEFINITIONS.

The preservative treatment of wood is widely recognized to be of great importance, not only in its bearing upon the conservation of our forest resources, but also because it is a large factor in reducing the annual expense for upkeep in those industries that use large amounts of timber under conditions in which it is particularly liable to destruction by the lower forms of organized life. The importance of the

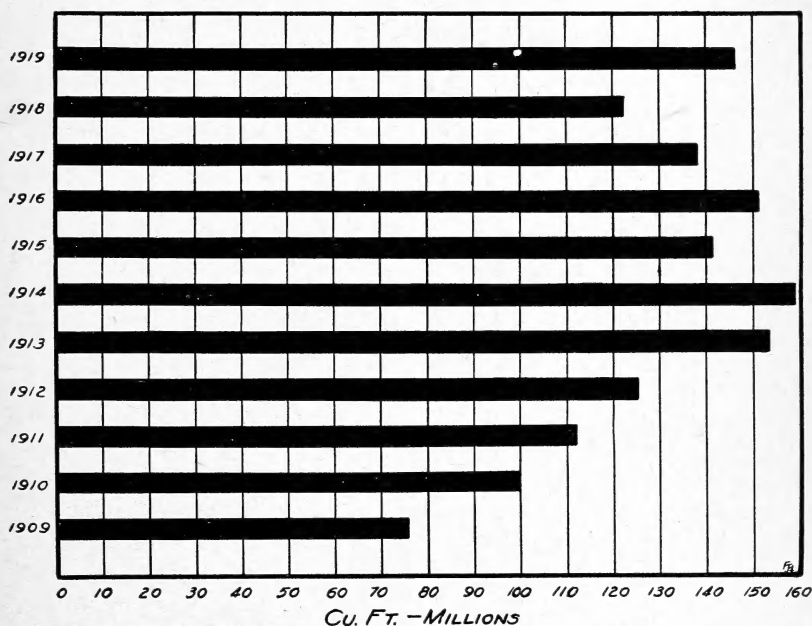

FIG. 1.—Total material treated (*t*) by wood preservatives.

wood-preserving industry is indicated by the diagram (fig. 1), which shows the total amount of timber annually treated with preservatives in this country for the years 1909 to 1919, inclusive.

### DEFINITIONS.

The term "creosote," or "creosote oil," has such a wide variation in meaning that all statistics include, in all probability, not only the product obtained from the distillation of coal tar, but also mixtures of the distillates with crude, refined, or filtered tar, mixtures of water-gas tar distillates, and mixtures of coal-tar distillates and water-gas tar. It is, therefore, advisable to define the terms that will be used in this bulletin.

If the meaning of coal-tar creosote is to be understood, a definition of the mother liquors, or tars, from which the creosote is obtained is necessary.

*Tar* is defined as a nonaqueous, viscous liquid of very complex composition produced by the destructive distillation or partial combustion of organic matter or of minerals containing organic matter.

*Coal tar* is the tarry liquid obtained by the destructive distillation or partial combustion of bituminous or semibituminous coals.

*High-temperature tar* is produced from bituminous or semibituminous coal at temperatures so high that it contains principally aromatic hydrocarbons, such as benzene, naphthalene, anthracene, and similar substances. It also contains well-defined amounts of phenoloids and tar bases. The conditions for the manufacture of this high-temperature tar prevail in the usual gas-house retort and by-product coke oven. High-temperature tars are divided into two classes—retort tar and coke-oven tar.

(1) *Gas-house or retort tar* is a high-temperature coal tar produced in a gas-house retort. Three types are recognized and derive their names from the type of retort in which the coal is coked. (a) *Horizontal-retort tar* is a high-temperature coal tar produced in a horizontal gas-house retort; (b) *inclined-retort tar* is a high-temperature coal tar produced in an inclined retort; (c) *vertical-retort tar* is a high-temperature coal tar produced in a vertical retort.

(2) *Coke-oven or by-product tar* is a high-temperature coal tar produced in a coke oven from bituminous or semibituminous coal. At least three classes are made in this country and derive their names from the type of oven in which they are produced. (a) *Otto tar* is a high-temperature coal tar produced in the Otto, the United Otto, or the Otto-Hoffman coke oven; (b) *Semet-Solvay tar* is a high-temperature coal tar produced in a Semet-Solvay oven; (c) *Koppers tar* is a high-temperature coal tar produced in a Koppers coke oven.

*Low-temperature coal tar* is produced from bituminous, semibituminous, or cannel coal at such low temperatures that it contains hydrocarbons, principally of the paraffin or olefin series. It also usually contains large amounts of phenoloids and appreciable amounts of tar bases. Two general divisions are made—tars produced by destructive distillation and producer gas tars.

(1) Tars produced by destructive distillation include: (a) *Cannel coal tars* produced from cannel coal at relatively low temperatures. Cannel coal is in reality a highly bituminous shale, and if this tar is included under coal tars, then tars from other bituminous shales should also be included. Shale tar is produced from the bituminous shale found in southern Scotland. (b) *Lignite tar* is the tar produced by the distillation of lignite or brown coal. Lunge is the authority for the statement that this tar is produced in Europe for the manu-



facture of petroleum products in competition with the natural American oils. It also contains phenoloids and tar bases.

(2) *Producer tars* are those tars which are produced from bituminous or semibituminous coals in the manufacture of producer gas. They result from destructive distillation combined with a partial combustion of the coal. (a) Blast furnaces using coal are in effect practically gas producers. A small amount of tar is produced in them, but it is similar in composition to that made in gas producers. This tar is known as *blast-furnace tar*. (b) *Mond-producer tar* is obtained from a Mond producer using bituminous or semibituminous coal. Other bituminous-coal producers also yield tars. These are, in general, called by the name of the producer, as the Sutherland producer tar.

*Oil tars* are the tarry fluids resulting from the destructive decomposition or cracking of petroleum oils. Like coal tars, these fluids are exceedingly complex mixtures. The character of their hydrocarbons depends greatly upon the temperature at which the tars were formed.

Like the high-temperature coal tars, the *high-temperature oil tars* are very complex mixtures of compounds. The hydrocarbons are chiefly of the aromatic series. Benzene, toluene, naphthalene, phenanthrene, and methyl anthracene have been found in them; but so far as is known no true anthracene has been identified in the American oil tars. They are further characterized by the almost entire absence of tar acids and tar bases, and this seems to constitute the chief difference between this type of tars and high-temperature coal tar.

*Water-gas tar* is the tar produced from petroleum oil in the carburated water-gas machine. This tar is practically the sole representative of high-temperature oil tars. Very small amounts of high-temperature oil tar are produced by the destructive distillation or cracking of petroleum oils in the gas retorts. A sample of such tar examined several years ago by the author could not be distinguished from water-gas tar and could be distinguished from high-temperature coal tar only by its lack of phenoloids and tar bases.

*Low-temperature oil tars* are produced in the manufacture of pintsch gas and are obtained as a residuum in the distillation of petroleum. They are characterized by an almost total absence of aromatic hydrocarbons and by a lack of phenoloids and tar bases. No further discussion of this class of tars is necessary for the purposes of this bulletin.

The term *creosote* is properly applied to the phenoloid bodies obtained from wood tar after they have been freed from the hydrocarbons, and the term is still used in this connection by druggists. A secondary meaning for creosote applies to a similar product

obtained from coal tar, and, in this respect it means the mixture of phenoloids known to the wood preserver as tar acids.

*Creosote oil* is the term correctly applied to that portion of wood tar or coal tar from which creosote may be obtained by extraction with caustic soda and a subsequent neutralization of the aqueous liquors with mineral acids.

Common usage in the wood-preserving industry has led to the disuse of the word "oil" and to the application of the term "creosote" to the mother liquor, or crude oil, from which true creosote may be obtained. Because of the similarity in other respects between the oil obtained from coal tar—that is, the true creosote oil—and that obtained from water-gas tar, the term "creosote oil" has been applied to oils containing no phenoloids whatsoever. In this publication, the term "creosote" is applied only to a pure product obtained by the distillation of tars, and will be restricted to the oils obtained from high-temperature coal and oil tars and to wood tars. They will be further defined by the use of some qualifying word or phrase such as coal-tar creosote or water-gas tar creosote. All the distilled oils (except patented or proprietary articles) will be called oils or distillates, and suitably designated to show their derivation. Mixtures of distilled oils with their mother liquor or with the mother liquor from other distilled oils will be termed tar solutions. More specifically, these terms are defined as follows:

*Coal-tar creosote* is defined as any and all distillate oils boiling between 200° and 400° C., which are obtained from high-temperature coal tars by distillation only. The addition or admixture of tars from any mixture or source, either refined, filtered, or crude, is not permitted under this definition.

*Water-gas-tar creosote* is defined as any and all distillate oils boiling between 200° and 400° C., which are obtained from water-gas tar or other high-temperature oil tars by distillation only. Admixture of other materials than those stated above changes the nomenclature.

*Wood-tar creosote* is a distillate oil obtained from wood tar. It has a specific gravity greater than 1 and distills principally above 170° C. at atmospheric pressure.

*Shale oil* is the oil obtained from the distillation of shale tar.

*Mond oil* is the oil from the distillation of Mond-producer tar.

*Petroleum oil* is used in the ordinary meaning, but also includes the oil from low-temperature oil tars.

*Retort oil* is the distillate above 200° C., obtained from low-temperature coal tars produced in the gas retort. It is similar in composition to Mond oil.

## CHAPTER II. COMPOSITION OF TARS AND METHODS OF MANUFACTURE.

The character of the tars from which creosotes are made determines in the main the character of the creosote. The methods used in producing the oil may have a slight effect upon the character of the creosote if the tar contains only small amounts of the "paraffin" bodies, but those methods would not change a low-temperature tar to a high-temperature tar. These two classes of tar are determined by the methods used in producing the tar itself. A short description of the method of manufacturing tar and of the general character of the tar as to both its chemical and physical properties is, therefore, very essential as a basis for the discussion of creosotes. Tars of all descriptions are usually by-products of the manufacture of other materials and, consequently, are subject to wide variation, for the reason that, as a rule, no attempt is made to control their composition other than for the purpose of facilitating their removal.

### COAL TAR.

Coal tar is obtained by the destructive distillation of bituminous or semibituminous coal. The main products of this reaction are coke and gas; the chief by-products, ammonia and tar liquor. Coal is generally distilled either for the production of illuminating gas or for the production of metallurgical coke. Whichever product is desired, the other is usually considered of secondary importance, and all the conditions are regulated to give a maximum yield of the highest quality of the main product. Whether gas or coke is to be the main product, there are differences in the character of the coal used, differences in the amount of coal used in each charge, differences in the time taken to carbonize, and differences in the temperatures used. A few coke plants are so situated that they have a demand for gas as well as coke, and in them both materials are principal products. Under such conditions slightly different methods of operation may be followed. However, the fundamental conditions governing the distillation of coal will always apply.

### COMPOSITION AND DESTRUCTIVE DISTILLATION OF COAL.

Considerable work has been done upon the composition of various coals, and perhaps the most simple explanation of the different

products obtained from coal is given by Lewes (2),<sup>1</sup> who considers that all coals are composed of—

- A. Carbon residuum.                      C. Resin bodies.  
B. Humous bodies.                         D. Hydrocarbons.

The proportion in which these four components are mixed can be made to account for all the various coals known. He considers, for instance, Nottingham coal as made up of A B C D; coking coals in general as made up of 3A B C 3D; anthracite as being made up of 5A 2C. Three of these four constituents, namely, the humous bodies, the resin bodies, and the hydrocarbons, when subjected to heat, are partially or completely decomposed. The temperature at which this decomposition begins is probably between 300° and 400° C. The problem of tar formation is, however, complicated by the fact that most coal distillation is carried out in a retort or oven heated to approximately 1,000° C. This high temperature makes the composition of the tar very complicated, as it affords an opportunity for at least three different reactions to take place in the same coking chamber at approximately the same time. The primary reaction is a decomposition of the coal into those products which are formed by low-temperature distillations; the secondary reaction is a decomposition into simple products of some of the more complicated products of the primary reaction, and the tertiary reaction consists of a recombination of the simple products into aromatic hydrocarbons which are stable at high temperatures. These reactions are going on at the same time and may be complete or only partially so, depending upon several conditions. The various constituents of coal, according to Lewes, yield the primary-reaction products shown in Table 1.

TABLE 1.—*Primary-reaction products of coal.*

	Gaseous products.	Liquid products.	Solid products.
Humous bodies.....	{Carbon monoxide..... Carbon dioxide..... Methane.....	{Water. Thin tar.	}Free carbon.
Resin bodies.....	{Carbon monoxide..... Carbon dioxide..... Ethylene and other unsaturated hydrocarbons.....	{Water..... Thin tar.....	{Free carbon. Pitch.
Hydrocarbons.....	Methane, ethane, and other paraffins.....	Heavy tar.....	{Free carbon. Pitch.

The primary reaction may give the hydrocarbons shown in Table 2, all of which have been found in the distillation products of coal decomposed at low temperatures.

<sup>1</sup> All italic figures inclosed within parantheses refer to the bibliography, in which numbers are assigned to the different articles of literature.

TABLE 2.—*Hydrocarbons found in the primary-reaction products of the distillation of coal.*

Saturated hydrocarbons.		Unsaturated hydrocarbons.	Naphthenes.		
Methane	CH <sub>4</sub> .....	Ethylene	C <sub>2</sub> H <sub>4</sub> .....	Hexahydrobenzene	C <sub>6</sub> H <sub>12</sub> .
Ethane	C <sub>2</sub> H <sub>6</sub> .....	Propylene	C <sub>3</sub> H <sub>6</sub> .....		
Propane	C <sub>3</sub> H <sub>8</sub> .....	Butylene	C <sub>4</sub> H <sub>8</sub> .....		
Butane	C <sub>4</sub> H <sub>10</sub> .....	Amylene	C <sub>5</sub> H <sub>10</sub> .....		
Pentane	C <sub>5</sub> H <sub>12</sub> .....	Hexylene	C <sub>6</sub> H <sub>12</sub> .....		
Hexane	C <sub>6</sub> H <sub>14</sub> .....	Heptylene	C <sub>7</sub> H <sub>14</sub> .....		
Heptane	C <sub>7</sub> H <sub>16</sub> .....				
Octane	C <sub>8</sub> H <sub>18</sub> .....				
Nonane	C <sub>9</sub> H <sub>20</sub> .....				
Decane	C <sub>10</sub> H <sub>22</sub> .....				
Possibly	paraffins.....				

All these hydrocarbons, both gaseous and liquid, are similar to what we obtain from crude petroleum. In addition to the above, the oxygen in the coal is probably in a large measure converted into oxides of carbon and phenols, as we find these materials in great abundance in low-temperature tars. All of the products of the primary reaction, with the exception of the gaseous carbon monoxide, carbon dioxide, methane, and ethane, will undergo decomposition at somewhat higher temperatures into more simple hydrocarbons with a production of the permanent gases, methane, ethane, ethylene, acetylene, and hydrogen. This is the secondary reaction. The products of the secondary reaction probably contain compounds having three carbon atoms or less, with the exception of possibly small amounts of benzene and xylene, which result from the decomposition of the naphthenes. We should expect that this phase of the reaction would produce chiefly hydrogen; the saturated hydrocarbons—methane, ethane, and possibly propane; and the unsaturated hydrocarbons—ethylene, propylene, acetylene, and amylenes. All of these, as well as different members of the acetylene series, have been identified as products of the distillation of coal. If the gas maker could so arrange his distillation that only the first and second reactions would take place, it would probably be a very satisfactory arrangement for him. In order, however, to heat the coal hot enough all the way through to induce a secondary reaction as nearly complete as possible, it is necessary to superheat the retorts or ovens, and, as a result, a third reaction may and does take place.

The tertiary reaction consists in building up more complex but more stable compounds from the more simple ones. This reaction is often accompanied by the elimination of hydrogen. The hydrocarbons formed are those classed by the chemist as aromatic hydrocarbons, and they differ from the paraffin hydrocarbons in containing less hydrogen per carbon atom, in the arrangement of the carbon atoms themselves, in their chemical reactions, and in their resistance to heat. The aromatic hydrocarbons may be subdivided into a

large number of different groups, of which those shown in the diagram may be considered the simplest members of a few typical groups.

All of these compounds except naphthanthracene have been positively identified in coal tar, and very probably that one is present also. Many more combinations and structures are, of course, possible, for which the reader is referred to Beilstein's *Organische Chemie*. The general course of these reactions is probably somewhat as follows: Three acetylenes,  $C_2H_2$ , combine to form benzene,  $C_6H_6$ ; 2 benzenes unite to form diphenyl with the elimination of hydrogen; 1 benzene and 2 acetylenes combine to form naphthalene; 2 benzenes and 1 acetylene combine to form phenanthrene or anthracene; 1 benzene, 1 naphthalene, and 1 acetylene combine to form either chrysene or naphthanthracene. These reactions may take place in this manner

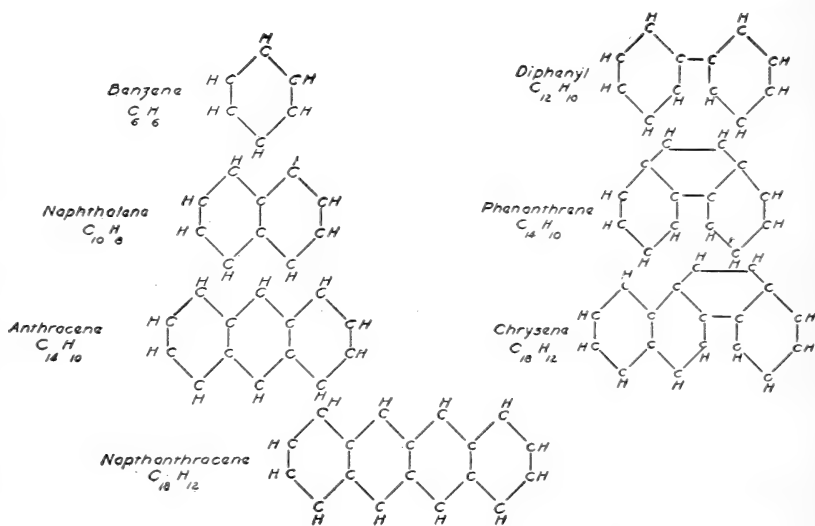

or through various intermediate stages. Part of these reactions, at least, have been carried out on a laboratory scale; others have followed the same general course, but have taken two or more stages in which to accomplish the final result.

From the above it is evident that, on the one hand, coal tars may be obtained containing large amounts of paraffins if the secondary and tertiary reactions are kept at a minimum; or, on the other hand, tars containing a predominance of aromatic hydrocarbons if the secondary and tertiary reactions are complete or nearly so. All stages of coal tars are known, from paraffin tars produced at low temperatures to aromatic tars produced at high temperatures. The tars generally used for the production of coal-tar creosote are those produced at high temperatures, but they may, under certain conditions, contain low-temperature tars. These reactions are governed by the

temperature of the gases, and this in turn is governed by the temperature of the retort and the time of contact of the gases with the heated walls. The time of contact of the gases with the walls is governed to some extent by the type of retort or oven used and the manner in which it is filled.

#### APPARATUS USED IN THE PRODUCTION OF COAL TAR.

As indicated before, high-temperature coal tar results in connection with the production both of illuminating gas and of coke. The apparatus and methods used, although they involve the same general reactions, differ in the following respects: First, the coals are different. In general, gas coal contains from 30 to 40 per cent of volatile matter, while the coal used for the production of coke contains from 15 to 25 per cent of volatile matter. Second, the sizes of the coking chambers are different. The capacity of the gas retort is measured by the hundredweight of coal per charge; the capacity of the coke oven is measured by the ton. The time of coking in gas-house practice may vary from 6 to 12 hours; in coke ovens it may vary from 24 to 60 hours.

There are three different types of gas benches used in this country, each type in general having several different subdivisions. The three types receive their names from the position of the retort itself. They are the horizontal retort, the inclined retort, and the vertical retort.

*Horizontal-retort benches.*—Horizontal retorts have a cross-section similar to the letter D laid on the flat side, and are about 18 inches wide and 15 inches high. They may be 6 to 18 feet long. The retort may be heated by direct coal fire, as in the older systems; or by producer gas, as in the more modern types. The coal may be charged by hand, sometimes by shovel, sometimes by a specially constructed trough or scoop; or by machinery, a retort known as the "through retort" having come largely into use. Figures 2 and 3 show views of a bench of machine-charged retorts. The hand-charged retort is usually filled about 6 inches in depth with coal, but it is possible to fill the machine-charged retort 12 inches deep. It has been shown by Lewes (2) that in the conditions first described the gas formed at the bottom of the retort rises through the charge and escapes from the retort chiefly through the space above the coal, and that it must of necessity come in very close contact with the heated walls of the retort. This almost assures a complete tertiary reaction. On the other hand, if the retort is filled, as it is possible for it to be with machine charging, the gas may escape largely through the center of the charge, which is cooler, and there may not be so complete a tertiary reaction. The tar would then not be composed entirely of aromatic hydrocarbons. Another factor that may enter into the

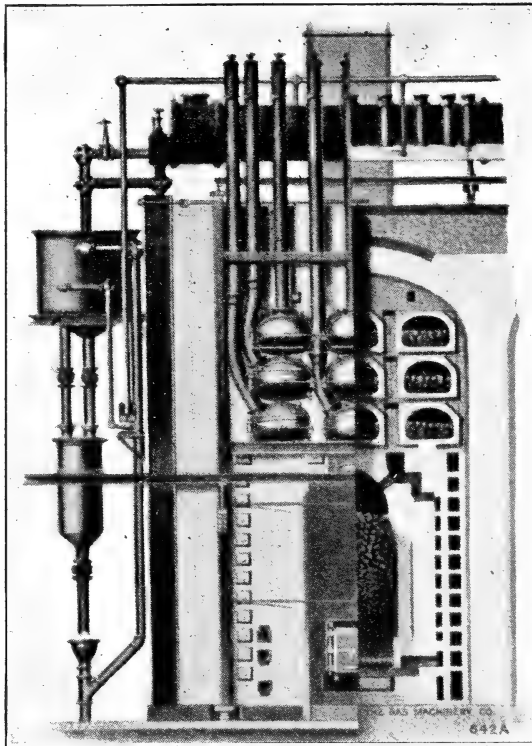

FIG. 2.—Cross-sectional view of bench of machine-charged horizontal retorts.

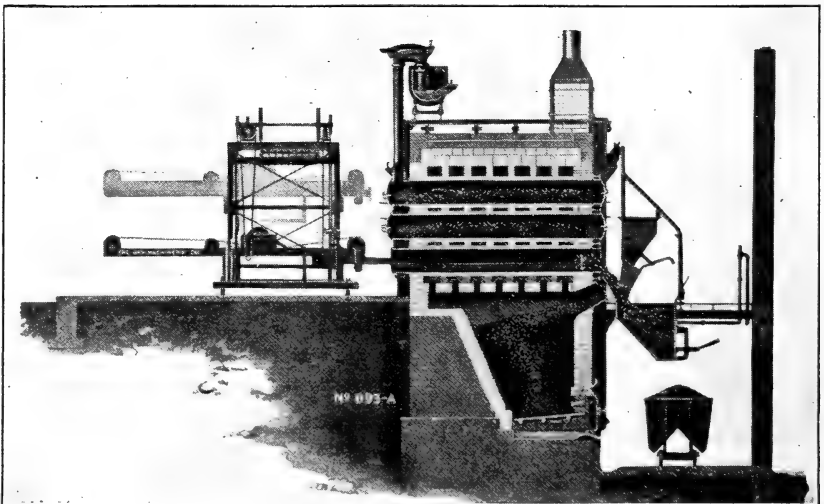

FIG. 3.—Longitudinal view of bench of machine-charged horizontal retorts.



composition of tar is the relation of the equipment at the gas plant to the demand for gas. The most efficient manner of operating any plant is not always the most expedient. During the war, when it was hard or impossible to obtain machinery, and at the same time the demand for the manufactured products was great, by shortening the time of coking and not attempting to remove all the gas, it was then found possible to increase the output of a given equipment to a considerable extent. Under such conditions the tar would be produced at a lower average temperature and hence the paraffin content would be higher.

*Inclined-retort benches.*—In the inclined-retort system the retorts are set at an angle which is as near as possible to the angle of recline of coal. This is in the neighborhood of 30 degrees. Coal is charged by gravity at the upper end of the retort, and under ideal conditions fills the retort to an even depth for its full length. This condition is not always realized in practice, and not infrequently a considerable amount of unburned coal is found near the lower door, while the upper part of the retort is nearly bare. This results in the tar containing high amounts of paraffin. At the present time the use of this system is not extending in this country.

*Vertical-retort benches.*—The fact that much space in textbooks is being devoted to the vertical retort would seem to indicate that in time this type of retort may replace the horizontal for gas-making purposes. The retorts are oval in cross-section and slightly larger at the bottom than at the top. The coal is charged and the coke extracted by gravity. For this reason the coal completely fills the cross-section of the retort. The escaping gases are, therefore, forced to travel chiefly through the cool core of uncarbonized coal. The resulting tars contain considerable amounts of paraffin bodies. In general, the specific gravity of tars from vertical retorts is less than that of tars from horizontal rerorts.

*By-product coke ovens.*—There are several types of by-product coke ovens in this country, but by far the greater proportion of them belongs to one or another of three systems. These systems differ from each other in several ways, as in methods of heating, in methods of regeneration of heat, and in methods of recovery of by-products, but the general principle underlying the manufacture of coke is the same as that used in retort practice.

The three principal systems are the Otto system, with its various modifications, the Semet-Solvay system, and the Koppers system. Figures 4, 5, 6, 7, and 8 show views of these three types of oven. By-product coke ovens are, in general, long, rectangular ovens which may vary in height from 3 to 9 feet and may be as long as 35 feet. The width of the oven, however, varies within narrow limits, being 17 to 19 inches. Inasmuch as coke ovens are generally erected in

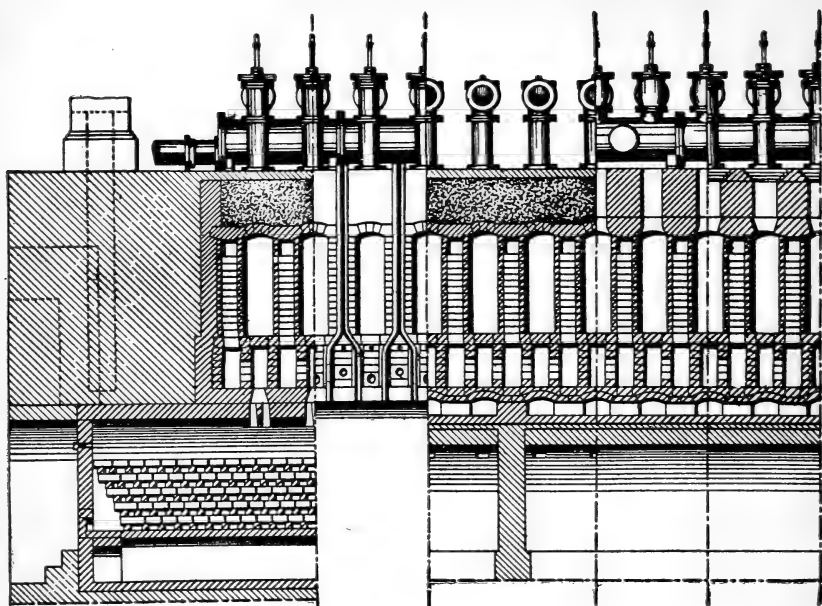

FIG. 4.—Longitudinal view of Otto-Hoffman (old style) coke ovens.

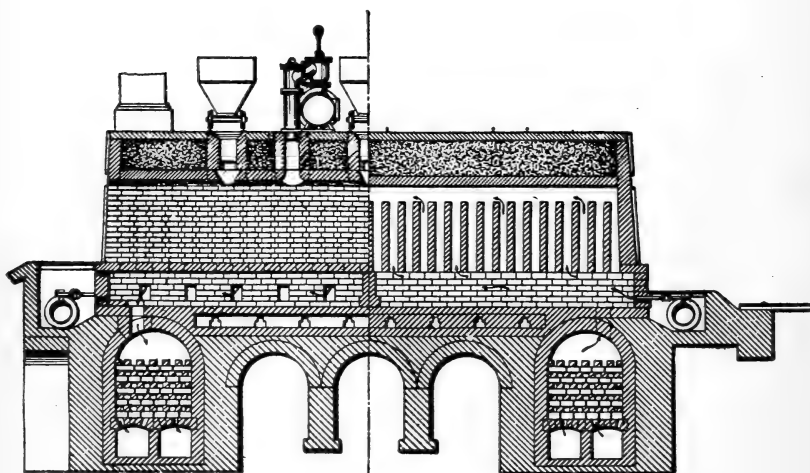

FIG. 5.—Cross-sectional view of Otto-Hoffman (old style) coke ovens.

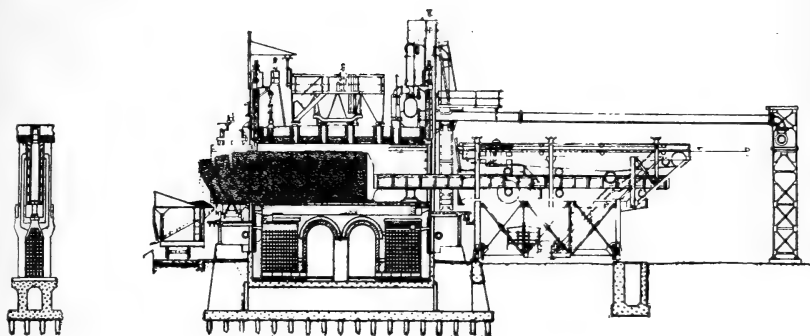

FIG. 6.—Cross-sectional and longitudinal views of Semet-Solvay coke oven.

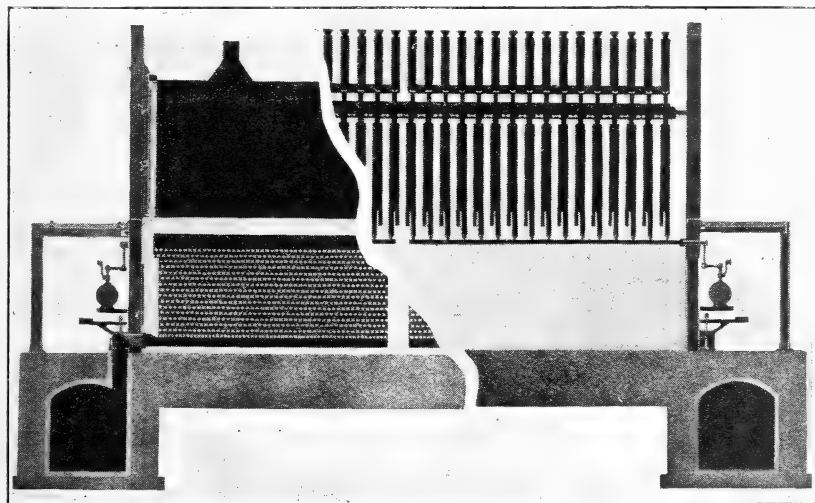

FIG. 7.—Longitudinal view of Koppers coke ovens.

batteries of 50 or more, side by side, there is but little chance to modify the method of heating. All of the ovens in this country, with the exception of the Semet-Solvay oven, heat the coking chamber by gas burned in vertical flues at the side of the chamber. The Semet-Solvay oven heats the coking chamber by gas burned in horizontal flues.

#### WATER-GAS TAR.

Water-gas tar is produced in the manufacture of carbureted water gas. This gas is produced in a machine known as a "water-gas set." It consists of three principal parts—a generator in which the true water gas is produced; a carburetor consisting principally of checker

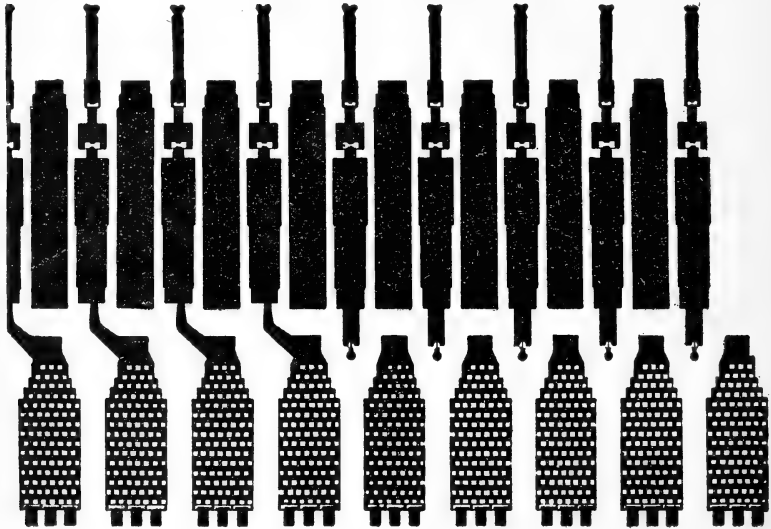

FIG. 8.—Cross-sectional view of Koppers coke ovens.

brick on which petroleum oil is sprayed in order to render the water gas of value for illuminating purposes; and a superheater, also of checker brick, in which the gases formed in the carburetor are fixed and made permanent. In operation the generator is filled to a suitable level with coke or anthracite coal. This is rendered incandescent by blowing through it air under pressure, the products of combustion passing through the carburetor, where they meet a secondary air supply and are completely burned in the carburetor and superheater. The gases passing from the superheater are allowed to escape in the stack and are lost, as they contain no material of heating value, and are used to obtain the proper temperature in the set. When the superheater and the rest of the water-gas set are of the proper temperature, the blowing is interrupted momentarily until the valves leading to the gas holder can be opened and the

escape valve closed. Steam is then blown through the coke bed, water gas being produced according to the equation  $C + H_2O = CO + H_2$ . As this gas enters the carburetor, gas oil obtained from petroleum is sprayed on the checker brick and cracked to permanent gases. This cracking and fixing of the gases is continued in the superheater. The gas, as it leaves the superheater, passes through condensers and scrubbers, where the tar is removed. The run with steam is continued until the temperature drops below a fixed point. This operation is then stopped, and the temperature is again raised by blowing. Table 3 shows a satisfactory set of operating conditions.

TABLE 3.—*Operating conditions in the water-gas set (4).*

Size of set.....	8 feet 6 inches.
Area of grate.....	33.2 square feet.
Fuel used.....	Oven coke.
Oil used.....	Lima gas oil.
Temperature at base of superheater.....	1,461° F.
Temperature at top of superheater.....	1,300° F.
Length of blow.....	3 minutes.
Length of gas make.....	4 minutes.

No tar is produced in the water-gas reaction itself, but is all obtained as a result of the cracking of petroleum oil. The same discussion which applied to the reactions taking place in coal-tar production apply equally well in this connection if we consider that the primary reaction as given under coal tar has already been performed by nature in the production of petroleum oil. Here again, as in producing coal gas, a gas manufacturer would prefer to have no Tertiary reaction; but, in the attempt to obtain a secondary reaction as complete as possible, some Tertiary products are formed. The presence of paraffin hydrocarbons in water-gas tar shows that, from the gas maker's point of view, a waste has resulted from insufficient cracking and the presence of aromatic tars shows a decrease in illuminating value on account of a recombination of some of the illuminants. The gas maker desires to obtain as small an amount of highly aromatic tar as possible with complete cracking of the oil. The presence of the large amount of hydrogen in water gas probably suppresses to some extent the Tertiary reaction which would normally be obtained by cracking petroleum in the presence of its own decomposition vapors, as is done in the manufacture of Pintsch and Blau gas; but the effect of this suppression would be no greater than a similar effect which must take place in coal gas, for the latter contains more hydrogen than does water gas.

The yield of tar depends, therefore, upon the completeness of cracking of the oil, which, in turn, is dependent upon the temperature to which the oil vapors are brought and the character of the oil used. Table 4 gives a comparative yield of water-gas tar from different oils.

TABLE 4.—Comparative yield of water-gas tar from different oils.

Mixture contains—		Volume of tar produced.
Class of oil.	Base.	
Naphthas.....	Paraffin.....	<i>Per cent.</i> 2 to 4
Gas oils.....	do.....	6 to 10
Crude oils.....	do.....	8 to 12
Gas oils.....	Asphaltic.....	10 to 15
Crude oils.....	do.....	12 to 18

### PRODUCTION OF TAR IN THE UNITED STATES.

The figures given in Table 5 show the number of gallons of coal tar produced in the United States since 1904:

TABLE 5.—Production of coal tar in the United States.

Year.	Retort tar.	By-product tar.
1904	41, 726, 970(5)	27, 771, 115(5)
1908	58, 541, 220(5)	42, 720, 009(5)
1912	40, 489, 855(6)	94, 306, 583(6)
1915	47, 863, 192(7)	138, 414, 601(7)
1917	53, 318, 413(7)	221, 999, 264(7)

No direct figures are available on the amount of tar produced by each type of retort or coke oven throughout this period. Some general idea may, however, be obtained from the following list of coke ovens in existence at the end of 1917: (8.)

Koppers.....	3, 374	Rothberg.....	281
Semet-Solvay.....	1, 831	Roberts.....	36
United Otto.....	2, 032	Didier.....	150
Wilputte.....	78	Total.....	7, 869
Gas machinery.....	60	Idle.....	571
Klönne.....	27		

The amount of water-gas tar produced and sold in this country as given by the United States Geological Survey is shown in Table 6:

TABLE 6.—Production of water-gas tar in the United States.<sup>1</sup>

Year.	Produced and sold.
	<i>Gallons.</i>
1905	9, 230, 411(9)
1908	9, 168, 834(6)
1912	34, 000, 000(6)
1915	51, 381, 911(7)
1917	59, 533, 208(7)

<sup>1</sup> Fulweiler (56) gives the production of water-gas tar in 1918 as approximately 70,000,000 gallons; in 1919, 75,000,000 gallons; and in 1920, 80,000,000 gallons.

### CHAPTER III. PRODUCTION OF CREOSOTE FROM TAR.

In commercial practice creosote is to a considerable extent a by-product of the manufacture of other materials. The details of the process, therefore, vary somewhat with the end product obtained. The process of manufacturing creosote consists, essentially, of the distillation of the tar and is in general the same, no matter what the end products may be.

The size and shape of the stills used for the purpose of commercial distillation vary somewhat according to the needs of the producer. In England and Germany, according to Lunge (10) and Warnes (11), the vertical still with a concave-upward bottom is preferred. Figure 9, taken from Lunge's *Coal Tar and Ammonia*, shows a cross-section of a 25-ton vertical still. Many stills of this general design are used in this country, but the horizontal still is more common. Figure 10 shows a battery of horizontal stills in use in this country.

The stills are filled to the proper level with crude or settled tar, preferably already heated by means of a preheater, and a slow fire is started under the still. In the early stages of the distillation extreme caution must be exercised, because most coal tar contains water, which can not readily be separated by standing. Too rapid heating will cause foaming or priming, with a loss of nearly the entire contents, unless the priming can be controlled.

In the United States it seems to be considered good practice to stir the contents of the still by using either air or steam, the former being preferred. This stirring aids in the prevention of foaming over during the early part of the distillation and results in a more rapid distillation when it is produced during the latter part of the process. A slight chemical reaction is also probably obtained. In Europe it is customary to inject steam into the still during the distillation of the anthracene oil. The number and graduation of fractions taken from coal tar depend largely on the markets for the various products. Warnes (11), an English writer, states that by far the greatest amount of tar distilled is divided into the following fractions: Crude naphtha, light oil, carbolic oil, creosote oil, anthracene or "green oil," and pitch. Lunge (10), in general, makes the same separation and gives the following temperatures as the cutting points of the various fractions:

Crude naphtha.....	Up to 105° or 110° C.
Light oils.....	From crude naphtha up to 165° or 210° C.
Carbolic oils.....	From light oil to 230° or 240° C.
Creosote oil.....	From carbolic oil to 270° C.
Anthracene oil.....	Above 270° C.

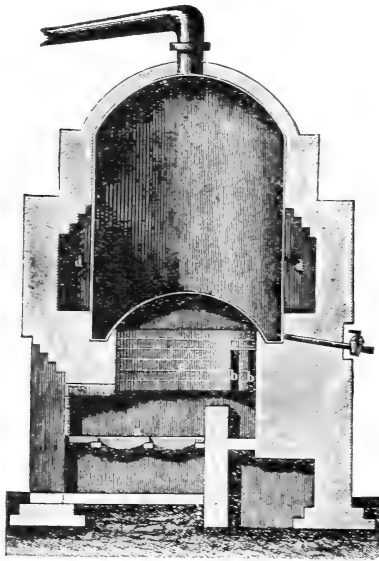

FIG. 9.—Cross-sectional view of European tar still. (Taken from Lunge's "Coal tar and Ammonia.")

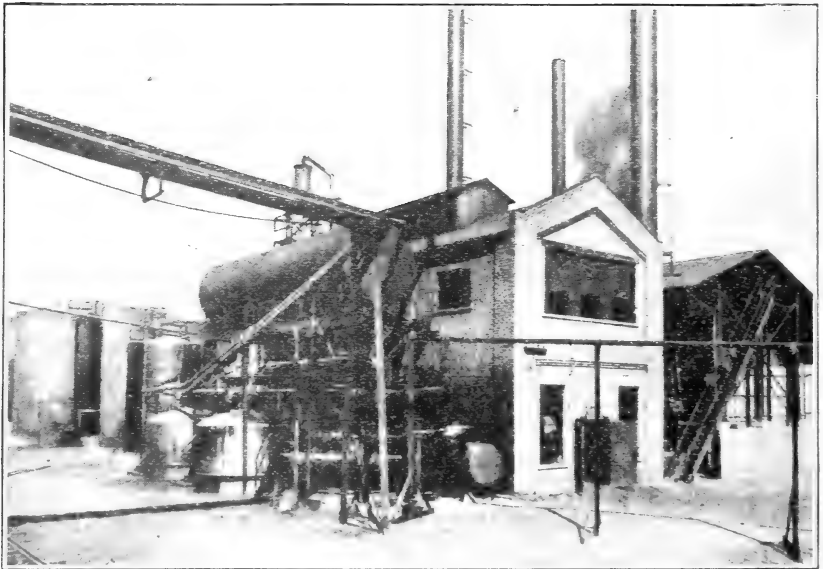

FIG. 10.—Battery of American tar stills and plant.



In this country there is little demand for either carbolic oil or anthracene oil. In general, therefore, these fractions are included in the creosote oil, and for the most part only three fractions are taken, namely, light oil, up to 200° or 210° C.; creosote oil, up to pitch; and pitch. The distillation is not carried so far as it is in Europe, but is run only to soft pitch. It is, therefore, expected that American oils will, in general, be somewhat lighter in specific gravity than the European oils, because the carbolic oils are usually included, and the distillation is not carried to so high a temperature.

It sometimes happens, however, when the demand for pitch is not very great, or when a special oil is desired, that the tar is distilled until only coke remains in the still. The coke, which is a very pure carbon, finds a sale for purposes similar to those for which retort carbon is used. The creosote, in consequence of the high temperature used in this distillation, is very high boiling and has a high specific gravity. There are at least two plants in this country which make special oils in this way.

Creosote oil, as it appears on the market, is not always a product obtained by the straight distillation of tar. It is frequently mixed with other products of coal tar, which are not of any value in other industries. For instance, the oil obtained by pressing the anthracene cake frequently finds its way to the creosote-oil tank, as does also the phenanthrene which results from the purification of the anthracene cake. The high-boiling oils known as carbolineums are, essentially expressed, "anthracene oils." In this country, tar is sometimes added to light creosote oils to raise their gravity. This tar may be either water-gas tar or low-carbon coal tar. The light creosote oils are sometimes redistilled, to remove part of the light oil and naphthalene and thus produce an oil that will fulfill specifications otherwise not met by the total distillate.

The amount of material classed under "creosote" that was produced, imported, and used in this country is shown by Table 7, covering the last nine years. These figures include not only straight distilled products of coal tar, but, in all probability, water-gas-tar creosotes, mixtures of water-gas-tar creosotes and coal-tar creosotes, and mixtures of either or both with coal tar, either refined, filtered, or crude, as well as mixtures of either or both with water-gas tar. No estimate of the amount of these mixtures can be made.

TABLE 7.—*Relative quantities of domestic and imported creosotes used by the treating plants of the United States, 1909 to 1918 (1).*

Year.	Total creosote used.	Domestic creosote.	Per cent of total.	Imported creosote.	Per cent of total.
	<i>Gallons.</i>	<i>Gallons.</i>		<i>Gallons.</i>	
1909	51,426,212	13,862,171	27	37,569,041	73
1910	63,266,271	18,184,355	29	45,081,916	71
1911	73,027,335	21,510,629	29	51,516,706	71
1912	83,666,490	31,135,195	37	52,531,295	63
1913	108,373,359	41,700,167	38	66,673,192	62
1914	79,334,606	28,026,870	35	51,307,736	65
1915	80,859,442	<sup>1</sup> 43,358,435	54	37,501,007	46
1916	90,404,749	<sup>2</sup> 46,754,818	52	43,649,931	48
1917	75,541,737	<sup>3</sup> 57,282,596	76	18,259,141	24
1918	52,776,386	<sup>4</sup> 50,610,650	96	2,165,736	4

<sup>1</sup> 41,333,890 gallons coal-tar creosote and 2,024,545 gallons water-gas tar.

<sup>2</sup> 45,318,735 gallons coal-tar creosote and 1,436,083 gallons water-gas tar.

<sup>3</sup> 54,305,204 gallons coal-tar creosote and 2,977,392 gallons water-gas tar.

<sup>4</sup> 47,787,998 gallons coal-tar creosote and 2,822,652 gallons water-gas tar.

## PART II. EXPERIMENTAL COMPARISON OF AUTHENTIC SPECIMENS OF CREOSOTE.

### CHAPTER I. COLLECTING AND TESTING THE SPECIMENS OF CREOSOTE.

In the early part of 1911 experiments were begun at the Forest Products Laboratory for the purpose of obtaining data on the chemical and physical properties of authentic coal-tar and water-gas-tar creosotes in order to check up the results previously obtained by the laboratory, and also of determining how wide a variation in these properties may be expected from the different retorts or ovens under various conditions of heating and with the different kinds of coal used. At the time the experiments were begun the latest available figures for the production of tar were the following:

	Gallons.
Gas-house tar, 1908.....	58,541,000
Coke-oven tar, 1909.....	60,126,000
Water-gas tar, 1908.....	14,700,000

The production of gas-house tar and that of coke-oven tar were, therefore, about equal, and the water-gas tar produced was about one-fourth of the product of the gas-house industry.

#### MATERIAL USED.

In collecting the samples of coal tar for this work the following points were taken into consideration: First, the type of retort or by-product oven employed; second, the kind of coal used; third, the temperature of coking. Circular letters were sent out to all the gas plants in this country that were manufacturing over 20,000,000 cubic feet of coal gas a year, asking for information on these points. Over 75 per cent of the companies replied. Of a total of 91 gas houses using coal, 82 used the horizontal retort, 7 the inclined retort, and 2 the vertical retort. Westmoreland coal was used by 19 of these, Youghiogheny by 35, Alabama by 7, Tennessee by 2, and the remainder were using mixtures of coal from different localities, chiefly mixtures of Westmoreland, Youghiogheny, and West Virginia, with other coals. Very few replies were made concerning the temperature, except in such terms as white, orange, cherry, and red heat. In the few instances given, the temperatures ranged from 1,800° F. (982° C.) to 2,700° F. (1,482° C.).

In view of the predominance of Youghiogheny and Westmoreland coal in the gas-house industry, it was decided to take six samples of

tar from Youghiogheny and five from Westmoreland. In addition, three samples were taken from plants using Alabama coal and three from plants using mixed coal in the horizontal retorts. Certain earlier investigations at the Forest Products Laboratory had shown that the tar produced from at least one inclined-retort plant had certain peculiarities which at the time put it under the suspicion of having been contaminated with other tars. For this reason it seemed desirable to visit as many of these plants as could be conveniently reached and determine whether these differences in properties were peculiar to the one plant or whether they were characteristic of inclined-retort tar. Six samples of this tar were collected. At the time of the collection only two plants were using the vertical retort, and one of these was not in active operation. Therefore, only one sample of vertical-retort tar was taken. Approximately one-half of the by-product coke-oven plants then existing were visited. They included six Semet-Solvay, five Otto or Otto-Hoffman, and one Koppers oven plant.

Table 8 shows the maximum temperature at which the coal was coked, and the specific gravity and free-carbon content of the tar produced by the different types of oven, as determined by the Office of Public Roads in 1912.

TABLE 8.—*Specific gravity and free-carbon content of various coke-oven tars.*

Type of oven.	Maximum temperature of coal (° C.).	Specific gravity of tar at 25° C.	Free-carbon content.	Type of oven.	Maximum temperature of coal (° C.).	Specific gravity of tar at 25° C.	Free-carbon content.
Koppers.....	1,388	1.171	3.89	Otto-Hoffmann....	1,200	1.160	13.94
Do.....	880 to 950	1.169	2.73	Do.....	1,000	1.214	14.05
Semet-Solvay.....	950 to 1,150	1.195	7.76	Do.....	.....	1.143	10.81
Do.....	950 to 1,150	1.206	8.77	Do.....	1,111	1.160	8.37
Do.....	950 to 1,150	1.176	7.14	United Otto.....	1,444	1.191	7.89
Do.....	950 to 1,150	1.168	6.10	Do.....	1,222	1.179	8.49
Do.....	950 to 1,150	1.173	4.71	Do.....	1,222	1.133	5.21
Do.....	950 to 1,150	1.191	7.49	Do.....	1,222	1.176	10.53
Do.....	950 to 1,150	1.169	6.56	Do.....	.....	1.195	12.18
Do.....	950 to 1,150	1.159	6.07	United Otto and			
Do.....	950 to 1,150	1.181	8.85	Otto-Hoffmann..	833 to 1,055	1.182	11.30
Do.....	950 to 1,150	1.159	5.05	Do.....	1,111	1.211	12.40
Do.....	950 to 1,150	1.141	3.96	United Otto and			
Do.....	950 to 1,150	1.175	6.90	Rothberg.....	1,000	1.210	16.80

Attention is particularly directed to the low carbon content of these tars. Of the 26 listed, only 8 have more than 10 per cent.

A total of 36 specimens of coal tar reached the Forest Products Laboratory in good condition. Three specimens were lost through leakage in transit. Table 9 gives the type of retort or oven from which the specimen tars were obtained, the kind of coal used, and a rough measure of the temperature used in coking. The temperatures shown for by-product tar were those given in Circular 97 of the Office of Public Roads for the same plants. For the most part

the coals used in by-product ovens were a mixture of two or more coals, as is customary in this industry.

These samples were collected from the States of Rhode Island, Massachusetts, Connecticut, New York, Pennsylvania, Delaware, Maryland, Ohio, Illinois, Missouri, Wisconsin, and Alabama. They represent fairly this country's total production of coal tar.

TABLE 9.—*Coal tars used in experimental work.*

Tar number.	Kind of retort or oven.	Kind of coal.	Temperature.
1	Horizontal retort.....	Youghiogheny.....	White to cherry.
2	.....do.....	.....do.....	Cherry.
3	.....do.....	.....do.....	Do.
4	.....do.....	.....do.....	Do.
5	.....do.....	.....do.....	Orange.
6	.....do.....	.....do.....	Cherry.
7	.....do.....	Westmoreland.....	Red.
8	.....do.....	.....do.....	Cherry.
9	.....do.....	.....do.....	Do.
10	.....do.....	.....do.....	White.
11	.....do.....	.....do.....	White to Cherry
12	.....do.....	Alabama.....	Orange.
13	.....do.....	.....do.....	Do.
14	.....do.....	Mixed.....	Cherry.
15	.....do.....	.....do.....	Orange.
16	.....do.....	.....do.....	Red.
17	Inclined retort.....	Westmoreland.....	Cherry.
18	.....do.....	.....do.....	Do.
19	.....do.....	.....do.....	Do.
20	.....do.....	.....do.....	Orange.
21	.....do.....	Mixed.....	Cherry.
22	.....do.....	.....do.....	Do.
23	Vertical retort.....	Westmoreland.....	Do.
24	Otto oven.....	Native.....	1,100 to 1,300° C.
25	.....do.....	Fairmont.....	
26	.....do.....	Mixed.....	
27	.....do.....	.....do.....	
28	.....do.....	.....do.....	
29	Semet-Solvay.....	Westmoreland and Pocahontas.....	
30	.....do.....	Mixed.....	
31	.....do.....	.....do.....	
32	.....do.....	West Virginia.....	
33	.....do.....	Mixed.....	
34	.....do.....	Alabama.....	
35	Koppers.....	.....do.....	

The samples of water-gas tar were taken for the most part at plants making both water gas and coal gas, but a number were collected from plants using only the water-gas process. They were taken from the same States as the coal-tar samples, and fairly represent the production of this kind of tar east of the Mississippi River, if not of the whole country. Table 10 indicates the number of the water-gas tars, the kind of oil used, the temperature regulation, and whether the plant manufactures coal gas also.

TABLE 10.—*Water-gas tars used in experimental work.*

Tar number.	Kind of oil used.	Temperature regulation.	Plant manufactures-coal gas also.
37	Gas.....	None.....	No.
38	.....do.....	.....do.....	No.
39	.....do.....	.....do.....	Yes.
40	.....do.....	.....do.....	Yes.
41	.....do.....	.....do.....	Yes.
42	.....do.....	.....do.....	Yes.
43	.....do.....	.....do.....	Yes.
44	.....do.....	Yes (1,360° to 1,400° F.)	Yes.
45	.....do.....	No.....	Yes.
46	.....do.....	Yes (1,350° to 1,400° F.)	Yes.
47	.....do.....	No.....	No.
48	.....do.....	.....do.....	No.
49	.....do.....	Yes (1,300° to 1,400° F.)	No.
50	.....do.....	.....do.....	No.
51	.....do.....	.....do.....	Yes.
52	.....do.....	No.....	No.
53	.....do.....	Yes (1,300° to 1,400° F.)	Yes.
54	.....do.....	No.....	Yes.

The apparatus used for distilling the tars is shown in figure 11. The still proper, *A*, consists of an ordinary 2-gallon cast-iron pot still with a wide top clamped gas-tight. This still was mounted in an iron framework and suitably shielded with asbestos boards. It was tapped at the bottom, and a connection made with  $\frac{1}{4}$ -inch gas pipes, *B*, to permit the entrance of more tar and to serve as an inlet for air. This pipe was also provided with a union, so that after distillation the upright part could be turned down and serve as an exit for the molten pitch. The gooseneck on the still was changed somewhat, in order to admit of the use of a thermometer *T*, and also to provide for a peep sight *P*, at the top of the still. In making the peep sight, two pieces of brass tubing were threaded to fit a  $\frac{3}{4}$ -inch cross. In the threaded ends of these tubes were cemented two pieces of glass tubing containing a flattened bulb at the end. When the brass tubes were inserted in their proper places, the two glass surfaces were from one-fourth to one-half inch apart. This peep sight provided an indication as to the working of the still. One of the greatest difficulties encountered in the distillation of the tar was the frothing over of the still caused by the presence of moisture. When this occurred, the peep sight was blackened, and the operator had a fraction of a second in which to turn off the gas and air and adjust the three-way cock *E*, to catch the undistilled tar in a separate container, so that it could be returned to the still by means of a separatory funnel *F*, at the top of the inlet tube. It was found by experiment that the easiest way to distil coal tar was to use at the start only one-half of the amount of material for a full charge, and by careful heating and by stirring with air to raise the temperature, as recorded by the thermometer at *T*, to about 110° C., and not above 120° C. When this point was reached, the rest of the tar for a

full charge was admitted along with air in a slow stream through the separatory funnel *F*. In this way only very small quantities of water were present at one time in the still, and the slow drying that would otherwise be necessary was avoided and at the same time the danger from frothing was eliminated. Air-cooled glass condensers *D* were used throughout the work, but they were supplemented by a water-cooled reflux condenser *R* at the receiver during the early stages of the distillation. The apparatus could be used for distillation in a stream of air, or without air, or with steam, as the case might require, and could be changed from one system to another during the distillation.

#### APPARATUS AND METHOD USED IN TESTING THE CREOSOTES.

##### APPARATUS FOR DISTILLING TARS.

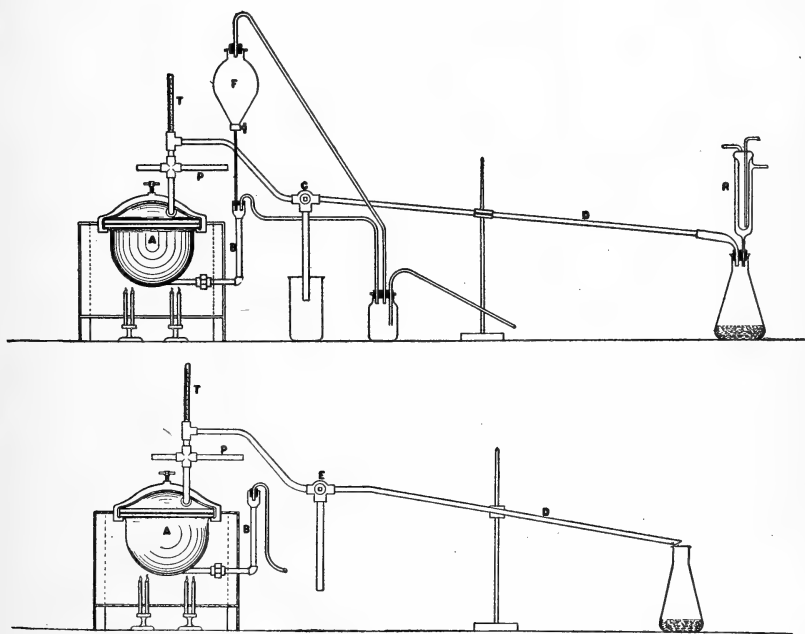

FIG. 11.—Apparatus used for distilling tars.

For the reader's convenience, a complete description of the apparatus and methods used in the testing of the creosotes is given in detail, although part of it has been published before. (12)

*Distillation test.*—In all distillations a Hempel flask was employed. Hempel flasks are usually made from Jena glass or its equivalent. The bulb is of such a capacity that, when it is filled to the bottom of the neck, it holds 500 cubic centimeters, a variation of 25 cubic centimeters being allowed. The neck of the flask is 1 inch in diameter and  $7\frac{1}{2}$  inches long from the top of the bulb to the delivery tube and extends 3 inches above the delivery tube. The delivery tube makes

an angle of  $75^\circ$  with the neck of the flask, and is one-fourth inch in diameter and  $8\frac{1}{2}$  inches long. The neck of the flask is constricted at its junction with the bulb to three-fourths inch in diameter. This constriction is made so that a loose plug of wire, preferably platinum, may be dropped into the neck to support a column of glass beads. In making the plugs used at the Forest Products Laboratory, two circles of heavy wire were fastened together at right angles to each other, and another circle of heavy wire was fastened to them in such a manner that the plane of this circle was perpendicular to the plane of the other two. Using these three circles as a framework, wire was used to fill up the spaces on the surface of the sphere and form a network through which the beads would not slip. Another device which serves the purpose equally well may be made from perforated sheet metal bent in the shape of a truncated cone. In constructing these, a circle  $1\frac{1}{2}$  inches in diameter was cut from perforated sheet brass of 23 B. S. gauge, having 23 perforations 0.023 inch in diameter to the linear inch. On the outside of the circle was cut a number of irregular notches one-fourth inch across and one-fourth inch deep. A sector was next cut from the whole, so that the remaining portion contained about two-thirds of the total area of the circle. The edges of this section were then drawn together and fastened by a wire in the form of a cone. Lastly, a small weight was hung from the center of the cone like the clapper in a bell, so that the cone would stand upright when it was dropped into the flask. This would support the column of beads fully as well as platinum wire, and had the advantage of being somewhat cheaper.

The bead column is composed of approximately 200 glass beads, but its height should be kept constant at 5 inches with a variation of not more than one-fourth inch. Some previous work by the Forest Products Laboratory on the distillation of turpentine (Forest Service Bulletin 105) has shown that the most important factor in the use of a Hempel column in distillation is the height of the bead column. The diameter of the column and the size of the beads have apparently but little effect, so far as the efficiency of separation is concerned, but do affect the speed at which the distillation can be run. If the same speed and the same height are used, the results obtained are identical, irrespective of the size of the beads or the diameter of the bead column, provided that the speed is not great enough to prevent the condensed liquid from returning to the flask.

The distillations were run at a rate as nearly uniform as possible. The speed of the dropping was timed by the use of a metronome set at 90 a minute and kept as near this rate as possible. At no time, however, was it allowed to exceed 120 drops or to go below 60 when once the distillation had been started.



The flask in position for distillation is supported on an asbestos board in which a hole has been cut almost as large as the great diameter of the bulb. The outline of this opening is irregular to permit the flame to play about the bulb. No wire gauze is used, for there is no danger of breakage so long as the flame does not come in contact with dry glass. The portion of the bulb above the asbestos board and below the Hempel column is protected from drafts by an asbestos box. No protection is given to the Hempel column unless the condensation becomes so great that the column begins to fill, and then it is surrounded by an asbestos box sufficiently large to prevent any portion of it coming in contact with the glass. The condensers used are ordinary glass tubing about one-half inch in diameter, drawn down at one end to about one-fourth inch and flanged at the other to receive a cork stopper. The length is approximately 8 inches. This has been found to be sufficient to condense all of the lighter oils but not sufficiently long to cause much solidification of the higher distillates in the tube. If solidification should occur, it is always melted out before the fraction is taken.

The thermometers used in this work were made of Jena borosilicon glass and were filled above the mercury column with carbon dioxide at a pressure of approximately 15 atmospheres. They read from 180° to 550° C. and were standardized either by the Bureau of Standards or by the German Physikalisch Technische Reichsanstalt. Corrections were made for the slight inaccuracy of the thermometers and also for the emergent stems. This latter correction is not usually made in creosote distillation, and would not be necessary if a standard thermometer were used for all such distillations and if the length of the emergent stem were the same in all cases. At the time this work was started no standard thermometer for creosote distillation had been adopted or even proposed by the various associations interested in wood preservation. The correction was necessary, therefore, as only by this method could the data here presented be compared with data in the collection of which thermometers of different lengths had been used.

For those who are not familiar with the emergentstem correction, the following explanation of its meaning and use is given. Mercurial thermometers are usually standardized with the whole of their mercury column at the same temperature as that of the bulb. This is possible only when the total length of the thermometer is bathed in the heated vapors or liquid. If this is impossible, then the thread of mercury is cooler than the bulb, and an error is introduced which makes the observed reading too low. If the difference between the temperature of the stem and bulb is small, this error is negligible; but if the difference is large, and the length of the emergent stem is great, the error becomes a factor of considerable importance, and

may be as great as 10° C. at the temperature used in distilling creosote oil. The formula for making the correction for this error is given in various ways. That adopted by the United States Bureau of Standards is  $F(T-t)N$ , in which  $T$  equals the observed reading of the thermometer;  $t$ , the average temperature of the emergent stem, obtained by placing another thermometer with its bulb at the center of the emergent stem;  $N$ , the number of degrees emergent, and  $F$  a factor for the thermometer depending upon the difference of expansion of glass and mercury. This factor varies from about 0.00015 to 0.00017; for Jena borosilicon glass the factor is 0.000158. Some idea of the size of these corrections may be obtained from Table 11.

TABLE 11.—*Corrections for emergent stem.*

$T$ .	$t$ .	$N$ .	Correc- tion.	$T$ .	$t$ .	$N$ .	Correc- tion.
200	.....	.....	.....	270	52.0	70	2.4
210	42	10	0.3	280	53.5	80	2.9
220	43.5	20	.6	290	55.0	90	3.4
230	45.0	30	.9	300	57.0	100	3.9
240	47.0	40	1.2	310	58.5	110	4.4
250	48.5	50	1.6	320	60.0	120	5.0
260	50.0	60	2.0	360	70.0	160	7.5

It is obviously impossible to perform the calculations necessary for this correction and at the same time watch a distillation in which fractions are being taken every 10 degrees. In this work, therefore, the position of each thermometer was fixed in respect to the distilling vessel and a table was worked out with different values for  $t$ . One of these tables is shown below (Table 12). It also makes correction for the errors in the thermometer caused by the irregularities in its construction.

TABLE 12.—*Emergent-stem corrections used with thermometer No. 1.*

Temp- erature desired when cor- rected.	Temperature to be read when—				Temp- erature desired when cor- rected.	Temperature to be read when—			
	$t=60$ .	$t=70$ .	$t=80$ .	$t=90$ .		$t=60$ .	$t=70$ .	$t=80$ .	$t=90$ .
°C.	°C.	°C.	°C.	°C.	°C.	°C.	°C.	°C.	°C.
180	180.9	.....	.....	.....	265	263.1	263.2	.....	.....
205	205.9	.....	.....	.....	275	272.5	272.5	.....	.....
215	215.7	.....	.....	.....	285	281.8	281.9	282.0	.....
225	225.2	.....	.....	.....	295	291.2	291.4	291.5	.....
235	234.8	.....	.....	.....	305	300.6	300.7	300.9	301.0
245	244.2	.....	.....	.....	315	310.2	310.3	310.5	310.6
255	253.7	.....	.....	.....	330	324.4	324.6	324.7	324.9

With this table before the operator, it was necessary only to determine  $t$  by a small thermometer hung in the air beside the standard and, by reference to the table, determine the exact point at which the cut should be made. The differences in these corrected readings

and those which would have been obtained under the same conditions by a thermometer complying with the specifications adopted by the American Wood Preservers' Association in 1912 are shown in Table 13.

TABLE 13.—Comparison of temperature readings of corrected thermometers and standard thermometers of the American Wood Preservers' Association, uncorrected.

Cor- rected temper- ature.	Stand- ard ther- momet- er, A. W. P. A., uncor- rected.	Differ- ence.	Cor- rected temper- ature.	Stand- ard ther- momet- er, A. W. P. A., uncor- rected.	Differ- ence.
° C.	° C.	° C.	° C.	° C.	° C.
180	178.8	1.2	265	260.2	4.8
205	203.0	2.0	275	269.7	5.3
215	212.7	2.3	285	279.1	5.9
225	222.2	2.8	295	288.4	6.6
235	231.8	3.2	305	297.7	7.3
245	241.3	3.7	320	311.7	8.3
255	250.8	4.2			

The fractions taken in this work are those given in Tables 12 and 13 in the first column. Two hundred and fifty grams of oil were used for a distillation, and the percentage weight of each fraction was determined to the nearest one-tenth of 1 per cent.

*Index of refraction test.*—The nature of the refraction test may be briefly described. When a ray of light passes from one medium to another of different density, it is bent out of its course or refracted. A familiar example of this refraction is shown by the appearance of piling just at the water line. Both above and below the water line the pile appears straight, but that portion of the pile under water appears to be nearer than the portion above. This is because of the difference in the refraction of light in air and in water. The refraction of light varies with every pair of media through which the light passes; but, if some medium is taken as a standard, then all measurements may be referred to it. The standard adopted is air. The refraction of light is measured by the angle through which the beam is bent in passing from air into the other medium. This measurement may be made by degrees and minutes or, for convenience, in what is known as the index of refraction. The index of refraction is the sine of the angle of incidence divided by the sine of the angle of refraction. The most convenient instrument for measuring this property is known as the Abbé refractometer, a view of which is shown in figure 12. It consists essentially of a split prism, *AB*, surrounded by heating chambers, all of which are mounted on a movable carriage, which in turn is connected to a lever carrying the reading glass *L*, over the fixed scale *J*. Above this split movable prism is mounted a spyglass, *F*, which in held is a fixed position in respect to

the scale *J*. The prism *AB*, being split, may be opened to receive the liquid material between the two faces, and it is this minute quantity of oil or other substance which we use in measuring the index of refraction. In operation light falling on the mirror is reflected into the prism *AB*. After passing through *B*, if no material is contained between the prism faces *A* and *B*, the light is totally reflected by the polished surface of *A*, and no light can pass into the spyglass above. If material is present, the light is refracted by this material, and this refracted light passes through the prism *A* into the spyglass, where it appears as a light portion above a shadow. The lever carrying the glass *L* and the split prism are then moved until the junction of light and shadow appears to be on the cross-hairs with which the spyglass is provided. The index of refraction is then read from the scale *J* by means of the reading glass *L*. No calculations are necessary.

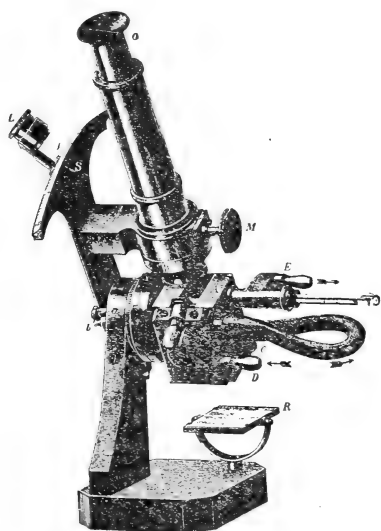

FIG. 12.—The Abbé refractometer.

With pure material the index of refraction has been used in determining the structure and character of carbon compounds, but with creosote it is merely a measure of a physical property of the oil which is easy of attainment. The same combinations of the same substances will always give the same index of refraction at a fixed temperature; but it does not always follow that, because the same index of refraction is obtained, two oils are of identical composition. The refractometer finds a very large use in commercial testing, particularly of oils, fats, and low-melting waxes, because exceedingly rapid as well as accurate measurements can be made.

The index of refraction was taken on all fractions above  $235^{\circ}\text{C}$ ., up to the point at which the distillate was no longer liquid at  $60^{\circ}\text{C}$ . the temperature at which these measurements were made. The values for the index of refraction are affected by the temperature to a considerable extent, and the higher the temperature the lower the index of refraction. It is, therefore, necessary either the measurements of this physical property be taken at a constant temperature or else that a correction be applied to change the observed reading to that at a standard temperature. The temperature factor for changing index of refraction values varies with different substances; hence, correction factors for creosote would be as

great in number as the number of fractions taken. All readings of the index of refraction were, therefore, taken at the standard temperature of 60° C., a possible variation of 1° being permitted. This variation is corrected by the use of the factor 0.00036 per degree. The factor is added when the actual temperature is above 60° C., and subtracted when it is below.

*Specific-gravity test.*—The specific gravity of the fractions was taken at 60° C. by means of a Westphal balance having a displacement of approximately 2 cubic centimeters. Here, again, as in the index of refraction, the factor for changing the readings at one temperature to those of another temperature is unknown; consequently, they were taken at exactly 60° C., this temperature being maintained by means of a water-bath whose temperature was controlled to one-tenth of a degree. The density of the fractions was referred to the density of water at 60° C., and, as the density of water has been very accurately determined (13), the readings given in this paper may easily be transferred to those at any other temperature, if that is desired. The values for 60° C. given in this publication are higher than they would be if water at 15° C. were taken as unity, but may be calculated to that standard by multiplying by 0.986. In a few cases the volume of the fractions was too small to make possible the determination of the specific gravity. In such cases two adjacent fractions were mixed, and the gravity was recorded as the average of the two. This made possible a record of the gravity of fractions which would otherwise have been omitted.

*Sulphonation test.*—The sulphonation test used was that described in Forest Service Circular 191. Ten cubic centimeters of the fraction of creosote to be tested are measured into an ordinary Babcock milk bottle. To this is added 40 cubic centimeters of 37/N sulphuric acid, 10 cubic centimeters at a time. The bottle with its contents is shaken for 2 minutes after each addition of 10 cubic centimeters of acid. After all the acid has been added, the bottle is kept at a constant temperature of 98° to 100° C. for one hour, during which time it is shaken vigorously every 10 minutes. At the end of the hour the bottle is removed, cooled, filled to the top of the graduation with ordinary concentrated sulphuric acid, and then whirled for 5 minutes in a Babcock separator. The unsulphonated residue is then read off from the graduation. The readings from the major graduations multiplied by two give the percentage of sulphonated residue by volume. Each major graduation is equal to one-fifth of a cubic centimeter, and the minor graduations are sometimes equal to one-twenty-fifth and sometimes to one-fiftieth of a cubic centimeter.

In well-equipped laboratories the usual steam-jacketed ovens capable of maintaining a temperature of 98° to 100° C. will keep the reaction mixture of the sulphuric acid and creosote at the proper tem-

perature. It frequently happens, however, that creosotes are analyzed in laboratories equipped for that purpose only; for such an equipment a special steam-bath or oven may be made by any tinsmith at small cost. It is essential that the chamber be of sufficient size to contain the Babcock bottle completely. Otherwise the exact dimensions of the steam bath are unimportant. The 37/N sulphuric acid is prepared by mixing fuming sulphuric acid with enough ordinary sulphuric acid so that the finished mixture will contain 80.1 per cent  $\text{SO}_3$ . Fuming sulphuric acid may be purchased in different concentrations, and there are two methods in common use for recording the strength. This is sometimes given in terms of free  $\text{SO}_3$ , and at other times in terms of  $\text{H}_2\text{S}_2\text{O}_7$ . Table 14 shows the relation between the two methods of nomenclature.

TABLE 14.—Concentration of  $\text{SO}_3$  in fuming sulphuric acid.

Per cent total $\text{SO}_3$ .	Per cent $\text{H}_2\text{S}_2\text{O}_7$ .	Per cent free $\text{SO}_3$ .	Per cent total $\text{SO}_3$ .	Per cent $\text{H}_2\text{S}_2\text{O}_7$ .	Per cent free $\text{SO}_3$ .	Per cent total $\text{SO}_3$ .	Per cent $\text{H}_2\text{S}_2\text{O}_7$ .	Per cent free $\text{SO}_3$ .
81.8	0	0	85.1	40	19	88.4	80	37
82.6	10	5	85.9	50	23	89.2	90	41
83.4	20	10	86.7	60	28	90.0	100	46
84.2	30	14	87.5	70	32			

The proper proportion in which to mix ordinary concentrated sulphuric acid with fuming sulphuric acid ( $\text{H}_2\text{S}_2\text{O}_7$ ) is shown by figure 13.

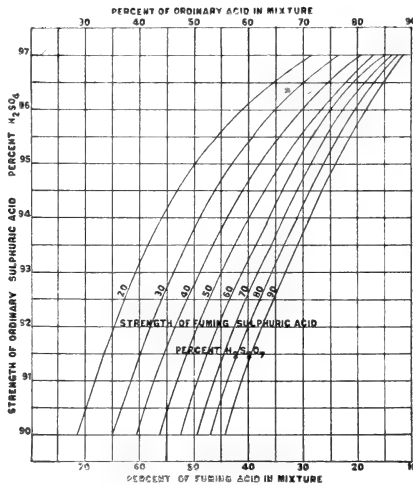

FIG. 13.—Proportion of fuming sulphuric acid  $\text{H}_2\text{S}_2\text{O}_7$  required to raise ordinary sulphuric acid to approximately 37.

*Tar acids.*—For the most part tar acids were not estimated; when they were, the methods specified by the National Electric Light Association, as given in Part IV, were used.

## CHAPTER II. DETERMINING CERTAIN CONDITIONS FOR THE TESTS.

### EFFECT OF AIR ON TARS DURING DISTILLATION.

As already mentioned, it is usually considered good practice in this country to blow air through the tar during distillation. This offers an opportunity for chemical reaction which might have a considerable effect on the physical and chemical properties of the creosote. It was therefore essential, before work on authentic material was undertaken, that the effect of blowing air through the tar should be known. A tar was distilled without the use of air and also with the use of air under two pressures chosen at random. The pressure of air was kept constant by suitable valves and was recorded in inches of water. A creosote thus prepared was carefully analyzed, the values of the index of refraction of the fractions being taken as a guide for changes in chemical and physical properties. Figure 14 shows graphically the change produced in the index of refraction when the same tar was distilled without the use of air, with air under a pressure of 7 inches of water, and with the air under a pressure of 14 inches of water. It will be shown later that an increase in index of refraction is accompanied by an increase in specific gravity and a decrease in sulphonation residue.

### COMPARISON OF COMMERCIAL CREOSOTES WITH LABORATORY CREOSOTES.

Another point of still greater importance in this investigation was the determination of the differences, if there were any, which existed between creosotes produced from small samples (5 to 10 gallons) of tar in the laboratory and those obtained from the same tar under commercial conditions. Through the courtesy of the Barrett Manufacturing Co., of New York, and the United Gas Improvement Co., of Philadelphia, samples of tar were taken from their stills just before distillation and after thorough mixing. Samples of the creosote were then collected as it came from the still throughout the entire distillation. These samples were used as standard commercial creosotes with which the laboratory creosotes prepared from the same tar were compared.

The effect of blowing air through the tar being known, it was simply a matter of experiment to ascertain an air pressure that would

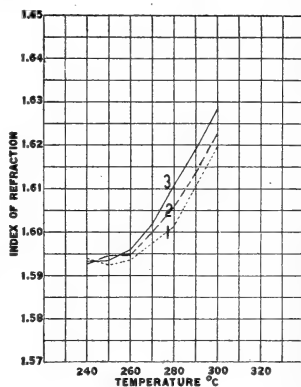

FIG. 14.—Effect of using air during the distillation of tar upon the index of refraction of the fractions of coal-tar creosote.

1. Coal-tar creosote from tar distilled without air.
2. Coal-tar creosote from the same tar distilled with air under 7 inches of water pressure.
3. Coal-tar creosote from the same tar using air under 14 inches of water pressure.

duplicate commercial conditions on a laboratory scale. It was found that air under a pressure of 7 inches completely fulfilled this condition with the still that was used, and that by using this air pressure the creosotes made at the laboratory agreed as closely as could be expected with commercial oils from the same tar. Figure 15 shows the indices of refraction, the specific gravities, and the sulphonation residues of two creosotes, one made at the laboratory and the other at a commercial plant from tar No. 1. Figure 16 shows the index of refraction values and the specific gravities of another pair of creosotes

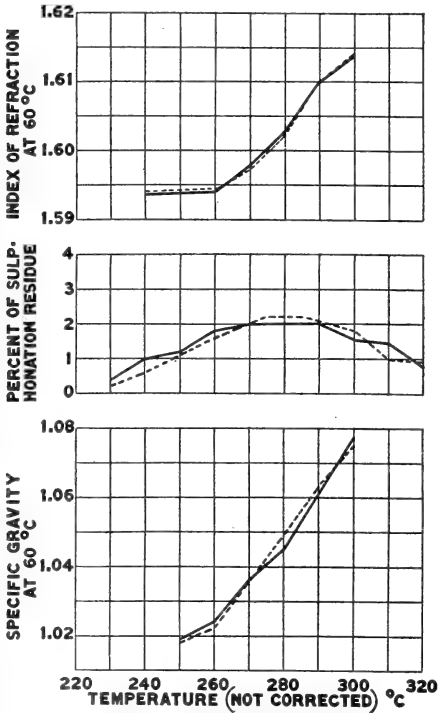

FIG. 15.—Physical constants of two coal-tar creosotes produced from tar No. 1.

Commercial coal-tar creosote—Dotted line.  
Experimental coal-tar creosote—Solid line.

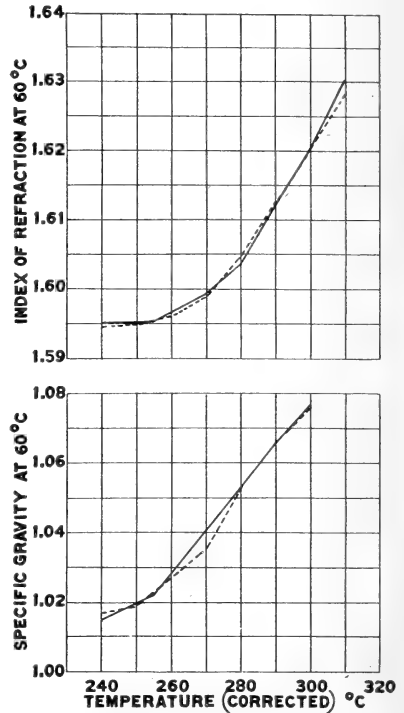

FIG. 16.—Physical constants of two coal-tar creosotes produced from tar No. 2.

Commercial coal-tar creosote—Dotted line.  
Experimental coal-tar creosote—Solid line.

produced from tar No. 2, and figure 17 shows the indices of refraction of two other pairs of creosotes made from tars No. 3 and 4, respectively. These figures show that creosotes can be produced from tars in the laboratory in such a way as to duplicate commercial conditions, and can be made as nearly identical as two analyses of the same oil.

In view of the fact, however, that not all tar distillers use air in their operation, it was decided that all work on authentic tars should



be carried out with the use of air under a pressure of 7 inches of water until all the moisture had been expelled from the tar. The rest of the distillation was completed without the use of air. The data thus obtained represent creosote oils that any manufacturer could obtain from the same tar. If there is any difference, the oils are lower in index of refraction and specific gravity, and higher in sulphonation residue than they would have been with the use of air. In other words, any specification that might result from this investigation would be on the safe side and would work no hardship on the manufacturer of creosote oil.

It was a somewhat difficult matter to cut the distillates from the tar in such a manner that an oil could be obtained having a distillation range similar to that of a commercial creosote. In practice, therefore, no attempt was made to separate the light oils from the creosote oils in the distillation from the tar still. The only separation made was the fraction containing the water and the more volatile of the light oils. The total distillate above this point was collected in one container and subsequently distilled from an ordinary flask. All oil coming over below  $205^{\circ}$  C. was discarded. That boiling from  $205^{\circ}$  to  $235^{\circ}$  C. was collected separately. The residue above  $235^{\circ}$  C. was weighed, and to this was added 25 per cent of its weight of the fraction boiling between  $205^{\circ}$  and  $235^{\circ}$  C. In this way the creosotes were made to conform to specification No. 1 of the American Railway Engineering Association so far as distillation limits were concerned.

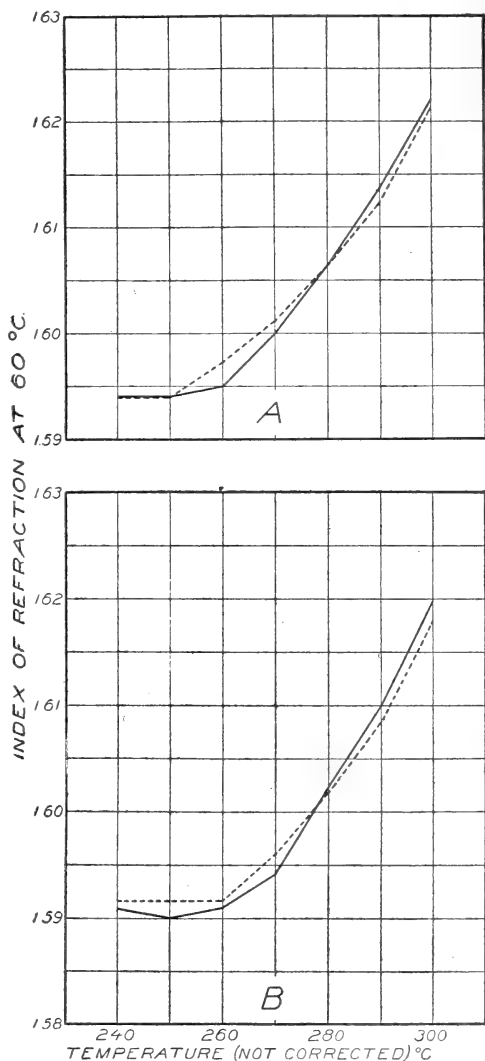

Fig. 17.—Index of refraction values of coal-tar creosotes produced from tars No. 3 and No. 4.

Commercial coal-tar creosotes—Dotted lines.  
Experimental coal-tar creosotes—Solid lines.

### CHAPTER III. RESULTS OF THE TESTS.

The results obtained by the various tests are given chiefly in the form of curves, which show graphically the similarity or dissimilarity of the creosotes examined. The data are given in tables in the Appendix.

#### COAL-TAR CREOSOTES.

Figures 18A, 19A, and 20A show the indices of refraction, the specific gravities, and the sulphonation residues, respectively, of the various fractions of creosotes obtained from horizontal retort tars. The data from which these curves are drawn are given in Tables 39, 40, 41, and 42. Particular attention is directed to the narrowness of the ranges of specific gravity, index of refraction, and sulphonation residue of these creosotes. Figures 18B, 19B, and 20B show the indices of refraction, the specific gravities, and sulphonation residue of the fractions obtained from inclined retort tars and from one vertical retort tar, the latter being plotted in a dotted line. Figures 18C, 19C, and 20C show the same curves for Semet-Solvay tar creosote, and figures 18D, 19D, and 20D show the curves for other by-product tar creosotes. In these figures the dotted lines are for Koppers tar creosote and the other lines are for Otto tar creosotes. Figure 21 shows summaries of the same results for each type of measurement. The 80° lines represent the range for coke-oven tar creosotes, the 45° lines represent the range of horizontal retort tar creosotes, and the 20° lines represent the range for the inclined retort and vertical retort tar creosotes.

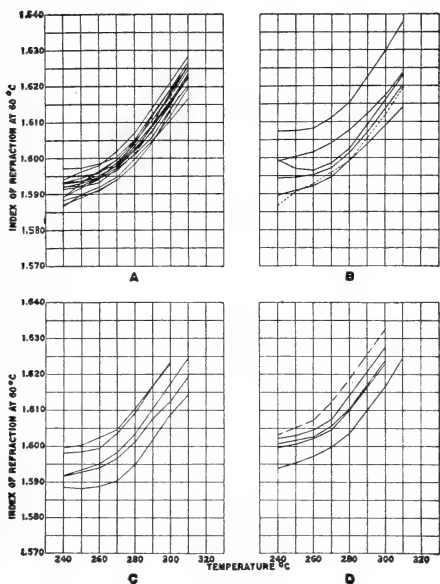

FIG. 18.—Index of refraction values of fractions of authentic coal-tar creosotes.

- A. Horizontal retort-tar creosotes.
- B. Inclined retort-tar creosotes. Dotted line vertical retort-tar creosote.
- C. Semet-Solvay tar creosotes.
- D. Otto-tar creosotes. Dotted line—Koppers-tar creosote.

In these figures the dotted lines are for Koppers tar creosote and the other lines are for Otto tar creosotes. Figure 21 shows summaries of the same results for each type of measurement. The 80° lines represent the range for coke-oven tar creosotes, the 45° lines represent the range of horizontal retort tar creosotes, and the 20° lines represent the range for the inclined retort and vertical retort tar creosotes.

Particular attention is called to figures 20A, 20B, 20C, and 20D, which represent the sulphonation residue of the various fractions. It will be noted that most of the maximum sulphonation residues are

obtained in the fractions boiling between 280° and 290° C., but sometimes not under 300° C. Above and below these points the sulphonation residues decrease. The results shown in these figures seem to indicate that the kind of coal from which the tar is manufactured

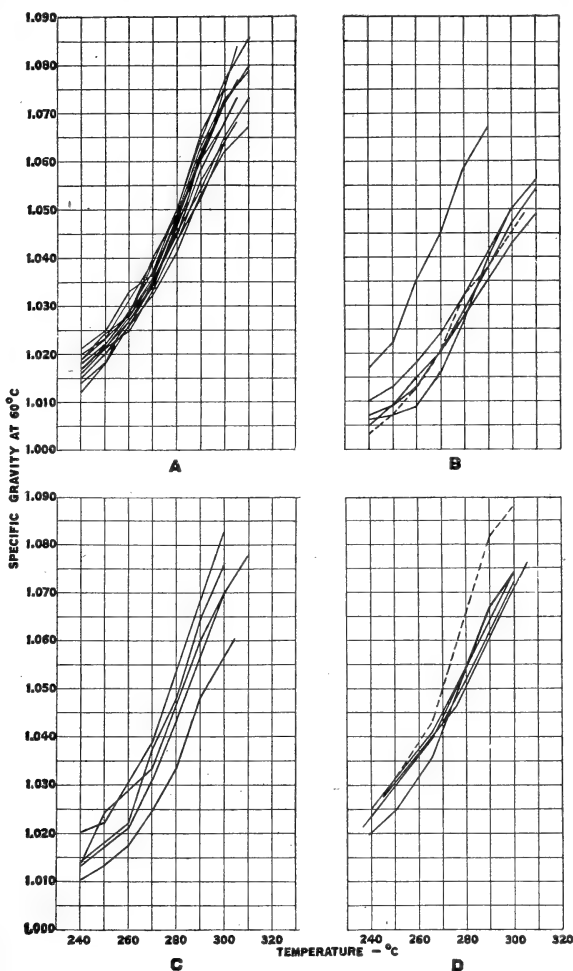

FIG. 19.—Specific gravities of fractions of authentic coal-tar creosotes.

- A. Horizontal-retort tar creosotes.
- B. Inclined-retort tar creosotes.  
Dotted line—Vertical-retort tar creosote.
- C. Semet-Solvay tar creosotes.
- D. Otto tar creosotes.  
Dotted line—Koppers tar creosote.

has at best only a slight influence on the quality of the creosote produced from coal tar, since in the range shown for horizontal retorts (figs. 18A, 19A, and 20A) Westmoreland, Youghiogheny, Alabama, and Tennessee coals were used, as well as mixtures of unknown or local coals with the above. The wide variation in the properties of coal-

tar creosotes indicated by figures 18 to 20 must, therefore, be due either to the type of retort or to the temperature of coking.

Figure 22 shows two coal-tar creosotes produced from tars from the same mixture of coal and operated under the same management, and as nearly as possible at the same temperature, although one tar was produced in an inclined retort and the other in a horizontal

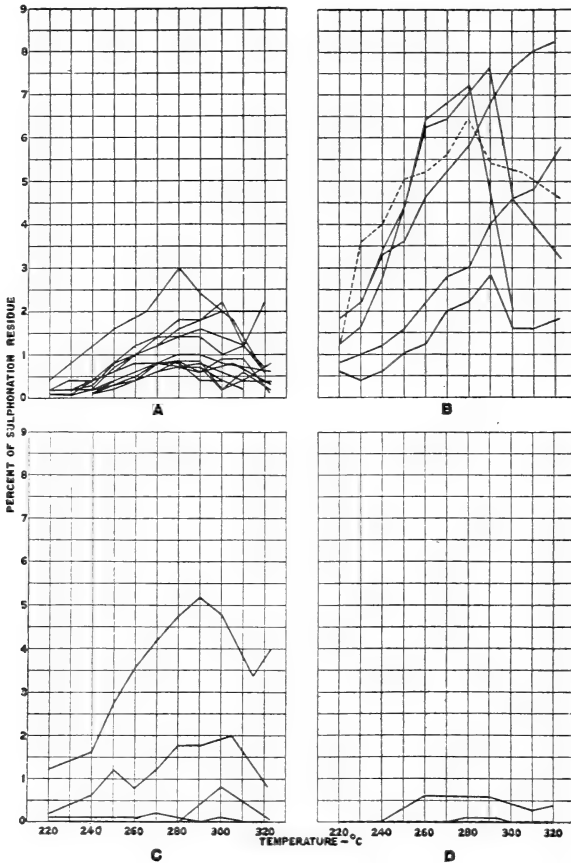

FIG. 20.—Sulphonation residues of fractions of authentic coal-tar creosotes.

- A. Horizontal-retort tar creosotes.
- B. Inclined-retort tar creosotes.
- Dotted line—Vertical-retort tar creosote.
- C. Semet-Solvay tar creosotes.
- D. Otto tar creosotes.
- Dotted line—Koppers tar creosotes.

retort. Figure 23 shows two coal-tar creosotes obtained from the same mixture of coal at different by-product plants which were at the time producing coke in approximately the same length of time, but which employ different types of oven—the Otto-Hoffman and the Semet-Solvay. These figures show the effect of different types of retort when the other two variables are practically the same. It is noted that the results are nearly identical, or, at least, that there

is less difference in the results from using different types of retort or oven than is often shown in the use of different ovens or retorts of the same type. In other words, if the coal and the temperature of coking are the same, the type of retort or oven seems to have little or no effect. This seems to indicate that the producing of highly aromatic coal-tar creosotes is dependent upon the temperature of coking. If this is true, then the method of applying the heat to the retort may have some effect upon the quality of the coal-tar creosote.

According to some researches at the University of Wisconsin (14) on producer gas, tar is formed from coals at comparatively low temperatures, ranging from 200° to 600° C. This is far below the

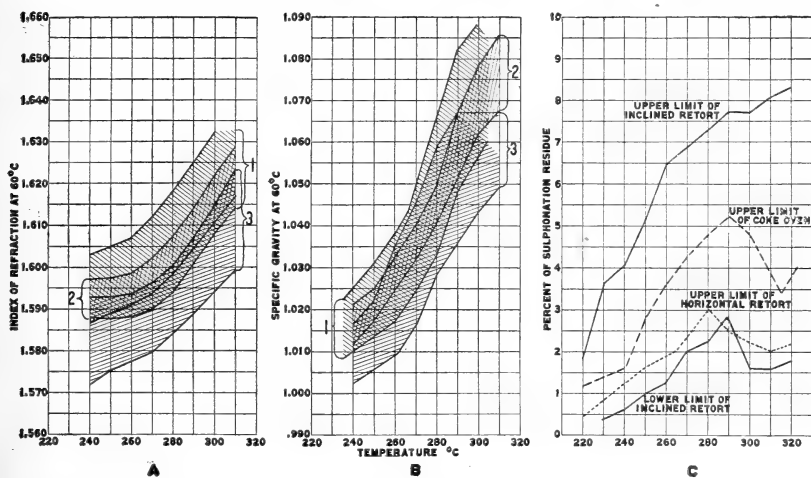

FIG. 21.—Summaries of the physical and chemical measurements of fractions of all authentic coal-tar creosotes.

- A. Index of refraction values.  
 B. Specific gravity values.  
 1. Horizontal-retort tar creosotes.  
 2. Coke-oven tar creosotes.  
 3. Inclined and vertical retort tar creosotes.  
 C. Sulphonation residues.

temperature of coking in both the by-product and gas-house retorts. Table 8 shows that the temperature of coking in the by-product oven rarely goes below 900° C. and that the average is about 1,000° C. If tars are produced at temperatures as low as 200° C. and are completely given off from the coal at 600° C., and if the retort is heated to a point as high as 1,000° C., the tar vapor, as it rises from the coal, must come into contact to a certain extent with a surface heated far above its temperature of formation, when it may, and probably does, undergo a chemical change. It is well known that paraffin-like oils may be obtained if coal is coked at low temperatures. It is also significant to note that in this work the tars produced at the highest temperatures yielded either no coal-tar creosotes at all or else one of

high physical properties and having no sulphonation residues; but that those subjected to lower temperatures yielded coal-tar creosotes having lower index of refraction values and higher sulphonation residues. The inclined-retort tar creosotes were higher in sulphonation residues, and it seems to be almost universally true that, when this type of retort is discharged, there is a small amount of uncoked coal in the charge. In the vertical retort there is less chance for the

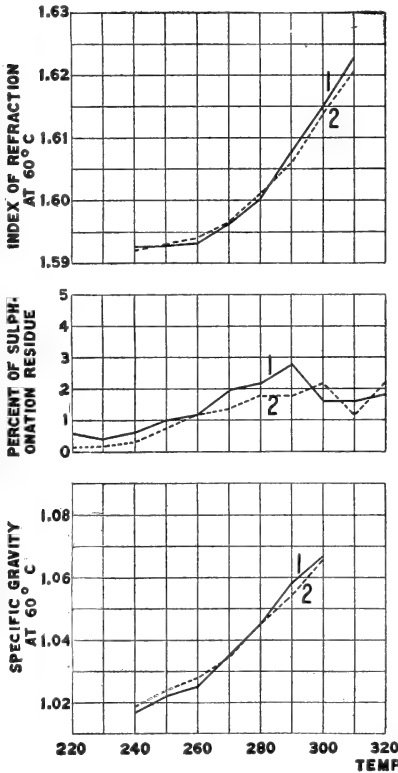

FIG. 22.—Physical and chemical constants of creosotes obtained from tar produced from the same mixture of coal at the same temperature but in different types of retort.  
1. Horizontal-retort tar creosote.  
2. Inclined-retort tar creosote.

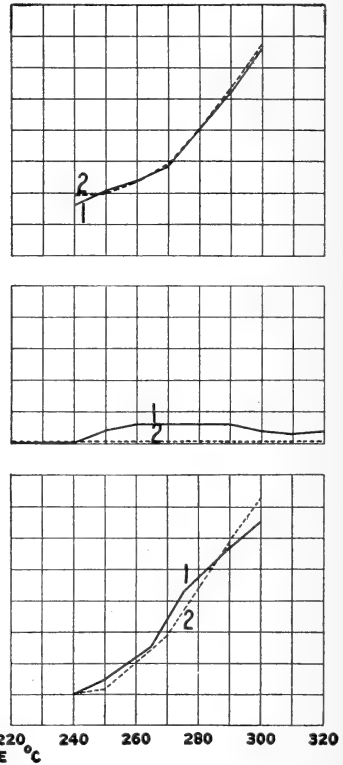

FIG. 23.—Physical and chemical constants of creosotes obtained from tar produced from the same mixture of coal at the same temperature but in different types of oven.  
1. Semet-Solvay tar creosote.  
2. Otto-Hoffman tar creosote.

gases to come in contact with the heated walls of the chamber unless a fixing chamber is left above the charge. In the by-product ovens the vertically heated ovens usually have a hotter roof than those heated horizontally. Of the six vertically heated by-product ovens only two produced coal-tar creosotes having a measurable amount of sulphonation residue. Of five coal-tar creosotes from horizontally heated ovens all but one had a measurable sulphonation residue. Of the four that had sulphonation residue the oldest plant produced the coal-tar creosotes having the highest sulphonation residue and the

next oldest the next greatest residue. Only one by-product tar creosote exceeded 2 per cent sulphonation residue in any of its fractions.

#### WATER-GAS-TAR CREOSOTES.

The data obtained on the water-gas-tar creosotes examined are shown in figure 24. In figure 24c attention is again directed toward the fractions from 260° to 300° C., the sulphonation residues being greater in general than in any other fractions obtained in distillation. This is the same as the indication on coal-tar creosotes. Very few data were obtained on the temperatures at which these tars were produced. It is, however, to be noted that the oils showing the highest indices of refraction, the highest specific gravities, and the lowest sulphonation residues were produced at the highest tem-

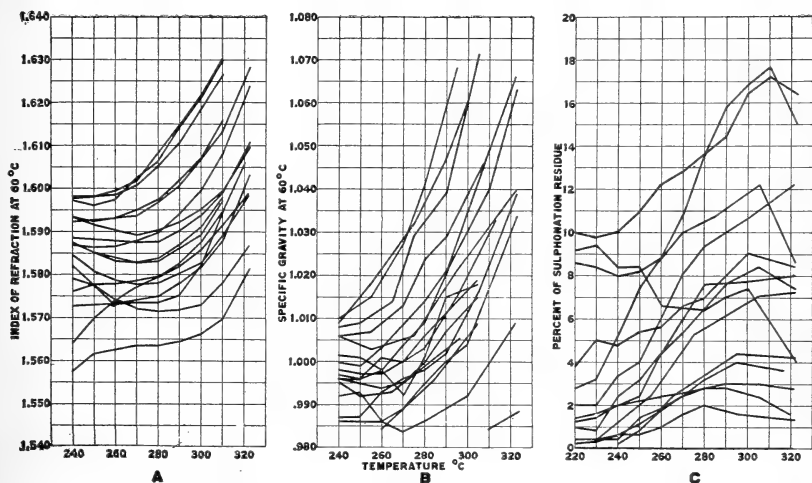

FIG. 24.—Physical and chemical measurements of fractions of all authentic water-gas tar creosote.

A. Index of refraction values.

B. Specific gravity values.

C. Sulphonation residues.

peratures, and in one or two instances the temperature is given at between 1300° and 1400° F., equivalent to 700° to 750° C.

Out of 19 water-gas tars 5, or approximately one-quarter, produced creosotes having 2 per cent or less of sulphonation residue. Eight produced creosotes having 5 per cent sulphonation residue. All of these tars were manufactured in plants that are using temperature regulation in the operation. In this age of scientific management a closer control of manufacturing operations may reasonably be expected, which will result in a probable increase in water-gas tar having a low sulphonation residue.

Statistics on the annual production of water-gas tar are given in Table 6. In 1912 the total production was nearly one-half of the total production of coal tar. The amount sold, however, was only one-quarter of the amount of coal tar sold.

## CHAPTER IV. COMPARISON OF THE PROPERTIES OF AUTHENTIC COAL-TAR CREOSOTES WITH THOSE OF AUTHENTIC WATER-GAS-TAR CREOSOTES.

The following curves show the similarities and dissimilarities of the physical properties of all coal-tar creosotes and all water-gas-tar creosotes tested. Figure 25A shows the index of refraction plotted against temperature, in which the lines sloping to the left represent water-gas-tar oils and the lines sloping to the right represent coal-tar

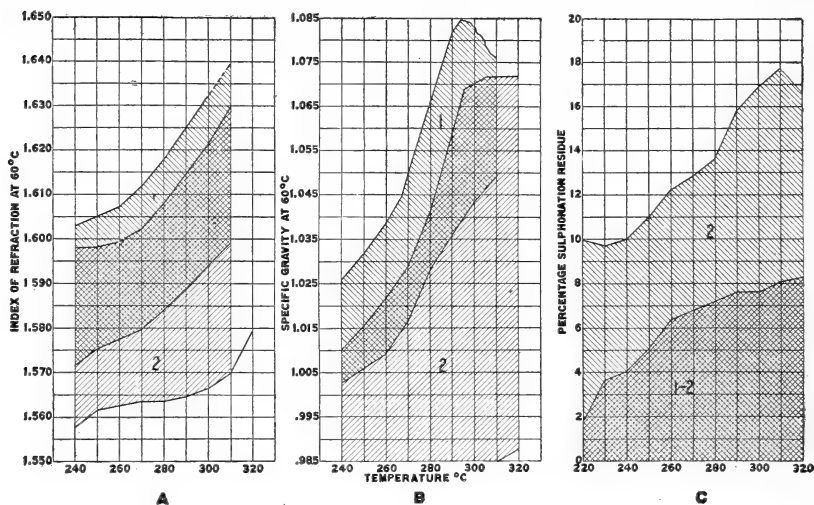

Fig. 25.—Comparison of the physical and chemical properties of the fractions of authentic coal-tar creosotes and authentic water-gas tar creosotes.

- A. Index of refraction values.
- B. Specific gravity values.
- C. Sulphonation values.
  1. Ranges of coal-tar creosotes.
  2. Ranges of water-gas tar creosotes.

creosotes. Figure 25B shows the same thing for specific gravity, and figure 25c represents the sulphonation residues (but the lines in this case are reversed). It is apparent from these curves that there is no sharp line of demarcation between the physical constants of coal-tar creosotes and of water-gas-tar creosotes. It is to be noted, however, that, whereas the larger number of coal-tar creosotes have a sulphonation residue of less than 3 per cent (see p. 20), the larger number of water-gas-tar creosotes have more than 3 per cent sulphonation residue in one or more of their fractions.

Figure 26 shows the index of refraction values of the fraction 285° to 295° C. taken from 17 coal-tar creosotes and 14 water-gas-tar creosotes, plotted against percentage of sulphonation residue for the



same fractions. The dots represent water-gas-tar creosotes, and the circles represent coal-tar creosotes. Here it is seen that, although in a general way the water-gas-tar creosotes are somewhat lower than the coal-tar creosotes, yet they intermingle to a degree so great that no differentiation could be obtained by this method. Furthermore, the figure indicates very strongly that the sulphonation residues and the index of refraction values are proportional to each other in some inverse ratio. In other words, index of refraction values could be obtained in a very general way by the sulphonation test.

Figures 27A, 27B, 27C, and 27D show the results of plotting specific gravity against index of refraction for the various fractions. Here the specific gravities of water-gas-tar creosotes are lower for the same index of refraction values than are those of the coal-tar creosotes, and there seems to be a somewhat definite line of demarcation between the two. However, the range of coal-tar creosotes and the range of water-gas-tar creosotes are each so much wider than the difference between the two ranges that mixtures of a high-grade water-gas-tar creosote and a high-grade coal-tar creosote would probably be classed as a coal-tar product, and mixtures of a low-grade coal-tar creosote and a low-grade water-gas-tar oil would probably be classed as a water-gas-tar product. In other words, although it is possible by this method to obtain figures showing a difference between pure water-gas-tar products and pure coal-tar products, it would be extremely difficult to say with any degree of authority that a given sample of oil was or was not a mixture of water-gas-tar and coal-tar products.

This method of plotting specific gravity against index of refraction for the individual fractions is the only one that has been found at the Forest Products Laboratory for differentiating water-gas-tar creosotes of low-sulphonation residues from coal-tar creosotes which can be recorded numerically. In addition to this, the odor of water-gas-tar products is characteristic. The recording of this odor, however, involves a large personal equation and is of value to the expert only. It is also well known that water-gas-tar products contain no tar acids or, at any rate, only a small amount, and practically no tar

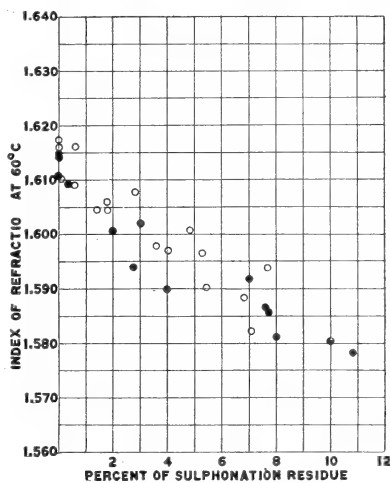

FIG. 26.—The relation between the index of refraction values and the amount of sulphonation residues of fractions of authentic creosotes.  
Circles—Coal-tar creosotes.  
Dots—Water-gas tar creosotes.

bases. These may easily be added to a water-gas-tar product at slight cost, however, and for this reason their presence is not proof positive that the creosote in which they are found is of coal-tar origin. It was supposed at one time that the color of the fractions was an

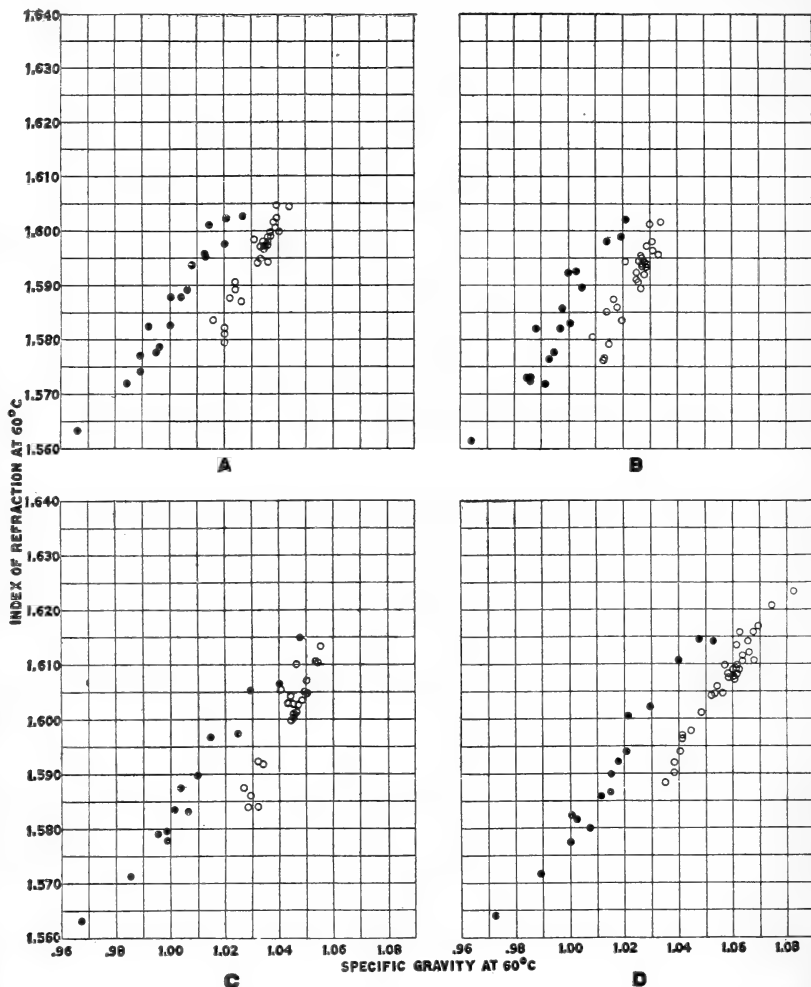

FIG. 27.—Relation between the index of refraction values and the specific gravity of the fractions of creosotes.

Circles—Coal-tar creosotes.

Dots—Water-gas-tar creosotes.

A. Fraction distilling between 255° and 265° C.

B. Fraction distilling between 265° and 275° C.

C. Fraction distilling between 275° and 285° C.

D. Fraction distilling between 285° and 295° C.

indication of a mixture of water-gas-tar oils with coal-tar creosotes. This investigation has shown that the supposed characteristic green color of certain of the fractions is common to all creosotes or oils having a high sulphonation residue, and that this color, therefore, does not indicate a mixture of the two kinds of oil.

## PART III. PROPERTIES OF CREOSOTES.

### CHAPTER I. COMPOSITION AND CHEMICAL PROPERTIES OF COAL-TAR CREOSOTE.

#### COMPOSITION OF COAL-TAR CREOSOTES.

The heavy oils of coal tar that are usually known to the trade as creosote oil and carbolineums are in general composed of compounds of the aromatic series and are usually somewhat complex in their chemical structure. The hydrocarbons, that is, those compounds containing only carbon and hydrogen, are represented by members of at least six subdivisions of the aromatic series.

The simplest of these is the benzene series, in which fall such compounds as benzene, toluene, and xylene. These are mainly low-boiling compounds—boiling below  $200^{\circ}$  C.—and are lighter than water, but, on account of the difficulty in separating these compounds from members of other series having higher boiling points, they may be found in the oils that are heavier than water.<sup>1</sup>

The next higher series is probably the indenenes. These also are low boiling, that is, they boil below  $200^{\circ}$  C., but in all probability they are found in coal-tar creosote.

The naphthalenes, of which naphthalene itself is the most important member so far as creosote oil is concerned, have boiling points between  $200^{\circ}$  and  $270^{\circ}$  C. when they are in the pure state. Some of this series are liquid at room temperature, but naphthalene, the parent of the series, is solid at ordinary temperatures, and, if it is pure, melts at  $80^{\circ}$  C. and boils at  $218^{\circ}$  C. Naphthalene may be present in almost any proportion in commercial oils. Samples of creosote, examined by the author, have contained as high as 75 per cent of oil boiling below  $225^{\circ}$  C., of which fully 75 per cent was naphthalene. On the other hand, oils such as the carbolineums contain practically no naphthalene. Acenaphthene might be termed a derivative of naphthalene. It has a somewhat higher boiling point, namely,  $275^{\circ}$  C. In the pure state this compound is a beautifully crystallized white material, melting at  $95^{\circ}$  C. It is characterized by its great solubility in hydrocarbon oils, especially those found in creosote; hence it rarely, if ever, crystallizes out from the mother liquor. Experiments at the Forest Products Laboratory seem to indicate that the golden yellow oil, which occurs above the naphtha-

<sup>1</sup> Huntley, in a master's thesis offered at the University of Wisconsin, has shown that oils boiling as low as  $137^{\circ}$  C. may be obtained from a supposedly high-boiling ( $295^{\circ}$  to  $320^{\circ}$  C.) fraction of coal-tar creosote. These oils, although small in amount, were in all probability a mixture of xylenes and other of the higher homologues.

lene fraction of creosote oil, is composed chiefly of this compound, mixed with sufficient quantities of other compounds to render it liquid at room temperature.

The highest fractions of creosote are composed chiefly of compounds of the fluorene and anthracene series. The compounds of these series boil from 270° C. to above 400° C. The members of these series that are found in the largest quantity in creosote oil are phenanthrene, anthracene, and fluorene. All of these will crystallize from the creosote oil on standing. The heavy solid matter crystallizing from foreign oils is a mixture of these three compounds with other hydrocarbons and bases. Anthracene is used to a considerable extent in the manufacture of dyes; some of the foreign creosotes may therefore have been robbed of this constituent.

Besides the hydrocarbons, which constitute by far the greater proportion of creosotes, there are a number of compounds containing oxygen which are collectively known as tar acids. These are not true acids in a chemical sense, but are phenols. They have some of the properties that are usually ascribed to acids, but also some of the properties that are characteristic of the alcohols. They are characterized by being extremely toxic to bacteria and fungi as well as to higher organisms. The higher homologues of phenol—the cresols and the xylenols—which are found in creosote, are as destructive as phenol to living organisms, if not more so. As the phenols, cresols, and xylenols may be considered the alcohols or tar acids of benzene, toluene, and xylene, so also in creosote are found compounds of an alcoholic nature known as naphthols, which are derived from the members of the naphthalene series. These, too, are used in medicine, as bactericides and antiseptics. At the present time the total amount of tar acids in creosote oil does not exceed 10 per cent and is usually less than 5 per cent.

Coal-tar creosotes contain also a number of compounds having nitrogen as one of their component parts. These are collectively known in this connection as tar bases. Just as it may be considered that the phenols are obtained from the hydrocarbons by the addition of an alcohol group, so it may be considered that one type of these tar bases is derived from the same hydrocarbons by the addition of an ammonia group. Aniline and the toluidenes are examples of this type of tar base derived from benzene and toluene, respectively. In general, however, this type of nitrogen compound is so low boiling that it is not found to any great extent in coal-tar creosotes. Another type of nitrogen compound contains this element in a much more stable condition. Compounds of this type may be termed cyclic nitrogen compounds, and are represented in coal-tar creosote by the pyridenes, the quinolines, and the acridines. These compounds bear the same relation to one another as benzene, naphthalene, and

anthracene do to one another. In general, the tar bases, particularly the cyclic compounds, are toxic to bacteria and fungi, and have been used as antiseptics in medicine. So far as the author is aware, no systematic tests have ever been made on the amount of tar bases which might be expected in coal-tar creosote. It probably does not, however, exceed the amount of phenols or tar acids.

In addition to the various hydrocarbons, tar acids, and tar bases, smaller amounts of compounds containing sulphur have been found in coal tar. According to Lunge (10), the following sulphur compounds have been found in coal tar, and in all probability are present in the creosote oil: thioxene, trimethylthiophene, tetramethylthiophene, biophene, dithienyl, trithienyl, thionaphthene, thiophthene.

#### CHEMICAL PROPERTIES OF COAL-TAR CREOSOTES.

A comprehensive treatment of the chemical properties of the individual compounds found in creosote is outside the scope of this work, and reference is made for this information to the various textbooks on advanced organic chemistry. A few remarks, however, on the general reactions of creosote oil are desirable. In general, the reactions of the various reagents which may be applied to creosote oil are those expected of the aromatic hydrocarbons. Practically all of the hydrocarbons in coal-tar creosote have the capacity of forming beautifully crystallized addition compounds with picric acid. All the aromatic hydrocarbons are attacked by fuming sulphuric acid, and some of them by ordinary sulphuric acid with the consequent production of sulphonic acids, which are soluble in water. The tar acids are characterized by their solubility in caustic soda, in which they form sodium salts that are more soluble in water than in oil. The phenols themselves can be reprecipitated from the aqueous solution of the sodium salt by the addition of an acid, carbon dioxide being sufficiently strong to accomplish this result. The tar bases, as a rule, form addition products with the mineral acids at ordinary temperatures, and these addition products are soluble in water. These bases are also characterized in general by the formation of insoluble compounds with the noble metals and with mercury.

## CHAPTER II. PHYSICAL PROPERTIES OF COAL-TAR CREOSOTES.

### SOLUBILITY.

The solubility of creosote in some solvents may be considered as a physical property; in other solvents a chemical reaction is involved. Usually, coal-tar creosote is completely soluble in chloroform, carbon tetrachloride, carbon bisulphide, ether, and absolute alcohol, although the individual constituents that go to make up the creosotes are frequently not soluble in some of these solvents. The influence of soluble constituents in increasing the solubility of those that usually are not soluble in the oil is well known to chemists. As an instance of this, it may be cited that, in the purification of anthracene from a mixture of phenanthrene and anthracene, the original material is quite soluble in warm 95 per cent alcohol. On cooling, a considerable amount of very impure anthracene crystallizes. A greater amount of alcohol is now required to dissolve this anthracene than was required to dissolve the original material, although it has been reduced to a smaller amount. Each time the crystallization is effected, the material becomes somewhat purer, and finally the anthracene is scarcely soluble in absolute alcohol. All aromatic hydrocarbons are soluble in dimethyl sulphate, but the aliphatic hydrocarbons are not soluble in it. As a rule, therefore, coal-tar creosote is completely soluble in this reagent; but, if paraffin compounds are present, it can not be expected that they would be separated quantitatively by the use of this solvent alone.

### COLOR AND ODOR.

The color of coal-tar creosote is usually a deep yellow to a dark brown, depending somewhat upon its age. When first distilled, it is a clear yellow oil with a greenish cast, which rapidly changes to brown on contact with the air. The odor is rather difficult to describe. If naphthalene is present in considerable quantities, this odor predominates, but in general the odor can be described only as "tarry."

### FLASH AND BURNING POINTS.

It is usual in stating the physical properties of oils to give some idea of their flash and burning points. The composition of creosote oil varies so greatly, however, that the determination of the flash and burning points is of very little value. One might place the flash point at not less than 70° or 75° C., and the oil may be expected to flash at 80° C. under almost any conditions. The burning point is between 90° and 100° C.

## VAPOR PRESSURE.

In the course of some experimental runs made by the Forest Service in a wood-preserving plant of light design, an explosion occurred which resulted in the rupture of the cylinder. It was thought at the time that, if the vapor pressure of the creosote oil were found to be sufficiently great, it might be an important factor in determining the design of treating plants. Experiments were therefore made to ascertain this vapor pressure at least approximately. Table 15 shows the average results obtained in experiments with two creosotes of different characteristics.

TABLE 15.—*Vapor pressure of coal-tar creosotes.*

Temperature (degrees C.).	Vapor pressure.		Temperature (degrees C.).	Vapor pressure.	
	Inches of mercury.	Pounds per sq. in.		Inches of mercury.	Pounds per sq. in.
50	2.0	1.0	110	7.4	3.7
60	2.8	1.4	120	8.2	4.1
70	3.6	1.8	130	9.0	4.5
80	4.6	2.3	140	9.8	4.9
90	5.6	2.8	150	10.6	5.3
100	6.4	3.2			

This vapor pressure is not sufficient to do any material harm, since it is always less than the atmospheric pressures at ordinary temperatures and elevations. If, however, the creosote contains water, the vapor pressure under this condition will be the sum of the vapor pressures of creosote and water. The vapor pressure of the mixture will be as shown in Table 16 if the vapor pressure of creosote, as given above, is used:

TABLE 16.—*Vapor pressure of mixtures of coal-tar creosote and water.*

Temperature (degrees C.).	Vapor pressure.		Temperature (degrees C.).	Vapor pressure.	
	Inches of mercury.	Pounds per sq. in.		Inches of mercury.	Pounds per sq. in.
40	3.0	1.5	80	18.6	9.3
50	3.5	2.7	90	26.2	13.1
60	8.6	4.3	100	36.4	18.2
70	12.8	6.4			

In this case, even at 100° C., the vapor pressure in excess of atmospheric pressure (15 pounds a square inch) is only 3.2 pounds a square inch, which is a pressure so small that it need not be taken into consideration in designing treating plants.

## SPECIFIC HEAT.

It is frequently desirable to know the specific heat of creosote in order that allowance may be made for sufficient coils to heat the

tanks and cylinders in an economical manner. The average specific heat over a range from 15° to 90° C. has been roughly determined in the Forest Products Laboratory. The results given in Table 17 are not absolute specific-heat data, but include also the latent heat of fusion if the creosote is solid at room temperature. They are, therefore, somewhat greater than true specific-heat values. The specific heat of nine creosotes are shown in Table 17.

TABLE 17.—*Specific heat of coal-tar creosotes.*

Creosote No.	Specific heat.	Creosote No.	Specific heat.
614	0.337	679	0.373
636	.353	680	.349
638	.332	687	1.443
641	.323	740	.307
677	.339		

<sup>7</sup> This creosote contained large quantities of naphthalene. It was practically solid at room temperature. The figure is high because of latent heat of fusion.

The specific heat of creosotes may therefore be assumed to range between 0.30 and 0.45. If water is added, the mixture has a higher specific heat than creosote oil, and the rise in specific heat is in direct proportion to the amount of water present. Therefore, if treating plants are designed to handle aqueous solutions, ample provision will be made for the heating of creosotes.

#### SPECIFIC GRAVITY.

The specific gravity of a material is a physical property that is easily measured. Because of this fact, it is used to a large extent in industry to determine such factors as the strength of solution or the quality of oil.

The specific gravity of straight distilled coal-tar creosotes may vary from 1.01 to 1.08 or more. The usual temperature at which specific-gravity determinations are made is 38° C. and referred to water at 15° C. Practically the same result is obtained if the determination is made at 60° C. and referred to water at 60° C.

It is sometimes convenient to measure the specific gravity at some temperature other than the ones shown above. The change in specific gravity with change in temperature is 0.00077 per degree centigrade, or 0.00043 per degree Fahrenheit. This correction factor may be added to the determined value if the temperature is above the standard, or subtracted if it is below.

#### COEFFICIENT OF EXPANSION.

The factor usually termed the coefficient of expansion is the amount of change per unit volume if an oil is heated through 1 degree. This factor changes with the temperature and also with the different



gravities of oils, and at best the coefficient of expansion can be only a rough average of the various coefficients of expansion at different temperatures for different oils. In practice, it is usual to say that the change in volume is 1 per cent of the original volume for every 22.5° F. of temperature change. This factor is approximately accurate and is based on the fact that creosote oil changes its specific gravity roughly 0.0008 per degree centigrade, or 0.00044 per degree Fahrenheit. For commercial work over a short range of temperature, this factor is probably sufficiently accurate; but for refined work, such as the experimental determination of absorption of creosote by wood, the figure of the next decimal place should be known. Some work at the Forest Products Laboratory shows that the figure derived from the change of gravity per degree centigrade lies between 0.00077 and 0.00078, and between 0.000428 and 0.000433, with an average of 0.000430 per degree Fahrenheit. This work also shows that the actual change in gravity is independent of the initial gravity, provided the initial gravity at 10° C. is between 1.01 and 1.05; therefore a change in volume is dependent upon the initial gravity of the oil; that is, an oil with a specific gravity of 1.01, when heated through 100° F., will not have the same increase in volume as will an oil of 1.05 specific gravity heated through the same temperature difference. The volume, however, may be calculated by the use of the formula

$$V' = \frac{GV}{G - (T - T') 0.00077}$$

where  $T$  and  $T'$  are temperatures in degrees centigrade; or by the use of the formula

$$V' = \frac{GV}{G - (T - T') 0.00043}$$

where  $T$  and  $T'$  are the temperatures in degrees Fahrenheit. In these formulæ,  $V'$  is the volume at the temperature  $T'$ ,  $V$  is the volume at temperature  $T$ , and  $G$  is the specific gravity at temperature  $T$ .

#### VISCOSITY.

Viscosity is a measure of the inner friction of liquids, that is, the friction produced by the liquid moving on itself. There are no instruments in commercial practice that measure this property directly. Most commercial viscosimeters are so constructed that the rate of flow of the liquid through an orifice of definite diameter under a definite head may be accurately measured. This does not give true viscosity, but does give an empirical measure of that property. Nearly all instruments are standardized by water at a fixed temperature. The efflux time in seconds of the liquid under examination divided by the efflux time of water at the standard temperature, is

sometimes known as "relative viscosity" or "specific viscosity," but more correctly as "Engler number" or "Saybolt number," as the case may be. Although there are a large number of viscosimeters on the market, no two makes will give exactly the same result because of the fact that these instruments work under a different head of liquid and have slightly different sizes of orifice. Results obtained by one make of instrument are, therefore, not directly comparable numerically with those obtained by another make. For that reason it is necessary to give the name of the instrument when viscosity readings are published. The instrument which seems to be

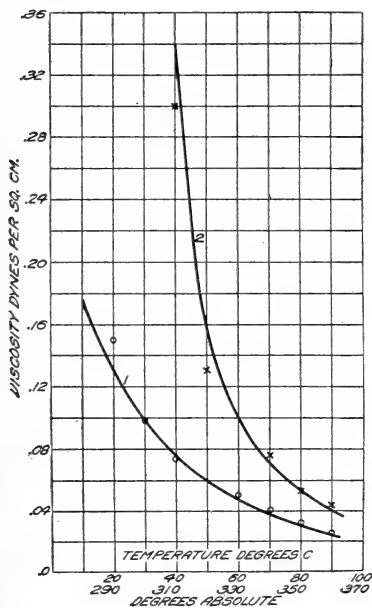

FIG. 28.—The change in viscosity of coal-tar distillates with change in temperature.

1. A high-boiling creosote.
2. A carbolineum.

in most general use in this country for measuring the viscosity of oils is that known as the Engler viscosimeter. The efflux time of water at 20° C., the standard temperature, is generally between 50 to 51 seconds. The Engler viscosimeter used at the Forest Products Laboratory has an efflux time of 50.8 seconds with water at 20° C. Tables have (15), however, been worked out by which results obtained in the Saybolt, Engler, and Redwood viscosimeters may now be converted to absolute viscosities, and hence from the readings of one instrument to those of another.

The viscosity of coal-tar creosote varies somewhat with the percentage of the higher-boiling constituents present. Those which have a large proportion of the higher-boiling oils are, of course, more viscous than those having a small percentage of these oils. The extremes are represented by low-boiling creosotes on the one hand and by carbolineums on the other. The viscosities of creosote as well as of all other oils vary also with the temperature. In general, the higher the temperature the less the viscosity. This is not, however, a straight-line relation. Figure 28 shows the change in absolute viscosity with the change in temperature for an average coal-tar creosote and for a carbolineum.

The change in viscosity of creosote or carbolineums may be calculated from two or three determinations at different temperatures by the use of the formula  $V = \frac{K}{T^A}$ , where  $V$  is the absolute viscosity

in dynes per square centimeter,  $T$  the absolute temperature in degrees centigrade and  $K$  and  $A$  constants for the oil. When the viscosity is determined at the two temperatures,  $T_1$  and  $T_2$ , then

$$\frac{V_1}{V_2} = \frac{T_2^A}{T_1^A} \text{ or } \frac{\log V_1 - \log V_2}{\log T_2 - \log T_1} = A$$

substitute the value of  $A$  in the first equation and solve for  $K$ . The equation thus obtained will give the values of  $V$  at any temperature, providing the original determinations were accurate. The equations for the two curves shown in figure 28 are  $V = \frac{6.54(10)^{18}}{T^8}$  for the creosote and  $V = \frac{5.31(10)^{30}}{T^{12.63}}$  for the carbolineum.

The viscosity of oil is supposed to have an effect on its penetrance into wood, and it seems reasonable to suppose that a limpid fluid would be easier to inject than a more viscous one. Weiss (16) stated that penetrance is some inverse function of the viscosity. Bond (17) showed that, in the different mixtures of creosote and carbon-free tars tested, there was no apparent relation between the viscosities of the creosotes and the penetration obtained. He also showed that the same thing was true when mixtures of normal tar and creosote were used.

Later, Teesdale and MacLean (18) stated that there was no apparent relation between the viscosity and the penetrance of the tar mixtures used. Their statements are, however, based on the viscosity as determined by the Engler viscosimeter. Since then their data have been recalculated to absolute viscosity and show that a very definite relation exists between absolute viscosity and penetrance, and that this relationship is capable of mathematical treatment. However, the data are not as yet sufficiently extensive to show the relationship of other variables which enter into the penetrance.

Figures 29 and 30 show the relationship between longitudinal penetration and absolute viscosity of various oils, including creosote oils, tar mixtures, tars, and asphaltic oils into noble fir and long-leaf pine. The equations given in the figures are of value only when the other conditions used in the test are held constant. Other factors which may influence the penetration are the time of treatment, the pressure used, and the moisture content in the wood. In all probability a full equation should read  $M, P, T, XY = K_2$ , where  $M$  is some function of the moisture content,  $P$  some function of the pressure used in treatment,  $T$  some function of the time of pressure,  $Y$  the absolute viscosity,  $X$  the longitudinal penetration, and  $K_2$  a constant. In these experiments the moisture content, pressure of treat-

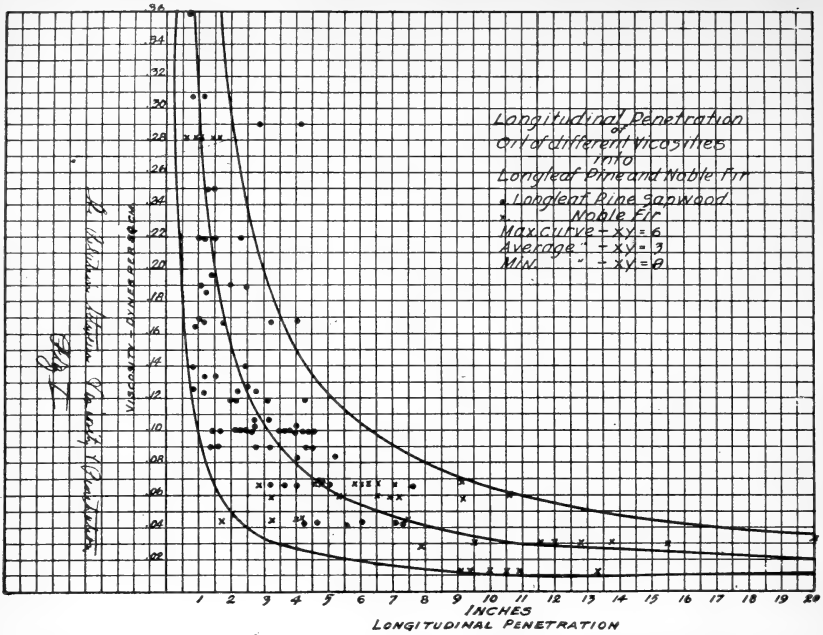

FIG. 29.—Longitudinal penetration of oil of different viscosities into longleaf pine and noble fir.

°—Longleaf pine sapwood.  
 \*—Noble fir.

Max. curve— $xy=6$ .  
 Average curve— $xy=3$ .  
 Min. curve— $xy=8$ .

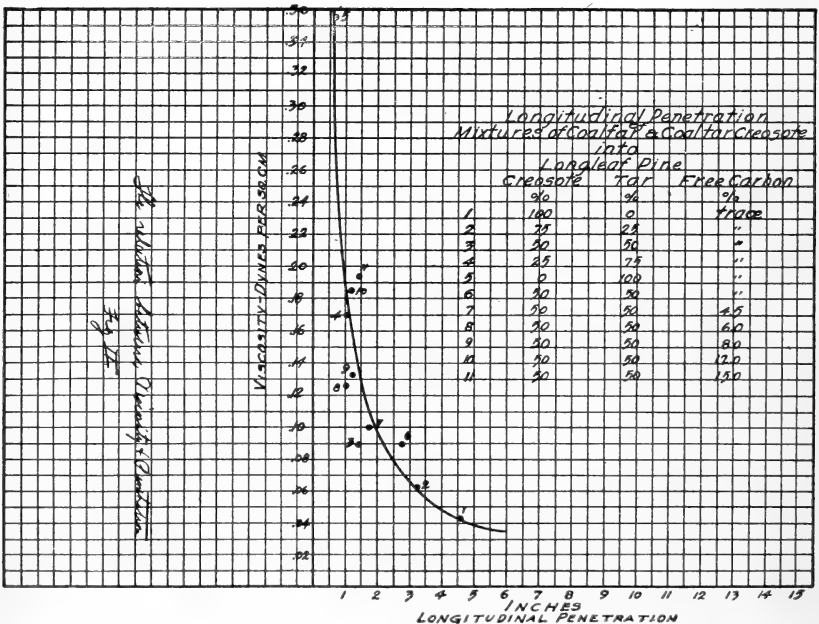

FIG. 30.—Longitudinal penetration. Mixtures of coal tar and coal tar creosote into longleaf pine.

ment, and time of treatment were held constant. The equation is simplified by dividing through by these numbers, but it must not be lost sight of that they belong in the equation, and that the equation  $XY = K$  holds only when  $M$ ,  $P$ , and  $T$  are constant.

#### VOLATILITY.

There is, perhaps, no physical property of coal-tar creosote that is of greater interest to the wood-preserving industry as a whole than its volatility, because the permanence of the treatment is largely dependent upon the volatility of the creosote. Alleman (19), Von Schrenk (20), Bateman (21), Ridgway (22), Rhodes and Hosford (23), and Mattos (57) in this country have shown that the oils present in piling, ties, and poles, after long use, have contained large amounts of the higher-boiling fractions of creosote. The loss was restricted chiefly to that portion of the creosote which distilled below 245° C., although there was also an appreciable loss in the portion distilling between 245° C. and 270° C. Above 270° C., however, the oil seemed to be fairly permanent. It has been shown by the Forest Products Laboratory that, if the assumption is made that there is no loss above 270° C., then the loss by evaporation may be calculated from an analysis of the original creosote and of the creosote extracted from wood that had been in service a long time. The correctness of this assumption is shown by the fact that calculations made from analyses of oil before and after use in open-tank treatment showed a loss of 41 per cent. A record of the amount of creosote in the timber after treatment and the amount used during treatment showed that there had been at least 38 per cent of loss, or practically the same figure as calculated from the analyses.

Instead of the residue about 270° C., some investigators had used the pitch residue, that is, the residue above 315° C. Although it is probable that, if the oils boiling above 270° C. are practically nonvolatile, then the pitch residues should possess this property to an even greater degree, yet, on account of the size of the fraction, calculations based on the pitch residue are more liable to error than those based on the residue above 270° C. This is because there is about the same accuracy in determining the pitch residue by weight as there is in determining the residue above 270° C. As the latter fraction is usually two and sometimes three or four times as great as the former, an error in determining the residue above 270° C. is only half as great on a percentage basis as would be the same error in determining the amount of pitch. This is shown very well by the following calculations. Creosote was allowed to evaporate in a pan and its loss was accurately determined. The analysis of this creosote before and after evaporation is given in Table 18.

TABLE 18.—*Distillation of oil before and after evaporation.*

Temperature (degrees C.).	Creosote before evapo- ration.	Creosote after evapo- ration.
	<i>Per cent.</i>	<i>Per cent.</i>
Up to 210..	2.2	0.2
210 to 235...	23.3	0.8
235 to 270...	24.1	14.1
270 to 315...	17.5	32.0
315 to 355...	17.1	27.3
Residue....	17.5	25.6

The actual loss produced by evaporation was 41.5 per cent. The loss calculated from the pitch residue was 43.2 per cent. The loss calculated from the residue above 270° C. was 41.1 per cent. By the pitch-residue method, the maximum difference is 1.7 per cent, and the maximum difference by residue above 270° C. is 0.4 per cent. As the data used in both cases were the same, these differences are due to the method of calculation rather than to any error in analysis.

In most cases it is impossible to obtain records of any kind that will show the composition of the creosote used in the treatment of old timbers. Two such records are furnished by the pole lines of the American Telephone & Telegraph Co. This company has a number of analyses of the original oils used, from which a fair average may be obtained. One line, the Washington-Norfolk line, was erected in 1897; the other, the Montgomery-New Orleans line, was erected in 1899. Five poles in the Washington-Norfolk line were removed in 1906 and one in 1908 for analysis. One pole from the Montgomery-New Orleans line was removed in 1908 for analysis.

The analysis of the creosote before treatment was obtained from the American Telephone & Telegraph Co., which makes the following report:

The original reports of the analysis are in our files and from which we have prepared the following table as indicating the average of the oil used in the treatment of the poles for that line. It is, of course, impossible to associate the poles under test with any particular analysis of oil.

TABLE 19.—*Average of tests of dead oil of coal tar used in treating poles.*

DISTILLATES.		Per cent.
Loss, water, etc., 170° C.....		1
170° to 205°.....		2
205° to 210°.....		4
210° to 235°.....		45
235° to 240°.....		7
240° to 270°.....		16
270° to 316°.....		9
Residue above 316°.....		16

100

Twenty-eight analyses were available for the above average.

For the distillate between 205° and 235° C.,

	Per cent.
19 analyses averaged about.....	45
3 analyses averaged between.....	50 and 55
2 analyses averaged between.....	55 and 60
4 analyses averaged between.....	60 and 65

The analyses of the creosotes extracted from five of the poles from the Washington-Norfolk line were published by Von Schrenk, Fulks, and Krammerer (20). Later, Rhodes and Hosford (23) published independent analyses of the creosotes from the same poles and, in addition, of one other creosote from the same line and of one from the Montgomery-New Orleans line. The records of both series of investigations are given in table 20.

TABLE 20.—Analyses of creosotes extracted from telephone poles.

Pole No. and fraction.	Top.		Butt.	
	V. S., F., and K., per cent.	Rhodes and Hosford, per cent.	V. S., F., and K., per cent.	Rhodes and Hosford, per cent.
Pole No. 10749.				
Below 210° C.....	0.0	1.8	0.0	2.3
210° to 235° C.....	6.7	6.5	37.4	42.5
235° to 270° C.....	31.0	23.9	26.9	22.5
270° to 315° C.....	21.3		14.2	
Residue.....	41.0	67.8	20.4	32.7
Pole No. 1425.				
Below 210° C.....	8.6	7.9	0.0	1.9
210° to 235° C.....	29.7	32.0	45.0	39.6
235° to 270° C.....		19.4	23.0	23.7
270° to 315° C.....	32.1		11.3	
Residue.....	29.6	40.7	16.1	34.8
Pole No. 9709.				
Below 210° C.....	0.0	3.1	0.0	2.4
210° to 235° C.....	1.0	6.7	12.9	15.6
235° to 270° C.....	8.2	18.2	25.7	24.8
270° to 315° C.....	32.2		18.9	
Residue.....	58.6	71.9	42.5	57.2
Pole No. 29.				
Below 210° C.....	0.0	3.2	1.0	0.5
210° to 235° C.....	40.7	21.4	47.1	44.3
235° to 270° C.....	19.0	24.2	19.2	25.7
270° to 315° C.....	11.5		12.9	
Residue.....	28.8	51.2	19.4	29.5
Pole No. 2931.				
Below 210° C.....	0.0	1.7	0.0	2.3
210° to 235° C.....	31.7	22.4	40.6	35.8
235° to 270° C.....	20.4	14.1	22.3	16.4
270° to 315° C.....	7.7		12.0	
Residue.....	39.9	61.8	24.7	45.5

Fraction.	Rhodes and Hosford, pole 5348.			Rhodes and Hosford, pole 10272.		
	Top.	Above ground line, per cent.	Below ground line, per cent.	Top.	Above ground line, per cent.	Below ground line, per cent.
Below 210° C.....	1.9	1.2	2.1	0.6	0.3	4.0
210° to 235° C.....	4.0	4.4	14.4	.7	.7	9.4
235° to 270° C.....	6.6	21.5	29.9	2.9	3.1	21.6
Residue.....	87.5	72.9	54.6	95.8	95.9	65.0

Messrs. Von Schrenk, Fulks, and Kammerer, using the pitch residue of the average creosote before treatment and the pitch residue of the individual creosotes after treatment, estimate the loss by volatilization to be as shown in Table 21.

TABLE 21.—*Loss of creosote by volatilization from telegraph poles.*

Pole No.	Section of pole.	Loss, per cent.	Pole No.	Section of pole.	Loss, per cent.
10, 749	Top.	59.0	1, 425	Butt.	2.7
10, 749	Butt.	20.8	2, 931	Top.	58.0
29	Top.	42.4	2, 931	Butt.	32.8
29	Butt.	16.4	9, 709	Top.	70.8
1, 425	Top.	43.3	9, 709	Butt.	60.3

The same investigators analyzed the oils extracted from the north and south sides of two poles; but, on account of lack of concordance in results, they could not state definitely whether there was any difference in evaporation corresponding to the difference in these two points of the compass. They also made a few analyses to determine the difference in evaporation near the surface and in the interior of the treated portions. Their results show a slight but gradual increase in the volatility of the creosote extracted from the center over that obtained from the outer portions; but the investigators state that more analyses should be made.

Even an average analysis of the creosote is not usually available. If, therefore, it is desired to determine the loss by volatilization, another assumption must be made. Much of the treated wood examined after long service is piling. In a pile there are three different parts that represent three different conditions of exposure—first, that part of the pile exposed to the air, or the air section; second, that part of the pile that is in the water, or the water section; and, third, the point of the pile, which is in the mud, or the mud section. The mud section is less likely to change than either of the other two, since the loss by evaporation and the loss by solution are both nearly negligible. The assumption that there is no appreciable loss of the creosote in the point seems, therefore, to be justifiable; at any rate, the figures obtained by using this assumption would be less instead of greater than the actual loss, even if the assumption is liable to be considerably in error. Basing calculations on these two assumptions, namely, that the fractions above 270° C. do not disappear appreciably, and that the creosote in the point is the same as the original creosote, the calculations shown in Tables 22 and 23 have been made to show the losses occurring from piling that has been in service for different lengths of time under different conditions.



TABLE 22.—Analyses and calculated losses of creosote from treated piling.

Length of service, years.	Character of oils.						Loss.				Observer.
	In point.		Below water line.		Above water line.		Below water line.		Above water line.		
	Up to 245° C.	Up to 270° C.	Up to 245° C.	Up to 270° C.	Up to 245° C.	Up to 270° C.	Total.	Average.	Total.	Average.	
	<i>P. ct.</i>	<i>P. ct.</i>	<i>P. ct.</i>	<i>P. ct.</i>	<i>P. ct.</i>	<i>P. ct.</i>	<i>P. ct.</i>	<i>P. ct.</i>	<i>P. ct.</i>	<i>P. ct.</i>	
38.....	37.8	52.2	23.3	41.9	20.4	31.7	17.0	0.42	30.0	0.79	Ridgway (22).
38.....	39.5	51.9			16.8	29.8			31.4	.83	Do.
20.....	59.9	69.6	59.8	69.3	57.7	65.9	1.0	.05	11.0	.54	Do.
20.....	61.1	70.9	52.7	63.5	48.4	58.5	20.0	1.0	30.0	1.5	Do.
20.....	60.4	68.5	49.9	58.7			23.7	1.2			Do.
30.....	41.8	48.2	33.3	40.4	10.2	30.5	13.0	.4	26.0	.8	Bateman (21).
30.....	9.4	21.5		4.6	5.8	11.6	17.7	.6	10.0	.3	Do.
	Up to 235° C.	Up to 270° C.	Up to 235° C.	Up to 270° C.	Up to 235° C.	Up to 270° C.					
29.....	42.0	53.2	54.0	73.4	33.3	58.9					Mattos (57).
29.....	7.6	32.3	4.1	20.5	5.2	20.5					Do.
22.....	6.9	28.6	1.8	24.0		14.9					Do.
20.....	16.1	38.5	4.1	28.8	1.2	9.2					Do.
18.....	11.5	41.6	15.2	46.1	15.4	40.1					Do.

TABLE 23.—Analyses of creosotes extracted from old timbers after various lengths of service.

Sample.	Service.	Creosote per cubic foot.	Distillation of extracted oil.							Tar acids.	
			To 205°.	205° to 245°.	245° to 270°.	270° to 320°.	320° to 420°.	Residue above 420°.	Total.		
	<i>Yrs.</i>	<i>Lbs.</i>	<i>Per ct.</i>	<i>Per ct.</i>	<i>Per ct.</i>	<i>Per ct.</i>	<i>Per ct.</i>	<i>Per ct.</i>	<i>Per ct.</i>	<i>Per ct.</i>	<i>Cm(5.)</i>
Tie No. 106.....	16	4.06		16.32	13.24	20.15	24.10	25.93	99.74		0.51
Tie No. 104.....	18	9.24		9.37	18.17	27.54	21.38	23.01	99.47		.36
Tie No. 113.....	18	8.01		9.75	18.54	24.96	22.42	24.07	99.74		1.13
Tie No. 109.....	16	8.29		7.08	12.45	16.68	40.84	22.52	99.57		.74
Pile No. 118.....	47	7.68		19.92	17.58	20.62	14.48	27.11	99.71		.78
Tie No. 107.....	42	12.71		9.45	12.30	27.56	33.48	17.87	100.66		.96
Tie No. 105.....	13 <sup>3</sup>	5.08		6.83	10.16	26.11	32.17	23.91	99.18		
Tie No. 103.....	19	14.07		17.78	11.88	21.26	14.64	34.01	99.57		.26
Tie No. 110.....	19	13.84		18.23	16.61	23.01	12.78	29.11	99.74		.68
Paving blocks Nos. 88 and 89.....	20	17.19		20.13	10.27	12.18	27.46	29.78	99.82		1.19
Tie No. 114.....	30	7.41		15.44	7.44	15.68	44.96	16.14	99.66		.37
Paving blocks Nos. 90 and 91.....	11	14.37		21.03	24.45	7.68	25.06	21.78	100.00		.87
Tie No. 108.....	23	5.17		10.59	12.61	28.56	20.32	27.87	99.95		.62
Tie No. 2.....	20	5.93		15.78	8.04	27.80	18.12	29.81	99.55		.76
Tie No. 3.....	20	9.03		10.15	16.32	20.54	12.63	40.02	99.66		.54
Tie No. 41.....	22	12.76		10.46	20.34	22.63	16.32	29.83	99.58		1.14
Tie No. 101.....	24	11.46		8.32	26.36	23.42	29.58	11.86	99.54		.38
Tie No. 102.....	21	8.19		18.24	12.16	28.92	22.76	17.35	99.43		.21
Tie No. 112.....	14	7.21	0.47	7.65	8.03	17.58	38.88	27.97	100.58		1.23
Pile No. 116.....	46	8.42		9.44	16.92	29.68	32.08	11.03	99.15		
Pile No. 111.....	46	8.07	2.76	19.53	14.61	18.15	17.23	27.03	99.31		
Pile No. 117.....	46	9.31		22.20	20.10	24.30	16.24	16.84	99.68		
Pile No. 4.....	46	12.61		16.87	12.15	13.25	25.37	32.30	99.94		1.07
Pile No. 5.....	21	9.06		13.56	10.52	20.34	31.24	23.92	99.58		1.78
Tie No. 8.....	22	12.36		9.03	15.21	29.45	13.35	32.91	99.96		1.37
Tie No. 9.....	16	9.42		6.39	10.38	27.75	31.86	23.51	99.89		1.15
Pile No. 81.....	11	18.34		38.88	13.76	13.12	10.08	24.02	99.86		
Pile No. 82.....	15	19.12		51.50	12.35	3.74	11.61	21.03	100.23		
Pile No. 83 <sup>2</sup> .....	7										
Pile No. 84.....	20	8.43		13.56	15.78	14.49	19.77	36.13	99.83		
Pile No. 85.....	17	13.21		19.07	12.39	12.32	17.58	38.14	99.50		
Tie No. 86.....	22	{ <sup>1</sup> 19.36 <sup>2</sup> 16.14}		22.53	13.47	22.63	18.58	22.37	99.58		
Pile No. 50.....	29	17.63	1.26	27.60	22.43	31.22	12.02	5.13	99.66		
Pile No. 51.....	29	17.08	2.18	31.06	18.21	36.04	8.17	4.13	99.79		
Paving block No. 52.....	34	18.81	.48	26.61	32.06	17.52	8.47	14.42	99.56		
Paving block No. 53.....	29	12.44	.68	17.57	18.78	37.52	16.62	8.56	99.73		
Paving blocks Nos. 54 and 55.....	29	{ <sup>6</sup> 6.07 <sup>5</sup> 5.46}	9.62	14.41	19.27	41.74	11.23	3.40	99.67		
Conduit pipe No. 67.....	14	8.74	5.08	27.23	10.46	27.68	19.03	9.93	99.41		

<sup>1</sup> Twenty years as a tie and 13 years as a fence post.

<sup>2</sup> Treated with creosote and resin. Not analyzed.

<sup>3</sup> Center.

<sup>4</sup> Under rail.

<sup>5</sup> Paving block No. 54.

<sup>6</sup> Paving block No. 55.

From a comparison of Table 21 with Table 22 it will be seen that the loss from piling is much less than the loss from poles, although in some of the piling there was a greater percentage of creosote distilling below  $245^{\circ}$  than there was in the poles, the loss from the butt in the poles being on an average somewhat greater than the loss from the air section in the piles, and considerably greater when it is considered on an average yearly basis. Table 23 shows the analyses of creosote extracted from woods that have been subjected to different lengths of service. No estimate of the loss on this material can be made, but attention is called to the fact that, in spite of the very heavy loss that was probably experienced (see Tables 21 and 22), the fractions distilling below  $245^{\circ}$  have not disappeared entirely. These fractions are the ones that usually contain the tar acids and the tar bases, both of which are known to be very toxic. Not all the investigators made determinations for tar acids, but in 65 per cent of the analyses that were made the acids were found. The absence of tar acids does not necessarily indicate that these compounds have volatilized, because it is possible for them to undergo chemical changes, as pointed out by S. Cabot (24), or for them to attack the cellulose or wood substance in such a way as to produce materials resembling bakelite, or for them to be dissolved in the water contained in the wood, and a part of them at least to penetrate into the apparently untreated portion of the wood. In any one of these conditions the tar acids would probably be missed by the investigator.

No short test is known to the writer that will give the volatility of creosote in any but a comparative way. For this purpose an examination of the percentage of distillate would probably serve as well as any other test. A number of tests have, however, been made both by evaporation from open dishes or pans and by evaporation from the treated wood. Figure 31A shows the loss of creosote by evaporation from open pans or dishes under two conditions of heating, and the percentage distilling at  $270^{\circ}$  C. The points fall roughly in a straight line. Figure 31B shows the same kind of relation between the amount distilling at  $270^{\circ}$  C. and the loss from creosoted wood. The relation here is represented by a nearly straight line, but the slope is much steeper than before. Furthermore, the maximum loss is less than half that in the dish test, although the oils were much lighter in character.

Von Schrenk and Kammerer (25) have reported a number of tests on six creosotes under three sets of conditions; that is, evaporation from open pans at room temperature for 304 days, evaporation for the same length of time from maple blocks, and evaporation from pine blocks. Using this length of time, the investigator shows that the loss by evaporation from the open pan is practically the same as the loss by evaporation from wood under the same conditions for

the creosotes tested. Beyond the time of 304 days the blocks gained in weight, probably because of the absorption of moisture. The results of these tests are plotted in figure 31c, in which the ordinates are the percentages distilling at 270° C. and the abscissæ are

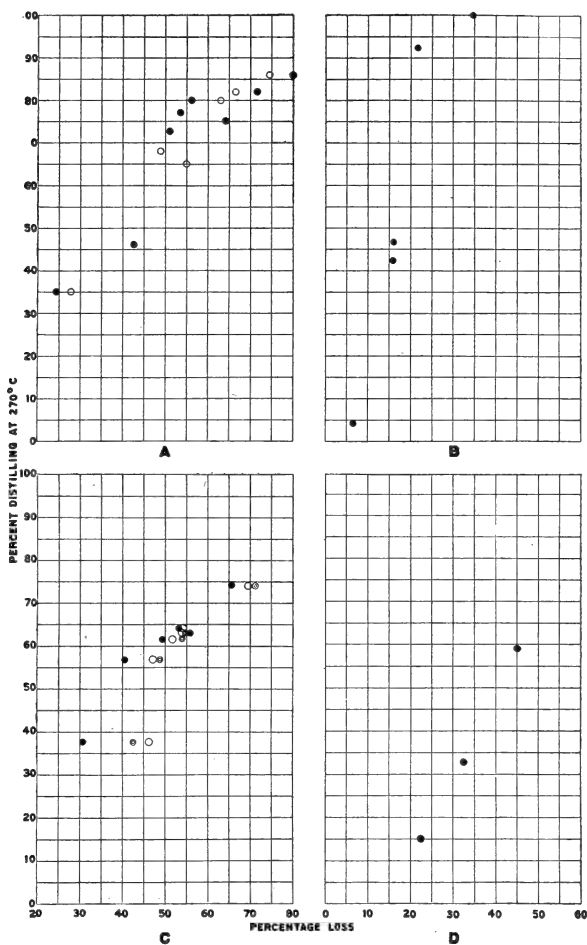

FIG. 31.—Relation between the loss by evaporation and the per cent of the oil volatile below 270° C.

- A. Loss of coal-tar creosote by evaporation from open pans.
- B. Loss of coal-tar creosote by evaporation from creosoted wood.
- C. Loss of coal-tar creosote by evaporation from pans and creosoted wood. Dots—Open pans. Circles—Maple blocks. Double circles—Pine blocks.
- D. Loss of water-gas tar creosote by evaporation from open pans.

the percentages of loss by evaporation. The three points lying in the lines parallel to the abscissæ are obtained by using the same creosote in the three different methods of test.

Recently Bateman and Town (26) have shown that the loss of creosote by weight because of evaporation in laboratory open-tank treatments is in direct proportion to the area of the surface of the oil, and is also dependent upon the volatility of the creosote. They give the equation  $\log L = 0.0165V - 0.347$  as the daily loss per square foot of exposed surface, when the temperature of the bath is 195° F. In this equation  $\log L$  is the logarithm of the loss and  $V$  is the percentage of creosote distilling below 270° C. The constants 0.0165 and 0.347 will vary if any of the conditions are used except those under which the experiment was carried out. Figure 32 gives a curve of the above equation, with the experimental data plotted upon it.

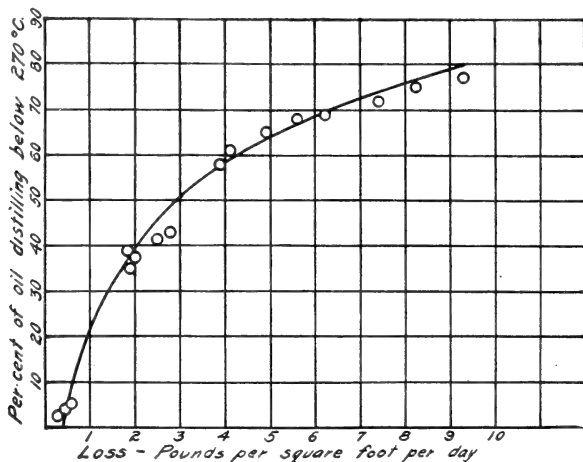

FIG. 32.—Relation between the volatility and the loss by evaporation of creosotes from open tanks.

Calculations show that it is very likely there is a mathematical relation between the rate of loss of creosote from treated wood and the amount and character of the creosote injected. The general form of the equation, as obtained from preliminary calculations, is

$$\frac{KA^2(1-Y)^3Y^2}{B-Y} = X$$

where  $K$  is a constant for the location,  $A$  is the weight of creosote injected per cubic foot of wood,  $B$  the percentage of creosote distilling below 270° C.,  $Y$  the loss by evaporation, and  $X$  the time required.

Figure 33 gives two curves in which the above equation has been used on two different creosoted sticks which had different grades of creosotes and different absorptions per cubic foot. In one curve the amount of oil distilling below 270° C. was 92 per cent, in the other curve 49 per cent. The amounts of oil injected per cubic foot were



Year	Quantity	Species	Origin	Location	Notes
1884		Yellow pine	Grand Central Yards.	New York City	
1886		Oak and pine	L. V.		
1887	252	Longleaf pine	A. C. L.	Halifax, N. C.	Ruef
1888		Hemlock	N. Y., N. H., & H.	Somerset, Mass.	
1891-2	6,500	Mixed	N. J. C.	Highlands Pier.	
1894	6,000	Pine	N. Y., N. H., & H.	Fairhaven tunnel, Conn.	
1896	76,100	Various	N. J. C.	Central division	
1897	25	Juniper	N. & S.	Norfolk division	
1897	75	do	do	do	
1904	190	Sawed s. y. pine	A., T., & S. F.	Ponca, Okla.	Ruef
	275	Hewed s. y. pine	do	Bliss, Okla.	do
	366	Sawed s. y. pine	do	Parry, Okla.	do
	27	Hewed s. y. pine	do	do	do
1905	304	do	do	Marceline, Mo.	do
	572	Sawed s. y. pine	do	Argonia, Kans.	do
	44	Hewed s. y. pine	do	Sutton, Kans.	do
	384	Sawed s. y. pine	do	Garnet, Kans.	do
1905	33	Sawed red gum	G., H., & S. A.		
	29	do	do		
	26	do	do		
	45	do	do		
	39	do	do		
	28	do	do		
	35	Sawed tupelo gum	do	Bay View and San Leon, Tex.	Full
	30	do	do		
	23	do	do		
	44	do	do		
	36	do	do		
	33	do	do		
1905	83	Red oak	St. L. & S. F.	Paupi, Mo.	do
	40	do	do	do	Ruef
1906	752	do	do	St. Clair, Mo.	do
	321	do	do	do	do
	205	Pine	G., H., & S. A.	Salix, La.	Full
	285	do	do	Lafayette and Scott	do
	560	do	N. Y., N. H., & H.	Fairhaven tunnel	do
	24,238	do	A., T., & S. F.	Ottawa cut-off	Ruef
1907	390	Red gum	do	Hutchinson, Kans.	do
	230	do	do	do	do
	262	do	do	Plesa, Kans.	do
	1,000	Loblolly pine	G. R. R.	Union Point, Ga.	Full
	1,000	do	do	Barrett, Ga.	do
	58	do	C., B. & Q.	Sheridan, Wyo.	
	2,494	Shortleaf pine	P. L. W.	Scio, Ohio	Ruef
	3,200	Long-leaf pine	N. Y., N. H., & H.	East of Greenwich	Full
	200	S. y. pine	do	Fairhaven tunnel	do
	1,274	do	L. & N.	Paules, Ark.	
1908	46	Red oak	M. P.	Summer, Wash.	Low
	98	do	C., B., & Q.	Lines east	Full

<sup>1</sup>N. L. T.=Not less than.

Date placed.	Number placed.	Location
1897	9,975	Washington-N
1899	7,644	Montgomery-N

10.48 pounds and 18.79 pounds, respectively. The value of  $K$  in these experiments was  $\frac{3.3}{100}$ . The equations for the two curves are

$$\frac{3.74(1-Y)^3 - Y^2}{92-Y} = X, \text{ and } \frac{11.68(1-Y)^3 - Y^2}{49-Y} = X,$$

respectively. The curves and data are plotted independently.

It would appear, however, notwithstanding the great loss which must certainly have occurred, that the effect of this loss upon the

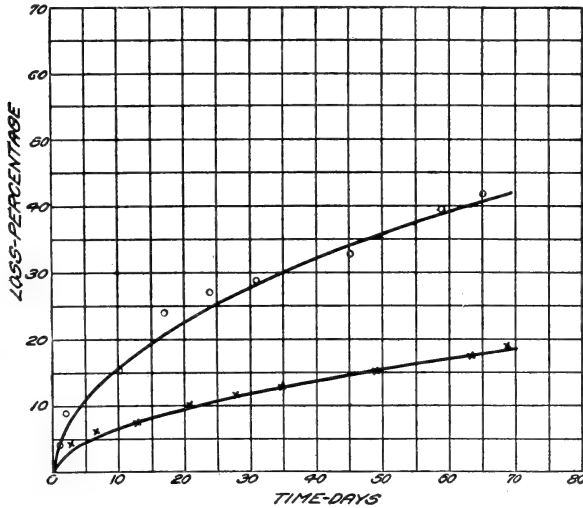

FIG. 33.—The relation between the volatility and loss by evaporation of creosotes from treated wood with time.

life of the treated timber may have been given more weight than it really deserved, particularly as to its effect upon the prevention of decay. Bateman (27) has shown that in all service records of ties and telephone poles, many of which were treated with very light creosote, the failures are due to mechanical failure of the wood itself and not to the failure of the creosote to protect. Tables 24 and 25 show the service records from which these conclusions are drawn and the analyses of the oils used.







### CHAPTER III. TOXIC PROPERTIES OF COAL-TAR CREOSOTES.

To be an efficient wood preservative, any oil must have at least two properties: It must be toxic; that is, able to destroy or to inhibit the growth of the organisms that cause the destruction of timber, and it must be as nearly permanent as possible. In addition to these two, it may have other properties, such, for example, as that of waterproofing, which would aid in the retardation of fungus growth. The most efficient wood-preserving oils, therefore, must possess a high degree of toxicity combined with a high degree of permanence. The long service of timbers treated with coal-tar creosote shows conclusively that coal-tar creosote possesses these properties to a marked degree.

Toxicity tests may be divided into three groups or classes: (1) tests on timber-destroying fungi; (2) tests on marine borers; and (3) tests on insect borers. The first two are of the greatest importance to the wood-preserving industry at the present time. The tests on fungi may be conducted in at least three ways: (1) by Petri-dish tests, which require only a short time for their completion; (2) by fungus-pit tests, requiring a somewhat longer time; and (3) by service tests, requiring from 4 to 10 years to obtain the results. The last is, of course, the most conclusive proof of the preserving value of any wood-preserving oil, but requires an exceedingly long time, and is, moreover, a test that combines permanence and toxicity. Furthermore, in such tests not infrequently the wood fails mechanically before the usefulness of the preservative is ended. The first and second are only comparative tests and show what might be expected of any wood preservative when compared with some other material of known value. In these two tests the factor of permanence is largely but not completely eliminated; it is, therefore, possible that a material which under tests promises to be a very effective preservative may not prove to give good service because of its lack of permanence.

#### FUNGUS-PIT TESTS.

Fungus-pit tests have been started by the Forest Products Laboratory, by Chapman (28), of Westinghouse, Church, Kerr & Co., and by Hosford, of the American Telephone & Telegraph Co., and probably by others. At the Forest Products Laboratory the tests consisted of placing blocks treated with various preservatives in a concrete pit in which the humidity and temperature could be

controlled, and of inoculating these blocks with timber-destroying fungi. The test at the laboratory has not been successful in destroying the treated wood. In the light of present knowledge only negative results could be expected from such tests.

Chapman (28) brush-treated his test specimens and set them in sheep manure. Experiments with brush-treated fence posts and telephone poles show that such a test will not be a test of the preservative, but that the wood will decay because checks and cracks develop and permit the entrance of fungi into the untreated section long before the treated portion has lost its resistance to decay. The original conception of the fungus-pit test was that the life of a preservative could be determined in a shorter time than by service tests, but the tests so far carried out have failed to obtain this result. The reason has been either that specimens which have decayed were not treated in such a manner as to give the preservative life of the creosote; or that the conditions in the fungus-pit were such that the creosote did not lose its vitality as it does under exposure.

#### PETRI-DISH TESTS.

There are various ways of making Petri-dish tests, which vary with different operators. Objections or criticisms can probably be brought against any one of the systems now in use. The general principles of the tests, however, are the same. A nutrient medium is prepared, in which the fungi can thrive under certain known conditions. To this medium, which usually consists of agar agar mixed with some nutrient such as beef broth, are added known amounts of the preservative, and the whole is poured into shallow covered glass dishes known as Petri dishes. After the agar agar has solidified to a jelly, it is inoculated with the fungus or other organisms to be used in the test. The organisms that have been used in testing wood preservatives include molds, yeast, timber-destroying fungi, and bacteria. The objection to the use of molds, yeasts, and bacteria for testing wood preservatives is that the killing points for these organisms might be entirely different from that for timber-destroying fungi, and it is already known that timber-destroying fungi differ among themselves in their resistance to certain wood preservatives. The chief advantage is that the test can be made in a few days instead of the weeks necessary when timber-destroying fungi are used. Although this difference in behavior in the various kinds of low organisms tested must be recognized, the information obtained from these comparative tests performed with such cultures is not entirely without value; for the experiments give very quickly some general idea of the relative toxicity, and approximately indicate the order in which the toxicity may reasonably be expected to fall when the preservatives are tested against timber-destroying fungi.

Humphrey and Fleming (29), of the Forest Products Laboratory, and Dean and Downes (30), of the Sheffield Scientific School, have put this work on safer ground by using the timber-destroying fungi in their tests. The former, who have done by far the greatest amount of work and have used chiefly the fungi *Fomes annosus* and *F. pinicola*, place the toxic point of coal-tar creosote between 0.2 and 0.5 per cent. If this is the true toxic point, then one-fifth of a pound of creosote per cubic foot of wood, provided it were properly distributed, would be sufficient to stop the growth of the fungi.

#### CAUSE OF TOXICITY OF CREOSOTE.

There is now little or no data on what compound or compounds in coal-tar creosote are responsible for its toxic effect, because few of the constituents have been isolated and subjected to tests. In general, the constituents of coal-tar creosotes may be divided into three groups—the hydrocarbon oils, the tar acids, and the tar bases. Of the hydrocarbons that are found in coal-tar creosote, naphthalene and anthracene, according to the methods used by J. M. Weiss (31), seem to have very little toxic action against bacteria, yeast, and penicilium. Russell and Pendleton (32) have shown that benzene and toluene are capable of destroying certain undesirable (or harmful) soil protozoa, bacteria, and fungi, but do not act on certain other soil bacteria that are desirable. Naphthalene and crude oil, when tested in the same way, gave a similar but slighter action. Weiss (31), Charitschkow (33), and Dean and Downes (30) have shown that the “neutral oils”—those oils that have been freed from tar acids and tar bases by being washed with caustic soda and sulphuric acid—still possess a considerable toxic property. Weiss (31) and Charitschkow (33) state that the toxicity of the neutral oils is nearly as great as the toxicity of the original creosotes from which they were obtained. Dean and Downes (30) show that the acid-free oil is more toxic than the original, but that the neutral oil (free from both acids and bases) is only about two-thirds as toxic as the original. The same sort of evidence has been obtained in the Forest Products Laboratory by Huntley (34), except that in his tests the toxicity of the neutral oils exceeded the toxicity of the original creosote. There is, of course, the possibility that the methods used to remove the tar acids and tar bases were such that there were traces of these materials or their salts still remaining in the oil, and that the increased toxicity of the tar-acid free oil of Dean and Downes and of the neutral oil of Huntley was due to the small amounts of tar-acid salts, which are somewhat more soluble in the agar medium than are the acids themselves. However, the weight of evidence now available seems to show that the neutral oils of coal-tar creosote are themselves very toxic, and that this toxicity is due to the lower-boiling hydrocarbons.

Of the tar acids and other oxygenated compounds found in coal-tar creosote, perhaps the best known is phenol, or carbolic acid. Phenol is recognized in medicine as being extremely toxic to practically all kinds of living organisms. It is used as a standard in the determination of the killing power of antiseptics and bactericides. The higher homologues of phenol, the cresols, are from two to four times as effective toward bacteria as is phenol, and the naphthols are also extremely toxic compounds which have been used as antiseptics and germicides. Weiss (31) has shown that the tar acids (all the tar acids extracted with caustic soda) are about as toxic as pure carbolic acid to penicillium, bacteria, and yeast, and that pure cresol is much stronger, requiring only a trace, whereas pure carbolic acid requires 0.15 per cent. Trillat (35) in 1892 mentioned phenol and alpha and beta naphthol as powerful antiseptics. Adiasiewietsch (36), in 1897, in experimenting with petroleum products, added tar acids among other things to increase the utilization of petroleum for wood preservation. Bokany (37) compared the efficiency of phenol with other antiseptics, and Schneider (38) has prepared powerful antiseptics from the alpha and beta naphthols as well as from the cresols. Russell and Pendleton (32) have shown that both the phenols and cresols are valuable for soil sterilization, although these operators found certain bacteria which apparently lived upon them. Morgan and Cooper (39), in 1912, showed that against the *Bacterium typhosum* the tar acids in general increase in toxicity with increase in molecular weight; and that in the same series of compounds, an increase in molecular weight is always accompanied by a rise in boiling point. They also show that the dihydroxynaphthalenes (2, 3, hydroxynaphthalenes and 2, 7, hydroxynaphthalenes), that is, naphthols having two phenolic groups, are between three and five times as toxic as phenols. It will be noted that the references given here are to comparatively recent experiments, some of which were directly connected with the wood-preserving industries. The references have been given to show that there are a number of investigators in wood preservatives who believe that coal-tar creosote owes its antiseptic properties, in a large measure at least, to phenols or tar acids.

The nitrogen bodies, that is, the pyridines, quinolines, and some others, have not been investigated so thoroughly as the phenols. Trillat (35) placed both quinoline and pyridine in the list of powerful antiseptics. Weiss (31) has shown that quinoline has decided antiseptic properties, being somewhat stronger than the phenols against the organisms tested. Morgan and Cooper (39) showed that the amines, that is, those compounds containing an  $NH_3$  group, are, in general, toxic to the *Bacterium typhosum*, although not so toxic as the corresponding phenols. Here again, in the same series of com-

pounds, the toxicity increases with molecular weight and with rise in boiling point. Russell and Pendleton (32) have shown that both pyridine and quinoline are valuable for soil sterilization.

It is realized that these tests on the various constituents of coal-tar creosotes are not conclusive proof of the antiseptic action of these materials when they are applied to timber-destroying fungi. The tests do at least point out the way in which it is most probable that creosote produces its toxic effect, and it might reasonably be assumed that the various classes of compounds, when applied to fungi, will behave in much the same way as they did in the tests in which they were applied to various other lower organisms. This will be the more probable if the general conclusion can be substantiated by a considerable amount of data. Certain tests now being made at the Forest Products Laboratory show that the tar acids are extremely toxic to timber-destroying fungi; that the tar bases are as toxic to these fungi, if not more so; and that the higher hydrocarbons under test have at best a slight toxicity. It seems, therefore, that the conclusion is justified that creosote oil in a large measure owes its toxicity against timber-destroying fungi to the tar acids and tar bases which form a small part of its composition, the rest of the toxic effects being caused by the light oil. The heavier oils have but little toxic value for this purpose. This conclusion is further brought out by the curve (fig. 36) showing the toxicity of coal-tar creosote plotted against its volatility at 275° C.

#### TESTS ON MARINE BORERS.

Practically the only work of this nature on the toxicity of creosote and its constituents toward the marine borer that has been published is that of Dr. Shackell (40). He showed that the phenols were extremely poisonous to the *Xylotrya*, but that the hydrocarbons, naphthalene, and anthracene could apparently be taken in and ejected from the body of this marine borer with no ill effects upon the animal. In conformity with this result, he found that the lower fractions of creosote are more toxic, and that, as the boiling points of the fractions increase, the toxicities decrease.

#### COMPARISON WITH SERVICE TESTS.

It is of considerable interest to compare the results of toxicity tests with service tests on the same material. Fortunately, there is in the Forest Products Laboratory a series of fractions of coal-tar creosotes which have been tested by the Petri-dish tests for fungi, by laboratory tests for *Xylotrya*, and by service tests as piling. Table 26 shows such a comparison.

TABLE 26.—Comparison of laboratory toxicity tests and service tests on fractions of coal-tar creosote.

Material.	Boiling point at the still.	Relative position against <i>Fomes annosus</i> .	Relative position against <i>Xylotrya</i> .	Relative position in service.
Fraction 1.....	Below 205° C.....	2	1 1	2 6
Fraction 2.....	205° to 250° C.....	1 1	2	5
Fraction 3.....	250° to 295° C.....	3	3 and 4	4
Fraction 4.....	295° to 320° C.....	5	5	2 and 3
Fraction 5.....	Res. above 320° C.....	2 6	2 6	1 1
Coal-tar creosote L-54.....	A verage creosote.....	4	3 and 4	2 and 3

<sup>1</sup> The figure 1 indicates the greatest toxicity or service.

<sup>2</sup> The figure 6 indicates the least toxicity or service.

Table 26 shows that the toxicity and length of service of the materials tested are almost completely reversed—that is, the highest toxicity gave the least service, and the least toxic substance gave the best service. The discrepancy between these two results is, however, easily explained. In order to exert its effect upon *Xylotrya*, the toxic principle must be soluble in the body fluids of this organism. In a state of purity these toxic principles would have a great and immediate toxic effect, but this effect would not be permanent, because the toxic principle is taken out by the continual leaching of the water. If, however, these toxic principles are mixed with oils in which they are more soluble than they are in water, it becomes increasingly harder to leach them, because of the retarding action of the oil. If, then, the toxic principles of coal-tar creosotes are considered to be chiefly the lower-boiling oils, it would be expected that in the Petri-dish tests, which are conducted with only a small amount of water, the fractions would arrange themselves in the order 1, 2, 3, 4, 5. But in service tests a greater loss would be expected from fraction 1 than from fraction 2, and a greater loss from fraction 3 than from fraction 4, and so on. The character of the residual oil in fraction 1 would tend to approach the character of the oil in fraction 5, and in the end the oils would be much the same in composition; fraction 1 would contain the least, and fraction 5 the most preservative, and the service tests would be expected to show the order 5, 4, 3, 2, 1. This was the actual arrangement in the service tests.

The separation of the fractions sharply into those indicated in Table 26 is by no means complete. Present knowledge of the action of complex mixtures upon distillation indicates that fraction 1 might be expected to contain considerable material which should have been included in fraction 2, a smaller amount which should have been included in fraction 3, and perhaps a small amount of fractions 4 and 5. Fraction 2 might be expected to contain considerable amounts of fractions 1 and 3, and smaller amounts of fractions 4 and 5. The truth of these statements is illustrated in Table 27, which

shows the percentage distilling from each fraction within the limits of the other fractions.

TABLE 27.—Relative composition of fractions of coal-tar creosotes when redistilled by Hempel flask (30).

Fraction No.	Amount distilling within the limits of—				
	Fraction 1.	Fraction 2.	Fraction 3.	Fraction 4.	Fraction 5.
	<i>Per cent.</i>	<i>Per cent.</i>	<i>Per cent.</i>	<i>Per cent.</i>	<i>Per cent.</i>
1	63	37	—	—	—
2	10	72	26	2	—
3	—	22	52	20	6
4	—	1	22	31	46
5	—	—	3	21	76

A more refined analysis would, of course, increase the distillation range. Huntley has shown that on the redistillation of fraction 4 the following initial boiling points were obtained, the initial boiling point at the still having been 295° C.

	° C.
Initial boiling point of second distillation.....	270
Initial boiling point of third distillation.....	210
Initial boiling point of fourth distillation,.....	140
Initial boiling point of fifth distillation.....	137

In other words, although the initial boiling point at the still was 295° C., this fraction contained a small amount of material boiling below 200° C. This amount was found to contain approximately 20 per cent of tar acids, and the amount boiling from 200° to 235° C., contained considerable quantities of tar bases. Both of these are very toxic materials and in the pure state are soluble in water; when mixed with oils in which they are soluble their extraction with water would take a very long time.

The two factors that govern the preserving value of any wood preservative are permanence and toxicity, but these two factors seem to be diametrically opposite. The relation between them is shown in figure 34.

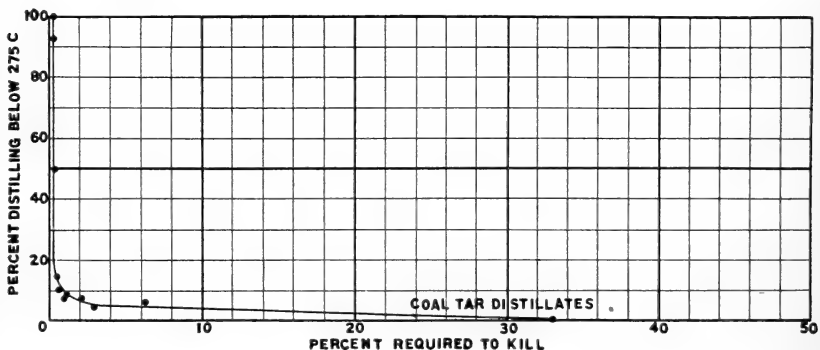

FIG. 34.—Relation between the volatility and toxicity of coal-tar creosotes.



## CHAPTER IV. COMPOSITION AND PROPERTIES OF WATER-GAS-TAR CREOSOTES.

### COMPOSITION OF WATER-GAS-TAR-CREOSOTES.

The distillate oils of water-gas tar boiling above 200° C. and as high, sometimes, as 400° C. are referred to as water-gas-tar creosotes. Like the coal-tar creosotes, they are extremely complex mixtures, composed chiefly of compounds of the aromatic series. They usually contain compounds of the aliphatic series, but this is by no means a characteristic of all water-gas-tar creosotes. The amounts may vary from nothing to as high as 20 or 25 per cent, depending chiefly on the temperature of formation of the mother liquor, tar. The results of much less research work have been published on water-gas tar and its products than on coal tar; consequently much less is publicly known about this material.

The similarity of water-gas-tar creosote and coal-tar creosote makes it seem very probable that in general the hydrocarbons found in the highly aromatic water-gas tars are the same as those found in coal tars. Benzol, toluol, xylol, naphthalene, phenanthrene, and methyl anthracene have been identified. The most notable difference between coal-tar creosotes and water-gas-tar creosotes is the nearly total absence of tar acids and tar bases in the latter and their presence in considerable amounts in the former. On account of the lack of these materials the odor of water-gas-tar creosotes is more oily than the odor of coal-tar creosotes.

### CHEMICAL PROPERTIES OF WATER-GAS-TAR CREOSOTES.

The chemical properties of water-gas-tar creosotes are in general the same as those of coal-tar creosotes from which the tar acids and tar bases have been removed. Only a very small proportion is reacted upon by caustic soda or dilute mineral acids. Concentrated sulphuric acid forms many sulphonic acids which are identical with the sulphonic acids produced from coal-tar creosotes.

### PHYSICAL PROPERTIES OF WATER-GAS-TAR CREOSOTES.

Because of the great similarity between water-gas-tar creosotes and coal-tar creosotes, the physical properties of one material would in general be the same as those of the other. The same solvents can be used for both. In general, the color of water-gas-tar creosote is somewhat more greenish, although this does not always hold true. The specific gravity of water-gas-tar creosotes is somewhat lower than the specific gravity of coal-tar creosote, varying between 1 and 1.07 at room temperature.

## VOLATILITY.

The volatility of three water-gas-tar creosotes is shown in figure 31D. Here the loss by volatilization is plotted against the percentage distilling at 270° C. These data were obtained from hemlock treated with water-gas-tar creosotes and held under test for 80 days at a temperature of 40° C. The conditions of these tests were the same as those described in connection with figure 31B, for coal-tar creosotes. The same general result is obtained from these creosotes as from coal-tar creosote, namely, that the volatility increases in some direct ratio to the percentage distilling below 270° C. The character of the

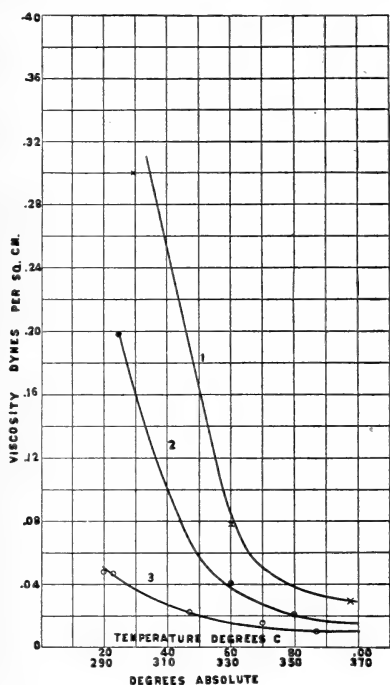

FIG. 35.—Change in viscosity of water-gas-tar creosotes with change in temperature. 1. Very high boiling oil. 2. Similar to a high-boiling creosote. 3. Low-boiling oil.

test, whether from open pan or from treated wood, whether of short or long exposure, and the temperature of heating will, of course, affect the volatility in the same general manner as in coal-tar creosote. Different results would probably also be obtained if different species of wood were used. A comparison of the two curves, which are comparable as far as treatment, wood, temperature of heating, and length of exposure are concerned, reveals the fact that the volatility of water-gas-tar creosote is the same as that of coal-tar creosote having the same percentage of distillate below 270° C. It follows, therefore, that the discussion of the volatility of coal-tar creosotes will apply equally well to water-gas-tar creosotes.

## VISCOSITY.

The change in viscosity with a rise in temperature for three water-gas-tar creosotes of widely different characteristics is shown in figure 35. The creosotes are pure distilled products without the addition of any tar. The change in viscosity of water-gas-tar creosotes with change in temperature can be calculated in the same manner as that of coal-tar creosotes according to the equation,  $\frac{V}{T^A} = K$ , where  $V$  is the absolute viscosity,  $T$  the absolute temperature, and  $K$  and  $A$  are constants depending upon the oil. The equations,

for the three curves in figure 35 are,

$$(1) V = \frac{6.02(10)^{31}}{T^{13}} \quad (2) V = \frac{3.4(10)^{31}}{T^{13}} \quad (3) V = \frac{8.94(10)^{17}}{T^{7.8}}$$

#### TOXIC PROPERTIES OF WATER-GAS-TAR CREOSOTES.

One might expect that the toxicity of water-gas-tar creosotes would be somewhat less than the toxicity of coal-tar creosotes because of the absence of tar acids and tar bases. This, in general seems to be true. The killing points of a few authentic water-gas-tar creosotes produced in the Forest Products Laboratory vary from 0.3 per cent to approximately 1 per cent against the timber-destroying fungus *Fomes annosus*. Dean and Downes (30) have investigated water-gas-tar creosotes and compared them with coal-tar creosotes. Their investigations with the timber-destroying fungus *Polystictus versicolor* show that the water-gas-tar creosotes used in their tests were about as toxic as the coal-tar creosotes which they used. These investigations also showed that the coal-tar creosote, after being freed from tar acids and tar bases, was only two-thirds as toxic as the original creosote or the water-gas-tar creosotes with which they compared it. The water-gas-tar creosotes were about twice as toxic as the high-boiling anthracene oils obtained from coal tar. J. M. Weiss (31) has shown that water-gas-tar creosotes are not so toxic against yeast, molds, and bacteria as the coal-tar creosotes which he tested.

The work of these investigators may be criticised not only because of their method of determining the toxicity, but also because they did not compare creosotes of similar boiling points. Dean and Downes, for instance, compared the toxicity of creosotes having the distillation limits shown in Table 28.

TABLE 28.—Comparison of the percentages of distillates of the creosotes whose toxicities were compared by Dean and Downes.

Fraction.	Coal-tar creosote.	Water-gas-tar creosote.
	<i>Per cent.</i>	<i>Per cent.</i>
Up to 205° C...	6.5	10.0
Up to 240° C...	37.2	45.5
Up to 300° C...	58.5	78.0
Up to 320° C...	67.6	84.0

The water-gas-tar creosote has a much lower boiling point than has the coal-tar creosote, and, consequently, it should be more toxic than the neutral oil of the coal-tar creosote. Weiss compared the oils as shown in Table 29.

TABLE 29.—Comparison of the percentages of distillates of the creosotes whose toxicities were compared by Weiss.

Fraction.	Straight coal-tar creosote.	Maintenance of way creosote.	Neutral coal-tar creosote sp. gr. 1.037.	Water-gas-tar creosote sp. gr. 1.024.	Water-gas-tar creosote sp. gr. 1.053.
Up to 200° C. ....	6.6	.....	1.8	1.1	.....
Up to 235° C. ....	60.3	33.2	30.6	18.9	5.3
Up to 270° C. ....	76.5	60.5	63.4	50.2	24.3
Up to 315° C. ....	86.2	78.0	87.2	81.4	49.0

All the coal-tar creosotes, even the neutral creosote, had lower boiling points than the water-gas creosotes, and consequently they should be more toxic than the water-gas-tar creosotes.

Tests made at the Forest Products Laboratory indicate that water-gas-tar creosotes, particularly the lower boiling ones, have a considerable degree of toxicity. A relation of toxicity to volatility similar to that found in coal-tar creosotes holds in the case of water-gas-tar creosotes also, except that the latter are not as toxic as the former, particularly so in the higher boiling oils that are analagous to carbolineums. The relation between toxicity of water-gas-tar creosotes and their volatility is shown in figure 36.

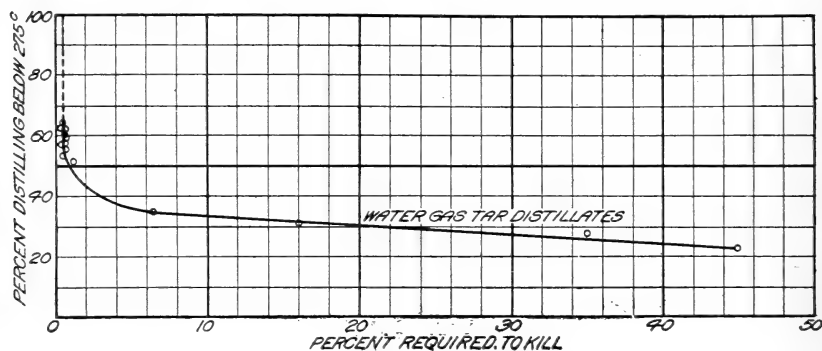

FIG. 36.—The relation between volatility and toxicity of water-gas-tar creosotes.

**CHAPTER V.—COMPARISON OF THE PROPERTIES OF COMMERCIAL COAL-TAR CREOSOTES AND COMMERCIAL WATER-GAS-TAR CREOSOTES.**

It is believed that a short comparison of the properties of commercial oils will be of value, notwithstanding the fact that they have been discussed at some length in the preceding chapters. Table 30 shows the similarities and dissimilarities of coal-tar creosotes and water-gas-tar creosotes.

TABLE 30.—*Comparison of the properties of commercial coal-tar creosotes and commercial water-gas-tar creosotes.*

	Coal-tar creosote.	Water-gas-tar creosote.
Specific gravity of original creosote.....	1.01 and up.....	1.00 and up.
Flash point.....	70° C. and up.....	70° C. and up.
Burning point.....	90° C. and up.....	90° C. and up.
Distilling range.....	170 to 400° C.....	170 to 400° C.
Change in specific gravity per degree C.....	0.00078.....	0.00078.
Sulphonation residue of fractions 275° to 285° C.....	Up to 8 per cent.....	0 to 8 per cent.
Tar-acid content.....	Up to 10 per cent.....	None.
Character of hydrocarbon.....	Chiefly aromatic.....	Chiefly aromatic.
Ratio of specific gravity to index of refraction of the fraction 275° to 285° C.....	1.81.....	1.56.
Toxicity.....	Shown in fig. 37.....	

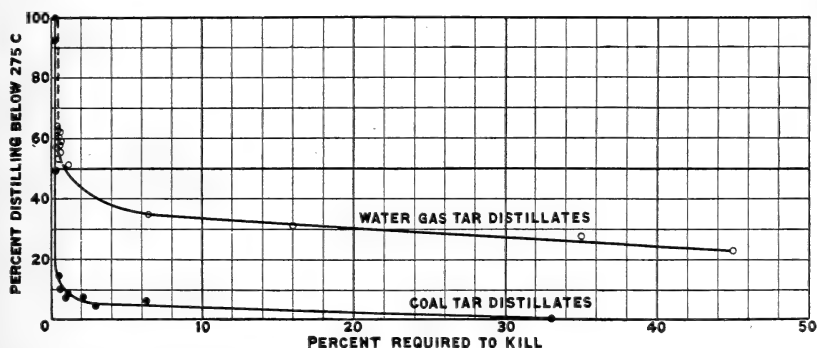

FIG. 37.—Comparison of the toxicities of coal-tar creosotes and water-gas-tar creosotes.

The chief difference between these two classes of creosote are a total lack of tar acids and bases in the water-gas-tar creosotes, a higher general average of the sulphonation residues in water-gas-tar creosotes than in coal-tar creosotes, and a lower toxicity. (Fig. 37.)

The only methods known at the forest products laboratory for differentiating between two classes of oils are the determination of

the tar-acid and tar-base contents, the determination of the ratio of the specific gravities to the indices of refraction values of the various fractions, and the testing of the toxicity of the creosotes. The absence of tar acids or tar bases is proof that the oil under test is not a distillate of coal tar. Part of the tar acids or tar bases may be removed from coal-tar creosote by chemical methods, but it is not likely that all the tar acids and all the tar bases would be taken out by such means. On the other hand, the presence of tar acids or tar bases or both classes of compounds does not mean that the oil under examination is a pure coal-tar distillate. It may be a water-gas-tar oil which has been mixed with a coal-tar creosote containing large amounts of tar acids and bases, or these materials may have been added directly to water-gas-tar creosote. The determination of the ratio of the specific gravities of the fractions to their index of refraction values is of use only if it is known that the distillates are pure oils, either water-gas-tar or coal-tar distillates. Unknown mixtures of the two can not be differentiated with certainty by this method. The toxicity test is of value only in high-boiling oils similar to carbolineum. In lower-boiling oils the fraction similar to carbolineum might be tested, but because of the fact that six weeks are required for its completion this test is of little value for commercial purposes.

## CHAPTER VI. TAR-CREOSOTE SOLUTIONS.

Within the last few years tar-creosote solutions have been used more and more in wood preservation. Various claims have been put forward in favor of tar: First, that, as it is the mother liquor of creosote, it contains all the toxic principles of creosote; second, that it retards the evaporation of creosote when mixed with it; third, that it does not reduce penetration into the wood; and fourth, that it is cheaper than coal-tar creosote. In answer to these arguments it may be said that, although tar is the mother liquor and contains all the toxic principles of coal-tar creosote, the concentration of the toxic elements in coal tar is only about one-fourth of that in coal-tar creosote, because coal-tar creosote is only about one-fourth of the volume of the coal tar from which it is distilled and contains practically all the toxic principles. It has also been shown in this bulletin that coal tar does not retard the evaporation of creosote mixed with it. Furthermore, Bond (17), and Teesdale and MacLean (18) have demonstrated that it is more difficult to penetrate wood with coal-tar solutions than it is with creosote.

### TAR AS A DILUENT.

The chief value of tar is as a diluent of creosote, although it may have a retarding influence on the rate of solution of the toxic principles into the wood. The use of a diluent in wood preservation is no new thing. In the treatment of wood with zinc chloride a strength of solution is used that will insure a thorough penetration. If the wood is difficult to penetrate, a relatively strong solution is used; but, if it is easy to penetrate, a more dilute solution is used, and more solution is put in, thus insuring a more thorough treatment. In other words, the amount of water or solvent is varied, but the amount of zinc chloride is kept constant. With zinc chloride the factor of safety is only about 2; with creosote it is in the neighborhood of 50. The reason for this great difference is that by diluting zinc chloride with water a depth of penetration as great as possible is obtained, and still only a small amount of zinc is used. On the other hand, it is impossible to give a deep oil penetration without using large quantities of oil. However, the usual oil penetration could be obtained, and at the same time creosote could be saved if it were diluted with some other oil, and this would have an effect analogous to that of the water in a zinc-chloride solution. As any good solvent of creosote would serve as well as another for this purpose, the main

thing is to obtain the cheapest material that will meet the conditions. Benzene and chloroform would answer the requirements so far as physical and chemical conditions are concerned, and on drying they would evaporate just as water does; but their use is, of course, out of the question on account of their great cost. Wood-preservers are practically confined by cost to such crude raw oils as crude petroleum, coal-tar, or water-gas tar. Of these three, coal-tar and water-gas tar are better solvents of creosote than is crude petroleum. Of the two tars, water-gas tar seems for the following reasons to fulfill more nearly all the requirements of a diluent:

(1) It contains an exceedingly small amount of suspended matter, whereas coal tar, as a minimum, has about 3 or 4 per cent. The viscosity of water-gas tar is usually less than that of coal tar. A mixture of water-gas tar and creosote may, therefore, be expected to penetrate more rapidly than an equal mixture of coal tar and coal-tar creosote.

(2) It may be used in its raw state when it is free from water. Coal tar containing ammonia was found by Bolton to be injurious to wood; therefore it must be refined in order to remove the ammonia.

(3) Crude water-gas tar, water free, is cheaper than refined coal tar.

Inasmuch as service records (27) show that the failures so far experienced in ties, poles, and other timbers have been the result of mechanical wear, checking, and similar causes, and not of the failure of the preservative, it is apparent that the limit of the life of coal-tar creosote has not been reached in this kind of service. In other words, the factor of safety is probably very much larger than it need be. It would seem justifiable in such conditions to dilute the creosote with some cheaper material, such as tar, to make the life of the preservative and the mechanical life of the wood more nearly equal. The best kind of oil to use for dilution under such conditions would be the low-boiling creosotes, because these contain the greatest amount of toxic materials. If the theory of the mechanism of preservative action suggested in this bulletin is correct, these low-boiling creosotes probably need more high-boiling materials to retard their too rapid solution.

#### PROPERTIES OF TAR-CREOSOTE SOLUTIONS.

But little can be said about the properties of tar-creosote solutions except that they should be intermediate between the same properties of creosote and tar. A small amount of work has, however, been done and the results of it are given below:

#### SPECIFIC GRAVITY.

The addition of a heavier substance, such as tar to creosote will, of course, increase the average specific gravity of the solution. This



increase in gravity appears to be a straight-line relation depending upon the gravity of the oil, the gravity of the tar, and the proportion of each in the mixture. The gravity of any solution may, therefore, be calculated from the gravity of its two components by the following formula: Specific gravity solution = per cent tar (specific gravity tar) + per cent creosote (specific gravity creosote). Figure 38 shows the change in specific gravity of a creosote with the addition of various amounts of a tar. The curve is drawn from the equation: the points are from experimental data.

## COEFFICIENT OF EXPANSION.

No data are available on the coefficient of expansion of tar solutions; but it would seem probable that the factor could be calculated from the known values for the change in the specific gravities of creosote and tar, respectively, on the assumption that the factor will be in direct proportion to the percentages of each of the two components in the mixture. J. M. Weiss (15) has published the results of investigations on the coefficient of expansion of tars from various sources, and shows that the average coefficient of expansion from 60° F. to 140° F. varies from 0.00027 to 0.000375 per degree Fahrenheit, the former being for a tar having a specific gravity of 1.296 and the latter for a tar having a specific gravity of 1.073. If these data be recalculated to a change in specific gravity per degree Fahrenheit, the factor will vary between 0.00035 and 0.00040, with an average of 0.000375. If, then, this factor be taken for the change in specific gravity of tar, and the factor 0.00043 be taken for the change in the specific gravity of creosote oil, the factors shown in Table 31 will be the change in specific gravities of tar mixtures, and should give results close enough to the true value for all commercial purposes.

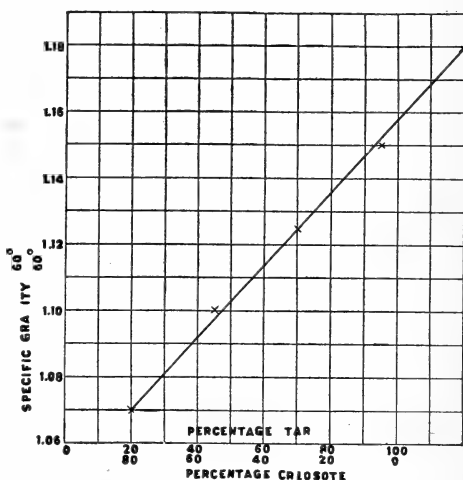

FIG. 38.—The change in specific gravity of tar solution.

TABLE 31.—*Change in specific gravity of different mixtures of tar and coal-tar creosote.*

Mixture contains—		Change in specific gravity per degree Fahrenheit.
Tar.	Creosote.	
<i>Per cent.</i>	<i>Per cent.</i>	
10	90	0.00042
20	80	.00042
30	70	.00041
40	60	.00041
50	50	.00040

## VOLATILITY.

The question has been raised whether or not evaporation can be partially prevented by the addition of some such nonvolatile material as tar, the tar having some sort of binding or holding property which would prevent the creosote from evaporating as rapidly as if it were used alone. In one of their papers, Von Schrenk and Kammerer (25) give a number of curves showing the loss by evaporation of creosote, tar, and creosote-tar mixtures. The tests extended over a long period of time, namely, 1,000 days, or nearly 3 years. The curves show that the tar is less volatile than the creosote-tar mixtures, and that the latter are less volatile than the creosote. If, however, the results are plotted in the same way as those of the creosote test (fig. 31), the same relation between volatility and percentage of distillate up to 270° C. will be shown. Furthermore, the volatility of the creosote-tar mixture can be calculated from the known volatility of the creosote and tar. The calculation is extremely simple and consists in multiplying the volatility of each constituent by the percentage used in the mixture and taking the sum of the two products as the volatility of the mixtures. Calculations made in this manner show the results given in Table 32.

TABLE 32.—*Comparison of actual and calculated losses due to evaporation of tar and coal-tar creosote mixtures.*

Loss of creosote.	Loss of tar.	Tar mixtures.	Calculated loss of mixtures.	Actual loss.
<i>Per cent.</i>	<i>Per cent.</i>	<i>Per cent.</i>	<i>Per cent.</i>	<i>Per cent.</i>
48.8	9.5	70 p. ct. C., 30 p. ct. T.	37.0	38.0
46.2	9.0	80 p. ct. 20 p. ct.	38.8	40.4
46.2	9.0	70 p. ct. 30 p. ct.	35.0	37.8
65.0	6.0	80 p. ct. 20 p. ct.	53.2	51.8
50.8	5.6	80 p. ct. 20 p. ct.	41.8	41.8
59.6	10.9	80 p. ct. 20 p. ct.	49.8	48.6

Table 32 shows that the actual loss and the calculated loss are practically identical. In other words, the effect of the tar is simply to reduce the quantity of creosote in the test, and the percentage

loss is based on an increased weight resulting from the addition of tar. The same general conclusion that the volatility of the creosote itself is practically not affected by the addition of the tar has been reached by Fredendoll (42) with respect to high-boiling petroleum oils.

#### VISCOSITY.

The addition of tar to coal-tar creosote of course increases the viscosity. The increase is not, however, in direct proportion to the amount of tar added. Up to about 50 per cent of tar the increase is relatively small, but beyond that point the viscosity increases very rapidly. Figure 39 shows the effect upon the viscosity of adding

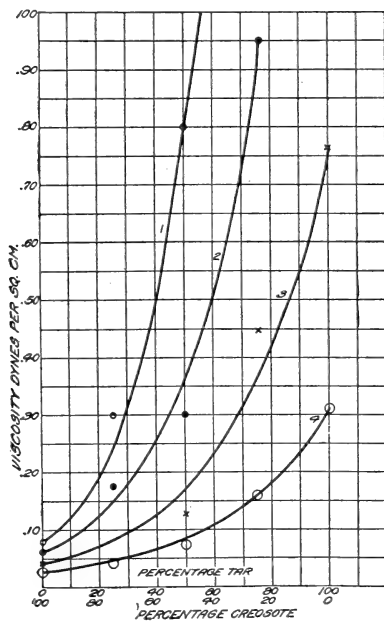

FIG. 39.—Change in viscosity of tar solutions with different amounts of tar at various temperatures.

1—At 40° C. 2—At 50° C. 3—At 70° C.  
4—At 90° C.

tar to creosote at different temperatures. The viscosity of any solution of coal tar and creosote may be calculated from the viscosity of the tar and the viscosity of the creosote at the same temperature by the aid of the formula  $V_m = \left( \frac{P}{V_t} \right) (V_c^{1-P})$ , where  $V_m$  = viscosity of the solution,  $V_t$  = viscosity of the tar,  $V_c$  = viscosity of the creosote,  $P$  = percentage tar used expressed as a decimal.

In figure 39 the value of a 50 per cent solution of tar and creosote at 90° C. is obtained from the equation  $V_c = (0.31^{0.5}) (0.025^{0.5})$ .

## CHAPTER VII. A THEORY OF THE MECHANISM OF THE PROTECTION OF WOOD BY OIL SOLUTIONS.

The author has recently proposed a theory of the mechanism of the protection of wood by preservatives, which is based on the two ideas, first, that any material in order to be toxic must be soluble in the body fluids of the organism it is intended to inhibit, and second, that, as the body fluids of timber-destroying organisms are chiefly water, the material must be soluble in water, at least sufficiently so to produce a solution of lethal concentration. For the purposes of this theory all the constituents of creosote oil may be divided into two classes. The first class comprises those materials that are sufficiently soluble in water to render them poisonous. These may be called toxic oils. They may be hydrocarbons, such as benzene, toluene, xylene, naphthalene, etc.; or tar acids, such as cresols, naphthols, etc.; or tar bases, such as quinoline, isoquinoline, etc.; or a combination of all three. Their chief characteristic is that they are sufficiently soluble in water to render their water solution capable of killing the wood-destroying organism. The second class of compounds comprises those that are not sufficiently soluble to render their water solutions toxic. This class of oils may be composed of the same types of compounds as those previously enumerated, and these oils differ from those of the other class only in their relative solubility. They may even be soluble to a slight extent, and in all probability they are. This class may be called nontoxic oils.

The toxic oils are completely soluble in the nontoxic oils and are partially soluble in water. When creosote comes in contact with water, these toxic oils will so divide themselves between the water and the nontoxic oils that their concentrations in water and in the nontoxic oil will be nearly in proportion to their solubility in the two mediums. This is known as the solubility partition. For the sake of argument, a toxic oil may be assumed which is fifty times as soluble in the nontoxic oil as it is in water, and it may be assumed that a 10 per cent solution of this toxic oil is used in the nontoxic oil. When such a solution comes in contact with an equal volume of water, the concentration of the water solution will be 0.2 per cent. If now the toxic limit of this water solution is only 0.05 per cent, then the water solution will be four times as toxic as is necessary to kill. It may be assumed that this water is now withdrawn and an equal amount added, which in turn takes up its proportion of toxic oil and is rendered poisonous. This change of water can take place seventy times

before the concentration of the water is below the killing point, and even then the water solution would still be very poisonous, though not sufficiently strong to kill, for at least 30 more changes of water.

In actual practice this change may take place either rapidly or slowly, depending upon the location of the treated timber. If the timber is alternately exposed to wetting and drying, as is true of piling between high and low tide, a very high rate of solution with rapid depletion of the preservative material would be expected. In timber located in dry places, as, for instance, telephone poles, a very much slower rate of solution would be expected. The idea here is simply that one part of the creosote oil prevents the rapid solution of the other part of the creosote oil which is toxic and which acts as the preservative.

The information in support of this theory is as yet incomplete in respect to creosote oil; but what information there is confirms the theory. Historically, perhaps the first data available on the solubility partition was furnished by Boulton in the Appendix of his *Antiseptic Treatment of Timber*, in which he showed that tar acids could be washed out of creosote by water. This, of course, is true, and according to the theory here proposed it is necessary if protection is to be afforded by tar acids. Boulton does not, however, make a point of showing that, although he used only 20 ounces of oil, it required 32 washings and the use of three times as much water as oil, or a total of 1,920 ounces, to reduce the tar-acid content of the oil from 10 per cent to 1.5 per cent in one case, and from 17.5 per cent to 3.5 per cent in the other case. In other words, he used 96 times as much water as he did oil, and even then he did not remove all of the tar acids. The attack of the teredo on treated piling after long service, during which the creosote acted as a preservative, is certainly a sure indication that the action of the water had dissolved out certain portions of the oil that were toxic. If this had not been so, the teredo would have begun its attack immediately. The very fact that creosote oil protected for a time and then failed to protect is sufficient indication that the toxic element had been removed.

A better proof of the theory is shown by some recent investigations at the Forest Products Laboratory. In the course of a certain study it was necessary to extract the creosote from a few telephone poles that had been in service about 20 years. One of these poles was so checked at the ground line as to permit the entrance of fungi, and the entire center of the pole at the ground line was completely decayed. None of the wood that contained creosote was decayed; in fact, it was very noticeable that there was a ring of from one-fourth to one-half inch in the untreated wood just inside the treated portion which was in a perfectly sound condition. This ring of

wood had been preserved from the fungus attack in some way or other, although it apparently contained no creosote. Sections of this untreated but preserved wood were taken, and any portions that showed signs of containing creosote were carefully removed. The remainder of the wood was then reduced to sawdust. A portion of this was extracted with water in a Soxhlet extractor in such a way as to retain the tar acids, if any were present, in the water. Another portion treated in the same manner was extracted, but in such a way as to retain the tar bases, if any were present. The solutions thus obtained, upon being neutralized, gave odors similar to those obtained from tar acids in the one case and from tar bases in the other. A second extraction with benzol of the wood previously extracted with water gave a residue of perfectly clear rosin, in which there was not the least sign of creosote odor. From this it seems apparent that this inner ring of untreated material had been preserved by the water-soluble material that came from the creosote and had been diffused through the wood. On the other hand, from coal-tar creosote a high-boiling oil has been isolated, which is probably a mixture of anthracene, phenanthrene, acenaphthene, and their hydrides. This oil is practically nontoxic, for fungus grows on agar agar containing 20 per cent of the oil.

The theory assumes that any toxic material which is more soluble in oil than it is in water will be less toxic at the start if oil is present than it would be in its absence. That is, if it takes 0.05 per cent of some material in water alone to kill an organism, it might take as much as 2 per cent if the material were dissolved in oil. On the other hand, any reserve material would not be removed so rapidly by leaching in the presence of oil as in its absence. Under similar conditions the speed at which creosote will be rendered nontoxic by leaching will depend on two things—the relative solubility of the toxic oils in the nontoxic oils and in water and the proportion of nontoxic oils present. If too little of the nontoxic oils is present, then the toxic material will be washed away very rapidly, because there would be little or no retaining influence exerted by the nontoxic oils. On the other hand, if there is too large an amount of nontoxic oil, the toxic oils will be prevented from going into solution in the water in a sufficient concentration to kill the attacking organism, and consequently these oils would not act as preservative.

## PART IV. METHODS OF TESTING CREOSOTES AND OFFICIAL SPECIFICATIONS FOR CREOSOTE.

### CHAPTER I. PRACTICAL METHODS OF TESTING CREOSOTES.

A number of tests have been proposed for creosote which, in general, are of considerable service when materials of known source are to be examined. The tests fail, however, if an attempt is made to determine whether the creosote under test meets the requirements for purity. The following tests have been proposed and used.

#### SPECIFIC-GRAVITY TEST.

Practically all specifications for creosote require that it shall have a certain range of specific gravity; sometimes it is stated that the specific gravity shall not be less than 1.03 or more than 1.08, and sometimes that it shall not be less than 1.03. The specific-gravity determination is effective only when straight, distilled oils are used. Water-gas-tar oils have practically the same range. An oil of low specific gravity may be made to pass the specifications for coal-tar creosote by the addition of tar. This would also raise the distillation limits. The specific-gravity test, although it is an exceedingly useful one when used with creosotes of known origin, does not identify the oil or exclude tar. Any approved method of determining specific gravity will answer. An ordinary hydrometer is generally used. The dimensions of the hydrometer and cylinder, and the details of the test adopted as standard by the American Society for Testing Materials, the American Railway Engi-

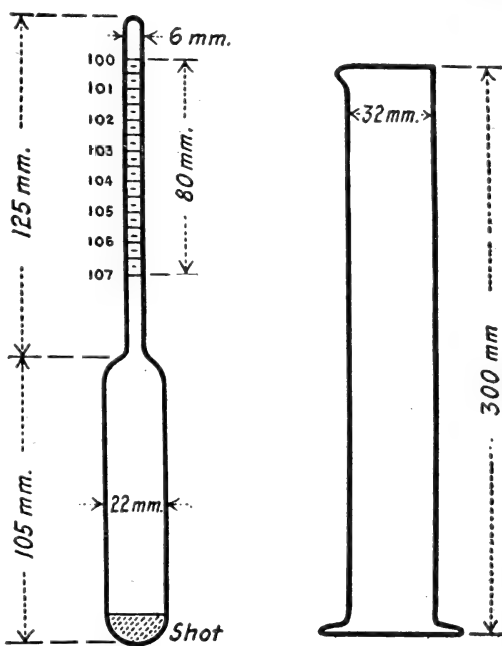

FIG. 40.—Hydrometer and cylinder used for specific-gravity test.

neering Association, and the American Wood Preservers' Association are as follows:

#### SPECIFIC GRAVITY.

(a) *Hydrometer*.—The hydrometer shall be of the form shown in figure 40. It shall have the following dimensions:

Length of stem.....	125 mm.; permissible variation.....	12.5 mm.
Length of bulb.....	105 mm.; permissible variation.....	10.5 mm.
Length of scale.....	80 mm.; permissible variation.....	8.0 mm.
Diameter of stem.....	6 mm.; permissible variation.....	0.5 mm.
Diameter of bulb.....	22 mm.; permissible variation.....	2.0 mm.

A set of two hydrometers with ranges 1.00 to 1.08 and 1.07 to 1.15 will suffice.

(b) *Cylinder*.—The cylinder shall be of the form shown in figure 40. It shall have the following dimensions:

Length.....	300 mm.; permissible variation.....	30 mm.
Diameter.....	32 mm.; permissible variation.....	3 mm.

The oil shall be brought to a temperature of 38° C. (100° F.), and the determination shall be made at the temperature unless the oil is not entirely liquid at 38° C. In case the oil requires to be brought to a higher temperature than 38° C. in order to render it completely fluid, it shall be tested at the lowest temperature at which it is completely fluid, and a correction made by adding 0.0008 to the observed specific gravity for each degree centigrade above 38° C. at which the test is made. This correction factor does not apply with equal accuracy to all oils, but serious error due to its use will be avoided if the foregoing precaution is observed with respect to avoiding unnecessarily high temperature. Before taking the specific gravity the oil in the cylinder should be stirred thoroughly with a glass rod, and this rod when withdrawn from the liquid should show no solid particles at the instant of withdrawal. Care should be taken that the hydrometer does not touch the sides or bottom of the cylinder when the reading is taken, and that the oil surface is free from froth and bubbles.

#### FREE-CARBON TEST.

The determination of free carbon or insoluble matter was supposed to be a measure of the amount of tar that might be present. When tar was obtained chiefly from gas houses this test did, in a rough way, give an indication of the amount of coal tar present in creosote. If 5 per cent of the tar containing 20 per cent of the free carbon were mixed with a pure distilled creosote, then the mixture would contain about 1 per cent of free carbon. In modern coke-oven practice tars may run as low as 4 per cent free carbon. Twenty-five per cent of such tar could be mixed with creosote and the mixture would still have only 1 per cent of free carbon. Furthermore, water-gas tar containing no free carbon could be added in any proportion without being identified by the free-carbon test.

The free-carbon test has been conducted by a number of different methods. In general it depends on the solubility of the oils in some



such substances as carbon bisulphide, chloroform, benzol, or toluol. Different results are obtained by the use of different solvents because the hydrocarbons of creosote or tar are not uniformly soluble in these solvents. This is particularly true of the bitumens in the pitches.

J. M. Weiss has conducted a number of tests on tar with different solvents. His method of procedure was to allow tar to digest with cold solvent for a number of hours and then to filter off the undissolved portion and extract it with the boiling solvent. When benzol,

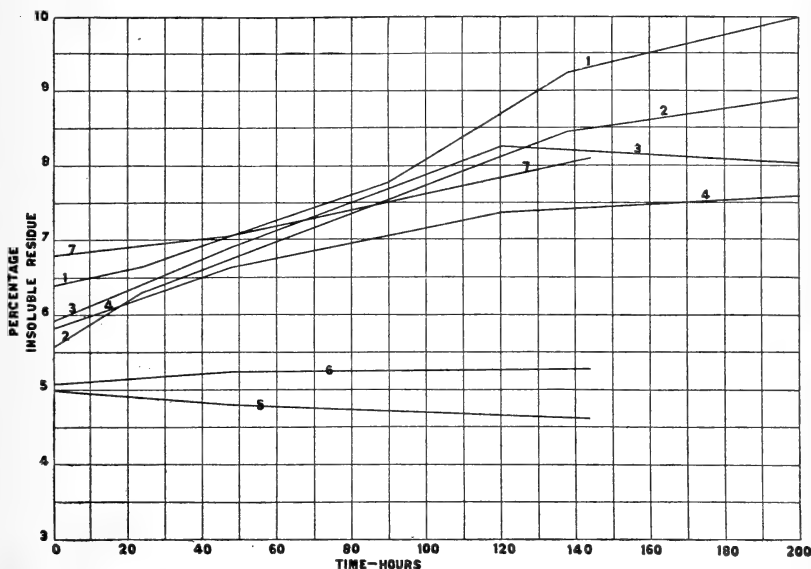

FIG. 41.—Change in apparent free-carbon content of a tar with change in time of digestion with different solvents.

- |                                    |                                      |
|------------------------------------|--------------------------------------|
| 1. Insoluble in benzol.            | 5. Insoluble in aniline.             |
| 2. Insoluble in benzol and toluol. | 6. Insoluble in pyridine.            |
| 3. Insoluble in chloroform.        | 7. Insoluble in glacial acetic acid. |
| 4. Insoluble in carbon bisulphide. |                                      |

benzol and toluol, chloroform, or carbon bisulphide was used as the cold extractive the same material served as the hot extractive; but when he used aniline, pyridine, or glacial acetic acid as a cold extractive he followed them with benzol as a hot extractive. The data obtained have been plotted in figure 41. From these curves it is apparent that the insoluble matter in this tar after one-half hour's digestion varied from 5 to 6.6 per cent, but that after 144 hours' digestion it varied from 4.6 to 9.3 per cent. With the exception of

the method in which glacial acetic acid was employed, that in which benzol was used as a solvent gave the highest results. All the solvents except aniline gave higher results with longer digestions. With the use of aniline the insoluble matter decreased from 5 per cent after one-half hour to 4.6 per cent after 144 hours, and this was the lowest result obtained.

Weiss further showed that the insoluble residue, after digestion with chloroform, contained noticeable amounts of chlorine. Sulphur was also found in the residue resulting from the digestion with carbon bisulphide.

Monroe and Broderson (45) investigated the action of benzol and chloroform on the free-carbon content of three classes of tar. The results of their work are plotted in figure 42. Here again they found

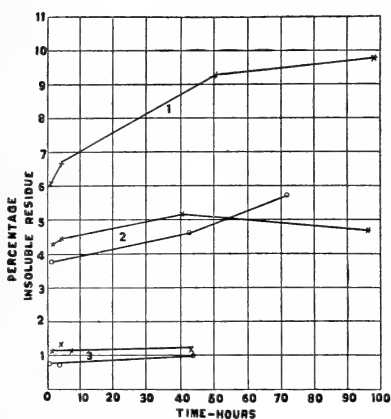

FIG. 42.—Change in apparent free carbon content of tars with change in time of digestion.

Numbers represent tars No. 1, 2, and 3.

X. Extractions made with benzol.

O. Extractions made with chloroform.

that benzol yields a greater insoluble residue than does chloroform, notwithstanding the fact that considerable quantities of chlorine were found in the residue. This amount increased with the time of digestion.

From the above it is apparent that, if this test is designed to determine the free carbon in tars, a digestion with aniline would give the more nearly correct result. But if a purely empirical determination is all that is desired, then any one of the solvents is satisfactory provided that the test is made standard and the conditions of the test are defined and rigidly adhered to.

The method adopted as standard by the American Society for Testing Materials, the American Railway Engineering Association, and the American Wood Preservers' Association is as follows:

*Apparatus.*—(A) Extractor may be of the form shown in figure 43 or similar form in which the oil is subjected to direct washing by the boiling vapors of the solvent.

(B) Filtering medium may be either two thicknesses of S. and S. No. 575 or Whatman No. 5 hardened filter paper, 15 cm. in diameter, arranged in cup shape by folding symmetrically; or alundum thimbles, flat bottom, 30×80 RA 98. If filter papers are used they shall be soaked in benzol prior to using to remove grease, dried in a steam oven, and kept in a desiccator until ready to be used. The filter-paper cup may be suspended in the extractor flask by a wire basket hung from two small hooks on the under surface of the metal cover of the flask.

If the alundum thimble is used it may be supported by making two perforations in the top of the thimble and suspending from the cover by German silver or platinum wires.

*Method.*—Weigh 10 grams of dry creosote in 100 cc. beaker. Add about 50 cc. of pure benzol and transfer at once to the filter cup. The filter cup or thimble is previously weighed, and the paper cup shall always be kept in a weighing bottle until ready for use. Wash out the beaker with benzol, passing all washings through the filter cup and place the latter at once in the extraction apparatus.

Extractor shall contain a suitable quantity of pure benzol. Sufficient heat to boil the solvent shall be provided by means of an electric heater or a steam bath.

Continue the extraction until the descending solvent is practically colorless and remove the filter cup and dry in steam oven until all solvent is driven off; cool in desiccator and weigh. The balance used for this purpose should be accurate to 0.5 mg.

#### DAVIS SPOT TEST.

T. H. Davis (46), in 1909, proposed a test, which he called the spot test, for the preliminary testing of creosote oil for free carbon. This test has been used for a long time by distillers, and consists in placing 6 drops of the oil on blotting paper and noting the character of the spots which remain. If free carbon is present it will manifest itself by a ring of free carbon the same size as the spot, but the oil will spread out into a ring 1 to 2 or 2½ inches in diameter. This test is exceedingly delicate and shows the presence of very minute quantities of carbon; for this reason it is of small value for determining the amount of free carbon in creosotes. It will, however,

show whether the regular free-carbon determinations should be made, and is of value as a preliminary test for this purpose. The test itself has not been given by creosote chemists the attention it deserves. H. Cloukey (47) shows that the test may be applied for a preliminary examination and will give a good indication to the analyst of what he may expect to find in the creosote under examination. When the color, character, and size of the spot are taken into consideration remarkable approximations may be made, provided a large number of authentic spots are available. Pure coal-tar creosote, pure water-gas-tar creosote, coal tar, water-gas tar, wood tar, wood-tar creosote, and petroleum oils all give spots that are characteristic of themselves and different from the others. Mixtures of creosote with tars also give characteristic spots.

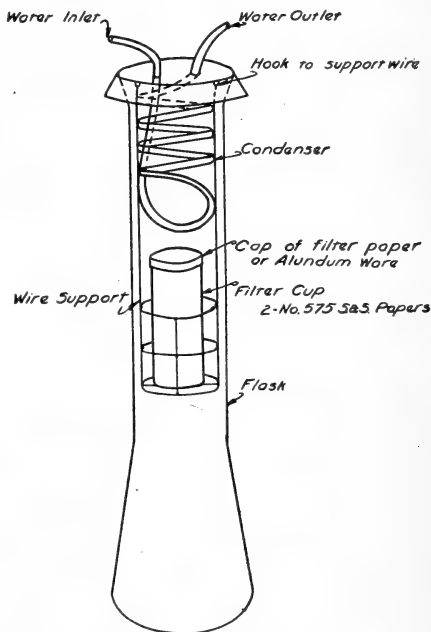

FIG. 43.—Type of extractor recommended for "free carbon" test.

## COKE TEST.

The coke test was proposed by the National Electric Light Association (48) for the determination of the amount of admixed tar, and was later adopted by the American Wood Preservers' Association and the American Society for Testing Materials. It depends upon the amount of coke residue left after all the volatile matter has been driven off. The coke residue in itself gives only a rough approximation of the amount of tar that has been added, for the coke residues of coal tars may vary anywhere from 26 to 57 per cent, while those of water-gas tars vary from 18 to 28 per cent. As usually applied, this test favors the use of water-gas tar in tar solutions in preference to coal tar. If, however, the free-carbon content (matter insoluble in benzine) is subtracted from the coke residue the resulting figure, which may be termed the "bituminous-coke residue," is fairly constant for both water-gas tar and coal tar, as is shown in Table 33.

TABLE 33.—Free-carbon content, coke residues, and bituminous-coke residues of various tars (49).

Kind of tar.	Tar No.	Free-carbon content.	Coke residue.	Bituminous-coke residue.
		<i>Per cent.</i>	<i>Per cent.</i>	<i>Per cent.</i>
High or medium free-carbon tar.....	1	37.1	57.2	20.1
	2	18.6	43.5	24.9
	3	16.2	42.9	26.7
	4	15.4	34.4	19.0
Low-carbon coal tar.....	5	7.6	26.8	19.2
	6	6.7	27.0	20.3
	7	5.4	28.4	23.0
	8	5.2	30.6	25.4
	9	4.4	29.4	25.0
Water-gas tar.....	10	1.3	25.3	24.0
	11	1.1	28.1	27.0
	12	.1	23.2	23.1
	13	.....	18.2	18.2

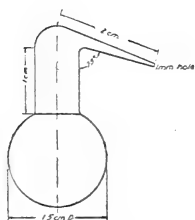

FIG. 44.—Bulb used in making coke test.

The method of conducting the coke test, as recommended by the three societies, is as follows:

The bulb shall be of hard glass, as shown in figure 44, and shall have the following approximate dimensions:

	Mm.
Diameter of bulb.....	15
Length of vertical neck.....	10
Length of horizontal neck.....	20
Diameter of orifice.....	1

Warm the bulb slightly to drive off all moisture, cool in a desiccator, and weigh. Again heat the bulb by placing it momentarily in an open Bunsen flame, and place the tubular underneath the surface of the oil to be tested, and allow the bulb to cool until sufficient oil is sucked in to fill the bulb about two-thirds full.

Any globules of oil sticking to the inside of the tubular should be drawn into the bulb by shaking or expelled by slightly heating it, and the outer surface should be

carefully wiped off and the bulb reweighed. This procedure will give about 1 g. of oil.

Cut a strip of thin asbestos paper about one-fourth inch wide and about 1 inch long, place it around the neck of the bulb, and catch the two free ends close up to the neck with a pair of crucible tongs. The oil should then be distilled off as in making ordinary oil distillation, starting with a very low flame and conducting the distillation as fast as can be maintained without spurting.

When oil ceases to come over, the heat should be increased until the highest temperature of the Bunsen flame is attained, the whole bulb being heated red hot until evolution of gas ceases, and any carbon sticking to the outside of the tubular is completely burned off. The bulb should then be cooled in a desiccator and weighed and the percentage of coke residue calculated to water-free oil.

#### DISTILLATION TEST.

This test has been used nearly as long as specifications have been written for creosote. It is without value for the determination of the source of the oil, because coal-tar creosote, water-gas-tar creosote, blast-furnace oil, certain crude petroleums, shale oils, candle oils, acid residues, and certain others have practically the same range of boiling points. The only value of the distillation test alone is to determine whether an oil of known source meets the requirements of the specification so far as boiling points are concerned. The type of distilling vessel has a considerable influence on the percentage of distillate obtained in any fraction from a given creosote. Because of the exceeding complexity of the mixture, no single distillation can secure an absolutely true apportionment of the oil, no matter how refined the apparatus may be. Therefore, to get concordant results from different operators, it is necessary that the standard form of the distilling vessel should be accurately fixed, that the position of the thermometer should always be the same, that the rate of distillation should be uniform, and that thermometers having practically the same dimensions should be used. The types of vessel that have been proposed for this test are the 8-ounce retort, the ordinary distilling flask, the Lunge trap flask, and the Hempel flask. The first three are used for ordinary commercial work and the last for a more refined test. The first three, when used under standard conditions, will give practically the same average results. The choice of one of the three vessels for such an empirical operation as the distillation test rests, therefore, on the ability of the apparatus to duplicate results. The ability to do this depends on the exact reproduction of the form, shape, and size of the apparatus. As the retorts are blown by hand in the form of a long pear-shaped glass and then bent down in a flame, the shapes and sizes can not be kept uniform. As a result, a so-called 8-ounce retort may hold anywhere from 4 to 12 ounces, depending on the carefulness of the assortment. On the other hand, as flasks of glass are now blown in a mold, the shapes and sizes are practically uniform. One would, for this reason,

expect the flasks to give more concordant results than the retorts, and this, in general, is true.

The Forest Products Laboratory has shown (50) that, although there is no practical difference between the average numerical results obtained by the use of the flask and retort, the flask gives a somewhat sharper separation than the retort and is therefore to be preferred to the retort.

The argument advanced in favor of the retort is that it has been used up to this time and should be continued. The argument against it is that it does not give as concordant results as the flask, and that the flask gives practically the same numerical value. Two associations—the National Electric Light Association (51) and the American Railway Engineering Association (52)—have made tests on the comparative checking value of the flask and the retort. The data obtained by them are published in their proceedings. A careful survey of these data shows that, after the elimination of what are evidently experimental errors, the ordinary flask is superior to the retort in checking value.

#### OFFICIAL SPECIFICATIONS OF FOUR SOCIETIES.

The specifications for the distillation tests adopted as standard by the American Wood Preservers' Association (1917), the American Railway Engineering Association (1917), the American Society for Testing Materials (1918), and the National Electric Light Association (1921), are as follows:

*Retort.*—This shall be a tubulated glass retort of the form and approximate dimensions shown in figure 45 with a capacity of 250 to 290 c. c. The capacity shall be measured by placing the retort with the bottom of the bulb and the end of the off-take in the same horizontal plane, and pouring water into the bulb through the tubulature until it overflows the offtake. The amount remaining in the bulb shall be considered its capacity.

*Condenser tube.*—The condenser tube shall be a suitable form of tapered glass tubing of the following dimensions:

Diameter of small end.....	12.5 mm.; permissible variation.....	1.5 mm.
Diameter of large end.....	28.5 mm.; permissible variation.....	3.0 mm.
Length.....	360.0 mm.; permissible variation.....	4.0 mm.

*Shield.*—An asbestos shield of the form shown in figure 45 shall be used to protect the retort from air currents and to prevent radiation. This may be covered with galvanized iron, as such an arrangement is more convenient and more permanent.

*Receivers.*—Erlenmeyer flasks of 50 to 100 c. c. capacity are the most convenient form.

*Thermometer.*—The thermometer shall conform to the following requirements: The thermometer shall be made of thermometric glass of a quality equivalent to suitable grades of Jena or Corning make. It shall be thoroughly annealed. It shall be filled above the mercury with inert gas which will not act chemically on or contaminate the mercury. The pressure of the gas shall be sufficient to prevent separation of the mercury column at all temperatures of the scale. There shall be a reservoir

above the final graduation large enough so that the pressure will not become excessive at the highest temperature. The thermometer shall be finished at the top with a small glass ring or button suitable for attaching a tag. Each thermometer shall have for identification the maker's name, a serial number, and the letters "A. S. T. M. distillation."

The thermometer shall be graduated from 0 to 400° C. at intervals of 1° C. Every fifth graduation shall be longer than the intermediate ones, and every tenth graduation beginning at zero shall be numbered. The graduation marks and number shall be clear-cut and distinct.

The thermometer shall conform to the following dimensions:

Total length, maximum.....	385	mm.
Diameter of stem.....	7	mm.; permissible variation..... 0.5 mm.
Diameter of bulb, minimum.....	5	mm.; and shall not exceed diameter of stem.
Length of bulb.....	12.5	mm.; permissible variation..... 2.5 mm.
Distance, 0° to bottom of bulb...	30	mm.; permissible variation..... 5 mm.
Distance, 0° to 400°.....	295	mm.; permissible variation..... 10 mm.

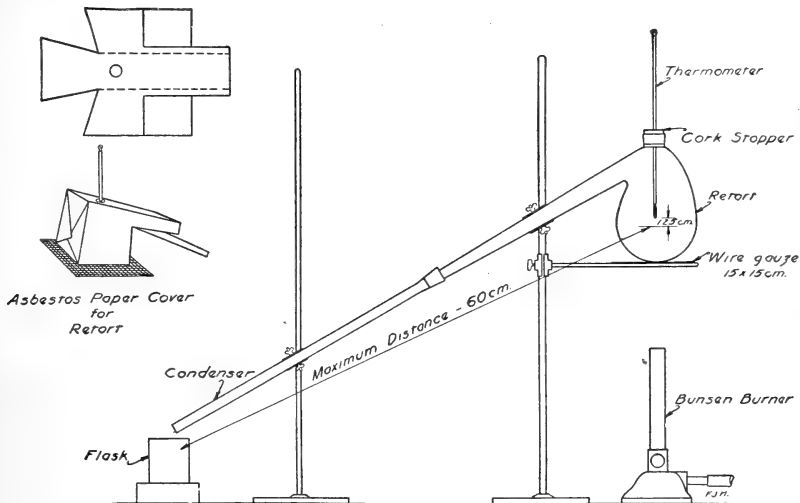

FIG. 45.—Arrangement of distilling apparatus recommended by American Wood Preservers' Association, American Railway Engineering Association, and American Society for Testing Materials.

The accuracy of the thermometer when delivered to the purchaser shall be such that when tested at full immersion the maximum error shall not exceed the following:

	°C.
From 0° to 200° C.....	0.5
From 200° to 300° C.....	1.0
From 300° to 375° C.....	1.5

The sensitiveness of the thermometer shall be such that when cooled to a temperature of 74° C. below the boiling point of water, at the barometric pressure at the time of test and plunged into free flow of steam, the meniscus shall pass the point 10° C. below the boiling point of water in not more than six seconds.

The retort shall be supported on a tripod or rings over two sheets of 20-mesh gauze, 6 inches square. It shall be connected to the condenser tube by a tight cork joint. The thermometer shall be inserted through a cork in the tubulature with the bottom

of the bulb one-half inch from the surface of the oil in the retort. The exact location of the thermometer bulb shall be determined by placing a vertical rule graduated in divisions not exceeding one-sixteenth inch back of the retort when the latter is in position for the test, and sighting the level of the liquid and the point for the bottom of the thermometer bulb. The distance from the bulb of the thermometer to the outlet end of the condenser tube shall be not more than 24 or less than 20 inches. The burner should be protected from drafts by a suitable shield or chimney.

Exactly 100 g. of oil shall be weighed into the retort, the apparatus assembled, and heat applied. The distillation shall be conducted at the rate of at least one drop and not more than two drops per second, and the distillate collected in weighed receivers. The condenser tube shall be warmed whenever necessary to prevent accumulation of solid distillates. Fractions shall be collected at the following points: 210°, 235°, 270°, 315°, and 355° C. The receivers shall be changed as the mercury passes the dividing temperature for each fraction. When the temperature reaches 355°, the flame shall be removed from the retort, and any oil which has condensed in the off-take shall be drained in the 355° fraction.

The residue shall remain in the retort with the cork and the thermometer in position until no vapors are visible; it shall then be weighed. If the residue is to be further tested, it shall then be poured directly into the brass collar used in the float test, or into a tin box, and covered and allowed to cool to air temperature. If the residue becomes so cool that it can not be poured readily from the retort, it shall be reheated by holding the bulb of the retort in hot water or steam, and not by the application of flame.

For weighing the receivers and fractions, a balance accurate to at least 0.05 g. shall be used.

During the progress of the distillation the thermometer shall remain in its original position. No correction shall be made for the emergent stem of the thermometer.

When any measurable amount of water is present in the distillate it shall be separated as nearly as possible and reported separately, all results being calculated on a basis of dry oil. When more than 2 per cent of water is present, water-free oil shall be obtained by separately distilling a larger quantity of oil, returning to the oil any oil carried over with the water, and using dried oil for the final distillation.

A more refined test, in which the Hempel flask is used, is given in Part II.

#### MOISTURE IN CREOSOTE TEST.

It sometimes happens that it is necessary to make a determination of the moistures in creosote. If the moisture content is small (less than 2 per cent), this can readily be done in conjunction with the distillation test. If, however, the water exceeds 2 per cent, or if there is difficulty in carrying out the distillation test on account of the spattering, the following method should be used. It has been adopted as standard by the American Wood Preservers' Association, the American Railway Engineering Association, and the American Society for Testing Materials.

#### WATER.

*Still.*—A vertical, cylindrical copper still with removable flanged top and yoke of the form and approximate dimensions shown in figure 46 shall be used.

*Thermometer.*—The standard distillation thermometer as specified under "Distillation," shall be used.



*Condenser.*—A copper trough condenser shall be used with straight-walled glass tube, having approximately the form and dimensions shown in figure 46.

*Separatory funnel.*—A separatory funnel of the form shown in figure 46 shall be used, having a total capacity of 120 c.c., and the outlet graduated in fifths of a cubic centimeter.

The apparatus shall be set up as shown in the figure.

When any measurable amount of water is present in the distillate below 210° C. on testing in accordance with the distillation, the oil and water in this fraction shall be separated, if possible, and measured separately. If more than 2 per cent of water is present, or if the water is apparently present to an extent in excess of 2 per cent, but an accurate separation is impossible, the percentage of water present shall be determined by the following method, and the water-free oil so obtained shall be used in the distillation test:

Measure 200 c.c. of oil in graduated cylinder, and pour into copper still, allowing the cylinder to drain into the still for several minutes. Attach lid and clamp, using

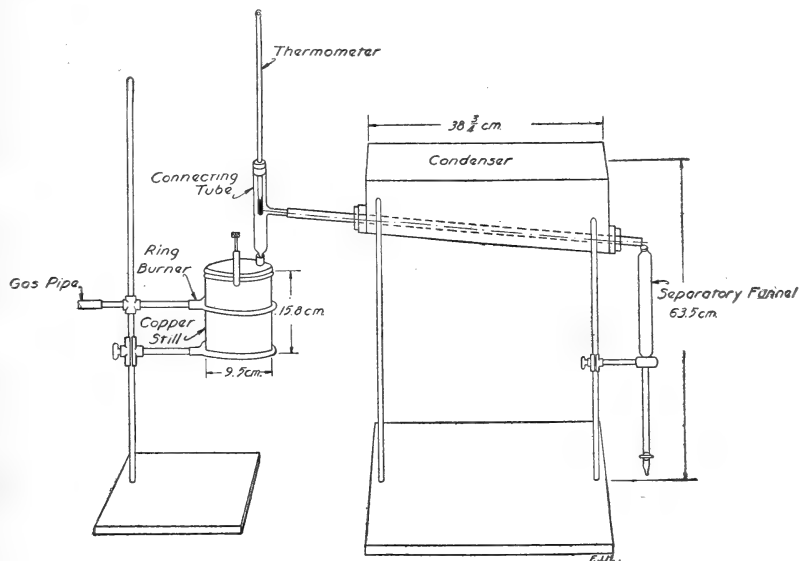

FIG. 46.—Apparatus for determining moisture content of cerosote oil.

a paper gasket slightly wet with oil around the flange of the still. Apply heat by means of the ring burner, which shall be placed just above the level of the oil in the still at the beginning of the test, and gradually lowered when most of the water has distilled over. Continue the distillation until the vapor temperature, indicated by the thermometer with the bulb opposite the offtake of the connecting tube, reaches 205° C. Collect distillate in separatory funnel. When the distillation is completed, and a clear separation of water and oil in the funnel has taken place, read the water by volume and draw off; and return any light oil distilled over with the water to the oil in the still. The dehydrated oil from the still shall be used for the distillation test.

#### TEST OF THE SPECIFIC GRAVITY OF THE FRACTIONS.

The test of the specific gravity of the fractions has been adopted by the American Wood Preservers' Association, the American Society for Testing Materials, and the American Railway Engineering Association. Tests that may be applied to the fractions obtained in the

distillation of creosote are much more likely to eliminate admixtures than tests performed on the whole sample. Therefore, too much importance can not be attributed to this test. The specific gravity of the fractions, according to the latest specifications, is taken at 38° C. and referred to water at 15° C. In general, the same result would be obtained by determining the specific gravity at 60° C. and referring to water at 60° C. The data on specific gravity and index of refraction given in the part of this bulletin describing the experimental comparison of creosotes were all taken at 60° C., and referred to water at the same temperature. The present specifications require the specific gravity of two large portions 235° to 315° C. and 315° to 355° C.; and, whereas the results obtained by these two fractions seem to be very good, a closer control is obtained by the use of more fractions. On account of the fact that tars and creosotes having very different boiling points are sometimes mixed together, the failure of either fraction to fulfill the requirements of the specification should be sufficient cause for the rejection of the material under that specification.

The specific-gravity values of three pure coal-tar creosotes are given in Table 34.

TABLE 34.—*Specific gravities of fractions of three pure coal-tar creosotes.*

Type of creosote.	Fraction 235° to 315° C. Sp. gr. 38° 15'	Fraction 315° to 355° C. Sp. gr. 38° 15'
	High-gravity creosote.....	1.047
Average-gravity creosote.....	1.036	1.112
Low-gravity creosote..... (Very exceptional cases.)	1.025	1.108

The examples from the report of the Committee on Preservatives of the American Wood Preservers' Association, 1917, given in Table 35, show the necessity of requiring both specific gravities to conform to the specification.

TABLE 35.—*Specific gravities of fractions of mixtures of coal-tar creosote, coal tar, and water-gas tar.*

No.	Composition of mixture.			Fraction 235° to 315° C. Sp. gr. 38° 15'	Fraction 315° to 355° C. Sp. gr. 38° 15'	No.	Composition of mixture.			Fraction 235° to 315° C. Sp. gr. 38° 15'	Fraction 315° to 355° C. Sp. gr. 38° 15'
	Creosote.	Coal tar.	Water-gas tar.				Creosote.	Coal tar.	Water-gas tar.		
	<i>Per cent.</i>	<i>Per cent.</i>	<i>Per cent.</i>				<i>Per cent.</i>	<i>Per cent.</i>	<i>Per cent.</i>		
1	65	25	10	<sup>1</sup> 1.028	1.102	7	65	.....	35	1.042	1.120
2	90	.....	10	1.033	<sup>1</sup> 1.088	8	55	.....	45	1.038	1.112
3	65	20	15	1.031	<sup>1</sup> 1.090	9	65	20	15	1.041	1.112
4	65	20	15	1.033	<sup>1</sup> 1.085	10	65	10	25	1.038	1.106
5	60	25	15	<sup>1</sup> 1.028	1.101	11	65	.....	35	1.038	1.104
6	55	22.5	22.5	<sup>1</sup> 1.025	1.100						

<sup>1</sup> Indicates failure to pass specifications.

Out of 28 tar solutions whose content of water-gas tar ranged from 10 to 45 per cent, 16 were rejected because both fractions were low in gravity, and 7 because one fraction was low; 5 passed both tests. Of these last, 1 was eliminated on account of both float and coke tests, 1 failed to pass the float test, and 1 failed in the coke test; but 2 passed all tests. Of these last, 1 contained 65 per cent of creosote, 20 per cent of coal tar, and 15 per cent of water-gas tar; and the other contained 65 per cent of creosote and 35 per cent of water-gas tar.

The method of determining specific gravity of the fractions recommended by the American Society for Testing Materials, the American Wood Preservers' Association, and the American Railway Engineering Association is as follows:

As specific gravity is an absolute physical determination, any recognized method which can be applied to the quantity and quality of material at hand to be tested must be considered satisfactory. The following methods are convenient and accurate means for the relatively small amounts of oil available in determining specific gravity of fractions to be tested.

*Liquid fractions.*—The Westphal balance may be used. If the fraction to be tested is liquid at a temperature not exceeding 60° C., the Westphal balance can be used with convenience and rapidity. A special type of Westphal balance is obtainable, designed for testing very small quantities. However, the ordinary type of Westphal balance can be adapted to testing small fractions by the use of a special plummet. When using the ordinary balance with the special plummet, extra care is needed that the adjustment of the balance be accurately made. The plummet can readily be made in the laboratory from a piece of ordinary glass tubing 7 mm. outside diameter, sealed at the end, and by melting into the glass where sealed, a short platinum wire. After cooling, place 9 to 10 g. of mercury in the tube, making a column 35 to 40 mm. high. Seal off the tube within 20 mm. of the top of the mercury column with blow pipe flame. The plummet shall have a length of about 55 to 60 mm. over all, and shall weigh between 10 and 12 g.

*Solid and semi-solid fractions.*—A pan of the form shown in figure 47 having the following approximate dimensions, may be used:

Diameter of base.....	20 mm.
Diameter of top.....	25 mm.
Depth.....	12 mm.
Diameter of wire.....	1 mm.
Total weight.....	7 g.

The pan and wires are made of platinum or nickel.

Solid or semisolid fractions of oil which can not be readily liquified can be rapidly and accurately tested in this apparatus by the usual method of weighing in air and in

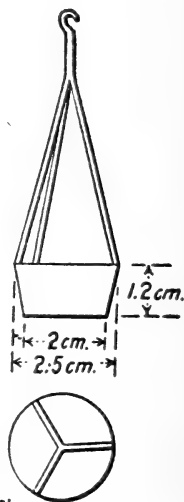

FIG. 47.—Pan used for determining specific gravity of solid or semi-solid fractions of creosotes.

water. The usual precautions of igniting the pan before use, and avoiding the enclosure of air or water in the sample, should be observed.

NOTE.—The method for liquid fractions is usually applicable to the fractions 235° to 315° C. and the method for solid and semisolid fractions to the fraction 315° to 355° C.

#### FLOAT TEST.

The float test is used for the detection and limitation of the amount of tar in creosote or creosote-tar solutions. It has been adopted by the American Wood Preservers' Association, the American Railway Engineering Association, and the American Society for Testing Materials. The apparatus consists of an asphalt viscosimeter made of a float or saucer of aluminum and two conical brass collars. In making the test a brass collar is filled with the residue left after distillation of the oil up to 355° C. It is then immersed in ice water for

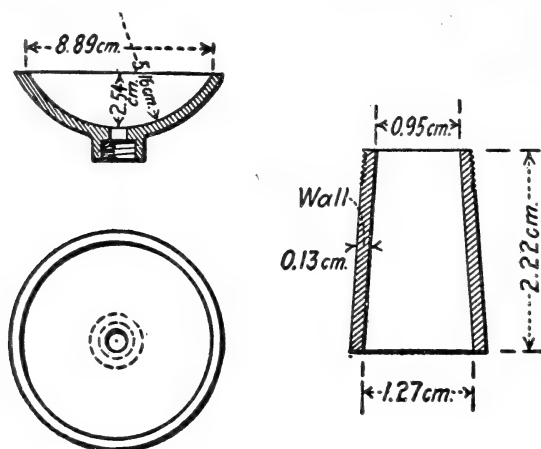

FIG. 48.—Apparatus used in float test.

a time sufficient to chill it thoroughly, after which it is fitted into the saucer and floated on water that is heated to the temperature of the test. The time in seconds, taken from the time the saucer is placed in the warm water to the time when it breaks through the plug of tar is a measure of the viscosity of the residue at the selected temperature and hence a measure of the amount of pitch or tar contained in the sample under test. This test can not be relied upon absolutely because of the variability in the amount of residue above 355° C. The chances are, however, that some other test, such as the free-carbon test, or the coke-residue test, or the test of the specific gravity of the fractions, would eliminate such oils, although in many cases 45 per cent or more of tar may be accepted under a specification permitting only 35 per cent.

The method of conducting the float test recommended by the three societies is as follows:

*Float or saucer.*—The float or saucer shall be made of aluminum, and shall be of the form and dimensions shown in figure 48.

*Conical collar.*—The conical collar shall be made of brass, and shall be of the form and dimensions shown in figure 48.

Place the brass collar with the small end on the brass plate, which has been previously amalgamated with mercury by first rubbing it with dilute solution of mercuric chloride or nitrate and then with mercury. Pour the residue to be tested into the collar direct from the retort, as described in the paragraph on "Distillation" or heat it in a tin box on water or steam bath, not by direct application of flame, and then pour into the collar in any convenient way until slightly more than level with the top. The surplus may be removed after the material has cooled to room temperature by means of spatula or steel knife which has been slightly heated. Then place the collar and plate in one of the tin cups containing ice water maintained at 5° C., and leave in this bath for at least 15 minutes.

Meanwhile, fill the other cup about three-fourths full of water and place on the tripod; heat the water to any desired temperature at which the test is to be made. This temperature should be accurately maintained, and should at no time throughout the entire test be allowed to vary more than 0.5° C. from the temperature specified.

After the material to be tested has been kept in the ice water for at least 15 minutes, and not more than 30 minutes, remove the collar with its contents from the plate and screw into the aluminum float, which is then immediately floated in the warmed bath. As the plug of residue becomes warm and fluid, it is forced upward and out of the collar until the water gains entrance to the saucer and causes it to sink.

The time in seconds between placing the apparatus on the water and when the water breaks through the residue shall be determined by means of a stop watch, and shall be taken as a measure of the consistency of the material under examination.

#### TAR-ACID CONTENT TEST.

Of late years the tar-acid test has not been applied to creosote to so great an extent as formerly. It can not be used for identification purposes, because tar acids may easily be added to products that do not contain them, and such adulterations can not now be detected. A mixture of 15 per cent of blast-furnace oil with 85 per cent of certain water-gas-tar creosotes will pass the tar-acid test, the specific-gravity test, and the distillation test for coal-tar creosotes.

The method of determining the tar acids adopted by the National Electric Light Association (51) is as follows:

One hundred cubic centimeters (100 c. c.) of the total distillate to three hundred and fifteen degrees (315° C.) to which forty cubic centimeters (40 c. c.) of a solution of sodium hydroxide having a specific gravity of one and fifteen hundredths (1.15) is added, is warmed slightly and placed in a separatory funnel. The mixture is vigorously shaken, allowed to stand until the oil and soda solutions separate, and the soda solution containing most of the tar acids drawn off. A second and third extraction is then made in the same manner, using thirty (30) and twenty (20) cubic centimeters of the soda solution, respectively. The three alkaline extracts are united in a two-hundred cubic centimeter (200 c. c.) graduated cylinder, and acidified with dilute sulphuric acid. The mixture is then allowed to cool and the volume of tar acids noted. The results should be calculated to percentage of original oil.

#### NAPHTHALENE TEST.

The naphthalene test described by Mann (53) is not, so far as is known at the Forest Products Laboratory, used in this country to any great extent. It consists in determining the melting point of

the naphthalene fraction. It may, however, be used by some of the manufacturers under the name of the limp-id-point test. It gives some idea of the naphthalene content, especially that which will solidify in cooling.

The Forest Service described (50) a test for solids which included naphthalene and anthracene solids. A test somewhat similar (54) was afterwards adopted by the American Railway Engineering Association. So far as the author is aware neither of these tests is now used to any great extent.

#### VISCOSITY TEST.

The viscosity test has been proposed chiefly in connection with tar mixtures (25). It consists of a determination of the viscosity by the use of an Engler viscosimeter. This gives but little information as to the amount of tar present. Probably an estimate of the tar content fully as accurate may be made by one familiar with analyses of creosote by noticing the character and percentage of residue above a certain fixed point, as, for instance, 320° C. The latter procedure is applicable to water-gas tar, but the former is not. This test has now been dropped from specifications. It is believed, however, in the light of the relationship that exists between the penetration of oils and their absolute viscosity, that it would be a very desirable test to make for this purpose alone.

#### INDEX OF REFRACTION TEST.

A description of the apparatus used and the method of making the index of refraction test is given on page —.

#### SULPHONATION TEST.

A description of the sulphonation test and directions for making it are given on page —.

#### DIMETHYL-SULPHATE TEST.

The dimethyl-sulphate test was designed chiefly for use in light creosotes and as sheep dips. Chapin (55) claims that it gives more satisfactory results than the sulphonation test which it replaces. At the Forest Products Laboratory, however, with creosotes such as are used by wood preservers, the sulphonation tests have given the better results. Neither test apparently can be relied upon to differentiate water-gas tar products from coal-tar products.

## CHAPTER II.—SPECIFICATIONS NOW IN FORCE BY VARIOUS ASSOCIATIONS.

During the last few years a concerted effort has been made in this country by various societies interested in wood preservation to adopt uniform specifications for wood-preserving oils. Such specifications have been adopted or have been proposed by several societies. In addition to these, other specifications are still in force which do not require all the latest tests. It is believed, however, that enough of the more modern specifications are given in Table 36 to answer most purposes; but, for the sake of simplification, only those are included which apply to different types of oil. No claim is made for the superiority of any of these oils. They differ only in boiling points. Although it has been generally believed that the higher-boiling oils are the most permanent, it has been shown that oils lighter than those of specification No. 3, if used in a proper manner, have outlasted the mechanical life of ties and poles. For land work, therefore, it seems to be largely a matter of personal opinion as to which of these oils is the best. It must be remembered that these specifications are for materials of known origin and are in addition to the requirement that the creosote shall be a coal-tar product. However, the tests given in these specifications do not guarantee a pure coal-tar product. Certain selected materials which are not derived from coal tar may pass all the tests; but the tests, if rigidly enforced, considerably reduce the amount of such materials. At the same time, certain pure coal-tar products are eliminated. The specification is intended to insure the type of oil which has proved of benefit. Until other materials have proved to be of value, or until our knowledge of the mechanism of protection by creosote has been enlarged, it is deemed advisable to exclude such materials from the best grade of oil, even though they are coal-tar products.

### COAL-TAR SOLUTIONS.

As already stated, tar solutions can not be considered so good preservatives as pure coal-tar creosotes. They have not been in use sufficiently long for their worth to be conclusively proved. It seems reasonable, however, to expect that a mixture of coal tar and coal-tar creosote will eventually be obtained that will preserve wood up to the limit of its mechanical life. Just what proportion of creosote and tar such a mixture will contain is problematical. Table 37 gives the specifications for tar solutions now in force.

TABLE 36.—*Specifications for coal-tar creosotes.*

[All creosotes listed must be a distillate of coal-gas or coke-oven tar, and, in addition, must fulfill these requirements.]

Requirement.	Specification.			
	No. 1.	No. 2.	No. 3.	No. 4.
Moisture content.....	N. M. 3 p. ct. <sup>1</sup>	N. M. 3 p. ct.	N. M. 3 p. ct.	N. M. 3 p. ct.
Insoluble in benzol.....	N. M. 0.5 p. ct.	N. M. 5 p. ct.	N. M. 5 p. ct.	N. M. 5 p. ct.
Specific gravity at 38° C. referred to water at 15.5° C.....	N. L. 1.03 <sup>2</sup>	N. L. 1.03	N. L. 1.03	N. L. 1.06.
Distillates up to 210° C.....	N. M. 5 p. ct.	N. M. 8 p. ct.	N. M. 10 p. ct.	N. M. 5 p. ct.
Distillates up to 235° C.....	N. M. 25 p. ct.	N. M. 35 p. ct.	N. M. 40 p. ct.	N. M. 15 p. ct.
Specific gravity of fractions at 38° C. referred to water at 15.5° C.:				
Fraction 235° to 315° C.....	N. L. 1.03	N. L. 1.03	N. L. 1.03	N. L. 1.03.
Fraction 315° to 355° C.....	N. L. 1.10	N. L. 1.10	N. L. 1.10	N. L. 1.10.
The float test must not exceed 50 seconds at 70° C. if the residue at 355° C. exceeds.....	5 p. ct.	5 p. ct.	5 p. ct.	5 p. ct.
Coke residue.....	N. M. 2 p. ct.	N. M. 2 p. ct.	N. M. 2 p. ct.	N. M. 2 p. ct.

Specification No. 1=Grade 1, A. R. E. A.; creosote for ties and structural timber of A. W. P. A.

Specification No. 2=Grade 2, A. R. E. A.

Specification No. 3=Grade 3, A. R. E. A.

Specification No. 4=Distillate oil for paving blocks, A. W. P. A. and A. S. M. I.

<sup>1</sup> N. M.=Not more than.

<sup>2</sup> N. L.=Not less than.

TABLE 37.—*Specifications for coal-tar solutions.*

Requirements.	Specification No. 1.	Specification No. 2.
Composition of solution.....	80 per cent distillate of coal-gas or coke-oven tar; 20 per cent filtered or refined coal-gas or coke-oven tar.	65 per cent distillate of coal-gas or coke-oven tar; 35 per cent filtered or refined coal-gas or coke-oven tar.
Water content.....	N. M. 3 per cent <sup>1</sup>	N. M. 3 per cent.
Insoluble in benzol.....	N. M. 2 per cent.	N. M. 2 per cent.
Specific gravity at 38° C. referred to water at 15.5° C.....	N. L. 1.03 <sup>2</sup>	N. L. 1.03.
Distillates up to 210° C.....	N. M. 1.12	N. M. 1.14.
Distillates up to 235° C.....	N. M. 5 per cent.	N. M. 5 per cent.
Specific gravity of fractions at 38° C. referred to water at 15.5° C.:		
Fraction 235° to 315° C.....	N. M. 25 per cent.	N. M. 25 per cent.
Fraction 315° to 355° C.....	N. L. 1.03	N. L. 1.03.
Float test must not exceed 50 seconds at 70° C. if the distillation residue at 355° C. exceeds.....	N. L. 1.10	N. L. 1.10.
Coke residue.....	26 per cent.	35 per cent.
	N. M. 6 per cent	N. M. 10 per cent.

Specification No. 1= Tar solution for ties and structural timber of A. R. E. A. and A. W. P. A.

Specification No. 2= Tar solution for paving blocks of A. W. P. A. and A. S. M. I.

<sup>1</sup> N. M.=Not more than.

<sup>2</sup> N. L.=Not less than.

#### WATER-GAS TAR.

Up to the present time no specifications have been adopted for either water-gas tar or water-gas-tar creosotes to be used alone as a wood preservative. The American Railway Engineering Association adopted in 1920 a specification for water-gas tar distillate and a specification for water-gas tar solution to be used in conjunction with zinc chloride by any of the preserving processes employing both zinc chloride and oil. The requirements of these specifications are given in Table 38.



TABLE 38.—Specifications for water-gas tar products to be used with zinc chloride.

Requirements.	Distillate oil	Water-gas-tar solution.
Composition.....	A pure distillate of water-gas tar.	60 per cent distillate of water-gas tar; 40 per cent refined or filtered water-gas tar.
Water content.....	N. M. 3 per cent <sup>1</sup>	N. M. 3 per cent.
Insoluble in benzol.....	N. M. 0.5 per cent.....	N. M. 2 per cent.
Specific gravity at 38° C. referred to water at 15.5° C.	N. L. 1.02 <sup>2</sup>	N. L. 1.03.
Distillates up to 210° C.....	N. M. 5 per cent.....	N. M. 1.07.
Distillates up to 235° C.....	N. M. 25 per cent.....	N. M. 8 per cent.
Distillates up to 355° C.....	N. L. 80 per cent.....	N. M. 20 per cent.
Specific gravity of fraction at 38° C. referred to water at 18.5:		N. L. 60 per cent.
Fraction 235° to 315° C.....	N. L. 0.98.....	N. L. 0.98.
	N. M. 1.02.....	N. M. 1.02.
Float test must not exceed 50 seconds at 70° C. if the distillation residue at 355° C. exceeds.	5 per cent.....	5 per cent.
Coke residue.....	N. M. 2 per cent.....	N. M. 10 per cent.

N. M.=Not more than.

<sup>2</sup> N. L.=Not less than.

## APPENDIX.

### TABLE 39.—Distillation of authentic coal-tar creosotes.

#### HORIZONTAL-RETORT TAR CREOSOTES.

Tar No.	Fraction limits.														Res.
	Up to 205°C.	205 to 215°C.	215 to 225°C.	225 to 235°C.	235 to 245°C.	245 to 255°C.	255 to 265°C.	265 to 275°C.	275 to 285°C.	285 to 295°C.	295 to 305°C.	305 to 315°C.	315 to 330°C.		
	Per cent.	Per cent.	Per cent.	Per cent.	Per cent.	Per cent.	Per cent.	Per cent.	Per cent.	Per cent.	Per cent.	Per cent.	Per cent.	Per cent.	
1	3.3	3.3	10.6	7.4	8.0	5.3	5.4	3.9	7.7	6.7	5.0	5.4	6.4	21.4	
2	5.0	6.1	10.0	12.4	6.7	7.1	6.6	4.9	5.5	4.7	5.2	3.9	5.7	16.0	
3	3.4	6.0	14.2	13.2	7.3	4.7	4.4	4.5	5.9	5.2	3.5	2.2	5.2	19.1	
4	3.5	7.9	11.0	11.1	9.2	4.9	5.2	5.0	5.8	6.0	4.0	3.3	5.6	17.1	
5	3.6	8.0	10.8	17.5	4.7	5.5	4.3	4.4	4.8	5.4	5.0	3.4	5.6	16.9	
6	4.6	5.2	10.2	8.5	7.4	5.1	5.8	6.2	6.5	5.2	4.8	4.2	6.0	19.8	
7	2.9	6.4	13.6	12.2	8.2	5.2	6.2	5.2	6.3	5.2	4.2	3.7	4.5	16.0	
8	1.3	4.4	14.8	19.4	7.4	5.0	5.6	4.8	4.7	5.2	4.1	3.2	5.0	14.6	
9	3.4	4.6	13.6	10.9	7.1	5.1	4.2	5.5	6.0	5.6	5.4	3.8	5.6	18.8	
10	1.4	3.5	14.0	18.8	6.8	4.6	3.3	4.8	5.0	6.2	4.9	2.8	5.1	18.4	
11	2.3	7.4	6.3	12.0	3.4	5.4	6.9	6.1	4.5	6.6	5.5	4.1	6.1	22.9	
12	3.7	5.6	14.5	16.8	9.7	4.8	3.7	3.8	5.3	5.3	6.3	.....	8.1	12.1	
13	9	3.0	6.9	16.7	7.5	6.4	4.8	6.5	5.8	6.6	5.8	4.2	5.6	19.0	
14	3.2	5.1	10.0	16.5	7.2	6.5	5.1	5.3	6.3	5.1	4.2	3.4	5.6	16.1	
15	3.0	6.9	13.4	12.0	7.6	6.6	5.6	5.1	6.0	5.2	4.3	3.3	4.4	16.2	

#### INCLINED-RETORT TAR CREOSOTES.

17	5.9	5.9	9.9	13.1	6.5	5.3	5.4	5.7	6.7	4.3	4.9	4.3	5.3	16.6
18	1.3	5.6	22.9	12.4	7.2	4.8	4.5	5.4	5.8	4.5	3.9	2.5	4.2	14.5
19	1.3	2.1	3.9	5.1	3.6	3.4	2.9	3.2	4.8	6.0	4.6	4.6	8.3	46.2
20	1.6	2.9	8.6	11.9	4.5	6.8	5.8	4.8	9.8	7.5	4.4	5.0	6.2	19.7
21	4.2	5.8	7.0	9.0	4.4	7.2	6.3	7.0	5.2	8.8	5.2	4.6	7.2	18.1
22	1.4	3.5	14.5	14.4	8.4	6.7	4.0	5.4	6.3	5.5	4.2	3.5	4.8	16.8

#### VERTICAL-RETORT TAR CREOSOTES.

23	8.7	7.9	11.2	10.1	5.7	5.3	6.8	6.0	6.1	4.9	4.3	3.6	5.4	12.8
----	-----	-----	------	------	-----	-----	-----	-----	-----	-----	-----	-----	-----	------

#### OTTO TAR CREOSOTES.

24	.2	1.0	12.6	8.0	3.5	2.1	2.0	2.3	5.0	6.6	3.9	5.7	9.9	36.2
25	3.6	10.0	12.6	8.8	11.6	4.8	5.8	4.6	3.9	6.0	4.4	3.5	3.7	16.2
26	1.8	4.7	25.2	13.7	5.2	4.3	3.7	3.4	3.9	5.7	4.4	3.0	3.6	16.0
27	.5	3.5	20.7	12.4	11.7	5.6	4.0	3.9	4.2	4.6	4.6	3.7	3.2	16.2

#### SEMET-SOLVAY TAR CREOSOTES.

29	6.8	8.8	13.0	10.0	4.2	7.5	3.9	4.1	5.4	4.7	5.0	1.1	9.1	16.3
30	3.1	5.9	9.9	8.6	8.2	5.5	5.3	6.2	6.4	5.7	6.2	4.1	5.3	19.1
31	2.8	2.7	15.3	13.1	6.6	3.7	3.4	4.9	4.4	7.9	4.8	5.2	5.2	20.0
32	1.8	1.8	10.1	8.3	6.8	3.3	4.2	3.6	6.6	8.0	5.2	4.8	7.2	27.9
33	4.8	4.8	13.0	16.7	7.7	5.8	5.2	5.2	5.5	6.0	3.0	2.7	5.2	17.0
34	.....	.....	.....	.....	.....	.....	.....	.....	.....	.....	.....	.....	.....	.....

#### KOPPERS TAR CREOSOTES.

35	.3	1.1	33.4	10.1	2.4	2.5	2.2	3.1	5.1	6.2	4.7	2.5	5.3	20.6
----	----	-----	------	------	-----	-----	-----	-----	-----	-----	-----	-----	-----	------

1 No creosote could be produced. Too much free carbon and nothing else but water.

TABLE 40.—Indices of refraction at 60° C. of fractions of coal-tar creosotes.

## HORIZONTAL-RETORT TAR CREOSOTES.

Tar No.	Fraction limits.								
	235 to 245° C.	245 to 255° C.	255 to 265° C.	265 to 275° C.	275 to 285° C.	285 to 295° C.	295 to 305° C.	305 to 315° C.	315 to 330° C.
	No.	No.	No.	No.	No.	No.	No.	No.	
1	1.5944	1.5963	1.5980	1.6020	1.6070	1.6142	1.6213	1.6283	N. L. <sup>1</sup>
2	1.5892	1.5933	1.5964	1.5995	1.6048	1.6108	1.6173	1.6250	N. L.
3	1.5935	1.5937	1.5953	1.5978	1.6027	1.6085	1.6155	1.6228	N. L.
4	1.5965	1.5923	1.5938	1.5969	1.6012	1.6080	1.6150	1.6223	N. L.
5	1.5923	1.5924	1.5945	1.5988	1.6035	1.6092	1.6190	1.6263	N. L.
6	1.5895	1.5919	1.5946	1.5975	1.6022	1.6093	1.6157	1.6237	N. L.
7	1.5930	1.5936	1.5948	1.5979	1.6028	1.6090	1.6163	1.6230	N. L.
8	1.5950	1.5952	1.5958	1.5985	1.6041	1.6118	1.6195	1.6269	N. L.
9	1.5931	1.5945	1.5960	1.5995	1.6050	1.6108	1.6178	1.6258	N. L.
10									
11	1.5971	1.5873	1.5984	1.6003	1.6050	1.6122	1.6182	1.6257	N. L.
12	1.5813	1.5892	1.5913	1.5940	1.5983	1.6087	1.6108	1.6166	N. L.
13	1.5882	1.5898	1.5907	1.5940	1.5985	1.6048	1.6120	1.6166	N. L.
14	1.5920	1.5930	1.5942	1.5965	1.6010	1.6060	1.6140	1.6205	N. L.
15	1.5869	1.5900	1.5918	1.5947	1.5997	1.6046	1.6118	1.6197	N. L.
16	1.5915	1.5923	1.5932	1.5963	1.6013	1.6075	1.6100	N. L.	N. L.

## INCLINED-RETORT TAR CREOSOTES.

17	1.5792	1.5795	1.5802	1.5822	1.5862	1.5922	1.5988	1.6052	N. L.
18	1.5843	1.5821	1.5816	1.5836	1.5875	1.5943	1.6010	1.6078	N. L.
19	1.5800	1.5824	1.5840	1.5868	1.5919	1.5980	1.6040	1.6113	N. L.
20	1.5830	1.5852	1.5868	1.5892	1.5925	1.5993	1.6023	1.6083	N. L.
21	1.5745	1.5758	1.5773	1.5796	1.5890	1.5888	1.5942	1.5988	N. L.
22	1.5925	1.5926	1.5931	1.5963	1.6003	1.6078	1.6147	1.6230	N. L.

## VERTICAL-RETORT TAR CREOSOTES.

23	1.5716	1.5754	1.5776	1.5810	1.5843	1.5904	1.5971	1.6047	N. L.
----	--------	--------	--------	--------	--------	--------	--------	--------	-------

## OTTO TAR CREOSOTES.

24	1.6021	1.6028	1.6041	1.6071	1.6132	1.6208	1.6273	N. L.	N. L.
25	1.5936	1.5949	1.5970	1.5994	1.6032	1.6100	1.6165	1.6245	N. L.
26	1.5998	1.6003	1.6018	1.6042	1.6105	1.6160	1.6229	N. L.	N. L.
27	1.6004	1.6015	1.6021	1.6051	1.6098	1.6160	1.6230	N. L.	N. L.
28									

## SEMET-SOLVAY TAR CREOSOTES.

29	1.5915	1.5928	1.5937	1.5968	1.6011	1.6073	1.6122	1.6192	N. L.
30	1.5918	1.5933	1.5950	1.5983	1.6031	1.6098	1.6170	1.6243	N. L.
31	1.5979	1.5983	1.5993	1.6032	1.6090	1.6170	1.6232	N. L.	N. L.
32	1.5996	1.6000	1.6018	1.6046	1.6103	1.6170	1.6240	N. L.	N. L.
33	1.5880	1.5878	1.5883	1.5901	1.5941	1.6012	1.6080	1.6183	N. L.
34									

## KOPPERS TAR CREOSOTES.

35	1.6031	1.6050	1.6071	1.6122	1.6182	1.6251	1.6322	N. L.	N. L.
----	--------	--------	--------	--------	--------	--------	--------	-------	-------

<sup>1</sup> Not liquid at 60° C.

TABLE 41.—*Specific gravities of fractions of coal-tar creosotes* (*Sp. Gr.*  $\frac{60}{60}$ ).

## HORIZONTAL-RETORT TAR CREOSOTES.

Tar No.	Fraction limits.									
	235 to 245° C.	245 to 255° C.	255 to 265° C.	265 to 275° C.	275 to 285° C.	285 to 295° C.	295 to 305° C.	305 to 315° C.	315 to 330° C.	
1.....	<i>Sp. gr.</i> 1.018	<i>Sp. gr.</i> 1.022	<i>Sp. gr.</i> 1.029	<i>Sp. gr.</i> 1.039	<i>Sp. gr.</i> 1.050	<i>Sp. gr.</i> 1.065	<i>Sp. gr.</i> 1.077	<i>Sp. gr.</i> 1.086	<i>Sp. gr.</i> 1.084	N. L. <sup>1</sup>
2.....	1.021	1.025	1.033	1.037	1.050	1.067	1.073	1.084		N. L.
3.....	1.015	1.020	1.026	1.034	1.045	1.058	1.073			N. L.
4.....	1.017	1.021	1.027	1.036	1.048	1.060	1.068			N. L.
5.....	1.014	1.018	1.029	1.037	1.048	1.060	1.072			N. L.
6.....	1.017	1.022	1.027	1.035	1.047	1.061	1.072	1.080		N. L.
7.....	1.016	1.021	1.028	1.036	1.047	1.062	1.073	1.079		N. L.
8.....	1.019	1.020	1.027	1.036	1.044	1.063	1.077			N. L.
9.....	1.017	1.022	1.027	1.040	1.049	1.063	1.073			N. L.
10.....										
11.....	1.020	1.023		1.039	1.049	1.066	1.075			N. L.
12.....	1.012	1.018	1.026	1.032	1.041	1.053	1.062	1.067		N. L.
13.....	1.018	1.022	1.032	1.032	1.043	1.056	1.068			N. L.
14.....	1.019	1.024	1.028	1.034	1.045	1.054	1.065	1.073		N. L.
15.....	1.017	1.021	1.025	1.033	1.044	1.052	1.064			N. L.
16.....	1.019	1.023	1.028	1.035	1.048	1.062	1.072	N. L.		N. L.

## INCLINED-RETORT TAR CREOSOTES.

17.....	1.007	1.009	1.015	1.020	1.029	1.038	1.047	1.054	N. L.
18.....	1.006	1.007	1.009	1.016	1.027	1.040	1.050		N. L.
19.....	1.008	1.005	1.005	1.026	1.034	1.044	1.053	1.060	N. L.
20.....	1.010	1.013	1.018	1.024	1.032	1.041	1.050	1.056	N. L.
21.....	1.005	1.009	1.013	1.020	1.028	1.035	1.043	1.049	N. L.
22.....	1.017	1.022	1.025	1.035	1.045	1.058	1.067	N. L.	N. L.

## VERTICAL-RETORT TAR CREOSOTES.

23.....	1.003	1.007	1.013	1.020	1.032	1.038	1.049		N. L.
---------	-------	-------	-------	-------	-------	-------	-------	--	-------

## OTTO TAR CREOSOTES.

24.....	1.020		1.040		1.055	1.074		N. L.	N. L.
25.....	1.017	1.020	1.031	1.040	1.043	1.061	1.077		N. L.
26.....	1.020	1.025	1.035	1.053	1.053	1.067	1.075	N. L.	N. L.
27.....	1.025	1.030	1.039		1.052	1.062	1.075	N. L.	N. L.
28.....									

## SEMET-SOLVAY TAR CREOSOTES.

29.....	1.013	1.024	1.033	1.046	1.060	1.075		N. L.	N. L.
30.....	1.013	1.017	1.021	1.031	1.043	1.057	1.070	1.078	N. L.
31.....	1.014	1.018	1.022	1.037	1.048	1.064	1.076	N. L.	N. L.
32.....	1.020	1.022	1.039	1.039	1.054	1.069	1.083	N. L.	N. L.
33.....	1.010	1.013	1.017	1.024	1.033	1.048	1.061		N. L.
34.....									

## KOPPERS TAR CREOSOTES.

35.....	1.027		1.041		1.065	1.082	1.089	N. L.	N. L.
---------	-------	--	-------	--	-------	-------	-------	-------	-------

<sup>1</sup> Not liquid at 60° C.



TABLE 43.—*Distillation of water-gas-tar creosotes (Hempel flask).*

Tar No.	Fraction limits.														Res.
	Up to 205° C.	205 to 215° C.	215 to 225° C.	225 to 235° C.	235 to 245° C.	245 to 255° C.	255 to 265° C.	265 to 275° C.	275 to 285° C.	285 to 295° C.	295 to 305° C.	305 to 315° C.	330° C.		
	Per cent.	Per cent.	Per cent.	Per cent.	Per cent.	Per cent.	Per cent.	Per cent.	Per cent.	Per cent.	Per cent.	Per cent.	Per cent.	Per cent.	
37	2.8	3.0	8.6	15.5	5.2	11.2	9.6	6.5	5.0	4.9	3.2	3.5	4.4	16.4	
38	3.3	2.4	11.0	15.2	9.1	6.4	8.4	6.7	6.8	4.5	3.8	3.3	3.8	14.9	
39	2.4	3.7	12.8	13.4	11.5	6.1	6.9	5.4	5.8	6.4	3.4	3.8	6.1	13.5	
40	2.2	2.0	5.4	12.0	14.3	5.4	11.1	9.7	7.3	6.0	7.1	4.3	5.5	8.7	
41	3.2	2.7	5.1	8.4	7.9	7.2	8.6	7.8	6.3	7.2	5.7	5.5	5.2	18.9	
42	2.4	2.4	17.8	14.2	6.7	3.6	3.6	3.0	2.9	3.3	3.6	1.8	7.1	27.1	
43	3.0	3.2	8.0	19.9	8.6	7.8	6.2	3.7	6.2	5.2	3.1	3.7	5.6	15.9	
44	2.2	4.3	14.8	14.6	7.8	3.9	3.6	5.9	5.1	5.4	3.8	3.9	5.6	18.9	
45	2.4	2.2	14.6	11.8	10.3	2.7	6.6	6.6	4.4	7.2	4.7	3.7	6.2	16.2	
46	2.9	2.8	10.4	13.8	9.5	7.0	6.8	5.1	4.8	4.0	2.3	3.6	6.0	21.2	
47	1.9	3.5	9.2	12.5	12.6	5.0	9.2	8.5	5.0	5.6	4.0	4.0	6.1	12.6	
48	2.2	2.9	13.0	11.1	8.7	6.9	5.6	4.3	6.0	5.1	7.6	4.4	6.4	16.1	
49	2.5	5.2	13.2	13.8	10.8	7.7	2.6	3.6	2.1	1.9	1.4	1.7	5.0	26.6	
50	2.6	2.4	16.2	21.6	7.0	5.6	4.7	3.6	5.5	4.6	2.9	3.8	4.7	14.4	
51	3.3	2.8	7.4	14.0	12.5	7.4	5.9	8.2	6.7	5.2	2.7	3.2	5.7	14.3	
52	7.6	5.0	5.3	6.9	11.8	9.0	8.5	6.7	7.8	6.3	4.4	2.5	4.9	12.9	
23	.6	1.2	17.0	16.9	7.1	4.4	3.1	5.4	6.0	4.7	4.0	3.6	5.8	19.6	
54	1.1	1.6	17.7	15.8	5.6	4.0	3.2	3.3	5.0	5.0	4.3	4.8	6.6	21.7	

TABLE 44.—*Indices of refraction of fractions of water-gas-tar creosotes.*

Tar No.	Fraction limits.									
	235 to 245° C.	245 to 255° C.	255 to 265° C.	265 to 275° C.	275 to 285° C.	285 to 295° C.	295 to 305° C.	305 to 315° C.	315 to 330° C.	
	No.	No.	No.	No.	No.	No.	No.	No.	No.	
37	1.5728	1.5728	1.5734	1.5742	1.5748	1.5780	1.5818	1.5880	1.6032	
38	1.5875	1.5853	1.5842	1.5828	1.5833	1.5861	1.5893	1.5990	N. L. <sup>1</sup>	
39	1.5873	1.5854	1.5831	1.5828	1.5838	1.5870	1.5912	1.5980	N. L.	
40	1.5798	1.5812	1.5817	1.5811	1.5817	1.5814	1.5832	1.5872	1.5988	
41	1.5574	1.5612	1.5625	1.5636	1.5635	1.5645	1.5662	1.5696	1.0812	
42	1.5931	1.5915	1.5904	1.5891	1.5901	1.5923	1.5954	1.5996	1.6097	
43	1.5922	1.5928	1.5932	1.5935	1.5968	1.6007	1.6068	1.6134	1.6282	
44	1.5938	1.5925	1.5931	1.5952	1.5973	1.6022	1.6070	1.6160	N. L.	
45	1.5848	1.5808	1.5786	1.5778	1.5780	1.5804	1.5827	1.5890	1.5985	
46	1.5886	1.5884	1.5880	1.5875	1.5878	1.5902	1.5940	1.5990	1.6108	
47	1.5760	1.5775	1.5778	1.5786	1.5798	1.5819	1.5858	1.5915	1.5988	
48	1.5790	1.5772	1.5742	1.5720	1.5715	1.5722	1.5732	1.5782	1.5868	
49	1.5820	1.5770	1.5731	1.5735	1.5753	1.5753	1.5826	1.5944	N. L.	
50	1.5982	1.5982	1.5985	1.6006	1.6052	1.6106	1.6185	1.6264	N. L.	
51	1.5868	1.5864	1.5866	1.5878	1.5898	1.5941	1.5996	1.6050	1.6240	
52	1.5640	1.5698	1.5739	1.5770	1.5792	1.5825	1.5878	1.5948	1.6060	
53	1.5972	1.5960	1.5974	1.6025	1.6064	1.6142	1.6212	1.6295	N. L.	
54	1.5975	1.5980	1.5996	1.6019	1.6082	1.6148	1.6218	1.6303	N. L.	

<sup>1</sup> Not liquid at 60° C.

TABLE 45.—Specific gravities of fractions of water-gas tar creosotes.

Tar No.	Distillation limits.								
	235 to 245° C.	245 to 255° C.	255 to 265° C.	265 to 275° C.	275 to 285° C.	285 to 295° C.	295 to 305° C.	305 to 315° C.	315 to 330° C.
	<i>Sp. gr.</i>	<i>Sp. gr.</i>	<i>Sp. gr.</i>	<i>Sp. gr.</i>	<i>Sp. gr.</i>	<i>Sp. gr.</i>	<i>Sp. gr.</i>	<i>Sp. gr.</i>	<i>Sp. gr.</i>
37	0.986	0.986	0.986	0.989	0.996	0.996	1.009		
38	.997	.996	1.001	1.000	1.006	1.019			N. L. <sup>1</sup>
39	1.002	1.001	.998	.992	1.001	1.015	1.018		N. L.
40	.987	.988	.989	.989	.989	.992	1.000	1.015	
41	.960	.962	.964	.966	.967	.972	.975	.984	0.998
42	1.006	1.003		1.006		1.021			1.041
43	1.000	.999	1.003		1.014	1.021	1.041		1.063
44	1.006	1.007		1.013	1.024	1.029	1.044		N. L.
45	.996		.994	.995	1.000	1.007	1.015		N. L.
46	.998	.997	.997	1.000	1.003	1.015			1.033
47	.987	.987	.993	.996	.998	1.002	1.016		1.039
48	.992	.993	.986	.984	.986	.989	.992		1.009
49	.995	.992	.993			1.005			N. L.
50	1.008	1.009	1.014	1.029		1.039	1.071		N. L.
51	.996	.996	.998	1.004	1.009	1.020	1.040		1.066
52	.971	.979	.984	.989	.995	1.000	1.009		1.034
53	1.010	1.015		1.027	1.041	1.068			N. L.
54	1.009	1.018		1.032		1.047	1.060		N. L.

<sup>1</sup> N t liquid at 60° C.

TABLE 46.—Sulphonation residues of fractions of water-gas tar creosotes.

Tar No.	Fraction limits.										
	205 to 225° C.	225 to 235° C.	235 to 245° C.	245 to 255° C.	255 to 265° C.	265 to 275° C.	275 to 285° C.	285 to 295° C.	295 to 305° C.	305 to 315° C.	315 to 330° C.
	<i>Per cent.</i>	<i>Per cent.</i>	<i>Per cent.</i>	<i>Per cent.</i>	<i>Per cent.</i>	<i>Per cent.</i>	<i>Per cent.</i>	<i>Per cent.</i>	<i>Per cent.</i>	<i>Per cent.</i>	<i>Per cent.</i>
37	8.6	8.4	8.0	8.2	8.8	10.0	10.8		11.2		8.6
38	1.4	1.6	2.0	4.2	4.4	6.0	7.6		7.8		8.0
39	1.0	.8	2.4	3.2	4.4	5.4	7.0	7.6	8.4		7.4
40	1.6	1.4	2.4	3.2	4.2	4.8	6.0	7.6	8.8		7.4
41	10.0	9.8	10.0	11.0	12.2	12.8	13.6	14.4	16.4	17.2	16.4
42	Tr.	.4	1.2		2.4	5.2		7.0			1.2
43	Tr.	.2	.3	.4	.6	1.0	1.6	2.0	1.6		1.4
44	.4	.4	.6	1.4		2.4	2.8	3.0	3.0		2.8
45	2.0	2.0	3.4	4.0	6.0	8.1	9.4	10.0	10.6		12.2
46	Tr.	.4	.4	1.4	1.8	2.4	3.2	4.0	3.6		
47	3.8	5.0	4.8	5.4	5.6	6.6	7.0	8.0	9.0		8.4
48	2.8	3.2	5.2	7.4	8.8	10.8	13.6	15.8	16.8	17.6	15.0
49	Tr.	Tr.	.2	.8		2.4		4.4			4.2
50	0	0	0	0	0	0	0	0	0	0	0
51	1.2	1.4	2.0	2.2	2.4	2.6	2.8	2.8	2.4		1.6
52	9.2	9.4	8.4	8.4	6.6	4.6	6.4	7.0	7.4	6.0	4.4
53	0	0	0	0	0	0	0	Tr.	0	0	0
54	0	0	0	0	0	0	0	Tr.	0	0	0

## BIBLIOGRAPHY.

1. HELPHENSTINE, R. K., Jr. Consumption of Wood Preservatives. (In Proceedings of American Wood Preservers' Association, 1919, p. 274.)
2. LEWES, V. B. Carbonization of Coal.
3. HUBBARD, P. Coke-oven Tars of the United States (U. S. Department of Agriculture, Office of Public Roads Circular No. 99.)
4. FULWEILER, W. H. Water-gas. (In Rogers and Auber's Industrial Chemistry, chap. XXI, p. 447.)
5. PARKER, E. W. Production of Gas, Coke, Tar, and Ammonia, 1908. (In Mineral Resources of the U. S., 1908, U. S. Geological Survey.)
6. PARKER, E. W. Production of Gas, Coke, Tar, and Ammonia, 1912. (In Mineral Resources of the U. S., 1912, U. S. Geological Survey.)
7. U. S. GEOLOGICAL SURVEY. Artificial Gas and By-products in 1917. (Press bulletin.)
8. Private communications from the Geological Survey.
9. PARKER, E. W. Production of Gas, Coke, Tar, and Ammonia, 1905. (In Mineral Resources of the U. S., 1905, U. S. Geological Survey.)
10. LUNGE, GEORGE. Coal Tar and Ammonia. (5th ed., N. Y., Van Nostrand, 1916.)
11. WARNES, A. R. Distillation of Coal Tar. (N. Y., Van Nostrand, 1914.)
12. DEAN, A. L., and BATEMAN, E. Analysis and Grading of Coal-tar Creosote. (U. S. Forest Service Circular No. 112.)
13. THEISEN-SCHEEL and DIESSELHORST. (Van Nostrand Chemical Annual, 1909.)
14. BERRY, O. C. Tar-forming Temperatures of American Coals. (University of Wisconsin Bulletin No. 635.)
15. American Society for Testing Materials, Proceedings, 1917, p. 621.
16. WEISS, H. F. Tests to Determine the Commercial Value of Wood Preservatives. (In Proceedings of Eighth International Congress of Applied Chemistry, 1912.)
17. BOND, F. M. The Effect upon Absorption and Penetration of Mixing Tar with Creosote. (In Proceedings of American Wood Preservers' Association, 1913, pp. 216-274.)
18. TEESDALE, C. H., and MACLEAN, J. D. Tests of the Absorption and Penetration of Coal Tar and Creosote in Longleaf Pine. (U. S. Department of Agriculture Bulletin No. 607.)
19. ALLEMAN, G. Quantity and Quality of Creosote in Well-preserved Timbers. (U. S. Forest Service Circular No. 88.)
20. VON SCHRENK, H., and others. Changes which Take Place in Coal-Tar Creosote during Exposure. (In Proceedings of American Railway Engineering Association, 1908, pp. 738-764.)
21. BATEMAN, E. Quantity and Quality of Creosote Found in Two Treated Piles after Long Service. (U. S. Forest Service Circular No. 199.)
22. RIDGWAY, F. B. Report on Creosoted Piling in Galveston Bay Bridge on the Santa Fe Railroad. (In Proceedings of American Wood Preservers' Association, 1914, pp. 194-215.)
23. RHODES, F. L., and HOSFORD, R. F. Recent Results Obtained from the Preservative Treatment of Telephone Poles. (In Proceedings of American Institute of Electrical Engineers, 1915.)



24. CABOT, S. Value of Higher Phenols in Wood-preservative Oils; Apparent Disappearance of the Higher-Boiling Phenols in Creosoted Wood. (In *Journal of Industrial and Engineering Chemistry*, 1912.)
25. VON SCHRENK, H., and KAMMERER, A. L. The Use of Refined Coal-tar in the Creosoting Industry. (In *Proceedings of American Railway Engineering Association*, 1914, pp. 635-681.)
26. BATEMAN, E., and TOWN, G. G. Loss by Evaporation of Creosote from Open-tank Treatments. (In *Proceedings of American Wood Preservers' Association*, 1920.)
27. BATEMAN, E. What Light Oils Have Done in Wood Preservation. (In *Proceedings of American Wood Preservers' Association*, 1920.)
28. CHAPMAN, C. M. A Fungus-bed Test for Wood Preservatives. (In *Proceedings of American Society for Testing Materials*, 1915.)
29. HUMPHREY, C. J., and FLEMING, R. M. Toxicity of Various Wood Preservatives. (In *Journal of Industrial and Engineering Chemistry*, 1914-1915.)  
——— Tests of Wood Preservatives. (U. S. Department of Agriculture Bulletin No. 145.)
30. DEAN, A. L., and DOWNES, C. R. Antiseptic Properties of Wood-preserving Oils. (In *Proceedings of Eighth International Congress of Applied Chemistry*, 1912.)
31. WEISS, J. M. The Action of Oils and Tar in Preventing Mould Growth; The Antiseptic Effect of Creosote Oil and Other Wood-preserving Materials. (In *Journal of the Society of Chemical Industry*, 1911, vol. 30, No. 4, p. 190.)
32. RUSSELL, E. J., and PENDLETON, W. The Action of Antiseptics in Increasing the Growth of Crops in Soils. (In *Journal of the Society of Chemical Industry*, 1913, vol. 32, No. 24, pp. 1137, 1138.)
33. CHARITSCHKOW, K. W. Antiseptic Properties of Creosote. (In *Journal of the Russian Chemical Society*, 1912.)
34. HUNTLEY, H. W. Identification and Toxic Action of Some Compounds in Coal-tar Creosote. (Unpublished Manuscript at U. S. Forest Products Laboratory, 1915.)
35. TRILLAT, A. Antiseptic and Medicinal Properties Derived from Coal-tar. (In *Moniteur Scientific*, 1892.)
36. ADASIEWIETSCH, A. W. Treatment of Wood with Antiseptics Prepared from Coal Tar. (Abstract, *Journal of the Society of Chemical Industry*, 1897.)
37. BOKORNY, Efficiency of Phenol as a Disinfectant Compared with Other Poisons. (*Chemiker Zeitung*, 1906.)
38. SCHNEIDER, H. Disinfectants from Naphthols. (*Chemiker Cent.*, 1906.)
39. MORGAN, G. F., and COOPER, E. A. Germicidal Power of Organic Hydroxy-Compounds and Amines. (In *Proceedings of Eighth International Congress of Applied Chemistry*, 1912.)
40. SHACKELL, L. F. Comparative Toxicity of Coal-tar Creosote and Creosote Distillates for the Marine Wood Borer, *Xylotrya*. (In *Proceedings of American Wood Preservers' Association*, 1915, pp. 233-252.)
41. BATEMAN, E. A Theory on the Mechanism of Protection by Wood Preservatives. (In *Proceedings of American Wood Preservers' Association*, 1920.)
42. FREDENDOLL, P. F. Evaporation of Creosote and Crude Oils. (In *Proceedings of American Wood Preservers' Association*, 1912, pp. 107-117.)
43. BATEMAN, E. The Relation Between Viscosity and Penetrance of Creosote into Wood. (In *Chemical and Metallurgical Engineering*, 1920.)
44. WEISS, J. M. Free Carbon: Its Nature and Determination in Tar Products. (In *Journal of Industrial and Engineering Chemistry*, 1914.)

45. MONROE, G. S., and BRODERSON, H. J. Some Effects of Certain Solvents on Tars in Free-carbon Determination. (In Journal of Industrial and Engineering Chemistry, 1918.)
46. DAVIS, T. H. The Examination of Creosote. (In Oil, Paint, and Drug Reporter. 1909.)
47. CLOUKEY, H. The Application of the Davis Spot Test in the Preliminary Examination of Creosote. (In Journal of Industrial and Engineering Chemistry, 1915.)
48. National Electric Light Association, Proceedings, 1911.
49. BATEMAN, E. Discussion on Paving-block Specifications. (In Proceedings of American Wood Preservers' Association, 1917.)
50. DEAN, A. L., and BATEMAN, E. The Fractional Distillation of Coal-tar Creosote, (U. S. Forest Service Circular No. 80.)
51. National Electric Light Association, Proceedings, 1911.
52. American Railway Engineering Association, Proceedings, 1913.
53. MANN, J. C. The Testing of Coal-tar Creosote. (In Journal of the Society of Chemical Industry, 1910.)
54. American Railway Engineering Association, Proceedings, 1908.
55. CHAPIN, R. M. The Analysis of Coal-tar Creosote and Cresylic Acid Sheep Dip- (U. S. Bureau of Animal Industry Bulletin 107.)
56. FULWEILER, W. H. Report on Water Gas Tar. (In Proceedings of American Wood Preservers' Association, 1921.)
57. MATTOS, F. D. Long Wharf Piles. (In Proceedings of American Wood Preservers' Association, 1920.)

---

---

ADDITIONAL COPIES

OF THIS PUBLICATION MAY BE PROCURED FROM  
THE SUPERINTENDENT OF DOCUMENTS  
GOVERNMENT PRINTING OFFICE  
WASHINGTON, D. C.

AT  
20 CENTS PER COPY





